



This is a digital copy of a book that was preserved for generations on library shelves before it was carefully scanned by Google as part of a project to make the world's books discoverable online.

It has survived long enough for the copyright to expire and the book to enter the public domain. A public domain book is one that was never subject to copyright or whose legal copyright term has expired. Whether a book is in the public domain may vary country to country. Public domain books are our gateways to the past, representing a wealth of history, culture and knowledge that's often difficult to discover.

Marks, notations and other marginalia present in the original volume will appear in this file - a reminder of this book's long journey from the publisher to a library and finally to you.

Usage guidelines

Google is proud to partner with libraries to digitize public domain materials and make them widely accessible. Public domain books belong to the public and we are merely their custodians. Nevertheless, this work is expensive, so in order to keep providing this resource, we have taken steps to prevent abuse by commercial parties, including placing technical restrictions on automated querying.

We also ask that you:

- + *Make non-commercial use of the files* We designed Google Book Search for use by individuals, and we request that you use these files for personal, non-commercial purposes.
- + *Refrain from automated querying* Do not send automated queries of any sort to Google's system: If you are conducting research on machine translation, optical character recognition or other areas where access to a large amount of text is helpful, please contact us. We encourage the use of public domain materials for these purposes and may be able to help.
- + *Maintain attribution* The Google "watermark" you see on each file is essential for informing people about this project and helping them find additional materials through Google Book Search. Please do not remove it.
- + *Keep it legal* Whatever your use, remember that you are responsible for ensuring that what you are doing is legal. Do not assume that just because we believe a book is in the public domain for users in the United States, that the work is also in the public domain for users in other countries. Whether a book is still in copyright varies from country to country, and we can't offer guidance on whether any specific use of any specific book is allowed. Please do not assume that a book's appearance in Google Book Search means it can be used in any manner anywhere in the world. Copyright infringement liability can be quite severe.

About Google Book Search

Google's mission is to organize the world's information and to make it universally accessible and useful. Google Book Search helps readers discover the world's books while helping authors and publishers reach new audiences. You can search through the full text of this book on the web at <http://books.google.com/>



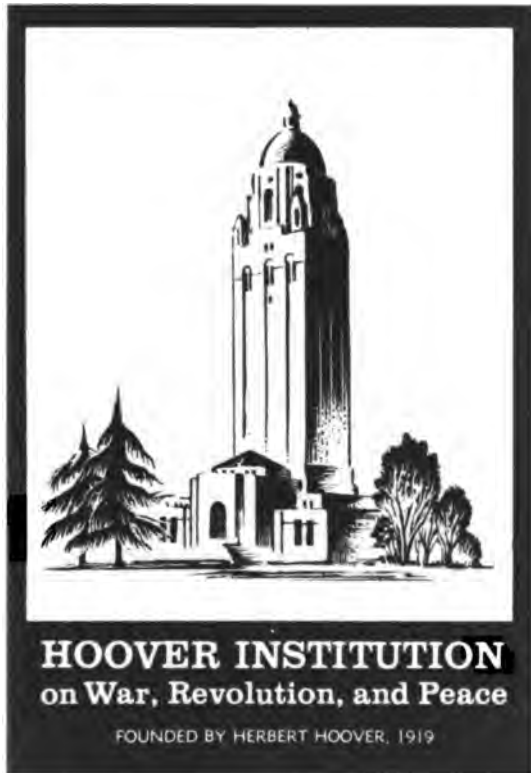

HOOVER INSTITUTION
on War, Revolution, and Peace

FOUNDED BY HERBERT HOOVER, 1919





.

.

1

THE ENCYCLOPÆDIA BRITANNICA

ELEVENTH EDITION

FIRST	edition, published in three	volumes,	1768—1771.
SECOND	" " ten	"	1777—1784.
THIRD	" " eighteen	"	1788—1797.
FOURTH	" " twenty	"	1801—1810.
FIFTH	" " twenty	"	1815—1817.
SIXTH	" " twenty	"	1823—1824.
SEVENTH	" " twenty-one	"	1830—1842.
EIGHTH	" " twenty-two	"	1853—1860.
NINTH	" " twenty-five	"	1875—1889.
TENTH	" ninth edition and eleven		
	supplementary volumes,		1902—1903.
ELEVENTH	" published in twenty-nine volumes,		1910—1911.

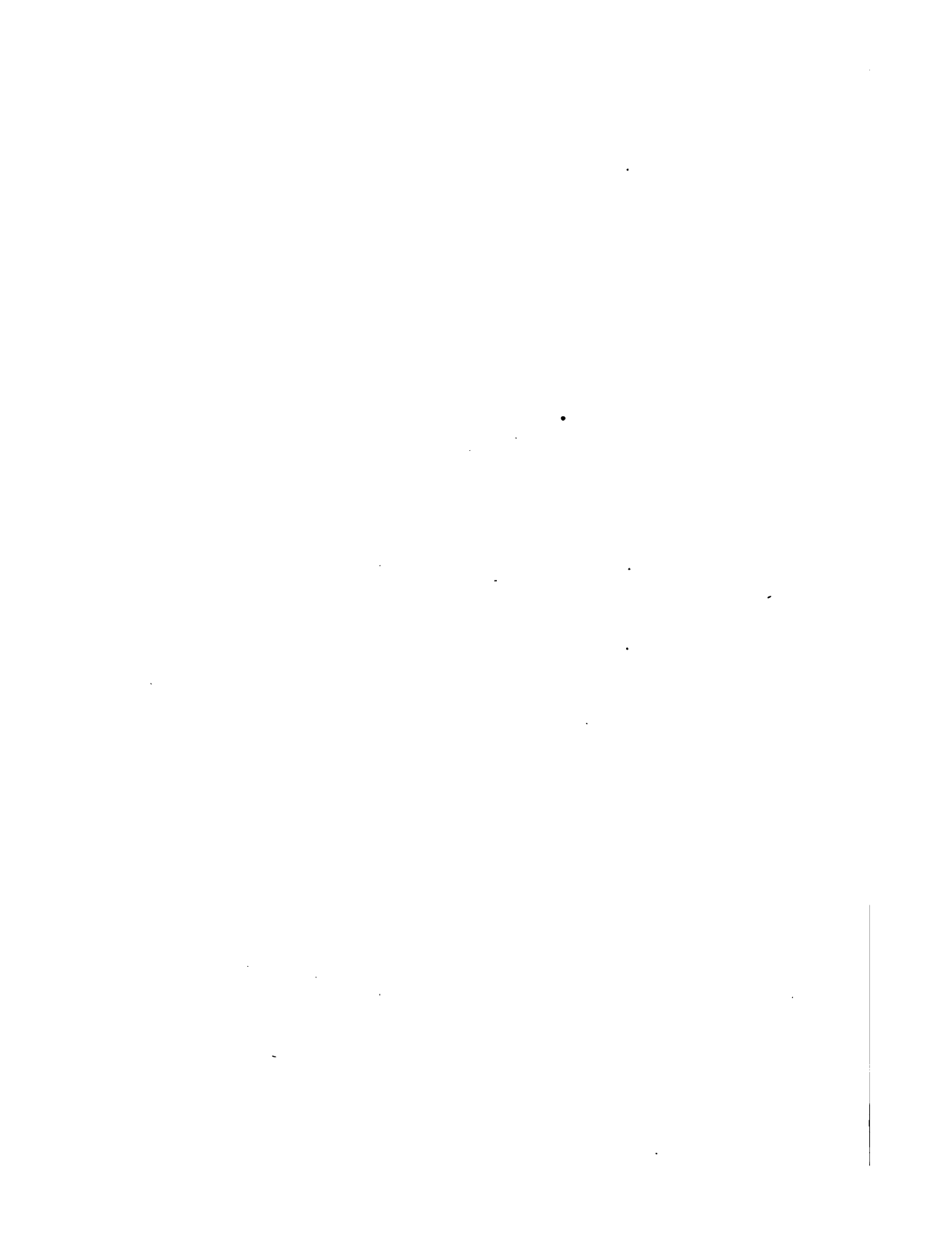

THE
ENCYCLOPÆDIA BRITANNICA

A
DICTIONARY
OF
ARTS, SCIENCES, LITERATURE AND GENERAL
INFORMATION

ELEVENTH EDITION .

VOLUME XIII
HARMONY .to HURSTMONCEAUX

NEW YORK
THE ENCYCLOPÆDIA BRITANNICA COMPANY
1910

Copyright, in the United States of America, 1910,
by
The Encyclopædia Britannica Company.

**INITIALS USED IN VOLUME XIII. TO IDENTIFY INDIVIDUAL
CONTRIBUTORS,¹ WITH THE HEADINGS OF THE
ARTICLES IN THIS VOLUME SO SIGNED.**

A. E. G.*	REV. ALFRED ERNEST GARVIE, M.A., D.D. Principal of New College, Hampstead. Member of the Board of Theology and the Board of Philosophy, London University. Author of <i>Studies in the Inner Life of Jesus</i> , &c.	{ Heresy (<i>in part</i>).
A. D.	HENRY AUSTIN DOBSON, LL.D. See the biographical article, DOBSON, H. A.	{ Hogarth.
A. E. T. W.	ALFRED EDWARD THOMAS WATSON. Editor of the <i>Badminton Library</i> and <i>Badminton Magazine</i> . Formerly Editor of the <i>Illustrated Sporting and Dramatic News</i> . Author of <i>The Racing World and its Inhabitants</i> ; &c.	{ Horse-Racing (<i>in part</i>); Hunting.
A. C. S.	ALGERNON CHARLES SWINBURNE. See the biographical article, SWINBURNE, A. C.	{ Hugo, Victor.
A. Cy.	ARTHUR ERNEST COWLEY, M.A., LITT.D. Sub-Librarian of the Bodleian Library, Oxford. Fellow of Magdalen College.	{ Hebrew Language; Hebrew Literature.
A. F. P.	ALBERT FREDERICK POLLARD, M.A., F.R.HIST.S. Professor of English History in the University of London. Fellow of All Souls College, Oxford. Assistant Editor of the <i>Dictionary of National Biography</i> , 1893-1901. Lothian Prizeman (Oxford), 1892, Arnold Prizeman, 1898. Author of <i>England under the Protector Somerset</i> ; <i>Henry VIII.</i> ; <i>Life of Thomas Cranmer</i> ; &c.	{ Heath, Nicholas; Henry VIII. of England; Hooper, Bishop; Humphrey, Lawrence.
A. Go.*	REV. ALEXANDER GORDON, M.A. Lecturer on Church History in the University of Manchester.	{ Hofmann, Melchior; Hotman.
A. H. S.	REV. ARCHIBALD HENRY SAYCE, D.D., LITT.D., LL.D. See the biographical article, SAYCE, A. H.	{ Humboldt, Karl W. Von.
A. H.-S.	SIR A. HOUTUM-SCHINDLER, C.I.E. General in the Persian Army. Author of <i>Eastern Persian Irak</i> .	{ Hormuz (<i>in part</i>).
A. J. H.	ALFRED J. HIPKINS, F.S.A. (1826-1903). Formerly Member of Council and Hon. Curator of the Royal College of Music, London. Member of Committee of the Inventions and Music Exhibition, 1883; of the Vienna Exhibition, 1892; and of the Paris Exhibition, 1900. Author of <i>Musical Instruments</i> ; &c.	{ Harp (<i>in part</i>).
A. L.	ANDREW LANG. See the biographical article, LANG, ANDREW.	{ Hauntings.
A. M. C.	AGNES MARY CLERKE. See the biographical article, CLERKE, A. M.	{ Herschel, Sir F. W. (<i>in part</i>); Herschel, Sir J. F. W. (<i>in part</i>); Hewellus; Hipparchus; Horrocks; Huggins; Humboldt.
A. N.	ALFRED NEWTON, F.R.S. See the biographical article, NEWTON, ALFRED.	{ Harpy; Harrier; Hawfinch; Hawk; Heron; Hoatzin; Honeyeater; Honey Guide; Hoopoe; Hornbill; Humming-Bird.
A. S.	ARTHUR SHADWELL, M.A., M.D., LL.D., F.R.C.P. Member of Council of Epidemiological Society. Author of <i>Industrial Efficiency: The London Water Supply; Drink, Temperance and Legislation</i> .	{ Housing.
A. W. H.*	ARTHUR WILLIAM HOLLAND. Formerly Scholar of St John's College, Oxford. Bacon Scholar of Gray's Inn, 1900.	{ Henry IV.: Roman Emperor; Hilde; Hohenzollern; Honorius II.; Anti-Pope.
A. W. W.	ADOLPHUS WILLIAM WARD, LITT.D., LL.D. See the biographical article, WARD, A. W.	{ Hrosvitha.
C. A. M. F.	CHARLES AUGUSTUS MAUDE FENNELL, M.A., LITT.D. Formerly Fellow of Jesus College, Cambridge. Editor of <i>Pindar's Odes and Fragments</i> ; and of the <i>Stanford Dictionary of Anglicised Words and Phrases</i> .	{ Hercules.

¹A complete list, showing all individual contributors, appears in the final volume.

INITIALS AND HEADINGS OF ARTICLES

- C. B.*** CHARLES BÉMONT, Litt.D. (Oxon.).
See the biographical article, BÉMONT, C. { Havet;
Hoxier.
- C. EL** SIR CHARLES NORTON EDGCOMBE ELIOT, K.C.M.G., C.B., M.A., LL.D., D.C.L.
Vice-Chancellor of Sheffield University. Formerly Fellow of Trinity College,
Oxford. H.M.'s Commissioner and Commander-in-Chief for the British East
Africa Protectorate; Agent and Consul-General at Zanzibar; and Consul-General
for German East Africa, 1900-1904. { Hissar (*in part*);
Hungary; *Language*;
Huns.
- C. F. A.** CHARLES FRANCIS ATKINSON.
Formerly Scholar of Queen's College, Oxford. Captain, 1st City of London
(Royal Fusiliers). Author of *The Wilderness and Cold Harbour*. { Hibernicisms (*in part*).
- C. H. Ha.** CARLTON HUNTLEY HAYES, A.M., Ph.D.
Assistant Professor of History in Columbia University, New York City. Member
of the American Historical Association. { Honorius II., III., IV.
- C. J. L.** SIR CHARLES JAMES LYALL, K.C.S.I., C.I.E., LL.D. (Edin.).
Secretary Judicial and Public Department, India Office. Fellow of King's College,
London. Secretary to Government of India, Home Department, 1889-1894.
Chief Commissioner, Central Provinces, India, 1895-1898. Author of *Translations*
of *Ancient Arabic Poetry*; &c. { Hindustani Literature.
- C. L. K.** CHARLES LETEBRIDGE KINGSFORD, M.A., F.R.HIST.S., F.S.A.
Assistant Secretary to the Board of Education. Author of *Life of Henry V.*
Editor of *Chronicles of London*, and *Stow's Survey of London*. { Henry IV., V., VI.;
of England.
- C. Mo.** WILLIAM COSMO MONKHOUSE.
See the biographical article, MONKHOUSE, W. C. { Hunt, W. Holman.
- C. P.** REV. CHARLES PRITCHARD, M.A.
See the biographical article, PRITCHARD, CHARLES. { Herschel, Sir F. W.
(*in part*);
Herschel, Sir J. F. W.
(*in part*).
- C. PL** CHRISTIAN PFISTER, D.-ès-L.
Professor at the Sorbonne, Paris. Chevalier of the Legion of Honour. Author
of *Études sur le règne de Robert le Pieux*. { Hunald.
- C. R. B.** CHARLES RAYMOND BEAZLEY, M.A., D.LITT.
Professor of Modern History in the University of Birmingham. Formerly Fellow
of Merton College, Oxford, and University Lecturer in the History of Geography.
Author of *Henry the Navigator*; *The Dawn of Modern Geography*; &c. { Hayton; Henry
the Navigator.
- C. S.** CARL SCHURZ, LL.D.
See the biographical article, SCHURZ, CARL. { Hayes, Ruthenford B.
- C. W. W.** SIR CHARLES WILLIAM WILSON, K.C.B., K.C.M.G., F.R.S. (1836-1967).
Major-General, Royal Engineers. Secretary to the North American Boundary
Commission, 1858-1862. British Commissioner on the Servian Boundary Com-
mission. Director-General of the Ordnance Survey, 1886-1894. Director-General
of Military Education, 1895-1898. Author of *From Korti to Khartoum*; *Life of*
Lord Clive; &c. { Hierapolis (*in part*).
- D. B. H.** DAVID BINNING MONRO, M.A., Litt.D.
See the biographical article, MONRO, DAVID BINNING. { Homer.
- D. F. T.** DONALD FRANCIS TOVEY.
Author of *Essays in Musical Analysis*: comprising *The Classical Concerto*, *The*
Goldberg Variations, and analyses of many other classical works. { Harmony.
- D. GL** SIR DAVID GILL, K.C.B., LL.D., F.R.S., F.R.A.S., D.Sc.
H.M. Astronomer at Cape of Good Hope, 1879-1907. Served in Geodetic Survey
of Egypt, and on the expedition to Ascension Island to determine the Solar
Parallax by observations of Mars. Directed Geodetic Survey of Natal, Cape Colony
and Rhodesia. Author of *Geodetic Survey of South Africa*; *Catalogues of Stars for*
the Equinoxes (1850, 1860, 1885, 1890, 1900); &c. { Heliconides.
- D. G. H.** DAVID GEORGE HOGARTH, M.A.
Keeper of the Ashmolean Museum, Oxford. Fellow of Magdalen College, Oxford.
Fellow of the British Academy. Excavated at Paphos, 1888; Naucratis, 1899 and
1903; Ephesus, 1904-1905; Assiut, 1906-1907. Director, British School at Athens,
1897-1900. Director, Cretan Exploration Fund, 1899. { Hercules (*in part*);
Hierapolis (*in part*);
Hittites.
- D. H.** DAVID HANNAY.
Formerly British Vice-Consul at Barcelona. Author of *Short History of the Royal*
Navy; *Life of Emilio Castelar*; &c. { Heyn; Hood, Viscount;
Howe, Earl; Humour.
- D. MR.** REV. DUGALD MACFADYEN, M.A.
Minister of South Grove Congregational Church, Highgate. Author of *Constructive*
Congregational Ideals; &c. { Henderson, Alexander
(*in part*).
- D. S.*** DAVID SHARP, M.A., M.B., F.R.S., F.Z.S.
Editor of the *Zoological Record*. Formerly Curator of Museum of Zoology, Univer-
sity of Cambridge. President of Entomological Society of London. Author of
"Insecta" (*Cambridge Natural History*); &c. { Hexapoda (*in part*).
- E. C. B.** RT. REV. EDWARD CUTHBERT BUTLER, O.S.B., M.A., D.LITT.
Abbot of Downside Abbey, Bath. Author of "The Lausiac History of Palladius"
in *Cambridge Texts and Studies*, vol. vi. { Hieronymites;
Hilarion, Saint.
- E. D. B.** EDWIN DAMPIER BRICKWOOD.
Author of *Boat-Racing*; &c. { Horse; *History*;
Horse-Racing (*in part*).

INITIALS AND HEADINGS OF ARTICLES

vii

E. D. Bu.	EDWARD DUNDAS BUTLER. Formerly Assistant in the Department of Printed Books, British Museum. Foreign Member of the Hungarian Academy of Sciences. Author of <i>Hungarian Poems and Fables for English Readers</i> ; &c.	Hungary: <i>Literature</i> (in part).
E. E. S.	ERNEST EDWARD SIKES, M.A. Fellow, Tutor and Lecturer, St John's College, Cambridge. Newton Student at Athens, 1890. Editor of the <i>Prometheus Vincit</i> of Aeschylus, and of <i>The Homeric Hymns</i> .	Hephaestus; Hera; Hermes.
E. F. S.	EDWARD FAIRBROTHER STRANGE. Assistant-Keeper, Victoria and Albert Museum, South Kensington. Member of Council, Japan Society. Author of numerous works on art subjects. Joint-editor of Bell's "Cathedral" Series.	Hiroshige; Hokusai.
E. G.	EDMUND GOSSE, LL.D. See the biographical article, GOSSE, EDMUND, W.	Herole Romances; Herole Verse; Herriek; Holberg.
Ed. M.	EDUARD MEYER, PH.D., D.LITT. (Oxon.), LL.D. Professor of Ancient History in the University of Berlin. Author of <i>Geschichte des Alterthums</i> ; <i>Geschichte des alten Aegypten</i> ; <i>Die Israeliten und ihre Nachbarstämme</i> .	Hornimzd.
E. M. W.	REV. EDWARD MEWBURN WALKER, M.A. Fellow, Senior Tutor and Librarian of Queen's College, Oxford.	Herodotus (in part).
E. O.*	EDMUND OWEN, M.B., F.R.C.S., LL.D., D.Sc. Consulting Surgeon to St Mary's Hospital, London, and to the Children's Hospital, Great Ormond Street, London. Chevalier of the Legion of Honour. Late Examiner in Surgery at the Universities of Cambridge, London and Durham. Author of <i>A Manual of Anatomy for Senior Students</i> .	Heart: <i>Surgery</i> ; Hernia.
E. Pr.	EDGAR PRESTAGE. Special Lecturer in Portuguese Literature at the University of Manchester. Comendador, Portuguese Order of S. Thiago. Corresponding Member of Lisbon Royal Academy of Sciences and Lisbon Geographical Society.	Herulano de Carvalho e Araujo.
E. Ra.*	EMIL REICH, DOC. JURIS., F.R.HIST.S. Author of <i>Hungarian Literature</i> ; <i>History of Civilisation</i> ; &c.	Hungary: <i>Literature</i> (in part).
E. E. B.	EDWYN ROBERT BEVAN, M.A. New College, Oxford. Author of <i>The House of Seleucus</i> ; <i>Jerusalem under the High Priests</i> .	Hellenism.
F. B.	FELICE BARNABEI, LITT.D. Formerly Director of Museum of Antiquities at Rome. Author of archaeological papers in Italian reviews and in the <i>Athenaeum</i> .	Herulanum.
F. C. C.	FREDERICK CORNWALLIS CONYBEARE, M.A., D.TH. (Giessen). Fellow of the British Academy. Formerly Fellow of University College, Oxford. Author of <i>The Ancient Armenian Texts of Aristotle</i> ; <i>Myth, Magic and Morals</i> ; &c.	Holy Water.
F. G. M. B.	FREDERICK GEORGE MEESON BECK, M.A. Fellow and Lecturer of Clare College, Cambridge.	Herul.
F. G. P.	FREDERICK GYMER PARSONS, F.R.C.S., F.Z.S., F.R.ANTHROP.INST. Vice-President, Anatomical Society of Great Britain and Ireland. Lecturer on Anatomy at St Thomas's Hospital and the London School of Medicine for Women. Formerly Hunterian Professor at the Royal College of Surgeons.	Heart: <i>Anatomy</i> .
F. G. S.	F. G. STEPHENS. Formerly art critic of the <i>Athenaeum</i> . Author of <i>Artists at Home</i> ; <i>George Cruikshank: Memorials of W. Mulready</i> ; <i>French and Flemish Pictures</i> ; <i>Sir E. Landseer</i> ; <i>T. C. Hook, R.A.</i> ; &c.	Holl, Frank.
F. H. B.	FRANCIS HENRY BUTLER, M.A. Worcester College, Oxford. Associate of the Royal School of Mines.	Honey; Hunter, John; Hunter, William.
F. LL. G.	FRANCIS LLEWELLYN GRIFFITH, M.A., PH.D., F.S.A. Reader in Egyptology, Oxford University. Editor of the <i>Archaeological Survey and Archaeological Reports of the Egypt Exploration Fund</i> . Fellow of Imperial German Archaeological Institute.	Heliopolis; Hermes Trismegistus; Horus.
F. O. B.	FREDERICK ORPEN BOWER, D.Sc., F.R.S. Regius Professor of Botany in the University of Glasgow. Author of <i>Practical Botany for Beginners</i> .	Hofmeister.
F. Pz.	FRANK PTAUX. President of the Société de l'Histoire du Protestantisme français. Author of <i>Les Précurseurs français de la tolérance</i> ; <i>Histoire de l'établissement des protestants français en Suède</i> ; <i>L'Eglise réformée de France</i> ; &c.	Huguenots.
G. A. Gr.	GEORGE ABRAHAM GRIERSON, C.I.E. PH.D., D.LITT. Member of the Indian Civil Service, 1873-1903. In charge of Linguistic Survey of India, 1898-1902. Gold Medallist, Asiatic Society, 1909. Vice-President of the Royal Asiatic Society. Formerly Fellow of Calcutta University. Author of <i>The Languages of India</i> ; &c.	Hindostani.
G. C. R.	GEORGE CROOM ROBERTSON, M.A. See the biographical article, ROBERTSON, G. C.	Hobbes, Thomas (in part).
G. C. W.	GEORGE CHARLES WILLIAMSON, LITT.D. Chevalier of the Legion of Honour. Author of <i>Portrait Miniatures</i> ; <i>Life of Richard Comany, R.A.</i> ; <i>George Englehart</i> ; <i>Portrait Drawings</i> ; &c. Editor of new edition of Bryan's <i>Dictionary of Printers and Engravers</i> .	Hilliard, Lawrence; Hilliard, Nicholas; Hoskins. Humphry, Ozias.

INITIALS AND HEADINGS OF ARTICLES

- G. G. S.** GEORGE GREGORY SMITH, M.A.
Professor of English Literature, Queen's University of Belfast. Author of *The Days of James IV.*; *The Transition Period*; *Specimens of Middle Scots*; &c. { Henryson.
- G. E.** REV. GEORGE EDMUNDSON, M.A., F.R.HIST.S.
Formerly Fellow and Tutor of Brasenose College, Oxford. Ford's Lecturer, 1909. Hon. Member, Dutch Historical Society, and Foreign Member, Netherlands Association of Literature. { Holland: *History*.
Holland: *County and Province of*.
- G. H. G.** GEORGE HERBERT CARPENTER, B.Sc.
Professor of Zoology in the Royal College of Science, Dublin. President of the Association of Economic Biologists. Member of the Royal Irish Academy. Author of *Insects: their Structure and Life*; &c. { Hemiptera;
Hexapoda (*in part*).
- G. J. T.** GEORGE JAMES TURNER.
Barrister-at-Law, Lincoln's Inn. Editor of *Select Pleas for the Forests for the Selden Society*. { Hundred.
- G. K.** GUSTAV KRÜGER.
Professor of Church History in the University of Giessen. Author of *Das Papsttum*; &c. { Hippolytus.
- G. R.** REV. GEORGE RAWLINSON, M.A.
See the biographical article, RAWLINSON, GEORGE. { Herodotus (*in part*).
- G. W. T.** REV. GRIFFITHS WHEELER THATCHER, M.A., B.D.
Warden of Camden College, Sydney, N.S.W. Formerly Tutor in Hebrew and Old Testament History at Mansfield College, Oxford. { Hasan-ul-Basfi;
Hassān ibn Thābit;
Hishām ibn al-Kalbi.
- H.** LORD HOUGHTON.
See the biographical article, HOUGHTON, 1ST BARON. { Hood, Thomas.
- H. Br.** HENRY BRADLEY, M.A., PH.D.
Joint-editor of the *New English Dictionary* (Oxford). Fellow of the British Academy. Author of *The Story of the Goths*; *The Making of English*; &c. { Holland.
- H. Et.** SIR HENRY BURDETT, K.C.B., K.C.V.O.
Founder and Editor of *The Hospital*. Formerly Superintendent of the Queen's Hospital, Birmingham, and the Seamen's Hospital, Greenwich. Author of *Hospitals and Asylums of the World*; &c. { Hospital.
- H. Ch.** HUGH CHISHOLM, M.A.
Formerly Scholar of Corpus Christi College, Oxford. Editor of the 11th edition of the *Encyclopædia Britannica*; Co-editor of the 10th edition. { Howe, Samuel Gridley.
- H. De.** HIPPOLYTE DELAHAYE, S.J.
Assistant in the compilation of the Bollandist publications: *Analecæ Bollandiana* and *Acta-sanctorum*. { Helena, St; Hubert, St.
- H. L.** HENRI LABROSSE.
Assistant Librarian at the Bibliothèque Nationale, Paris. Officer of the Academy. { Hugh of St Omer.
- H. L. G.** HUGH LONGBOURNE CALLENDAR, F.R.S., LL.D.
Professor of Physics, Royal College of Science, London. Formerly Professor of Physics in McGill College, Montreal, and in University College, London. { Heat.
- H. M. V.** HERBERT M. VAUGHAN, F.S.A.
Keble College, Oxford. Author of *The Last of the Royal Stuarts*; *The Medici Popes*; *The Last Stuart Queen*. { Henry, Stuart (Cardinal York).
- H. W. C. D.** HENRY WILLIAM CARLESS DAVIS, M.A.
Fellow and Tutor of Balliol College, Oxford. Fellow of All Souls College, Oxford, 1895-1902. Author of *England under the Normans and Angevins*; *Charlemagne*. { Henry I., II., III.:
Of England.
Henry of Huntingdon.
- H. W. R.*** REV. HENRY WHEELER ROBINSON, M.A.
Professor of Church History in Rawdon College, Leeds. Senior Kennicott Scholar, Oxford, 1901. Author of *Hebrew Psychology in Relation to Pauline Anthropology* (in Mansfield College Essays); &c. { Hosea (*in part*).
- H. W. S.** H. WICKHAM STED.
Correspondent of *The Times* at Vienna. Correspondent of *The Times* at Rome, 1897-1902. { Humbert, King.
- H. Y.** SIR HENRY YULE, K.C.S.I., C.B.
See the biographical article, YULE, SIR H. { Normus (*in part*);
Hsüan Tsang (*in part*).
- I. A.** ISRAEL ABRAHAMS, M.A.
Reader in Talmudic and Rabbinic Literature in the University of Cambridge. Formerly President, Jewish Historical Society of England. Author of *A Short History of Jewish Literature*; *Jewish Life in the Middle Ages*; *Judaism*; &c. { Hasdai ibn Shaprut;
Harzi;
Hirsch, Samson R.
- J. A. C.** SIR JOSEPH ARCHER CROWE, K.C.M.G.
See the biographical article, CROWE, SIR J. A. { Hobbema; Holbein.
- J. A. R.** VERY REV. JOSEPH ARMITAGE ROBINSON, D.D.
Dean of Westminster. Fellow of the British Academy. Hon. Fellow of Christ's College, Cambridge. Formerly Fellow of Christ's College, Cambridge, and Norrisian Professor of Divinity in the University. Author of *Some Thoughts on the Incarnation*; &c. { Hippolytus, The Canons of.
- J. Et.** JAMES BARTLETT.
Lecturer on Construction, Architecture, Sanitation, Quantities, &c., at King's College, London. Member of Society of Architects. Member of Institute of Junior Engineers. { Heating.

INITIALS AND HEADINGS OF ARTICLES

J. B. T.	SIR JOHN BATTY TUKE, M.D., F.R.S. (Edin.), D.Sc., LL.D. President of the Neurological Society of the United Kingdom. Medical Director of New Saughton Hall Asylum, Edinburgh. M.P. for the Universities of Edinburgh and St Andrews, 1900-1910.	{ Hippocrates.
J. Da.	REV. JAMES DAVIES, M.A. (1820-1883). Formerly Head Master of Ludlow Grammar School and Prebendary of Hereford Cathedral. Translated classical authors for Bohn's "Classical Library." Author of volumes in Collins's <i>Ancient Classics for English Readers</i> .	{ Hesiod (<i>in part</i>).
J. B.	H. JULIUS EGGELE, PH.D. Professor of Sanskrit and Comparative Philology, University of Edinburgh. Formerly Secretary and Librarian to Royal Asiatic Society.	{ Hinduism.
J. F. F.	JOHN FAIRFULL FLEET, C.I.E. Commissioner of Central and Southern Divisions of Bombay, 1891-1897. Author of <i>Inscriptions of the Early Gupta Kings</i> ; &c.	{ Hindu Chronology.
J. F. H. B.	SIR JOHN FRANCIS HARPIN BROADBENT, BART., M.A., M.D. Physician to Out-Patients, St Mary's Hospital, London, and to the Hampstead General Hospital. Assistant Physician to the London Fever Hospital. Author of <i>Heart Disease and Aneurysm</i> ; &c.	{ Heart: <i>Heart Disease</i> .
J. G.*	REV. JAMES GOW, M.A., LITT.D. Head Master of Westminster School. Fellow of King's College, London. Formerly Fellow of Trinity College, Cambridge. Editor of <i>Horace's Odes and Satires</i> . Author of <i>A Companion to the School Classics</i> ; &c.	{ Horace (<i>in part</i>).
J. Ga.	JAMES GAIRDNER, C.B. See the biographical article, GAIRDNER, J	{ Henry VII.: of England.
J. G. M.	JOHN GRAY MCKENDRICK, M.D., LL.D., F.R.S., F.R.C.P. (Edin.) Emeritus Professor of Physiology at the University of Glasgow. Author of <i>Life in Motion</i> ; <i>Life of Helmholtz</i> ; &c.	{ Hearing; Helmholtz.
J. G. R.	JOHN GEORGE ROBERTSON, M.A., PH.D. Professor of German at the University of London. Formerly Lecturer on the English Language, Strassburg University. Author of <i>History of German Literature</i> ; &c.	{ Helne (<i>in part</i>); Hildebrand, Lay of; Hoffmann, E. T. W.
J. Hn.	JÜSTÜS HARBAGEN, PH.D. Privatdozent in Medieval and Modern History, University of Bonn. Author of <i>Das Rheinland unter der französischen Herrschaft</i> .	{ Hoeker, F. F. K.; Hertzberg, Count Von; Hormayr.
J. H. A. H.	JOHN HENRY ARTHUR HART, M.A. Fellow, Theological Lecturer and Librarian, St John's College, Cambridge.	{ Herod; Herodians.
J. H. F.	JOHN HENRY FREESE, M.A. Formerly Fellow of St John's College, Cambridge.	{ Herald; Hesiod (<i>in part</i>).
J. H. Mu.	JOHN HENRY MUTREHEAD, M.A., LL.D. Professor of Philosophy in the University of Birmingham. Author of <i>Elements of Ethics</i> ; <i>Philosophy and Life</i> ; &c. Editor of <i>Library of Philosophy</i> .	{ Hegel: <i>Hegelianism in England</i> .
J. H. R.	JOHN HORACE ROUND, M.A., LL.D. (Edin.) Author of <i>Federal England</i> ; <i>Studies in Peerage and Family History</i> ; <i>Peerage and Pedigree</i> .	{ Hereward.
J. J. F.	REV. JAMES J. FOX. St Thomas's College, Brookland, D.C., U.S.A.	{ Hoeker, I. T.
J. K. L.	SIR JOHN KNOX LAUGHTON, M.A., LITT.D. Professor of Modern History, King's College, London, Secretary of the Navy Records Society. Served in the Baltic, 1854-1855; in China, 1856-1859. Honorary Fellow, Gonville and Caius College, Cambridge. Fellow, King's College, London. Author of <i>Physical Geography in its Relation to the Prevailing Winds and Currents</i> ; <i>Studies in Naval History</i> ; <i>Sea Fights and Adventures</i> ; &c.	{ Hood of Avalon.
J. M. M.	JOHN MALCOLM MITCHELL. Sometime Scholar of Queen's College, Oxford. Lecturer in Classics, East London College (University of London). Joint-editor of Grote's <i>History of Greece</i> .	{ Heraclitus; Hume, David (<i>in part</i>).
J. P.-B.	JAMES GEORGE JOSEPH PENDEREL-BRODBURST. Editor of the <i>Guardian</i> (London).	{ Hopplewhita.
J. P. Pe.	REV. JOHN PUNNETT PETERS, PH.D., D.D. Canon Residentiary, Cathedral of New York. Formerly Professor of Hebrew in the University of Pennsylvania. Director of the University Expedition to Babylonia, 1888-1895. Author of <i>Nippur, or Explorations and Adventures on the Euphrates</i> .	{ Hillah; Hll.
J. S. Co.	JAMES SUTHERLAND COTTON, M.A. Editor of <i>The Imperial Gazetteer of India</i> . Hon. Secretary of the Egyptian Exploration Fund. Formerly Fellow and Lecturer of Queen's College, Oxford. Author of <i>India in the "Citizen" Series</i> ; &c.	{ Hastings, Warren.
J. S. F.	JOHN SMITH FLETT, D.Sc., F.G.S. Petrographer to the Geological Survey. Formerly Lecturer on Petrology in Edinburgh University. Neill Medallist of the Royal Society of Edinburgh. Bigsby Medallist of the Geological Society of London.	{ Hornfels.
J. T. Ba.	JOHN T. BEALBY. Joint-author of Stanford's <i>Europe</i> . Formerly Editor of the <i>Scottish Geographical Magazine</i> . Translator of Sven Hedin's <i>Through Asia, Central Asia and Tibet</i> ; &c.	{ Hissar (<i>in part</i>).

INITIALS AND HEADINGS OF ARTICLES

- J. T. C.** JOSEPH THOMAS CUNNINGHAM, M.A., F.Z.S.
Lecturer on Zoology at the South-Western Polytechnic, London. Formerly Fellow of University College, Oxford. Assistant Professor of Natural History in the University of Edinburgh and Naturalist to the Marine Biological Association. { Herring.
- J. T. Mo.** JOHN TORREY MORSE, Jr.
Author of *The Life and Letters of Oliver Wendell Holmes*. { Holmes, Oliver Wendell.
- J. T. S.*** JAMES THOMSON SHOTWELL, Ph.D.
Professor of History in Columbia University, New York City. { History.
- J. V.*** JULES VIARD.
Archivist at the National Archives, Paris. Officer of Public Instruction. Author of *La France sous Philippe VI. de Valois*; &c. { Hundred Years' War.
- J. V. B.** JAMES VERNON BARTLET, M.A., D.D. (St Andrews).
Professor of Church History, Mansfield College, Oxford. Author of *The Apostolic Age*; &c. { Hebrews, Epistle to the;
Herman, Shephard of,
- J. Ws.** JOHN WEATHERS, F.R.H.S.
Lecturer on Horticulture to the Middlesex County Council. Author of *Practical Guide to Garden Plants*; *French Market Gardening*; &c. { Hippeastrum; Honeysuckle;
Horticulture (in part).
- J. W.*** JAMES WARD, D.Sc., LL.D.
Professor of Mental Philosophy and Logic in the University of Cambridge. Fellow of Trinity College, Cambridge. Fellow of the British Academy. Fellow of the New York Academy of Sciences. { Harbart.
- J. W. F.** J. WALTER FERRIER.
Translated *George Eliot and Judaism* from the German of Kaufmann. Author of *Motischkffe*. { Helme (in part).
- J. W. Fo.** THE HON. JOHN WATSON FOSTER, A.M., LL.D.
Professor of American Diplomatics, George Washington University, Washington, U.S.A. Formerly U.S. Secretary of State. Author of *Diplomatic Memoirs*; &c. { Harrison, Benjamin.
- K. S.** KATHLEEN SCHLESINGER.
Editor of *The Fortieth of Musical Archaeology*. Author of *The Instruments of the Orchestra*. { Harp (in part);
Harp-Lute; Harpsichord;
Holstromps; Horn;
Hurdy-Gurdy.
- L. H. B.** LIBERTY HYDE BAILEY, LL.D.
Director of the College of Agriculture, Cornell University. Chairman of Roosevelt Commission on Country Life. { Horticulture: American
Calendar (in part).
- L. J. S.** LEONARD JAMES SPENCER, M.A.
Assistant in Department of Mineralogy, British Museum. Formerly Scholar of Sidney Sussex College, Cambridge, and Harkness Scholar. Editor of the *Mineralogical Magazine*. { Harmotome; Hemimorphite;
Houlandite; Hornblende;
Humite.
- L. W.** LUCIEN WOLF.
Vice-President of the Jewish Historical Society of England. Formerly President of the Society. Joint-editor of the *Bibliotheca Anglo-judaica*. { Hirsch, Baron.
- M. G.** MOSES GASTER, Ph.D. (Leipzig).
Chief Rabbi of the Sephardic Communities of England. Vice-President, Zionist Congress, 1898, 1899, 1900. Ilchester Lecturer at Oxford on Slavonic and Byzantine Literature, 1896 and 1891. President, Folk Lore Society of England. Vice-President Anglo-Jewish Association. Author of *History of Rumanian Popular Literature*; &c. { Hasdeu.
- M. Ha.** MARCUS HARTOG, M.A., D.Sc., F.L.S.
Professor of Zoology, University College, Cork. Author of "Protozoa" in *Cambridge Natural History*; and papers for various scientific journals. { Helleoza.
- M. H. C.** MONTAGUE HUGHES CRACKANTHORPE, K.C., D.C.L.
President of the Eugenics Education Society. Honorary Fellow, St John's College, Oxford. Bencher of Lincoln's Inn. Formerly Member of the General Council of the Bar and of the Council of Legal Education, and Standing Counsel to the University of Oxford. { Herschell, 1st Baron.
- M. H. T.** MARCUS NIEHSUR TOD, M.A.
Fellow and Tutor of Oriel College, Oxford. University Lecturer in Epigraphy. Joint-author of *Catalogue of the Sparta Museum*. { Helots.
- M. O. B. G.** MAXIMILIAN OTTO BISMARCK CASPARI.
Reader in Ancient History at London University. Lecturer in Greek at Birmingham University, 1905-1908. { Heraclius.
- M. T. M.** MAXWELL T. MASTERS, M.D., F.R.S. (1833-1907).
Formerly Editor of *Gardener's Chronicle*; and Lecturer on Botany, St George's Hospital, London. Author of *Plant Life*; *Botany for Beginners*; and numerous monographs in botanical works. { Horticulture (in part).
- M. D. M.** NEWTON DENNISON MEREWESS, A.M., Ph.D.
Author of *Maryland as a Proprietary Province*. { Henry, Patrick;
Homestead and Exemption
Laws.
- O. Ba.** OSWALD BARRON, F.S.A.
Editor of *The Ancestor*, 1902-1905. Hon. Genealogist to Standing Council of the Honourable Society of the Baronetage. { Heraldry;
Herbert: family;
Howard: family.
- O. Br.** OSCAR BRILLIANT.
{ Hungary: Geography
and Statistics.

INITIALS AND HEADINGS OF ARTICLES

xi

- O. C. W.** **REV. OWEN CHARLES WHITEHOUSE, M.A., D.D.**
Christ's College, Cambridge. Professor of Hebrew, Biblical Exegesis and Theology, and Theological Tutor, Cheshunt College, Cambridge. { Hebrew Religion.
- P. A.** **PAUL DANIEL ALPHANDÉRY.**
Professor of the History of Dogma, École pratique des hautes études, Sorbonne, Paris. Author of *Les Idées morales chez les hétérodoxes Latines au début du XIII^e siècle.* { Henry of Lausanne;
Hugh of St Victor;
Humillat.
- P. C. M.** **PETER CHALMERS MITCHELL, M.A., F.R.S., F.Z.S., D.Sc., LL.D.**
Secretary to the Zoological Society of London. University Demonstrator in Comparative Anatomy and Assistant to Linacre Professor at Oxford, 1888-1891. Examiner in Zoology to the University of London, 1903. Author of *Outlines of Biology*; &c. { Hemichorda;
Heredity.
- P. C. Y.** **PHILIP CHESNEY YORKE, M.A.**
Magdalen College, Oxford. Editor of *Letters of Princess Elizabeth of England.* { Holles, Baron.
- P. H.** **PETER HENDERSON (1823-1890).**
Formerly Horticulturist, Jersey City and New York. Author of *Gardening for Profit, Garden and Farm Topics.* { Horticulture: American
Calendar (in part).
- P. H. P.-S.** **PHILIP HENRY PYE-SMITH, M.D., F.R.S.**
Consulting Physician to Guy's Hospital, London. Formerly Vice-Chancellor of the University of London. Joint-author of *A Text Book of Medicine*; &c. { Harvey, William.
- P. L.** **PHILIP LAKE, M.A., F.G.S.**
Lecturer on Physical and Regional Geography in Cambridge University. Formerly of the Geological Survey of India. Author of *Monograph of British Cambrian Trilobites.* Translator and Editor of Kayser's *Comparative Geology.* { Himalaya: Geology.
- R. A.*** **ROBERT ANCHEL.**
Archivist to the Department de l'Eure. { Hérault de Séchelles.
- R. Ad.** **ROBERT ADAMSON, LL.D.**
See the biographical article, ADAMSON, R. { Hume, David (in part).
- R. A. S. M.** **ROBERT ALEXANDER STEWART MACALISTER, M.A., F.S.A.**
St John's College, Cambridge. Director of Excavations for the Palestine Exploration Fund. { Hebron; Hor, Mt.
- R. A. W.** **ROBERT ALEXANDER WAHAB, C.B., C.M.G., C.I.E.**
Colonel, Royal Engineers. Formerly H.M. Commissioner, Aden Boundary Delimitation, and Superintendent, Survey of India. Served with Tirah Expeditionary Force, 1897-1898; Anglo-Russian Boundary Commission, Pamirs, 1895; &c. { Hass, El; Hojaz.
- R. H. S.** **RICHARD HENRY STODDARD.**
See the biographical article, STODDARD, RICHARD HENRY. { Hawthorne, Nathaniel.
- R. I. P.** **REGINALD INNES POCOCK, F.Z.S.**
Superintendent of the Zoological Gardens, London. { Harvester; Hibernation.
- R. J. M.** **RONALD JOHN McNEILL, M.A.**
Christ Church, Oxford. Barrister-at-Law. Formerly Editor of the *St James's Gazette*, London. { Holy-Hutchinson.
- R. J. S.** **HON. ROBERT JOHN STRUTT, M.A., F.R.S.**
Professor of Physics in the Imperial College of Science and Technology, South Kensington. Fellow of Trinity College, Cambridge. { Hellum.
- R. K. D.** **SIR ROBERT KENNAWAY DOUGLAS.**
Formerly Keeper of Oriental Printed Books and MSS. at the British Museum, and Professor of Chinese, King's College, London. Author of *The Language and Literature of China*; &c. { Hsüan Tsang (in part).
- R. L.*** **RICHARD LYDEKKER, F.R.S., F.G.S., F.Z.S.**
Member of the Staff of the Geological Survey of India, 1874-1882. Author of *Catalogue of Fossil Mammals, Reptiles and Birds in the British Museum*; *The Deer of all Lands*; *The Game Animals of Africa*; &c. { Hedgehog;
Hippopotamus;
Horse (in part); Howler.
- R. N. B.** **ROBERT NISBET BAIN (d. 1909).**
Assistant Librarian, British Museum, 1881-1909. Author of *Scandinavia, the Political History of Denmark, Norway and Sweden, 1513-1900*; *The First Romanovs 1613-1725*; *Slavonic Europe, the Political History of Poland and Russia from 1469 to 1700*; &c. { Höpken; Horn, A. B., Count;
Hungary: History (in part);
Hunyadi, János;
Hunyadi, László.
- R. Po.** **RENÉ POUPOARDIN, D.-ÈS-L.**
Secretary of the Ecole des Chartes. Honorary Librarian at the Bibliothèque Nationale, Paris. Author of *Le Royaume de Provence sous les Carolingiens*; *Recueil des chartes de Saint-Germain*; &c. { Hinemar.
- R. P. S.** **R. PHENÉ SPIERS, F.S.A., F.R.I.B.A.**
Formerly Master of the Architectural School, Royal Academy, London. Past President of Architectural Association. Associate and Fellow of King's College, London. Corresponding Member of the Institute of France. Editor of *Fergusson's History of Architecture*. Author of *Architecture: East and West*; &c. { House.
- R. S. C.** **ROBERT SEYMOUR CONWAY, M.A., D.LITT. (Cantab.).**
Professor of Latin and Indo-European Philology in the University of Manchester. Formerly Professor of Latin in University College, Cardiff; and Fellow of Gonville and Caius College, Cambridge. Author of *The Italic Dialects.* { Hernald;
Hirpini.
- R. S. T.** **RALPH STOCKMAN TARR.**
Professor of Physical Geography, Cornell University. { Hudson River.

INITIALS AND HEADINGS OF ARTICLES

- R. W.** ROBERT WALLACE, F.R.S. (Edin.), F.L.S.
Professor of Agriculture and Rural Economy at Edinburgh University, and Garton Lecturer on Colonial and Indian Agriculture. Professor of Agriculture, R.A.C., Cirencester, 1882-1885. Author of *Farm Live Stock of Great Britain; The Agriculture and Rural Economy of Australia and New Zealand; Farming Industries of Cape Colony; &c.* } *Horse (in part).*
- S. F. B.** SPENCER FULLERTON BAIRD, LL.D.
See the biographical article, BAIRD, S. F. } *Henry, Joseph.*
- S. A. C.** STANLEY ARTHUR COOK, M.A.
Lecturer in Hebrew and Syriac, and formerly Fellow, Gonville and Caius College, Cambridge. Editor for Palestine Exploration Fund. Examiner in Hebrew and Aramaic, London University, 1904-1908. Author of *Glossary of Aramaic Inscriptions; The Laws of Moses and the Code of Hammurabi; Critical Notes on Old Testament History; Religion of Ancient Palestine; &c.* } *Herakliah;
Hoshua.*
- T. A. I.** THOMAS ALLAN INGRAM, M.A., LL.D.
Trinity College, Dublin. } *Holiday.*
- T. As.** THOMAS ASHEBY, M.A., D.LITT. (Oxon.).
Director of British School of Archaeology at Rome. Formerly Scholar of Christ Church, Oxford. Craven Fellow, 1897. Conington Prizeman, 1906. Member of the Imperial German Archaeological Institute. } *Heracles (in part);
Hispellum.*
- T. Ba.** SIR THOMAS BARCLAY, M.P.
Member of the Institute of International Law. Member of the Supreme Council of the Congo Free State. Officer of the Legion of Honour. Author of *Problems of International Practice and Diplomacy; &c.* M.P. for Blackburn, 1910. } *High Seas.*
- T. B.*** THOMAS BROWN.
Incorporated Weaving, Dyeing and Printing College, Glasgow. } *Hosiery.*
- T. F. H.** T. F. HENDERSON.
Author of *The Cashel Letters and Mary Queen of Scots; Life of Robert Burns; &c.* } *Hooker, Richard.*
- T. Gl.** THOMAS GILRAY, M.A.
Formerly Professor of Modern History and English Literature, University College, Dundee. } *Henderson, Alexander
(in part).*
- T. H. H.*** COLONEL SIR THOMAS HUNGERFORD HOLDICH, K.C.M.G., K.C.I.E., Hon. D.Sc.
Superintendent Frontier Surveys, India, 1892-1898. Gold Medalist, R.G.S., London, 1887. Author of *The Indian Borderland; The Countries of the King's Award; India; Tibet; &c.* } *Helmund; Herat;
Himalaya;
Hindu Kush.*
- T. L. H.** SIR THOMAS LITTLE HEATH, K.C.B., D.Sc.
Assistant Secretary to the Treasury. Formerly Fellow of Trinity College, Cambridge. } *Hero of Alexandria.*
- T. Se.** THOMAS SECCOMBE, M.A.
Balliol College, Oxford. Lecturer in History, East London and Birkbeck Colleges, University of London. Stanhope Prizeman, Oxford, 1887. Assistant Editor of *Dictionary of National Biography, 1891-1901.* Author of *The Age of Johnson; joint-author of Bookman History of English Literature; &c.* } *Hayward, Abraham;
Hughes, Thomas.*
- T. Wo.** THOMAS WOOHOUSE.
Head of the Weaving and Textile Designing Department, Technical College, Dundee. } *Hose-Pipe.*
- T. W. A.** THOMAS WILLIAM ALLEN, M.A.
Fellow and Tutor of Queen's College, Oxford. Joint-editor of *The Homeric Hymns.* } *Homer (in part).*
- W. A. B. C.** REV. WILLIAM AUGUSTUS BREVOORT COOLIDGE, M.A., F.R.G.S., PH.D.
Fellow of Magdalen College, Oxford. Professor of English History, St David's College, Lampeter, 1880-1881. Author of *Guide to Switzerland; The Alps in Nature and in History; &c.* Editor of *The Alpine Journal, 1880-1889.* } *Hautes Alpes;
Haute-Savoie;
Herzog, Hans.*
- W. A. P.** WALTER ALISON PHILLIPS, M.A.
Formerly Exhibitioner of Merton College and Senior Scholar of St John's College, Oxford. Author of *Modern Europe; &c.* } *Hohenlohe (in part).
Holy Alliance, The;
Honorius I;
Hungary: History (in part).*
- W. Ba.** WILLIAM BACHER, D.Ph.
Professor of Biblical Studies at the Rabbinical Seminary, Budapest. } *Hilal.*
- W. Fr.** WILLIAM FREAM, LL.D. (d. 1907).
Formerly Lecturer on Agricultural Entomology, University of Edinburgh, and Agricultural Correspondent of *The Times.* } *Hop;
Horse (in part).*
- W. F. C.** WILLIAM FEILDEN CRAIGES, M.A.
Barrister-at-Law, Inner Temple. Lecturer on Criminal Law at King's College, London. Editor of *Archbold's Criminal Pleading (23rd ed.)*. } *Homicide.*
- W. G. H.** WALTER GEORGE HEADLAM (1866-1908).
Fellow of King's College, Cambridge. Editor of *Herodas.* Translator of the plays of Aeschylus. } *Herodas.*
- W. H. F.** SIR WILLIAM HENRY FLOWER, F.R.S.
See the biographical article, FLOWER, SIR W. H. } *Horse (in part).*
- W. H. Ha.** WILLIAM HENRY HADOW, M.A., MUS.DOC.
Principal, Armstrong College, Newcastle-on-Tyne. Formerly Fellow and Tutor of Worcester College, Oxford. Member of Council, Royal College of Music. Editor of *Oxford History of Music.* Author of *Studies in Modern Music; &c.* } *Haydn.*

INITIALS AND HEADINGS OF ARTICLES

xiii

W. L. G.	WILLIAM LAWSON GRANT, M.A. Professor at Queen's University, Kingston, Canada. Formerly Beit Lecturer in Colonial History at Oxford University. Editor of <i>Acts of the Privy Council</i> , Colonial Series; <i>Canadian Constitutional Development</i> (in collaboration).	Howe, Joseph.
W. M. R.	WILLIAM MICHAEL ROSSETTI. See the biographical article, ROSSETTI, DANTE GABRIEL.	Haydon, Benjamin Robert.
W. P. J.	WILLIAM PRICE JAMES. University College, Oxford. Barrister-at-Law. High Bailiff of County Courts, Cardiff. Author of <i>Romantic Professions</i> ; &c.	Henley, W. E.
W. R. M.	SIR WILLIAM ROBERTSON NICOLL, LL.D. See the biographical article, NICOLL, SIR W. R.	Harris, Thomas Lake
W. R. S.	WILLIAM ROBERTSON SMITH, LL.D. See the biographical article, SMITH, WILLIAM ROBERTSON.	Hossa (in part).
W. R. S.-R.	WILLIAM RALSTON SHEDDEN-RALSTON, M.A. Assistant in the Department of Printed Books, British Museum. Author of <i>Russian Folk Tales</i> ; &c.	Hortzen.
W. R. W.	WILLIAM ROBERT WORTHINGTON WILLIAMS, F.L.S. Superintendent of London County Council Botany Centre. Assistant Lecturer in Botany, Birkbeck College (University of London). Member of the Geologists' Association.	Horticulture (in part).
W. T. H.	WILLIAM TOD HELMUTH, M.D., LL.D. (d. 1901). Formerly Professor of Surgery and Dean of the Homoeopathic and Medical College and Hospital, New York. President of the Collins State Homoeopathic Hospital. Sometime President of the American Institute of Homoeopathy and the New York State Homoeopathic Medical Society. Author of <i>Treatise on Diphtheria</i> ; <i>System of Surgery</i> ; &c.	Homoeopathy.
W. W.	WILLIAM WALLACE, LL.D. See the biographical article, WALLACE, WILLIAM (1844-1897).	Hegel (in part).
W. W.	WILLISTON WALKER, PH.D., D.D. Professor of Church History, Yale University. Author of <i>History of the Congregational Churches in the United States</i> ; <i>The Reformation</i> ; <i>John Calvin</i> ; &c.	Hopkins, Samuel.
W. Y. S.	WILLIAM YOUNG SELLAR, LL.D. See the biographical article, SELLAR, W. Y.	Horace (in part).

PRINCIPAL UNSIGNED ARTICLES

Harrow.
Hartford.
Hartlepool.
Harvard University.
Harz Mountains.
Hat.
Havana.
Hawaii.
Hazel.
Health.

Heath.
Hebrides, The.
Heidelberg Catechism.
Helligoland.
Heliostat.
Hellsbore.
Helmet.
Hemp.
Herbarium.

Herefordshire.
Hero.
Hertfordshire.
Hesse.
Hesse-Cassel.
Hesse-Darmstadt.
High Place.
Highway.
Hockey.

Holly.
Homfly.
Honduras.
Hong-Kong.
Hostage.
Hottentots.
Household, Royal.
Hudson's Bay Company.
Huntingdonshire.

ENCYCLOPÆDIA BRITANNICA

ELEVENTH EDITION

VOLUME XIII

HARMONY (Gr. *ἁρμονία*, a concord of musical sounds, *ἀρμόζειν* to join; *ἁρμονική* (sc. *τέχνη*) meant the science or art of music, *ἁρμονική* being of wider significance), a combination of parts so that the effect should be aesthetically pleasing. In its earliest sense in English it is applied, in music, to a pleasing combination of musical sounds, but technically it is confined to the science of the combination of sounds of different pitch.

I. *Concord and Discord*.—By means of harmony modern music has attained the dignity of an independent art. In ancient times, as at the present day among nations that have not come under the influence of European music, the harmonic sense was, if not altogether absent, at all events so obscure and undeveloped as to have no organizing power in the art. The formation by the Greeks of a scale substantially the same as that which has received our harmonic system shows a latent harmonic sense, but shows it in a form which positively excludes harmony as an artistic principle. The Greek perception of certain *successions* of sounds as concordant rests on a principle identifiable with the scientific basis of concord in simultaneous sounds. But the Greeks did not conceive of musical simultaneity as consisting of anything but identical sounds; and when they developed the practice of *magadizing*—i.e. singing in octaves—they did so because, while the difference between high and low voices was a source of pleasure, a note and its octave were then, as now, perceived to be in a certain sense identical. We will now start from this fundamental identity of the octave, and with it trace the genesis of other concords and discords; bearing in mind that the history of harmony is the history of artistic instincts and not a series of progressive scientific theories.

The unisonous quality of octaves is easily explained when we examine the "harmonic series" of upper partials (see **SOUND**). Every musical sound, if of a timbre at all rich (and hence pre-eminently the human voice), contains some of these upper partials. Hence, if one voice produce a note which is an upper

higher voice will also coincide with some of the lower. Thus, if a note and its octave be sung together, the upper octave is itself No. 2 in the harmonic series of the lower, No. 2 of its own series is No. 4 of the lower, and its No. 3 is No. 6, and so on. The impression of identity thus produced is so strong that we often find among people unacquainted with music a firm conviction that a man is singing in unison with a boy or an instrument when he is really singing in the octave below. And even musical people find a difficulty in realizing more than a certain brightness and richness of single tone when a violinist plays octaves perfectly in tune and with a strong emphasis on the lower notes. Doubling in octaves therefore never was and never will be a process of harmonization.

Now if we take the case of one sound doubling another in the 12th, it will be seen that here, too, no real addition is made by the higher sound to the lower. The 12th is No. 3 of the harmonic series, No. 2 of the higher note will be No. 6 of the lower, No. 3 will be No. 9, and so on. But there is an important difference between the 12th and the octave. However much we alter the octave by transposition into other octaves, we never get anything but unison or octaves. Two notes two octaves apart are just as devoid of harmonic difference as a plain octave or unison. But, when we apply our principle of the identity of the octave to the 12th, we find that the removal of one of the notes by an octave may produce a combination in which there is a distinct harmonic element. If, for example, the lower note is raised by an octave so that the higher note is a fifth from it, No. 3 of the harmonic series of the higher note will not belong to the lower note at all. The 5th is thus a combination of which the two notes are obviously different; and, moreover, the principle of the identity of octaves can now operate in a contrary direction and transfer this positive harmonic value of the 5th to the 12th, so that we regard the 12th as a 5th plus an octave, instead of regarding the 5th as a compressed 12th.¹ At the same time, the relation between the two is quite close enough to give the 5th much of the feeling of harmonic poverty and reduplication that characterizes the octave; and hence when medieval musicians

Ex. 1.—The notes marked * are out of tune.



partial of another note sung at the same time by another voice, the higher voice adds nothing new to the lower but only reinforces what is already there. Moreover, the upper partials of the

¹ Musical intervals are reckoned numerically upwards along the degrees of the diatonic scales (described below). Intervals greater than an octave are called *compound*, and are referred to their simple forms, e.g. the 12th is a compound 5th.

doubled a melody in 5ths and octaves they believed themselves to be doing no more than extending and diversifying the means by which a melody might be sung in unison by different voices. How they came to prefer for this purpose the 4th to the 5th seems puzzling when we consider that the 4th does not appear as a fundamental interval in the harmonic series until that series has passed beyond that part of it that maintains any relation to our musical ideas. But it was of course certain that they obtained the 4th as the inversion of the 5th; and it is at least possible that the singers of lower voices found a peculiar pleasure in singing below higher voices in a position which they felt harmonically as that of a top part. That is to say, a bass, in singing a fourth below a tenor, would take pleasure in doubling in the octave an alto singing normally a 5th above the tenor.¹ This should also, perhaps, be taken in connexion with the fact that the interval of the downward 4th is in melody the earliest that became settled. And it is worth noticing that, in any singing-class where polyphonic music is sung, there is a marked tendency among the more timid members to find their way into their part by a gentle humming which is generally a 4th below the nearest steady singers.

The limited compass of voices soon caused modifications in the medieval parallelisms of 4ths and 5ths, and the introduction of independent ornaments into one or more of the voices increased to an extent which drew attention to other intervals. It was long, however, before the true criterion of concord and discord was attained; and at first the notion of concord was purely acoustic, that is to say, the ear was sensitive only to the difference in roughness and smoothness between combinations in themselves. And even the modern researches of Helmholtz fail to represent classical and modern harmony, in so far as the phenomena of beats are quite independent of the contrapuntal nature of concord and discord which depends upon the melodic intelligibility of the motion of the parts. Beats give rise to a strong physical sense of discord akin to the painfulness of a flickering light (see SOUND). Accordingly, in the earliest experiments in harmony, the ear, in the absence of other criteria, attached much more importance to the purely acoustic roughness of beats than our ears under the experience of modern music. This, and the circumstance that the *imperfect* concords² (the 3rds and 6ths) long remained out of tune owing to the incompleteness of the Pythagorean system of harmonic ratios, sufficiently explain the medieval treatment of these combinations as discords differing only in degree from the harshness of 2nds and 7ths. In the earliest attempts at really contrapuntal writing (the astonishing 13th- and 14th-century motets, in which voices are made to sing different melodies at once, with what seems to modern ears a total disregard of sound and sense) we find that the method consists in a kind of rough-hewing by which the concords of the octave, 5th and 4th are provided at most of the strong accents, while the rest of the harmony is left to take care of itself. As the art advanced the imperfect concords began to be felt as different from the discords; but as their true nature appeared it brought with it such an increased sense of the harmonic poverty of octaves, 5ths and 4ths, as ended in a complete inversion of the earliest rules of harmony.

The harmonic system of the later 15th century, which culminated in the "golden age" of the 16th-century polyphony, may be described as follows: Imagine a flux of simultaneous independent melodies, so ordered as to form an artistic texture based not only on the variety of the melodies themselves, but also upon gradations between points of repose and points in which the roughness of sound is rendered interesting and beautiful by means of the clearness with which the melodic sense in each part indicates the convergence of all towards the next point of repose. The typical point of repose owes its effect not only to the acoustic smoothness of the combination, but to the fact that it actually

¹ It is at least probable that this is one of the several rather obscure reasons for the peculiar instability of the 4th in modern harmony, which is not yet satisfactorily explained.

² The perfect concords are the octave, unison, 5th and 4th. Other diatonic combinations, whether concords or discords, are called imperfect.

consists of the essential elements present in the first five notes of the harmonic series. The major 3rd has thus in this scheme asserted itself as a concord, and the fundamental principle of the identity of octaves produces the result that any combination of a bass note with a major 3rd and a perfect 5th above it, at any distance, and with any amount of doubling, may constitute a concord available even as the final point of repose in the whole composition.

And by degrees the *major triad*, with its major 3rd, became so familiar that a chord consisting of a bare 5th, with or without an octave, was regarded rather as a skeleton triad without the 3rd than as a concord free from elements of imperfection. Again, the identity of the octave secured for the combination of a note with its minor 3rd and minor 6th a place among concords; because, whether so recognized by early theorists or not, it was certainly felt as an inversion of the major triad. The fact that its bass note is not the fundamental note (and therefore has a series of upper partials not compatible with the higher notes) deprives it of the finality and perfection of the major triad, to which, however, its relationship is too near for it to be felt otherwise than as a concord. This sufficiently explains why the minor 6th ranks as a concord in music, though it is acoustically nearly as rough as the discord of the minor 7th, and considerably rougher than that of the 7th note of the harmonic series, which has not become accepted in our musical system at all.

But the major triad and its inversion are not the only concords that will be produced by our flux of melodies. From time to time this flux will arrest attention by producing a combination which, while it does not appeal to the ear as being a part of the harmonic chord of nature, yet contains in itself no elements not already present in the major triad. Theorists have in vain tried to find in "nature" a combination of a note with its minor 3rd and perfect 5th; and so long as harmony was treated unhistorically and unscientifically as an *a priori* theory in which every chord must needs have a "root," the minor triad, together with nearly every other harmonic principle of any complexity, remained a mystery. But the minor triad, as an artistic and not purely acoustic phenomenon, is an inevitable thing. It has the character of a concord because of our intellectual perception that it contains the same elements as the major triad; but its absence of connexion with the natural harmonic series deprives it of complete finality in the simple system of 16th-century harmony, and at the same time gives it a permanent contrast with the major triad; a contrast which is acoustically intensified by the fact that, though its intervals are in themselves as concordant as those of the major triad, their relative position produces decidedly rough combinations of "resultant tones."

By the time our flux of melodies had come to include the major and minor triads as concords, the notion of the independence of parts had become of such paramount importance as totally to revolutionize the medieval conception of the perfect concords. Fifths and octaves no longer formed an oasis in a desert of cacophony, but they assumed the character of concord so nearly approaching to unison that a pair of consecutive 5ths or octaves began to be increasingly felt as violating the independence of the parts. And thus it came about that in pure 16th-century counterpoint (as indeed at the present day whenever harmony and counterpoint are employed in their purest significance) consecutive 5ths and octaves are strictly forbidden. When we compare our laws of counterpoint with those of medieval discant (in which consecutive 5ths and octaves are the rule, while consecutive 3rds and 6ths are strictly forbidden) we are sometimes tempted to think that the very nature of the human ear has changed. But it is now generally recognized that the process was throughout natural and inevitable, and the above account aims at showing that consecutive 5ths are forbidden by our harmonic system for the very reason which inculcated them in the system of the 12th century.

II. *Tenacity*.—As soon as the major and minor triad and their first inversions were well-defined entities, it became evident that

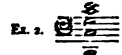

the successions of these concords and their alternations with discord involved principles at once larger and more subtle than those of mere difference in smoothness and artificiality. Not only was a major chord (or at least its skeleton) necessary for the final point of repose in a composition, but it could not itself sound final unless the concords as well as the discords before it showed a well-defined tendency towards it. This tendency was best realized when the penultimate concord had its fundamental note at the distance of a 5th or a 4th above or below that of the final chord. When the fundamental note of the penultimate chord is a 5th above or (what is the same thing) a 4th below that of the final chord, we have an "authentic" or "perfect" cadence, and the relation between the two chords is very clear. While the contrast between them is well marked, they have one note in common—for the root of the penultimate chord is the 5th of the final chord; and the statement of this common note, first as an octave or unison and then as a 5th, expresses the first facts of harmony with a force which the major 3rds of the chords can only strengthen, while it also involves in the bass that melodic interval of the 4th or the 5th which is now known

to be the germ of all melodic scales. The relation of the final note of a scale with its upper 5th or lower 4th thus becomes a fundamental fact of complex harmonic significance—that is to say, of harmony modified by melody in so far as it concerns the succession of sounds as well as their simultaneous combination. In our modern key-system the final note of the scale is called the *tonic*, and the 5th above or 4th below it is the *dominant*. (In the 16th century the term "dominant" has this meaning only in the "authentic" modes other than the Phrygian, but as an aesthetic fact it is present in all music, though the theory here given would not have been intelligible to any composers before the 18th century). Another penultimate chord asserts itself as the converse of the dominant—namely, the chord of which the root is a 5th below or a 4th above the final. This chord has not that relationship to the final which the dominant chord shows, for its fundamental note is not in the harmonic series of the final. But the fundamental note of the final chord is in its harmonic series, and in fact stands to it as the dominant stands to the final. Thus the progression from *subdominant*, as it is called, to tonic, or final, forms a full close known as the "plagal cadence," second only in importance to the "perfect" or "authentic cadence."

In our modern key-system these three chords, the tonic, the dominant and the subdominant, form a firm harmonic centre in reference to which all other chords are grouped. The tonic is the final in which everything ultimately resolves: the dominant stands on one side of it as a chord based on the note harmonically most closely related to the tonic, and the subdominant stands on the other side as the converse and opposite of the dominant, weaker than the dominant because not directly derived from the tonic. The other triads obtainable from the notes of the scale are all minor, and of less importance, and their relationship to each other and to the tonic is most definite when they are so grouped that their basses rise and fall in 4th and 5ths, because they then tend to imitate the relationship between tonic, dominant and subdominant.

Ex. 6

Tonic. Supertonic. Mediant. Subdominant. Dominant. Submediant.

Here are the six common chords of the diatonic scale. The triad on the 7th degree or "leading-note" (B) is a discord, and is therefore not given here.

Now, in the 16th century it was neither necessary nor desirable that chords should be grouped exclusively in this way. The relation between tonic, dominant and subdominant must necessarily appear at the final close, and in a lesser degree at

¹ The submediant is so-called because if the subdominant is taken a 5th below the tonic, the submediant will come midway between it and the tonic, as the mediant comes midway between tonic and dominant.

subordinate points of repose; but, where no harmonies were dwelt on as stable and independent entities except the major and minor triads and their first inversions, a scheme in which these were confined to the illustration of their most elementary relationship would be intolerably monotonous. It is therefore neither surprising nor a sign of archaism that the tonality of modal music is from the modern point of view often very indefinite. On the contrary, the distinction between masterpieces and inferior works in the 16th century is nowhere more evident than in the expressive power of modal tonality, alike where it resembles and where it differs from modern. Nor is it too much to say that that expressive power is based on the modern sense of key, and that a description of modal tonality in terms of modern key will accurately represent the harmonic art of Palestrina and the other supreme masters, though it will have almost as little in common with 16th-century theory and inferior 16th-century practice as it has with modern custom. We must conceive modal harmony and tonality as a scheme in which voices move independently and melodiously in a scale capable of bearing the three chords of the tonic, dominant and subdominant, besides three other minor triads, but not under such restrictions of symmetrical rhythm and melodic design as will necessitate a confinement to schemes in which these three cardinal chords occupy a central position. The only stipulation is that the relationship of at least two cardinal chords shall appear at every full close. At other points the character and drift of the harmony is determined by quite a different principle—namely, that, the scale being conceived as indefinitely extended, the voices are agreed in selecting a particular section of it, the position of which determines not only the melodic character of each part but also the harmonic character of the whole, according to its greater or less remoteness from the scale in which major cardinal chords occupy a central position. Historically these modes were derived, with various errors and changes, from the purely melodic modes of the Greeks. Aesthetically they are systems of modern tonality adapted to conditions in which the range of harmony was the smallest possible, and the necessity for what we may conveniently call a clear and solid key-perspective incomparably slighter than that for variety within so narrow a range. We may thus regard modal harmony as an essentially modern scheme, presented to us in cross-sections of various degrees of obliquity, and modified at every close so as either to take us to a point of view in which we see the harmony symmetrically (as in those modes of which the final chord is normally major, namely the Ionian, which is practically our major scale, the Mixolydian and the Lydian, which last is almost invariably turned into Ionian by the systematic flattening of its 4th degree) or else to transform the mode itself so that its own notes are flattened and sharpened into suitable final chords (as is necessary in those modes of which the triad on the final is normally minor, namely, the Dorian, Phrygian and Aeolian). In this way we may describe Mixolydian tonality as a harmonic scheme in which the keys of G major and C major are so combined that sometimes we feel that we are listening to harmony in C major that is disposed to overbalance towards the dominant, and sometimes that we are in G major with a pronounced leaning towards the subdominant. In the Dorian mode our sensations of tonality are more confused. We seem to be wandering through all the key-relationships of a minor tonic without defining anything, until at the final close the harmonies gather strength and bring us, perhaps with poetic surprise, to a close in D with a major chord. In the Phrygian mode the difficulty in forming the final close is such that classical Phrygian compositions actually end in what we feel to be a half-close, an impression which is by the great masters rendered perfectly artistic by the strong feeling that all such parts of the composition as do not owe their expression to the variety and inconstancy of their harmonic drift are on the dominant of A minor.

It cannot be too strongly insisted that the expression of modal music is a permanent artistic fact. Its refinements may be crowded out by the later tonality, in which the much greater

² See PLAIN SONG.

variety of fixed chords needs a much more rigid harmonic scheme to control it, but they can never be falsified. And when Beethoven in his last "Bagatelle" raises the 6th of a minor scale for the pleasure he takes in an unexpectedly bright major chord; or when, in the *Incarminatus* of his *Mass in D*, he makes a free use of the Dorian scale, he is actuated by precisely the same harmonic and aesthetic motives as those of the wonderful opening of Palestrina's eight-part *Stabat Mater*; just as in the Lydian figured chorale in his *A minor Quartet* he carries out the principle of harmonic variety, as producible by an oblique melodic scale, with a thoroughness from which Palestrina himself would have shrunk. (We have noted that in 16th-century music the Lydian mode is almost invariably Ionized.)

III. *Modern Harmony and Tonality*.—In the harmonic system of Palestrina only two kinds of discord are possible, namely, *suspensions* and *passing-notes*.

Ex. 7.
Suspension.



No. 8.
Passing Note.



The principle of the suspension is that while parts are moving from one concord to another one of the parts remains behind, so as to create a discord at the moment when the other parts proceed. The suspended part then goes on to its concordant note, which must lie on an adjacent (and in most cases a lower) degree of the scale. Passing-notes are produced transiently by the motion of a part up or down the scale while other parts remain stationary. The possibilities of these two devices can be worked out logically so as to produce combinations of extreme harshness. And, when combined with the rules which laid on the performers the responsibility for modifying the strict scale of the mode in order to form satisfactory closes and avoid melodic harshness, they sometimes gave rise to combinations which the clearest artistic intellects of the 16th century perceived as incompatible with the modal style. For example, in a passage written thus



is a substitute for and not an addition to the plain statement. It is not surprising that the sudden opening up of the whole possibilities of modern harmony at the end of the 16th century at first produced a chaos of style.

Another feature of the harmonic revolution arose from the new habit of supporting a single voice on chords played by an instrument. This, together with the use of discords in a new sense, drew attention to the chords as things in themselves and not as moments of greater or less repose in a flux of independent melodies. This was as valuable an addition to musical thought and expression as the free use of abstract terms in literature, but it had precisely the same dangers, and has until recent times vitiated harmonic theory and divorced it from the modest observation of the practice of great masters. When, early in the 18th century, Rameau devoted much of his best energy to the elaboration of a theory of harmony, his field of observation was a series of experiments begun in chaos and resolved, not as yet in a great art, but in a system of conventions, for the contemporary art of Bach and Handel was beyond the scope of contemporary theory. He showed great analytical genius and sense of tonality in his development of the notion of the "fundamental bass," and it is rather to his credit than otherwise that he did not emphasize the distinction between discords on the dominant and those on other degrees of the scale. But his system, with all subsequent improvements, refutations and repairs only led to that bane of 19th-century theory and source of what may be called the journalism of harmonic style, according to which every chord (no matter how obviously artificial and transient) must be regarded, so to speak, as a literal fact for which a root and a scientific connexion with the natural harmonic series must at all cost be found. Some modern theorists have, however, gone too far in denying the existence of harmonic roots altogether, and certainly it is neither scientific nor artistic to regard the coincidence of the major triad with the first five notes of the harmonic series as merely accidental. It is not likely that the dominant 7th owes all its naturalness to a resemblance to the flat 7th of the harmonic series, which is too far out of tune even to pass for an augmented 6th. But the dominant major 9th certainly gains in sonorousness from its coincidence with the 9th harmonic, and many cases in music could be found where the dominant 7th itself would gain from being so far flattened as to add coincidence with a natural harmonic to its musical significance as an unprepared discord (see, for example the "native wood-notes wild" of the distant huntsmen in the second act of *Tristan und Isolde*, where also the 9th and 11th are involved, and, moreover, on horns, of which the natural scale is the harmonic series itself). If the distinction between "essential" and "unessential" discords is, in the light of history and common sense, a difference only in degree, it is thus none the less of great aesthetic importance. Arithmetic and acoustics show that in proportion as musical harmony emphasizes combinations belonging to the lower region of the harmonic series the effect will be sonorous and natural, but common sense, history and aesthetics also show that the interaction of melody, harmony and rhythm must produce a host of combinations which acoustics alone cannot possibly explain. These facts are amply competent to explain themselves. To describe them in detail is beyond the scope of the present article, but a few examples from different periods are given at the end in musical type.

IV. *The Minor Mode*.—When the predecessors of Bach and Handel had succeeded in establishing a key-system able to bear the weight of free discord, that key-system took two forms, in both of which the three chords of tonic, dominant and subdominant occupied cardinal points. In the one form the tonic chord was natural, that is to say, major. In the other form the tonic chord was artificial, that is to say, minor. In the minor mode so firm is the position of the tonic and dominant (the dominant chord always being major) that it is no longer necessary, as in the 16th century, to conclude with a major chord, although it long remained a frequent practice, rather because of the inherent beauty and surprise of the effect than because of any

mere survival of ancient customs, at least where great masters are concerned. (This final major chord is known as the *Tiersce de Picardie*.) The effect of the minor mode is thus normally plaintive because it centres round the artificial concord instead of the natural; and, though the keynote bears this minor artificial triad, the ear nevertheless has an expectation (which may be intensified into a powerful emotional effect) that the final conclusion of the harmonic scheme may brighten out into the more sonorous harmonic system of major chords. Let us once more recall those ecclesiastical modes of which the 3rd degree is normally minor. We have seen how they may be regarded as the more oblique of the various cross-sections of the 16th-century harmonic scheme. Now, the modern minor mode is too firmly rooted in its minor tonic chord for the 16th-century feeling of an oblique harmonic scheme to be of more than secondary importance, though that feeling survives, as the discussion of key-relationships will show us. But it is constantly thrust into the background by the new possibility that the minor tonic chord with its attendant minor harmonies may give place to the major system round the same tonic, and by the certainty that if any change is made at the conclusion of the work it will be upon the same tonic and not have reference to some other harmonic centre. In other words, a major and minor key on the same tonic are felt as identical in everything but expression (a point in which the Tonic Sol Fa system, as hitherto practised, with its identification of the minor key with its "relative" instead of its tonic major, shows a most unfortunate confusion of thought). The characteristics of the major and minor modes may of course be modified by many artistic considerations, and it would be as absurd to develop this account into a scheme of pigeon-holed passions as to do the same for the equally obvious and closely parallel fact that in drama a constant source of pathos is the placing of our sympathies in an oblique relation to the natural sequence of events or to the more universal issues of the subject.

V. *Key-Relationships*.—On the modern sense of the identity of the tonic in major and minor rests the whole distinctive character of modern harmony, and the whole key-system of the classical composers. The masters of the 16th century naturally found it necessary to make full closes much more frequently than would be desirable if the only possible close was that on the final of the mode. They therefore formed closes on other notes, but they formed them on these exactly as on a final. Thus, a close on the second degree of the Ionian mode was identical with a Dorian final close. The notes, other than the final, on which closes could be made were called *modulations*. And what between the three "regular modulations" (known as the dominant, mediant, and participant) and the "conceded modulations," of which two were generally admitted in each mode simply in the interests of variety, a composer was at liberty to form a full close on any note which did not involve too many extraneous sharps or flats for its correct accomplishment. But there was a great difference between modal and modern conceptions of modulation. We have said that the close on the second degree of the Ionian mode was Dorian, but such a modulation was not regarded as a visit paid to the Dorian mode, but merely as the formation of a momentary point of repose on the second degree of the Ionian mode. When therefore it is said that the modulations of 16th-century music are "purposeless and shifting," the criticism implies a purpose in change of key which is wholly irrelevant. The modal composers' purpose lay in purely local relationships of harmony, in various degrees of refinement which are often crowded out of the larger and more coarse-grained scheme of modern harmony, but which modern harmony is perfectly capable of employing in precisely the same sense whenever it has leisure.

Modulation, in the modern sense of the term, is a different thing. The modern sense of tonality is so firm, and modern designs so large, that it is desirable that different portions of a composition should be arranged round different harmonic centres or keys, and moreover that the relation between these keys and the primary key should be felt, and the whole design

should at last return to the primary key, to remain there with such emphasis and proportion as shall leave upon the mind the impression that the whole is in the primary key and that the foreign keys have been as artistically grouped around it as its own local harmonies. The true principles on which keys are related proved so elastic in the hands of Beethoven that their results utterly outstripped the earlier theory which adhered desperately to the limitations of the 16th century; and so vast is the range of key which Beethoven is able to organize in a convincing scheme of relationship, that even modern theory, dazzled by the true harmonic possibilities, is apt to come to the conclusion, more lame and impotent than any ancient pedantry, that all keys are equally related. A vague conception, dubbed "the unity of the chromatic scale," is thus made to explain away the whole beauty and power of Wagner's no less than Beethoven's harmonic system. We have not space to dispute the matter here, and it must suffice to state dogmatically and statistically the classical facts of key-relationship, including those which Beethoven established as normal possibilities on the suggestion of Haydn, in whose works they appear as special effects.

a. *Direct Relationships*.—The first principle on which two keys are considered to be related is a strengthening of that which determined the so-called modulations of the 16th-century modes. Two keys are directly related when the tonic chord of the one is among the common chords of the other. Thus, D minor is related to C major because the tonic chord of D minor is the common chord on the supertonic of C (see Ex. 6). In the same way the four other related keys to C major are E minor the mediant, F major the subdominant, G major the dominant and A minor the submediant.

This last key-relationship is sometimes called the "relative" minor, partly because it is usually expressed by the same key-signature as the tonic, but probably more justifiably because it is the point of view from which to reckon the key-relationships of the minor tonic. If we take the minor scale in its "harmonic" form (*i.e.* the form deducible from its chords of minor tonic, minor subdominant and major dominant, without regard to the exigencies of melody in concession to which the "melodic" minor scale raises the 6th in ascent and flattens the 7th in descent), we shall find it impossible to build a common chord upon its mediant (Ex. 10). But we have seen that A minor is related to C major; Ex. 10.  therefore it is absurd to suppose that C major is not related to A minor. Clearly then we must deduce some of the relationships of a minor tonic as the converse of those of a major tonic. Thus we may read Ex. 6 backwards and reason as follows: A minor is the submediant of C major; therefore C major is the mediant or relative major of A minor. D minor is the supertonic of C major; therefore C major is related to D minor and may be called its flat 7th. Taking A minor as our standard key, G major is then the flat 7th to A minor. The remaining major keys (C major to E minor = F major to A minor) may be traced directly as well as conversely; and the subdominant, being minor, does not involve an appeal to the major scale at all. But with the dominant we find the curious fact that while the dominant *chord* of a minor key is major it is impossible to regard the major dominant *key* as directly related to the minor tonic, since it does not contain the minor tonic chord at all; *e.g.* the only chord of A in E major is A major. But the dominant minor key contains the tonic chord of the primary minor key clearly enough as subdominant, and therefore when we modulate from a minor tonic to a minor dominant we feel that we have a direct key-relationship and have not lost touch with our tonic. Thus in the minor mode modulation to the dominant key is, though frequent and necessary, a much more uphill process than in the major mode, because the naturally major dominant chord has first to be contradicted. On the other hand, a contrast between minor tonic and major dominant key is very difficult to work on a large scale (as, for example, in the complementary key for second subjects of sonata movements) because, while the major dominant key behaves as if not directly

related to the minor tonic, it also gives a curious sensation of being merely *as* the dominant instead of *is* it; and thus we find that in the few classical examples of a dominant major second subject in a minor sonata-movement the second subject either relapses into the dominant minor, as in Beethoven's *Kreutzer Sonata* and the finale of Brahms's *Third Symphony*, or begins in it, as in the first movement of Brahms's *Fourth Symphony*.

The effect of a modulation to a related key obviously depends upon the change of meaning in the chords common to both keys, and also in the new chords introduced. Thus, in modulating to the dominant we invest the brightest chord of our first key with the finality and importance of a tonic; our original tonic chord becomes comparatively soft in its new position as subdominant; and a new dominant chord arises, surpassing in brilliance the old dominant (now tonic) as that surpassed the primary tonic. Again, in modulating to the subdominant the softest chord of the primary key becomes tonic, the old tonic is comparatively bright, and a new and softer subdominant chord appears. We have seen the peculiarities of modulation to the dominant from a minor tonic, and it follows from them that modulation from a minor tonic to the subdominant involves the beautiful effect of a momentary conversion of the primary tonic chord to major, the poetic and often dramatically ironical power of which is manifested at the conclusion of more than half the finest classical slow movements in minor keys, from Bach's *E♭* minor Prelude in the first book of the *Forty-eight* to the slow movement of Brahms's *G* major *String Quintet*, *Op.* 111.

The effect of the remaining key-relationships involves contrasts between major and minor mode; but it is otherwise far less defined, since the primary tonic chord does not occupy a cardinal position in the second key. These key-relationships are most important from a minor tonic, as the change from minor to major is more vivid than the reverse change. The smoothest changes are those to "relative" minor, "relative" major (C to A minor; C minor to E♭); and mediant minor and submediant major (C to E minor; C minor to A♭). The change from major tonic to supertonic minor is extremely natural on a small scale, i.e. within the compass of a single melody, as may be seen in countless openings of classical sonatas. But on a large scale the identity of primary dominant with secondary subdominant confuses the harmonic perspective, and accordingly in classical music the supertonic minor appears neither in the second subjects of first movements nor as the key for middle movements.¹ But since the key-relationships of a minor tonic are at once more obscure harmonically and more vivid in contrast, we find that the converse key-relationship of the flat 7th, though somewhat bold and archaic in effect on a small scale, has once or twice been given organic function on a large scale in classical movements of exceptionally fantastic character, of which the three great examples are the ghostly slow movement of Beethoven's *D* major *Trio*, *Op.* 70, No. 1, the scherzo of his *Ninth Symphony*, and the finale of Brahms's *D* minor *Violin Sonata* (where, however, the C major theme soon passes permanently into the more orthodox dominant minor).

Thus far we have the set of key-relationships universally recognized since the major and minor modes were established, a relationship based entirely on the place of the primary tonic chord in the second key. It only remains for us to protest against the orthodox description of the five related keys as being the "relative" minor or major and the dominant and subdominant with their "relative" minors or majors; a conception which expresses the fallacious assumption that keys which are related to the same key are related to one another, and which thereby implies that all keys are equally related and that classical composers were fools. It cannot be too strongly insisted that there is no foundation for key-relationship except through a tonic, and that it is through the tonic that the most distant keys

have always been connected by every composer with a wide range of modulation, from Haydn to Brahms and (with due allowance for the conditions of his musical drama) Wagner.

b. Indirect Relationships.—So strong is the identity of the tonic in major and minor mode that Haydn and Mozart had no scruple in annexing, with certain reservations, the key-relationships of either as an addition to those of the other. The smoothness of Mozart's style makes him prefer to annex the key-relationships of the tonic minor (e.g. C major to A♭, the submediant of C minor), because the primary tonic note is in the second key, although its chord is transformed. His range of thought does not allow him to use these keys otherwise than episodically; but he certainly does not treat them as chaotically remote by confining them to rapid modulations in the development-portions of his movements. They occur characteristically as beautiful purple patches before or during his second subjects. Haydn, with his mastery of rational paradox, takes every opportunity, in his later works, of using all possible indirect key-relationships in the choice of key for slow movements and for the trios of minuetts. By using them thus sectionally (i.e. so as not to involve the organic connecting links necessary for the complementary keys of second subjects) he gives himself a free hand; and he rather prefers those keys which are obtained by transforming the minor relationships of a major primary key (e.g. C to A major instead of A minor). These relationships are of great brilliance and also of some remoteness of effect, since the primary tonic note, as well as its chord, disappears entirely. Haydn also obtains extreme contrasts by changing both modes (e.g. C minor to A major, as in the *G* minor *Quartet*, *Op.* 73, No. 6, where the slow movement is in E major), and indeed there is not one key-contrast known to Beethoven and Brahms which Haydn does not use with complete sense of its meaning, though his art admits it only as a surprise.

Beethoven rationalized every step in the whole possible range of key-relationship by such harmonic means as are described in the article *BEETHOVEN*. Haydn's favourite key-relationships he used for the complementary key in first movements; and he at once discovered that the use of the major mediant as complementary key to a major tonic implied at all events just as much suggestion of the submediant major in the recapitulation as would not keep the latter half of the movement for too long out of the tonic. The converse is not the case, and where Beethoven uses the submediant major as complementary key in a major first movement he does not subsequently introduce the still more remote and brilliant mediant in the recapitulation. The function of the complementary key is that of contrast and vividness, so that if the key is to be remote it is as well that it should be brilliant rather than sombre; and accordingly the easier key-relationships obtainable through transforming the tonic into minor do not appear as complementary keys until Beethoven's latest and most subtle works, as the *Quartet in B♭*, *Op.* 130 (where we again note that the flat submediant of the exposition is temporarily answered by the flat mediant of the recapitulation).

c. Artificial Key-relationships.—Early in the history of the minor mode it was discovered that the lower tetrachord could be very effectively and naturally altered so as to resemble the upper (thus producing the scale C D♭ E♭ F, G A♭ B♭ C). This produces a flat supertonic (the chord of which is generally presented in its first inversion, and is known as the Neapolitan 6th, from its characteristic use in the works of the Neapolitan school which did so much to establish modern tonality) and its origin, as just described, often impels it to resolve on a major tonic chord. Consequently it exists in the minor mode as a phenomenon not much more artificial than the mode itself; and although the keys it thus connects are extremely remote, and the effect of their connexion very surprising, the connexion is none the less real, whether from a major or a minor tonic, and is a crucial test of a composer's sense of key-perspective. Thus Philipp Emanuel Bach in a spirit of mere caprice puts the charming little slow movement of his *D* major *Symphony* into E♭ and obliterates all real relationship by chaotic operatic

¹ Until Beethoven developed the resources for a wider scheme of key-contrasts, the only keys for second subjects of sonata-movements were the dominant (when the tonic was major) and the "relative" major or dominant minor (when the tonic was minor). A wider range was possible only in the irresponsible style of D. Scarlatti.

connecting links. Haydn's greatest pianoforte sonata (which, being probably his last, is of course No. 1 in most editions) is in E \flat , and its slow movement is in F \sharp major (=F \flat). That key had already appeared, with surprising effect, in the wanderings of the development of the first movement. No attempt is made to indicate its connexion with E \flat ; and the finale begins in E \flat , but its first bar is unharmonized and starts on the one note which most contradicts E \sharp and least prepares the mind for E \flat . The immediate repetition of the opening phrase a step higher on the normal supertonic strikes the note which the opening had contradicted, and thus shows its function in the main key without in the least degree explaining away the paradoxical effect of the key of the slow movement. Brahms's *Violoncello Sonata Op. 99*, is in F; a prominent episode in the development of the first movement is in E \sharp minor (=G \flat), thus preparing the mind for the slow movement, which is in F \sharp major (=G \flat), with a central episode in F minor. The scherzo is in F minor, and begins on the dominant. Thus if we play its first chord immediately after the last chord of the slow movement we have exactly that extreme position of flat supertonic followed by dominant which is a favourite form of cadence in Wagner, who can even convey its meaning by its mere bass without any harmonies (*Walküre*, Act 3, Scene 2: "Was jetzt du bist, das sage dir selbst").

Converse harmonic relationships are, as we have seen, always weaker than their direct forms. And thus the relation of C major to B major or minor (as shown in the central episode of the slow movement just mentioned) is rare. Still more rare is the obtaining of indirect artificial relationships, of which the episode in the first movement just mentioned is an illustration in so far as it enhances the effect of the slow movement, but is inconclusive in so far as it is episodic. For with remote key-relationships everything depends upon whether they are used with what may be called cardinal function (like complementary keys) or not. Even a near key may occur in the course of wandering modulations without producing any effect of relationship at all, and this should always be borne in mind whenever we accumulate statistics from classical music.

d. Contrary and Unconnected Keys.—There remain only two pairs of keys that classical music has not brought into connexion, a circumstance which has co-operated with the utter vagueness of orthodox theories on the subject to confirm the conventionally progressive critic in his conviction that all modulations are alike. We have seen how the effect of modulation from major tonic to minor supertonic is, on a large scale, obscured by the identity of the primary dominant with the secondary subdominant, though the one chord is major and the other minor. Now when the supertonic becomes major this difference no longer obviates the confusion, and modulation from C major to D major, though extremely easy, is of so bewildering effect that it is used by classical composers only in moments of intensely dramatic surprise, as, for example, in the recapitulation of the first subject of Beethoven's *Eroica Symphony*, and the last variation (or coda) of the slow movement of his *Trio in B \flat* , Op. 97. And in both cases the balance is restored by the converse (and equally if not more contradictory) modulation between major tonic and major flat 7th, though in the slow movement of the *B \flat Trio* the latter is represented only by its dominant chord which is "enharmonically" resolved into quite another key. The frequent attempts made by easy-going innovators to treat these key-contrasts on another footing than that of paradox, dramatic surprise or hesitation, only show a deficient sense of tonality, which must also mean an inability to see the intensely powerful effect of the true use of such modulations in classical music, an effect which is entirely independent of any ability to formulate a theory to explain it.¹

¹ Many theorists mistake the usual extreme emphasis on the dominant chord of the dominant key, in preparation for second subjects, for a modulation to the major supertonic, but this can deceive no one with any sense of tonality. A good practical test is to see what becomes of such passages when translated into the minor mode. Illusory modulation to the flat 7th frequently occurs as a bold method of throwing strong emphasis on to the subdominant at the outset of a movement, as in Beethoven's *Sonata*, Op. 31, No. 1.

There now remains only one pair of keys that have never been related, namely, those that (whether major or minor) are at the distance of a tritone 4th. In the first place they are unrelated because there is no means of putting any form of a tonic chord of F \sharp into any form of the key of C, or vice versa; and in the second place because it is impossible to tell which of two precisely opposite keys the second key may be (e.g. we have no means of knowing that a direct modulation from C to F \sharp is not from C to G \flat , which is exactly the same distance in the opposite direction). And this brings us to the only remaining subjects of importance in the science and art of harmony, namely, those of the tempered scale, enharmonic ambiguity and just intonation. Before proceeding we subjoin a table of all the key-relationships from major and minor tonics, representing the degrees by capital Roman figures when the second key is major and small figures when the second key is minor and small figures

TABLES OF KEY-RELATIONSHIPS

		A. From Major Tonic					
		Direct Relationships	III	III	IV	V	vii
		Indirect through both I and the second key			iv	v	
Indirect, through I	III ^b VII ^b	Indirect through the second key		III			V
Doubly indirect through the former indirect keys	III ^b vii ^b						
Artificial, direct	II ^b					VII & vii	
Artificial, indirect ²	II ^b						
							IV \sharp & iv \flat = v \flat & v \sharp
Unrelated							
Contradictory						VII \sharp & vii \flat	
		B. From Minor Tonic ³					
		Direct Relationships	III	iv	v	VI	VII
		Indirect through both I and the second key			IV	V	
Indirect, through I	III ^b vii ^b	Indirect through the second key	III				vii
Doubly indirect	III ^b VII ^b						
Artificial, direct	II ^b						
Artificial, indirect ⁴	II ^b					VII \sharp & vii \flat	
							IV \sharp & iv \flat = v \flat & v \sharp
Unrelated							
Contradictory ⁵			II				vii \flat

² Very rare, but the slow movement of Schubert's *C major String Quintet* demonstrates it magnificently.

³ All the indirect relationships from a minor tonic are distinctly strained and, except in the violently contrasted doubly indirect keys, obscure as being themselves minor. But the direct artificial modulation is quite smooth, and rich rather than remote. See Beethoven's *C \sharp minor Quartet*.

⁴ No classical example, though the clearer converse from a major tonic occurs effectively.

⁵ Not (with the exception of II) so violent as when from major tonic. Bach, whose range seldom exceeds direct key-relationships, is not afraid to drift from D minor to C minor, though nothing would induce him to go from D major to C major or minor.

when minor. Thus I represents tonic major, iv represents subdominant minor, and so on. A flat or a sharp after the figure indicates that the normal degree of the standard scale has been lowered or raised a semitone, even when in any particular pair of keys it would not be expressed by a flat or a sharp. Thus *vib* would, from the tonic of B \flat major, express the position of the slow movement of Beethoven's *Sonata, Op. 106*, which is written in F \sharp minor since G \flat minor is beyond the practical limits of notation.

VI. *Temperament and Enharmonic Changes.*—As the facts of artistic harmony increased in complexity and range, the purely acoustic principles which (as Helmholtz has shown) go so far to explain 16th-century aesthetics became more and more inadequate; and grave practical obstacles to euphonious tuning began to assert themselves. The scientific (or natural) ratios of the diatonic scale were not interfered with by art so long as no discords were "fundamental"; but when discords began to assume independence, one and the same note often became assignable on scientific grounds to two slightly different positions in pitch, or at all events to a position incompatible with even tolerable effect in performance. Thus, the chord of the diminished 7th is said to be intolerably harsh in "just intonation," that is to say, intonation based upon the exact ratios of a normal minor scale. In practical performance the diminished 7th contains three minor 3rds and two imperfect 5ths (such as that which is present in the dominant 7th), while the peculiarly dissonant interval from which the chord takes its name is very nearly the same as a major 6th. Now it can only be said that an intonation which makes nonsense of chords of which every classical composer from the time of Corelli has made excellent sense, is a very unjust intonation indeed; and to anybody who realizes the universal relation between art and nature it is obvious that the chord of the diminished 7th must owe its naturalness to its close approximation to the natural ratios of the minor scale, while it owes its artistic possibility to the extremely minute instinctive modification by which its dissonance becomes tolerable. As a matter of fact, although we have shown here and in the article MUSIC how artificial is the origin and nature of all but the very scantiest materials of the musical language, there is no art in which the element of practical compromise is so minute and so hard for any but trained scientific observation to perceive. If a painter could have a scale of light and shade as nearly approaching nature as the practical intonation of music approaches the acoustic facts it really involves, a visit to a picture gallery would be a severe strain on the strongest eyes, as Ruskin constantly points out. Yet music is in this respect exactly on the same footing as other arts. It constitutes no exception to the universal law that artistic ideas must be realized, not in spite of, but by means of practical necessities. However independent the treatment of discords, they assert themselves in the long run as transient. They resolve into permanent points of repose of which the basis is natural; but the transient phenomena float through the harmonic world adapting themselves, as best they can, to their environment, showing as much dependence upon the stable scheme of "just intonation" as a crowd of metaphors and abstractions in language shows a dependence upon the rules of the syllogism. As much and no more, but that is no doubt a great deal. Yet the attempt to determine the point in modern harmony where just intonation should end and the tempered scale begin, is as vexatious as the attempt to define in etymology the point at which the literal meaning of a word gives places to a metaphorical meaning. And it is as unsound scientifically as the conviction of the typical circle-squarer that he is unravelling a mystery and measuring a quantity hitherto unknown. Just intonation is a reality in so far as it emphasizes the contrast between concord and discord; but when it forbids artistic interaction between harmony and melody it is a chimera. It is sometimes said that Bach, by the example of his forty-eight preludes and fugues in all the major and minor keys, first fixed the modern scale. This is true practically, but not aesthetically. By writing a series of movements in every key of which the

keynote was present in the normal organ and harpsichord manuals of his and later times, he enforced the system by which all facts of modern musical harmony are represented on keyed instruments by dividing the octave into twelve equal semitones, instead of tuning a few much-used keys as accurately as possible and sacrificing the euphony of all the rest. This system of *equal temperament*, with twelve equal semitones in the octave, obviously annihilates important distinctions, and in the most used keys it sours the concords and blunts the discords more than unequal temperament; but it is never harsh; and where it does not express harmonic subtleties the ear instinctively supplies the interpretation; as the observing faculty, indeed, always does wherever the resources of art indicate more than they express.

Now it frequently happens that discords or artificial chords are not merely obscure in their intonation, whether ideally or practically, but as produced in practice they are capable of two sharply distinct interpretations. And it is possible for music to take advantage of this and to approach a chord in one significance and quit it with another. Where this happens in just intonation (in so far as that represents a real musical conception) such chords will, so to speak, quiver from one meaning into the other. And even in the tempered scale the ear will interpret the change of meaning as involving a minute difference of intonation. The chord of the diminished 7th has in this way four different meanings—



and the chord of the augmented 6th, when accompanied by the fifth, may become a dominant 7th or vice versa, as in the passage already cited in the coda of the slow movement of Beethoven's *B \flat Trio, Op. 97*. Such modulations are called *enharmonic*. We have seen that all the more complex musical phenomena involve distinctions enharmonic in the sense of intervals smaller than a semitone, as, for instance, whenever the progression D E in the scale of C, which is a minor tone, is identified with the progression of D E in the scale of D, which is a major tone (differing from the former as $\frac{1}{2}$ from $\frac{1}{6}$). But the special musical meaning of the word "enharmonic" is restricted to the difference between such pairs of sharps with flats or naturals as can be represented on a keyboard by the same note, this difference being the most impressive to the ear in "just intonation" and to the imagination in the tempered scale.

Not every progression of chords which is, so to speak, spelt enharmonically is an enharmonic modulation in itself. Thus a modulation from D flat to E major looks violently enharmonic on paper, as in the first movement of Beethoven's *Sonata, Op. 110*. But E major with four sharps is merely the most convenient way of expressing F flat, a key which would need six flats and a double flat. The reality of an enharmonic modulation can be easily tested by transporting the passage a semitone. Thus, the passage just cited, put a semitone lower, becomes a perfectly diatonic modulation from C to E flat. But no transposition of the sixteen bars before the return of the main theme in the scherzo of Beethoven's *Sonata in E \flat , Op. 31, No. 3*, will get rid of the fact that the diminished 7th (G \flat B \flat D \flat E \flat), on the dominant of F minor, must have changed into G \flat B \flat D \flat F \flat (although Beethoven does not take the trouble to alter the spelling) before it could resolve, as it does, upon the dominant of A \flat . But though there is thus a distinction between real and apparent enharmonic modulations, it frequently happens that a series of modulations perfectly diatonic in themselves returns to the original key by a process which can only be called an enharmonic circle. Thus the whole series of keys now in practical use can be arranged in what is called the circle of fifths (C G D A E B F \sharp [=G \flat] D \flat A \flat B \flat F C), from which series we now see the meaning of what was said in the discussion of key-relationships as to the ambiguity of the relationships between keys a tritone fourth apart). Now no human memory is capable of distinguishing the difference of pitch between the

keys of C and B \sharp after a wide series of modulations. The difference would be perceptible enough in immediate juxtaposition, but after some interval of time the memory will certainly accept two keys so near in pitch as identical, whether in "just intonation" or not. And hence the enharmonic circle of fifths is a conception of musical harmony by which infinity is at once rationalized and avoided, just as some modern mathematicians are trying to rationalize the infinity of space by a non-Euclidian space so curved in the fourth dimension as to return upon itself. A similar enharmonic circle progressing in major 3rds is of frequent occurrence and of very rich effect. For example, the keys of the movements of Brahms's *C Minor Symphony* are C minor, E major, A \flat major (= G \sharp), and C (= B \sharp). And the same circle occurs in the opposite direction in the first movement of his *Third Symphony*, where the first subject is in F, the transition passes directly to D \flat and thence by exactly the same step to A (= B $\flat\flat$). The exposition is repeated, which of course means that in "just intonation" the first subject would begin in G $\flat\flat$ and then pass through a transition in E $\flat\flat\flat$ to the second subject in C $\flat\flat\flat$. As the development contains another spurious enharmonic modulation, and the recapitulation repeats in another position the first spurious enharmonic modulation of the exposition, it would follow that Brahms's movement began in F and ended in C sextuple-flat! So much, then, for the application of bad metaphysics and circle-squaring mathematics to the art of music. Neither in mathematics nor in art is an approximation to be confused with an imperfection. Brahms's movement begins and ends in F much more exactly than any wooden diagonal fits a wooden square.

The following series of musical illustrations show the genesis of typical harmonic resources of classical and modern music.

Ex. 12.—Three concords (tonic, first inversion of subdominant, and dominant of A minor, a possible 16th-century cadence in the Phrygian mode).



Ex. 13.—The same chords varied by a suspension (*).



Ex. 14.—Ditto, with the further addition of a double suspension (*) and two passing notes (††).



Ex. 15.—Ditto, with a chromatic alteration of the second chord (*) and an "essential" discord (dominant 7th) at (†).



Ex. 16.—Ditto, with chromatic passing notes (**) and appoggiaturas (††).



Ex. 17.—The last two chords of Ex. 16 attacked unexpectedly, the first appoggiatura (*) prolonged till it seems to make a strange foreign chord before it resolves on the short note at †, while the second appoggiatura (†) is chromatic.

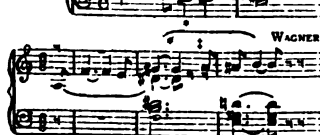

Ex. 18.—The same enharmonically transformed so as to become a variation of the "dominant ninth" of C minor. The G \sharp at * is really A \flat , and † is no longer a note of resolution, but a chromatic passing-note.



Definitions.

(Intended to comprise the general conceptions set forth in the above article.)

1. *Musical sounds, or notes*, are sensations produced by regular periodical vibrations in the air, sufficiently rapid to coalesce in a single continuous sensation, and not too rapid for the mechanism of the human ear to respond.
2. The *pitch* of a note is the sensation corresponding to the degree of rapidity of its vibrations; being *low* or *grave* where these are slow, and *high* or *acute* where they are rapid.
3. An *interval* is the difference in pitch between two notes.
4. *Rhythm* is the organization, in a musical scheme, of sounds in respect of time.
5. *Melody* is the organization, in a musical scheme, of rhythmic notes in respect of pitch.
6. *Harmony* is the organization, in a musical scheme, of simultaneous combinations of notes on principles whereby their acoustic properties interact with laws of rhythm and melody.
7. The *harmonic series* is an infinite series of notes produced by the subdivision of a vibrating body or column of air into aliquot parts, such notes being generally inaudible except in the form of the timbre which their presence in various proportions imparts to the fundamental note produced by the whole vibrating body or air-column.
8. A *concord* is a combination which, both by its acoustic smoothness and by its logical origin and purpose in a musical scheme, can form a point of repose.
9. A *discord* is a combination in which both its logical origin in a musical scheme and its acoustic roughness show that it cannot form a point of repose.
10. The *perfect concords* and *perfect intervals* are those comprised within the first four members of the harmonic series, namely, the octave, as between numbers 1 and 2 of the series (see Ex. 1 above); the 5th, as between Nos. 2 and 3; and the 4th, as between Nos. 3 and 4.
11. All notes exactly one or more octaves apart are regarded as harmonically identical.
12. The *root* of a chord is that note from which the whole or the most important parts of the chord appear (if distributed in the right octaves) as members of the harmonic series.
13. A chord is inverted when its lowest note is not its root.
14. The *major triad* is a concord containing three different notes which (octaves being disregarded) are identical with the first, third and fifth members of the harmonic series (the second and fourth members being negligible as octaves).
15. The *minor triad* is a concord containing the same intervals as the major triad in a different order; in consequence it is artificial, as one of its notes is not derivable from the harmonic series.
16. *Unessential discords* are those that are treated purely as the phenomena of transition, delay or ornament, in an otherwise concordant harmony.
17. *Essential discords* are those which are so treated that the mind tends to regard them as definite chords possessing roots.
18. A *key* is an harmonic system in which there is never any doubt as to which note or triad shall be the final note of music in that system, nor of the relations between that note or chord and the other notes or chords. (In this sense the church modes are either not keys or else they are subtle mixtures of keys.)
19. This final note of a key is called its *tonic*.
20. The *major mode* is that of keys in which the tonic triad and the two other cardinal triads are major.
21. The *minor mode* is that of keys in which the tonic triad and one other cardinal triad are minor.
22. A *diatonic scale* is a series of the notes essential to one major or minor key, arranged in order of pitch and repeating itself in other octaves on reaching the limit of an octave.
23. *Modulation* is the passing from one key to another.
24. *Chromatic notes and chords* are those which do not belong to the diatonic scale of the passage in which they occur, but which are not so used as to cause modulation.
25. *Enharmonic intervals* are minute intervals which never occur in music as directly measured quantities, though they exist as differences between approximately equal ordinary intervals, diatonic or chromatic. In an enharmonic modulation, two chords differing by an enharmonic quantity are treated as identical.
26. *Pedal* or *organ point* is the sustaining of a single note in the bass (or, in the case of an *inverted pedal*, in an upper part) while the harmonies move independently. Unless the harmonies are sometimes foreign to the sustained note, it does not constitute a pedal. In modern music pedals take place on either the tonic or the dominant, other pedal-notes being rare and of complex meaning. Double pedals (of tonic and dominant, with tonic below) are not unusual. The device is capable of very free treatment, and has produced many very bold and rich harmonic effects in music since the earlier works of Beethoven. It probably accounts for many so-called "essential discords."

In the form of *drones* the pedal is the only real harmonic device of ancient and primitive music. The ancient Greeks sometimes

used a reiterated instrumental note as an accompaniment *above* the melody. These primitive devices, though harmonic in the true modern sense of the word, are out of the line of harmonic development, and did not help it in any definite way.

27. The *fundamental bass* of a harmonic passage is an imaginary bass consisting of the roots of the chords.

28. A *figured bass*, or *continuo*, is the bass of a composition supplied with numerals indicating the chords to be filled in by the accompanist. *Thorough-bass* (Ger. *Generalbass*) is the art of interpreting such figures. (D. F. T.)

HARMOTOME, a mineral of the zeolite group, consisting of hydrous barium and aluminium silicate, $H_2BaAl_2(SiO_2)_6 \cdot 5H_2O$. Usually a small amount of potassium is present replacing part

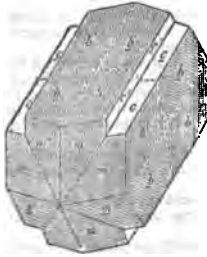

of the barium. The system of crystallization is monoclinic; only complex twinned crystals are known. A common and characteristic form of twinned crystal, such as is represented in the figure, consists of four intercrossing individuals twinned together according to two twin-laws; the compound group resembles a tetragonal crystal with prism and pyramid, but may be distinguished from this by the grooves along the edges of the pseudo-prism. The faces of the crystals are marked by characteristic striations, as indicated in the figure. Twinned crystals of exactly the same kind are also frequent in phillipsite (*q.v.*). Crystals are usually white and translucent, with a vitreous lustre. The hardness is 4½, and the specific gravity 2.5.

The name harmotome (from *ἀρμός*, "a joint," and *τέμνω*, "to cut") was given by R. J. Haüy in 1801, and has a crystallographic signification. Earlier names are cross-stone (Ger. *Kreuzstein*), ercinite, andreasbergolite and andreolite, the two last being derived from the locality, Andreasberg in the Harz. Morvenite (from Morven in Argyllshire) is the name given to small transparent crystals formerly referred to phillipsite.

Like other zeolites, harmotome occurs with calcite in the amygdaloidal cavities of volcanic rocks, for example, in the dolerites of Dumbartonshire, and as fine crystals in the agate-lined cavities in the melaphyre of Oberstein in Germany. It also occurs in gneiss, and sometimes in metalliferous veins. At Andreasberg in the Harz it is found in the lead and silver veins; and at Strontian in Argyllshire in lead veins, associated with brewsterite (a strontium and barium zeolite), barytes and calcite. (L. J. S.)

HARMS, CLAUS (1778-1855), German divine, was born at Fahrstedt in Schleswig-Holstein on the 25th of May 1778, and in his youth worked in his father's mill. At the university of Kiel he repudiated the prevailing rationalism and under the influence of Schleiermacher became a fervent Evangelical preacher, first at Lunden (1806), and then at Kiel (1816). His trenchant style made him very popular, and he did great service for his cause especially in 1817, when, on the 300th anniversary of the Reformation, he published side by side with Luther's theses, ninety-five of his own, attacking reason as "the pope of our time" who "dismisses Christ from the altar and throws God's word from the pulpit." He also had some fame as a hymn-writer, and besides volumes of sermons published a good book on *Pastoraltheologie* (1830). He resigned his pastorate on account of blindness in 1849, and died on the 1st of February 1855.

See *Autobiography* (2nd ed., Kiel, 1852); M. Baumgarten, *Ein Denkmal für C. Harms* (Brunswick, 1855).

HARNACK, ADOLF (1851-), German theologian, was born on the 7th of May 1851 at Dorpat, in Russia, where his father, Theodosius Harnack (1817-1889), held a professorship of pastoral theology.

Theodosius Harnack was a staunch Lutheran and a prolific writer on theological subjects; his chief field of work was practical theology, and his important book on that subject, summing up his long experience and teaching, appeared at

Erlangen (1877-1878, 2 vols.). The liturgy of the Lutheran church of Russia has, since 1898, been based on his *Liturgische Formulare* (1872).

The son pursued his studies at Dorpat (1869-1872) and at Leipzig, where he took his degree; and soon afterwards (1874) began lecturing as a *Privatdozent*. These lectures, which dealt with such special subjects as Gnosticism and the Apocalypse, attracted considerable attention, and in 1876 he was appointed professor extraordinarius. In the same year he began the publication, in conjunction with O. L. von Gebhardt and T. Zahn, of an edition of the works of the Apostolic Fathers, *Patrum apostolicorum opera*, a smaller edition of which appeared in 1877. Three years later he was called to Giessen as professor ordinarius of church history. There he collaborated with Oscar Leopold von Gebhardt in *Texte und Untersuchungen zur Geschichte der altchristlichen Litteratur* (1882 sqq.), an irregular periodical, containing only essays in New Testament and patristic fields. In 1881 he published a work on monasticism, *Das Mönchtum, seine Ideale und seine Geschichte* (5th ed., 1900; English translation, 1901), and became joint-editor with Emil Schürer of the *Theologische Literaturzeitung*. In 1885 he published the first volume of his epoch-making work, *Lehrbuch der Dogmengeschichte* (3rd ed. in three volumes, 1894-1898; English translation in seven volumes, 1894-1899). In this work Harnack traces the rise of dogma, by which he understands the authoritative doctrinal system of the 4th century and its development down to the Reformation. He considers that in its earliest origins Christian faith and the methods of Greek thought were so closely intermingled that much that is not essential to Christianity found its way into the resultant system. Therefore Protestants are not only free, but bound, to criticize it; indeed, for a Protestant Christian, dogma cannot be said to exist. An abridgment of this appeared in 1889 with the title *Grundriss der Dogmengeschichte* (3rd ed., 1898). In 1886 Harnack was called to Marburg; and in 1888, in spite of violent opposition from the conservative section of the church authorities, to Berlin. In 1890 he became a member of the Academy of Sciences. At Berlin, somewhat against his will, he was drawn into a controversy on the Apostles' Creed, in which the party antagonisms within the Prussian Church had found expression. Harnack's view is that the creed contains both too much and too little to be a satisfactory test for candidates for ordination, and he would prefer a briefer symbol which could be rigorously exacted from all (cf. his *Das apostolische Glaubensbekenntnis. Ein geschichtlicher Bericht nebst einem Nachwort*, 1892; 27th ed., 1896). At Berlin Harnack continued his literary labours. In 1893 he published a history of early Christian literature down to Eusebius, *Geschichte der altchristl. Litteratur bis Eusebius* (part 2 of vol. i., 1897); and in 1900 appeared his popular lectures, *Das Wesen des Christentums* (5th ed., 1901; English translation, *What is Christianity?* 1901; 3rd ed., 1904). One of his more recent historical works is *Die Mission und Ausbreitung des Christentums in den ersten drei Jahrhunderten* (1902; English translation in two volumes, 1904-1905). It has been followed by some very interesting and important New Testament studies (*Beiträge zur Einleitung in das neue Testament*, 1906 sqq.; Engl. trans.: *Luke the Physician*, 1907; *The Sayings of Jesus*, 1908). Harnack, both as lecturer and writer, was one of the most prolific and most stimulating of modern critical scholars, and trained up in his "Seminar" a whole generation of teachers, who carried his ideas and methods throughout the whole of Germany and even beyond its borders. His distinctive characteristics are his claim for absolute freedom in the study of church history and the New Testament; his distrust of speculative theology, whether orthodox or liberal; his interest in practical Christianity as a religious life and not a system of theology. Some of his addresses on social matters have been published under the heading "Essays on the Social Gospel" (1907).

HARNESS (from O. Fr. *harnais* or *harnois*; the ultimate origin is obscure; the Celtic origin which connects it with the Welsh *haiarn*, iron, has phonetic and other difficulties; the French is the origin of the Span. *arnes*, and Ger. *Harnisch*), probably, in

origin, gear, tackle, equipment in general, but early applied particularly to the body armour of a soldier, including the trappings of the horse; now the general term for the gear of an animal used for draft purposes, traces, collar, bridle, girth, breeching, &c. It is usually not applied to the saddle or bridle of a riding animal. The word, in its original meaning of tackle or working apparatus, is still found in weaving, for the mechanism which shifts the warp-threads to form the "shed," and in bell-hanging, for the apparatus by which a large bell is hung. The *New English Dictionary* quotes an early use of the word for the lines, rod and hooks of an angler (*Fysshing with an Angle*, c. 1450).

HARO, CLAMEUR DE, the ancient Norman custom of "crying for justice," still surviving in the Channel Islands. The wronged party must on his knees and before witnesses cry: "Harol! Harol! Harol! à l'aide, mon prince, on me fait tort." This appeal has to be respected, and the alleged trespass or tort must cease till the matter has been thrashed out in the courts. The "cry" thus acts as an interim injunction, and no inhabitant of the Channel Islands would think of resisting it. The custom is undoubtedly very ancient, dating from times when there were no courts and no justice except such as was meted out by princes personally. The popular derivation for the name is that which explains "Haro" as an abbreviation of "Hal Rollo," a direct appeal to Rollo, first duke of Normandy. It is far more probable that haro is simply an exclamation to call attention (O.H.G. *hera*, *hera*, "here"). Indeed it is clear that the "cry for justice" was in no sense an institution of Rollo, but was a method of appeal recognized in many countries. It is said to be identical with the "Legatro of the Bavarians and the Thuringians," and the first mention of it in France is to be found in the "Grand coutumier de Normandie." A similar custom, only observed in criminal charges, was recognized by the Saxon laws under the name of "Clamor Violentiae." Thus there is reason to think that William the Conqueror on his arrival in England found the "cry" fully established as far as criminal matters were concerned. Later the "cry" was made applicable to civil wrongs, and when the administration of justice became systematized, disappeared altogether in criminal cases. It naturally tended to become obsolete as the administration of justice became systematized, but it was long retained in north-western France in cases of disputed possession, and was not actually repealed until the close of the 18th century. A survival of the English form of haro is possibly to be found in the "Ara," a cry at fairs when "settling time" arrived.

HAROLD I. (d. 1040), surnamed Harefoot, the illegitimate son of Canute, king of England, and Ælfgifu of Northampton. On the death of his father in 1035, he claimed the crown of England in opposition to Canute's legitimate son, Hardicanute. His claims were supported by Leofric, earl of Mercia, and the north; those of Hardicanute by his mother, Queen Emma, Godwine, earl of the West-Saxons and the south. Eventually Harold was temporarily elected regent, pending a final settlement on Hardicanute's return from Denmark. Hardicanute, however, tarried, and meanwhile Harold's party increased rapidly. In 1037 he was definitely elected king, and banished Emma from the kingdom. The only events of his brief reign are ineffectual inroads of the Welsh and Scots. Hardicanute was preparing to invade England in support of his claims when Harold died at Oxford on the 10th of March 1040.

HAROLD II. (c. 1022-1066), king of the English, the second son of Earl Godwine, was born about 1022. While still very young (before 1045) he was appointed to the earldom of the East-Angles. He shared his father's outlawry and banishment in 1051; but while Godwine went to Flanders, Harold with his brother Leofwine took refuge in Ireland. In 1052 Harold and Leofwine returned. Having plundered in the west of England, they joined their father, and were with him at the assembly which decreed the restoration of the whole family. Harold was now restored to his earldom of the East-Angles, and on his father's death in 1053 he succeeded him in the greater earldom

of the West-Saxons. He was now the chief man in the kingdom, and when the older earls Leofric and Siward died his power increased yet more, and the latter part of Edward's reign was virtually the reign of Harold. In 1055 he drove back the Welsh, who had burned Hereford. In 1063 came the great Welsh war, in which Harold, with the help of his brother Tostig, crushed the power of Gruffyd, who was killed by his own people. But in spite of his power and his prowess, Harold was the minister of the king rather than his personal favourite. This latter position rather belonged to Tostig, who on the death of Siward in 1055 received the earldom of Northumberland. Here, however, his harshness soon provoked enmity, and in 1065 the Northumbrians revolted against him, choosing Morkere in his place. Harold acted as mediator between the king and the insurgents, and at length agreed to the choice of Morkere, and the banishment of his brother. At the beginning of 1066 Edward died, with his last breath recommending Harold as his successor. He was accordingly elected at once and crowned. The men of Northumberland at first refused to acknowledge him, but Harold won them over. The rest of his brief reign was taken up with preparations against the attacks which threatened him on both sides at once. William challenged the crown, alleging both a bequest of Edward in his favour and a personal engagement which Harold had contracted towards him—probably in 1064; and prepared for the invasion of England. Meanwhile Tostig was trying all means to bring about his own restoration. He first attacked the Isle of Wight, then Lindesey, but was compelled to take shelter in Scotland. From May to September the king kept the coast with a great force by sea and land, but at last provisions failed and the land army was dispersed. Harold then came to London, ready to meet whichever enemy came first. By this time Tostig had engaged Harold Hardrada of Norway to invade England. Together they sailed up the Humber, defeated Edwin and Morkere, and received the submission of York. Harold hurried northwards; and on the 25th of September he came on the Northmen at Stamford Bridge and won a complete victory, in which Tostig and Harold Hardrada were slain. But two days later William landed at Pevensey. Harold marched southward as fast as possible. He gathered his army in London from all southern and eastern England, but Edwin and Morkere kept back the forces of the north. The king then marched into Sussex and engaged the Normans on the hill of Senlac near Battle (see HASTINGS). After a fight which lasted from morning till evening, the Normans had the victory, and Harold and his two brothers lay dead on the field (14th of October 1066).

HARP (Fr. *harpe*; Ger. *Harfe*; Ital. *arpa*), a member of the class of stringed instruments of which the strings are twanged or vibrated by the fingers. The harp is an instrument of beautiful proportions, approximating to a triangular form, the strings diminishing in length as they ascend in pitch. The mechanism is concealed within the different parts of which the instrument is composed, (1) the pedestal or pedal-box, on which rest (2) the vertical pillar, and (3) the inclined convex body in which the soundboard is fixed, (4) the curved neck, with (5) the comb concealing the mechanism for stopping the strings, supported by the pillar and the body.

(1) The *pedestal* or *pedal-box* forms the base of the harp and contains seven pedals both in single and double action harps, the difference being that in the single action the pedals are only capable of raising the strings one semitone by means of a drop into a notch, whereas with the double action the pedals, after a first drop, can by a further drop into a second and lower notch shorten the string a second semitone, whereby each string is made to serve in turn for flat, natural and sharp. The harp is normally in the key of C flat major, and each of the seven pedals acts upon one of the notes of this diatonic scale throughout the compass. The choice of this method of tuning was imposed by the construction of the harp with double action. The pedals remain in the notches until released by the foot, when the pedal returns to its normal position through the action of a spiral spring, which may be seen under each of the pedals by turning the harp up.

(2) The *vertical pillar* is a kind of tunnel in which are placed the seven rods worked by the pedals, which set in motion the mechanism situated in the neck of the instrument. Although the pillar apparently

rests on the pedestal, it is really supported by a brass shoulder firmly screwed to the beam which forms the lowest part of the body, a connexion which remains undisturbed when the pedal box and its cover are removed.

(3) The body or sound-chest of the harp is in shape like the longitudinal section of a cone. It was formerly composed of staves joined together as in the lute and mandoline. Erard was the first to make it in two pieces of wood, generally sycamore, with the addition of a flat soundboard of Swiss pine. The body is strengthened on the inside, in order to resist the tension of the strings, by means of ribs; there are five soundholes in the back, which in the older models were furnished with swell shutters opened at will by the swell pedal, the fourth from the left worked by the left foot. As the increase of sound obtained by means of the swell was infinitesimal, the device has now been discarded. The harp is strung by knotting the end of the string and passing it through its hole in the centre of the soundboard, where it is kept in position by means of a grooved peg which grips the string.

(4) The neck consists of a curved piece of wood resting on the body at the treble end of the instrument and joining the pillar at the bass end. In the neck are set the tuning pins round which are wound the strings.

(5) The comb is the name given to two brass plates or covers which fit over both sides of the neck, concealing part of the mechanism for shortening the strings and raising their pitch a semitone when actuated by the pedals. On the front plate of the comb, to the left of the player, is a row of brass bridges against which the strings rest below the tuning pins, and which determine the vibrating length of the string reckoned from the peg in the soundboard. Below the bridges are two rows of brass disks, known as forks, connected by steel levers; each disk is equipped with two studs for grasping the string and shortening it. The mechanism is ingenious. When a pedal is depressed to the first notch, the corresponding lower disk turns a little way on a mandrel keeping the studs clear of the string. The upper disk, set in motion by the steel levers connecting the disks, revolves simultaneously till the string is caught by the two studs which thus form a new bridge, shortening the vibrating length of the string by just the length necessary to raise the pitch a semitone. If the same pedal be depressed to the second notch, another movement ceases the lower disk to revolve again till the string is a second time seized and shortened, the upper disk remaining stationary. The hidden mechanism meanwhile has gone through a series of movements; the pedal is really a lever set upon a spring, and when depressed it draws down the connecting rod in the pillar which sets in motion chains governing the mandrels of the disks.

The harp usually has forty-six strings, of gut in the middle and upper registers, and of covered steel wire in the bass; the C strings are red and the F strings blue. The compass thus has a range of

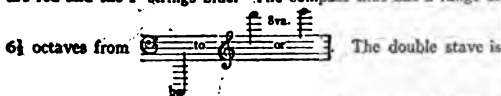

used as for the pianoforte. The single action harp used to be tuned to the key of E \flat major.

The modern harp with double action is the only instrument with fixed tones, not determined by the ear or touch of the performer, which has separate notes for naturals, sharps and flats, giving it an enharmonic compass. On the harp the appreciable interval between D \flat and E \flat can be played. The harp in its normal condition is tuned to C \flat major; it rests with the performer to transpose it at will in a few seconds into any other key by means of the pedals. Each of the pedals influences one note of the scale throughout the compass, beginning at the left with D, C, and B worked by the left foot. Missing the fourth or forte pedal, and continuing towards the right we get the E, F, G and A pedals worked by the right foot. By lowering the D pedal into the first notch the D \flat becomes D \sharp , and into the second notch D \sharp , and so on for all the pedals. If, for example, a piece be written in the key of E major, the harp is transposed into that key by depressing the E, A, and B pedals to the first notch, and those for F, G, C and D to the second or sharp notch and so on through all the keys. Accidentals and modulations are readily played by means of the pedals, provided the transitions be not too rapid. The harp is the instrument upon which transposition presents the least difficulty, for the fingering is the same for all keys. The strings are twanged with the thumbs and the first three fingers.

The quality of tone does not vary much in the different registers, but it has the greatest brilliancy in keys with many flats, for the strings are then open and not shortened by the forks. Various effects can be obtained on the harp: (1) by harmonics, (2) by damping, (3) by guitar tones, (4) by the glissando. (1) Harmonics are produced by resting the ball of the hand on the middle of the string and setting it in vibration by the thumb or the first two fingers of the same hand, whereby a mysterious and beautiful tone is obtained. Two or three harmonics can be played together with the left hand, and by using both hands at once as many as four are possible. (2) Damping is effected by laying the palm against the string in the

bass and the back of the finger in the treble. (3) Guitar or pizzicato notes are obtained by twanging the strings sharply at the lower end near the soundboard with the nails. (4) The glissando effect is produced, as on the pianoforte, by sliding the thumb or finger along the strings in quick succession; this does not necessarily give the diatonic scale, for by means of the pedals the harp can be tuned beforehand to chords. It is possible to play on the harp all kinds of diatonic and arpeggio passages, but no chromatic, except in very slow tempo, on account of the time required by the mechanism of the pedals; and chords of three or four notes in each hand, shakes, turns, successions of double notes can be easily acquired. The same note can also be repeated slowly or quickly, the next string being tuned to a duplicate note, and the two strings plucked alternately in order to give the string time to vibrate.

Pleyel's chromatic harp, patented in 1804 and improved in 1803 by Gustave Lyon, manager of the firm of Pleyel, Wolff & Co., is an instrument practically without mechanism which has already won great favour in France and Belgium, notably in the orchestra. It has been constructed on the familiar lines of the pianoforte; Henry Pape, a piano manufacturer, had in 1845 conceived the idea of a chromatic harp of which the strings crossed in the centre as in the piano, and a report on the construction was published at the time; the instrument, however, was not considered successful, and was relegated to oblivion until Mr Lyon revised the matter and brought out a successful and practical instrument. The advantages claimed for this harp are the abandonment of the whole pedal mechanism, a metal framing which insures the strings keeping in tune as long as those of a piano, and an easily acquired technique. The chromatic harp consists of (1) a pedestal on castors, (2) a steel pillar without internal mechanism, (3) a wide neck containing two brass wrest-planks in which are fixed two rows of tuning pins, and (4) a soundchest in which is firmly riveted the steel plate to which the strings are fastened, and the soundboard pierced with eyelet holes through which the strings are drawn to the string plate. There is a string for every chromatic semitone of the scale of C major, the white strings representing the white keys of the piano keyboard, and the black strings corresponding to the black keys. The tuning pins for the black strings are set in the left side of the neck in alternate groups of twos and threes, and those for the white in the right side in alternate groups of threes and fours. The strings cross half-way between neck and soundboard, this being the point where they are plucked; the left hand finds the black notes above, and the right hand below the crossing. There is besides in the neck a set of twelve tuning buttons, each one of which on being pressed gives out one note of the chromatic scale tuned to the pitch of the diapason normal. It is obvious that the repertoire for this harp is very extensive, including many compositions written for the piano, which however cannot be played with any legato effects, these being still impossible on this chromatic harp.

History.—While the instrument is of great antiquity, it is yet from northern Europe that the modern harp and its name are derived. The Greeks and Romans preferred to it the lyre in its different varieties, and a Latin writer, Venantius Fortunatus,¹ describes it in the 7th century of our era as an instrument of the barbarians—"Romanusque lyra, plaudat tibi barbarus harpa." This is believed to be the earliest mention of the name, which is clearly Teutonic.—O.H.Ger. *harapha*, A.-S. *hearpe*, Old Norse *harpa*. The modern Fr. *harpe* retains the aspirate; in the Spanish and Italian *arpa* it is dropped.

The earliest delineations of the harp in Egypt give no indication that it had not existed long before. There are, indeed, representations in Egyptian paintings of stringed instruments of a bow-form having affinities with both primitive harp and *nefer* (a kind of oval guitar) that support the idea of the invention of the harp from the tense string of the warrior's or hunter's bow. This primitive-looking instrument, called *nanga*, had a boat-shaped sound-chest with a parchment or skin soundboard, down the centre of which one end of the string was fastened to a strip of wood, whilst the other was wound round pegs in the upper part of the bow. The *nanga* was played horizontally, being borne upon the performer's shoulder.² Between it and the grand vertical harps in the frescos of the time of Rameses III., more than 3000 years old, discovered by the traveller Bruce³ (fig. 1), there are varieties that permit us to bind the whole



FIG. 1.

¹ *Poemata*, lib. vii. cap. 8, p. 245, Migne's *Patrologia cursus completus* (Paris, 1857-1866, vol. 83).

² A few *nangas* (c. 1500 B.C.) are preserved among the Egyptian antiquities at the British Museum, fourth Egyptian room.

³ Bruce's harps are reproduced by Champollion, tome iii. p. 261.

from the simplest bow-form to the almost triangular harp, into one family (see fig. 2).

The Egyptian harp had no front pillar, and as it was strung with catgut the tension and pitch must necessarily have been low. The



FIG. 2.

harps above-mentioned depicted in the tomb at Thebes, assumed from the players to be more than 6 ft. high, have not many strings, the one having ten, the other thirteen. What the accordance of these strings was it would be hard to recover. We must be content with the knowledge that the old Egyptians possessed harps in principle like our own, the largest having pedestals upon which they prized them.

The ancient Assyrians had harps like those of Egypt in being without a front pillar, but differing from them in having the sound-body uppermost, in which we find the early use of soundholes; while the lower portion was a bar to which the strings were tied and by means of which the tuning was apparently effected.¹ What the Hebrew harp was, whether it followed the Egyptian or the Assyrian, we do not know. That King David played upon the harp as commonly depicted is rather a modern idea. Medieval artists frequently gave King David the psaltery, a horizontal stringed instrument from which has gradually developed the modern piano. The Hebrew "kinnor" may have been a kind of trigonon, a triangular stringed instrument between a small harp and a psaltery, sounded by a plectrum, or more probably, as advocated by Dr Stainer in his essay on the music of the Bible, a kind of lyre.

The earliest records that we possess of the Celtic race, whether Gaelic or Cymric, give the harp a prominent place and harpists peculiar veneration and distinction. The names for the harp are, however, quite different from the Teutonic. The Irish "clairseach," the Highland Scottish "clarsach," the Welsh, Cornish, Breton "teilyn," "telein," "têlen," "têlen," show no etymological kinship to the other European names. The first syllable in clairseach or clarsach is derived from the Gaelic "clar," a board or table (soundboard), while the first syllable of teilyn is distinctly Old Welsh, and has a tensile meaning; thus resonance supplies the one idea, and tension the other.

The literature of these Celtic harps may be most directly found in Bunting's *Ancient Music of Ireland* (Dublin, 1809), Gunn's *Historical Enquiry respecting the Performances on the Harp in the Highlands of Scotland* (Edinburgh, 1807), and E. Jones's *Musical and Poetical Memoirs of the Welsh Bards* (London, 1784). The treatises of Walker, Dalryell, and others may also be consulted; but in all these authorities due care must be taken of the bias of patriotism, and the delusive aim to reconstruct much that we must be content to receive as only vaguely indicated in records and old monuments. There is, however, one early Irish monument about which there can be no mistake, the harp upon a cross belonging to the ancient church of Ullard near Kilkenny, the date of which cannot be later than 830; the sculpture is rude, but the instrument is clearly shown by the drawing in Bunting's work to have no front pillar. This remarkable structural likeness to the old harps of Egypt and Assyria may be accidental, but permits the plausible hypothesis of Eastern descent. The oldest specimen of the beautiful form by which the Irish harp is now recognized, with gracefully curved front pillar and sweep of neck (the latter known as the harmonic curve), is the famous harp in Trinity College, Dublin, the possession of which has been attributed to King Brian Boiroimhe. From this mythic ownership Dr Petrie (see essay in Bunting) has delivered it; but he can only deduce the age from the ornamentation and heraldry, which fix its date in the 14th century or a little later. There is a cast of it in the Victoria and Albert Museum. The next oldest is in the Highlands of Scotland, the *Clarsach Lamontach*, or Lamont's Clarschoe, belonging, with another of later date, to the old Perthshire family of Robertson of Lude. Both are described in detail by Gunn. This Lamont harp was taken by a lady of that family from Argyleshire about 1460, on her marriage into the family of Lude. It had about thirty strings tuned singly, but the scale was sometimes doubled in pairs of unisons like lutes and other contemporary instruments. The Dalway harp in Ireland (fig. 3) inscribed "Ego sum Regina Cithararum," and dated 1621, appears to have had pairs of strings in the centre only. These were of brass wire, and played with the pointed finger-nails. The Italian contemporary "Arpa Doppia" was entirely upon the duplex principle, but with gut strings played by the fleshy ends of the fingers. When E. Bunting met at Belfast in 1792 as

¹ Representations of these may be seen among the musical scenes in the Nimrod Gallery at the British Museum.

many Irish harpers as could be at that late date assembled, he

found the compass of their harps to comprise



thirty notes which were tuned diatonically in the key of G, under certain circumstances transposable to C and rarely to D, the scales being the major of these keys. The harp first appeared in the coat of arms of Ireland in the reign of Henry VIII.; and some years after in a map of 1567 preserved in a volume of state papers, we find it truly drawn according to the outlines of the national Irish instrument.² References to the Highlands of Scotland are of necessity included with Ireland; and in both we find another name

erroneously applied by lexicographers to the harp, viz. "cruit." Bunting, particularly mentions the "cinnard cruit" (harp with a high head) and the "crom cruit" (the curved harp). In the Ossianic MSS. of the Dean of Lismore (1512) the word "cru" occurs several times, and in Neill M'Alpine's *Gaelic Dictionary* (1832), which gives the dialect of Islay, closely related to that of Ulster, the word "cruit" is rendered "harp." The confusion doubtless arose from the fact that from the 11th century cithara is glossed *hearpan* in Anglo-Saxon MSS., a word which, like *citharisare* in medieval Latin, referred to plucking or twanging of strings in contradistinction to those instruments vibrated by means of the bow.



FIG. 3.

Irish (Dalway) Harp. Irish (Dalway) Harp. cithara is always glossed by "crot." The modern Welsh "cwrth" is not a harp but a "rotta" (see CROWD). An old Welsh harp, not triple strung, exists, which bears a great resemblance to the Irish harp in neck, soundboard and soundholes. But this does not imply derivation of the harp of Wales from that of Ireland or the reverse. There is really no good historical evidence, and there may have been a common or distinct origin on which ethnology only can throw light.³ The Welsh like the Irish harp was often an hereditary instrument to be preserved with great care and veneration, and used by the bards of the family, who were alike the poet-musicians and historians. A slave was not allowed to touch a harp, and it was exempted by the Welsh laws from seizure for debt. The old Welsh harp appears to have been at one time strung with horse-hair, and by the Eisteddfod laws the pupil spent his noviciate of three years in the practice of a harp with that stringing. The comparatively modern Welsh triple harp (fig. 4) is always strung with gut. It has a rising neck as before stated, and three rows of strings,—the outer rows tuned diatonic, the centre one chromatic for the sharps and flats. Jones gives it 98 strings, and a compass of 5 octaves and one note, from violoncello C. As in all Celtic harps, the left is the treble hand, and in the triple harps there are 27 strings on that side, the right or bass hand having 37, and the middle or chromatic row 34.

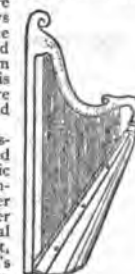

FIG. 4.

The first pattern of the modern harp is discovered in German and Anglo-Saxon illuminated MSS. as far back as the 9th century.⁴ A diatonic instrument, it must have been common throughout Europe, as Orcagna, Fra Angelico, and other famous Italian painters depict it over and over again in their masterpieces. No accidental semitones were possible with this instrument, unless the strings were shortened by the player's fingers. This lasted until the 17th century, when a Tirolese maker adapted hooks (perhaps suggested by the fretted or bonded clavichord) Welsh Triple Harp, that, screwed into the neck, could be turned downwards to fix the desired semitone at pleasure. At last, somewhere about 1720, Hochbrucker, a Bavarian, invented pedals that, acting through the pedestal of the instrument, governed by mechanism the stopping, and thus left the player's hands free, an indisputable advantage; and it became possible at once to play in no less

² See also a woodcut in John Derrick's *Image of Ireland* (1581), pl. iii. (Edinburgh ed. 1883).

³ See the fine volume *Musical Instruments on the Irish and Scottish Harps* by Robert Bruce Armstrong (1904), vol. i. Vol. ii., which deals with the Welsh harp, has unfortunately been withdrawn from sale.

⁴ See for the medieval harp a careful article by Hortense Panum, "Harfe und Lyra im alten Nord-Europa," in *Intern. Mus. Ges.* vol. vii. pt. 1 (Leipzig, 1905); and for references as to illuminated MSS., early woodcuts, paintings, &c. see Hugo Leichtentritt, "Was lehren uns die Bildwerke des 14-17 Jahrhunderts über die Instrumentalmusik ihrer Zeit?" *ibid.* vol. vii. p. 3 (Leipzig, 1906).

⁵ See Nauwerk, "Die Hakenharfe, Die Vervollkommnung des Mechanismus an der deutschen Harfe," in *Allg. musik. Ztg.* (Leipzig, 1815), p. 545 seq.

than eight major scales. By a sequence of improvements, in which two Frenchmen named Cousineau took an important part, the various defects inherent in Hochbrucker's plan became ameliorated. The pedals were doubled, and, the tuning of the instrument being changed from the key of Eb to Cb, it became possible to play in fifteen keys, thus exceeding the power of the keyboard instruments, over which the harp has another important advantage in the simplicity of the fingering, which is the same for every key.

It is to Sebastian Erard we owe the perfecting of the pedal harp (fig. 5), a triumph which he gained in Paris by unremitting studies begun when he adopted a "fork" mechanism in 1786 and ended in 1810 when he had attained complete success with the double action pedal mechanism already described above. Erard's merit was not confined to this improvement only; he modified the structure of the comb that conceals the mechanism, and constructed the sound-body of the instrument upon a modern principle more advantageous to the tone.

Notwithstanding these improvements and the great beauty of tone the harp possesses, the domestic use of it in modern times has almost disappeared. The great cost of a good harp, and the trouble to many amateurs of tuning, may have led to the supplanting of the harp by the more convenient and useful pianoforte. With this comes naturally a diminution in the number of solo-players on the instru-

ment. Were it not for the increasing use of the harp in the orchestra, the colour of its tone having attracted the masters of instrumentation, so that the great scores of Meyerbeer and Gounod, of Berlioz, Liszt and Wagner are not complete without it, we should perhaps know little more of the harp than of the dulcimer, in spite of the efforts of distinguished virtuosi whose devotion to their instrument maintains its technique on an equality with that of any other, even the most in public favour. The first record of the use of harps in the orchestra occurs in the account of the *Ballet comique de la royne* performed at the château de Moutiers on the occasion of the marriage of Mary of Lorraine with the duc de Joyeuse in 1581, when harps formed part of the *concert de musique*.

See in addition to the works already referred to, Engel's *Musical Instruments in the South Kensington Museum* (1874); and the articles "Harp," in Rees's *Cyclopaedia*, written by Dr Buryay, in Stainer and Barrett's *Dictionary of Musical Terms* (1876), and in Grove's *Dictionary of Music and Musicians*. On the origins of the instrument see *Proceedings of British Association* (1904) (address of president of anthropological section). (K. S.; A. J. H.)

HARPENDEN, an urban district in the Mid or St Albans parliamentary division of Hertfordshire, England, 25 m. N.W. by N. from London by the Midland railway, served also by a branch of the Great Northern railway. Pop. (1901) 4725. It is a favourite outlying residential district for those whose work lies in London. The church of St Nicholas is a modern reconstruction with the exception of the Perpendicular tower. In the Lawes Testimonial Laboratory there is a vast collection of samples of experimentally grown produce, annual products, ashes and soils. Sir John Bennet Lawes (d. 1900) provided an endowment of £100,000 for the perpetuation of the agricultural experiments which he inaugurated here at his seat of Rothamsted Park. The success of his association of chemistry, with botany is shown by the fact that soil has been made to bear wheat without intermission for upwards of half a century without manure. The country neighbouring to Harpenden is very pleasant, including the gorse-covered Harpenden Common and the narrow well-wooded valley of the upper Lea.

HARPER'S FERRY, a town of Jefferson county, West Virginia, U.S.A., finely situated at the confluence of the Potomac and Shenandoah rivers (which here pass through a beautiful gorge in the Blue Ridge), 55 m. N.W. of Washington. Pop. (1900) 896; (1910) 766. It is served by the Baltimore & Ohio railway, which crosses the Potomac here, by the Winchester & Potomac railway (Baltimore & Ohio) of which it is a terminus, and by boats on the Chesapeake & Ohio Canal, which passes along the Maryland side of the Potomac. Across the Potomac on the north rise the Maryland Heights; across the Shenandoah, on the West Virginia side, the Virginia or Loudoun Heights; and behind the town to the W. the Bolivar Heights. A United States arsenal and armoury were established at Harper's Ferry in 1796, the site being chosen because of the good water-power;

these were seized on the 16th of October 1859 by John Brown (q.v.), the abolitionist, and some 21 of his followers. For four months before the raid Brown and his men lived on the Kennedy Farm, in Washington county, Maryland, about 4 m. N.W. of Harper's Ferry. The engine-house in which Brown was captured was exhibited at the Columbian Exposition at Chicago and was later rebuilt on Bolivar Heights; a marble pillar, marked "John Brown's Fort," has been erected on its original site. On Camp Hill is Storer College (state-aided), a normal school for negroes, which was established under Free Baptist control in 1867, and has academic, normal, biblical, musical and industrial departments.

The first settlement here was made about 1747 by Robert Harper, who ran a ferry across the Potomac. The position of Harper's Ferry at the lower end of the Shenandoah Valley rendered it a place of strategic importance during the Civil War. On the 18th of April 1861, the day after Virginia passed her ordinance of secession, when a considerable force of Virginia militia under General Kenton Harper approached the town—an attack having been planned in Richmond two days before—the Federal garrison of 45 men under Lieutenant Roger Jones set fire to the arsenal and fled. Within the next few days large numbers of Confederate volunteers assembled here; and Harper was succeeded in command (27th April) by "Stonewall" Jackson, who was in turn succeeded by Brigadier-General Joseph E. Johnston on the 23rd of May. Johnston thought that the place was unimportant, and withdrew when (15th June) the Federal forces under General Robert Patterson and Colonel Lew Wallace approached, and Harper's Ferry was again occupied by a Federal garrison. In September 1862, during General Lee's first invasion of the North, General McClellan advised that the place be abandoned in order that the 10,000 men defending it might be added to his fighting force, but General Halleck would not consent, so that when Lee needed supplies from the Shenandoah Valley he was blocked by the garrison, then under the command of Colonel Dixon S. Miles. On Jackson's approach they were distributed as follows: about 7000 men on Bolivar Heights, about 2000 on Maryland Heights, and about 1800 on the lower ground. On the 13th of September General Lafayette McLaws carried Maryland Heights and General John G. Walker planted a battery on Loudoun Heights. On the 14th there was some fighting, but early on the 15th, as Jackson was about to make an assault on Bolivar Heights, the garrison, surrounded by a superior force, surrendered. The total Federal loss (including the garrisons at Winchester and Martinsburg) amounted to 44 killed (the commander was mortally wounded), 12,520 prisoners, and 13,000 small arms. For this terrible loss to the Union army the responsibility seems to have been General Halleck's, though the blame was officially put on Colonel Miles, who died immediately after the surrender. Jackson rejoined Lee on the following day in time to take part in the battle of Antietam, and after the battle General McClellan placed a strong garrison (the 12th Corps) at Harper's Ferry. In June 1863 the place was again abandoned to the Confederates on their march to Pennsylvania. After their defeat at Gettysburg, the town again fell into the hands of the Federal troops, and it remained in their possession until the end of the war. On the 4th of July 1864 General Franz Sigel, who was then in command here, withdrew his troops to Maryland Heights, and from there resisted Early's attempt to enter the town and to drive the Federal garrison from Maryland Heights. Harper's Ferry was seriously damaged by a flood in the Shenandoah in October 1878.

HARPIES (Gr. ἄρπυιαι, older form ἄρπυιαι, "swift robbers"), in ancient mythology, the personification of the sweeping storm-winds. In Homer, where they appear indifferently under the name of ἄρπυιαι and θεῖλαιαι, their function is to carry off those whose sudden disappearance is desired by the gods. Only one of them is there mentioned (*Iliad*, xvi. 150) by name, Podargē, the mother of the coursers of Achilles by Zephyrus, the generative wind. According to Hesiod (*Theog.* 265) they are two in number, Aëlo and Ocypetē, daughters of Thaumias and Electra, winged

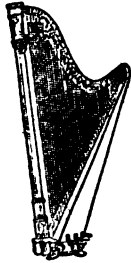

FIG. 5. Modern Erard Harp.

goddesses with beautiful locks, swifter than winds and birds in their flight, and their domain is the air. In later times their number was increased (Celaeno being a frequent addition and their leader in Virgil), and they were described as hateful and repulsive creatures, birds with the faces of old women, the ears of bears, crooked talons and hanging breasts; even in Aeschylus (*Emmenides*, 50) they appear as ugly and misshapen monsters. Their function of snatching away mortals to the other world brings them into connexion with the Erinyes, with whom they are often confounded. On the so-called Harpy monument from Lycia, now in the British Museum, the Harpies appear carrying off some small figures, supposed to be the daughters of Pandareus, unless they are intended to represent departed souls. The repulsive character of the Harpies is more especially seen in the legend of Phineus, king of Salmysdesus in Thrace (Apollodorus i. 9, 21; see also Diod. Sic. iv. 43). Having been deprived of his sight by the gods for his ill-treatment of his sons by his first wife (or for having revealed the future to mortals), he was condemned to be tormented by two Harpies, who carried off whatever food was placed before him. On the arrival of the Argonauts, Phineus promised to give them particulars of the course they should pursue and of the dangers that lay before them, if they would deliver him from his tormentors. Accordingly, when the Harpies appeared as usual to carry off the food from Phineus's table, they were driven off and pursued by Calais and Zetes, the sons of Boreas, as far as the Strophades islands in the Aegean. On promising to cease from molesting Phineus, their lives were spared. Their place of abode is variously placed in the Strophades, the entrance to the under-world, or a cave in Crete. According to Cecil Smith, *Journal of Hellenic Studies*, xiii. (1892-1893), the Harpies are the hostile spirits of the scorching south wind; E. Rohde (*Rheinisches Museum*, i., 1895) regards them as spirits of the storm, which at the bidding of the gods carry off human beings alive to the under-world or some spot beyond human ken.

See articles in Roscher's *Lexikon der Mythologie* and Daremberg and Saglio's *Dictionnaire des antiquités*. In the article GREEK ART, fig. 14 gives a representation of the winged Harpies.

HARPIGNIES, HENRI (1819-), French landscape painter, born at Valenciennes in 1819, was intended by his parents for a business career, but his determination to become an artist was so strong that it conquered all obstacles, and he was allowed at the age of twenty-seven to enter Achard's atelier in Paris. From this painter he acquired a groundwork of sound constructive draughtsmanship, which is so marked a feature of his landscape painting. After two years under this exacting teacher he went to Italy, whence he returned in 1850. During the next few years he devoted himself to the painting of children in landscape setting, and fell in with Corot and the other Barbizon masters, whose principles and methods are to a certain extent reflected in his own personal art. To Corot he was united by a bond of warm friendship, and the two artists went together to Italy in 1860. On his return, he scored his first great success at the Salon, in 1861, with his "Lisière de bois sur les bords de l'Allier." After that year he was a regular exhibitor at the old Salon; in 1886 he received his first medal for "Le Soir dans la campagne de Rome," which was acquired for the Luxembourg Gallery. Many of his best works were painted at Hérisson in the Bourbonnais, as well as in the Nivernais and the Auvergne. Among his chief pictures are "Soir sur les bords de la Loire" (1861), "Les Corbeaux" (1865), "Le Soir" (1866), "Le Saut-du-Loup" (1873), "La Loire" (1882), and "Vue de Saint-Privé" (1883). He also did some decorative work for the Paris Opéra—the "Vallée d'Égérie" panel, which he showed at the Salon of 1870.

HARP-LUTE, or DITAL HARP, one of the many attempts to revive the popularity of the guitar and to increase its compass, invented in 1798 by Edward Light. The harp-lute owes the first part of its name to the characteristic mechanism for shortening the effective length of the strings; its second name—dital harp—emphasizes the nature of the stops, which are worked by the thumb in contradistinction to the pedals of the harp worked

by the feet. It consists of a pear-shaped body, to which is added a curved neck supported on a front pillar or arm springing from the body, and therefore reminiscent of the harp. There are 12 catgut strings. The curved fingerboard, almost parallel with the neck, is provided with frets, and has in addition a thumb-key for each string, by means of which the accordance of the string is mechanically raised a semitone at will. The dital or key, on being depressed, acts upon a stop-rod or eye, which draws the string down against the fret, and thus shortens its effective length. The fingers then stop the strings as usual over the remaining frets. A further improvement was patented in 1816 as the British harp-lute. Other attempts possessing less practical merit than the dital harp were the lyra-guitarre, which appeared in Germany at the beginning of the 19th century; the accord-guitarre, towards the middle of the same century; and the keyed guitar. (K. S.)

HARPOCRATES, originally an Egyptian deity, adopted by the Greeks, and worshipped in later times both by Greeks and Romans. In Egypt, Harpa-khruti, Horus the child, was one of the forms of Horus, the sun-god, the child of Osiris. He was supposed to carry on war against the powers of darkness, and hence Herodotus (ii. 144) considers him the same as the Greek Apollo. He was represented in statues with his finger on his mouth, a symbol of childhood. The Greeks and Romans, not understanding the meaning of this attitude, made him the god of silence (Ovid, *Melam.* ix. 691), and as such he became a favourite deity with the later mystic schools of philosophy.

See articles by G. Lafaye in Daremberg and Saglio's *Dictionnaire des antiquités*, and by E. Meyer (*s.v.* "Horus") in Roscher's *Lexikon der Mythologie*.

HARPOCRATION, VALERIUS, Greek grammarian of Alexandria. He is possibly the Harpocraton mentioned by Julius Capitolinus (*Life of Verus*, 2) as the Greek tutor of Antoninus Verus (2nd century A.D.); some authorities place him much later, on the ground that he borrowed from Athenaeus. He is the author of a *Λεξικόν* (or *Περὶ τῶν λέξεων τῶν δεκά βιβλίων*), which has come down to us in an incomplete form. The work contains, in more or less alphabetical order, notes on well-known events and persons mentioned by the orators, and explanations of legal and commercial expressions. As nearly all the lexicons to the Greek orators have been lost, Harpocraton's work is especially valuable. Amongst his authorities were the writers of Attidēs (histories of Attica), the grammarian Didymus, Dionysius of Halicarnassus, and the lexicographer Dionysius, son of Tryphon. The book also contains contributions to the history of Attic oratory and Greek literature generally. Nothing is known of an *Ἀθηναίων συναγωγή*, a sort of anthology or chrestomathy attributed to him by Suidas. A series of articles in the margin of a Cambridge MS. of the lexicon forms the basis of the *Lexicon rhetoricum Cantabrigiense* (see DOBREE, P. P.).

The best edition is by W. Dindorf (1853); see also J. E. Sandys, *History of Classical Scholarship*, i. (1906), p. 325; C. Boysen, *De Harpocratonis fontibus* (Kiel, 1876).

HARPOON (from Fr. *harpon*, a grappling-iron, O. Fr. *harpe*, a dog's claw, an iron clamp for fastening stones together; the source of these words is the Lat. *harpago*, *harpa*, &c., formed from Gr. ἄρπαγή, hook, ἄρπάζω, to snatch, tear away, cf. "harpy"), barbed spear, particularly one used for spearing whales or other large fish, and either thrown by hand or fired from a gun (see WHALE-FISHERY).

HARPSICHORD, HARPSICON, DOUBLE VIRGINALS (Fr. *clavecin*; Ger. *Clavicymbel*, *Kiel-Flügel*; Ital. *arpicordo*, *cembalo*, *clavicembalo*, *gravicembalo*; Dutch, *clavisinbal*), a large keyboard instrument (see PIANOFORTE), belonging to the same family as the virginal and spinet, but having 2, 3, or even 4 strings to each note, and a case of the harp or wing shape, afterwards adopted for the grand pianoforte. J. S. Bach's harpsichord, preserved in the museum of the Hochschule für Musik at Charlottenburg, has two manuals and 4 strings to each note, one 16 ft., two 8 ft. and one 4 ft. By means of stops the performer has within his power a number of combinations for varying the tone and dynamic power. In all instruments of the harpsichord family

the strings, instead of being struck by tangents as in the clavichord, or by hammers as in the pianoforte, are plucked by means of a quill firmly embedded in the centred tongue of a jack or upright placed on the back end of the key-lever. When the finger depresses a key, the jack is thrown up, and in passing the crow-quill catches the string and twangs it. It is this twanging of the string which produces the brilliant incisive tone peculiar to the harpsichord family. What these instruments gain in brilliancy of tone, however, they lose in power of expression and of accent. The impossibility of commanding any emphasis necessarily created for the harpsichord an individual technique which influenced the music composed for it to so great an extent that it cannot be adequately rendered upon the pianoforte.

The harpsichord assumed a position of great importance during the 16th and 17th centuries, more especially in the orchestra, which was under the leadership of the harpsichord player. The most famous of all harpsichord makers, whose names form a guarantee for excellence, were the Ruckers, established at Antwerp from the last quarter of the 16th century. (K. S.)

HARPY, a large diurnal bird of prey, so named after the mythological monster of the classical poets (see **HARPIES**),—the *Thrasaetus harpyia* of modern ornithologists—an inhabitant of the warmer parts of America from Southern Mexico to Brazil. Though known since the middle of the 17th century, its habits have come very little under the notice of naturalists, and what is said of them by the older writers must be received with some



Harpy.

suspicion. A cursory inspection of the bird, which is not unfrequently brought alive to Europe, its size, and its enormous bill and talons, at once suggest the vast powers of destruction imputed to it, and are enough to account for the stories told of its ravages on mammals—sloths, fawns, peccaries and spider-monkeys. It has even been asserted to attack the human race. How much of this is fabulous there seems no means at present of determining, but some of the statements are made by voracious travellers—D'Orbigny and Tschudi. It is not uncommon in the forests of the isthmus of Panama, and Salvin says (*Proc. Zool. Society*, 1864, p. 368) that its flight is slow and heavy. Indeed its owl-like visage, its short wings and soft plumage, do not indicate a bird of very active habits, but the weapons of offence with which it is armed show that it must be able to cope with vigorous prey. Its appearance is sufficiently striking—the head and lower parts, except a pectoral band, white, the former

adorned with an erectile crest, the upper parts dark grey banded with black, the wings dusky, and the tail barred; but the huge bill and powerful scutellated legs most of all impress the beholder. The precise affinities of the harpy cannot be said to have been determined. By some authors it is referred to the eagles, by others to the buzzards, and by others again to the hawks; but possibly the first of these alliances is the most likely to be true. (A. N.)

HARRAN, HARAN or CHARRAN (Sept. *Χαρράν* or *Χαρρά:*; Strabo, *Κάρρα:* Pliny, *Carras* or *Carrhoe*; Arab. *Harrán*), in biblical history the place where Terah halted after leaving Ur, and apparently the birthplace of Abraham, a town on the stream Jullab, some nine hours' journey from Edessa in Syria. At this point the road from Damascus joins the highway between Nineveh and Carchemish, and Haran had thus considerable military and commercial value. As a strategic position it is mentioned in inscriptions as early as the time of Tiglath Pileser I., about 1100 B.C., and subsequently by Sargon II., who restored the privileges lost at the rebellion which led to the conquest referred to in 2 Kings xix. 12 (=Isa. xxxvii. 12). It was the centre of a considerable commerce (Ezek. xxvii. 23), and one of its specialities was the odoriferous gum derived from the strobilus (Pliny, *H.N.* xii. 40). It was here that Crassus in his eastern expedition was attacked and slain by the Parthians (53 B.C.); and here also the emperor Caracalla was murdered at the instigation of Macrinus (A.D. 217). Haran was the chief home of the moon-god Sin, whose temple was rebuilt by several kings, among them Assur-bani-pal and Nabunidus and Herodian (iv. 13, 7) mentions the town as possessing in his day a temple of the moon. In the middle ages it is mentioned as having been the seat of a particular heathen sect, that of the Haranite Sabæans. It retained its importance down to the period of the Arab ascendancy; but by Abulfeda it is mentioned as having before his time fallen into decay. It is now wholly in ruins. The Yahwistic writer (Gen. xxvii. 43) makes it the home of Laban and connects it with Isaac and Jacob. But we cannot thus put Haran in Aramnaharaim; the home of the Labanites is rather to be looked for in the very similar word Hauran.

HARRAR (or **HARAR**), a city of N.E. Africa, in 8° 45' N., 42° 36' E., capital of a province of Abyssinia and 220 m. S.S.W. of the ports of Zaila (British) and Jibuti (French) on the Gulf of Aden. With Jibuti it is connected by a railway (188 m. long) and carriage-road. Harrar is built on the slopes of a hill at an elevation of over 5000 ft. A lofty stone wall, pierced by five gates and flanked by twenty-four towers, encloses the city, which has a population of about 40,000. The streets are steep, narrow, dirty and unpaved, the roadways consisting of rough boulders. The houses are in general made of undressed stone and mud and are flat-topped, the general aspect of the city being Oriental and un-Abyssinian. A few houses, including the palace of the governor and the foreign consulates, are of more elaborate and solid construction than the majority of the buildings. There are several mosques and an Abyssinian church (of the usual circular construction) built of stone. Harrar is a city of considerable commercial importance, through it passing all the merchandise of southern Abyssinia, Kaffa and Galla land. The chief traders are Abyssinians, Armenians and Greeks. The principal article of export is coffee, which is grown extensively in the neighbouring hills and is of the finest quality. Besides coffee there is a large trade in durra, the kat plant (used by the Mahomedans as a drug), ghee, cattle, mules and camels, skins and hides, ivory and gums. The import trade is largely in cotton goods, but every kind of merchandise is included.

Harrar is believed to owe its foundation to Arab immigrants from the Yemen in the 7th century of the Christian era. In the region of Somaliland, now the western part of the British protectorate of that name, the Arabs established the Moslem state of Adel or Zaila, with their capital at Zaila on the Gulf of Aden. In the 13th century the sultans of Adel enjoyed great power. In 1521 the then sultan Abubekr transferred the seat of government to Harrar, probably regarding Zaila as too exposed to the attacks of the Turkish and Portuguese navies then contending

for the mastery of the Red Sea and Gulf of Aden. Abubekr's successor was Mahommed III., Ahmed ibn Ibrahim el-Ghazi (1507-1543), surnamed Gran (Granyé), the left-handed. He was not an Arab but, probably, of Somali origin. The son of a noted warrior, he quickly rose to supreme power, becoming sultan or amir in 1525. He is famous for his invasion of Abyssinia, of which country he was virtual master for several years. From the beginning of the 17th century Adel suffered greatly from the ravages of pagan Galla tribes, and Harrar sank to the position of an amirate of little importance. It was first visited by a European in 1854 when (Sir) Richard Burton spent ten days there in the guise of an Arab. In 1875 Harrar was occupied by an Egyptian force under Raouf Pasha, by whose orders the amir was strangled. The town remained in the possession of Egypt until 1885, when the garrison was withdrawn in consequence of the rising of the Mahdi in the Sudan. The Egyptian garrison and many Egyptian civilians, in all 6500 persons, left Harrar between November 1884 and the 25th of April 1885, when a son of the ruler who had been deposed by Egypt was installed as amir, the arrangement being carried out under the superintendence of British officers. The new amir held power until January 1887, in which month Harrar was conquered by Menelek II., king of Shoa (afterwards emperor of Abyssinia). The governorship of Harrar was by Menelek entrusted to Ras Makonnen, who held the post until his death in 1906.

The Harrari proper are of a distinct stock from the neighbouring peoples, and speak a special language. Harrarese is "a Semitic graft inserted into an indigenous stock" (Sir R. Burton, *First Footsteps in East Africa*). The Harrari are Mahomedans of the Shafa'i or Persian sect, and they employ the solar year and the Persian calendar. Besides the native population there are in Harrar colonies of Abyssinians, Somalis and Gallas. By the Somalis the place is called Adari, by the Gallas Adaray.

See ABYSSINIA; SOMALILAND. Also P. Paulitschke, *Harrar: Forschungsreise nach den Somal- und Galla-Ländern Ost-Afrikas* (Leipzig, 1888).

HARRATIN, black Berbers; dwelling in Tidikelt and other Saharan oases. Many of them are blacker than the average negro. In physique, however, they are true to the Berber type, being of handsome appearance with European features and well-proportioned bodies. They are the result of an early crossing with the Sudanese negro races, though to-day they have all the pride of the Berbers (*q.v.*), and do not live with or intermarry among negroes.

HARRIER, or **HEN-HARRIER**, name given to certain birds of prey which were formerly very abundant in parts of the British Islands, from their habit of harrying poultry. The first of these names has now become used in a generic sense for all the species ranked under the genus *Circus* of Lacépède, and the second confined to the particular species which is the *Falco cyaneus* of Linnaeus and the *Circus cyaneus* of modern ornithologists.

One European species, *C. aeruginosus*, though called in books the marsh-harrier, is far more commonly known in England and Ireland as the moor-buzzard. But harriers are not, like buzzards, arboreal in their habits, and always affect open country, generally, though not invariably, preferring marshy or fenny districts; for snakes and frogs form a great part of their ordinary food. On the ground their carriage is utterly unlike that of a buzzard, and their long wings and legs render it easy to distinguish the two groups when taken in the hand. All the species also have a more or less well-developed ruff or frill of small thickset feathers surrounding the lower part of the head, nearly like that seen in owls, and accordingly many systematists consider that the genus *Circus*, though undoubtedly belonging to the *Falconidae*, connects that family with the *Striges*. No osteological affinity, however, can be established between the harriers and any section of the owls, and the superficial resemblance will have to be explained in some other way. Harriers are found almost all over the world,¹ and

¹ The distribution of the different species is rather curious, while the range of some is exceedingly wide,—one, *C. maillardi*, seems to be limited to the island of Réunion (Bourbon).

fifteen species are recognized by Bowdler Sharge (*Cat. Birds Brit. Museum*, i. pp. 50-73). In most if not all the harriers the sexes differ greatly in colour, so much so that for a long while the males and females of one of the commonest and best known, the *C. cyaneus* above mentioned, were thought to be distinct species, and were or still are called in various European languages by different names. The error was maintained with the greater persistency since the young males, far more abundant than the adults, wear much the same plumage as their mother, and it was not until after Montagu's observations were published at the



Hen-Harrier (Male and Female).

beginning of the 19th century that the "ringtail," as she was called (the *Falco pygargus* of Linnaeus), was generally admitted to be the female of the "hen-harrier." But this was not Montagu's only good service as regards this genus. He proved the hitherto unexpected existence of a second species,² subject to the same diversity of plumage. This was called by him the ash-coloured falcon, but it now generally bears his name, and is known as Montagu's harrier, *C. cineraceus*. In habits it is very similar to the hen-harrier, but it has longer wings, and its range is not so northerly, for while the hen-harrier extends to Lapland, Montagu's is but very rare in Scotland, though in the south of England it is the most common species. Harriers indeed in the British Islands are rapidly becoming things of the past. Their nests are easily found, and the birds when nesting are easily destroyed. In the south-east of Europe, reaching also to the Cape of Good Hope and to India, there is a fourth species, the *C. swainsoni* of some writers, the *C. pallidus* of others. In North America *C. cyaneus* is represented by a kindred form, *C. hudsonius*, usually regarded as a good species, the adult male of which is always to be recognized by its rufous markings beneath, in which character it rather resembles *C. cineraceus*, but it has not the long wings of that species. South America has in *C. cinereus* another representative form, while China, India and Australia possess more of this type. Thus there is a section in which the males have a strongly contrasted black and grey plumage, and finally there is a group of larger forms allied to the European *C. aeruginosus*, wherein a grey dress is less often attained, of which the South African *C. ranivorus* and the New Zealand *C. gouldi* are examples. (A. N.)

HARRIGAN, EDWARD (1845-), American actor, was born in New York of Irish parents on the 26th of October 1845. He made his first appearance in San Francisco in 1867, and soon afterwards formed a stage partnership with Tony Hart, whose real name was Anthony Cannon. As "Harrigan and Hart," they had a great success in the presentation of types of low life in New York. Beginning as simple sketches, these were gradually worked up into plays, with occasional songs, set to popular music

² A singular mistake, which has been productive of further error, was made by Albin, who drew his figure (*Hist. Birds*, ii. pl. 5) from a specimen of one species, and coloured it from a specimen of another.

by David Braham. The titles of these plays indicate their character, *The Mulligan Guards*, *Squatter Sovereignty*, *A Leather Patch*, *The O'Regans*. The partnership with Hart lasted from 1871-1884. Subsequently Harrigan played in different cities of the United States, one of his favourite parts being George Coggs-well in *Old Lavender*.

HARRIMAN, EDWARD HENRY (1848-1900), American financier and railroad magnate, son of the Rev. Orlando Harriman, rector of St. George's Episcopal church, Hempstead, L.I., was born at Hempstead on the 25th of February 1848. He became a broker's clerk in New York at an early age, and in 1870 was able to buy a seat on the New York Stock Exchange on his own account. For a good many years there was nothing sensational in his success, but he built up a considerable business connexion and prospered in his financial operations. Meanwhile he carefully mastered the situation affecting American railways. In this respect he was assisted by his friendship with Mr Stuyvesant Fish, who, on becoming vice-president of the Illinois Central in 1883, brought Harriman upon the directorate, and in 1887, being then president, made Harriman vice-president; twenty years later it was Harriman who dominated the finance of the Illinois Central, and Fish, having become his opponent, was dropped from the board. It was not till 1898, however, that his career as a great railway organizer began with his formation, by the aid of the bankers, Kuhn, Loeb & Co., of a syndicate to acquire the Union Pacific line, which was then in the hands of a receiver and was generally regarded as a hopeless failure. It was soon found that a new power had arisen in the railway world. Having brought the Union Pacific out of bankruptcy into prosperity, and made it an efficient instead of a decaying line, he utilized his position to draw other lines within his control, notably the Southern Pacific in 1901. These extensions of his power were not made without friction, and his abortive contest in 1901 with James J. Hill for the control of the Northern Pacific led to one of the most serious financial crises ever known on Wall Street. But in the result he became the dominant factor in American railway matters. At his death, on the 9th of September 1900, his influence was estimated to extend over 60,000 m. of track, with an annual earning power of \$700,000,000 or over. Astute and unscrupulous manipulation of the stock markets, and a capacity for the hardest of bargaining and the most determined warfare against his rivals, had their place in this success, and Harriman's methods excited the bitterest criticism, culminating in a stern denunciation from President Roosevelt himself in 1907. Nevertheless, besides acquiring colossal wealth for himself, he helped to create for the American public a vastly improved railway service, the benefit of which survived all controversy as to the means by which he triumphed over the obstacles in his way.

HARRIMAN, a city of Roane county, Tennessee, U.S.A., on the Emory river, about 35 m. W. by S. of Knoxville. Pop. (1900) 3442 (516 being negroes); (1910) 3061. Harriman is served by the Harriman & North Eastern, the Tennessee Central, and the Southern railways. It is the seat of the East Tennessee Normal and Industrial Institute, for negroes, and of the American University of Harriman (Christian Church, coeducational; 1893), which comprises primary, preparatory, collegiate, Bible school, civic research, commercial, music and art departments, and in 1907-1908 had 12 instructors and 317 students. Near the city are large deposits of iron and an abundance of coal and timber. Among manufactures are cotton products, farming tools, leather, tannic acid, furniture and flour. Harriman was founded in 1890 by a land company. A clause in this company's by-laws requires that every conveyance of real estate by the company "shall contain a provision forbidding the use of the property or any building thereon, for the purpose of making, storing or selling intoxicating beverages as such." Harriman was chartered as a city in 1891, and its charter was revised in 1899.

HARRINGTON, EARLS OF. The first earl of Harrington was the diplomatist and politician, William Stanhope (c. 1600-1756), a younger son of John Stanhope of Elvaston, Derbyshire, and a brother of Charles Stanhope (1673-1760), an active

politician during the reign of George I. His ancestor, Sir John Stanhope (d. 1638), was a half-brother of Philip Stanhope, 1st earl of Chesterfield. Educated at Eton, William Stanhope entered the army and served in Spain, but soon he turned his attention to more peaceful pursuits, went on a mission to Madrid and represented his country at Turin. When peace was made between England and Spain in 1720 Stanhope became British ambassador to the latter country, and he retained this position until March 1727, having built up his reputation as a diplomatist during a difficult period. In 1729 he had some part in arranging the treaty of Seville between England, France and Spain, and for his services in this matter he was created Baron Harrington in January 1730. Later in the same year he was appointed secretary of state for the northern department under Sir Robert Walpole, but, like George II., he was anxious to assist the emperor Charles VI. in his war with France, while Walpole favoured a policy of peace. Although the latter had his way Harrington remained secretary until the great minister's fall in 1742, when he was transferred to the office of president of the council and was created earl of Harrington and Viscount Petersham. In 1744, owing to the influence of his political allies, the Pelhams, he returned to his former post of secretary of state, but he soon lost the favour of the king, and this was the principal cause why he left office in October 1746. He was lord lieutenant of Ireland from 1747 to 1751, and he died in London on the 8th of December 1756.

The earl's successor was his son, William (1719-1779), who entered the army, was wounded at Fontenoy and became a general in 1770. He was a member of parliament for about ten years and he died on the 1st of April 1779. This earl's wife Caroline (1722-1784), daughter of Charles Fitzroy, 2nd duke of Grafton, was a noted beauty, but was also famous for her eccentricities. Their elder son, Charles (1753-1829), who became the 3rd earl, was a distinguished soldier. He served with the British army during the American War of Independence and attained the rank of general in 1802. From 1805 to 1812 he was commander-in-chief in Ireland; he was sent on diplomatic errands to Vienna and to Berlin, and he died at Brighton on the 15th of September 1829.

Charles Stanhope, 4th earl of Harrington (1780-1851), the eldest son of the 3rd earl, was known as Lord Petersham until he succeeded to the earldom in 1829. He was very well known in society owing partly to his eccentric habits; he dressed like the French king Henry IV., and had other personal peculiarities. He married the actress, Maria Foote, but when he died in March 1851 he left no sons, and his brother Leicester Fitzgerald Charles (1784-1862) became the 5th earl. This nobleman was a soldier and a politician of advanced views, who is best known as a worker with Lord Byron in the cause of Greek independence. He was in Greece in 1823 and 1824, where his relations with Byron were not altogether harmonious. He wrote *A Sketch of the History and Influence of the Press in British India* (1823); and *Greece in 1823 and 1824* (English edition 1824, American edition 1825). His son Sydney Seymour Hyde, 6th earl (1845-1866), dying unmarried, was succeeded by a cousin, Charles Wyndham Stanhope (1809-1881), as 7th earl, and in 1881 the latter's son Charles Augustus Stanhope (b. 1844) became 8th earl of Harrington.

Before the time of the first earl of Harrington the Stanhope family had held the barony of Stanhope of Harrington, which was created in 1605 in favour of Sir John Stanhope (c. 1550-1621) of Harrington, Northamptonshire. Sir John was a younger son of Sir Michael Stanhope (d. 1552) of Shelford, Nottinghamshire, who was a brother-in-law of the protector Somerset. Sir Michael's support of Somerset cost him his life, as he was beheaded on the 26th of February 1552. Sir John was treasurer of the chamber from 1596 to 1616 and was a member of parliament for several years. He died on the 9th of March 1621, and when his only son Charles, 2nd baron (c. 1595-1675), died without issue in 1675 the barony became extinct.

HARRINGTON, or HARINGTON, JAMES (1611-1677), English political philosopher, was born in January 1611 of an old Rutlandshire family. He was son of Sir Sapcotes Harrington of Rand, Lincolnshire, and great-nephew of the first Lord Harrington of Exton (d. 1615). In 1629 he entered Trinity College, Oxford, as

a gentleman commoner. One of his tutors was the famous Chillingworth. After several years spent in travel, and as a soldier in the Dutch army, he returned to England and lived in retirement till 1646, when he was appointed to the suite of Charles I., at that time being conveyed from Newcastle as prisoner. Though republican in his ideas, Harrington won the king's regard and esteem, and accompanied him to the Isle of Wight. He roused, however, the suspicion of the parliamentarians and was dismissed: it is said that he was for a short time put in confinement because he would not swear to refuse assistance to the king should he attempt to escape. After Charles's death Harrington devoted his time to the composition of his *Oceana*, a work which pleased neither party. By order of Cromwell it was seized when passing through the press. Harrington, however managed to secure the favour of the Protector's favourite daughter, Mrs Claypole; the work was restored to him, and appeared in 1656, dedicated to Cromwell. The views embodied in *Oceana*, particularly that bearing on vote by ballot and rotation of magistrates and legislators, Harrington and others (who in 1659 formed a club called the "Rota") endeavoured to push practically, but with no success. In November 1661, by order of Charles II., Harrington was arrested, apparently without sufficient cause, on a charge of conspiracy, and was thrown into the Tower. Despite his repeated request no public trial could be obtained, and when at length his sisters obtained a writ of *habeas corpus* he was secretly removed to St Nicholas Island off Plymouth. There his health gave way owing to his drinking guaiacum on medical advice, and his mind appeared to be affected. Careful treatment restored him to bodily vigour, but his mind never wholly recovered. After his release he married,—at what date does not seem to be precisely known. He died on the 11th of September 1677, and was buried next to Sir Walter Raleigh in St Margaret's, Westminster.

Harrington's writings consist of the *Oceana*, and of papers, pamphlets, aphorisms, even treatises, in defence of the *Oceana*. The *Oceana* is a hard, prolix, and in many respects heavy exposition of an ideal constitution, "*Oceana*" being England, and the lawgiver Olphaus Mogaletor, Oliver Cromwell. The details are elaborated with infinite care, even the salaries of officials being computed, but the main ideas are two in number, each with a practical corollary. The first is that the determining element of power in a state is property generally, property in land in particular; the second is that the executive power ought not to be vested for any considerable time in the same men or class of men. In accordance with the first of these, Harrington recommends an agrarian law, limiting the portion of land held to that yielding a revenue of £3000, and consequently insisting on particular modes of distributing landed property. As a practical issue of the second he lays down the rule of rotation by ballot. A third part of the executive or senate are voted out by ballot every year (not being capable of being elected again for three years). Harrington explains very carefully how the state and its governing parts are to be constituted by his scheme. *Oceana* contains many valuable ideas, but it is irretrievably dull.

His *Works* were edited with biography by John Toland in 1700; Toland's edition, with additions by Birch, appeared in 1747, and again in 1771. *Oceana* was reprinted by Henry Morley in 1887. See Dwight in *Political Science Quarterly* (March, 1887). Harrington has often been confused with his cousin Sir James Harrington, a member of the commission which tried Charles I., and afterwards excluded from the acts of pardon.

HARRIOT, or HARRIOTT, THOMAS (1560—1621), English mathematician and astronomer, was born at Oxford in 1560. After studying at St Mary Hall, Oxford, he became tutor to Sir Walter Raleigh, who appointed him in 1585 to the office of geographer to the second expedition to Virginia. Harriot published an account of this expedition in 1588, which was afterwards reprinted in Hakluyt's *Voyages*. On his return to England, after an absence of two years, he resumed his mathematical studies, and having made the acquaintance of Henry Percy, earl of Northumberland, distinguished for his patronage of men of science, he received from him a yearly pension of £120. He died at London on the 2nd of July 1621. A manuscript of

Harriot's entitled *Ephemeris chrysemetrica* is preserved in Sion College; and his *Artis analyticae praxis ad aequationes algebraicas resolvendas* was published at London in 1631. His contributions to algebra are treated in the article ALGEBRA; Wallis's *History of Algebra* (1685) may also be consulted. From some papers of Harriot's, discovered in 1784, it would appear that he had either procured a telescope from Holland, or divined the construction of that instrument, and that he coincided in point of time with Galileo in discovering the spots on the sun's disk.

See Charles Hutton, *Mathematical and Philosophical Dictionary* (1815), and J. E. Montucla, *Histoire des mathématiques* (1758).

HARRIS, GEORGE, 1ST BARON (1746—1829), British general, was the son of the Rev George Harris, curate of Brasted, Kent, and was born on the 18th of March 1746. Educated at Westminster school and at the Royal Military Academy, Woolwich, he was commissioned to the Royal Artillery in 1760, transferring to an ensigny in the 5th foot (Northumberland Fusiliers) in 1762. Three years later he became lieutenant, and in 1771 captain. His first active service was in the American War of Independence, in which he served at Lexington, Bunker Hill (severely wounded) and in every engagement of Howe's army except one up to November 1778. By this time he had obtained his majority, and his next service was under Major-General Medows at Santa Lucia in 1778—1779, after which his regiment served as marines in Rodney's fleet. Later in 1779 he was for a time a prisoner of war. Shortly before his promotion to lieutenant-colonel in his regiment (1780) he married. After commanding the 5th in Ireland for some years, he exchanged and went with General Medows to Bombay, and served with that officer in India until 1792, taking part in various battles and engagements, notably Lord Cornwallis's attack on Seringapatam. In 1794, after a short period of home service, he was again in India. In the same year he became major-general, and in 1796 local lieutenant-general in Madras. Up to 1800 he commanded the troops in the presidency, and for a short time he exercised the civil government as well. In December 1798 he was appointed by Lord Wellesley, the governor-general, to command the field army which was intended to attack Tipu Sahib, and in a few months Harris reduced the Mysore country and stormed the great stronghold of Seringapatam. His success established his reputation as a capable and experienced commander, and its political importance led to his being offered the reward (which he declined) of an Irish peerage. He returned home in 1800, became lieutenant-general in the army the following year, and attained the rank of full general in 1812. In 1815 he was made a peer of the United Kingdom under the title Baron Harris of Seringapatam and Mysore, and of Belmont, Kent. In 1820 he received the G.C.B., and in 1824 the governorship of Dumbarton Castle. Lord Harris died at Belmont in May 1829. He had been colonel of the 73rd Highlanders since 1800.

His descendant, the 4th Baron Harris (b. 1851), best known as a cricketer, was under-secretary for India (1885—1886), under-secretary for war (1886—1889) and governor of Bombay (1890—1895).

See Rt. Hon. S. Lushington, *Life of Lord Harris* (London, 1840), and the regimental histories of the 5th Northumberland Fusiliers and 73rd Highlanders.

HARRIS, JAMES (1700—1780), English grammarian, was born at Salisbury on the 20th of July 1700. He was educated at the grammar school in the Close at Salisbury, and at Wadham College, Oxford. On leaving the university he was entered at Lincoln's Inn as a student of law, though not intended for the bar. The death of his father in 1733 placed him in possession of an independent fortune and of the house in Salisbury Close. He became a county magistrate, and represented Christchurch in parliament from 1761 till his death, and was comptroller to the queen from 1774 to 1780. He held office under Lord Grenville, retiring with him in 1765. The decided bent of his mind had always been towards the Greek and Latin classics; and to the study of these, especially of Aristotle, he applied himself with unremitting assiduity during a period of fourteen or fifteen

years. He published in 1744 three treatises—on art; on music, painting and poetry; and on happiness. In 1751 appeared the work by which he became best known, *Hermes*, a philosophical inquiry concerning universal grammar. He also published *Philosophical Arrangements* and *Philosophical Inquiries*. Harris was a great lover of music, and adapted the words for a selection from Italian and German composers, published by the cathedral organist, James Corfe. He died on the 22nd of December 1780.

His works were collected and published in 1801, by his son, the first earl of Malmesbury, who prefixed a brief biography.

HARRIS, JOEL CHANDLER (1848–1908), American author, was born in Eatonton, Putnam county, Georgia, on the 8th of December 1848. He started as an apprentice to the printer's trade in the office of the *Countryman*, a weekly paper published on a plantation not far from his home. He then studied law, and practised for a short time in Forsyth, Ga., but soon took to journalism. He joined the staff of the *Savannah Daily News* in 1871, and in 1876 that of the *Atlanta Constitution*, of which he was an editor from 1890 to 1901, and in this capacity did much to further the cause of the New South. But his most distinctive contribution to this paper, and to American literature, consisted of his dialect pieces dealing with negro life and folklore. His stories are characterized by quaint humour, poetic feeling and homely philosophy; and "Uncle Remus," the principal character of most of them, is a remarkably vivid and real creation. The first collection of his stories was published in 1880 as *Uncle Remus: his Songs and his Sayings*. Among his later works are *Nights with Uncle Remus* (1883), *Mingo and Other Sketches in Black and White* (1884), *Free Joe and Other Georgian Sketches* (1887), *Balaam and His Master and Other Sketches and Stories* (1891), *Uncle Remus and His Friends* (1892), *On the Plantation* (1892), which is partly autobiographical, *Sister Jane* (1896), *The Chronicles of Aunt Minerva Ann* (1899), and *The Tar-Baby and Other Rhymes of Uncle Remus* (1904). More purely juvenile are *Daddy Jake the Runaway and Other Stories* (1889), *Little Mr Thimblefinger and his Queer Country* (1894) and its sequel *Mr Rabbit at Home* (1895), *Aaron in the Wildwoods* (1897), *Plantation Pegeants* (1899), *Toid by Uncle Remus* (1905), and *Uncle Remus and Br'er Rabbit* (1907). He was one of the compilers of the *Life of Henry W. Grady, including his Writings and Speeches* (1890) and wrote *Stories of Georgia* (1896), and *Georgia from the Invasion of De Soto to Recent Times* (1899). He died in Atlanta on the 3rd of July 1908.

HARRIS, JOHN (c. 1666–1719), English writer. He is best known as the editor of the *Lexicon technicum*, or *Dictionary of the Arts and Sciences* (1704), which ranks as the earliest of the long line of English encyclopaedias, and as the compiler of the *Collection of Voyages and Travels* which passes under his name. He was born about 1666, probably in Shropshire, and was a scholar of Trinity College, Oxford, from 1684 to 1688. He was presented to the vicarage of Icklesham in Sussex, and subsequently to the rectory of St Thomas, Winchelsea. In 1698 he was entrusted with the delivery of the seventh series of the Boyle lectures—*Atheistical Objections against the Being of God and His Attributes fairly considered and fully refuted*. Between 1702 and 1704 he delivered at the Marine Coffee House in Birchin Lane the mathematical lectures founded by Sir Charles Cox, and advertised himself as a mathematical tutor at Amen Corner. The friendship of Sir William Cowper, afterwards lord chancellor, secured for him the office of private chaplain, a prebend in Rochester cathedral (1708), and the rectory of the united parishes of St Mildred, Bread Street and St Margaret Moses, in addition to other preferments. He showed himself an ardent supporter of the government, and engaged in a bitter quarrel with the Rev. Charles Humphreys, who afterwards was chaplain to Dr Sacheverel. Harris was one of the early members of the Royal Society, and for a time acted as vice-president. At his death on the 7th of September 1719, he was busy completing an elaborate *History of Kent*. He is said to have died in poverty brought on by his own bad management of his affairs.

HARRIS, THOMAS LAKE (1823–1906), American spiritualistic "prophet," was born at Fenny Stratford in Buckinghamshire, England, on the 15th of May 1823. His parents were Calvinistic Baptists, and very poor. They settled at Utica, New York, when Harris was five years old. When he was about twenty Harris became a Universalist preacher, and then a Swedenborgian. He became associated about 1847 with a spiritualist of indifferent character named Davis. After Davis had been publicly exposed, Harris established a congregation in New York. About 1850 he professed to receive inspirations, and published some long poems. He had the gift of improvisation in a very high degree. About 1859 he preached in London, and is described as a man "with low, black eyebrows, black beard, and sallow countenance." He was an effective speaker, and his poetry was admired by many; Alfred Austin in his book *The Poetry of the Period* even devoted a chapter to Harris. He founded in 1861 a community at Wassaic, New York, and opened a bank and a mill, which he superintended. There he was joined by about sixty converts, including five orthodox clergymen, some Japanese people, some American ladies of position, and especially by Laurence Oliphant (*q.v.*) with his wife and mother. The community—the Brotherhood of the New Life—decided to settle at the village of Brocton on the shore of Lake Erie. Harris established there a wine-making industry. In reply to the objections of tectotallers he said that the wine prepared by himself was filled with the divine breath so that all noxious influences were neutralized. Harris also built a tavern and strongly advocated the use of tobacco. He exacted complete surrender from his disciples—even the surrender of moral judgment. He taught that God was bi-sexual, and apparently, though not in reality, that the rule of society should be one of married celibacy. He professed to teach his community a change in the mode of respiration which was to be the visible sign of possession by Christ and the seal of immortality. The Oliphants broke away from the restraint about 1881, charging him with robbery and succeeding in getting back from him many thousands of pounds by legal proceedings. But while losing faith in Harris himself, they did not abandon his main teaching. In Laurence Oliphant's novel *Masollam* his view of Harris will be found. Briefly, he held that Harris was originally honest, greatly gifted, and possessed of certain psychical powers. But in the end he came to practise unbridled licence under the loftiest pretensions, made the profession of extreme disinterestedness a cloak to conceal his avarice, and demanded from his followers a blind and supple obedience. Harris in 1876 discontinued for a time public activities, but issued to a secret circle books of verse dwelling mainly on sexual questions. On these his mind ran from the first. In 1891 he announced that his body had been renewed, and that he had discovered the secret of the resuscitation of humanity. He published a book, *Lyra triumphalis*, dedicated to A. C. Swinburne. He also made a third marriage, and visited England intending to remain there. He was called back by a fire which destroyed large stocks of his wine, and remained in New York till 1903, when he visited Glasgow. His followers believed that he had attained the secret of immortal life on earth, and after his death on the 23rd of March 1906 declared that he was only sleeping. It was three months before it was acknowledged publicly that he was really dead. There can be little or no doubt as to the real character of Harris. His teaching was esoteric in form, but is a thinly veiled attempt to alter the ordering of sexual relations.

The authoritative biography from the side of his disciples is the *Life* by A. A. Cuthbert, published in Glasgow in 1908. It is full of the jargon of Harris's sect, but contains some biographical facts as well as many quotations. Mrs Oliphant's *Life of Laurence Oliphant* (1891) has not been shaken in any important particular, and Oliphant's own portrait of Harris in *Masollam* is apparently unexaggerated. But Harris had much personal magnetism, unbounded self-confidence, along with endless fluency, and to the last was believed in by some disciples of character and influence. (W. R. N.)

HARRIS, SIR WILLIAM SNOW (1791–1867), English electrician, was descended from an old family of solicitors at Plymouth, where he was born on the 1st of April 1791. He received his early education at the Plymouth grammar-school,

and completed a course of medical studies at the university of Edinburgh, after which he established himself as a general medical practitioner in Plymouth. On his marriage in 1824 he resolved to abandon his profession on account of its duties interfering too much with his favourite study of electricity. As early as 1820 he had invented a new method of arranging the lightning conductors of ships, the peculiarity of which was that the metal was permanently fixed in the masts and extended throughout the hull; but it was only with great difficulty, and not till nearly thirty years afterwards, that his invention was adopted by the government for the royal navy. In 1826 he read a paper before the Royal Society "On the Relative Powers of various Metallic Substances as Conductors of Electricity," which led to his being elected a fellow of the society in 1831. Subsequently, in 1834, 1836 and 1839, he read before the society several valuable papers on the elementary laws of electricity, and he also communicated to the Royal Society of Edinburgh various interesting accounts of his experiments and discoveries in the same field of inquiry. In 1835 he received the Copley gold medal from the Royal Society for his papers on the laws of electricity of high tension, and in 1839 he was chosen to deliver the Bakerian lecture. Meanwhile, although a government commission had recommended the general adoption of his conductors in the royal navy, and the government had granted him an annuity of £300 "in consideration of services in the cultivation of science," the naval authorities continued to offer various objections to his invention; to aid in removing these he in 1843 published his work on *Thunderstorms*, and also about the same time contributed a number of papers to the *Nautical Magazine* illustrative of damage by lightning. His system was actually adopted in the Russian navy before he succeeded in removing the prejudices against it in England, and in 1845 the emperor of Russia, in acknowledgment of his services, presented him with a valuable ring and vase. At length, the efficiency of his system being acknowledged, he received in 1847 the honour of knighthood, and subsequently a grant of £5000. After succeeding in introducing his invention into general use Harris resumed his labours in the field of original research, but as he failed to realize the advances that had been made by the new school of science his application resulted in no discoveries of much value. His manuals of *Electricity*, *Galvanism* and *Magnetism*, published between 1848 and 1856, were, however, written with great clearness, and passed through several editions. He died at Plymouth on the 22nd of January 1867, while having in preparation a *Treatise on Frictional Electricity*, which was published posthumously in the same year, with a memoir of the author by Charles Tomlinson.

HARRIS, WILLIAM TORREY (1835-1909), American educationist, was born in North Killingly, Connecticut, on the 10th of September 1835. He studied at Phillips Andover Academy, Andover, Massachusetts, and entered Yale, but left in his junior year (1857) to accept a position as a teacher of shorthand in the St Louis, Missouri, public schools. Advancing through the grades of principal and assistant superintendent, he was city superintendent of schools from 1867 until 1880. In 1858, under the stimulus of Henry C. Brockmeyer, Harris became interested in modern German philosophy in general, and in particular in Hegel, whose works a small group, gathering about Harris and Brockmeyer, began to study in 1859. From 1867 to 1893 Harris edited *The Journal of Speculative Philosophy* (22 vols.), which was the quarterly organ of the Philosophical Society founded in 1866. The Philosophical Society died out before 1874, when Harris founded in St Louis a Kant Club, which lived for fifteen years. In 1873, with Miss Susan E. Blow, he established in St Louis the first permanent public-school kindergarten in America. He represented the United States Bureau of Education at the International Congress of Educators at Brussels in 1880. In 1889 he represented the United States Bureau of Education at the Paris Exposition, and from 1889 to 1906 was United States commissioner of education. In 1899 the university of Jena gave him the honorary degree of Doctor of Philosophy for his work on Hegel. In 1906

the Carnegie Foundation for the Advancement of Teaching conferred upon him "as the first man to whom such recognition for meritorious service is given, the highest retiring allowance which our rules will allow, an annual income of \$3000." Besides being a contributor to the magazines and encyclopedias on educational and philosophical subjects, he wrote *An Introduction to the Study of Philosophy* (1889); *The Spiritual Sense of Dante's Divina Commedia* (1889); *Hegel's Logic* (1890); and *Psychologic Foundations of Education* (1898); and edited Appleton's *International Education Series* and Webster's *International Dictionary*. He died on the 5th of November 1909.

See Henry R. Evans, "A List of the Writings of William Torrey Harris" in the *Report of the Commissioner of Education for 1907*, vol. i. (Washington, 1908).

HARRISBURG, the capital of Pennsylvania, U.S.A.; and the county-seat of Dauphin county, on the E. bank of the Susquehanna river, about 105 m. W. by N. of Philadelphia. Pop. (1890), 39,385; (1900), 50,167, of whom 2493 were foreign-born and 4107 were negroes; (1910 census) 64,186. It is served by the Pennsylvania, the Philadelphia & Reading, the Northern Central and the Cumberland Valley railways; and the Pennsylvania canal gives it water communication with the ocean. The river here is a mile wide, and is ordinarily very shallow and dotted with islets, but rises from 4 to 6 ft. after a moderate rain; it is spanned by several bridges.

The city lies for the most part on the E. slope of a hill extending from the river bank, several feet in height, across the Pennsylvania canal to Paxton Creek. Front Street, along the river, is part of a parkway connecting the park system with which the city is encircled. Overlooking it are the finest residences, among them the governor's mansion. State Street, 120 ft. in width, runs at right angles with Front Street through the business centre of the city, being interrupted by the Capitol Park (about 16 acres). The Capitol, dedicated in 1906, was erected to replace one burned in 1897; it is a fine building, with a dome modelled after St Peter's at Rome. At the main entrance are bronze doors, decorated in relief with scenes from the state's history; the floor of the rotunda is of tiles made at Doylestown, in the style of the pottery made by early Moravian settlers, and illustrating the state's resources; the Senate Chamber and the House Chamber have stained-glass windows by W. B. van Ingen and mural paintings by Edwin A. Abbey, who painted a series, "The Development of the Law," for the Supreme Court room in the eastern wing and decorated the rotunda. The mural decorations of the south corridor, by W. B. van Ingen, portray the state's religious sects; those in the north corridor, by John W. Alexander, represent the changes in the physical and material character of the state; and there is a frieze by Miss Violet Oakley, "The Founding of the State of Liberty Spiritual," in the governor's reception room. Two heroic groups of statuary for the building were designed by George Grey Barnard. The state library in the Capitol contains about 150,000 volumes. In the same park is also a monument 105 ft. high erected in

1 For this building the legislature in 1901 appropriated \$4,000,000, stipulating that it should be completed before the 1st of January 1907. It was completed by that time, the net expenditure of the building commission being about \$3,970,000. Although the legislature had made no provision for furniture and decoration, the state Board of Public Grounds and Buildings (governor, auditor-general and treasurer) undertook to complete the furnishing and decoration of the building within the stipulated time, and paid out for that purpose more than \$8,600,000. In May 1906 a new treasurer entered office, who discovered that many items for furniture and decoration were charged twice, once at a normal and again at a remarkably high figure. In 1907 the legislature appointed a committee to investigate the charge of fraud. The committee's decision was that the Board of Grounds and Buildings was not authorized to let the decorating and furnishing of the state house; that it had illegally authorized certain expenditures; and that architect and contractors had made fraudulent invoices and certificates. Various indictments were found: in the first trial for conspiracy in the making and delivering of furniture the contractor and the former auditor-general, state treasurer and superintendent of public grounds and buildings were convicted and in December 1908 were sentenced to two years' imprisonment and fined \$500 each; in 1910 a suit was brought for the recovery of about \$5,000,000 from those responsible.

HARRISMITH—HARRISON, BENJAMIN

1868 to the memory of the soldiers who fell in the Mexican War; it has a column of Maryland marble 76 ft. high, which is surmounted by an Italian marble statue of Victory, executed in Rome. At the base of the monument are muskets used by United States soldiers in that war and guns captured at Cerro Gordo. In State Street is the Dauphin County Soldiers' monument, a shaft 10 ft. sq. at the base and 110 ft. high, with a pyramidal top.

For several years prior to 1902 Harrisburg suffered much from impure water, a bad sewerage system, and poorly paved and dirty streets. In that year, however, a League for Municipal Improvements was formed; in February 1902 a loan of \$1,000,000 for municipal improvements was voted, landscape gardeners and sewage engineers were consulted, and a non-partisan mayor was elected, under whom great advances were made in street cleaning and street paving, a new filtration plant was completed, the river front was beautified and protected from flood, sewage was diverted from Paxton Creek, and the development of an extensive park system was undertaken.

Harrisburg's charitable institutions include a city hospital, a home for the friendless, a children's industrial home, and a state lunatic hospital (1845). The city is the seat of a Roman Catholic bishopric. Both coal and iron ore abound in the vicinity, and the city has numerous manufacturing establishments. The value of its factory products in 1905 was \$17,146,338 (14.3% more than in 1900), the more important being those of steel works and rolling mills (\$4,528,907), blast furnaces, steam railway repair shops, cigar and cigarette factories (\$1,258,498), foundries and machine shops (\$953,617), boot and shoe factories (\$922,568), flouring and grist mills, slaughtering and meat-packing establishments and silk mills.

Harrisburg was named in honour of John Harris, who, upon coming into this region to trade early in the 18th century, was attracted to the site as an easy place at which to ford the Susquehanna, and about 1726 settled here. He was buried in what is now Harris Park, where he erected the first building, a small hut, within the present limits of Harrisburg. In 1753 his son established a ferry over the river, and the place was called Harris's Ferry until 1785, when the younger Harris laid out the town and named it Harrisburg. In the same year it was made the county-seat of the newly constituted county of Dauphin, and its name was changed to Louisburg; but when, in 1791, it was incorporated as a borough, the present name was again adopted. In 1812, after an effort begun twenty-five years before, it was made the capital of the state; and in 1860 it was chartered as a city. In the summer of 1827, through the persistent efforts of persons most interested in the woollen manufactures of Massachusetts and other New England states to secure legislative aid for that industry, a convention of about 100 delegates—manufacturers, newspaper men and politicians—was held in Harrisburg, and the programme adopted by the convention did much to bring about the passage of the famous high tariff act of 1828.

HARRISMITH, a town in the Orange Free State, 60 m. N.W. by rail of Ladysmith, Natal, and 240 m. N.E. of Bloemfontein via Bethlehem. Pop. (1904) 8300 (including troops 1921). It is built on the banks of the Wilge, 5250 ft. above the sea and some 20 m. W. of the Drakensberg. Three miles N. is the Platberg, a table-shaped mountain rising 2000 ft. above the town, whence an excellent supply of water is derived. The town is well laid out and several of the streets are lined with trees. Most of the houses are built of white stone quarried in the neighbourhood. The Kaffirs, who numbered in 1904 3483, live in a separate location. Harrismith has a dry, bracing climate and enjoys a high reputation in South Africa as a health resort. It serves one of the best-watered and most fertile agricultural and pastoral districts of the province, of which it is the chief eastern trading centre. Wool and hides are the principal exports.

Harrismith was founded in 1849, the site first chosen being on the Elands river, where the small town of Aberfeldig now is; but the advantages of the present site soon became apparent and the settlement was removed. The founders were Sir Harry Smith (after whom the town is named), then governor of Cape

Colony, and Major Henry D. Warden, at that time British resident at Bloemfontein, whose name is perpetuated in that of the principal street. In a cave about 2 m. from the town are well-preserved Bushman paintings.

HARRISON, BENJAMIN (1833-1901), the twenty-third president of the United States, was born at North Bend, near Cincinnati, Ohio, on the 20th of August 1833. His great-grandfather, Benjamin Harrison of Virginia (c. 1740-1791), was a signer of the Declaration of Independence. His grandfather, William Henry Harrison (1773-1841), was ninth president of the United States. His father, John Scott Harrison (1804-1878), represented his district in the national House of Representatives in 1853-1857. Benjamin's youth was passed upon the ancestral farm, and as opportunity afforded he attended school in the log school-house near his home. He was prepared for college by a private tutor, studied for two years at the Farmers' College, near Cincinnati, and in 1852 graduated from Miami University, at that time the leading educational institution in the State of Ohio. From his youth he was diligent in his studies and a great reader, and during his college life showed a marked talent for extemporaneous speaking. He pursued the study of law, partly in the office of Bellamy Storer (1798-1875), a leading lawyer and judge of Cincinnati, and in 1853 he was admitted to the bar. At the age of twenty-one he removed to Indianapolis. He had but one acquaintance in the place, the clerk of the federal court, who permitted him to occupy a desk in his office and place at the door his sign as a lawyer. Waiting for professional business, he was content to act as court crier for two dollars and a half a day; but he soon gave indications of his talent, and his studious habits and attention to his cases rapidly brought him clients. Within a few years he took rank among the leading members of the profession at a bar which included some of the ablest lawyers of the country. His legal career was early interrupted by the Civil War. His whole heart was enlisted in the anti-slavery cause, and during the second year of the war he accepted a commission from the governor of the state as second-lieutenant and speedily raised a regiment. He became its colonel, and as such continued in the Union Army until the close of the war, and on the 23rd of January 1865 was breveted a brigadier-general of volunteers for "ability and manifest energy and gallantry in command of brigade." He participated with his regiment in various engagements during General Don Carlos Buell's campaigns in Kentucky and Tennessee in 1862 and 1863; took part in General W. T. Sherman's march on Atlanta in 1864 and in the Nashville campaign of the same year; and was transferred early in 1865 to Sherman's army in its march through the Carolinas. As the commander of a brigade he served with particular distinction in the battles of Kenesaw Mountain (June 29-July 3, 1864), Peach Tree Creek (20th of July 1864) and Nashville (15th-16th of December 1864).

Allowing for this interval of military service, he applied himself exclusively for twenty-four years to his legal work. The only office he held was that of reporter of the supreme court of Indiana for two terms (1860-1862 and 1864-1868), and this was strictly in the line of his profession. He was a devoted member of the Republican party, but not a politician in the strict sense. Once he became a candidate for governor, in 1876, but his candidature was a forlorn hope, undertaken from a sense of duty after the regular nominee had withdrawn. He took a deep interest in the campaign which resulted in the election of James A. Garfield as president, and was offered by him a place in his cabinet; but this he declined, having been elected a member of the United States Senate, in which he took his seat on the 4th of March 1881. He was chairman of the committee on territories, and took an active part in urging the admission as states of North Dakota, South Dakota, Washington, Idaho and Montana, which finally came into the Union during his presidency. He served also on the committee of military and Indian affairs, the committee on foreign relations and others, was prominent in the discussion of matters brought before the Senate from these committees, advocated the enlargement of the navy and the reform of the civil service, and opposed the

pension veto messages of President Cleveland. Having failed to secure a re-election to the Senate in 1887, Harrison was nominated by the Republican party for the presidency in 1888, and defeated Grover Cleveland, the candidate of the Democratic party, receiving 233 electoral votes to Cleveland's 168. Among the measures and events distinguishing his term as president were the following: The meeting of the Pan-American Congress at Washington; the passage of the McKinley Tariff Bill and of the Sherman Silver Bill of 1890; the suppressing of the Louisiana Lottery; the enlargement of the navy; further advance in civil service reform; the convocation by the United States of an international monetary conference; the establishment of commercial reciprocity with many countries of America and Europe; the peaceful settlement of a controversy with Chile; the negotiation of a Hawaiian Annexation Treaty, which, however, before its ratification, his successor withdrew from the Senate; the settlement of difficulties with Germany concerning the Samoan Islands, and the adjustment by arbitration with Great Britain of the Bering Sea fur-seal question. His administration was marked by a revival of American industries and a reduction of the public debt, and at its conclusion the country was left in a condition of prosperity and on friendly terms with foreign nations. He was nominated by his party in 1892 for re-election, but was defeated by Cleveland, this result being due, at least in part, to the labour strikes which occurred during the presidential campaign and arrayed the labour unions against the tariff party.

After leaving public life he resumed the practice of the law, and in 1898 was retained by the government of Venezuela as its leading counsel in the arbitration of its boundary dispute with Great Britain. In this capacity he appeared before the international tribunal of arbitration at Paris in 1899, worthily maintaining the reputation of the American bar. After the Spanish-American War he strongly disapproved of the colonial policy of his party, which, however, he continued to support. He occupied a portion of his leisure in writing a book, entitled *This Country of Ours* (1897), treating of the organization and administration of the government of the United States, and a collection of essays by him was published posthumously, in 1901, under the title *Views of an Ex-President*. He died at Indianapolis on the 13th of March 1901. Harrison's distinguishing trait of character, to which his success is to be most largely attributed, was his thoroughness. He was somewhat reserved in manner, and this led to the charge in political circles that he was cold and unsympathetic; but no one gathered around him more devoted and loyal friends, and his dignified bearing in and out of office commanded the hearty respect of his countrymen.

President Harrison was twice married; in 1853 to Miss Caroline Lavinia Scott, by whom he had a son and a daughter, and in 1896 to Mrs Mary Scott Lord Dimmock, by whom he had a daughter.

A "campaign" biography was published by Lew Wallace (Philadelphia, 1888), and a sketch of his life may be found in *Presidents of the United States* (New York, 1894), edited by James Grant Wilson.

HARRISON, FREDERIC (1831—), English jurist and historian, was born in London on the 18th of October 1831. Members of his family (originally Leicestershire yeomen) had been lessees of Sutton Place, Guildford, of which he wrote an interesting account (*Annals of an Old Manor House*, 1893). He was educated at King's College school and at Wadham College, Oxford, where, after taking a first-class in *Literae Humaniores* in 1853, he became fellow and tutor. He was called to the bar in 1858, and, in addition to his practice in equity cases, soon began to distinguish himself as an effective contributor to the higher-class reviews. Two articles in the *Westminster Review*, one on the Italian question, which procured him the special thanks of Cavour, the other on *Essays and Reviews*, which had the probably undesigned effect of stimulating the attack on the book, attracted especial notice. A few years later Mr Harrison worked at the codification of the law with Lord Westbury, of whom he contributed an interesting notice to Nash's biography of the chan-

cellor. His special interest in legislation for the working classes led him to be placed upon the Trades Union Commission of 1867-1869; he was secretary to the commission for the digest of the law, 1869-1870; and was from 1877 to 1880 professor of jurisprudence and international law under the council of legal education. A follower of the positive philosophy, but in conflict with Richard Congreve (*q.v.*) as to details, he led the Positivists who split off and founded Newton Hall in 1881, and he was president of the English Positivist Committee from 1880 to 1905; he was also editor and part author of the *Positivist New Calendar of Great Men* (1892), and wrote much on Comte and Positivism. Of his separate publications, the most important are his lives of Cromwell (1888), William the Silent, (1897), Ruskin (1902), and Chatham (1905); his *Meaning of History* (1862; enlarged 1894) and *Byzantine History in the Early Middle Ages* (1900); and his essays on *Early Victorian Literature* (1896) and *The Choice of Books* (1886) are remarkable alike for generous admiration and good sense. In 1904 he published a "romantic monograph" of the 19th century, *Theophano*, and in 1906 a verse tragedy, *Nicephorus*. An advanced and vehement Radical in politics and Progressive in municipal affairs, Mr Harrison in 1886 stood unsuccessfully for parliament against Sir John Lubbock for London University. In 1889 he was elected an alderman of the London County Council, but resigned in 1893. In 1870 he married Ethel Berta, daughter of Mr William Harrison, by whom he had four sons. George Gissing, the novelist, was at one time their tutor; and in 1905 Mr Harrison wrote a preface to Gissing's *Veranilda* (see also Mr Austin Harrison's article on Gissing in the *Nineteenth Century*, September 1906). As a religious teacher, literary critic, historian and jurist, Mr Harrison took a prominent part in the life of his time, and his writings, though often violently controversial on political and social subjects, and in their judgment and historical perspective characterized by a modern Radical point of view, are those of an accomplished scholar, and of one whose wide knowledge of literature was combined with independence of thought and admirable vigour of style. In 1907 he published *The Creed of a Layman, Apologia pro fide mea*, in explanation of his religious position.

HARRISON, JOHN (1693-1776), English horologist, was the son of a carpenter, and was born at Faulby, near Pontefract in Yorkshire, in the year 1693. Thence his father and family removed in 1700 to Barrow in Lincolnshire. Young Harrison at first learned his father's trade, and worked at it for several years, at the same time occasionally making a little money by land-measuring and surveying. The bent of his mind, however, was towards mechanical pursuits. In 1715 he made a clock with wooden wheels, which is in the patent museum at South Kensington, and in 1726 he devised his ingenious "gridiron pendulum," which maintains its length unaltered in spite of variations of temperature (see *CLOCK*). Another invention of his was a recoil clock escapement in which friction was reduced to a minimum, and he was the first to employ the commonly used and effective form of "going ratchet," which is a spring arrangement for keeping the timepiece going at its usual rate during the interval of being wound up.

In Harrison's time the British government had become fully alive to the necessity of determining more accurately the longitude at sea. For this purpose they passed an act in 1713 offering rewards of £10,000, £15,000 and £20,000 to any who should construct chronometers that would determine the longitude within 60, 40 and 30 m. respectively. Harrison applied himself vigorously to the task, and in 1735 went to the Board of Longitude with a watch which he also showed to Edmund Halley, George Graham and others. Through their influence he was allowed to proceed in a king's ship to Lisbon to test it; and the result was so satisfactory that he was paid £500 to carry out further improvements. Harrison worked at the subject with the utmost perseverance, and, after making several watches, went up to London in 1761 with one which he considered almost perfect. His son William was sent on a voyage to Jamaica to test it; and on his return to Portsmouth in 1762, it was found to have lost

only 1 minute 54 seconds. This was surprisingly accurate, as it determined the longitude within 18 m., and Harrison claimed the full reward of £20,000; but though from time to time he received sums on account, it was not till 1773 that he was paid in full. In these watches compensation for changes of temperature was applied for the first time by means of a "compensation-curb," designed to alter the effective length of the balance-spring in proportion to the expansion or contraction caused by variations of temperature. Harrison died in London on the 24th of March 1776. His want of early education was felt by him greatly throughout life. He was unfortunately never able to express his ideas clearly in writing, although in conversation he could give a very precise and exact account of his many intricate mechanical contrivances.

Among his writings were a *Description concerning such Mechanisms as will afford a Nice or True Measurement of Time* (1775), and *The Principles of Mr Harrison's Timekeeper*, published by order of the Commissioners of Longitude (1767).

HARRISON, THOMAS (1606–1660), English parliamentarian, a native of Newcastle-under-Lyme in Staffordshire, the son of a butcher and mayor of that town, was baptized in 1606. He was placed with an attorney of Clifford's Inn, but at the beginning of the war in 1642 he enlisted in Essex's lifeguards, became major in Fleetwood's regiment of horse under the earl of Manchester, was present at Marston Moor, at Naseby, Langport and at the taking of Winchester and Basing, as well as at the siege of Oxford. At Basing Harrison was accused of having killed a prisoner in cold blood. In 1646 he was returned to parliament for Wendover, and served in Ireland in 1647 under Lord Lisle, returning to England in May, when he took the side of the army in the dispute with the parliament and obtained from Fairfax a regiment of horse. In November he opposed the negotiations with the king, whom he styled "a man of blood" to be called to account, and he declaimed against the House of Lords. At the surprise of Lambert's quarters at Appleyby on the 18th of July 1648, in the second civil war, he distinguished himself by his extraordinary daring and was severely wounded. He showed a special zeal in bringing about the trial of the king. Charles was entrusted to his care on being brought up from Hurst Castle to London, and believed that Harrison intended his assassination, but was at once favourably impressed by his bearing and reassured by his disclaiming any such design. Harrison was assiduous in his attendance at the trial, and signed the death-warrant with the fullest conviction that it was his duty. He took part in suppressing the royalist rising in the midlands in May 1649, and in July was appointed to the chief command in South Wales, where he is said to have exercised his powers with exceptional severity. On the 20th of February 1651 he became a member of the council of state, and during Cromwell's absence in Scotland held the supreme military command in England. He failed in stopping the march of the royalists into England at Knutsford on the 16th of August 1651, but after the battle of Worcester he rendered great service in pursuing and capturing the fugitives. Later he pressed on Cromwell the necessity of dismissing the Long Parliament, and it was he who at Cromwell's bidding, on the 20th of April 1653, laid hands on Speaker Lenthall and compelled him to vacate the chair. He was president of the council of thirteen which now exercised authority, and his idea of government appears to have been an assembly nominated by the congregations, on a strictly religious basis, such as Barebone's Parliament which now assembled, of which he was a member and a ruling spirit. Harrison belonged to the faction of Fifth Monarchy men, whose political ideals were entirely destroyed by Cromwell's assumption of the protectorate. He went immediately into violent opposition, was deprived of his commission on the 22nd of December 1653, and on the 3rd of February 1654 was ordered to confine himself to his father's house in Staffordshire. Suspected of complicity in the plots of the anabaptists, he was imprisoned for a short time in September, and on that occasion was sent for by Cromwell, who endeavoured in a friendly manner to persuade him to desist. He, however, incurred the suspicions of the administration afresh, and on the 15th of February 1655 he was

imprisoned in Carisbrooke Castle, being liberated in March 1656, when he took up his residence at Highgate with his family. In April 1657 he was arrested for supposed complicity in Venner's conspiracy, and again once more in February 1658, when he was imprisoned in the Tower. At the Restoration, Harrison, who was excepted from the Act of Indemnity, refused to take any steps to save his life, to give any undertaking not to conspire against the government or to flee. "Being so clear in the thing," he declared, "I durst not turn my back nor step a foot out of the way by reason I had been engaged in the service of so glorious and great a God." He was arrested in Staffordshire in May 1660 and brought to trial on the 11th of October. He made a manly and straightforward defence, pleading the authority of parliament and adding, "May be I might be a little mistaken, but I did it all according to the best of my understanding, desiring to make the revealed will of God in His holy scriptures a guide to me." At his execution, which took place at Charing Cross on the 13th of October 1660, he behaved with great fortitude.

Richard Baxter, who was acquainted with him, describes Harrison as "a man of excellent natural parts for affection and oratory, but not well seen in the principles of his religion; of a sanguine complexion, naturally of such a vivacity, hilarity and alacrity as another man hath when he hath drunken a cup too much, but naturally also so far from humble thoughts of himself that it was his ruin." Cromwell also complained of his excessive eagerness. "Harrison is an honest man and aims at good things, yet from the impatience of his spirit will not wait the Lord's leisure but hurries me on to that which he and all honest men will have cause to repent." Harrison was an eloquent and fluent expounder of the scriptures, and his "raptures" on the field of victory are recorded by Baxter. He was of the chief of those "fiery spirits" whose ardent and emotional religion inspired their political action, and who did wonders during the period of struggle and combat, but who later, in the more sober and difficult sphere of constructive statesmanship, showed themselves perfectly incapable.

Harrison married about 1648 Katherine, daughter and heiress of Ralph Harrison of Highgate in Middlesex, by whom he had several children, all of whom, however, appear to have died in infancy.

See the article on Harrison by C. H. Firth in the *Dict. of Nat. Biog.*; *Life of Harrison* by C. H. Simpkinton (1905); *Notes and Queries*, 9 series, xi, 211.

HARRISON, THOMAS ALEXANDER (1853–), American artist, was born in Philadelphia on the 17th of January 1853. He was a pupil of the Pennsylvania Academy of Fine Arts and of the *École des Beaux-Arts*, Paris, whither he went in 1878, having previously been with a United States government survey expedition on the Pacific coast. Chafing under the restraints of the schools, he went into Brittany, and at Pont Aven and Carnac turned his attention to marine painting and landscape. In 1882 he sent a figure-piece to the Salon, a fisher boy on the beach, which he called "Châteaux en Espagne." This attracted attention, and in 1885 he received an honourable mention, the first of many awards conferred upon him, including the Temple gold medal (Pennsylvania Academy of Fine Arts, Philadelphia, 1887), first medal, Paris Exhibition (1889), and medals in Munich, Brussels, Ghent, Vienna and elsewhere. He became a member of the Legion of Honour and *officier* of Public Instruction, Paris; a member of the *Société Nationale des Beaux-Arts*, Paris; of the Royal Institute of Painters in Oil Colours, London; of the Secession societies of Munich, Vienna and Berlin; of the National Academy of Design, the Society of American Artists, New York, and other art bodies. In the Salon of 1885 he had a large canvas of several nude women, called "In Arcady," a remarkable study of flesh tones in light and shade which had a strong influence on the younger men of the day. But his reputation rests rather on his marine pictures, long waves rolling in on the beach, and great stretches of open sea under poetic conditions of light and colour.

His brother, **BIRCE HARRISON** (1854–), also a painter, particularly successful in snow scenes, was a pupil of the *École*

des Beaux Arts, Paris, under Cabanel and Carolus Duran; his "November" (honourable mention, 1882) was purchased by the French government. Another brother, BUTLER HARRISON (d. 1886), was a figure painter.

HARRISON, WILLIAM (1534-1593), English topographer and antiquary, was born in London on the 18th of April 1534. He was educated, according to his own account, at St Paul's school and at Westminster under Alexander Nowell. In 1551 he was at Cambridge, but he took his B.A. degree from Christ Church, Oxford, in 1560. He was inducted early in 1559 to the rectory of Radwinter, Essex, on the presentation of Sir William Brooke, Lord Cobham, to whom he had formerly acted as chaplain; and from 1571 to 1581 he held from another patron, Francis de la Wood, the living of Wimbish in the same county. He became canon of Windsor in 1586, and his death and burial are noted in the chapter book of St George's chapel on the 24th of April 1593.

His famous and amusing *Description of England* was undertaken for the queen's printer, Reginald Wolfe, who designed the publication of "an universall cosmographie of the whole world . . . with particular histories of every knowne nation." After Wolfe's death in 1576 this comprehensive plan was reduced to descriptions and histories of England, Scotland and Ireland. The historical section was to be supplied by Raphael Holinshed, the topographical by Harrison. The work was eventually published as *The Chronicles of England, Scotland and Ireland* . . . by Raphael Holinshed and others, and was printed in two black-letter folio volumes in 1577. Harrison's *Description of England*, humbly described as his "foule frizeled treatise," and dedicated to his patron Cobham, is an invaluable survey of the condition of England under Elizabeth, in all its political, religious and social aspects. Harrison is a minute and careful observer of men and things, and his descriptions are enlivened with many examples of a lively and caustic humour which makes the book excellent reading. In spite of his Puritan prejudices, which lead him to regret that the churches had not been cleared of their "pictures in glass" ("by reason of the extreme cost thereof"), and to exhaust his wit on the effeminate Italian fashions of the younger generation, he had an eye for beauty and is loud in his praise of such architectural gems as Henry VII.'s chapel at Westminster. He is properly contemptuous of the snobbery that was even then characteristic of English society; but his account of "how gentlemen are made in England" must be read in full to be appreciated. He is especially instructive on the condition and services of the Church immediately after the Reformation; notably in the fact that, though an ardent Protestant, he is quite unconscious of any breach of continuity in the life and organization of the Church of England.

Harrison also contributed the translation from Scots into English of Bellenden's version of Hector Boëce's Latin *Description of Scotland*. His other works include a "Chronologic," giving an account of events from the creation to the year 1593, which is of some value for the period covered by the writer's lifetime. This, with an elaborate treatise on weights and measures, remains in MS. in the diocesan library of Londonderry.

For the later editions of the *Chronicles of England* . . . see HOLINSHED. The second and third books of Harrison's *Description* were edited by Dr F. J. Furnivall for the New Shakspere Society, with extracts from his "Chronologic" and from other contemporary writers, as *Shakspere's England* (2 vols., 1877-1878).

HARRISON, WILLIAM HENRY (1773-1841), ninth president of the United States, was born at Berkeley, Charles City county, Virginia, on the 9th of February 1773, the third son of Benjamin Harrison (c. 1740-1791). His father was long prominent in Virginia politics, and became a member of the Virginia House of Burgesses in 1764, opposing Patrick Henry's Stamp Act resolutions in the following year; he was a member of the Continental Congress in 1774-1777, signing the Declaration of Independence and serving for a time as president of the Board of War; speaker of the Virginia House of Delegates in 1777-1782; governor of Virginia in 1781-1784; and in 1788 as a member of the Virginia Convention he actively opposed the ratification of the Federal Constitution by his state. William

Henry Harrison received a classical education at Hampden-Sidney College, where he was a student in 1787-1790, and began a medical course in Philadelphia, but the death of his father caused him to discontinue his studies, and in November 1791 he entered the army as ensign in the Tenth Regiment at Fort Washington, Cincinnati. In the following year he became a lieutenant, and subsequently acted as aide-de-camp to General Anthony Wayne in the campaign which ended in the battle of Fallen Timbers on the 10th of August 1794. He was promoted to a captaincy in 1797 and for a brief period served as commander of Fort Washington, but resigned from the army in June 1798. Soon afterwards he succeeded Winthrop Sargent as secretary of the North-west Territory. In 1799 he was chosen by the Jeffersonian party of this territory as the delegate of the territory in Congress. While serving in this capacity he devised a plan for disposing of the public lands upon favourable terms to actual settlers, and also assisted in the division of the North-west Territory. It was his ambition to become governor of the more populous eastern portion, which retained the original name, but instead, in January 1800, President John Adams appointed him governor of the newly created Indiana Territory, which comprised until 1809 a much larger area than the present state of the same name. (See *INDIANA: History*.) He was not sworn into office until the 10th of January 1801, and was governor until September 1812. Among the legislative measures of his administration may be mentioned the attempted modification of the slavery clause of the ordinance of 1787 by means of an indenture law—a policy which Harrison favoured; more effective land laws; and legislation for the more equitable treatment of the Indians and for preventing the sale of liquor to them. In 1803 Harrison also became a special commissioner to treat with the Indians "on the subject of boundary or lands," and as such negotiated various treaties—at Fort Wayne (1803 and 1809), Vincennes (1804 and 1809) and Grouseland (1805)—by which the southern part of the present state of Indiana and portions of the present states of Illinois, Wisconsin and Missouri were opened to settlement. For a few months after the division in 1804 of the Louisiana Purchase into the Orleans Territory and the Louisiana Territory he also acted as governor of the Louisiana Territory—all of the Louisiana Purchase N. of the thirty-third parallel, his jurisdiction then being the greatest in extent ever exercised by a territorial official in the United States.

The Indian cessions of 1809, along the Wabash river, aroused the hostility of Tecumseh (q.v.) and his brother, familiarly known as "The Prophet," who were attempting to combine the tribes between the Ohio and the Great Lakes in opposition to the encroachment of the whites. Several fruitless conferences between the governor and the Indian chiefs, who were believed to be encouraged by the British, resulted in Harrison's advance with a force of militia and regulars to the Tippecanoe river, where (near the present Lafayette, Ind.) on the 7th of November 1811 he won over the Indians a victory which established his military reputation and was largely responsible for his subsequent nomination and election to the presidency of the United States. From one point of view the battle of Tippecanoe may be regarded as the opening skirmish of the war of 1812. When in the summer of 1812 open hostilities with Great Britain began, Harrison was appointed by Governor Charles Scott of Kentucky major-general in the militia of that state. A few weeks later (22nd August 1812) he was made brigadier-general in the regular U.S. army, and soon afterwards was put in command of all the troops in the north-west, and on the 2nd of March 1813 he was promoted to the rank of major-general. General James Winchester, whom Harrison had ordered to prepare to cross Lake Erie on the ice and surprise Fort Malden, turned back to rescue the threatened American settlement at Frenchtown (now Monroe), on the Raisin river, and there on the 22nd of January 1813 was forced to surrender to Colonel Henry A. Proctor. Harrison's offensive operations being thus checked, he accomplished nothing that summer except to hold in check Proctor, who (May 1-5) besieged him at Fort Meigs, the American advanced

post after the disaster of the river Raisin. After Lieutenant O. H. Perry's naval victory on the 10th of September 1813, Harrison no longer had to remain on the defensive; he advanced to Detroit, re-occupied the territory surrendered by General William Hull, and on the 5th of October administered a crushing defeat to Proctor at the battle of the Thames.

In 1814 Harrison received no active assignments to service, and on this account and because the secretary of war (John Armstrong) issued an order to one of Harrison's subordinates without consulting him, he resigned his commission. Armstrong accepted the resignation without consulting President Madison, but the president later utilized Harrison in negotiating with the north-western Indians, the greater part of whom agreed (22nd July 1814) to a second treaty of Greenville, by which they were to become active allies of the United States, should hostilities with Great Britain continue. This treaty publicly marked an American policy of alliance with these Indians and caused the British peace negotiators at Ghent to abandon them. In the following year Harrison held another conference at Detroit with these tribes in order to settle their future territorial relations with the United States.

From 1816 to 1819 Harrison was a representative in Congress, and as such worked in behalf of more liberal pension laws and a better militia organization, including a system of general military education, of improvements in the navigation of the Ohio, and of relief for purchasers of public lands, and for the strict construction of the power of Congress over the Territories, particularly in regard to slavery. In accordance with this view in 1819 he voted against Tallmadge's amendment (restricting the extension of slavery) to the enabling act for the admission of Missouri. He also delivered forcible speeches upon the death of Kosciusko and upon General Andrew Jackson's course in the Floridas, favouring a partial censure of the latter.

Harrison was a member of the Ohio senate in 1819-1821, and was an unsuccessful candidate for the National House of Representatives in 1822, when his Missouri vote helped to cause his defeat; he was a presidential elector in 1824, supporting Henry Clay, and from 1825 to 1828 was a member of the United States Senate. In 1828 after unsuccessful efforts to secure for him the command of the army, upon the death of Major-General Jacob Brown, and the nomination for the vice-president, on the ticket with John Quincy Adams, his friends succeeded in getting Harrison appointed as the first minister of the United States to Colombia. He became, however, an early sacrifice to Jackson's spoils system, being recalled within less than a year, but not until he had involved himself in some awkward diplomatic complications with Bolivar's autocratic government.

For some years after his return from Colombia he lived in retirement at North Bend, Ohio. He was occasionally "mentioned" for governor, senator or representative, by the anti-Jackson forces, and delivered a few addresses on agricultural or political topics. Later he became clerk of the court of common pleas of Hamilton county—a lucrative position that was then most acceptable to him. Early in 1835 Harrison began to be mentioned as a suitable presidential candidate, and later in the year he was nominated for the presidency at large public meetings in Pennsylvania, New York and Maryland. In the election of the following year he attracted a large part of the Whig and Anti-Masonic vote of the Middle and Western states and led among the candidates opposing Van Buren, but received only 73 electoral votes while Van Buren received 170. His unexpected strength, due largely to his clear, if non-committal, political record, rendered him the most "available" candidate for the Whig party for the campaign of 1840, and he was nominated by the Whig convention at Harrisburg, Pa., in December 1839, his most formidable opponent being Henry Clay, who, though generally regarded as the real leader of his party, was less "available" because as a mason he would alienate former members of the old Anti-Masonic party, and as an advocate of a protective tariff would repel many Southern voters. The convention adjourned without adopting any "platform" of principles, the party shrewdly deciding to make its campaign merely on the

issue of whether the Van Buren administration should be continued in power and thus to take full advantage of the popular discontent with the administration, to which was attributed the responsibility for the panic of 1837 and the subsequent business depression. Largely to attract the votes of Democratic malcontents the Whig convention nominated for the vice-presidency John Tyler, who had previously been identified with the Democratic party. The campaign was marked by the extraordinary enthusiasm exhibited by the Whigs, and by their skill in attacking Van Buren without binding themselves to any definite policy. Because of his fame as a frontier hero, of the circumstance that a part of his home at North Bend, Ohio, had formerly been a log cabin, and of the story that cider, not wine, was served on his table, Harrison was derisively called by his opponents the "log cabin and hard cider" candidate, the term was eagerly accepted by the Whigs, in whose processions miniature log cabins were carried and at whose meetings hard cider was served, and the campaign itself has become known in history as the "log cabin and hard cider campaign." Harrison's canvass was conspicuous for the immense Whig processions and mass meetings, the numerous "stump" speeches (Harrison himself addressing meetings at Dayton, Chillicothe, Columbus and other places), and the use of campaign songs, of party insignia, and of campaign cries (such as "Tippecanoe and Tyler too"); and in the election he won by an overwhelming majority of 234 electoral votes to 60 cast for Van Buren.

President Harrison was inaugurated on the 4th of March 1841. He chose for his cabinet Daniel Webster as secretary of state, Thomas Ewing as secretary of the treasury, John Bell as secretary of war, George E. Badger as secretary of the navy, Francis Granger as postmaster-general, and John J. Crittenden as attorney-general. He survived his inauguration only one month, dying on the 4th of April 1841, and being succeeded by the vice-president, John Tyler. The immediate cause of his death was an attack of pneumonia, but the disease was aggravated by the excitement attending his sudden change in circumstances and the incessant demands of office seekers. After temporary interment at Washington, his body was removed to the tomb at North Bend, Ohio, where it now lies. A few of Harrison's public addresses survive, the most notable being *A Discourse on the Aborigines of the Ohio*. It has been said of him: "He was not a great man, but he had lived in a great time, and he had been a leader in great things." He was the first territorial delegate in the Congress of the United States and was the author of the first step in the development of the country's later homestead policy; the first presidential candidate to be selected upon the ground of "expediency" alone; and the first president to die in office. In 1795 he married Anna Symmes (1775-1864), daughter of John Cleves Symmes. Their grandson, Benjamin Harrison, was the twenty-third president of the United States.

AUTHORITIES.—In 1824 Moses Dawson published at Cincinnati the *Historical Narrative of the Civil and Military Services of Major-General William H. Harrison*. This is a combined defence and political pamphlet, but it is the source of all the subsequent "lives" that have appeared. There are several "campaign" biographies, including one by Richard Hildreth (1839) and one by Caleb Cushing (1840); and there is a good sketch in *Presidents of the United States* (New York, 1894), edited by J. G. Wilson. An excellent study of Harrison's career in Indiana appears in vol. 4 of the *Indiana Historical Society Publications*. Selections from his scanty correspondence appear in vols. ii. and iii. of the *Quarterly Publications of the Historical and Philosophical Society of Ohio*.

HARRISON, a town of Hudson county, New Jersey, U.S.A., on the Passaic river, opposite Newark (with which it is connected by bridges and electric railways), and 7 m. W. of Jersey City. Pop. (1890) 8338; (1900) 10,506, of whom 3633 were foreign-born; (1910 census) 14,498. It is served by the Pennsylvania, the Erie, and the Delaware, Lackawanna & Western railways. Harrison was chosen as the eastern terminal of the Pennsylvania railroad for steam locomotive service, transportation thence to New York being by electric power through the railway's Hudson river tunnels. The town has an extensive river-front, along which are many of its manufactories; among their products are steam-pumps, steel, iron, machinery, roller bearings,

brass tubing, iron and brass castings, marine engines, hoisting engines, metal novelties, dry batteries, electric lamps, concrete blocks, cotton thread, wire cloth, leather, trunks, beer, barrels, lumber, inks and cutlery. The factory product in 1905 was valued at \$8,408,924. The town is governed by a mayor and a common council. Harrison was settled toward the close of the 17th century, and for many years constituted the S. portion of the township of Lodi. In 1840, however, it was set off from Lodi and named in honour of President William Henry Harrison, and in 1873 it was incorporated. Harrison originally included what is now the town of Kearny (q.v.).

HARRODSBURG, a city and the county-seat of Mercer county, Kentucky, U.S.A., 32 m. S. of Frankfort, on the Southern railway. Pop. (1890) 3230; (1900) 2876, of whom 1150 were negroes; (1910 U.S. census) 3147. On account of its sulphur springs Harrodsburg became early in the 19th century a fashionable resort, and continues to attract a considerable number of visitors. The city is the seat of Harrodsburg Academy, Beaumont College for women (1894; founded as Daughters' College in 1856); and Wayman College (African M.E.) for negroes. Among its manufactures are flour, whisky, dressed lumber and ice. About 7 m. E. of Harrodsburg is Pleasant Hill, or Union Village, a summer resort and the home, since early in the 19th century, of a Shaker community. Harrodsburg was founded on the 16th of June 1774 by James Harrod (1746-1793) and a few followers, and is the oldest permanent settlement in the state. It was incorporated in 1875. Harrodsburg was formerly the seat of Bacon College (see LEXINGTON, Kentucky).

HARROGATE, a municipal borough and watering-place in the Ripon parliamentary division of the West Riding of Yorkshire, England, 203 m. N. by W. from London, on the North-Eastern railway. Pop. (1891) 16,316; (1901) 28,423. It is indebted for its rise and importance to its medicinal springs, and is the principal inland watering-place in the north of England. It consists of two scattered townships, Low Harrogate and High Harrogate, which have gradually been connected by a continuous range of handsome houses and villas. A common called the Stray, of 200 acres, secured by act of parliament from ever being built upon, stretches in front of the main line of houses, and on this account Harrogate, notwithstanding its rapid increase, has retained much of its rural charm. As regards climate a choice is offered between the more bracing atmosphere of High Harrogate and the sheltered and warm climate of the low town. The waters are chalybeate, sulphureous and saline, and some of the springs possess all these qualities to a greater or less extent. The principal chalybeate springs are the Twitt well, called by Dr Bright, who wrote the first account of it, the "English Spa," discovered by Captain William Slingsby of Bilton Hall near the close of the 16th century; the Royal Chalybeate Spa, more commonly known as John's Well, discovered in 1631 by Dr Stanhope of York; Muspratt's chalybeate or chloride of iron spring discovered in 1810, but first properly analysed by Dr Sheridan Muspratt in 1865; and the Starbeck springs midway between High Harrogate and Knaresborough. The principal sulphur springs are the old sulphur well in the centre of Low Harrogate, discovered about the year 1656; the Montpellier springs, the principal well of which was discovered in 1822, situated in the grounds of the Crown Hotel and surmounted by a handsome building in the Chinese style, containing pump-room, baths and reading-room; and the Harlow Car springs, situated in a wooded glen about a mile west from Low Harrogate. Near Harlow Car is Harlow observatory, a square tower 100 ft. in height, standing on elevated ground and commanding a very extensive view. A saline spring situated in Low Harrogate was discovered in 1783. Some eighty springs in all have been discovered. The principal bath establishments are the Victoria Baths (1871) and the Royal Baths (1807). There are also a handsome kursaal (1903), a grand opera house, numerous modern churches, and several hospitals and benevolent institutions, including the Royal Bath hospital. The corporation owns the Stray, and also the Spa concert rooms and grounds, Harlow Moor, Crescent Gardens, Royal Bath gardens and other large

open spaces, as well as Royal Baths, Victoria Baths and Starbeck Baths. The mineral springs are vested in the corporation. The high-lying moorland of the surrounding district is diversified by picturesque dales; and Harrogate is not far from many towns and sites of great interest, such as Ripon, Knaresborough and Fountains Abbey. The town was incorporated in 1884, and the corporation consists of a mayor, 8 aldermen and 24 councillors. Area, 3276 acres.

HARROW,¹ an agricultural implement used for (1) levelling ridges left by the plough and preparing a smooth surface for the reception of seeds; (2) covering in seeds after sowing; (3) tearing up and gathering weeds; (4) disintegrating and levelling the soil of meadows and pastures; (5) forming a surface tilth by pulverizing the top soil and so conserving moisture.

The harrow rivals the plough in antiquity. In its simplest form it consists of the boughs of trees interlaced into a wooden frame, and this form survives in the "bush-harrow." Another old type, found in the middle ages and still in use, consists of a wooden framework in which iron pegs or "tines" are set. This is now generally superseded by the "zig-zag" harrow patented by Armstrong in 1839, built of iron bars in which the tines are so arranged that each follows its own track and has a separate line of action. This harrow is usually made in two or three sections

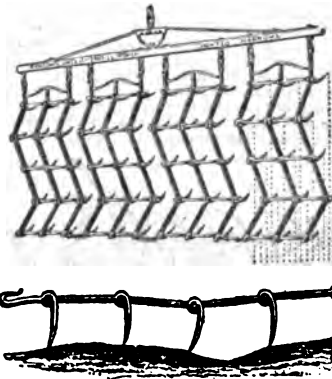

FIG. 1.—Jointed Zig-zag Harrow. (Ransomes, Sims & Jefferies, Ltd.)

which fold over one another and are thus easily portable, the arrangement at the same time giving a flexibility on uneven ground. Additional flexibility may be imparted to the implement by jointing the stays of the frame which are in the line of draught. The liability that the tines may snap off is the chief weakness of this type, and improvements have consisted chiefly in alterations in their shape and the method of fixing them to the frame.

The other type of harrow most used is the chain harrow, consisting of a number of square-link chains connected by cross links and attached to a draught-bar, the whole being kept expanded by stretchers and trailing weights. It is used for levelling and spreading manure over grass-land, from which it at the same time tears up moss and coarse herbage. Mention may also be made of the drag-harrow, a heavy implement with long tines, approximating closely to the cultivator, and of the Norwegian harrow with its revolving rows of spikes.

A few variations and developments of the ordinary harrow require notice. In the adjustable harrow (fig. 2) the teeth are secured to bars pivoted at their ends in the side bars of the frame, and provided with crank arms connected to a common link bar, which may be moved horizontally by means of a lever for the purpose of adjusting

¹ In Mid. Eng. *harrow*; the O. Eng. appears to have been *hearge*; the word is cognate with the Dutch *hark*, Swed. *harke*, Ger. *Harke*, rake, and with Danish *harr*, and Swed. *harf*, harrow, but the ultimate origin is unknown; the Fr. *herse* is a different word, cf. *HERSE*.

the angle which the teeth make with the ground, and thus convert the machine from a pulverizer to a smoothing harrow. The small figure illustrates a spring connexion between the adjusting lever and its locking bar, which allows the teeth to yield upon striking an obstruction. As the briskness of the operation adds to its effective-

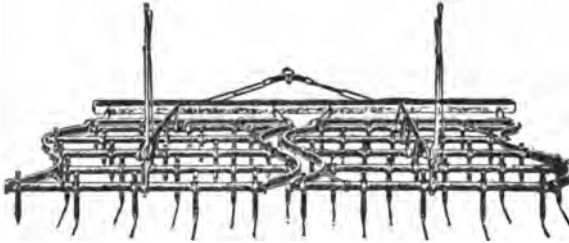

FIG. 2.—Adjustable Harrow.

ness, the harrow is often made with a seat from which the operator can hasten the team without fatiguing himself.

Fig. 3 illustrates a spring-tooth harrow. In this harrow the independent frames are carried upon wheels, and a seat for the operator is mounted upon standards supported by the two frames. The teeth consist of flat steel springs of scroll form, which yield to rigid obstructions and are mounted on rock shafts in the same manner as in the walking harrow before described. The levers enable the operator to raise the teeth more or less, and thus free them from rubbish and also regulate the depth of action.

Another variation of the harrow with great pulverizing and loosening capabilities consists of a main frame, having a pole and whipple-trees attached; to this frame are pivoted two supplemental frames, each of which has mounted on it a shaft carrying a series of concavo-convex disks. The supplemental frames may be swung by

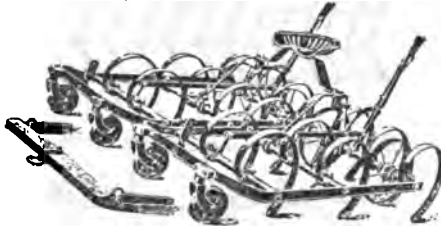
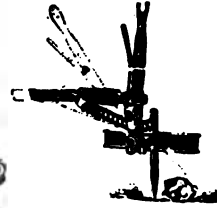

FIG. 3.—Spring-tooth Harrow.

the adjusting levers to any angle with relation to the line of draught, and the disks then act like that of the disk plough (see PLOUGH), throwing the soil outward with more or less force, according to the angle at which they are set, and thus thoroughly breaking up and pulverizing the clods. Above the disks is a bar to which are pivoted a series of scrapers, one for each disk, which are held to their work with a yielding action, being thrown out of operation when desired by the levers shown in connexion with the operating bar. Pans on the main frame are used to carry weights to hold the disks down to their work. The cut away disk harrow differs from the ordinary disk harrow in that its disks are notched and so have greater penetrating power. The curved knife-tooth harrow consists of a frame to which a row of curved blades is attached. Other forms of the implement are illustrated and discussed in *Farm Machinery and Farm Motors* by J. B. Davidson and L. W. Chase (New York, 1908).

HARROWBY, DUDLEY RYDER, 1ST EARL OF (1762-1847), the eldest son of Nathaniel Ryder, 1st Baron Harrowby (1735-1803), was born in London on the 22nd of December 1762. His grandfather Sir Dudley Ryder (1691-1756) became a member of parliament and solicitor-general owing to the favour of Sir Robert Walpole in 1733; in 1737 he was appointed attorney-general and three years later he was knighted; in 1754 he was made lord chief justice of the king's bench and a privy councillor, the patent creating him a peer having been just signed by the king, but not passed, when he died on the 25th of May 1756. His only son Nathaniel, who was member of parliament for Tiverton for twenty years, was created Baron Harrowby in 1776. Educated at St John's College, Cambridge, Dudley Ryder became

member of parliament for Tiverton in 1784 and under-secretary for foreign affairs in 1789. In 1791 he was appointed paymaster of the forces and vice-president of the board of trade, but he resigned the positions and also that of treasurer of the navy



Showing tooth mechanism of harrow.

when he succeeded to his father's barony in June 1803. In 1804 he was secretary of state for foreign affairs and in 1805 chancellor of the duchy of Lancaster under his intimate friend William Pitt; in the latter year he was sent on a special and important mission to the emperors of Austria and Russia and the king of Prussia, and

for the long period between 1812 and 1827 he was lord president of the council. After Canning's death in 1827 he refused to serve George IV. as prime minister and he never held office again, although he continued to take part in politics, being especially prominent during the deadlock which preceded the passing of the Reform Bill in 1832. Harrowby's long association with the Tories did not prevent him from assisting to remove the disabilities of Roman Catholics and Protestant dissenters, or from supporting the movement for electoral reform; he was also in favour of the emancipation of the slaves. The earl died at his Staffordshire residence, Sandon Hall, on the 26th of December 1847, being, as Charles Greville says, "the last of his generation and of the colleagues of Mr Pitt, the sole survivor of those stirring times and mighty contests."

Harrowby's eldest son, Dudley Ryder, 2nd earl (1798-1882), was born in London on the 19th of May 1798, his mother being Susan (d. 1838), daughter of Granville Leveson-Gower, marquess of Stafford, a lady of exceptional attainments. As Viscount Sandon he became member of parliament for Tiverton in 1819, in 1827 he was appointed a lord of the admiralty, and in 1830 secretary to the India board. From 1831 to 1847 Sandon represented Liverpool in the House of Commons. For a long time he was out of office, but in 1855, eight years after he had become earl of Harrowby, he was appointed chancellor of the duchy of Lancaster by Lord Palmerston; in a few months he was transferred to the office of lord privy seal, a position which he resigned in 1857. He was chairman of the Maynooth commission and a member of other important royal commissions, and was among the most stalwart and prominent defenders of the established church. He died at Sandon on the 10th of November 1882. His successor was his eldest son, Dudley Francis Stuart Ryder (1831-1900), vice-president of the council from 1874 to 1878, president of the board of trade from 1878 to 1880, and lord privy seal in 1885 and 1886. He died without sons on the 26th of March 1900, and was succeeded by his brother, Henry Dudley Ryder (1836-1900), whose son, John Herbert Dudley Ryder (b. 1864), became 5th earl of Harrowby.

HARROWING OF HELL, an English poem in dialogue, dating from the end of the 13th century. It is written in the East Midland dialect, and is generally cited as the earliest dramatic work of any kind preserved in the language, though it was in reality probably intended for recitation rather than performance. It is closely allied to the kind of poem known as a *débat*, and the opening words—"Alle herkneth to me nou A strif wille I tellen ou Of Jesu and of Satan"—seem to indicate that the piece was delivered by a single performer. The subject—the descent of Christ into Hades to succour the souls of the just, as related in the apocryphal gospel of Nicodemus—is introduced in a kind of prologue, then follows the dispute between "Dominus" and "Satan" at the gate of Hell; the gatekeeper runs away, and the just are set free, while Adam, Eve, Habraham, David, Johannes and Moyses do homage to the deliverer. The poem

ends with a short prayer: "God, for his moder loue Let oue neuer thider come." Metrically, the poem is characterized by frequent alliteration imposed upon the rhymed octosyllabic couplet.—

Welcome, louerd, god of londe
Godes sone and godes sonde (ii. 149-150).

The piece is obviously connected with the Easter cycle of liturgical drama, and the subject is treated in the York and Townley plays.

MSS. are: Brit. Mus., Harl. MS. 2253; Edinburgh, Auchinleck MS., W 41; Oxford, Bodleian, Digby 86. It was privately printed by J. P. Collier and by J. O. Halliwell, but is available in Appendix III. of A. W. Pollard's *English Miracle Plays* . . . (4th ed., 1904) K. Bökdeker, *Altengl. Dichtungen des MS. Harl. 2253* (Berlin, 1878); and E. Mall, *The Harrowing of Hell* (Breslau, 1871). See also E. K. Chambers, *The Medieval Stage* (2 vols., 1903).

HARROW-ON-THE-HILL, an urban district in the Harrow parliamentary division of Middlesex, England, 12 m. W.N.W. of St Paul's cathedral, London, served by the London and North Western, Metropolitan and District railways. Pop. (1901), 10,220. It takes its name from its position on an isolated hill rising to a height of 345 ft. On the summit, and forming a conspicuous landmark, is the church of St Mary, said to have been founded by Lanfranc, archbishop of Canterbury, in the reign of William I., and Norman work appears at the base of the tower. The remainder of the church is of various later dates, and there are several ancient monuments and brasses.

Harrow is celebrated for its public school, founded in 1571 by John Lyon, whose brass is in the church, a yeoman of the neighbouring village of Preston who had yearly during his life set aside 20 marks for the education of poor children of Harrow; though a school existed before his time. Though the charter was granted by Queen Elizabeth in 1571, and the statutes drawn up by the founder in 1590, two years before his death, it was not till 1611 that the first building was opened for scholars. Lyon originally settled about two-thirds of his property on the school, leaving the remainder for the maintenance of the highway between London and Harrow, but in the course of time the values of the respective endowments have changed so far that the benefit accruing to the school is a small proportion of the whole. About 1660 the headmaster, taking advantage of a concession in Lyon's statutes, began to receive "foreigners," i.e. boys from other parishes, who were to pay for their education. From this time the prosperity of the school may be dated. In 1809 the parishioners of Harrow appealed to the court of chancery against the manner in which the school was conducted, but the decision, while it recognized their privileges, confirmed the right of admission to foreigners. The government of the school was originally vested in six persons of standing in the parish who had the power of filling vacancies in their number by election among themselves; but under the Public Schools Act of 1868 the governing body now consists of the surviving members of the old board, besides six new members who are elected respectively by the lord chancellor, the universities of Oxford, Cambridge and London, the Royal Society, and the assistant masters of the school. There are several scholarships in connexion with the school to Oxford and Cambridge Universities. Harrow was originally an exclusively classical school, but mathematics became a compulsory study in 1837; modern languages, made compulsory in the upper forms in 1851, were extended to the whole school in 1855; while English history and literature began to be especially studied about 1809. The number of boys is about 600. The principal buildings are modern, including the chapel (1857), the library (1863), named after the eminent headmaster Dr Charles John Vaughan, and the speech-room (1877), the scene of the brilliant ceremony on "Speech Day" each summer term. The fourth form room, however, dates from 1611, and on its panels are cut the names of many eminent *alumni*, such as Byron, Robert Peel, R. B. Sheridan and Temple (Lord Palmerston). Several of the buildings were erected out of the Lyon Tercentenary Fund, subscribed after the tercentenary celebration in 1871.

A considerable extension of Harrow as an outer residential suburb of London has taken place north of the hill, where is the urban district of Wealdstone (pop. 5001), and there are also important printing and photographic works.

HARRY THE MINSTREL, or **BLIND HARRY** (fl. 1470-1492), author of the Scots historical poem *The Actis and Deidis of the Illustere and Vaiseand Campioun Schir William Wallace, Knicht of Ellerslie*, flourished in the latter half of the 15th century. The details of his personal history are of the scantiest. He appears to have been a blind Lothian man, in humble circumstances, who had some reputation as a story-teller, and who received, on five occasions, in 1490 and 1491, gifts from James IV. The entries of these, in the *Accounts of the Lord High Treasurer*, occur among others to harpers and singers. He is alluded to by Dunbar (*q.v.*) in the fragmentary *Interlude of the Droichis Part of the Play*, where a "droich," or dwarf, personates

"the nakit blynd Harry
That lang has bene in the fary
Farleis to find;"

and again in Dunbar's *Lament for the Makaris*. John Major (*q.v.*) in his Latin *History* speaks of "one Henry, blind from his birth, who, in the time of my childhood, fashioned a whole book about William Wallace, and therein wrote down in our popular verse—and this was a kind of composition in which he had much skill—all that passed current among the people in his day. I, however, can give but partial credence to these writings. This Henry used to recite his tales before nobles, and thus received food and clothing as his reward" (Bk. iv. ch. xv.).

The poem (preserved in a unique MS., dated 1488, in the Advocates' library, Edinburgh) is divided into eleven books and runs to 11,853 lines. Its poetic merits are few, and its historical accuracy is easily impugned. It has the formal interest of being one of the earliest, certainly one of the most extensive verse-documents in Scots written in five-accent, or heroic, couplets. It is also the earliest outstanding work which discloses that habit of Scotticism which took such strong hold of the popular Northern literature during the coming years of conflict with England. In this respect it is in marked contrast with all the patriotic verse of preceding and contemporary literature. This attitude of the *Wallace* may perhaps be accepted as corroborative evidence of the humble milieu and popular sentiment of its author. The poem owed its subsequent widespread reputation to its appeal to this sentiment rather than to its literary quality. On the other hand, there are elements in the poem which show that it is not entirely the work of a poor crowder; and these (notably references to historical and literary authorities, and occasional reminiscences of the literary tricks of the Scots Chaucerian school) have inclined some to the view that the text, as we have it, is an edited version of the minstrel's rough song-story. It has been argued, though by no means conclusively, that the "editor" was John Ramsay, the scribe of the Edinburgh MS. and of the companion Edinburgh MS. of the *Brus* by John Barbour (*q.v.*).

The poem appears, on the authority of Laing, to have been printed at the press of Chepman & Myllar about 1508, but the fragments which Laing saw are not extant. The first complete edition, now available, was printed by Lekpervik for Henry Charteris in 1570 (Brit. Museum). It was reprinted by Charteris in 1594 and 1601, and by Andro Hart in 1611 and 1620. At least six other editions appeared in the 17th century. There are many later reprints, including some of William Hamilton of Gilbertfield's modern Scots version of 1722. The first critical edition was prepared by Dr Jamieson and published in 1820. In 1889 the Scottish Text Society completed their edition of the text, with prolegomena and notes by James Moir.

See, in addition to Jamieson's and Moir's volumes (*u.s.*), J. T. T. Brown's *The Wallace and the Bruce Restudied* (Bonner, *Beiträge zur Anglistik*, vi., 1900), a plea for Ramsay's authorship of the known text; also W. A. Craigie's article in *The Scottish Review* (July 1903), a comparative estimate of the *Brus* and *Wallace*, in favour of the latter.

HARSDÖRFFER, GEORG PHILIPP (1607-1658), German poet, was born at Nuremberg on the 1st of November 1607. He studied law at Altdorf and Strassburg, and subsequently travelled

through Holland, England, France and Italy. His knowledge of languages gained for him the appellation "the learned," though he was as little a learned man as he was a poet. As a member of the *Fruchbringende Gesellschaft* he was called *der Spielende* (the player). Jointly with Johann Klaj (q.v.) he founded in 1644 at Nuremberg the order of the *Pegnitzschäfer*, a literary society, and among the members thereof he was known by the name of *Strephon*. He died at Nuremberg on the 22nd of September 1658. His writings in German and Latin fill fifty volumes, and a selection of his poems, interesting mostly for their form, is to be found in Müller's *Bibliothek deutscher Dichter des 17ten Jahrhunderts*, vol. ix. (Leipzig, 1826).

His life was written by Widmann (Altdorf, 1707). See also Tittmann, *Die Nürnberger Dichterschule* (Göttingen, 1847); Hodermann, *Eine vornehme Gesellschaft, nach Harsdörffers "Gesprächspielen"* (Paderborn, 1890); T. Bischoff, "Georg Philipp Harsdörffer" in the *Festschrift zur 250jährigen Jubelfeier des Pegnitzschen Blumenordens* (Nuremberg, 1894); and Krapp, *Die ästhetischen Tendenzen Harsdörffers* (Berlin, 1904).

HARSHA, or **HARSHAVARDHANA** (fl. A.D. 606-648), an Indian king who ruled northern India as paramount monarch for over forty years. The events of his reign are related by Hüan Tsang, the Chinese pilgrim, and by Bana, a Brahman author. He was the son of a raja of Thanesar, who gained prominence by successful wars against the Huns, and came to the throne in A.D. 606, though he was only crowned in 612. He devoted himself to a scheme of conquering the whole of India, and carried on wars for thirty years with success, until (A.D. 620) he came in contact with Pulakesin II., the greatest of the Chalukya dynasty, who made himself lord of the south, as Harsha was lord of the north. The Nerbudda river formed the boundary between the two empires. In the latter years of his reign Harsha's sway over the whole basin of the Ganges from the Himalayas to the Nerbudda was undisputed. After thirty-seven years of war he set himself to emulate Asoka and became a patron of art and literature. He was the last native monarch who held paramount power in the north prior to the Mahomedan conquest; and was succeeded by an era of petty states.

See Bana, *Sri-harsha-charita*, trans. Cowell and Thomas (1897); Ettinghausen, *Harsha Vardhana* (Louvain, 1906).

HARSNETT, SAMUEL (1561-1631), English divine, archbishop of York, was born at Colchester in June 1561, and was educated at Pembroke Hall, Cambridge, where he was successively scholar, fellow and master (1605-1616). He was also vice-chancellor of the university in 1606 and 1614. His ecclesiastical career began somewhat unpromisingly, for he was censured by Archbishop Whitgift for Romanist tendencies in a sermon which he preached against predestination in 1584. After holding the living of Chigwell (1597-1605) he became chaplain to Bancroft (then bishop of London), and afterwards archdeacon of Essex (1603-1609), rector of Stisted and bishop of Chichester (1609-1619) and archbishop of York (1629). He died on the 25th of May 1631. Harsnett was no favourite with the Puritan community, and Charles I. ordered his *Considerations for the better Settling of Church Government* (1629) to be circulated among the bishops. His *Declaration of Egregious Popish Impostures* (1603) furnished Shakespeare with the names of the spirits mentioned by Edgar in *King Lear*.

HART, ALBERT BUSHNELL (1854-), American historian, was born at Clarksville, Mercer county, Pennsylvania, on the 1st of July 1854. He graduated at Harvard College in 1880, studied at Paris, Berlin and Freiburg, and received the degree of Ph.D. at Freiburg in 1883. He was instructor in history at Harvard in 1882-1887, assistant professor in 1887-1897, and became professor in 1897. Among his writings are: *Introduction to the Study of Federal Government* (1890), *Formation of the Union* (1892), in the Epochs of American History series), *Practical Essays on American Government* (1893), *Studies in American Education* (1895), *Guide to the Study of American History* (with Edward Channing, 1897), *Salmon Portland Chase* (1899, in the American Statesman series), *Foundations of American Foreign Policy* (1901), *Actual Government* (1903), *Slavery and Abolition* (1906, the volume in the American

Nation series dealing with the period 1831-1841), *National Ideals Historically Traced* (1907), the 26th volume of the American Nation series, and many historical pamphlets and articles. In addition he edited *American History told by Contemporaries* (4 vols., 1898-1901), and *Source Readers in American History* (4 vols., 1901-1903), and two co-operative histories of the United States, the Epochs of American History series (3 small text-books), and, on a much larger scale, the American Nation series (27 vols., 1903-1907); he also edited the American Citizen series.

HART, CHARLES (d. 1683), English actor, grandson of Shakespeare's sister Joan, is first heard of as playing women's parts at the Blackfriars' theatre as an apprentice of Richard Robinson. In the Civil War he was a lieutenant of horse in Prince Rupert's regiment, and after the king's defeat he played surreptitiously at the Cockpit and at Holland House and other noblemen's residences. After the Restoration he is known to have been in 1660 the original *Dorante* in *The Mistaken Beauty*, adapted from Corneille's *Le Menteur*. In 1663 he went to the Theatre Royal in Killigrew's company, with which he remained until 1682, taking leading parts in Dryden's, Jonson's and Beaumont and Fletcher's plays. He is highly spoken of by contemporaries in such Shakespearian parts as Othello and Brutus. He is often mentioned by Pepys. Betterton praised him, and would not himself play the part of Hotspur until after Hart's retirement. He died in 1683 and was buried on the 20th of August. Hart is said to have been the first lover of Nell Gwyn, and to have trained her for the stage.

HART, ERNEST ABRAHAM (1835-1898), English medical journalist, was born in London on the 26th of June 1835, the son of a Jewish dentist. He was educated at the City of London school, and became a student at St George's hospital. In 1856 he became a member of the Royal College of Surgeons, making a specialty of diseases of the eye. He was appointed ophthalmic surgeon at St Mary's hospital at the age of 28, and occupied various other posts, introducing into ophthalmic practice some modifications since widely adopted. His name, too, is associated with a method of treating popliteal aneurism, which he was the first to use in Great Britain. His real life-work, however, was as a medical journalist, beginning with the *Lancet* in 1857. He was appointed editor of the *British Medical Journal* in 1866. He took a leading part in the exposures which led to the inquiry into the state of London workhouse infirmaries, and to the reform of the treatment of sick poor throughout England, and the Infant Life Protection Act of 1872, aimed at the evils of baby-farming, was largely due to his efforts. The record of his public work covers nearly the whole field of sanitary legislation during the last thirty years of his life. He had a hand in the amendments of the Public Health and of the Medical Acts; in the measures relating to notification of infectious disease, to vaccination, to the registration of plumbers; in the improvement of factory legislation; in the remedy of legitimate grievances of Army and Navy medical officers; in the removal of abuses and deficiencies in crowded barrack schools; in denouncing the sanitary shortcomings of the Indian government, particularly in regard to the prevention of cholera. His work on behalf of the British Medical Association is shown by the increase from 2000 to 10,000 in the number of members, and the growth of the *British Medical Journal* from 20 to 64 pages, during his editorship. From 1872 to 1897 he was chairman of the Association's Parliamentary Bill Committee. He died on the 7th of January 1898. For his second wife he married Alice Marion Rowland, who had herself studied medicine in London and Paris, and was no less interested than her husband in philanthropic reform. She was most active in her encouragement of Irish cottage industries, and was the founder of the Donegal Industrial Fund.

HART, SIR ROBERT, Bart. (1835-), Anglo-Chinese statesman, was born at Milltown, Co. Armagh, on the 20th of February 1835. He was educated at Taunton, Dublin and Belfast, and graduated at Queen's College, Belfast, in 1853. In the following year he received an appointment as student

interpreter in the China consular service, and after serving for a short time at the Ningpo vice-consulate, he was transferred to Canton, where after acting as secretary to the allied commissioners governing the city, he was appointed the local inspector of customs. There he first gained an insight into custom-house work. One effect of the Taiping rebellion was to close the native custom-house at Shanghai; and as the corrupt alternatives proposed by the Chinese were worse than useless, it was arranged by Sir Rutherford Alcock, the British consul, with his French and American colleagues, that they should undertake to collect the duties on goods owned by foreigners entering and leaving the port. Sir T. Wade was appointed to the post of collector in the first instance, and after a short tenure of office was succeeded by Mr H. N. Lay, who held the post until 1863, when he resigned owing to a disagreement with the Chinese government in connexion with the Lay-Osborn fleet. During his tenancy of office the system adopted at Shanghai was applied to the other treaty ports, so that when on Mr Lay's resignation Mr Hart was appointed inspector-general of foreign customs, he found himself at the head of an organization which collected a revenue of upwards of eight million taels per annum at fourteen treaty ports. From the date when Mr Hart took up his duties at Peking, in 1863, he unceasingly devoted the whole of his energies to the work of the department, with the result that the revenue grew from upwards of eight million taels to nearly twenty-seven million, collected at the thirty-two treaty ports, and the customs staff, which in 1864 numbered 200, reached in 1901 a total of 5704. From the first Mr Hart gained the entire confidence of the members of the Chinese government, who were wise enough to recognize his loyal and able assistance. Of all their numerous sources of revenue, the money furnished by Mr Hart was the only certain asset which could be offered as security for Chinese loans. For many years, moreover, it was customary for the British minister, as well as the ministers of other powers, to consult him in every difficulty; and such complete confidence had Lord Granville in his ability and loyalty, that on the retirement of Sir T. Wade he appointed him minister plenipotentiary at Peking (1885). Sir Robert Hart, however—who was made a K.C.M.G. in 1882—recognized the anomalous position in which he would have been placed had he accepted the proposal, and declined the proffered honour. On all disputed points, whether commercial, religious or political, his advice was invariably sought by the foreign ministers and the Chinese alike. Thrice only did he visit Europe between 1863 and 1902, the result of this long comparative isolation, and of his constant intercourse with the Peking officials, being that he learnt to look at events through Chinese spectacles; and his work, *These from the Land of Sinim*, shows how far this affected his outlook. The faith which he put in the Chinese made him turn a deaf ear to the warnings which he received of the threatening Boxer movement in 1900. To the last he believed that the attacking force would at least have spared his house, which contained official records of priceless value, but he was doomed to see his faith falsified. The building was burnt to the ground with all that it contained, including his private diary for forty years. When the stress came, and he retreated to the British legation, he took an active part in the defence, and spared neither risk nor toil in his exertions. In addition to the administration of the foreign customs service, the establishment of a postal service in the provinces devolved upon him, and after the signing of the protocol of 1901 he was called upon to organize a native customs service at the treaty ports.

The appointment of Sir Robert Hart as inspector-general of the imperial maritime customs secured the interests of European investors in Chinese securities, and helped to place Chinese finance generally on a solid footing. When, therefore, in May 1906 the Chinese government appointed a Chinese administrator and assistant administrator of the entire customs of China, who would control Sir Robert Hart and his staff, great anxiety was aroused. The Chinese government had bound itself in 1896 and 1898 that the imperial maritime customs services should remain as then constituted during the currency

of the loan. The British government obtained no satisfactory answer to its remonstrances, and Sir Robert Hart, finding himself placed in a subordinate position after his long service, retired in July 1907. He received formal leave of absence in January 1908, when he received the title of president of the board of customs. Both the Chinese and the British governments from time to time conferred honours upon Sir Robert Hart. By giving him a Red Button, or button of the highest rank, a Peacock's Feather, the order of the Double Dragon, a patent of nobility to his ancestors for three generations, and the title of Junior Guardian of the heir apparent, the Chinese showed their appreciation of his manifold and great services; while under the seal of the British government there were bestowed upon him the orders of C.M.G. (1880), K.C.M.G. (1882), G.C.M.G. (1889), and a baronetcy (1893). He has also been the recipient of many foreign orders. Sir Robert Hart married in 1886 Hester, the daughter of Alexander Bredon, Esq., M.D., of Portadown.

See his life by Julia Bredon (*Sir Robert Hart*, 1909).

HART, WILLIAM (1823-1894), American landscape and cattle painter, was born in Paisley, Scotland, on the 31st of March 1823, and was taken to America in early youth. He was apprenticed to a carriage painter at Albany, New York, and his first efforts in art were in making landscape decorations for the panels of coaches. Subsequently he returned to Scotland, where he studied for three years. He opened a studio in New York in 1853, and was elected an associate of the National Academy of Design in 1857 and an academician in the following year. He was also a member of the American Water Colour Society, and was its president from 1870 to 1873. As one of the group of the Hudson River School he enjoyed considerable popularity, his pictures being in many well-known American collections. He died at Mount Vernon, New York, on the 17th of June 1894.

His brother, **JAMES McDOUGAL HART** (1828-1901), born in Kilmarnock, Scotland, was also a landscape and cattle painter. He was a pupil of Schirmer in Düsseldorf, and became an associate of the National Academy of Design in 1857 and a full member in 1859. He was survived by two daughters, both figure painters, Letitia B. Hart (b. 1867) and Mary Theresa Hart (b. 1872).

HARTE, FRANCIS BRET (1839-1902), American author, was born at Albany, New York, on the 25th of August 1839. His father, a professor of Greek at the Albany College, died during his boyhood. After a common-school education he went with his mother to California at the age of seventeen, afterwards working in that state as a teacher, miner, printer, express-messenger, secretary of the San Francisco mint, and editor. His first literary venture was a series of *Condensed Novels* (travesties of well-known works of fiction, somewhat in the style of Thackeray), published weekly in *The Californian*, of which he was editor, and reissued in book form in 1867. *The Overland Monthly*, the earliest considerable literary magazine on the Pacific coast, was established in 1868, with Harte as editor. His sketches and poems, which appeared in its pages during the next few years, attracted wide attention in the eastern states and in Europe.

Bret Harte was an early master of the short story, and his Californian tales were regarded as introducing a new *genre* into fiction. "The Luck of Roaring Camp" (1868), "The Outcasts of Poker Flat" (1869), the later sketch "How Santa Claus came to Simpson's Bar," and the verses entitled "Plain Language from Truthful James," combined humour, pathos and power of character portrayal in a manner that indicated that the new land of mining-gulches, gamblers, unassimilated Asiatics, and picturesque and varied landscape had found its best delineator; so that Harte became, in his pioneer pictures, a sort of later Fenimore Cooper. Forty-four volumes were published by him between 1867 and 1898. After a year as professor in the university of California, Harte lived in New York, 1871-1878; was United States consul at Crefeld, Germany, 1878-1880; consul at Glasgow, 1880-1885; and after 1885 resided in London, engaged

in literary work. He died at Camberley, England, on the 5th of May 1902.

A library edition of his *Writings* (16 vols.) was issued in 1900, and increased to 19 vols. in 1904. See also H. W. Boynton, *Bret Harle* (1905) in the Contemporary Men of Letters series; T. E. Pemberton, *Life of Bret Harle* (1903), which contains a list of his poems, tales, &c.

HARTEBEEST, the Boer name for a large South African antelope (also known as caama) characterized by its red colour, long face with naked muzzle and sharply angulated lyrate horns, which are present in both sexes. This antelope is the



Cape Hartebeest (*Bubalis cama*).

Bubalis cama or *Alcelaphus cama* of naturalists; but the name hartebeest has been extended to include all the numerous members of the same genus, some of which are to be found in every part of Africa, while one or two extend into Syria. Some of the species of the allied genus *Damaliscus*, such as Hunter's antelope (*D. hunteri*), are also often called hartebeests. (See ANTELOPE.)

HARTFORD, a city and the capital of Connecticut, U.S.A., the county-seat of Hartford county, and a port of entry, coterminous with the township of Hartford, in the west central part of the state, on the W. bank of the Connecticut river, and about 35 m. from Long Island Sound. Pop. (1890), 53,230; (1900), 70,850, of whom 23,758 were foreign-born (including 8076 Irish, 2700 Germans, 2260 Russians, 1952 Italians, 1714 Swedes, 1634 English and 1309 English Canadians); (1910 census) 98,915. Of the total population in 1900, 43,872 were of foreign parentage (both parents foreign-born), and of these 18,410 were of Irish parentage. Hartford is served by two divisions of the New York, New Haven & Hartford railway, by the Central New England railway, by the several electric lines of the Connecticut Company which radiate to the surrounding towns, and by the steamboats of the Hartford & New York Transportation Co., all of which are controlled by the N.Y., N.H. & H. The river, which is navigable to this point, is usually closed from the middle of December to the middle of March.

The city covers an area of 17.7 sq. m.; it is well laid out and compactly built, and streets, parks, &c., are under a city-plan commission authorized in 1907. It is intersected by the sluggish Park river, which is spanned by ten bridges. A stone arch bridge, with nine arches, built of granite at a cost of \$1,700,000 and dedicated in 1908, spans the Connecticut (replacing the old Connecticut river bridge built in 1818 and burned in 1895), and connects Hartford with the village of East Hartford in the township of East Hartford (pop. 1000, 6406), which has important paper-manufacturing and tobacco-growing interests. The park system of Hartford is the largest in any city of the United States in proportion to the city's population. In 1908 there were 21 public parks, aggregating more than 1335 acres. In the extreme

S. of the city is Goodwin Park (about 200 acres); in the S.E. is Colt Park (106 acres), the gift of Mrs Elizabeth Colt, the widow of Samuel Colt, inventor of the Colt revolver; in the S.W. is Pope Park (about 90 acres); in the W. is Elizabeth (100 acres); in the E., along the Connecticut river front, is Riverside (about 80 acres); and in the extreme N. is Keney Park (680 acres), the gift of Henry Keney, and, next to the Metropolitan Reservations near Boston, the largest park in the New England states. Near the centre of the city are the Capitol Grounds (27 acres; until 1872 the campus of Trinity College) and Bushnell Park (41 acres), adjoining Capitol Park. Bushnell Park, named in honour of Horace Bushnell, contains the Corning Memorial Fountain, erected in 1899 and designed by J. Massey Rhind, and three bronze statues, one, by J. Q. A. Ward, of General Israel Putnam; one, by Truman H. Bartlett, of Dr Horace Wells (1815-1848), the discoverer of anaesthesia; and one, by E. S. Woods, of Colonel Thomas Knowlton (1749-1776), a patriot soldier of the War of Independence, killed at the battle of Harlem Heights. On the Capitol Grounds is the state capitol (Richard M. Upjohn, architect), a magnificent white marble building, which was completed in 1880 at a cost of \$2,534,000. Its exterior is adorned with statues and busts of Connecticut statesmen and carvings of scenes in the history of the state. Within the building are regimental flags of the Civil War, a bronze statue by Olin L. Warner of Governor William A. Buckingham, a bronze statue by Karl Gerhardt of Nathan Hale, a bronze tablet (also by Karl Gerhardt) in memory of John Fitch (1743-1798), the inventor; a portrait of Washington, purchased by the state in 1800 from the artist, Gilbert Stuart; and a series of oil portraits of the colonial and state governors. The elaborately carved chair of the lieutenant-governor in the senate chamber, made of wood from the historic Charter Oak, and the original charter of 1662 (or its duplicate of the same date) are preserved in a special vault in the Connecticut state library. A new state library and supreme court building and a new state armoury and arsenal, both of granite, have been (1910) erected upon lands recently added to the Capitol Grounds, thus forming a group of state buildings with the Capitol as the centre. Near the Capitol, at the approach of the memorial bridge across the Park river, is the Soldiers' and Sailors' memorial arch, designed by George Keller and erected by the city in 1885 in memory of the Hartford soldiers and sailors who served in the American Civil War.

Near the centre of the city is the old town square (now known as the City Hall Square), laid off in 1637. Here, facing Main Street, stands the city hall, a beautiful example of Colonial architecture, which was designed by Charles Bulfinch, completed in 1796, and until 1879 used as a state capitol; it has subsequently been restored. In Main Street is the present edifice of the First Church of Christ, known as the Centre Congregational Church, which was organized in Cambridge, Massachusetts, in 1632, and removed to Hartford, under the leadership of Thomas Hooker and Samuel Stone, in 1636. In the adjoining cemetery are the graves of Thomas Hooker, Governor William Leete (1603-1683), and Governor John Haynes, and a monument in memory of 100 early residents of Hartford. In the same thoroughfare is the Wadsworth Athenaeum (built in 1842; enlarged in 1892-1893 and 1907) and its companion buildings, the Colt memorial (built in 1908 to accommodate the Elizabeth Colt art collection) and the Morgan art gallery (built in 1908 by J. Pierpont Morgan in memory of his father, Junius Morgan, a native of Hartford). In this group of buildings are the Hartford public library (containing 90,000 volumes in 1908), the Watkinson library of reference (70,000 volumes in 1908), the library of the Connecticut historical society (25,000 volumes in 1908) and a public art gallery. Other institutions of importance in Hartford are the American school for the deaf (formerly the American asylum for the deaf and dumb), founded in 1816 by Thomas H. Gallaudet; the retreat for the insane (opened for patients in 1824); the Hartford hospital; St Francis hospital; St Thomas's seminary (Roman Catholic); La Salette Missionary college (R.C.; 1898); Trinity college (founded by members of the Protestant Episcopal church, and now non-sectarian), which was

chartered as Washington College in 1823, opened in 1824, renamed Trinity College in 1845, and in 1907-1908 had 27 instructors and 208 students; the Hartford Theological seminary, a Congregational institution, which was founded at East Windsor Hill in 1834 as the Theological Institute of Connecticut, was removed to Hartford in 1865, and adopted its present name in 1885; and, affiliated with the last mentioned institution, the Hartford School of Religious Pedagogy. The Hartford grammar school, founded in 1638, long managed by the town and in 1847 merged with the classical department of the Hartford public high school, is the oldest educational institution in the state. In Farmington Avenue is St Joseph's cathedral (Roman Catholic), the city being the seat of the diocese of Hartford.

During the 18th century Hartford enjoyed a large and lucrative commerce, but the railway development of the 19th century centralized commerce in New York and Boston, and consequently the principal source of the city's wealth has come to be manufacturing and insurance. In 1905 the total value of the "factory" product was \$25,975,651. The principal industries are the manufacture of small arms (by the Colt's Patent Fire-Arms Manufacturing Co., makers of the Colt revolver and the Gatling gun), typewriters (Royal and Underwood), automobiles, bicycles, cyclometers, carriages and wagons, belting, cigars, harness, machinists' tools and instruments of precision, coil-piping, church organs, horse-shoe nails, electric equipment, machine screws, drop forgings, hydrants and valves, and engines and boilers. In 1788 the first woolen mill in New England was opened in Hartford; and here, too, about 1846, the Rogers process of electro-silver plating was invented. The city is one of the most important insurance centres in the United States. As early as 1794 policies were issued by the Hartford Fire Insurance Company (chartered in 1810). In 1909 Hartford was the home city of six fire insurance and six life insurance companies, the principal ones being the Aetna (fire), Aetna Life, Phoenix Mutual Life, Phoenix Fire, Travelers (Life and Accident), Hartford Fire, Hartford Life, National Fire, Connecticut Fire, Connecticut General Life and Connecticut Mutual Life. In 1906 the six fire insurance companies had an aggregate capital of more than \$10,000,000; on the 1st January 1906 they reported assets of about \$59,000,000 and an aggregate surplus of \$30,000,000. In the San Francisco disaster of that year they paid more than \$15,000,000 of losses. Since the fire insurance business began in Hartford, the companies of that city now doing business there have paid about \$340,000,000 in losses. Several large and successful foreign companies have made Hartford their American headquarters. The life insurance companies have assets to the value of about \$225,000,000. The Aetna (fire), Aetna Life, Connecticut Fire, Connecticut Mutual Life, Connecticut General Life, Hartford Fire, Hartford Life, Hartford Steam Boiler Inspection and Insurance Co., National Fire, Orient Fire, Phoenix Mutual Life and Travelers companies have their own homes, some of these being among the finest buildings in Hartford. The city has also large banking interests.

The first settlement on the site of Hartford was made by the Dutch from New Amsterdam, who in 1633 established on the bank of the Connecticut river, at the mouth of the Park river, a fort which they held until 1654. The township of Hartford was one of the first three original townships of Connecticut. The first English settlement was made in 1635 by sixty immigrants, mostly from New Town (now Cambridge), Massachusetts; but the main immigration was in 1636, when practically all the New Town congregation led by Thomas Hooker and Samuel Stone joined those who had preceded them. Their settlement was called Newtown until 1637, when the present name was adopted from Hertford, England, the birthplace of Stone. In 1636 Hartford was the meeting-place of the first general court of the Connecticut colony; the Fundamental Orders, the first written constitution, were adopted at Hartford in 1639; and after the union of the colonies of New Haven and Connecticut, accomplished by the charter of 1662, Hartford became the sole capital; but from 1701 until 1873 that honour was shared with

New Haven. At Hartford occurred in 1687 the meeting of Edmund Andros and the Connecticut officials (see CONNECTICUT). Hartford was first chartered in 1784, was rechartered in 1856 (the charter of that date has been subsequently revised), and in 1881 was made coterminous with the township of Hartford. The city was the literary centre of Federalist ideas in the latter part of the 18th century, being the home of Lemuel Hopkins, John Trumbull, Joel Barlow and David Humphreys, the leading members of a group of authors known as the "Hartford Wits"; and in 1814-1815 the city was the meeting-place of the famous Hartford Convention, an event of great importance in the history of the Federalist party. The War of 1812, with the Embargo Acts (1807-1813), which were so destructive of New England's commerce, thoroughly aroused the Federalist leaders in this part of the country against the National government as administered by the Democrats, and in 1814, when the British were not only threatening a general invasion of their territory but had actually occupied a part of the Maine coast, and the National government promised no protection, the legislature of Massachusetts invited the other New England states to join with her in sending delegates to a convention which should meet at Hartford to consider their grievances, means of preserving their resources, measures of protection against the British, and the advisability of taking measures to bring about a convention of delegates from all the United States for the purpose of revising the Federal constitution. The legislatures of Connecticut and Rhode Island, and town meetings in Cheshire and Grafton counties (New Hampshire) and in Windham county (Vermont) accepted the invitation, and the convention, composed of 12 delegates from Massachusetts, 7 from Connecticut, 4 from Rhode Island, 2 from New Hampshire and 1 from Vermont, all Federalists, met on the 15th of December 1814, chose George Cabot of Massachusetts president and Theodore Dwight of Connecticut secretary, and remained in secret session until the 5th of January 1815, when it adjourned *sine die*. At the conclusion of its work it recommended greater military control for each of the several states and that the Federal constitution be so amended that representatives and direct taxes should be apportioned among the several states "according to their respective numbers of free persons," that no new state should be admitted to the Union without the concurrence of two-thirds of both Houses of Congress, that Congress should not have the power to lay an embargo for more than sixty days, that the concurrence of two-thirds of the members of both Houses of Congress should be necessary to pass an act "to interdict the commercial intercourse between the United States and any foreign nation or the dependencies thereof" or to declare war against any foreign nation except in case of actual invasion, that "no person who shall hereafter be naturalized shall be eligible, as a member of the Senate or House of Representatives of the United States, nor capable of holding any civil office under the authority of the United States," and that "the same person shall not be elected president of the United States a second time; nor shall the president be elected from the same state two terms in succession." After making these recommendations concerning amendments the Convention resolved: "That if the application of these states to the government of the United States, recommended in a foregoing resolution, should be unsuccessful, and peace should not be concluded, and the defence of these states should be neglected, as it has been since the commencement of the war, it will, in the opinion of this convention, be expedient for the legislatures of the several states to appoint delegates to another convention, to meet at Boston in the state of Massachusetts on the third Thursday of June next, with such powers and instructions as the exigency of a crisis so momentous may require." The legislatures of Massachusetts and Connecticut approved of these proposed amendments and sent commissioners to Washington to urge their adoption, but before their arrival the war had closed, and not only did the amendments fail to receive the approval of any other state, but the legislatures of nine states expressed their disapproval of the Hartford Convention itself, some charging it with sowing "seeds of dissension and

disunion." The cessation of the war brought increased popularity to the Democratic administration, and the Hartford Convention was vigorously attacked throughout the country.

Hartford was the birthplace of Noah Webster, who here published his *Grammatical Institute of the English Language* (1783-1785), and of Henry Barnard, John Fiske and Frederick Law Olmsted, and has been the home of Samuel P. Goodrich (Peter Parley), George D. Prentice, Harriet Beecher Stowe, Charles Dudley Warner, Samuel L. Clemens (Mark Twain) and Horace Bushnell. More than 100 periodicals have been established in Hartford, of which the oldest is the *Hartford Courant* (1764), the oldest newspaper in the United States. This paper was very influential in shaping public opinion in the years preceding the War of Independence; after the war it was successively Federalist, Whig and Republican. *The Times* (semi-weekly 1817; daily 1841) was one of the most powerful Democratic organs in the period before the middle of the 19th century, and had Gideon Wells for editor 1826-1836. The *Congregationalist* (afterwards published in Boston) and the *Churchman* (afterwards published in New York) were also founded at Hartford.

See *Scena, Hartford in the Olden Times: Its First Thirty Years* (Hartford, 1853), edited by W. M. B. Hartley; and J. H. Trumbull, *Memorial History of Hartford County* (Boston, 1886). For the Hartford Convention see *History of the Hartford Convention* (Boston, 1833), published by its secretary, Theodore Dwight; H. C. Lodge, *Life and Letters of George Cabot* (Boston, 1877); and Henry Adams, *Documents Relating to New England Federalism* (Boston, 1877).

HARTFORD CITY, a city and the county-seat of Blackford county, Indiana, U.S.A., 62 m. N.E. of Indianapolis. Pop. (1890) 2287; (1900) 5912 (572 foreign-born); (1910) 6187. The city is served by the Fort Wayne, Cincinnati & Louisville, and the Pittsburg, Cincinnati, Chicago & St. Louis railways, and the Indiana Union Traction line (electric). There are oil and natural gas wells in the vicinity, and the city has pulp and paper mills, glass and tile works, and manufactories of woodenware, and nitro-glycerine and powder. The municipality owns and operates its water-works system. The first settlement in the vicinity was made in 1832. Hartford City became the county-seat of Blackford county when that county was erected in 1837; it was laid out in 1839 and was first incorporated as a town in 1867.

HARTIG, GEORG LUDWIG (1764-1837), German agriculturist and writer on forestry, was born at Gladenbach, near Marburg, on the 2nd of September 1764. After obtaining a practical knowledge of forestry at Harzburg, he studied from 1781 to 1783 at the university of Giessen. In 1786 he became manager of forests to the prince of Solms-Braunfels at Hungen in the Wetterau, where he founded a school for the teaching of forestry. After obtaining in 1797 the appointment of inspector of forests to the prince of Orange-Nassau, he continued his school of forestry at Dillenburg, where the attendance thereat increased considerably. On the dissolution of the principality by Napoleon I. in 1805 he lost his position, but in 1806 he went as chief inspector of forests to Stuttgart, whence in 1811 he was called to Berlin in a like capacity. There he continued his school of forestry, and succeeded in connecting it with the university of Berlin, where in 1830 he was appointed an honorary professor. He died at Berlin on the 2nd of February 1837. His son Theodor (1805-1880), and grandson Robert (1839-1901), were also distinguished for their contributions to the study of forestry.

G. L. Hartig was the author of a number of valuable works: *Lehrbuch für Jäger* (Stuttgart, 1810); *Lehrbuch für Förster* (3 vols., Stuttgart, 1808); *Kubiktabellen für geschmillene, beschlagene, und runde Hölzer* (1815, 10th ed. Berlin, 1871); and *Lexikon für Jäger und Jagdfreunde* (1836, 2nd ed. Berlin, 1859-1861). Theodor Hartig and his son Robert also published numerous works dealing with forestry, one of the latter's books being translated into English by W. Somerville and H. Marshall Ward as *Diseases of Trees* (1894).

HARTLEPOOL, a parliamentary borough of Durham, England, embracing the municipal borough of Hartlepool or East Hartlepool and the municipal and county borough of West Hartlepool. Pop. (1901) of Hartlepool, 22,723; of West Hartlepool, 62,627. The towns are on the coast of the North Sea separated by Hartlepool Bay, with a harbour, and both have stations on branches of

the North Eastern railway, 247 m. N. by W. from London. The surrounding country is bleak, and the coast is low. Caves occur in the slight cliffs, and protection against the attacks of the waves has been found necessary. The ancient market town of Hartlepool lies on a peninsula which forms the termination of a south-eastward sweep of the coast and embraces the bay. Its naturally strong position was formerly fortified, and part of the walls, serving as a promenade, remain. The parish church of St Hilda, standing on an eminence above the sea, is late Norman and Early English, with a massive tower, heavily buttressed. There is a handsome borough hall in Italian style. West Hartlepool, a wholly modern town, has several handsome modern churches, municipal buildings, exchange, market hall, Athenaeum and public library. The municipal area embraces the three townships of Seaton Carew, a seaside resort with good bathing, and golf links; Stranton, with its church of All Saints, of the 14th century, on a very early site; and Throston.

The two Hartlepoools are officially considered as one port. The harbour, which embraces two tidal basins and six docks aggregating 83½ acres, in addition to timber docks of 57 acres, covers altogether 350 acres. There are five graving docks, admitting vessels of 550 ft. length and 10 to 21 ft. draught. The depth of water on the dock sills varies from 17½ ft. at neap tides to 25 ft. at spring tides. A breakwater three-quarters of a mile long protects the entrance to the harbour. An important trade is carried on in the export of coal, ships, machinery, iron and other metallic ores, woollens and cottons, and in the import of timber, sugar, iron and copper ores, and eggs. Timber makes up 59 % of the imports, and coal and ships each about 30% of the exports. The principal industries are shipbuilding (iron), boiler and engineering works, iron and brass foundries, steam saw and planing mills, flour-mills, paper and paint factories, and soapworks.

The parliamentary borough (falling within the south-east county division) returns one member. The municipal borough of Hartlepool is under a mayor, 6 aldermen and 18 councillors, and has an area of 972 acres. The municipal borough of West Hartlepool is under a mayor, 8 aldermen and 24 councillors, and has an area of 2684 acres.

Built on the horns of a sheltered bay, Hartlepool (Hertepull, Hertipol), grew up round the monastery founded there in 640, but was destroyed by the Danes in 800 and rebuilt by Egred, bishop of Lindisfarne. In 1173 Bishop Hugh de Puiset allowed French and Flemish troops to land at Hartlepool to aid the Scots. It is not mentioned in Boldon Book as, being part of the royal manor of Sadberg held at this time by the family of Bruce, it did not become the property of the see of Durham until the purchase of that manor in 1189. The bishops did not obtain possession until the reign of John, who during the interval in 1201 gave Hartlepool a charter granting the burgesses the same privileges that the burgesses of Newcastle enjoyed; in 1230 Bishop Richard Poor granted further liberties, including a gild merchant. Edward II. seized the borough as a possession of Robert Bruce, but he could control it very slightly owing to the bishop's powers. In 1328 Edward III. granted the borough 100 marks towards the town-wall and Richard II. granted murage for seven years, the term being extended in 1400. In 1383 Bishop Fordham gave the burgesses licence to receive tolls within the borough for the maintenance of the walls, while Bishop Neville granted a commission for the construction of a pier or mole. In the 16th century Hartlepool was less prosperous; in 1523 the haven was said to be ruined, the fortifications decayed. An act of 1535 declared Hartlepool to be in Yorkshire, but in 1554 it was reinstated in the county of Durham. It fell into the hands of the northern earls in 1563, and a garrison was maintained there after the rebellion was crushed. In 1593 Elizabeth incorporated it, and gave the burgesses a town hall and court of pie powder. During the civil wars Hartlepool, which a few years before was said to be the only port town in the country, was taken by the Scots, who maintained a garrison there until 1647. As a borough of the Palatinate Hartlepool was not represented in parliament until the 19th century, though strong arguments in its favour were advanced in the Commons in 1614. The markets of

Hartlepool were important throughout the middle ages. In 1216 John confirmed to Robert Bruce the market on Wednesday granted to his father and the fair on the feast of St Lawrence; this fair was extended to fifteen days by the grant of 1230, while the charter of 1595 also granted a fair and market. During the 14th century trade was carried on with Germany, Spain and Holland, and in 1346 Hartlepool provided five ships for the French war, being considered one of the chief seaports in the kingdom. The markets were still considerable in Camden's day, but declined during the 18th century, when Hartlepool became fashionable as a watering-place.

HARTLEY, SIR CHARLES AUGUSTUS (1825-), English engineer, was born in 1825 at Heworth, Durham. Like most engineers of his generation he was engaged in railway work in the early part of his career, but subsequently he devoted himself to hydraulic engineering and the improvement of estuaries and harbours for the purposes of navigation. He was employed in connexion with some of the largest and most important waterways of the world. After serving in the Crimea as a captain of engineers in the Anglo-Turkish contingent, he was in 1856 appointed engineer-in-chief for the works carried out by the European Commission of the Danube for improving the navigation at the mouths of that river, and that position he retained till 1872, when he became consulting engineer to the Commission (see DANUBE). In 1875 he was one of the committee appointed by the authority of the U.S.A. Congress to report on the works necessary to form and maintain a deep channel through the south pass of the Mississippi delta; and in 1884 the British government nominated him a member of the international technical commission for widening the Suez Canal. In addition he was consulted by the British and other governments in connexion with many other river and harbour works, including the improvement of the navigation of the Scheldt, Hugli, Don and Dnieper, and of the ports of Odessa, Trieste, Kustendjic, Burgas, Varna and Durban. He was knighted in 1862, and became K.C.M.G. in 1884.

HARTLEY, DAVID (1705-1757), English philosopher, and founder of the Associationist school of psychologists, was born on the 30th of August 1705. He was educated at Bradford grammar school and Jesus College, Cambridge, of which society he became a fellow in 1727. Originally intended for the Church, he was deterred from taking orders by certain scruples as to signing the Thirty-nine Articles, and took up the study of medicine. Nevertheless, he remained in the communion of the English Church, living on intimate terms with the most distinguished churchmen of his day. Indeed he asserted it to be a duty to obey ecclesiastical as well as civil authorities. The doctrine to which he most strongly objected was that of eternal punishment. Hartley practised as a physician at Newark, Bury St Edmunds, London, and lastly at Bath, where he died on the 28th of August 1757. His *Observations on Man* was published in 1749, three years after Condillac's *Essai sur l'origine des connaissances humaines*, in which theories essentially similar to his were expounded. It is in two parts—the first dealing with the frame of the human body and mind, and their mutual connexions and influences, the second with the duty and expectations of mankind. His two main theories are the doctrine of vibrations and the doctrine of associations. His physical theory, he tells us, was drawn from certain speculations as to nervous action which Newton had published in his *Principia*. His psychological theory was suggested by the *Dissertation concerning the Fundamental Principles of Virtue or Morality*, which was written by a clergyman named John Gay (1699-1745), and prefixed by Bishop Law to his translation¹ of Archbishop King's Latin work on the *Origin of Evil*, its chief object being to show that sympathy and conscience are developments by means of association from the selfish feelings.

The outlines of Hartley's theory are as follows. With Locke he asserted that, prior to sensation, the human mind is a blank. By a growth from simple sensations those states of consciousness which appear most remote from sensation come into being. And the one

law of growth of which Hartley took account was the law of contiguity, synchronous and successive. By this law he sought to explain, not only the phenomena of memory, which others had similarly explained before him, but also the phenomena of emotion, of reasoning, and of voluntary and involuntary action (see ASSOCIATION OF IDEAS).

By his physical theory Hartley gave the first strong impulse to the modern study of the intimate connexion of physiological and psychical facts which has proved so fruitful, though his physical theory in itself is inadequate, and has not been largely adopted. He held that sensation is the result of a vibration of the minute particles of the medullary substance of the nerves, to account for which he postulated, with Newton, a subtle elastic ether, rare in the interstices of solid bodies and in their close neighbourhood, and denser as it recedes from them. Pleasure is the result of moderate vibrations, pain of vibrations so violent as to break the continuity of the nerves. These vibrations leave behind them in the brain a tendency to fainter vibrations or "vibratuncles" of a similar kind, which correspond to "ideas of sensation." Thus memory is accounted for. The course of reminiscence and of the thoughts generally, when not immediately dependent upon external sensation, is accounted for on the ground that there are always vibrations in the brain on account of its heat and the pulsation of its arteries. What these vibrations shall be is determined by the nature of each man's past experience, and by the influence of the circumstances of the moment, which causes now one another tendency to prevail over the rest. Sensations which are often associated together become each associated with the ideas corresponding to the others; and the ideas corresponding to the associated sensations become associated together, sometimes so intimately that they form what appears to be a new simple idea, not without careful analysis resolvable into its component parts.

Starting, like the modern Associationists, from a detailed account of the phenomena of the senses, Hartley tries to show how, by the above laws, all the emotions, which he analyses with considerable skill, may be explained. Locke's phrase "association of ideas" is employed throughout, "idea" being taken as including every mental state but sensation. He emphatically asserts the existence of pure disinterested sentiment, while declaring it to be a growth from the self-regarding feelings. Voluntary action is explained as the result of a firm connexion between a motion and a sensation or "idea," and, on the physical side, between an "ideal" and a motory vibration. Therefore in the Freewill controversy Hartley took his place as a determinist. It is singular that, as he tells us, it was only with reluctance, and when his speculations were nearly complete, that he came to a conclusion on this subject in accordance with his theory.

See life of Hartley by his son in the 1801 edition of the *Observations*, which also contains notes and additions translated from the German of H. A. Pistorius; Sir Leslie Stephen, *History of English Thought in the Eighteenth Century* (3rd ed., 1902), and article in the *Dictionary of National Biography*; G. S. Bower, *Hartley and James Mill* (1881); B. Schönlanke, *Hartley und Priestley die Begründer des Associationismus in England* (1882). See also the histories of philosophy and bibliography in J. M. Baldwin's *Dictionary of Philosophy and Psychology* (1905), vol. iii.

HARTLEY, JONATHAN SCOTT (1845-), American sculptor, was born at Albany, New York, on the 23rd of September 1845. He was a pupil of E. D. Palmer, New York, and of the schools of the Royal Academy, London; he later studied for a year in Berlin and for a year in Paris. His first important work (1882) was a statue of Miles Morgan, the Puritan, for Springfield, Mass. Among his other works are the Daguerre monument in Washington; "Thomas K. Beecher," Elmira, New York, and "Alfred the Great," Appellate Court House, New York. He devoted himself particularly to the making of portrait busts, in which he attained high rank. In 1891 he became a member of the National Academy of Design.

HARTLIB, SAMUEL (c. 1599-c. 1670), English writer on education and agriculturist, was born towards the close of the 16th century at Elbing in Prussia, his father being a refugee merchant from Poland. His mother was the daughter of a rich English merchant at Danzig. About 1628 Hartlib went to England, where he carried on a mercantile agency, and at the same time found leisure to enter with interest into the public questions of the day. An enthusiastic admirer of Comenius, he published in 1637 his *Conatuum Comenianorum proeludia*, and in 1639 *Comenii pansophiae prodromus et didactica dissertatio*. In 1641 appeared his *Relation of that which hath been lately attempted to procure Ecclesiastical Peace among Protestants*, and *A Description of Macaria*, containing his ideas of what a model state should be. During the civil war Hartlib occupied himself

¹ Anonymously in the 1731 ed., with acknowledgment in the 1758 ed.

with the peaceful study of agriculture, publishing various works by himself, and printing at his own expense several treatises by others on the subject. In 1652 he issued a second edition of the *Discourse of Flanders Husbandry* by Sir Richard Weston (1645); and in 1651 *Samuel Hartlib, his Legacy, or an Enlargement of the Discourse of Husbandry used in Brabant and Flanders*, by Robert Child. For his various labours Hartlib received from Cromwell a pension of £100, afterwards increased to £300, as he had spent all his fortune on his experiments. He planned a school for the sons of gentlemen, to be conducted on new principles, and this probably was the occasion of his friend Milton's *Tractate on Education*, addressed to him in 1644, and of Sir William Petty's *Two Letters* on the same subject, in 1647 and 1648. At the Restoration Hartlib lost his pension, which had already fallen into arrears; he petitioned parliament for a new grant of it, but what success he met with is unknown, as his latter years and death are wrapped in obscurity. A letter from him is known to have been written in February 1661-1662, and apparently he is referred to by Andrew Marvell as alive in 1670 and fleeing to Holland from his creditors.

A *Biographical Memoir of Samuel Hartlib*, by H. Dircks, appeared in 1865.

HARTMANN, KARL ROBERT EDUARD VON (1842-1906), German philosopher, was born in Berlin on the 23rd of February 1842. He was educated for the army, and entered the artillery of the Guards as an officer in 1860, but a malady of the knee, which crippled him, forced him to quit the service in 1865. After some hesitation between music and philosophy, he decided to make the latter the serious work of his life, and in 1867 the university of Rostock conferred on him the degree of doctor of philosophy. He subsequently returned to Berlin, and died at Grossichterfelde on the 5th of June 1906. His reputation as a philosopher was established by his first book, *The Philosophy of the Unconscious* (1869; 10th ed. 1890). This success was largely due to the originality of its title, the diversity of its contents (von Hartmann professing to obtain his speculative results by the methods of inductive science, and making plentiful use of concrete illustrations), the fashionableness of its pessimism and the vigour and lucidity of its style. The conception of the Unconscious, by which von Hartmann describes his ultimate metaphysical principle, is not at bottom as paradoxical as it sounds, being merely a new and mysterious designation for the Absolute of German metaphysicians. The Unconscious appears as a combination of the metaphysical of Hegel with that of Schopenhauer. The Unconscious is both Will and Reason and the absolute all-embracing ground of all existence. Von Hartmann thus combines "pantheism" with "panlogism" in a manner adumbrated by Schelling in his "positive philosophy." Nevertheless Will and not Reason is the primary aspect of the Unconscious, whose melancholy career is determined by the primacy of the Will and the subservience of the Reason. Preconsciously the Will is potential and the Reason latent, and the Will is void of reason when it passes from potentiality to actual willing. This latter is absolute misery, and to cure it the Unconscious evokes its Reason and with its aid creates the best of all possible worlds, which contains the promise of its redemption from actual existence by the emancipation of the Reason from its subjugation to the Will in the conscious reason of the enlightened pessimist. When the greater part of the Will in existence is so far enlightened by reason as to perceive the inevitable misery of existence, a collective effort to will non-existence will be made, and the world will relapse into nothingness, the Unconscious into quiescence. Although von Hartmann is a pessimist, his pessimism is by no means unmitigated. The individual's happiness is indeed unattainable either here and now or hereafter and in the future, but he does not despair of ultimately releasing the Unconscious from its sufferings. He differs from Schopenhauer in making salvation by the "negation of the Will-to-live" depend on a collective social effort and not on individualistic asceticism. The conception of a redemption of the Unconscious also supplies the ultimate basis of von Hartmann's ethics. We must provisionally affirm life and devote ourselves to social

evolution, instead of striving after a happiness which is impossible; in so doing we shall find that morality renders life less unhappy than it would otherwise be. Suicide, and all other forms of selfishness, are highly reprehensible. Epistemologically von Hartmann is a transcendental realist, who ably defends his views and acutely criticizes those of his opponents. His realism enables him to maintain the reality of Time, and so of the process of the world's redemption.

Von Hartmann's numerous works extend to more than 12,000 pages. They may be classified into—A. Systematical, including *Grundprobleme der Erkenntnistheorie; Kategorienlehre; Das zeitliche Bewusstsein; Die Philosophie des Schönen; Die Religion des Geistes; Die Philosophie des Unbewussten* (3 vols., which now include his, originally anonymous, self-criticism, *Das Unbewusste vom Standpunkte der Physiologie und Descendenztheorie*, and its refutation, Eng. trans. by W. C. Coupland, 1884); *System der Philosophie im Grundriss*, 1. *Grundriss der Erkenntnistheorie; Kritische Methode*; 2. *Das religiöse Bewusstsein der Menschheit; Geschichte der Metaphysik* (3 vols.); *Kant's Erkenntnistheorie; Kritische Grundlegung des transscendentalen Realismus; Über die dialektische Methode*; studies of Schelling, Lotze, von Kirchmann; *Zur Geschichte des Pessimismus; Neukantianismus; Schopenhauerismus; Hegelianismus; Geschichte der deutschen Ästhetik seit Kant; Die Krisis des Christentums in der modernen Theologie; Philosophische Fragen der Gegenwart; Ethische Studien; Moderne Psychologie; Das Christentum des neuen Testaments; Die Weltanschauung der modernen Physik*. C. Popular—*Soziale Kernfragen; Moderne Probleme; Tagesfragen; Zwei Jahrzehnte deutscher Politik; Das Judentum in Gegenwart und Zukunft; Die Selbstzerstörung des Christentums; Gesammelte Studien; Der Spiritismus und die Geisterhypothese des Spiritismus; Zur Zeitgeschichte*. His select works have been published in 10 volumes (2nd ed., 1885-1896). On his philosophy see R. Köber, *Das philosophische System Eduard von Hartmanns* (1884); O. Plümacher, *Der Kampf uns Unbewusste* (2nd ed., 1890), with a chronological table of the Hartmann literature from 1868 to 1890; A. Drews, *E. von Hartmanns Philosophie und der Materialismus in der modernen Kultur* (1890) and *E. von Hartmanns philosophisches System im Grundriss* (1902), with biographical introduction; and for further authorities, J. M. Baldwin, *Dictionary of Philosophy and Psychology* (1901-1905).

HARTMANN, MORITZ (1821-1872), German poet and author, was born of Jewish parentage at Duschnik in Bohemia on the 15th of October 1821. Having studied philosophy at Prague and Vienna, he travelled in south Germany, Switzerland and Italy, and became tutor in a family at Vienna. In 1845 he proceeded to Leipzig and there published a volume of patriotic poems, *Kelch und Schwert* (1845). Fearing in consequence prosecution at the hands of the authorities, he abided events in France and Belgium, and after issuing in Leipzig *Neuere Gedichte* (1846) returned home, suffered a short term of imprisonment, and in 1848 was elected member for Leitmeritz in the short-lived German parliament at Frankfort-on-Main, in which he sided with the extreme Radical party. He took part with Robert Blum (1807-1848) in the revolution of that year in Vienna, but contrived to escape to London and Paris. In 1849 he published *Reimchronik des Pfaffen Mauritius*, a satirical political poem in the style of Heine. During the Crimean War (1854-56) Hartmann was correspondent of the *Kölnische Zeitung*, settled in 1860 in Geneva as a teacher of German literature and history, became in 1865 editor of the *Freie* in Stuttgart and in 1868 a member of the staff of the *Neue Freie Presse* in Vienna. He died at Oberdöbling near Vienna on the 13th of May 1872.

Among Hartmann's numerous works may be especially mentioned *Der Krieg um den Wald* (1850), a novel, the scene of which is laid in Bohemia; *Tagebuch aus Langwedoc und Provence* (1852); *Erzählungen eines Unsteten* (1853); and *Die letzten Tage eines Königs* (1867). His idyll, *Adam und Eva* (1851), and his collection of poetical tales, *Schatten* (1851), show that the author possessed but little talent for epic narrative. Hartmann's poems are often lacking in genuine poetical feeling, but the love of liberty which inspired them, and the fervour, ease and clearness of their style compensated for these shortcomings and gained for him a wide circle of admirers.

His *Gesammelte Werke* were published in 10 vols. in 1873-1874, and a selection of his *Gedichte* in the latter year. The first two volumes of a new edition of his works contain a biography of Hartmann by O. Wittner. See also E. Ziel, "Moritz Hartmann" (in *Unsere Zeit*, 1872); A. Marchand, *Les Poètes lyriques de l'Autriche* (1892); Brandes, *Das junge Deutschland* (Charlottenburg, 1899).

HARTMANN VON AUE (c. 1170-c. 1210), one of the chief Middle High German poets. He belonged to the lower nobility of Swabia, where he was born about 1170. After receiving a monastic education, he became retainer (*dienslman*) of a nobleman whose domain, Aue, has been identified with Obernau on the Neckar. He also took part in the Crusade of 1196-97. The date of his death is as uncertain as that of his birth; he is mentioned by Gottfried von Strassburg (c. 1210) as still alive, and in the *Krons* of Heinrich von dem Türlin, written about 1220, he is mourned for as dead. Hartmann was the author of four narrative poems which are of importance for the evolution of the Middle High German court epic. The oldest of these, *Erec*, which may have been written as early as 1191 or 1192, and the latest and ripest, *Iwein*, belong to the Arthurian cycle and are based on epics by Chrétien de Troyes (*q.v.*); between them lie the romance, *Gregorius*, also an adaptation of a French epic, and *Der arme Heinrich*, one of the most charming specimens of medieval German poetry. The theme of the latter—the cure of the leper, Heinrich, by a young girl who is willing to sacrifice her life for him—Hartmann had evidently found in the annals of the family in whose service he stood. Hartmann's most conspicuous merit as a poet lies in his style; his language is carefully chosen, his narrative lucid, flowing and characterized by a sense of balance and proportion which is rarely to be found in German medieval poetry. *Gregorius*, *Der arme Heinrich* and his lyrics, which are all fervidly religious in tone, imply a tendency towards asceticism, but, on the whole, Hartmann's striving seems rather to have been to reconcile the extremes of life; to establish a middle way of human conduct between the worldly pursuits of knighthood and the ascetic ideals of medieval religion.

Erec has been edited by M. Haupt (2nd ed., Leipzig, 1871); *Gregorius*, by H. Paul (2nd ed., Halle, 1900); *Der arme Heinrich*, by W. Wackernagel and W. Toischer (Basel, 1885) and by H. Paul (2nd ed., Halle, 1893); by J. G. Robertson (London, 1895), with English notes; *Iwein*, by G. F. Beeneck and K. Lachmann (4th ed., Berlin, 1877) and E. Henrici (Halle, 1891-1893). A convenient edition of all Hartmann's poems by F. Bech, 3 vols. (3rd ed., Leipzig, 1891-1893, vol. 3 in 4th ed., 1902).

The literature on Hartmann is extensive. See especially L. Schmid, *Des Minnesingers Hartmann von Aue Stand, Heimat und Geschlecht* (Tübingen, 1874); H. Röttcken, *Die epische Kunst Heinrichs von Veldeke und Hartmanns von Aue* (Halle, 1887); F. Saran, *Hartmann von Aue als Lyriker* (Halle, 1889); A. E. Schönbach, *Über Hartmann von Aue* (Graz, 1894); F. Piquet, *Étude sur Hartmann d'Aue* (Paris, 1898). Translations have been made into modern German of all Hartmann's poems, while *Der arme Heinrich* has repeatedly attracted the attention of modern poets, both English (Longfellow, Rossetti) and German (notably, Gerhart Hauptmann). See H. Tardel, *Der arme Heinrich in der neueren Dichtung* (Berlin, 1905).

HARTSHORN, SPIRITS OF, a name signifying originally the ammoniacal liquor obtained by the distillation of horn shavings, afterwards applied to the partially purified similar products of the action of heat on nitrogenous animal matter generally, and now popularly used to designate the aqueous solution of ammonia (*q.v.*).

HARTZENBUSCH, JUAN EUGENIO (1806-1880). Spanish dramatist, was born at Madrid on the 6th of September 1806. The son of a German carpenter, he was educated for the priesthood, but he had no religious vocation and, on leaving school, followed his father's trade till 1830, when he learned shorthand and joined the staff of the *Gaceta*. His earliest dramatic essays were translations from Molière, Voltaire and the elder Dumas; he next recast old Spanish plays, and in 1837 produced his first original play, *Los Amantes de Teruel*, the subject of which had been used by Rey de Artieda, Tirso de Molina and Perez de Montalbán. *Los Amantes de Teruel* at once made the author's reputation, which was scarcely maintained by *Doña Mencía* (1839) and *Alfonso el Casto* (1841); it was not till 1845 that he approached his former success with *La Jura en Santa Gadea*. Hartzenbusch was chief of the National Library from 1862 to 1875, and was an indefatigable—though not very judicious—editor of many national classics. Inferior in inspiration to other contemporary Spanish dramatists, Hartzenbusch excels his rivals in versatility and in conscientious workmanship.

HĀRŪN AL-RASHĪD (763 or 766-809), *i.e.* "Hārūn the Orthodox," the fifth of the 'Abbasid caliphs of Bagdad, and the second son of the third caliph Mahdi. His full name was Hārūn ibn Muḥammad ibn 'Abdallāh ibn Muḥammad ibn 'Alī ibn 'Abdallāh ibn 'Abbās. He was born at Rai (Rhagae) on the 20th of March A.D. 763, according to some accounts, and according to others on the 15th of February A.D. 766. Hārūn al-Rashīd was twenty-two years old when he ascended the throne. His father Mahdi just before his death conceived the idea of superseding his elder son Mūsā (afterwards known as Hādī, the fourth caliph) by Hārūn. But on Mahdi's death Hārūn gave way to his brother. For the campaigns in which he took part prior to his accession see CALIPHATE, section C, *The Abbasids*, §§ 3 and 4.

Rashīd owed his succession to the throne to the prudence and sagacity of Yahyā b. Khālid the Barmecide, his secretary, whom on his accession he appointed his lieutenant and grand vizier (see BARMECIDES). Under his guidance the empire flourished on the whole, in spite of several revolts in the provinces by members of the old Alid family. Successful wars were waged with the rulers of Byzantium and the Khazars. In 803, however, Hārūn became suspicious of the Barmecides, whom with only a single exception he caused to be executed. Henceforward the chief power was exercised by Fadl b. Rabi', who had been chamberlain not only under Hārūn himself but under his predecessors, Manṣūr, Madhi and Hādī. In the later years of Hārūn's reign troubles arose in the eastern parts of the empire. These troubles assumed proportions so serious that Hārūn himself decided to go to Khorasan. He died, however, at Tus in March 809.

The reign of Hārūn (see CALIPHATE, section C, § 5) was one of the most brilliant in the annals of the caliphate, in spite of losses in north-west Africa and Transoxiana. His fame spread to the West, and Charlemagne and he exchanged gifts and compliments as masters respectively of the West and the East. No caliph ever gathered round him so great a number of learned men, poets, jurists, grammarians, cadis and scribes, to say nothing of the wits and musicians who enjoyed his patronage. Hārūn himself was a scholar and poet, and was well versed in history, tradition and poetry. He possessed taste and discernment, and his dignified demeanour is extolled by the historians. In religion he was extremely strict; he prostrated himself a hundred times daily, and nine or ten times made the pilgrimage to Mecca. At the same time he cannot be regarded as a great administrator. He seems to have left everything to his viziers Yahyā and Fadl, to the former of whom especially was due the prosperous condition of the empire. Hārūn is best known to Western readers as the hero of many of the stories in the *Arabian Nights*; and in Arabic literature he is the central figure of numberless anecdotes and humorous stories. Of his incognito walks through Bagdad, however, the authentic histories say nothing. His Arabic biographers are unanimous in describing him as noble and generous, but there is little doubt that he was in fact a man of little force of character, suspicious, untrustworthy and on occasions cruel.

See the Arabic histories of Ibn al-Athīr and Ibn Khaldūn. Among modern works see Sir W. Muir, *The Caliphate* (London, 1891); R. D. Osborn, *Islam under the Khalifs of Bagdad* (London, 1878); Gustav Weil, *Geschichte der Chalifen* (Mannheim and Stuttgart, 1846-1862); G. le Strange, *Bagdad during the Abbasid Caliphate* (Oxford, 1900); A. Müller, *Der Islam*, vol. I. (Berlin, 1885); E. H. Palmer, *The Caliph Harun Ar-Rashid* (London, 1880); J. B. Bury's edition of Gibbon's *Decline and Fall* (London, 1898), vol. vi. pp. 34 foll.

HARUSPICES, or ARUSPICES (perhaps "entail observers," cf. Skt. *kira*, Gr. *χορδή*), a class of soothsayers in Rome. Their art (*disciplina*) consisted especially in deducing the will of the gods from the appearance presented by the entrails of the slain victim. They also interpreted all portents or unusual phenomena of nature, especially thunder and lightning, and prescribed the expiatory ceremonies after such events. To please the god, the victim must be without spot or blemish, and the practice of observing whether the entrails presented any abnormal appearance,

and thence deducing the will of heaven, was also very important in Greek religion. This art, however, appears not to have been, as some other modes of ascertaining the will of the gods undoubtedly were, of genuine Aryan growth. It is foreign to the Homeric poems, and must have been introduced into Greece after their composition. In like manner, as the Romans themselves believed, the art was not indigenous in Rome, but derived from Etruria.¹ The Etruscans were said to have learned it from a being named Tages, grandson of Jupiter, who had suddenly sprung from the ground near Tarquinii. Instructions were contained in certain books called *libri haruspicini, fulgurales, rituales*. The art was practised in Rome chiefly by Etruscans, occasionally by native-born Romans who had studied in the priestly schools of Etruria. From the regal period to the end of the republic, haruspices were summoned from Etruria to deal with prodigies not mentioned in the pontifical and Sibylline books, and the Roman priests carried out their instructions as to the offering necessary to appease the anger of the deity concerned. Though the art was of great importance under the early republic, it never became a part of the state religion. In this respect the haruspices ranked lower than the augurs, as is shown by the fact that they received a salary; the augurs were a more ancient and purely Roman institution, and were a most important element in the political organization of the city. In later times the art fell into disrepute, and the saying of Cato the Censor is well known, that he wondered how one haruspex could look another in the face without laughing (*Cic. De div. ii. 24*). Under the empire, however, we hear of a regular collegium of sixty haruspices; and Claudius is said to have tried to restore the art and put it under the control of the pontifices. This collegium continued to exist till the time of Alaric.

See A. Bouché-Leclercq, *Histoire de la divination dans l'antiquité* (1879-1881); Marquardt, *Römische Staatsverwaltung*, iii. (1885), pp. 410-415; G. Schmeisser, *Die etruskische Disciplin vom Bundesgenossenkrieg bis zum Untergang des Heidentums* (1881), and *Quæstionum de Etrusca disciplina partícula* (1872); P. Clairin, *De haruspibus apud Romanos* (1880). Also OMEN.

HARVARD UNIVERSITY, the oldest of American educational institutions, established at Cambridge, Massachusetts. In 1636 the General Court of the colony voted £400 towards "a schoole or college," which in the next year was ordered to be at "New Towne." In memory of the English university where many (probably some seventy) of the leading men of the colony had been educated, the township was named Cambridge in 1638. In the same year John Harvard (1607-1638), a Puritan minister lately come to America, a bachelor and master of Emmanuel college, Cambridge, dying in Charlestown (Mass.), bequeathed to the wilderness seminary half his estate (£780) and some three hundred books; and the college, until then unorganized, was named Harvard College (1639) in his honour. Its history is unbroken from 1640, and its first commencement was held in 1642. The spirit of the founders is beautifully expressed in the words of a contemporary letter which are carved on the college gates: "After God had carried us safe to New-England, and wee had builded our houses, provided necessities for our liveli-hood, rear'd convenient places for Gods worship, and settled the Civill Government, One of the next things we longed for, and looked after was to advance *Learning*, and perpetuate it to Posterity, dreading to leave an illiterate Ministry to the Churches, when our present Ministers shall lie in the Dust." The college charter of 1650 dedicated it to "the advancement of all good literature, arts, and sciences," and "the education of the English and Indian youth . . . in knowledge and godlynes." The second building (1654) on the college grounds was called "the Indian College." In it was set up the College press, which since 1638 had been in the president's house, and here, it is believed, was printed the translation of the Bible (1661-1663) by John Eliot into the language of the natives, with primer, catechisms, grammars, tracts, &c. A fair number of Indians were students, but only one, Caleb Cheeshahteamuck, took a bachelor's degree (1665). By generous

¹ The statement of Dionysius of Halicarnassus (ii. 22) that the haruspices were instituted by Romulus is due to his confusing them with the augurs.

aid received from abroad for this special object, the college was greatly helped in its infancy.

The charter of 1650 has been in the main, and uninterruptedly since 1707, the fundamental source of authority in the administration of the university. It created a co-opting corporation consisting of the president, treasurer and five fellows, who formally initiate administrative measures, control the college funds, and appoint officers of instruction and government; subject, however, to confirmation by the Board of Overseers (established in 1642), which has a revisory power over all acts of the corporation. Circumstances gradually necessitated ordinary government by the resident teachers; and to-day the various faculties, elaborately organized, exercise immediate government and discipline over all the students, and individually or in the general university council consider questions of policy. The Board of Overseers was at first jointly representative of state and church. The former, as founder and patron, long regarded Harvard as a state institution, controlling or aiding it through the legislature and the overseers; but the controversies and embarrassments incident to legislative action proved prejudicial to the best interests of the college, and its organic connexion with the state was wholly severed in 1866. Financial aid and practical dependence had ceased some time earlier; indeed, from the very beginning, and with steadily increasing preponderance, Harvard has been sustained and fostered by private munificence rather than by public money. The last direct subsidy from the state determined in 1824, although state aid was afterwards given to the Agassiz museum, later united with the university. The church was naturally sponsor for the early college. The changing composition of its Board of Overseers marked its liberation first from clerical and later from political control; since 1865 the board has been chosen by the alumni (non-residents of Massachusetts being eligible since 1880), who therefore really control the university. When the state ceased to repress effectually the rife speculation characteristic of the first half of the seventeenth century, in religion as in politics, and in America as in England, the unity of Puritanism gave way to a variety of intense sectarianisms, and this, as also the incoming of Anglican churchmen, made the old faith of the college insecure. President Henry Dunster (c. 1612-1659), the first president, was censured by the magistrates and removed from office for questioning infant baptism. The conservatives, who clung to pristine and undiluted Calvinism, sought to intrench themselves in Harvard, especially in the Board of Overseers. The history of the college from about 1673 to 1725 was exceedingly troubled. Increase and Cotton Mather, forceful but bigoted, were the bulwarks of reaction and fomenters of discord. One episode in the struggle was the foundation and encouragement of Yale College by the reactionaries of New England as a truer "school of the prophets" (Cotton Mather being particularly zealous in its interests), after they had failed to secure control of the government of Harvard. It represented conservative secession. In 1792 the first layman was chosen to the corporation; in 1805 a Unitarian became professor of theology; in 1843 the board of overseers was opened to clergymen of all denominations; in 1886 attendance on prayers by the students ceased to be compulsory. Thus Harvard, in response to changing ideas and conditions, grew away from the ideas of its founders.

Harvard, her alumni, and her faculty have been very closely connected with American letters; not only in the colonial period, when the Mathers, Samuel Sewall and Thomas Prince were important names, or in the revolutionary and early national epoch with the Adamsses, Fisher Ames, Joseph Dennie and Robert Treat Paine, but especially in the second third of the 19th century, when the great New England movements of Unitarianism and Transcendentalism were led by Harvard graduates. In 1805 Henry Ware (1764-1845) was elected the first anti-Trinitarian to be Hollis professor of divinity, and this marked Harvard's close connexion with Unitarianism, in the later history of which Ware, his son Henry (1794-1843), and Andrews Norton (1786-1852), all Harvard alumni and professors,

and Joseph Buckminster (1751-1812) and William Ellery Channing were leaders of the conservative Unitarians, and Joseph Stevens Buckminster (1784-1812), James Freeman Clarke, and Theodore Parker were liberal leaders. Of the "Transcendentalists," Emerson, Francis Henry Hedge (1805-1890), Clarke, Convers Francis (1795-1863), Parker, Thoreau and Christopher Pearse Cranch (1812-1892) were Harvard graduates. Longfellow's professorship at Harvard identified him with it rather than with Bowdoin; Oliver Wendell Holmes was professor of anatomy and physiology at Harvard in 1847-1882; and Lowell, a Harvard alumnus, was Longfellow's successor in 1855-1886 as Smith Professor of the French and Spanish languages and literatures. Ticknor and Charles Eliot Norton are other important names in American literary criticism. The historians Sparks, Bancroft, Hildreth, Palfrey, Prescott, Motley and Parkman were graduates of Harvard, as were Edward Everett, Charles Sumner and Wendell Phillips.

In organization and scope of effort Harvard has grown, especially after 1869, under the direction of President Charles W. Eliot, to be in the highest sense a university; but the "college" proper, whose end is the liberal culture of undergraduates, continues to be in many ways the centre of university life, as it is the embodiment of university traditions. The medical school (in Boston) dates from 1782, the law school from 1817, the divinity school¹ (though instruction in theology was of course given from the foundation of the college) from 1819, and the dental school (in Boston) from 1867. The Bussey Institution at Jamaica Plain was established in 1871 as an undergraduate school of agriculture, and reorganized in 1908 for advanced instruction and research in subjects relating to agriculture and horticulture. The Graduate School of Arts and Sciences dates from 1872, the Graduate School of Applied Science (growing out of the Lawrence Scientific School) from 1906, and the Graduate School of Business Administration (which applies to commerce the professional methods used in post-graduate schools of medicine, law, &c.) from 1908. The Lawrence Scientific School, established in 1847, was practically abolished in 1907-1908, when its courses were divided between the College (which thereafter granted a degree of S.B.) and the Graduate School of Applied Science, which was established in 1906 and gives professional degrees in civil, mechanical and electrical engineering, mining, metallurgy, architecture, landscape architecture, forestry, applied physics, applied chemistry, applied zoology and applied geology. A school of veterinary medicine, established in 1882, was discontinued in 1901. The university institutions comprise the botanic garden (1807) and the (Asa) Gray herbarium (1864); the Arnold arboretum (1872), at Jamaica Plain, for the study of arboriculture, forestry and dendrology; the university museum of natural history, founded in 1859 by Louis Agassiz as a museum of comparative zoology, enormously developed by his son, Alexander Agassiz, and transferred to the university in 1876, though under an independent faculty; the Peabody museum of American archaeology and ethnology, founded in 1866 by George Peabody; the William Hayes Fogg art museum (1895); the Semitic museum (1889); the Germanic Museum (1902), containing rich gifts from Kaiser Wilhelm II., the Swiss government, and individuals and societies of Germanic lands; the social museum (1906); and the astronomical observatory (1843; location 42° 22' 48" N. lat., 71° 8' W. long.), which since 1891 has maintained a station near Arequipa, Peru. A permanent summer engineering camp is maintained at Squam Lake, New Hampshire. In Petersham, Massachusetts, is the Harvard Forest, about 2000 acres of hilly wooded country with a stand in 1908 of 10,000,000 ft. B.M. of merchantable timber (mostly white pine); this forest was given to the university in 1907, and is an important part of the equipment of the division of forestry. The university library is the largest college library in the country, and from its slow and competent selection is of exceptional value. In 1908 it numbered,

including the various special libraries, 803,800 bound volumes, about 496,600 pamphlets, and 27,450 maps. Some of its collections are of great value from associations or special richness, such as Thomas Carlyle's collection on Cromwell and Frederick the Great; the collection on folk-lore and medieval romances, supposed to be the largest in existence and including the material used by Bishop Percy in preparing his *Reliques*; and that on the Ottoman empire. The law library has been described by Professor A. V. Dicey of Oxford as "the most perfect collection of the legal records of the English people to be found in any part of the English-speaking world." There are department libraries at the Arnold arboretum, the Gray herbarium, the Bussey Institution, the astronomical observatory, the dental school, the medical school, the law school, the divinity school, the Peabody museum, and the museum of comparative zoology. In 1878 the library published the first of a valuable series of *Bibliographical Contributions*. Other publications of the university (apart from annual reports of various departments) are: the *Harvard Oriental Series* (started 1891), *Harvard Studies in Classical Philology* (1890), *Harvard Theological Review* (1907), the *Harvard Law Review* (1889), *Harvard Historical Studies* (1897), *Harvard Economic Studies* (1906), *Harvard Psychological Studies* (1903), the *Harvard Engineering Journal* (1902), the *Bulletin* (1874) of the Bussey Institution, the *Archaeological and Ethnological Papers* (1888) of the Peabody museum, and the *Bulletin* (1863), *Contributions* and *Memoirs* (1865) of the museum of comparative zoology. The students' publications include the *Crimson* (1873), a daily newspaper; the *Advocate* (1832), a literary bi-weekly; the *Lampoon* (1876), a comic bi-weekly; and the *Harvard Monthly* (1885), a literary monthly. The *Harvard Bulletin*, a weekly, and the *Harvard Graduates' Magazine* (1892), a quarterly, are published chiefly for the alumni.

In 1908-1909 there were 743 officers of instruction and administration (including those for Radcliffe) and 5250 students (2059 in 1869), the latter including 2238 in the college, 1641 in the graduate and professional schools, and 1332 in the summer school. Radcliffe College, for women, had 449 additional students. The whole number of degrees conferred up to 1905 was 31,805 (doctors of science and of philosophy by examination, 408; masters of arts and of science by examination, 1759). The conditions of the time when Harvard was a theological seminary for boys, governed like a higher boarding school, have left traces still discernible in the organization and discipline, though no longer in the aims of the college. The average age of students at entrance, only 14 years so late as 1820, had risen by 1890 to 19 years, making possible the transition to the present régime of almost entire liberty of life and studies without detriment, but with positive improvement, to the morals of the student body. A strong development toward the university ideal marked the opening of the 19th century, especially in the widening of courses, the betterment of instruction, and the suggestions of quickening ideas of university freedom, whose realization, along with others, has come since 1870. The elimination of the last vestiges of sectarianism and churchly discipline, a lessening of parietal oversight, a lopping off of various outgrown colonial customs, a complete reconstruction of professional standards and methods, the development of a great graduate school in arts and sciences based on and organically connected with the undergraduate college, a great improvement in the college standard of scholarship, the allowance of almost absolute freedom to students in the shaping of their college course (the "elective" system), and very remarkable material prosperity marked the administration (1860-1909) of President Eliot. In the readjustment in the curricula of American colleges of the elements of professional training and liberal culture Harvard has been bold in experiment and innovation. With Johns Hopkins University she has led the movement that has transformed university education, and her influence upon secondary education in America has been incomparably greater than that of any other university. Her entrance requirements to the college and to the schools of medicine, law, dentistry and divinity have been higher than those of any other American university.

¹ Affiliated with the university, but autonomous and independent, is the Andover Theological Seminary, which in 1908 removed from Andover to Cambridge.

A bachelor's degree is requisite for entrance to the professional schools (except that of dentistry), and the master's degree (since 1872) is given to students only for graduate work in residence, and rarely to other persons as an honorary degree. In scholarship and in growth of academic freedom Germany has given the quickening impulse. This influence began with George Ticknor and Edward Everett, who were trained in Germany, and was continued by a number of eminent German scholars, some driven into exile for their liberalism, who became professors in the second half of the 19th century, and above all by the many members of the faculty still later trained in German universities. The ideas of recognizing special students and introducing the elective system were suggested in 1824, attaining establishment even for freshmen by 1885, the movement characterizing particularly the years 1865-1885. The basis of the elective system (as in force in 1910) is freedom in choice of studies within liberal limits; and, as regards admission to college¹ (completely established 1891), the idea that the admission is of minds for the quality of their training and not for their knowledge of particular subjects, and that any subject may be acceptable for such training if followed with requisite devotion and under proper methods. Except for one course in English in the Freshman year, and one course in French or German for those who do not on entrance present both of these languages, no study is prescribed, but the student is compelled to select a certain number of courses in some one department or field of learning, and to distribute the remainder among other departments, the object being to secure a systematic education, based on the principle of knowing a little of everything and something well.

The material equipment of Harvard is very rich. In 1900 it included invested funds of \$22,716,760 (\$2,257,900 in 1860) and lands and buildings valued at \$12,000,000 at least. In 1908-1909 an income of more than \$130,000 was distributed in scholarships, fellowships, prizes and other aids to students. The yearly income available for immediate use from all sources in 1899-1904 averaged \$1,074,229, of which \$452,760 yearly represented gifts. The total gifts, for funds and for current use, in the same years aggregated \$6,152,988. The income in 1907-1908 was \$1,846,976; \$241,924 was given for immediate use, and \$440,822 was given for capital. The medical school is well endowed and is housed in buildings (1906) on Longwood Avenue, Boston; the gifts for its buildings and endowments made in 1901-1902 aggregate \$5,000,000. Among the university buildings are two dining-halls accommodating some 2500 students, a theatre for public ceremonies, a chapel, a home for religious societies, a club-home (the Harvard Union) for graduates and undergraduates, an infirmary, gymnasium, boat houses and large playgrounds, with a concrete stadium capable of seating 27,000 spectators. Massachusetts Hall (1720) is the oldest building. University Hall (1815), the administration building, dignified, of excellent proportions and simple lines, is a good example of the work of Charles Bulfinch. Memorial Hall (1874), an ambitious building of cathedral suggestion, commemorates the Harvard men who fell in the Civil War, and near it is an ideal statue (1884) of John Harvard by Daniel C. French. The medical and dental schools are in Boston, and the Bussey Institution and Arnold Arboretum are at Jamaica Plain.

RADCLIFFE COLLEGE, essentially a part of Harvard, dates from the beginning of systematic instruction of women by members of the Harvard faculty in 1879, the Society for the Collegiate Instruction of Women being formally organized in 1882. The present name was adopted in 1894 in honour of Ann

¹ The requirements for admission as changed in 1908 are based on the "unit system"; satisfactory marks must be got in subjects aggregating 26 units, the unit being a measure of preparatory study. Of these 26 units, English (4 units), algebra (2), plane geometry (2), some science or sciences (2), history (2); either Greek and Roman, or American and English), a modern language (2; French and German) are prescribed; prospective candidates for the degree of A.B. are required to take examinations for 4 additional units in Greek or Latin, and for the other 8 points have large range of choice; and candidates for the degree of S.B. must take additional examinations in French or German (2 units) and have a similar freedom of choice in making up the remaining to units.

Radcliffe, Lady Mowison (ob. c. 1661), widow of Sir Thomas Mowison, alderman and (1634) lord mayor of London, who in 1643 founded the first scholarship in Harvard College. From 1804 also dates the present official connexion of Radcliffe with Harvard. The requirements for admission and for degrees are the same as in Harvard (whose president countersigns all diplomas), and the president and fellows of Harvard control absolutely the administration of the college, although it has for immediate administration a separate government. Instruction is given by members of the university teaching force, who repeat in Radcliffe many of the Harvard courses. Many advanced courses in Harvard, and to a certain extent laboratory facilities, are directly accessible to Radcliffe students, and they have unrestricted access to the library.

The presidents of Harvard have been: Henry Dunster (1640-1654); Charles Chauncy (1654-1672); Leonard Hoar (1672-1675); Urian Oakes (1675-1681); John Rogers (1682-1684); Increase Mather (1685-1701); Charles Morton (vice-president) (1697-1698); Samuel Willard (1700-1707); John Leverett (1708-1724); Benjamin Wadsworth (1725-1737); Edward Holyoke (1737-1769); Samuel Locke (1770-1773); Samuel Langdon (1774-1780); Joseph Willard (1781-1804); Samuel Webber (1806-1810); John Thornton Kirkland (1810-1828); Josiah Quincy (1829-1845); Edward Everett (1846-1849); Jared Sparks (1849-1853); James Walker (1853-1860); Cornelius Conway Felton (1860-1862); Thomas Hill (1862-1868); Charles William Eliot (1869-1909); Abbott Lawrence Lowell (appointed 1909).

AUTHORITIES.—Benjamin Peirce, *A History of Harvard University 1636-1775* (Boston, 1883); Josiah Quincy, *A History of Harvard University* (2 vols., Boston, 1840); Samuel A. Eliot, *Harvard College and its Benefactors* (Boston, 1848); H. C. Shelley, *John Harvard and his Times* (Boston, 1907); *The Harvard Book* (2 vols., Cambridge, 1874); G. Birkbeck Hill, *Harvard College, by an Oxonian* (New York, 1894); William R. Thayer, "History and Customs of Harvard University," in *Universities and their Sons*, vol. i. (Boston, 1898); *Official Guide to Harvard*, and the various other publications of the university; also the *Harvard Graduates' Magazine* (1892 sqq.).

HARVEST (A.S. *harfest* "autumn," O.H. Ger. *herbst*, possibly through an old Teutonic root representing Lat. *carpere*, "to pluck"), the season of the ingathering of crops. Harvest has been a season of rejoicing from the remotest ages. The ancient Jews celebrated the Feast of Pentecost as their harvest festival, the wheat ripening earlier in Palestine. The Romans had their Cerealia or feasts in honour of Ceres. The Druids celebrated their harvest on the 1st of November. In pre-reformation England Lammas Day (Aug. 1st, O.S.) was observed at the beginning of the harvest festival, every member of the church presenting a loaf made of new wheat. Throughout the world harvest has always been the occasion for many queer customs which all have their origin in the animistic belief in the Corn-Spirit or Corn-Mother. This personification of the crops has left its impress upon the harvest customs of modern Europe. In west Russia, for example, the figure made out of the last sheaf of corn is called the Bastard, and a boy is wrapped up in it. The woman who binds this sheaf represents the "Cornmother," and an elaborate simulation of childbirth takes place, the boy in the sheaf squalling like a new-born child, and being, on his liberation, wrapped in swaddling bands. Even in England vestiges of sympathetic magic can be detected. In Northumberland, where the harvest rejoicing takes place at the close of the reaping and not at the ingathering, as soon as the last sheaf is set on end the reapers shout that they have "got the kern." An image formed of a wheat-sheaf, and dressed in a white frock and coloured ribbons, is hoisted on a pole. This is the "kern-baby" or harvest-queen, and it is carried back in triumph with music and shouting and set up in a prominent place during the harvest supper. In Scotland the last sheaf if cut before Hallowmas is called the "maiden," and the youngest girl in the harvest-field is given the privilege of cutting it. If the reaping finishes after Hallowmas the last corn cut is called the *Cailleach* (old woman). In some parts of Scotland this last sheaf is kept till Christmas morning and then divided among the cattle "to make them

thrive all the year round," or is kept till the first mare foals and is then given to her as her first food. Throughout the world, as J. C. Frazer shows, the semi-worship of the last sheaf is or has been the great feature of the harvest-home. Among harvest customs none is more interesting than harvest cries. The cry of the Egyptian reapers announcing the death of the corn-spirit, the rustic prototype of Osiris, has found its echo on the world's harvest-fields, and to this day, to take an English example, the Devonshire reapers utter cries of the same sort and go through a ceremony which in its main features is an exact counterpart of pagan worship. "After the wheat is cut they 'cry the neck.' . . . An old man goes round to the shocks and picks out a bundle of the best ears he can find. . . this bundle is called 'the neck'; the harvest hands then stand round in a ring, the old man holding 'the neck' in the centre. At a signal from him they take off their hats, stooping and holding them with both hands towards the ground. Then all together they utter in a prolonged cry 'the neck!' three times, raising themselves upright with their hats held above their heads. Then they change their cry to 'Wee yen! way yen!' or, as some report, 'we haven!' On a fine still autumn evening "crying the neck" has a wonderful effect at a distance. In East Anglia there still survives the custom known as "Halling Largess." The harvesters beg largess from passers, and when they have received money they shout thrice "Halloo, largess," having first formed a circle, bowed their heads low crying "Hoo-Hoo-Hoo," and then jerked their heads backwards and uttered a shrill shriek of "Ah! Ah!"

For a very full discussion of harvest customs see J. C. Frazer, *The Golden Bough*, and Brand's *Antiquities of Great Britain* (Hazlitt's ed., 1905).

HARVEST-BUG, the familiar name for mites of the family Trombididae, belonging to the order Acari of the class Arachnida. Although at one time regarded as constituting a distinct species, described as *Leptus autumnalis*, harvest-bugs are now known to be the six-legged larval forms of several British species of mites of the genus *Trombidium*. They are minute, rusty-brown organisms, barely visible to the naked eye, which swarm in grass and low herbage in the summer and early autumn, and cause considerable, sometimes intense, irritation by piercing and adhering to the skin of the leg, usually lodging themselves in some part where the clothing is tight, such as the knee when covered with gartered stockings. They may be readily destroyed, and the irritation allayed, by rubbing the affected area with some insecticide like turpentine or benzine. They are not permanently parasitic, and if left alone will leave their temporary host to resume the active life characteristic of the adult mite, which is predatory in habits, preying upon minute living animal organisms.

HARVESTER, HARVEST-SPIDER, OR HARVEST-MAN, names given to Arachnids of the order Opiliones, referable to various species of the family Phalangidae. Harvest-spiders or harvest-men, so-called on account of their abundance in the late summer and early autumn, may be at once distinguished from all true spiders by the extreme length and thinness of their legs, and by the small size and spherical or oval shape of the body, which is not divided by a waist or constriction into an anterior and a posterior region. They may be met with in houses, back yards, fields, woods and heaths; either climbing on walls, running over the grass, or lurking under stones and fallen tree trunks. They are predaceous, feeding upon small insects, mites and spiders. The males are smaller than the females, and often differ from them in certain well-marked secondary sexual characters, such as the mandibular protuberance from which one of the common English spiders, *Phalangium cornutum*, takes its scientific name. The male is also furnished with a long and protrusible penis, and the female with an equally long and protrusible ovipositor. The sexes pair in the autumn, and the female, by means of her ovipositor, lays her eggs in some cleft or hole in the soil and leaves them to their fate. After breeding, the parents die with the autumn cold; but the eggs retain their vitality through the winter and hatch with the warmth of spring and early summer, the young gradually attaining maturity as the latter season

progresses. Hence the prevalence of adult individuals in the late summer and autumn, and at no other time of the year. They are provided with a pair of glands, situated one on each side of the carapace, which secrete an evil-smelling fluid believed to be protective in nature. Harvest-men are very widely distributed and are especially abundant in temperate countries of the

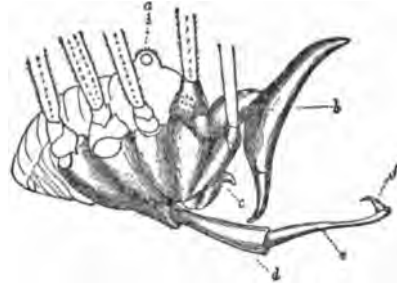

FIG. 1.—Harvest-man (*Phalangium cornutum*, Linn.); profile of male, with legs and palpi truncated.

- a, Ocular tubercle.
- b, Mandible.
- c, Labrum (upper lip).
- d, Sheath of penis protruded.
- e, Penis.
- f, The glands.

northern hemisphere. They are also, however, common in India, where they are well known for their habit of adhering together in great masses, comparable to a swarm of bees, and of swaying gently backwards and forwards. The long legs of harvest-men serve them not only as organs of rapid locomotion, but also as props to raise the body well off the ground, thus enabling the animals to stalk unmolested from the midst of an army of raiding ants. (R. I. P.)

HARVEY, GABRIEL (c. 1545-1630), English writer, eldest son of a ropemaker of Saffron-Walden, Essex, was born about 1545. He matriculated at Christ's College, Cambridge, in 1566, and in 1570 was elected fellow of Pembroke Hall. Here he formed a lasting friendship with Edmund Spenser, and it has been suggested (*Athen. Cantab.* ii. 258) that he may have been the poet's tutor. Harvey was a scholar of considerable weight, who has perhaps been judged too exclusively from the brilliant invectives directed against him by Thomas Nashe. Henry Morley, writing in the *Fortnightly Review* (March 1860), brought evidence from Harvey's Latin writings which shows that he was distinguished by quite other qualities than the pedantry and conceit usually associated with his name. He desired to be "epitaphed as the Inventour of the English Hexameter," and was the prime mover in the literary clique that desired to impose on English verse the Latin rules of quantity. In a "gallant, familiar letter" to M. Immerito (Edmund Spenser) he says that Sir Edward Dyer and Sir Philip Sidney were helping forward "our new famous enterprise for the exchanging of Barbarous and Balductum Rymes with Artificiall Verses." The document includes a tepid appreciation of the *Faerie Queene* which had been sent to him for his opinion, and he gives examples of English hexameters illustrative of the principles enunciated in the correspondence. The opening lines—

"What might I call this Tree? A Laurell? O bonny Laurell
Needs to thy bowes will I bow this knee, and vayne my bonetto"—

afford a fair sample of the success of Harvey's metrical experiments, which presented a fair mark for the wit of Thomas Nashe. "He (Harvey) goes twitching and hopping in our language like a man running upon quagmires, up the hill in one syllable, and down the dale in another," says Nashe in *Strange News*, and he mimics him in the mocking couplet:

"But eh! what news do you hear of that good Gabriel Huffe-Snuffe,
Known to the world for a foole, and clapt in the Fleete for a
Runner?"

Harvey exercised great influence over Spenser for a short time, and the friendship lasted even though Spenser's genius refused

to be bound by the laws of the new prosody. Harvey is the Hobbinnoll of his friend's *Shepherds Calendar*, and into his mouth is put the beautiful song in the fourth eclogue in praise of Eliza. If he was really the author of the verses "To the Learned Shepheard" signed "Hobynoll" and prefixed to the *Faerie Queene*, he was a good poet spoiled. But Harvey's genuine friendship for Spenser shows the best side of a disposition uncompromising and quarrelsome towards the world in general. In 1573 ill-will against him in his college was so strong that there was a delay of three months before the fellows would agree to grant him the necessary grace for his M.A. degree. He became reader in rhetoric about 1576, and in 1578, on the occasion of Queen Elizabeth's visit to Sir Thomas Smith at Audley End, he was appointed to dispute publicly before her. In the next year he wrote to Spenser complaining of the unauthorized publication of satirical verses of his which were supposed to reflect on high personages, and threatened seriously to injure Harvey's career. In 1583 he became junior proctor of the university, and in 1585 he was elected master of Trinity Hall, of which he had been a fellow from 1578, but the appointment appears to have been quashed at court. He was a protégé of the Earl of Leicester, to whom he introduced Spenser, and this connexion may account for his friendship with Sir Philip Sidney. But in spite of patronage, a second application for the mastership of Trinity Hall failed in 1598. In 1585 he received the degree of D.C.L. from the university of Oxford, and is found practising at the bar in London. Gabriel's brother, Richard, had taken part in the Marprelate controversy, and had given offence to Robert Greene by contemptuous references to him and his fellow wits. Greene retorted in his *Quip for an Upsart Courtier* with some scathing remarks on the Harveys, the worst of which were expunged in later editions, drawing attention among other things to Harvey's modest parentage. In 1599 Archbishop Whitgift made a raid on contemporary satire in general, and among other books the tracts of Harvey and Nashe were destroyed, and it was forbidden to reprint them. Harvey spent the last years of his life in retirement at his native place, dying in 1630.

His extant Latin works are: *Ciceronianus* (1577); *G. Harveii rhetor, sive 2 dierum oratio de natura, arte et exercitatione rhetorica* (1577); *Smithus, vel Musarum lacrymæ* (1578), in honour of Sir Thomas Smith; and *G. Harveii gratulationum Valdensium libri quatuor* (sic), written on the occasion of the queen's visit to Audley End (1578). *The Letter-Book of Gabriel Harvey, A.D. 1573-80* (1884, ed. E. J. L. Scott, Camden Society), contains rough drafts of the correspondence between Spenser and Harvey, letters relative to the disputes at Pembroke Hall, and an extraordinary correspondence dealing with the pursuit of his sister Mercy by a young nobleman. A copy of Quintilian (1542), in the British Museum, is extensively annotated by Gabriel Harvey. After Greene's death Harvey published *Four Letters and certain Sonnets* (1592), in which in a spirit of righteous superiority he laid bare with spiteful fulness the miserable details of Greene's later years. Thomas Nashe, who in power of invective and merciless wit was far superior to Harvey, took upon himself to avenge Greene's memory, and at the same time settle his personal account with the Harveys, in *Strange News* (1593). Harvey refuted the personal charges made by Nashe in *Pierce's Supplication, or a New Prayse of the Old Ass* . . . (1593). In *Christes Teares over Jerusalem* (1593) Nashe made a full apology to Harvey, who refused to be appeased, and resumed what had become a very scurrilous controversy in a *New Letter of Notable Contents* (1593). Nashe thereupon withdrew his apology in a new edition (1594) of *Christes Teares*, and hearing that Harvey had boasted of victory he produced the most biting satire of the series in *Have with you to Saffron Walden* (1596). Harvey retorted in *The Trimming of Thomas Nashe Gentleman, by the high-titled patron Don Richardo de Medico campo* . . . (1597).

His complete works were edited by Dr A. B. Grosart with a "Memorial Introduction" for the *Hull Library* (1884-1885). See also Isaac Disraeli, on "Literary Ridicule," in *Colanities of Authors* (ed. 1840); T. Warton's *History of English Poetry* (ed. W. C. Hazlitt, 1871); J. P. Collier's *Bibliographical and Critical Account of the Rarest Books in the English Language* (1865), and the *Works of Thomas Nashe*.

HARVEY, SIR GEORGE (1806-1876), Scottish painter, the son of a watchmaker, was born at St Ninians, near Stirling, in February 1806. Soon after his birth his parents removed to Stirling, where George was apprenticed to a bookseller. His love for art having, however, become very decided, in his

eighteenth year he entered the Trustees' Academy at Edinburgh. Here he so distinguished himself that in 1826 he was invited by the Scottish artists, who had resolved to found a Scottish academy, to join it as an associate. Harvey's first picture, "A Village School," was exhibited in 1826 at the Edinburgh Institution; and from the time of the opening of the Academy in the following year he continued annually to exhibit. His best-known pictures are those depicting historical episodes in religious history from a puritan or evangelical point of view, such as "Covenanters Preaching," "Covenanters' Communion," "John Bunyan and his Blind Daughter," "Sabbath Evening," and the "Quitting of the Manse." He was, however, equally popular in Scotland for subjects not directly religious; and "The Bowlers," "A Highland Funeral," "The Curlers," "A Schule Skailin'," and "Children Blowing Bubbles in the Churchyard of Greyfriars, Edinburgh," manifest the same close observation of character, artistic conception and conscientious elaboration of details. In "The Night Mail" and "Dawn Revealing the New World to Columbus" the aspects of nature are made use of in different ways, but with equal happiness, to lend impressiveness and solemnity to human concerns. He also painted landscapes and portraits. In 1829 he was elected a fellow of the Royal Scottish Academy; in 1864 he succeeded Sir J. W. Gordon as president; and he was knighted in 1867. He died at Edinburgh on the 22nd of January 1876.

Sir George Harvey was the author of a paper on the "Colour of the Atmosphere," read before the Edinburgh Royal Society, and afterwards published with illustrations in *Good Words*; and in 1870 he published a small volume entitled *Notes of the Early History of the Royal Scottish Academy, Selections from the Works of Sir George Harvey, P.R.S.A., described by the Rev. A. L. Simpson, F.S.A. Scot., and photographed by Thomas Annan, appeared at Edinburgh in 1869.*

HARVEY, WILLIAM (1578-1657), English physician, the discoverer of the circulation of the blood, was the eldest son of Thomas Harvey, a prosperous Kentish yeoman, and was born at Folkestone on the 1st of April 1578. After passing through the grammar school of Canterbury, on the 31st of May 1593, having just entered his sixteenth year, he became a pensioner of Caius College, Cambridge, at nineteen he took his B.A. degree, and soon after, having chosen the profession of medicine, he went to study at Padua under H. Fabricius and Julius Casserius. At the age of twenty-four Harvey became doctor of medicine, in April 1602. Returning to England in the first year of James I., he settled in London; and two years later he married the daughter of Dr Lancelot Browne, who had been physician to Queen Elizabeth. In the same year he became a candidate of the Royal College of Physicians, and was duly admitted a fellow (June 1607). In 1609 he obtained the reversion of the post of physician to St Bartholomew's hospital. His application was supported by the king himself and by Dr Henry Atkins (1558-1635), the president of the college, and on the death of Dr Wilkinson in the course of the same year he succeeded to the post. He was thrice censor of the college, and in 1615 was appointed Lumléan lecturer.

In 1616 he began his course of lectures, and first brought forward his views upon the movements of the heart and blood. Meantime his practice increased, and he had the lord chancellor, Francis Bacon, and the earl of Arundel among his patients. In 1618 he was appointed physician extraordinary to James I., and on the next vacancy physician in ordinary to his successor. In 1628, the year of the publication of the *Exercitatio anatomica de motu cordis et sanguinis*, he was elected treasurer of the College of Physicians, but at the end of the following year he resigned the office, in order, by command of Charles I., to accompany the young duke of Lennox (James Stuart, afterwards duke of Richmond) on his travels. He appears to have visited Italy, and returned in 1632. Four years later he accompanied the earl of Arundel on his embassy to the emperor Ferdinand II. He was eager in collecting objects of natural history, sometimes causing the earl anxiety for his safety by his excursions in a country infested by robbers in consequence of the Thirty Years' War. In a letter written on this journey, he says: "By the

way we could scarce see a dogg, crow, kite, raven, or any bird, or anything to anatomise; only sum few miserable people, the reliques of the war and the plague, whom famine had made anatomies before I came." Having returned to his practice in London at the close of the year 1636, he accompanied Charles I. in one of his journeys to Scotland (1639 or 1641). While at Edinburgh he visited the Bass Rock; he minutely describes its abundant population of sea-fowl in his treatise *De generatione*, and incidentally speaks of the account then credited to the solan goose growing on trees as a fable. He was in attendance on the king at the battle of Edgehill (October 1642), where he withdrew under a hedge with the prince of Wales and the duke of York (then boys of twelve and ten years old), "and took out of his pocket a book and read. But he had not read very long before a bullet of a great gun grazed on the ground near him, which made him remove his station," as he afterwards told John Aubrey. After the indecisive battle, Harvey followed Charles I. to Oxford, "where," writes the same gossiping narrator, "I first saw him, but was then too young to be acquainted with so great a doctor. I remember he came several times to our college (Trinity) to George Bathurst, B.D. who had a hen to hatch eggs in his chamber, which they opened daily to see the progress and way of generation." In Oxford he remained three years, and there was some chance of his being superseded in his office at St Bartholomew's hospital, "because he hath withdrawn himself from his charge, and is retired to the party in arms against the Parliament." It was no doubt at this time that his lodgings at Whitehall were searched, and not only the furniture seized but also invaluable manuscripts and anatomical preparations.¹

While with the king at Oxford he was made warden of Merton College, but a year later, in 1646, that city surrendered to Fairfax, and Harvey returned to London. He was now sixty-eight years old, and, having resigned his appointments and relinquished the cares of practice, lived in learned retirement with one or other of his brothers. It was in his brother Daniel's house at Combe that Dr (afterwards Sir George) Ent, a faithful friend and disciple (1604-1689), visited him in 1650. "I found him," he says, "with a cheerful and sprightly countenance investigating, like Democritus, the nature of things. Asking if all were well with him—'How can that be,' he replied, 'when the state is so agitated with storms and I myself am yet in the open sea? And indeed, were not my mind solaced by my studies and the recollection of the observations I have formerly made, there is nothing which should make me desirous of a longer continuance. But thus employed, this obscure life and vacation from public cares which would disgust other minds is the medicine of mine.' " The work on which he had been chiefly engaged at Oxford, and indeed since the publication of his treatise on the circulation in 1628, was an investigation into the recondite but deeply interesting subject of generation. Charles I. had been an enlightened patron of Harvey's studies, had put the royal deer parks at Windsor and Hampton Court at his disposal, and had watched his demonstration of the growth of the chick with no less interest than the movements of the living heart. Harvey had now collected a large number of observations, though he would probably have delayed their publication. But Ent succeeded in obtaining the manuscripts, with authority to print them or not as he should find them. "I went from him," he says, "like another Jason in possession of the golden fleece, and when

¹ "Ignoscant mihi niveae animae, si, summarum injuriarum memor, levem gemitum effuderō. Doloris mihi haec causa est: cum, inter superos nostros tumultus et bella plusquam civilia, serenissimum regem (idque non solum senatus permissione sed et jussu) sequor, rapaces quaedam manus non modo aedium mearum suppellectilem omnem expilarunt, sed etiam, quae mihi causa gravior querimoniae, adversaria mea, multorum annorum laboribus parta, e museo meo summovertunt. Quo factum est ut observationes plurimae, praesertim de generatione insectorum, cum republicae literariae (ausim dicere) detrimento, perierint."—*De gen.*, Ex. lxxviii. To this loss Cowley refers—

"O cursed war! who can forgive thee this
Houses and towns may rise again,
And ten times easier 'tis
To rebuild Paul's than any work of his."

I came home and perused the pieces singly, I was amazed that so vast a treasure should have been so long hidden." The result was the publication of the *Exercitationes de generatione* (1651).

This was the last of Harvey's labours. He had now reached his seventy-third year. His theory of the circulation had been opposed and defended, and was now generally accepted by the most eminent anatomists both in his own country and abroad. He was known and honoured throughout Europe, and his own college (Caius) voted a statue in his honour (1652) *viro monumentis suis immortalis*. In 1654 he was elected to the highest post in his profession, that of president of the college; but the following day he met the assembled fellows, and, declining the honour for himself on account of the infirmities of age, recommended the re-election of the late president Dr Francis Prujean (1593-1666). He accepted, however, the office of consiliarius, which he again held in the two following years. He had already enriched the college with other gifts besides the honour of his name. He had raised for them "a noble building of Roman architecture (rustic work with Corinthian pilasters), comprising a great parlour or conversation room below and a library above"; he had furnished the library with books, and filled the museum with "simples and rarities," as well as with specimens of instruments used in the surgical and obstetric branches of medicine. At last he determined to give to his beloved college his paternal estate at Burmarsh in Kent. His wife had died some years before, his brothers were wealthy men, and he was childless, so that he was defrauding no heir when, in July 1656, he made the transfer of this property, then valued at £56 per annum, with provision for a salary to the college librarian and for the endowment of an annual oration, which is still given on the anniversary of the day. The orator, so Harvey orders in his deed of gift, is to exhort the fellows of the college "to search out and study the secrets of nature by way of experiment, and also for the honour of the profession to continue mutual love and affection among themselves."

Harvey, like his contemporary and great successor Thomas Sydenham, was long afflicted with gout, but he preserved his activity of mind to an advanced age. In his eightieth year, on the 3rd of June 1657, he was attacked by paralysis, and though deprived of speech was able to send for his nephews and distribute his watch, ring, and other personal trinkets among them. He died the same evening, "the palsy giving him an easy passport," and was buried with great honour in his brother Eliab's vault at Hempstead in Essex, *annorum et saeculae satur*. In 1883 the lead coffin containing his remains was enclosed in a marble sarcophagus and moved to the Harvey chapel within the church.

John Aubrey, to whom we owe most of the minor particulars about Harvey which have been preserved, says: "In person he was not tall, but of the lowest stature; round faced, olivaster complexion, little eyes, round, very black, full of spirits; his hair black as a raven, but quite white twenty years before he died." The best portrait of him extant is by Cornelius Jansen in the library of the College of Physicians, one of those rescued from the great fire, which destroyed their original hall in 1666. It has been often engraved, and is prefixed to the fine edition of his works published in 1766.

Harvey's Work on the Circulation.—In estimating the character and value of the discovery announced in the *Exercitatio de motu cordis et sanguinis*, it is necessary to bear in mind the previous state of knowledge on the subject. Aristotle taught that in man and the higher animals the blood was elaborated from the food in the liver, thence carried to the heart, and sent by it through the veins over the body. His successors of the Alexandrian school of medicine, Erasistratus and Herophilus, further elaborated his system, and taught that, while the veins carried blood from the heart to the members, the arteries carried a subtle kind of air or spirit. For the practical physician only two changes had been made in this theory of the circulation between the Christian era and the 16th century. Galen had discovered that the arteries were not, as their name implies, merely air-pipes, but that they contained blood as well as vital air or spirit. And it had been gradually ascertained that the nerves (νεῦρα) which

arose from the brain and conveyed "animal spirits" to the body were different from the tendons or sinews (*νεῦρα*) which attach muscles to bones. First, then, the physicians of the time of Thomas Linacre knew that the blood is not stagnant in the body. So did Shakespeare and Homer, and every augur who inspected the entrails of a victim, and every village barber who breathed a vein. Plato even uses the expression *τὸ αἷμα κατὰ πάντα τὰ μέλη σφοδρῶς περιφέρεσθαι*. But no one had a conception of a continuous stream returning to its source (a circulation in the true sense of the word) either in the system or in the lungs. If they used the word *circulatio*, as did Caesalpinus,¹ it was as vaguely as the French policeman cries "Circulez." The movements of the blood were in fact thought to be slow and irregular in direction as well as in speed, like the "circulation" of air in a house, or the circulation of a crowd in the streets of a city. Secondly, they supposed that one kind of blood flowed from the liver to the right ventricle of the heart, and thence to the lungs and the general system by the veins, and that another kind flowed from the left ventricle to the lungs and general system by the arteries. Thirdly, they supposed that the septum of the heart was pervious and allowed blood to pass directly from the right to the left side. Fourthly, they had no conception of the functions of the heart as the motor power of the movement of the blood. They doubted whether its substance was muscular; they supposed its pulsation to be due to expansion of the spirits it contained; they believed the only dynamic effect which it had on the blood to be sucking it in during its active diastole, and they supposed the chief use of its constant movements to be the due mixture of blood and spirits.

Of the great anatomists of the 16th century, Sylvius (*In Hipp. et Gal. phys. partem anatom. isagoge*) described the valves of the veins; Vesalius (*De humani corporis fabrica*, 1542) ascertained that the septum between the right and left ventricles is complete, though he could not bring himself to deny the invisible pores which Galen's system demanded. Servetus, in his *Christianismi restitutio* (1553), goes somewhat farther than his fellow-student Vesalius, and says: "Paries ille medius non est aptus ad communicationem et elaborationem illam; licet aliquid residare possit"; and, from this anatomical fact and the large size of the pulmonary arteries he concludes that there is a communication in the lungs by which blood passes from the pulmonary artery to the pulmonary vein: "Eodem artificio quo in hepate fit transfusio a vena porta ad venam cavam propter sanguinem, fit etiam in pulmone transfusio a vena arteriosa ad arteriam venosam propter spiritum." The natural spirit of the left side and the vital spirit of the right side of the heart were therefore, he concluded, practically the same, and hence two instead of three distinct spirits should be admitted. It seems doubtful whether even Servetus rightly conceived of the entire mass of the blood passing through the pulmonary artery and the lungs. The transference of the *spiritus naturalis* to the lungs, and its return to the left ventricle, as *spiritus vitalis*, was the function which he regarded as important. Indeed a true conception of the lesser circulation as a transference of the whole blood of the right side to the left was impossible until the corresponding transference in the greater or systematic circulation was discovered. Servetus, however, was the true predecessor of Harvey in physiology, and his claims to that honour are perfectly authentic and universally admitted.²

¹ Indeed the same word, *νεῦρα αἷματος*, occurs in the Hippocratic writings, and was held by Van der Linden to prove that to the father of medicine himself, and not to Columbus or Caesalpinus, belonged the laurels of Harvey.

² Realdo Columbus (*De re anatomica*, 1559) formally denies the muscularity of the heart, yet correctly teaches that blood and spirits pass from the right to the left ventricle, not through the septum but through the lungs. "quod nemo hactenus aut animadvertit aut scriptum reliquit." The fact that Harvey quotes Columbus and not Servetus is explained by the almost entire destruction of the writings of the latter, which are now among the rarest curiosities. The great anatomist Fabricius, Harvey's teacher at Padua, described the valves of the veins more perfectly than had Sylvius. Carlo Ruini, in his treatise on the *Anatomy and Diseases of the Horse* (1590), taught that the left ventricle sends blood and vital spirits to all parts of the body except the lungs—the ordinary Galenic doctrine. Yet on the

The way then to Harvey's great work had been paved by the discovery of the valves in the veins, and by that of the lesser circulation—the former due to Sylvius and Fabricius, the latter to Servetus—but the significance of the valves was unsuspected, and the fact of even the pulmonary circulation was not generally admitted in its full meaning.

In his treatise Harvey proves (1) that it is the contraction, not the dilatation, of the heart which coincides with the pulse, and that the ventricles as true muscular sacs squeeze the blood which they contain into the aorta and pulmonary artery; (2) that the pulse is not produced by the arteries enlarging and so filling, but by the arteries being filled with blood and so enlarging; (3) that there are no pores in the septum of the heart, so that the whole blood in the right ventricle is sent to the lungs and round by the pulmonary veins to the left ventricle, and also that the whole blood in the left ventricle is again sent into the arteries, round by the smaller veins into the venae cavae, and by them to the right ventricle again—thus making a complete "circulation"; (4) that the blood in the arteries and that in the veins is the same blood; (5) that the action of the right and left sides of the heart, auricles, ventricles and valves, is the same, the mechanism in both being for reception and propulsion of liquid and not of air, since the blood on the right side, though mixed with air, is still blood; (6) that the blood sent through the arteries to the tissues is not all used, but that most of it runs through into the veins; (7) that there is no to and fro undulation in the veins, but a constant stream from the distant parts towards the heart; (8) that the dynamical starting-point of the blood is the heart and not the liver.

The method by which Harvey arrived at his complete and almost faultless solution of the most fundamental and difficult problem in physiology has been often discussed, and is well worthy of attention. He begins his treatise by pointing out the many inconsistencies and defects in the Galenic theory, quoting the writings of Galen himself, of Fabricius, Columbus and others, with great respect, but with unflinching criticism. For, in his own noble language, wise men must learn anatomy, not from the decrees of philosophers, but from the fabric of nature herself, "nec ita in verba jurare antiquitatis magistrae, ut veritatem amicam in apertis relinquant, et in conspectu omnium deserant." He had, as we know, not only furnished himself with all the knowledge that books and the instructions of the best anatomists of Italy could give, but, by a long series of dissections, had gained a far more complete knowledge of the comparative anatomy of the heart and vessels than any contemporary—we may almost say than any successor—until the times of John Hunter and J. F. Meckel. Thus equipped, he tells us that he began his investigations into the movements of the heart and blood by looking at them—i.e. by seeing their action in living animals. After a modest preface, he heads his first chapter strength of this phrase Professor J. B. Ercolani actually put up a tablet in the veterinary school at Bologna to Ruini as the discoverer of the circulation of the blood! The claims of Caesalpinus, a more plausible claimant to Harvey's laurels, are scarcely better founded. In his *Quaestiones peripateticæ* (1571) he followed Servetus and Columbus in describing what we now know as the pulmonary "circulation" under that name, and this is the only foundation for the assertion (first made in Bayle's dictionary) that Caesalpinus knew "the circulation of the blood." He is even behind Servetus, for he only allows part of the blood of the right ventricle to go round by this "circuit"; some, he conceives, passes through the hypothetical pores in the septum, and the rest by the superior cava to the head and arms, by the inferior to the rest of the body: "Hanc esse venarum utilitatem ut omnes partes corporis sanguinem pro nutrimento deferant. Ex dextro ventro cordis vena cava sanguinem crassiorem, in quo calor intensus est magis, ex altero autem ventro, sanguinem temperatissimum ac sincerissimum habente, egreditur aorta." Caesalpinus seems to have had no original views on the subject; all that he writes is copied from Galen or from Servetus except some erroneous observations of his own. His greatest merit was as a botanist; and no claim to the "discovery of the circulation" was made by him or by his contemporaries. When it was made, Haller decided conclusively against it. The fact that an inscription has been placed on the bust of Caesalpinus at Rome, which states that he preceded others in recognizing and demonstrating "the general circulation of the blood," is only a proof of the blindness of misplaced national vanity.

"Ex vivorum dissectione, qualis sit cordis motus." He minutely describes what he saw and handled in dogs, pigs, serpents, frogs and fishes, and even in slugs, oysters, lobsters and insects, in the transparent *minima squilla*, "quae Anglice dicitur a shrimp," and lastly in the chick while still in the shell. In these investigations he used a *perspicillum* or simple lens. He particularly describes his observations and experiments on the ventricles, the auricles, the arteries and the veins. He shows how the arrangement of the vessels in the foetus supports his theory. He adduces facts observed in disease as well as in health to prove the rapidity of the circulation. He explains how the mechanism of the valves in the veins is adapted, not, as Fabricius believed, to moderate the flow of blood from the heart, but to favour its flow to the heart. He estimates the capacity of each ventricle, and reckons the rate at which the whole mass of blood passes through it. He elaborately and clearly demonstrates the effect of obstruction of the blood-stream in arteries or in veins, by the forceps in the case of a snake, by a ligature on the arm of a man, and illustrates his argument by figures. He then sums up his conclusion thus: "Circulari quodam motu, in circuitu, agitari in animalibus sanguinem, et esse in perpetuo motu; et hanc esse actionem sive functionem cordis quam pulsus peragit; et omnino motus et pulsus cordis causam unam esse." Lastly, in the 15th, 16th and 17th chapters, he adds certain confirmatory evidence, as the effect of position on the circulation, the absorption of animal poisons and of medicines applied externally, the muscular structure of the heart and the necessary working of its valves. The whole treatise, which occupies only 67 pages of large print in the quarto edition of 1766, is a model of accurate observation, patient accumulation of facts, ingenious experimentation, bold yet cautious hypothesis and logical deduction.

In one point only was the demonstration of the circulation incomplete. Harvey could not discover the capillary channels by which the blood passes from the arteries to the veins. This gap in the circulation was supplied several years later by the great anatomist Marcello Malpighi, who in 1661 saw in the lungs of a frog, by the newly invented microscope, how the blood passes from the one set of vessels to the other. Harvey saw all that could be seen by the unaided eye in his observations on living animals; Malpighi, four years after Harvey's death, by another observation on a living animal, completed the splendid chain of evidence. If this detracts from Harvey's merit it leaves Servetus no merit at all. But in fact the existence of the channels first seen by Malpighi was as clearly pointed to by Harvey's reasoning as the existence of Neptune by the calculations of Leverrier and of Adams.

Harvey himself and all his contemporaries were well aware of the novelty and importance of his theory. He says in the admirable letter to Dr Argent, president of the College of Physicians, which follows the dedication of his treatise to Charles I., that he should not have ventured to publish "a book which alone asserts that the blood pursues its course and flows back again by a new path, contrary to the received doctrine taught so many ages by innumerable learned and illustrious men," if he had not set forth his theory for more than nine years in his college lectures, gradually brought it to perfection, and convinced his colleagues by actual demonstrations of the truth of what he advanced. He anticipates opposition, and even obloquy or loss, from the novelty of his views. These anticipations, however, the event proved to have been groundless. If we are to credit Aubrey indeed, he found that after the publication of the *De motu* "he fell mightily in his practice; 'twas believed by the vulgar that he was crackbrained, and all the physicians were against him." But the last assertion is demonstrably untrue; and if apothecaries and patients ever forsook him, they must soon have returned, for Harvey left a handsome fortune. By his own profession the book was received as it deserved. So novel a doctrine was not to be accepted without due inquiry, but his colleagues had heard his lectures and seen his demonstrations for years; they were already convinced of the truth of his theory, urged its publication, continued him in his lectureship, and paid him every honour in their power. In other countries the book was widely read and much canvassed. Few accepted the new theory; but no one dreamed of claiming the honour of it for himself, nor for several years did any one pretend that it could be found in the works of previous authors. The first attack on it was a feeble tract by one James Primerose, a pupil of Jean Riolan (*Exerc. et animado. in libr. Harveii de motu cord. et sang.*, 1630). Five years later Parisianus, an Italian physician, published his *Lapis Lydius de motu cord.*

et sang. (Venice, 1635), a still more bulky and futile performance. Primerose's attacks were "imbellia plerumque" and "sine ictu"; that of Parisianus "in quamplurimis turpibus," according to the contemporary judgment of Johann Vesling. Their dulness has protected them from further censure. Caspar Hoffmann, professor at Nuremberg, while admitting the truth of the lesser circulation in the full Harveian sense, denied the rest of the new doctrine. To him the English anatomist replied in a short letter, still extant, with great consideration yet with modest dignity, beseeching him to convince himself by actual inspection of the truth of the facts in question. He concludes: "I accept your censure in the candid and friendly spirit in which you say you wrote it; do you also let the same to me, now that I have answered you in the same spirit." This letter is dated May 1636, and in that year Harvey passed through Nuremberg with the earl of Arundel, and visited Hoffmann. But he failed to convince him; "nec tamen valuit Harveius vel coram," writes P. M. Schlegel, who, however, afterwards succeeded in persuading the obstinate old Galenist to soften his opposition to the new doctrine, and thinks that his complete conversion might have been effected if he had but lived a little longer—"nec dubito quin concessisset tandem in nostra castra." While in Italy the following year Harvey visited his old university of Padua, and demonstrated his views to Professor Vesling. A few months later this excellent anatomist wrote him a courteous and sensible letter, with certain objections to the new theory. The answer to this has not been preserved, but it convinced his candid opponent, who admitted the truth of the circulation in a second letter (both were published in 1640), and afterwards told a friend, "Harveium nostrum si audias, agnosces coelestem sanguinis et spiritus ingressum ex arteriis per venas in dextrum cordis sinum." Meanwhile a greater convert, R. Descartes, in his *Discours sur la méthode* (1637) had announced his adhesion to the new doctrine, and refers to "the English physician to whom belongs the honour of having first shown that the course of the blood in the body is nothing less than a kind of perpetual movement in a circle." J. Walaeus of Leyden, H. Regius of Utrecht and Schlegel of Hamburg successively adopted the new physiology. Of these professors, Regius was molested by the pertinacious Primerose and molested him in return (*Spongia qua diutius sordet quae Jac. Primrosius, &c., and Antidotum ad Spongiam senescentem Henr. Regii*). Descartes afterwards repeated Harvey's vivisections, and, more convinced than ever, demolished Professor V. F. Plempius of Louvain, who had written on the other side. George Ent also published an *Apologia pro circulatione sanguinis* in answer to Parisianus.

At last Jean Riolan ventured to publish his *Enchiridium anatomicum* (1648), in which he attacks Harvey's theory, and proposes one of his own. Riolan had accompanied the queen dowager of France (Maria de' Medici) on a visit to her daughter at Whitehall, and had there met Harvey and discussed his theory. He was, in the opinion of the judicious Haller, "vir asper et in numero suoque coaevo immitis ac nemini parens, nimis avidus suorum laudum praeco, et se ipso latente anatomicorum princeps." Harvey replied to the *Enchiridium* with perfectly courteous language and perfectly conclusive arguments, in two letters *De circulatione sanguinis*, which were published at Cambridge in 1649, and are still well worth reading. He speaks here of the "circuitus sanguinis a me inventus." Riolan was unconvinced, but lived to see another professor of anatomy appointed in his own university who taught Harvey's doctrines. Even in Italy, Trullius, professor of anatomy at Rome, expounded the new doctrine in 1651. But the most illustrious converts were Jean Pecquet of Dieppe, the discoverer of the thoracic duct, and of the true course of the lacteal vessels, and Thomas Bartholinus of Copenhagen, in his *Anatomie ex omnium veterum recentiorumque observationibus, imprimis institutibus beati mei parentis Caspari Bartholini, ad circulationem Harveianam et vasa lymphatica renovata* (Leiden, 1651). At last Plempius also retracted all his objections; for, as he candidly stated, "having opened the bodies of a few living dogs, I find that all Harvey's statements are perfectly true." Hobbes of Malmesbury could not say in the preface to his *Elementa philosophiae* that his friend Harvey, "solus quod etiam, doctrinam novam superata invidia vivens stabilivit."

It has been made a reproach to Harvey that he failed to appreciate the importance of the discoveries of the lacteal and lymphatic vessels by G. Aselli, J. Pecquet and C. Bartholinus. In three letters on the subject, one to Dr R. Morison of Paris (1652) and two to Dr Horst of Darmstadt (1653), a correspondent of Bartholin's, he discusses these observations, and shows himself unconvinced of their accuracy. He writes, however, with great moderation and reasonableness, and excuses himself from investigating the subject further on the score of the infirmities of age; he was then above seventy-four. The following quotation shows the spirit of these letters: "Laudo equidem summopere Pecqueti aliorumque in indaganda veritate industrium singulare, nec dubito quin multa adhuc in Democriti puteo abscondita sint, a venturi saeculi indefatigabili diligentia expromenda." Bartholin, though reasonably disappointed in not having Harvey's concurrence, speaks of him with the utmost respect, and generously says that the glory of discovering the movements of the heart and of the blood was enough for one man.

Harvey's Work on Generation.—We have seen how Dr. Ent persuaded his friend to publish this book in 1651. It is between five and six times as long as the *Exerc. de motu cord. et sang.*, and is followed by excursus *De partu, De uteri membranis, De conceptione*; but, though the fruit of as patient and extensive observations, its value is far inferior. The subject was far more abstruse, and in fact inaccessible to proper investigation without the aid of the microscope. And the field was almost untrodden since the days of Aristotle. Fabricius, Harvey's master, in his work *De formatione ovi et pulli* (1621), had alone preceded him in modern times. Moreover, the seventy-two chapters which form the book lack the co-ordination so conspicuous in the earlier treatise, and some of them seem almost like detached chapters of a system which was never completed or finally revised.

Aristotle had believed that the male parent furnished the body of the future embryo, while the female only nourished and formed the seed; this is in fact the theory on which, in the *Ennemides* of Aeschylus, Apollo obtains the acquittal of Orestes. Galen taught almost as erroneously that each parent contributes seeds, the union of which produced the young animal. Harvey, after speaking with due honour of Aristotle and Fabricius, begins rightly "ab ovo"; for, as he remarks, "eggs cost little and are always and everywhere to be had," and moreover "almost all animals, even those which bring forth their young alive, and man himself, are produced from eggs" ("omnia omnino animalia, etiam vivipara, atque hominem adeo ipsum, ex ovo progigni"). This dictum, usually quoted as "omne vivum ex ovo," would alone stamp this work as worthy of the discoverer of the circulation of the blood, but it was a prevision of genius, and was not proved to be a fact until K. E. von Baer discovered the mammalian ovum in 1827. Harvey proceeds with a careful anatomical description of the ovary and oviduct of the hen, describes the new-laid egg, and then gives an account of the appearance seen on the successive days of incubation, from the 1st to the 6th, the 10th and the 14th, and lastly describes the process of hatching. He then comments upon and corrects the opinions of Aristotle and Fabricius, declares against spontaneous generation (though in one passage he seems to admit the current doctrine of production of worms by putrefaction as an exception), proves that there is no *semen foemineum*, that the chalazae of the hen's eggs are not the *semen galli*, and that both parents contribute to the formation of the egg. He describes accurately the first appearance of the ovarian ova as mere specks, their assumption of yolk and afterwards of albumen. In chapter xiv. he describes two methods of production of the embryo from the ovum: one is *metamorphosis*, or the direct transformation of pre-existing material, as a worm from an egg, or a butterfly from an *aurelia* (chrysalis); the other is *epigenesis*, or development with addition of parts, the true generation observed in all higher animals. Chapters xvi.-i. are devoted to the abstruse question of the efficient cause of generation, which, after much discussion of the opinions of Aristotle and of Sennertius, Harvey refers to the action of both parents as the efficient instruments of the first great cause.¹ He then goes on to describe the order in which the several parts appear in the chick. He states that the *punctum saliens* or foetal heart is the first organ to be seen, and explains that the nutrition of the chick is not only effected by yolk conveyed directly into the midgut, as Aristotle taught, but also by absorption from yolk and white by the umbilical (omphalomesaraic) veins; on the fourth day of incubation appear two masses (which he oddly names *vermiculus*), one of which develops into three vesicles, to form the cerebrum, cerebellum and eyes, the other into the breastbone and thorax; on the sixth or seventh day come the viscera, and lastly, the feathers and other external parts. Harvey points out how nearly this order of development in the chick agrees with what he had observed in mammalian and particularly in human embryos. He notes the bifid apex of the foetal heart in man and the equal thickness of the ventricles, the soft cartilages which represent the future bones, the large amount of liquor amnii and absence of placenta which characterize the foetus in the third month; in the fourth the position of the testes in the abdomen, and the uterus with its Fallopian tubes resembling the uterus bicornis of the sheep; the large thymus; the caecum, small as in the adult, not forming a

¹ So in *Exerc. liv.*: "Superior itaque et diviniore opifex, quam est homo, videtur hominem fabricare et conservare, et nobilior artifex, quam gallus, pullum ex ovo producere. Nempe agnoscimus Deum, creatorem summum atque omnipotentem, in cunctorum animalium fabrica ubique praesentem esse, et in operibus suis quasi digito monstrari: cuius in procreatione pulli instrumenta sint gallus et gallina. . . . Nec quicumque sane haec attributa conveniunt nisi omnipotenti rerum Principio, quoquecum demum nomine idipsum appellare libuerit: sive Mentem divinam cum Aristotele, sive cum Platone Animam Mundi, aut cum aliis Naturam naturantem, vel cum ethnicis Saturnum aut Iovem; alii potius (ut nos decet) Creatorem ac Patrem omnium quae in coelis et terris, a quo animalia eorumque origines dependunt, cujusque nutu sive effatu fiunt et generantur omnia.

second stomach as in the pig, the horse and the hare; the lobulated kidneys, like those of the seal ("*vitulo*," ac. *marino*) and porpoise, and the large suprarenal veins, not much smaller than those of the kidneys (ii.-lv). He failed, however, to trace the connexion of the urachus with the bladder. In the following chapters (lxiii.-lxvii.) he describes the process of generation in the fallow deer or the roe. After again insisting that all animals arise from ova, that a "conception" is an internal egg and an egg an extruded conception, he goes on to describe the uterus of the doe, the process of impregnation, and the subsequent development of the foetus and its membranes, the *punctum saliens*, the cotyledons of the placenta, and the "uterine milk," to which Sir William Turner recalled attention in later years. The treatise concludes with detached notes on the placenta, parturition and allied subjects.

Harvey's other Writings and Medical Practice.—The remaining writings of Harvey which are extant are unimportant. A complete list of them will be found below, together with the titles of those which we know to be lost. Of these the most important were probably that on respiration, and the records of post-mortem examinations. From the following passage (*De partu*, p. 550) it seems that he had a notion of respiration being connected rather with the production of animal heat than, as then generally supposed, with the cooling of the blood. "Haec qui diligenter perpendit, naturamque aeris diligenter introsperit, facile opinor fatebitur eundem nec refrigerationis gratia nec in pabulum animalibus concedi. Haec autem obiter duntaxat de respiratione diximus, proprio loco de eadem forsitan copiosius disceptatur."

Of Harvey as a practising physician we know very little. Aubrey tells us that "he paid his visits on horseback with a foot-cloth, his man following on foot, as the fashion then was." He adds—"Though all of his profession would allow him to be an excellent anatomist, I never heard any that admired his therapeutic way. I knew several practitioners that would not have given threepence for one of his bills" (the apothecaries used to collect physicians' prescriptions and sell or publish them to their own profit), "and that a man could hardly tell by his bill what he did aim at." However this may have been,—and rational therapeutics was impossible when the foundation stone of physiology had only just been laid,—we know that Harvey was an active practitioner, performing such important surgical operations as the removal of a breast, and he turned his obstetric experience to account in his book on generation. Some good practical precepts as to the conduct of labour are quoted by Percivall Willughby (1596-1685). He also took notes of the anatomy of disease; these unfortunately perished with his other manuscripts. Otherwise we might regard him as a forerunner of G. B. Morgagni; for Harvey saw that pathology is but a branch of physiology, and like it must depend first on accurate anatomy. He speaks strongly to this purpose in his first epistle to Riolan: "Sicut enim sanorum et boni habitus corporum dissectio plurimum ad philosophiam et rectam physiologiam facit, ita corporum morbosorum et cachecticorum inspectio potissimum ad pathologiam philosophicam." The only specimen we have of his observations in morbid anatomy is his account of the post-mortem examination made by order of the king on the body of the famous Thomas Parr, who died in 1635, at the reputed age of 152. Harvey insists on the value of physiological truths for their own sake, independently of their immediate utility; but he himself gives us an interesting example of the practical application of his theory of the circulation in the cure of a large tumour by tying the arteries which supplied it with blood (*De generat. Exerc. xix.*).

The following is believed to be a complete list of all the known writings of Harvey, published and unpublished:—

Exercitatio anatomica de motu cordis et sanguinis, 410 (Frankfort-on-the-Main, 1628); *Exercitationes duae anatomicae de circulatione sanguinis, ad Johannem Riolanum, filium, Parisiensem* (Cambridge, 1649); *Exercitationes de generatione animalium, quibus accedunt quaedam de partu, de membranis ac humoribus uteri, et de conceptione*, 410 (London, 1651); *Anatomia Thomae Parr*, first published in the treatise of Dr John Betts, *De ortu et natura sanguinis*, 8vo (London, 1669). Letters: (1) to Caspar Hoffmann of Nuremberg, May 1636; (2) to Schlegel of Hamburg, April 1651; (3) three to Giovanni Nardi of Florence, July 1651, Dec. 1653 and Nov. 1655; (4) two to Dr Morison of Paris, May 1652; (5) two to Dr Horst of

Darmstadt, Feb. 1654–1655 and July 1655; (6) to Dr Vlackveld of Haarlem, May 1657. His letters to Hoffmann and Schlegel are on the circulation; those to Morison, Horns and Vlackveld refer to the discovery of the lacteals; the two to Nardi are short letters of friendship. All these letters were published by Sir George Ent in his collected works (Leiden, 1687). Of two MS. letters, one on official business to the secretary Dorchester was printed by Dr Aveling, with a facsimile of the crabbed handwriting (*Memorials of Harvey*, 1875), and the other, about a patient, appears in Dr Robert Willis's *Life of Harvey* (1878). *Prælectiones anatomiae universalis per me Gul. Harveium medicum Londinensem, anat. et chir. professorem, an. dom. (1616), aetat. 37.*—MS. notes of his Lumnick lectures in Latin,—are in the British Museum library; an autotype reproduction was issued by the College of Physicians in 1886. An account of a second MS. in the British Museum, entitled *Gulielmus Harveius de musculis, motu locali, &c.*, was published by Sir G. E. Paget (*Notice of an unpublished MS. of Harvey*, London, 1890). The following treatises, or notes towards them, were lost either in the pillaging of Harvey's house, or perhaps in the fire of London, which destroyed the old College of Physicians: *A Treatise on Respiration*, promised and probably at least in part completed (pp. 82, 550, ed. 1766); *Observationes de usu Lienis*; *Observationes de motu locali*, perhaps identical with the above-mentioned manuscript; *Tractatum physiologicum; Anatomia medicinalis* (apparently notes of morbid anatomy); *De generatione insectorum*. The fine 4to edition of Harvey's *Works*, published by the Royal College of Physicians in 1766, was superintended by Dr Mark Akenside; it contains the two treatises, the account of the post-mortem examination of old Parr, and the six letters enumerated above. A translation of this volume by Dr Willis, with Harvey's will, was published by the Sydenham Society, 8vo (London, 1849).

The following are the principal biographies of Harvey: in Aubrey's *Letters of Eminent Persons*, &c., vol. ii. (London, 1813), first published in 1685, the only contemporary account; in Bayle's *Dictionnaire historique et critique* (1698 and 1720; Eng. ed., 1738); in the *Biographia Britannica*, and in Aiken's *Biographical Memoirs of the Latin Life*; by Dr Thomas Lawrence, prefixed to the college edition of Harvey's *Works* in 1766; memoir in *Lives of British Physicians* (London, 1830); a Life by Dr Robert Willis, founded on that by Lawrence, and prefixed to his English edition of Harvey in 1847; the much enlarged Life by the same author, published in 1878; the biography by Dr William Munk in the *Roll of the College of Physicians*, vol. i. (2nd ed., 1879).

The literature which has arisen on the great discovery of Harvey, on his methods and his merits, would fill a library. The most important contemporary writings have been mentioned above. The following list gives some of the most remarkable in modern times: the article in Bayle's dictionary quoted above; *Anatomical Lectures*, by Wm. Hunter, M.D. (1784); Sprengell, *Geschichte der Arzneikunde* (Halle, 1800), vol. iv.; Flourens, *Histoire de la circulation* (1854); Lewes, *Physiology of Common Life* (1899), vol. i. pp. 291–345; Ceradini, *La Scoperta della circolazione del sangue* (Milan, 1876); Tollin, *Die Entdeckung des Blutkreislaufs durch Michael Serret* (Jena, 1876); Kirchner, *Die Entdeckung des Blutkreislaufs* (Berlin, 1878); Willis, in his *Life of Harvey*; Wharton Jones, "Lecture on the Circulation of the Blood," *Lancet* for Oct. 25 and Nov. 1, 1879; and the various *Harveian Orations*, especially those by Sir E. Sieveking, Dr Guy and Professor George Rolleston. (P. H. P.-S.)

HARVEY, a city of Cook county, Illinois, U.S.A., about 18 m. S. of the Chicago Court House. Pop. (1900) 5305 (982 foreign-born); (1910) 7227. It is served by the Chicago Terminal Transfer, the Grand Trunk and the Illinois Central railways. Harvey is a manufacturing and residence suburb of Chicago. Among its manufactures are railway, foundry and machine-shop supplies, nining and ditching machinery, stone crushers, street-making and street-cleaning machinery, stoves and motor-vehicles. It was named in honour of Turlington W. Harvey, a Chicago capitalist, founded in 1890, incorporated as a village in 1891 and chartered as a city in 1895.

HARWICH, a municipal borough and seaport in the Harwich parliamentary division of Essex, England, on the extremity of a small peninsula projecting into the estuary of the Stour and Orwell, 70 m. N.E. by E. of London by the Great Eastern railway. Pop. (1901), 10,070. It occupies an elevated situation, and a wide view is obtained from Beacon Hill at the southern end of the esplanade. The church of St Nicholas was built of rick in 1821; and there are a town hall and a custom-house. The harbour is one of the best on the east coast of England, and a stormy weather is largely used for shelter. A breakwater and sea-wall prevent the blocking of the harbour entrance and encroachments of the sea; and there is another breakwater at Landguard Point on the opposite (Suffolk) shore of the estuary. The principal imports are grain and agricultural produce, timber

and coal, and the exports cement and fish. Harwich is one of the principal English ports for continental passenger traffic, steamers regularly serving the Hook of Holland, Amsterdam, Rotterdam, Antwerp, Esbjerg, Copenhagen and Hamburg. The continental trains of the Great Eastern railway run to Parkeston Quay, 1 m. from Harwich up the Stour, where the passenger steamers start. The fisheries are important, principally those for shrimps and lobsters. There are cement and shipbuilding works. The port is the headquarters of the Royal Harwich Yacht Club. There are batteries at and opposite Harwich, and modern works on Shotley Point, at the fork of the two estuaries. There are also several of the Martello towers of the Napoleonic era. At Landguard Fort there are important defence works with heavy modern guns commanding the main channel. This has been a point of coast defence since the time of James I. Between the Parkeston Quay and Town railway stations is that of Dovercourt, an adjoining parish and popular watering-place. Harwich is under a mayor, 4 aldermen and 12 councillors. Area, 1541 acres.

Harwich (Herewica, Herewyck) cannot be shown to have been inhabited very early, although in the 18th century remains of a camp, possibly Roman, existed there. Harwich formed part of the manor of Dovercourt. It became a borough in 1319 by a charter of Edward II., which was confirmed in 1342 and 1378, and by each of the Lancastrian kings. The exact nature and degree of its self-government is not clear. Harwich received charters in 1547, 1553 and 1560. In 1604 James I. gave it a charter which amounted to a new constitution, and from this charter begins the regular parliamentary representation. Two burgesses had attended parliament in 1343, but none had been summoned since. Until 1867 Harwich returned two members; it then lost one, and in 1885 it was merged in the county. Included in the manor of Dovercourt, Harwich from 1086 was for long held by the de Vere family. In 1252 Henry III. granted to Roger Bigod a market here every Tuesday, and a fair on Ascension day, and eight days after. In 1320 a grant occurs of a Tuesday market, but no fair is mentioned. James I. granted a Friday market, and two fairs, at the feast of St Philip and St James, and on St Luke's day. The fair has died out, but markets are still held on Tuesday and Friday. Harwich has always had a considerable trade; in the 14th century merchants came from Spain, and there was much trade in wheat and wool with Flanders. But the passenger traffic appears to have been as important at Harwich in the 14th century as it is now. Shipbuilding was a considerable industry at Harwich in the 17th century.

HARZBURG, a town of Germany, in the duchy of Brunswick, beautifully situated in a deep and well-wooded vale at the north foot of the Harz Mountains, at the terminus of the Brunswick-Harzburg railway, 5 m. E.S.E. from Goslar and 18 m. S. from Wolfenbüttel. Pop. (1905), 4396. The Radau, a mountain stream, descending from the Brocken, waters the valley and adds much to its picturesque charm. The town is much frequented as a summer residence. It possesses brine and carbonated springs, the Juliusshall saline baths being about a mile to the south of the town, and a hydropathic establishment. A mile and a half south from the town lies the Burgberg, 1500 ft. above sea-level, on whose summit, according to tradition, was once an altar to the heathen idol Krodo, still to be seen in the Ulrich chapel at Goslar. There are on the summit of the hill the remains of an old castle, and a monument erected in 1875 to Prince Bismarck, with an inscription taken from one of his speeches against the Ultramontane claims of Rome—"Nach Canossa gehen wir nicht."

The castle on the Burgberg called the Harzburg is famous in German history. It was built between 1065 and 1069, but was laid in ruins by the Saxons in 1074; again it was built and again destroyed during the struggle between the emperor Henry IV. and the Saxons. By Frederick I. it was granted to Henry the Lion, who caused it to be rebuilt about 1180. It was a frequent residence of Otto IV., who died therein, and after being frequently besieged and taken, it passed to the house of

Brunswick. It ceased to be of importance as a fortress after the Thirty Years' War, and gradually fell into ruins.

See Delius, *Untersuchungen über die Geschichte der Harzburg* (Halberstadt, 1826); Dommes, *Harzburg und seine Umgebung* (Goslar, 1862); Jacobs, *Die Harzburg und ihre Geschichte* (1885); and Stolle, *Führer von Bad Harzburg* (1899).

HARZ MOUNTAINS (also spelt HARTZ, Ger. *Harzgebirge*, anc. *Silva Hercynia*), the most northerly mountain-system of Germany, situated between the rivers Weser and Elbe, occupy an area of 784 sq. m., of which 455 belong to Prussia, 286 to Brunswick and 43 to Anhalt. Their greatest length extends in a S.E. and N.W. direction for 57 m., and their maximum breadth is about 20 m. The group is made up of an irregular series of terraced plateaus, rising here and there into rounded summits, and intersected in various directions by narrow, deep valleys. The north-western and higher part of the mass is called the Ober or Upper Harz; the south-eastern and more extensive part, the Unter or Lower Harz; while the N.W. and S.W. slopes of the Upper Harz form the Vorharz. The Brocken group, which divides the Upper and Lower Harz, is generally regarded as belonging to the first. The highest summits of the Upper Harz are the Brocken (3747 ft.), the Heinrichshöhe (3425 ft.), the Königsberg (3376 ft.) and the Wurmberg (3176 ft.); of the Lower Harz, the Josephshöhe in the Auerberg group and the Viktorhöhe in the Ramberg, each 1887 ft. Of these the Brocken (*q.v.*) is celebrated for the legends connected with it, immortalized in Goethe's *Faust*. Streams are numerous, but all small. While rendered extensively useful, by various skillful artifices, in working the numerous mines of the district, at other parts of their course they present the most picturesque scenery in the Harz. Perhaps the finest valley is the rocky Bodethal, with the Rossplatte, the Hexentanzplatz, the Baumannshöhle and the Bielsöhle.

The Harz is a mass of Palaeozoic rock rising through the Mesozoic strata of north Germany, and bounded on all sides by faults. Slates, schists, quartzites and limestones form the greater part of the hills, but the Brocken and Victorshöhe are masses of intrusive granite, and diabases and diabase tufts are interstratified with the sedimentary deposits. The Silurian, Devonian and Carboniferous systems are represented—the Silurian and Devonian forming the greater part of the hills S.E. of a line drawn from Lauterberg to Wernigerode, while N.W. of this line the Lower Carboniferous predominates. A few patches of Upper Carboniferous are found on the borders of the hills near Ilfeld, Ballenstedt, &c., lying unconformably upon the Devonian. The structure of the Harz is very complicated, but the general strike of the folds, especially in the Oberharz plateau, is N.E. or N.N.E. The whole mass evidently belongs to the ancient Hercynian chain of North Europe (which, indeed, derives its name from the Harz), and is the north-easterly continuation of the rocks of the Ardennes and the Eifel. The folding of the old rocks took place towards the close of the Palaeozoic era; but the faulting to which they owe their present position was probably Tertiary. Metalliferous veins are common, amongst the best-known being the silver-bearing lead veins of Klausthal, which occur in the Cuium or Lower Carboniferous.

Owing to its position as the first range which the northerly winds strike after crossing the north German plain, the climate on the summit of the Harz is generally raw and damp, even in summer. In 1895 an observatory was opened on the top of the Brocken, and the results of the first five years (1896-1900) showed a July mean of 50° Fahr., a February mean of 24.7°, and a yearly mean of 36.6°. During the same five years the rainfall averaged 64½ ins. annually. But while the summer is thus relatively ungenial on the top of the Harz, the usual summer heat of the lower-lying valleys is greatly tempered and cooled; so that, adding this to the natural attractions of the scenery, the deep forests, and the legendary and romantic associations attaching to every fantastic rock and ruined castle, the Harz is a favourite summer resort of the German people. Among the more popular places of resort are Harzburg, Thale and the Bodethal; Blankenburg, with the Teufelsmauer and the Hermannshöhle; Wernigerode, Ilsenburg, Grund, Lauterberg, Hubertusbad, Alexisbad and Suderode. Some of these, and other places not named, add to their natural attractions the advantage of mineral springs and baths, pine-needle baths, whey cures, &c. The Harz is penetrated by several railways, among them a rack-railway up the

Brocken, opened in 1898. The district is traversed by excellent roads in all directions.

The northern summits are destitute of trees, but the lower slopes of the Upper Harz are heavily wooded with pines and firs. Between the forests of these stretch numerous peat-mosses, which contain in their spongy reservoirs the sources of many small streams. On the Brocken are found one or two arctic and several alpine plants. In the Lower Harz the forests contain a great variety of timber. The oak, elm and birch are common, while the beech especially attains an unusual size and beauty. The walnut-tree grows in the eastern districts.

The last bear was killed in the Harz in 1705, and the last lynx in 1817, and since that time the wolf too has become extinct; but deer, foxes, wild cats and badgers are still found in the forests.

The Harz is one of the richest mineral storehouses in Germany, and the chief industry is mining, which has been carried on since the middle of the 16th century. The most important mineral is a peculiarly rich argentiferous lead, but gold in small quantities, copper, iron, sulphur, alum and arsenic are also found. Mining is carried on principally at Klausthal and St Andreasberg in the Upper Harz. Near the latter is one of the deepest mining shafts in Europe, namely the Samson, which goes down 2790 ft. or 720 ft. below sea-level. For the purpose of getting rid of the water, and obviating the flooding of such deep workings, it has been found necessary to construct drainage works of some magnitude. As far back as 1777-1799 the Georgsstollen was cut through the mountains from the east of Klausthal westward to Grund, a distance of 4 m.; but this proving insufficient, another sewer, the Ernst-Auguststollen, no less than 14 m. in length, was made from the same neighbourhood to Gittelde, at the west side of the Harz, in 1851-1864. Marble, granite and gypsum are worked; and large quantities of vitriol are manufactured. The vast forests that cover the mountain slopes supply the materials for a considerable trade in timber. Much wood is exported for building and other purposes, and in the Harz itself is used as fuel. The sawdust of the numerous mills is collected for use in the manufacture of paper. Turf-cutting, coarse lace-making and the breeding of canaries and native song-birds also occupy many of the people. Agriculture is carried on chiefly on the plateaus of the Lower Harz; but there is excellent pasturage both in the north and in the south. In the Lower Harz, as in Switzerland, the cows, which carry bells harmoniously tuned, are driven up into the heights in early summer, returning to the sheltered regions in late autumn.

The inhabitants are descended from various stocks. The Upper and Lower Saxon, the Thuringian and the Frankish races have all contributed to form the present people, and their respective influences are still to be traced in the varieties of dialect. The boundary line between High and Low German passes through the Harz. The Harz was the last stronghold of paganism in Germany, and to that fact are due the legends, in which no district is richer, and the fanciful names given by the people to peculiar objects and appearances of nature.

See *Zeitschrift des Harzvereins* (Wernigerode, annually since 1868); Günther, *Der Harz in Geschichts-, Kultur- und Landschaftsbildern* (Hanover, 1885); and "Der Harz" in Scobel's *Monographien zur Erdkunde* (Bielefeld, 1901); H. Hoffmann and others, *Der Harz* (Leipzig, 1899); *Harzwanderungen* (Leipzig, 1902); Hampe, *Flora Hercynica* (Halle, 1873); von Groddeck, *Abriss der Geographie des Harzes* (2nd ed., Klausthal, 1883); Prühle, *Harz sagen* (2nd ed., Leipzig, 1886); Hautzinger, *Der Kupfer- und Silbersegen des Harzes* (Berlin, 1877); Hoppe, *Die Bergwerke im Ober- und Unterharz* (Klausthal, 1883); Schultze, *Litha Hercynica* (Leipzig, 1895); Lüdecke, *Die Minerale des Harzes* (Berlin, 1896).

HASA, EL (*Aksa, Al Hasa*), a district in the east of Arabia stretching along the shore of the Persian Gulf from Kuwét in 29° 20' N. to the south point of the Gulf of Bahrein in 25° 10' N., a length of about 360 m. On the W. it is bounded by Nejd, and on the S.E. by the peninsula of El Katr which forms part of Oman. The coast is low and flat and has no deep-water port along its whole length with the exception of Kuwét; from that place to El Katif the country is barren and without villages

or permanent settlements, and is only occupied by nomad tribes, of which the principal are the Bani Hajar, Ajman and Khalid. The interior consists of low stony ridges rising gradually to the inner plateau. The oases of Hofuf and Katif, however, form a strong contrast to the barren wastes that cover the greater part of the district. Here an inexhaustible supply of underground water (to which the province owes its name Hasa) issues in strong springs, marking, according to Arab geographers, the course of a great subterranean river draining the Nejd highlands. Hofuf the capital, a town of 15,000 to 20,000 inhabitants, with its neighbour Mubāriz scarcely less populous, forms the centre of a thriving district 50 m. long by 15 m. in breadth, containing numerous villages each with richly cultivated fields and gardens. The town walls enclose a space of 1½ by 1 m., at the north-west angle of which is a remarkable citadel attributed to the Carmathian princes. Mubāriz is celebrated for its hot spring, known as Um Sabā or "mother of seven," from the seven channels by which its water is distributed. Beyond the present limits of the oasis much of the country is well supplied with water, and ruined sites and half-obliterated canals show that it has only relapsed into waste in recent times. Cultivation reappears at Katif, a town situated on a small bay some 35 m. north-west of Bahrein. Date groves extend for several miles along the coast, which is low and muddy. The district is fertile but the climate is hot and unhealthy; still, owing to its convenient position, the town has a considerable trade with Bahrein and the gulf ports on one side and the interior of Nejd on the other. The fort is a strongly built enclosure attributed, like that at Hofuf, to the Carmathian prince Abu Tahir.

*Uker or *Ujer is the nearest port to Hofuf, from which it is distant about 40 m.; large quantities of rice and piece goods transhipped at Bahrein are landed here and sent on by caravan to Hofuf, the great entrepôt for the trade between southern Nejd and the coast. It also shares in the valuable pearl fishery of Bahrein and the adjacent coast.

Politically El Hasa is a dependency of Turkey, and its capital Hofuf is the headquarters of the sanjak or district of Nejd. Hofuf, Katif and El Katr were occupied by Turkish garrisons in 1871, and the occupation has been continued in spite of British protest as to El Katr, which according to the agreement made in 1867, when Bahrein was taken under British protection, was tributary to the latter. Turkish claims to Kuwait have not been admitted by Great Britain.

AUTHORITIES.—W. G. Palgrave, *Central and Eastern Arabia* (London, 1865); L. Pelly, *Journal R.G.S.* (1866); S. M. Zwemer, *Geog. Journal* (1902); G. F. Sadlier, *Diary of a Journey across Arabia* (Bombay, 1866); V. Chirol, *The Middle East* (London, 1904).

(R. A. W.)

HASAN AND HOSAIN (or **HUSEIN**), sons of the fourth Mahommedan caliph Ali by his wife Fatima, daughter of Mahomet. On Ali's death Hasan was proclaimed caliph, but the strength of Moawiya who had rebelled against Ali was such that he resigned his claim on condition that he should have the disposal of the treasure stored at Kufa, with the revenues of Darabjird. This secret negotiation came to the ears of Hasan's supporters, a mutiny broke out and Hasan was wounded. He retired to Medina where he died about 660. The story that he was poisoned at Moawiya's instigation is generally discredited; see **CALIPHATE**, sect. B, § 1). Subsequently his brother Hosain was invited by partisans in Kufa to revolt against Moawiya's successor Yazid. He was, however, defeated and killed at Kerbela on the 10th of October (Muharram) 680 (see **CALIPHATE**, sect. B, § 2 *ad init.*). Hosain is the hero of the Passion Play which is performed annually (e.g. at Kerbela) on the anniversary of his death by the Shi'ites of Persia and India, to whom from the earliest times the family of Ali are the only true descendants of Mahomet. The play lasts for several days and concludes with he carrying out of the coffins (*tabut*) of the martyrs to an open place in the neighbourhood.

See Sir Wm. Muir, *The Caliphate* (1893); Sir Lewis Pelly, *The Itinerary of Hasan and Hosain* (1879).

HASAN UL-BASRI [Abū Sa'ūd ul-Hasan ibn Abī-l-Hasan (assār ul-Basri)], (642-728 or 737), Arabian theologian, was

born at Medina. His father was a freedman of Zaid ibn Thābit, one of the *Anṣār* (Helpers of the Prophet), his mother a client of Umm Salama, a wife of Mahomet. Tradition says that Umm Salama often nursed Hasan in his infancy. He was thus one of the *Tābi'ūn* (i.e. of the generation that succeeded the Helpers). He became a teacher of Baṣra and founded a school there. Among his pupils was Wāṣil ibn 'Atā, the founder of the Mo'tazilites. He himself was a great supporter of orthodoxy and the most important representative of asceticism in the time of its first development. With him fear is the basis of morality, and sadness the characteristic of his religion. Life is only a pilgrimage, and comfort must be denied to subdue the passions. Many writers testify to the purity of his life and to his excelling in the virtues of Mahomet's own companions. He was "as if he were in the other world." In politics, too, he adhered to the earliest principles of Islam, being strictly opposed to the inherited caliphate of the Omayyads and a believer in the election of the caliph.

His life is given in Nawāwī's *Biographical Dictionary* (ed. F. Wüstenfeld, Göttingen, 1842-1847); Cf. R. Dossy, *Essai sur l'histoire de l'islamisme*, pp. 201 seq. (Leiden and Paris, 1870); A. von Kremer, *Culturgeschichtliche Streifzüge*, p. 5 seq.; R. A. Nicholson, *A Literary History of the Arabs*, pp. 225-227 (London, 1907). (G. W. T.)

HASBEYA, or **HASBEIYA**, a town of the Druses, about 36 m. W. of Damascus, situated at the foot of Mt. Hermon in Syria, overlooking a deep amphitheatre from which a brook flows to the Hasbāni. The population is about 5000 (4000 Christians). Both sides of the valley are planted in terraces with olives, vines and other fruit trees. The grapes are either dried or made into a kind of syrup. In 1846 an American Protestant mission was established in the town. This little community suffered much persecution at first from the Greek Church, and afterwards from the Druses, by whom in 1860 nearly 1000 Christians were massacred, while others escaped to Tyre or Sidon. The castle in Hasbeya was held by the crusaders under Count Oran; but in 1171 the Druse emirs of the great Shehāb family (see **DRUSES**) recaptured it. In 1205 this family was confirmed in the lordship of the town and district, which they held till the Turkish authorities took possession of the castle in the 19th century. Near Hasbeya are bitumen pits let by the government; and to the north, at the source of the Hasbāni, the ground is volcanic. Some travellers have attempted to identify Hasbeya with the biblical Baal-Gad or Baal-Hermon.

HASDAI IBN SHAPRUT, the founder of the new culture of the Jews in Moorish Spain in the 10th century. He was both physician and minister to Caliph Abd ar-Rahman III. in Cordova. A man of wide learning and culture, he encouraged the settlement of Jewish scholars in Andalusia, and his patronage of literature, science and art promoted the Jewish renaissance in Europe. Poetry, philology, philosophy all flourished under his encouragement, and his name was handed down to posterity as the first of the many Spanish Jews who combined diplomatic skill with artistic culture. This type was the creation of the Moors in Andalusia, and the Jews ably seconded the Mahommedans in the effort to make life at once broad and deep. (I. A.)

HASDEU, or **HĂȚEUV**, **BOGDAN PETRICEICU** (1836-1907), Rumanian philologist, was born at Khotin in Bessarabia in 1836, and studied at the university of Kharkov. In 1853 he first settled in Jassy as professor of the high school and librarian. He may be considered as the pioneer in many branches of Rumanian philology and history. At Jassy he started his *Arhivele istorice a Romaniei* (1865-1867), in which a large number of old documents in Slavonic and Rumanian were published for the first time. In 1870 he inaugurated *Columna lui Traian*, the best philological review of the time in Rumania. In his *Cumene den Bătrâni* (2 vols., 1878-1881) he was the first to contribute to the history of apocryphal literature in Rumania. His *Historia critica a Romanilor* (1875), though incomplete, marks the beginning of critical investigation into the history of Rumania. Hasdeu edited the ancient Psalter of Coresi of 1577 (*Psaltirea lui Coresi*, 1881). His *Etymologicum magnum Romaniae* (1886, &c.) is the beginning of an encyclopaedic dictionary of the Rumanian language, though never finished.

beyond the letter B. In 1876 he was appointed director of the state archives in Bucharest and in 1878 professor of philology at the university of Bucharest. His works, which include one drama, *Rasnan și Vidra*, bear the impress of great originality of thought, and the author is often carried away by his profound erudition and vast imagination. Hasdeu was a keen politician. After the death of his only child Julia in 1888 he became a mystic and a strong believer in spiritism. He died at Campina on the 7th of September 1907.

(M. G.)

HASDRUBAL, the name of several Carthaginian generals, among whom the following are the most important:—

1. The son-in-law of Hamilcar Barca (q.v.), who followed the latter in his campaign against the governing aristocracy at Carthage at the close of the First Punic War, and in his subsequent career of conquest in Spain. After Hamilcar's death (228) Hasdrubal, who succeeded him in the command, extended the newly acquired empire by skilful diplomacy, and consolidated it by the foundation of New Carthage (Cartagena) as the capital of the new province, and by a treaty with Rome which fixed the Ebro as the boundary between the two powers. In 221 he was killed by an assassin.

Polybius ii. 1; Livy xxi. 1; Appian, *Hispanica*, 4-8.

2. The second son of Hamilcar Barca, and younger brother of Hannibal. Left in command of Spain when Hannibal departed to Italy (218), he fought for six years against the brothers Gnaeus and Publius Scipio. He had on the whole the worst of the conflict, and a defeat in 216 prevented him from joining Hannibal in Italy at a critical moment; but in 212 he completely routed his opponents, both the Scipios being killed. He was subsequently outgeneralled by Publius Scipio the Younger, who in 209 captured New Carthage and gained other advantages. In the same year he was summoned to join his brother in Italy. He eluded Scipio by crossing the Pyrenees at their western extremity, and, making his way thence through Gaul and the Alps in safety, penetrated far into Central Italy (207). He was ultimately checked by two Roman armies, and being forced to give battle was decisively defeated on the banks of the Metaurus. Hasdrubal himself fell in the fight; his head was cut off and thrown into Hannibal's camp as a sign of his utter defeat.

Polybius x. 34-xi. 3; Livy xxvii. 1-51; Appian, *Bellum Hannibalicum*, ch. lii. sqq.; R. Oehler, *Der letzte Feldzug des Barkiden Hasdrubals* (Berlin, 1897); C. Lehmann, *Die Angriffe der drei Barkiden auf Italien* (Leipzig, 1905). See also PUNIC WARS.

HASE, CARL BENEDICT (1780-1864), French Hellenist, of German extraction, was born at Sulza near Naumburg on the 11th of May 1780. Having studied at Jena and Helmstedt, in 1801 he made his way on foot to Paris, where he was commissioned by the comte de Choiseul-Gouffier, late ambassador to Constantinople, to edit the works of Johannes Lydus from a MS. given to Choiseul by Prince Mourousi. Hase thereupon decided to devote himself to Byzantine history and literature, on which he became the acknowledged authority. In 1805 he obtained an appointment in the MSS. department of the royal library; in 1816 became professor of palaeography and modern Greek at the École Royale, and in 1852 professor of comparative grammar in the university. In 1812 he was selected to superintend the studies of Louis Napoleon (afterwards Napoleon III.) and his brother. He died on the 21st of March 1864. His most important works are the editions of Leo Diaconus and other Byzantine writers (1819), and of Johannes Lydus, *De ostentis* (1823), a masterpiece of textual restoration, the difficulties of which were aggravated by the fact that the MS. had for a long time been stowed away in a wine-barrel in a monastery. He also edited part of the Greek authors in the collection of the Historians of the Crusades and contributed many additions (from the fathers, medical and technical writers, scholiasts and other sources) to the new edition of Stephanus's *Thesaurus*.

See J. D. Guignaut, *Notice historique sur la vie et les travaux de Carl Benedict Hase* (Paris, 1867); articles in *Nouvelle Biographie générale* and *Allgemeine deutsche Biographie*; and a collection of autobiographical letters, *Briefe von der Wanderung und aus Paris*, edited by O. Heine (1894), containing a vivid account of Hase's journey, his enthusiastic impressions of Paris and the hardships of his early life.

HASE, KARL AUGUST VON (1800-1890), German Protestant theologian and Church historian, was born at Steinbach in Saxony on the 25th of August 1800. He studied at Leipzig and Erlangen, and in 1829 was called to Jena as professor of theology. He retired in 1883 and was made a baron. He died at Jena on the 3rd of January 1890. Hase's aim was to reconcile modern culture with historical Christianity in a scientific way. But though a liberal theologian, he was no dry rationalist. Indeed, he vigorously attacked rationalism, as distinguished from the rational principle, charging it with being unscientific inasmuch as it ignored the historical significance of Christianity, shut its eyes to individuality and failed to give religious feeling its due. His views are presented scientifically in his *Evangelisch-protestantische Dogmatik* (1826, 6th ed., 1870), the value of which "lies partly in the full and judiciously chosen historical materials prefixed to each dogma, and partly in the skill, caution and tact with which the permanent religious significance of various dogmas is discussed" (Otto Pfeifferer). More popular in style is his *Gnosis oder prot.-evang. Glaubenslehre* (3 vols., 1827-1829, 2nd ed. in 2 vols., 1869-1870). But his reputation rests chiefly on his treatment of Church history in his *Kirchengeschichte, Lehrbuch zunächst für akademische Vorlesungen* (1834, 12th ed., 1900).

His biographical studies, *Frans von Assis* (1856; 2nd ed., 1892), *Katrina von Siena* (1864, 2nd ed., 1892), *Neue Propheten* (Die Jungfrau von Orleans, Savonarola, Thomas Münzer) are judicious and sympathetic. Other works are: *Hutterus redemptus oder Dogmatik der evang.-luth. Kirche* (1827; 12th ed., 1883), in which he sought to present the teaching of the Protestant church in such a way as Hutter would have reconstructed it, had he still been alive; *Leben Jesu* (1829, 5th ed., 1865, Eng. trans., 1860); in an enlarged form, *Geschichte Jesu* (2nd ed., 1891); and *Handbuch der prot. Polemik gegen die röm.-kath. Kirche* (1862; 7th ed., 1900; Eng. trans., 1906).

For his life see his *Ideale und Irrthümer* (1872, 5th ed., 1894) and *Annalen meines Lebens* (1891), and cf. generally Otto Pfeifferer, *Development of Theology* (1890); F. Lichtenberger, *Hist. of German Theology* (1889).

HASHISH, or **HASHERB**, the Arabic name, meaning literally "dried herb," for the various preparations of the Indian hemp plant (*Cannabis indica*), used as a narcotic or intoxicant in the East, and either smoked, chewed or drunk (see HEMP and Bhang). From the Arabic *hashtshin*, i.e. "hemp-eaters," comes the English "assassin" (see ASSASSIN).

HASLEMERE, a market-town in the Guildford parliamentary division of Surrey, England, 43 m. S.W. from London by the London & South-Western railway. It is situated in an elevated valley between the bold ridges of Hindhead (895 ft.) and Blackdown (918 ft.). Their summits are open and covered with heath, but their flanks and the lower ground are magnificently wooded. The hills are deeply scored by steep and picturesque valleys, of which the most remarkable is the Devil's Punch Bowl, a hollow of regular form on the west flank of Hindhead. The invigorating air has combined with scenic attraction to make the district a favourite place of residence. Professor Tyndall built a house on the top of Hindhead, setting an example followed by many others. On Blackdown, closely screened by plantations, is Aldworth, built for Alfred, Lord Tennyson, who died here in 1892. George Eliot stayed for a considerable period at Shottermill, a neighbouring village. Pop. of Haslemere (1901), 2614; of Hindhead, 666.

HASLINGDEN, a market-town and municipal borough in the Rossendale and Heywood parliamentary divisions of Lancashire, England, 19 m. N. by W. from Manchester by the Lancashire & Yorkshire railway. Pop. (1901), 18,543. It lies in a hilly district on the borders of the forest of Rossendale, and is supposed by some to derive its name from the hazel trees which formerly abounded in its neighbourhood. The old town stood on the slope of a hill, but the modern part has extended about its base. The parish church of St James was rebuilt in 1780, with the exception of the tower, which dates from the time of Henry VIII. The woollen manufacture was formerly the staple. The town, however, steadily increasing in importance, has cotton, woollen and engineering works—coal-mining, quarrying and brickmaking are carried on in the neighbourhood. The borough,

as incorporated in 1891, comprised several townships and parts of townships, but under the Local Government Act of 1894 these were united into one civil parish. The corporation consists of a mayor, 6 aldermen and 18 councillors. Area, 8,196 acres.

HASPE, a town of Germany, in the Prussian province of Westphalia, in the valley of the Ennepe, at the confluence of the Haspe, and on the railway from Düsseldorf to Dortmund, 10 m. N.E. of Barmen by rail. Pop. (1905), 19,813. Its industries include iron foundries, rolling mills, puddling furnaces, and manufactures of iron, steel and brass wares and of machines. Haspe was raised to the rank of a town in 1873.

HASSAM, CHILDE (1859—), American figure and landscape painter, born in Boston, Massachusetts, was a pupil of Boulanger and Lefebvre in Paris. He soon fell under the influence of the Impressionists, and took to painting in a style of his own, in brilliant colour, with effective touches of pure pigment. He won a bronze medal at the Paris Exhibition of 1889; medals at the World's Fair, Chicago, 1893; Boston Art Club, 1896; Philadelphia Art Club, 1892; Carnegie Institute, Pittsburg, 1898; Buffalo Pan-American, 1901; Temple gold medal, Pennsylvania Academy of Fine Arts, Philadelphia, 1899; and silver medal, Paris Exhibition, 1900. He became a member of the National Academy of Design, the Society of American Artists, the Ten Americans, the American Water Colour Society, the Société Nationale des Beaux Arts, Paris, and the Secession Society, Munich.

HASSAN, a town and district of Mysore, India. The town dates from the 11th century and had in 1901 a population of 8241. The district naturally divides into two portions, the Malnad, or hill country, which includes some of the highest ranges of the Western Ghats, and the Maidan or plain country, sloping towards the south. The Hemavati, which flows into the Cauvery in the extreme south, is the most important river of the district. The upper slopes of the Western Ghats are abundantly clothed with magnificent forests, and wild animals abound. Among the mineral products are kaolin, felspar and quartz. The soil of the valleys is a rich red alluvial loam. The area is 2547 sq. m. Population (1901), 568,919, showing an increase of 11% in the decade. The district contains some of the most remarkable archaeological monuments in India, such as the colossal Jain image at Sravana Belgola (a monolith 57 ft. high on the summit of a hill) and the great temple at Halebid. Coffee cultivation has been on the increase of late years. The first plantation was opened in 1843, and now there are many coffee estates owned by Europeans and also native holdings. The exports are large, consisting chiefly of food-grains and coffee. The imports are European piece-goods, hardware of all sorts and spices. The largest weekly fair is held at Alur. A great annual religious gathering and fair, attended by about 10,000 persons, takes place every year at Melukot. The Southern Mahratta railway traverses the north-east of the district.

The real history of Hassan does not begin until the epoch of the Hoysala dynasty, which lasted from the 11th till the 14th century. Their capital was at Dwarasamundra (Dwaravati-pura), the ruins of which are still to be seen scattered round the village of Halebid. The earlier kings professed the Jain faith, but the finest temples were erected to Siva by the later monarchs of the line. While they were at the zenith of their power the whole of southern India acknowledged their sway.

HASSANIÁ, an African tribe of Semitic stock. They inhabit the desert between Merawi and the Nile at the 6th Cataract, and the left bank of the Blue Nile immediately south of Khartum.

HASSAN IBN THĀBIT (died 674), Arabian poet, was born in Yathrib (Medina), a member of the tribe Khazraj. In his youth he travelled to Hira and Damascus, then settled in Medina, where, after the advent of Mahomet, he accepted Islam and wrote poems in defence of the prophet. His poetry is regarded as commonplace and lacking in distinction.

His diwan has been published at Bombay (1864), Tunis (1864) and Lahore (1878). See H. Hirschfeld's "Prolegomena to an edition of the Diwan of Hassan" in *Transactions of Oriental Congress* (London, 1892). (G. W. T.)

HASSE, JOHANN ADOLPH (1699-1783), German musical composer, was born at Bergedorf near Hamburg, on the 25th of March 1699, and received his first musical education from his father. Being possessed of a fine tenor voice, he chose the theatrical career, and joined the operatic troupe conducted by Reinhard Keiser, in whose orchestra Handel had played the second violin some years before. Hasse's success led to an engagement at the court theatre of Brunswick, and it was there that, in 1723, he made his début as a composer with the opera *Antigonus*. The success of this first work induced the duke to send Hasse to Italy for the completion of his studies, and in 1724 he went to Naples and placed himself under Porpora, with whom, however, he seems to have disagreed both as a man and as an artist. On the other hand he gained the friendship of Alessandro Scarlatti, to whom he owed his first commission for a serenade for two voices, sung at a family celebration of a wealthy merchant by two of the greatest singers of Italy, Farinelli and Signora Tesi. This event established Hasse's fame; he soon became very popular, and his opera *Sesostrato*, written for the Royal Opera at Naples in 1726, made his name known all over Italy. At Venice, where he went in 1727, he became acquainted with the celebrated singer Faustina Bordogni (born at Venice in 1700), who became the composer's wife in 1730. The two artists soon afterwards went to Dresden, in compliance with a brilliant offer made to them by the splendour-loving elector of Saxony, Augustus II. There Hasse remained for two years, after which he again journeyed to Italy, and also in 1733 to London, in which latter city he was tempted by the aristocratic clique inimical to Handel to become the rival and antagonist of that great master. But this he modestly and wisely declined, remaining in London only long enough to superintend the rehearsals for his opera *Artaserse* (first produced at Venice, 1730). All this while Faustina had remained at Dresden, the declared favourite of the public and unfortunately also of the elector, nor was her husband, who remained attached to her, allowed to see her except at long intervals. In 1739, after the death of Augustus II., Hasse settled permanently at Dresden till 1763, when he and his wife retired from court service with considerable pensions. But Hasse was still too young to rest on his laurels. He went with his family to Vienna, and added several operas to the great number of his works already in existence. His last work for the stage was the opera *Ruggiero* (1771), written for the wedding of Archduke Ferdinand at Milan. On the same occasion a work by Mozart, then fourteen years old, was performed, and Hasse observed "this youngster will surpass us all." By desire of his wife Hasse settled at her birthplace Venice, and there he died on the 23rd of December 1783. His compositions include as many as 120 operas, besides oratorios, cantatas, masses, and almost every variety of instrumental music. During the siege of Dresden by the Prussians in 1760, most of his manuscripts, collected for a complete edition to be brought out at the expense of the elector, were burnt. Some of his works, amongst them an opera *Alcide al Bivio* (1760), have been published, and the libraries of Vienna and Dresden possess the autographs of others. Hasse's instrumentation is certainly not above the low level attained by the average musicians of his time, and his *ensembles* do not present any features of interest. In dramatic fire also he was wanting, but he had a fund of gentle and genuine melody, and by this fact his enormous popularity during his life must be accounted for. The two airs which Farinelli had to repeat every day for ten years to the melancholy king of Spain, Philip V., were both from Hasse's works. Of Faustina Hasse it will be sufficient to add that she was, according to the unanimous verdict of the critics (including Dr Burney), one of the greatest singers of a time rich in vocal artists. The year of her death is not exactly known. Most probably it shortly preceded that of her husband.

HASSELQUIST, FREDERIK (1722-1752), Swedish traveller and naturalist, was born at Törnevalle, East Gothland, on the 3rd of January 1722. On account of the frequently expressed regrets of Linnæus, under whom he studied at Upsala, at the lack of information regarding the natural history of Palestine,

Hasselquist resolved to undertake a journey to that country, and a sufficient subscription having been obtained to defray expenses, he reached Smyrna towards the end of 1749. He visited parts of Asia Minor, Egypt, Cyprus and Palestine, making large natural history collections, but his constitution, naturally weak, gave way under the fatigues of travel, and he died near Smyrna on the 9th of February 1752 on his way home. His collections reached home in safety, and five years after his death his notes were published by Linnæus under the title *Resa till Heliga Landet föröfhad från år 1749 till 1752*, which was translated into French and German in 1762 and into English in 1766.

HASSELT, ANDRÉ HENRI CONSTANT VAN (1806-1874), Belgian poet, was born at Maastricht, in Limburg, on the 5th of January 1806. He was educated in his native town, and at the university of Liège. In 1833 he left Maastricht, then blockaded by the Belgian forces, and made his way to Brussels, where he became a naturalized Belgian, and was attached to the Bibliothèque de Bourgogne. In 1843 he entered the education department, and eventually became an inspector of normal schools. His native language was Dutch, and as a French poet André van Hasselt had to overcome the difficulties of writing in a foreign language. He had published a *Chant hellénique* in honour of Canaris in the columns of *La Sentinelle des Pays-Bas* as early as 1826, and other poems followed. His first volume of verse, *Primevères* (1834), shows markedly the influence of Victor Hugo, which had been strengthened by a visit to Paris in 1830. His relations with Hugo became intimate in 1851-1852, when the poet was an exile in Brussels. In 1839 he became editor of the *Renaissance*, a paper founded to encourage the fine arts. His chief work, the epic of the *Quatre Incarnations du Christ*, was published in 1867. In the same volume were printed his *Études rythmiques*, a series of metrical experiments designed to show that the French language could be adapted to every kind of musical rhythm. With the same end in view he executed translations of many German songs, and wrote new French libretti for the best-known operas of Mozart, Weber and others. Hasselt died at Saint Josse ten Noode, a suburb of Brussels, on the 1st of December 1874.

A selection from his works (10 vols., Brussels, 1876-1877) was edited by MM. Charles Hen and Louis Alvin. He wrote many books for children, chiefly under the pseudonym of Alfred-Avelines; and studies on historical and literary subjects. The books written in collaboration with Charles Hen are signed Charles André. A bibliography of his writings is appended to the notice by Louis Alvin in the *Biographie nat. de Belgique*, vol. vii. Van Hasselt's fame has continued to increase since his death. A series of tributes to his memory are printed in the *Poésies choisies* (1901), edited by M. Georges Barral for the *Collection des poètes français de l'étranger*. This book contains a biographical and critical study by Jules Guillaume, and some valuable notes on the poet's theories of rhythm.

HASSELT, the capital of the Belgian province of Limburg. Pop. (1904), 16,179. It derives its name from *Hazel-bosch* (hazel wood). It stands at the junction of several important roads and railways from Maaseyck, Maastricht and Liège. It has many breweries and distilleries, and the spirit known by its name, which is a coarse gin, has a certain reputation throughout Belgium. On the 6th of August 1831 the Dutch troops obtained here their chief success over the Belgian nationalists during the War of Independence. Hasselt is best known for its great septennial fête held on the day of Assumption, August 15th. The curious part of this fête, which is held in honour of the Virgin under the name of Virga Jesse, is the conversion of the town for the day into the semblance of a forest. Fir trees and branches from the neighbouring forest are collected and planted in front of the houses, so that for a few hours Hasselt has the appearance of being restored to its primitive condition as a wood. The figure of the giant who is supposed to have once held the Hazel-bosch under his terror is paraded on this occasion as the "lounge man." Originally this celebration was held annually, but in the 18th century it was restricted to once in seven years. There was a celebration in 1905.

HASSENPFUG, HANS DANIEL LUDWIG FRIEDRICH (1794-1862), German statesman, was born at Hanau in Hesse

on the 26th of February 1794. He studied law at Göttingen, graduated in 1816, and took his seat as *Assessor* in the judicial chamber of the board of government (*Regierungshollegium*) at Cassel, of which his father Johann Hassenpflug was also a member. In 1821 he was nominated by the new elector, William II., *Justiciar* (councillor of justice); in 1832 he became *Ministerialrat* and reporter (*Referent*) to the ministry of Hesse-Cassel, and in May of the same year was appointed successively minister of justice and of the interior. It was from this moment that he became conspicuous in the constitutional struggles of Germany.

The reactionary system introduced by the elector William I. had broken down before the revolutionary movements of 1830, and in 1831 Hesse had received a constitution. This development was welcome neither to the elector nor to the other German governments, and Hassenpflug deliberately set to work to reverse it. In doing so he gave the lie to his own early promise; for he had been a conspicuous member of the revolutionary *Burschenschaft* at Göttingen, and had taken part as a volunteer in the War of Liberation. Into the causes of the change it is unnecessary to inquire; Hassenpflug by training and tradition was a strait-laced official; he was also a first-rate lawyer; and his naturally arbitrary temper had from the first displayed itself in an attitude of overbearing independence towards his colleagues and even towards the elector. To such a man constitutional restrictions were intolerable, and from the moment he came into power he set to work to override them, by means of press censorship, legal quibbles, unjustifiable use of the electoral prerogatives, or frank supersession of the legislative rights of the Estates by electoral ordinances. The story of the constitutional deadlock that resulted belongs to the history of Hesse-Cassel and Germany; so far as Hassenpflug himself was concerned, it made him, more even than Metternich, the Mephistopheles of the Reaction to the German people. In Hesse itself he was known as "Hessen's Hass und Fluch" (Hesse's hate and curse). In the end, however, his masterful temper became unendurable to the regent (Frederick William); in the summer of 1837 he was suddenly removed from his post as minister of the interior and he thereupon left the elector's service.

In 1838 he was appointed head of the administration of the little principality of Hohenzollern-Sigmaringen, an office which he exchanged in the following year for that of civil governor of the grand-duchy of Luxemburg. Here, too, his independent character suffered him to remain only a year; he resented having to transact all business with the grand-duke (king of the Netherlands) through a Dutch official at the Hague; he protested against the absorption of the Luxemburg surplus in the Dutch treasury; and, failing to obtain redress, he resigned (1840). From 1841 to 1850 he was in Prussian service, first as a member of the supreme court of justice (*Obertribunal*) and then (1846) as president of the high court of appeal (*Oberappellationsgericht*) at Greifswald. In 1850 he was tried for speculation and convicted; and, though this judgment was reversed on appeal, he left the service of Prussia.

With somewhat indecent haste (the appeal had not been heard) he was now summoned by the elector of Hesse once more to the head of the government, and he immediately threw himself again with zeal into the struggle against the constitution. He soon found, however, that the opinion of all classes, including the army, was solidly against him, and he decided to risk all on an alliance with the reviving fortunes of Austria, which was steadily working for the restoration of the *status quo* overthrown by the revolution of 1848. On his advice the elector seceded from the Northern Union established by Prussia and, on the 13th of September, committed the folly of flying secretly from Hesse with his minister. They went to Frankfurt, where the federal diet had been re-established, and on the 21st persuaded the diet to decree an armed intervention in Hesse. This decree, carried out by Austrian troops, all but led to war with Prussia, but the unreadiness of the Berlin government led to the triumph of Austria and of Hassenpflug, who at the end of the year was once more installed in power at Cassel as minister of finance. His position was, however, not enviable; he was loathed and

despised by all, and disliked even by his master. The climax came in November 1853, when he was publicly horse-whipped by the count of Isenburg-Wächtersbach, the elector's son-in-law. The count was pronounced insane; but Hassenpflug was conscious of the method in his madness, and tendered his resignation. This was, however, not accepted; and it was not till the 16th of October 1855 that he was finally relieved of his offices. He retired to Marburg, where he died on the 15th of October 1862. He lived just long enough to hear of the restoration of the Hesse constitution of 1831 (June 21, 1862), which it had been his life's mission to destroy. Of his publications the most important in *Aktenstücke, die landständischen Anklagen wider den Kurfürstlichen hessischen Staatsminister Hassenpflug. Ein Beitrag zur Zeitgeschichte und zum neueren deutschen Staatsrechte*, anonym. (Stuttgart and Tübingen, 1836). He was twice married, his first wife being the sister of the brothers Grimm. His son Karl Hassenpflug (1824-1890) was a distinguished sculptor.

* See the biography by Wippermann in *Allgemeine deutsche Biographie*, with authorities.

HASTINAPUR, an ancient city of British India, in the Meerut district of the United Provinces, lying on the bank of a former bed of the Ganges, 22 m. N.E. of Meerut. It formed the capital of the great Pandava kingdom, celebrated in the *Mahābhārata*, and probably one of the earliest Aryan settlements outside the Punjab. Tradition points to a group of shapeless mounds as the residence of the Lunar princes of the house of Bharata whose deeds are commemorated in the great national epic. After the conclusion of the famous war which forms the central episode of that poem, Hastinapur remained for some time the metropolis of the descendants of Parikshit, but the town was finally swept away by a flood of the Ganges, and the capital was transferred to **Kausambi**.

HASTINGS, a famous English family. **JOHN, BARON HASTINGS** (c. 1262-c. 1315), was a son of Sir Henry de Hastings (d. 1268), who was summoned to parliament as a baron by Simon de Montfort in 1264. Having joined Montfort's party Sir Henry led the Londoners at the battle of Lewes and was taken prisoner at Evesham. After his release he continued his opposition to Henry III.; he was among those who resisted the king at Kenilworth, and after the issue of the *Dictum de Kenilworth* he commanded the remnants of the baronial party when they made their last stand in the isle of Ely, submitting to Henry in July 1267. His younger son, Edmund, was specially noted for his military services in Scotland during the reign of Edward I. John Hastings married Isabella (d. 1305), daughter of William de Valence, earl of Pembroke, a half-brother of Henry III., and fought in Scotland and in Wales. Through his mother, Joanna de Cantilupe, he inherited the extensive lordship of Abergavenny, hence he is sometimes referred to as lord of Bergavenny, and in 1295 he was summoned to parliament as a baron. Before this date, however, he had come somewhat prominently to the front. His paternal grandmother, Ada, was a younger daughter of David, earl of Huntingdon, and a niece of the Scottish king, William the Lion; and in 1290 when Margaret, the maid of Norway, died, Hastings came forward as a claimant for the vacant throne. Although unsuccessful in the matter he did not swerve from his loyalty to Edward I. He fought constantly either in France or in Scotland; he led the bishop of Durham's men at the celebrated siege of Carlaverock castle in 1300; and with his brother Edmund he signed the letter which in 1301 the English barons sent to Pope Boniface VIII. repudiating papal interference in the affairs of Scotland; on two occasions he represented the king in Aquitaine. Hastings died in 1312 or 1313. His second wife was Isabella, daughter of the elder Hugh le Despenser. Hastings, who was one of the most wealthy and powerful nobles of his time, stood high in the regard of the king and is lauded by the chroniclers.

His eldest son **JOHN** (d. 1325), who succeeded to the barony, was the father of Laurence Hastings, who was created earl of Pembroke in 1339, the earls of Pembroke retaining the barony of Hastings until 1389. A younger son by a second marriage, Sir Hugh Hastings (c. 1307-1347), saw a good deal of military

service in France; his portrait and also that of his wife may still be seen on the east window of Elsing church, which contains a beautiful brass to his memory.

On the death of John, the third and last earl of Pembroke of the Hastings family, in 1389, Sir Hugh's son **JOHN** had, according to a decision of the House of Lords in 1840, a title to the barony of Hastings, but he did not prosecute his claim and he died without sons in 1393. However his grand-nephew, and heir, Hugh (d. 1396), claimed the barony, which was also claimed by Reginald, Lord Grey of Ruthyn. Like the earls of Pembroke, Grey was descended through his grandmother, Elizabeth Hastings, from John, Lord Hastings, by his first wife; Hugh, on the other hand, was descended from John's second wife. After Hugh's death his brother, Sir Edward Hastings (c. 1382-1438), claimed the barony, and the case as to who should bear the arms of the Hastings family came before the court of chivalry. In 1410 it was decided in favour of Grey, who thereupon assumed the arms. Both disputants still claimed the barony, but the view seems to have prevailed that it had fallen into abeyance in 1389. Sir Edward was imprisoned for refusing to pay his rival's costs, and he was probably still in prison when he died in January 1438. After his death the Hastings family, which became extinct during the 16th century, tacitly abandoned the claim to the barony. Then in 1840 the title was revived in favour of Sir Jacob Astley, Bart. (1797-1859), who derived his claim from a daughter of Sir Hugh Hastings who died in 1540. Sir Jacob's descendant, Albert Edward (b. 1882), became 21st Baron Hastings in 1904.

A distant relative of the same family was William, Baron Hastings (c. 1430-1483), a son of Sir Leonard Hastings (d. 1455). He became attached to Edward IV., whom he served before his accession to the throne, and after this event he became master of the mint, chamberlain of the royal household and one of the king's most trusted advisers. Having been made a baron in 1461, he married Catherine, daughter of Richard Neville, earl of Salisbury, and was frequently sent on diplomatic errands to Burgundy and elsewhere. He was faithful to Edward IV. during the king's exile in the winter of 1470-1471, and after his return he fought for him at Barnet and at Tewkesbury; he has been accused of taking part in the murder of Henry VI.'s son, prince Edward, after the latter battle. Hastings succeeded his sovereign in the favour of Jane Shore. He was made captain of Calais in 1471, and was with Edward IV. when he met Louis XI. of France at Picquigny in 1475, on which occasion he received gifts from Louis and from Charles the Bold of Burgundy. After Edward IV.'s death Hastings behaved in a somewhat undecided manner. He disliked the queen, Elizabeth Woodville, but he refused to ally himself with Richard, duke of Gloucester, afterwards King Richard III. Suddenly Richard decided to get rid of him, and during a meeting of the council on the 13th of June 1483 he was seized and at once put to death. This dramatic incident is related by Sir Thomas More in his *History of Richard III.*, and has been worked by Shakespeare into his play *Richard III.* Hastings is highly praised by his friend Philippe de Commines, and also by More. He left a son, Edward (d. 1508), the father of George, Baron Hastings (c. 1488-1545), who was created earl of Huntingdon (q.v.) in 1520.

When Francis, 10th earl of Huntingdon, died in October 1789, the barony of Hastings passed to his sister Elizabeth (1731-1808), wife of John Rawdon, earl of Moira, and from her it came to her son Francis Rawdon-Hastings (see below), who was created marquess of Hastings in 1817.

HASTINGS, FRANCIS RAWDON-HASTINGS, 1st MARQUESS OF (1754-1826), British soldier and governor-general of India, born on the 9th of December 1754, was the son of Sir John Rawdon of Moira in the county of Down, 4th baronet, who was created Baron Rawdon of Moira, and afterwards earl of Moira, in the Irish peerage. His mother was the Lady Elizabeth Hastings, daughter of Theophilus, 9th earl of Huntingdon. Lord Rawdon, as he was then called, was educated at Harrow and Oxford, and joined the army in 1771 as ensign in the 15th foot. His life henceforth was entirely spent in the service of his country, and may be divided into four periods: from 1775 to

1782 he was engaged with much distinction in the American war; from 1783 to 1813 he held various high appointments at home, and took an active part in the business of the House of Lords; from 1813 to 1823 was the period of his labours in India; after retiring from which, in the last years of his life (1824-1826), he was governor of Malta.

In America Rawdon served at the battles of Bunker Hill, Brooklyn, White Plains, Monmouth and Camden, at the attacks on Forts Washington and Clinton, and at the siege of Charleston. In fact he was engaged in many important operations of the war. Perhaps his most noted achievements were the raising of a corps at Philadelphia, called the Irish Volunteers, who under him became famous for their fighting qualities, and the victory of Hobkirk's Hill, which, in command of only a small force, he gained by superior military skill and determination against a much larger body of Americans. In 1781 he was invalided. The vessel in which he returned to England was captured and carried into Brest. He was speedily released, and on his arrival in England was much honoured by George III., who created him an English peer (Baron Rawdon) in March 1783. In 1789 his mother succeeded to the barony of Hastings, and Rawdon added the surname of Hastings to his own.

In 1793 Rawdon succeeded his father as earl of Moira. In 1794 he was sent with 7000 men to Ostend to reinforce the duke of York and the allies in Flanders. The march by which he effected a junction was considered extraordinary. In 1803 he was appointed commander-in-chief in Scotland, and in 1804 he married Flora Mure Campbell, countess of Loudoun in her own right. When Fox and Grenville came into power in 1806, Lord Moira, who had always voted with them, received the place of master-general of the ordnance. He was now enabled to carry a philanthropic measure, of which from his first entry into the House of Lords he had been a great promoter, namely, the Debtor and Creditor Bill for relief of poor debtors. Ireland was another subject to which he had given particular attention: in 1797 there was published a *Speech by Lord Moira on the Dreadful and Alarming State of Ireland*. Lord Moira's sound judgment on public affairs, combined with his military reputation and the uprightness of his character, won for him a high position among the statesmen of the day, and he gained an additional *prestige* from his intimate relations with the prince of Wales. As a mark of the regent's regard Lord Moira received the order of the Garter in 1812, and in the same year was appointed governor-general of Bengal and commander-in-chief of the forces in India. He landed at Calcutta, and assumed office in succession to Lord Minto in October 1813. One of the chief questions which awaited him was that of relations with the Gurkha state of Nepal. The Gurkhas, a brave and warlike little nation, failing to extend their conquests in the direction of China, had begun to encroach on territories held or protected by the East India Company; especially they had seized the districts of Batwal and Seoraj, in the northern part of Oudh, and when called upon to relinquish these, they deliberately elected (April 1814) to go to war rather than do so. Lord Moira, having travelled through the northern provinces and fully studied the question, declared war against Nepal (November 1814). The enemy's frontier was 600 m. long, and Lord Moira, who directed the plan of the campaign, resolved to act offensively along the whole line. It was an anxious undertaking, because the native states of India were all watching the issue and waiting for any serious reverse to the English to join against them. At first all seemed to go badly, as the British officers despised the enemy, and the sepoy were unaccustomed to mountain warfare, and thus alternate extremes of rashness and despondency were exhibited. But this rectified itself in time, especially through the achievements of General (afterwards Sir David) Ochterlony, who before the end of 1815 had taken all the Gurkha posts to the west, and early in 1816 was advancing victoriously within 50 m. of Khatmandu, the capital. The Gurkhas now made peace; they abandoned the disputed districts, ceded some territory to the British, and agreed to receive a British resident. For his masterly conduct of these affairs Lord Moira was created marquess of Hastings in February 1817.

He had now to deal with internal dangers. A combination of Mahratta powers was constantly threatening the continuance of British rule, under the guise of plausible assurances severally given by the peshwa, Sindhia, Holkar and other princes. At the same time the existence of the Pindari state was not only dangerous to the British, as being a warlike power always ready to turn against them, but it was a scourge to India itself. In 1816, however, the Pindaris entered British territory in the Northern Circars, where they destroyed 339 villages. On this, permission was obtained to act for their suppression. Before the end of 1817 the preparations of Lord Hastings were completed, when the peshwa suddenly broke into war, and the British were opposed at once to the Mahratta and Pindari powers, estimated at 200,000 men and 500 guns. Both were utterly shattered in a brief campaign of four months (1817-18). The peshwa's dominions were annexed, and those of Sindhia, Holkar, and the raja of Berar lay at the mercy of the governor-general, and were saved only by his moderation. Thus, after sixty years from the battle of Plassey, the supremacy of British power in India was effectively established. The Pindaris had ceased to exist, and peace and security had been substituted for misery and terror.

"It is a proud phrase to use," said Lord Hastings, "but it is a true one, that we have bestowed blessings upon millions. Nothing can be more delightful than the reports I receive of the sensibility manifested by the inhabitants to this change in their circumstances. The smallest detachment of our troops cannot pass through that district without meeting everywhere eager and exulting gratulations, the tone of which peaves them to come from glowing hearts. Multitudes of people have, even in this short interval, come from the hills and fastnesses in which they had sought refuge for years, and have recaptured their ancient deserted villages. The ploughshare is again in every quarter turning up a soil which had for many seasons never been stirred, except by the hoofs of predatory cavalry."

While the natives of India appreciated the results of Lord Hastings's achievements, the court of directors grumbled at his having extended British territory. They also disliked and opposed his measures for introducing education among the natives and his encouraging the freedom of the press. In 1819 he obtained the cession by purchase of the island of Singapore. In finance his administration was very successful, as notwithstanding the expenses of his wars he showed an annual surplus of two millions sterling. Brilliant and beneficent as his career had been, Lord Hastings did not escape unjust detraction. His last years of office were embittered by the discussions on a matter notorious at the time, namely, the affairs of the banking-house of W. Palmer and Company. The whole affair was mixed up with insinuations against Lord Hastings, especially charging him with having been actuated by favouritism towards one of the partners in the firm. From imputations which were inconsistent with his whole character he has subsequently been exonerated. But while smarting under them he tendered his resignation in 1821, though he did not leave India till the first day of 1823. He was much exhausted by the arduous labours which for more than nine years he had sustained. Among his characteristics it is mentioned that "his ample fortune absolutely sank under the benevolence of his nature"; and, far from having enriched himself in the appointment of governor-general, he returned to England in circumstances which obliged him still to seek public employment. In 1824 he received the comparatively small post of governor of Malta, in which island he introduced many reforms and endeared himself to the inhabitants. He died on the 28th of November 1826, leaving a request that his right hand should be cut off and preserved till the death of the marchioness of Hastings, and then be interred in her coffin.

Hastings was succeeded by his son, Francis George Augustus (1808-1844), who in 1840 succeeded through his mother to the earldom of Loudoun. When his second son, Henry Weysford, the 4th marquess, died childless on the 10th of November 1868 the marquessate became extinct; the earldom of Loudoun devolved upon his sister, Edith Mary (d. 1874), wife of Charles Frederick Abney-Hastings, afterwards Baron Donington; the

barony of Hastings, which fell into abeyance, was also revived in 1871 in her favour.

See Ross-of-Bladenburg, *The Marquess of Hastings* ("Rulers of India" series) (1893); and *Private Journal of the Marquess of Hastings*, edited by his daughter, the marchioness of Bute (1858).

HASTINGS, FRANK ABNEY (1794-1828), British naval officer and Philhellene, was the son of Lieut.-general Sir Charles Hastings, a natural son of Francis Hastings, tenth earl of Huntingdon. He entered the navy in 1805, and was in the "Neptune" (100) at the battle of Trafalgar; but in 1800 a quarrel with his flag captain led to his leaving the service. The revolutionary troubles of the time offered chances of foreign employment. Hastings spent a year on the continent to learn French, and sailed for Greece on the 12th of March 1822 from Marseilles. On the 3rd of April he reached Hydra. For two years he took part in the naval operations of the Greeks in the Gulf of Smyrna and elsewhere. He saw that the light squadrons of the Greeks must in the end be overpowered by the heavier Turkish navy, clumsy as it was; and in 1823 he drew up and presented to Lord Byron a very able memorandum which he laid before the Greek government in 1824. This paper is of peculiar interest apart from its importance in the Greek insurrection, for it contains the germs of the great revolution which has since been effected in naval gunnery and tactics. In substance the memorandum advocated the use of steamers in preference to sailing ships, and of direct fire with shells and hot shot, as a more trustworthy means of destroying the Turkish fleet than fire-ships. It will be found in Finlay's *History of the Greek Revolution*, vol. ii. appendix i. The application of Hastings's ideas led necessarily to the disuse of sailing ships, and the introduction of armour. The incompetence of the Greek government and the corrupt waste of its resources prevented the full application of Hastings's bold and far-seeing plans. But largely by the use of his own money, of which he is said to have spent £7000, he was able to some extent to carry them out. In 1824 he came to England to obtain a steamer, and in 1825 he had fitted out a small steamer named the "Karteria" (Perseverance), manned by Englishmen, Swedes and Greeks, and provided with apparatus for the discharge of shell and hot shot. He did enough to show that if his advice had been vigorously followed the Turks would have been driven off the sea long before the date of the battle of Navarino. The great effect produced by his shells in an attack on the sea-line of communication of the Turkish army, then besieging Athens at Oropus and Volo in March and April 1827, was a clear proof that much more could have been done. Military mismanagement caused the defeat of the Greeks round Athens. But Hastings, in co-operation with General Sir R. Church (*q.v.*), shifted the scene of the attack to western Greece. Here his destruction of a small Turkish squadron at Salona Bay in the Gulf of Corinth (29th of September 1827) provoked Ibrahim Pasha into the aggressive movements which led to the destruction of his fleet by the allies at Navarino (*q.v.*) on the 20th of October 1827. On the 25th of May 1828 he was wounded in an attack on Anatolikon, and he died in the harbour of Zante on the 1st of June. General Gordon, who served in the war and wrote its history, says of him: "If ever there was a disinterested and really useful Philhellene it was Hastings. He received no pay, and had expended most of his slender fortune in keeping the 'Karteria' afloat for the last six months. His ship, too, was the only one in the Greek navy where regular discipline was maintained."

See Thomas Gordon, *History of the Greek Revolution* (London, 1832); George Finlay, *History of the Greek Revolution* (Edinburgh, 1861).

HASTINGS, WARREN (1732-1818), the first governor-general of British India, was born on the 6th of December 1732 in the little hamlet of Churchill in Oxfordshire. He came of a family which had been settled for many generations in the adjoining village of Daylesford; but his great-grandfather had sold the ancestral manor-house, and his grandfather had been unable to maintain himself in possession of the family living. His mother died a few days after giving him birth; his father,

Pynaston Hastings, drifted away to perish obscurely in the West Indies. Thus unfortunate in his birth, young Hastings received the elements of education at a charity school in his native village. At the age of eight he was taken in charge by an elder brother of his father, Howard Hastings, who held a post in the customs. After spending two years at a private school at Newington Butts, he was moved to Westminster, where among his contemporaries occur the names of Lord Thurlow and Lord Shelburne, Sir Elijah Impey, and the poets Cowper and Churchill. In 1749, when his headmaster Dr Nichols was already anticipating for him a successful career at the university, his uncle died, leaving him to the care of a distant kinsman, Mr Creswicke, who was afterwards in the direction of the East India Company; and he determined to send his ward to seek his fortune as a "writer" in Bengal.

When Hastings landed at Calcutta in October 1750 the affairs of the East India Company were at a low ebb. Throughout the entire south of the peninsula French influence was predominant. The settlement of Fort St George or Madras, captured by force of arms, had only recently been restored in accordance with a clause of the peace of Aix-la-Chapelle. The organizing genius of Dupleix everywhere overshadowed the native imagination, and the star of Clive had scarcely yet risen above the horizon. The rivalry between the English and the French, which had already convulsed the south, did not penetrate to Bengal. That province was under the able government of Ali Vardi Khan, who peremptorily forbade the foreign settlers at Calcutta and Chandernagore to introduce feuds from Europe. The duties of a young "writer" were then such as are implied in the name. At an early date Hastings was placed in charge of an *awrang* or factory in the interior, where his duties would be to superintend the weaving of silk and cotton goods under a system of money advances. In 1753 he was transferred to Cossimbazar, the river-port of the native capital of Murshidabad. In 1756 the old nawab died, and was succeeded by his grandson Suraj-ud-Dowlah, a young madman of 19, whose name is indelibly associated with the tragedy of the Black Hole. When that passionate young prince, in revenge for a fancied wrong, resolved to drive the English out of Bengal, his first step was to occupy the fortified factory at Cossimbazar, and make prisoners of Hastings and his companions. Hastings was soon released at the intercession of the Dutch resident, and made use of his position at Murshidabad to open negotiations with the English fugitives at Falta, the site of a Dutch factory near the mouth of the Hugli. In later days he used to refer with pride to his services on this occasion, when he was first initiated into the wiles of Oriental diplomacy. After a while he found it necessary to fly from the Mahomedan court and join the main body of the English at Falta. When the relieving force arrived from Madras under Colonel Clive and Admiral Watson, Hastings enrolled himself as a volunteer, and took part in the action which led to the recovery of Calcutta. Clive showed his appreciation of Hastings's merits by appointing him in 1758 to the important post of resident at the court of Murshidabad. It was there that he first came into collision with the Bengali Brahman, Nuncomar, whose subsequent fate has supplied more material for controversy than any other episode in his career. During his three years of office as resident he was able to render not a few valuable services to the Company; but it is more important to observe that his name nowhere occurs in the official lists of those who derived pecuniary profit from the necessities and weakness of the native court. In 1761 he was promoted to be member of council, under the presidency of Mr Vansittart, who had been introduced by Clive from Madras. The period of Vansittart's government has been truly described as "the most revolting page of our Indian history." The entire duties of administration were suffered to remain in the hands of the nawab, while a few irresponsible English traders had drawn to themselves all real power. The members of council, the commanders of the troops, and the commercial residents plundered on a grand scale. The youngest servant of the Company claimed the right of trading on his own account, free from taxation and from local jurisdiction, not only for himself but also for every native subordinate whom he might permit

to use his name. It was this exemption, threatening the very foundations of the Mussulman government, that finally led to a rupture with the nawab. Macaulay, in his celebrated essay, has said that "of the conduct of Hastings at this time little is known." As a matter of fact, the book which Macaulay was professing to review describes at length the honourable part consistently taken by Hastings in opposition to the great majority of the council. Sometimes in conjunction only with Vansittart, sometimes absolutely alone, he protested unceasingly against the policy and practices of his colleagues. On one occasion he was stigmatized in a minute by Mr Batson with "having espoused the nawab's cause, and as a hired solicitor defended all his actions, however dishonourable and detrimental to the Company." An altercation ensued. Batson gave him the lie and struck him in the council chamber. When war was actually begun, Hastings officially recorded his previous resolution to have resigned, in order to repudiate responsibility for measures which he had always opposed. Waiting only for the decisive victory of Buzar over the allied forces of Bengal and Oudh, he resigned his seat and sailed for England in November 1764.

After fourteen years' residence in Bengal Hastings did not return home a rich man, estimated by the opportunities of his position. According to the custom of the time he had augmented his slender salary by private trade. At a later date he was charged by Burke with having taken up profitable contracts for supplying bullocks for the use of the Company's troops. It is admitted that he conducted by means of agents a large business in timber in the Gangetic Sundarbans. When at Falta he had married Mrs Buchanan, the widow of an officer. She bore him two children, of whom one died in infancy at Murshidabad, and was shortly followed to the grave by her mother. Their common gravestone is in existence at the present day, bearing date July 11, 1759. The other child, a son, was sent to England, and also died shortly before his father's return. While at home Hastings is said to have attached himself to literary society; and it may be inferred from his own letters that he now made the personal acquaintance of Samuel Johnson and Lord Mansfield. In 1766 he was called upon to give evidence before a committee of the House of Commons upon the affairs of Bengal. The good sense and clearness of the views which he expressed caused attention to be paid to his desire to be again employed in India. His pecuniary affairs were embarrassed, partly from the liberality with which he had endowed his few surviving relatives. The great influence of Lord Clive was also exercised on his behalf. At last, in the winter of 1768, he received the appointment of second in council at Madras. Among his companions on his voyage round the Cape were the Baron Imhoff, a speculative portrait-painter, and his wife, a lady of some personal attractions and great social charm, who was destined henceforth to be Hastings's lifelong companion. Of his two years' work at Madras it is needless to speak in detail. He won the good-will of his employers by devoting himself to the improvement of their manufacturing business, and he kept his hands clean from the prevalent taint of pecuniary transactions with the nawab of the Carnatic. One fact of some interest is not generally known. He drew up a scheme for the construction of a pier at Madras, to avoid the dangers of landing through the surf, and instructed his brother-in-law in England to obtain estimates from the engineers Brindley and Smeaton.

In the beginning of 1772 his ambition was stimulated by the nomination to the second place in council in Bengal with a promise of the reversion of the governorship when Mr Cartier should retire. Since his departure from Bengal in 1764 the situation of affairs in that settlement had scarcely improved. The second governorship of Clive was marked by the transfer of the *divans* or financial administration from the Mogul emperor to the Company, and by the enforcement of stringent regulations against the besetting sin of peculation. But Clive was followed by two inefficient successors; and in 1770 occurred the most terrible Indian famine on record, which is credibly estimated to have swept away one-third of the population. In April 1772 Warren Hastings took his seat as president of the council at Fort

William. His first care was to carry out the instructions received from home, and effect a radical reform in the system of government. Clive's plan of governing through the agency of the native court had proved a failure. The directors were determined "to stand forth as *divans*, and take upon themselves by their own servants the entire management of the revenues." All the officers of administration were transferred from Murshidabad to Calcutta, which Hastings boasted at this early date that he would make the first city in Asia. This reform involved the ruin of many native reputations, and for a second time brought Hastings into collision with the wily Brahman, Nuncomar. At the same time a settlement of the land revenue on leases for five years was begun, and the police and military systems of the country were placed upon a new footing. Hastings was a man of immense industry, with an insatiable appetite for detail. The whole of this large series of reforms was conducted under his own personal supervision, and upon no part of his multifarious labours did he dwell in his letters home with greater pride. As an independent measure of economy, the stipend paid to the titular nawab of Bengal, who was then a minor, was reduced by one-half—to sixteen *lakhs* a year (say £160,000). Macaulay imputes this reduction to Hastings as a characteristic act of financial immorality; but in truth it had been expressly enjoined by the court of directors, in a despatch dated six months before he took up office. His pecuniary bargains with Shuja-ud-Dowlah, the nawab wazir of Oudh, stand on a different basis. Hastings himself always regarded them as incidents in his general scheme of foreign policy. The Mahrattas at this time had got possession of the person of the Mogul emperor, Shah Alam, from whom Clive obtained the grant of Bengal in 1765, and to whom he assigned in return the districts of Allahabad and Kora and a tribute of £300,000. With the emperor in their camp, the Mahrattas were threatening the province of Oudh, and causing a large British force to be cantoned along the frontier for its defence. Warren Hastings, as a deliberate measure of policy, withheld the tribute due to the emperor, and resold Allahabad and Kora to the wazir of Oudh. The Mahrattas retreated, and all danger for the time was dissipated by the death of their principal leader. The wazir now bethought him that he had a good opportunity for satisfying an old quarrel against the adjoining tribe of Rohillas, who had played fast and loose with him while the Mahratta army was at hand. The Rohillas were a race of Afghan origin, who had established themselves for some generations in a fertile tract west of Oudh, between the Himalayas and the Ganges, which still bears the name of Rohilkhand. They were not so much the occupiers of the soil as a dominant caste of warriors and freebooters. But in those troubled days their title was as good as any to be found in India. After not a little hesitation, Hastings consented to allow the Company's troops to be used to further the ambitious designs of his Oudh ally, in consideration of a sum of money which relieved the ever-pressing wants of the Bengal treasury. The Rohillas were defeated in fair fight. Some of them fled the country, and so far as possible Hastings obtained terms for those who remained. The fighting, no doubt, on the part of the wazir was conducted with all the savagery of Oriental warfare; but there is no evidence that it was a war of extermination.

Meanwhile, the affairs of the East India Company had come under the consideration of parliament. The Regulating Act, passed by Lord North's ministry in 1773, effected considerable changes in the constitution of the Bengal government. The council was reduced to four members with a governor-general, who were to exercise certain indefinite powers of control over the presidencies of Madras and Bombay. Hastings was named in the act as governor-general for a term of five years. The council consisted of General Clavering and the Hon. Colonel Monson, two third-rate politicians of considerable parliamentary influence; Philip Francis (*q.v.*), then only known as an able permanent official; and Barwell, of the Bengal Civil Service. At the same time a supreme court of judicature was appointed, composed of a chief and three puisne judges, to exercise an indeterminate jurisdiction at Calcutta. The chief-justice was Sir Elijah Impey,

already mentioned as a schoolfellow of Hastings at Westminster. The whole tendency of the Regulating Act was to establish for the first time the influence of the crown, or rather of parliament, in Indian affairs. The new members of council disembarked at Calcutta on the 10th of October 1774; and on the following day commenced the long feud which scarcely terminated twenty-one years later with the acquittal of Warren Hastings by the House of Lords. Macaulay states that the members of council were put in ill-humour because their salute of guns was not proportionate to their dignity. In a contemporary letter Francis thus expresses the same petty feeling: "Surely Mr H. might have put on a ruffled shirt." Taking advantage of an ambiguous clause in their commission, the majority of the council (for Barwell uniformly sided with Hastings) forthwith proceeded to pass in review the recent measures of the governor-general. All that he had done they condemned; all that they could they reversed. Hastings was reduced to the position of a cipher at their meetings. After a time they lent a ready ear to detailed allegations of corruption brought against him by his old enemy Nuncomar. To charges from such a source, and brought in such a manner, Hastings disdained to reply, and referred his accuser to the supreme court. The majority of the council, in their executive capacity, resolved that the governor-general had been guilty of peculation, and ordered him to refund. A few days later Nuncomar was thrown into prison on a charge of forgery preferred by a private prosecutor, tried before the supreme court sitting in bar, found guilty by a jury of Englishmen and sentenced to be hanged. Hastings always maintained that he did not cause the charge to be instituted, and the legality of Nuncomar's trial is thoroughly proved by Sir James Stephen. The majority of the council abandoned their supporter, who was executed in due course. He had forwarded a petition for reprieve to the council, which Clavering took care should not be presented in time, and which was subsequently burnt by the common hangman on the motion of Francis. While the strife was at its hottest, Hastings had sent an agent to England with a general authority to place his resignation in the hands of the Company under certain conditions. The agent thought fit to exercise that authority. The resignation was promptly accepted, and one of the directors was appointed to the vacancy. But in the meantime Colonel Monson had died, and Hastings was thus restored, by virtue of his casting vote, to the supreme management of affairs. He refused to ratify his resignation; and when Clavering attempted to seize on the governor-generalship, he judiciously obtained an opinion from the judges of the supreme court in his favour. From that time forth, though he could not always command an absolute majority in council, Hastings was never again subjected to gross insult, and his general policy was able to prevail.

A crisis was now approaching in foreign affairs which demanded all the experience and all the genius of Hastings for its solution. Bengal was prosperous, and free from external enemies on every quarter. But the government of Bombay had hurried on a rupture with the Mahratta confederacy at a time when France was on the point of declaring war against England, and when the mother-country found herself unable to subdue her rebellious colonists in America. Hastings did not hesitate to take upon his own shoulders the whole responsibility of military affairs. All the French settlements in India were promptly occupied. On the part of Bombay, the Mahratta war was conducted with procrastination and disgrace. But Hastings amply avenged the capitulation of Wargoon by the complete success of his own plan of operations. Colonel Goddard with a Bengal army marched across the breadth of the peninsula from the valley of the Ganges to the western sea, and achieved almost without a blow the conquest of Gujerat. Captain Popham, with a small detachment, stormed the rock fortress of Gwalior, then deemed impregnable and the key of central India; and by this feat held in check Sindria, the most formidable of the Mahratta chiefs. The Bhonsta Mahratta raja of Nagpur, whose dominions bordered on Bengal, was won over by the diplomacy of an emissary of Hastings. But while these events were taking place,

a new source of embarrassment had arisen at Calcutta. The supreme court, whether rightly or wrongly, assumed a jurisdiction of first instance over the entire province of Bengal. The English common law, with all the absurdities and rigours of that day, was arbitrarily extended to an alien system of society. *Zambudars*, or government renters, were arrested on mesne process; the sanctity of the *zenana*, or women's chamber, as dear to Hindus as to Mahomedans, was violated by the sheriff's officer; the deepest feelings of the people and the entire fabric of revenue administration were alike disregarded. On this point the entire council acted in harmony. Hastings and Francis went joint-bail for imprisoned natives of distinction. At last, after the dispute between the judges and the executive threatened to become a trial of armed force, Hastings set it at rest by a characteristic stroke of policy. A new judicial office was created in the name of the Company, to which Sir Elijah Impey was appointed, though he never consented to draw the additional salary offered to him. The understanding between Hastings and Francis, originating in this state of affairs, was for a short period extended to general policy. An agreement was come to by which Francis received patronage for his circle of friends, while Hastings was to be unimpeded in the control of foreign affairs. But a difference of interpretation arose. Hastings recorded in an official minute that he had found Francis's private and public conduct to be "void of truth and honour." They met as duellists. Francis fell wounded, and soon afterwards returned to England.

The Mahratta war was not yet terminated, but a far more formidable danger now threatened the English in India. The imprudent conduct of the Madras authorities had irritated beyond endurance the two greatest Mussulman powers in the peninsula, the nizam of the Deccan and Hyder Ali, the usurper of Mysore, who began to negotiate an alliance with the Mahrattas. A second time the genius of Hastings saved the British empire in the east. On the arrival of the news that Hyder had descended from the highlands of Mysore, cut to pieces the only British army in the field, and swept the Carnatic up to the gates of Madras, he at once adopted a policy of extraordinary boldness. He signed a blank treaty of peace with the Mahrattas, who were still in arms, reversed the action of the Madras government towards the nizam, and concentrated all the resources of Bengal against Hyder Ali. Sir Eyre Coote, a general of renown in former Carnatic wars, was sent by sea to Madras with all the troops and treasure that could be got together; and a strong body of reinforcements subsequently marched southwards under Colonel Pearse along the coast line of Orissa. The landing of Coote preserved Madras from destruction, though the war lasted through many campaigns and only terminated with the death of Hyder. Pearse's detachment was decimated by an epidemic of cholera (perhaps the first mention of this disease by name in Indian history); but the survivors penetrated to Madras, and not only held in check Bbonsla and the nizam, but also corroborated the lesson taught by Goddard—that the Company's sepoys could march anywhere, when boldly led. Hastings's personal task was to provide the ways and means for this exhausting war. A considerable economy was effected by a reform in the establishment for collecting the land tax. The government monopolies of opium and salt were then for the first time placed upon a remunerative basis. But these reforms were of necessity slow in their beneficial operation. The pressing demands of the military chest had to be satisfied by loans, and in at least one case from the private purse of the governor-general. Ready cash could alone fill up the void; and it was to the hoards of native princes that Hastings's fertile mind at once turned. Chait Sing, raja of Benares, the greatest of the vassal chiefs who had grown rich under the protection of the British rule, lay under the suspicion of disloyalty. The wazir of Oudh had fallen into arrears in the payment due for the maintenance of the Company's garrison posted in his dominions, and his administration was in great disorder. In his case the ancestral hoards were under the control of his mother, the begum of Oudh, into whose hands they had been allowed to pass at the time when Hastings

was powerless in council. Hastings resolved to make a progress up country in order to arrange the affairs of both provinces, and bring back all the treasure that could be squeezed out of its holders by his personal intervention. When he reached Benares and presented his demands, the raja rose in insurrection, and the governor-general barely escaped with his life. But the faithful Popham rapidly rallied a force for his defence. The insurgents were defeated again and again; Chait Sing took to flight, and an augmented permanent tribute was imposed upon his successor. The Oudh business was managed with less risk. The wazir consented to everything demanded of him. The begum was charged with having abetted Chait Sing in his rebellion; and after the severest pressure applied to herself and her attendant eunuchs, a fine of more than a million sterling was exacted from her. Hastings appears to have been not altogether satisfied with the incidents of this expedition, and to have anticipated the censure which it received in England. As a measure of precaution, he procured documentary evidence of the rebellious intentions of the raja and the begum, to the validity of which Impey obligingly lent his extra-judicial sanction.

The remainder of Hastings's term of office in India was passed in comparative tranquillity, both from internal opposition and foreign war. The centre of interest now shifts to the India House and to the British parliament. The long struggle between the Company and the ministers of the crown for the supreme control of Indian affairs and the attendant patronage had reached its climax. The decisive success of Hastings's administration alone postponed the inevitable solution. His original term of five years would have expired in 1778; but it was annually prolonged by special act of parliament until his voluntary resignation. Though Hastings was thus irremovable, his policy did not escape censure. Ministers were naturally anxious to obtain the reversion to his vacant post, and Indian affairs formed at this time the hinge on which party politics turned. On one occasion Dundas carried a motion in the House of Commons, censuring Hastings and demanding his recall. The directors of the Company were disposed to act upon this resolution; but in the court of proprietors, with whom the decision ultimately lay, Hastings always possessed a sufficient majority. Fox's India Bill led to the downfall of the Coalition ministry in 1783. The act which Pitt successfully carried in the following year introduced a new constitution, in which Hastings felt that he had no place. In February 1785 he finally sailed from Calcutta, after a dignified ceremony of resignation, and amid enthusiastic farewells from all classes.

On his arrival in England, after a second absence of sixteen years, he was not displeased with the reception he met with at court and in the country. A peerage was openly talked of as his due, while his own ambition pointed to some responsible office at home. Pitt had never taken a side against him, while Lord Chancellor Thurlow was his pronounced friend. But he was now destined to learn that his enemy Francis, whom he had discomfited in the council chamber at Calcutta, was more than his match in the parliamentary arena. Edmund Burke had taken the subject races of India under the protection of his eloquence. Francis, who had been the early friend of Burke, supplied him with the personal animus against Hastings, and with the knowledge of detail, which he might otherwise have lacked. The Whig party on this occasion unanimously followed Burke's lead. Dundas, Pitt's favourite subordinate, had already committed himself by his earlier resolution of censure; and Pitt was induced by motives which are still obscure to incline the ministerial majority to the same side. To meet the oratory of Burke and Sheridan and Fox, Hastings wrote an elaborate minute with which he wearied the ears of the House for two successive nights, and he subsidized a swarm of pamphleteers. The impeachment was decided upon in 1786, but the actual trial did not commence until 1788. For seven long years Hastings was upon his defence on the charge of "high crimes and misdemeanours." During this anxious period he appears to have borne himself with characteristic dignity, such as is consistent with no other hypothesis than the consciousness of innocence. At last, in 1795, the House

of Lords gave a verdict of not guilty on all charges laid against him; and he left the bar at which he had so frequently appeared, with his reputation clear, but ruined in fortune. However large the wealth he brought back from India, all was swallowed up in defraying the expenses of his trial. Continuing the line of conduct which in most other men would be called hypocrisy, he forwarded a petition to Pitt praying that he might be reimbursed his costs from the public funds. This petition, of course, was rejected. At last, when he was reduced to actual destitution, it was arranged that the East India Company should grant him an annuity of £4000 for a term of years, with £90,000 paid down in advance. This annuity expired before his death; and he was compelled to make more than one fresh appeal to the bounty of the Company, which was never withheld. Shortly before his acquittal he had been able to satisfy the dream of his childhood, by buying back the ancestral manor of Daylesford, where the remainder of his life was passed in honourable retirement. In 1813 he was called on to give evidence upon Indian affairs before the two houses of parliament, which received him with exceptional marks of respect. The university of Oxford conferred on him the honorary degree of D.C.L.; and in the following year he was sworn of the privy council, and took a prominent part in the reception given to the duke of Wellington and the allied sovereigns. He died on the 22nd of August 1818, in his 86th year, and lies buried behind the chancel of the parish church, which he had recently restored at his own charges.

In physical appearance, Hastings "looked like a great man, and not like a bad man." The body was wholly subjugated to the mind. A frame naturally slight had been further attenuated by rigorous habits of temperance, and thus rendered proof against the diseases of the tropics. Against his private character not even calumny has breathed a reproach: As brother, as husband and as friend, his affections were as steadfast as they were warm. By the public he was always regarded as reserved, but within his own inner circle he gave and received perfect confidence. In his dealings with money, he was characterized rather by liberality of expenditure than by carefulness of acquisition. A classical education and the instincts of family pride saved him from both the greed and the vulgar display which marked the typical "nabob," the self-made man of those days. He could support the position of a governor-general and of a country gentleman with equal credit. Concerning his second marriage, it suffices to say that the Baroness Imhoff was nearly forty years of age, with a family of grown-up children, when the complaisant law of her native land allowed her to become Mrs Hastings. She survived her husband, who cherished towards her to the last the sentiments of a lover. Her children he adopted as his own; and it was chiefly for her sake that he desired the peerage which was twice held out to him.

Hastings's public career will probably never cease to be a subject of controversy. It was his misfortune to be the scapegoat upon whose head parliament laid the accumulated sins, real and imaginary, of the East India Company. If the acquisition of the Indian empire can be supported on ethical grounds, Hastings needs no defence. No one who reads his private correspondence will admit that even his least defensible acts were dictated by dishonourable motives. It is more pleasing to point out certain of his public measures upon which no difference of opinion can arise. He was the first to attempt to open a trade route with Tibet, and to organize a survey of Bengal and of the eastern seas. It was he who persuaded the *pandits* of Bengal to disclose the treasures of Sanskrit to European scholars. He founded the Madras college for Mahomedan education at Calcutta, primarily out of his own funds; and he projected the foundation of an Indian institute in England. The Bengal Asiatic Society was established under his auspices, though he yielded the post of president to Sir W. Jones. No Englishman ever understood the native character so well as Hastings; none ever devoted himself more heartily to the promotion of every scheme, great and small, that could advance the prosperity of India. Natives and Anglo-Indians alike venerate his name, the former as their first beneficent administrator, the latter as the

most able and the most enlightened of their own class. If Clive's sword conquered the Indian empire, it was the brain of Hastings that planned the system of civil administration, and his genius that saved the empire in its darkest hour.

See G. B. Malleson, *Life of Warren Hastings* (1894); G. W. Forrest, *The Administration of Warren Hastings* (Calcutta, 1892); Sir Charles Lawson, *The Private Life of Warren Hastings* (1895); L. J. Trotter, *Warren Hastings* ("Rulers of India" series) (1890); Sir Alfred Lyall, *Warren Hastings* ("English Men of Action" series) (1889); F. M. Holmes, *Four Heroes of India* (1892); G. W. Hastings, *A Vindication of Warren Hastings* (1909). Macaulay's famous essay, though a classic, is very partial and inaccurate; and Burke's speech, on the impeachment of Warren Hastings, is magnificent rhetoric. The true historical view has been restored by Sir James Stephen's *Story of Nuncomar* (1885) and by Sir John Strachey's *Hastings and the Rohilla War* (1892), and it is enforced in some detail in Sydney C. Grier's *Letters of Warren Hastings to his Wife* (1905), material for which existed in a mass of documents relating to Hastings, acquired by the British Museum. (J. S. Co.)

HASTINGS, a municipal, county and parliamentary borough and watering-place of Sussex, England, one of the Cinque Ports, 62 m. S.E. by S. from London, on the South Eastern & Chatham and the London, Brighton & South Coast railways. Pop. (1901), 65,528. It is picturesquely situated at the mouth of two narrow valleys, and, being sheltered by considerable hills on the north and east, has an especially mild climate. Eastward along the coast towards Fairlight, and inland, the country is beautiful. A parade fronts the English Channel, and connects the town on the west with St Leonard's, which is included within the borough. This is mainly a residential quarter, and has four railway stations on the lines serving Hastings. Both Hastings and St Leonard's have fine piers; there is a covered parade known as the Marina, and the Alexandra Park of 75 acres was opened in 1891. There are also numerous public gardens. The sandy beach is extensive, and affords excellent bathing. On the brink of the West Cliff stand a square and a circular tower and other fragments of the castle, probably erected soon after the time of William the Conqueror; together with the ruins, opened up by excavation in 1824, of the castle chapel, a transitional Norman structure 110 ft. long, with a nave, chancel and aisles. Besides the chapel there was formerly a college, both being under the control of a dean and secular canons. The deanery was held by Thomas Becket, and one of the canonries by William of Wykeham. The principal public buildings are the old parish churches of All Saints and St Clements, the first containing in its register for 1619 the baptism of Titus Oates, whose father was rector of the parish; numerous modern churches, the town hall (1880); theatre, music hall and assembly rooms. The Brassey Institute contains a public library, museum and art school. The Albert Memorial clock-tower was erected in 1864. Educational institutions include the grammar school (1883), school of science and art (1878) and technical schools. At the west end of the town are several hospitals and convalescent homes. The prosperity of the town depends almost wholly on its reputation as a watering-place, but there is a small fishing and boat-building industry. In 1890 an act of parliament authorized the construction of a harbour, but the work, begun in 1896, was not completed. The fish-market beneath the castle cliff is picturesque. The parliamentary borough, returning one member, falls within the Rye division of the county. The county borough was created in 1888. The municipal borough is under a mayor, 10 aldermen and 30 councillors. Area, 4857 acres.

Rock shelters on Castle Hill and numerous flint instruments which have been discovered at Hastings point to an extensive neolithic population, and there are ancient earthworks and a promontory camp of unknown date. There is no evidence that Hastings was a Roman settlement, but it was a place of some note in the Anglo-Saxon period. In 705 land at Hastings (Haestingaceaster, Haestingas, Haestingaport) is included in a grant, which may possibly be a forgery, of a South Saxon chieftain to the abbey of St Denis in France; and a royal mint was established at the town by Æthelstan. The battle of Hastings in 1066 described below was the first and decisive act of the Norman Conquest. It was fought near the present Battle Abbey,

about 6 m. inland. After the Conquest William I. erected the earthworks of the existing castle. By 1086 Hastings was a borough and had given its name to the rape of Sussex in which it lay. The town at that time had a harbour and a market. Whether Hastings was one of the towns afterwards known as the Cinque Ports at the time when they received their first charter from Edward the Confessor is uncertain, but in the reign of William I. it was undoubtedly among them. These combined towns, of which Hastings was the head, had special liberties and a separate jurisdiction under a warden. The only charter peculiar to Hastings was granted in 1589 by Elizabeth, and incorporated the borough under the name of "mayor, jurats and commonalty," instead of the former title of "bailiff, jurats and commonalty." Hastings returned two members to parliament probably from 1322, and certainly from 1366, until 1885, when the number was reduced to one.

Battle of Hastings.—On the 28th of September 1066, William of Normandy, bent on asserting by arms his right to the English crown, landed at Pevensey. King Harold, who had destroyed the invaders of northern England at the battle of Stamford Bridge in Yorkshire, on hearing the news hurried southward, gathering what forces he could on the way. He took up his position, athwart the road from Hastings to London, on a hill¹ some 6 m. inland from Hastings, with his back to the great forest of Anderida (the Weald) and in front of him a long glacial-like slope, at the bottom of which began the opposing slope of Telham Hill. The English army was composed almost entirely of infantry. The shire levies, for the most part destitute of body armour and with miscellaneous and even improvised weapons, were arranged on either flank of Harold's guards (*huscarles*), picked men armed principally with the Danish axe and shield.

Before this position Duke William appeared on the morning of the 14th of October. His host, composed not only of his Norman vassals but of barons, knights and adventurers from all quarters, was arranged in a centre and two wings, each corps having its archers and arblasters in the front line, the rest of the infantry in the second and the heavy armoured cavalry in the third. Neither the arrows nor the charge of the second line of foot-men, who, unlike the English, wore defensive mail, made any impression on the English standing in a serried mass behind their interlocked shields.²

Then the heavy cavalry came on, led by the duke and his brother Odo, and encouraged by the example of the minstrel Taillefer, who rode forward, tossing and catching his sword, into the midst of the English line before he was pulled down and killed. All along the front the cavalry came to close quarters with the defenders, but the long powerful Danish axes were

¹ Freeman called this hill Senlac and introduced the fashion of describing the battle as "the battle of Senlac." Mr J. H. Round, however, proved conclusively that this name, being French (Senlecque), could not have been in use at the time of the Conquest, that the battlefield had in fact no name, pointing out that in William of Malmesbury and in Domesday Book the battle is called "of Hastings" (*Bellum Hastingsense*), while only one writer, Ordericus Vitalis, describes it two hundred years after the event as *Bellum Senlacium*. See Round, *Feudal England* (London, 1895), p. 333 et seq.

² There is still a difference of opinion as to whether the English were, or were not, defended by any other rampart than that of the customary "shield-wall." Freeman, apparently as a result of a misunderstanding of a passage in Henry of Huntingdon and the slightly ambiguous verse of Wace in the *Roman du Rou* (ll. 6991-6994 and ll. 7815-7826), affirms that Harold turned "the battle as far as possible into the likeness of a siege," by building round his troops a "palisade" of solid timber (*Norman Conquest*, iii. 444). This was proved to be a fable by J. H. Round, in the course of a general attack on Freeman's historical method, which provoked the professor's defenders to take up the cudgels on his behalf in a very long and lively controversy. The result of this was that Freeman's account was wholly discredited, though Round's view—that there was no wall of any kind save the shield-wall—is not generally accepted. Professor Oman (*Academy*, June 9, 1894), for instance, holds that there was "an *abatis* of some sort" set to hamper the advance of cavalry (see also ENGLISH HISTORY, vol. ix, p. 474). Mr Round sums up the controversy, from his point of view, in his *Feudal England*, p. 340 et seq., where references to other monographs on the subject will be found.

as formidable as the halbert and the bill proved to be in battles of later centuries, and they lopped off the arms of the assailants and cut down their horses. The fire of the attack died out and the left wing (Bretons) fled in rout. But as the *fyrd* levies broke out of the line and pursued the Bretons down the hill in a wild, formless mob, William's cavalry swung round and destroyed them, and this suggested to the duke to repeat deliberately what the Bretons had done from fear. Another advance, followed by a feigned retreat, drew down a second large body of the English from the crest, and these in turn, once in the open, were ridden over and slaughtered by the men-at-arms. Lastly, these two disasters having weakened the defenders both materially and morally, William subjected the *huscarles*, who had stood fast when the *fyrd* broke its ranks, to a constant rain of arrows, varied from time to time by cavalry charges. These magnificent soldiers endured the trial for many hours, from noon till close on nightfall; but at last, when the Norman archers raised their bows so as to pitch the arrows at a steep angle of descent in the midst of the *huscarles*, the strain became too great. While some rusbed forward alone or in twos and threes to die in the midst of the enemy, the remainder stood fast, too closely crowded almost for the wounded to drop. At last Harold received a mortal wound, the English began to waver, and the knights forced their way in. Only a remnant of the defenders made its way back to the forest; and William, after resting for a night on the hardy-won ground, began the work of the Norman Conquest.

HASTINGS, a city and the county-seat of Adams county, Nebraska, U.S.A., about 95 m. W. by S. of Lincoln. Pop. (1890) 13,584; (1900) 7188 (1253 foreign-born); (1910) 9338. Hastings is served by the Chicago, Burlington & Quincy, the Chicago & North-western, the Missouri Pacific and the St Joseph & Grand Island railways. It is the seat of Hastings College (Presbyterian, coeducational), opened in 1882, and having 286 students in 1908, and of the state asylum for the chronic insane. The city carries on a considerable jobbing business for the farming region of which it is the centre and produce market. There are a large foundry and several large brickyards here. Hastings was settled in 1872, was incorporated in 1874 and was chartered as a city in the same year.

HAT, a covering for the head worn by both sexes, and distinguished from the cap or bonnet by the possession of a brim. The word in O.E. is *hæt*, which is cognate with O. Frisian *hatt*, O.N. *hote*, &c., meaning head-covering, hood; it is distantly related to the O.E. *hod*, hood, which is cognate with the German for "hat," *Hut*. The history of the hat as part of the apparel of both sexes, with the various changes in shape which it has undergone, is treated in the article **COSTUME**.

Hats were originally made by the process of felting, and as tradition ascribed the discovery of that very ancient operation to St Clement, he was assumed as the patron saint of the craft. At the present day the trade is divided into two distinct classes. The first and most ancient is concerned with the manufacture of felt hats, and the second has to do with the recent but now most extensive and important manufacture of silk or dress hats. In addition to these there is the important manufacture of straw or plaited hats (see **STRAW** and **STRAW MANUFACTURES**); and hats are occasionally manufactured of materials and by processes not included under any of these heads, but such manufactures do not take a large or permanent position in the industry.

Felt Hats.—There is a great range in the quality of felt hats: the finer and more expensive qualities are made entirely of fur; for commoner qualities a mixture of fur and wool is used; and for the cheapest kinds wool alone is employed. The processes and apparatus necessary for making hats of fur differ also from those required in the case of woollen bodies; and in large manufactories machinery is now generally employed for operations which at no distant date were entirely manual. An outline of the operations by which the old beaver hat was made will give an idea of the manual processes in making a fur napped hat, and the apparatus and mechanical processes employed in making ordinary hard and soft felts will afterwards be noticed.

Hatters' fur consists principally of the hair of rabbits (technically called coneys) and hares, with some proportion of nutria, musquash and beavers hair; and generally any pariags and cuttings from

furriers are also used. Furs intended for felting are deprived of their long coarse hairs, after which they are treated with a solution of nitrate of mercury, an operation called *carrotting* or *secrelage*, whereby the felting properties of the fur are greatly increased. The fur is then cut by hand or machine from the skin, and in this state it is delivered to the hat maker.

The old process of making a beaver hat was as follows. The materials of a proper beaver consisted, for the body or foundation, of rabbits' fur, and for the nap, of beaver fur, although the beaver was often mixed with or supplanted by a more common fur. In preparing the fur plate, the hatter weighed out a sufficient quantity of rabbit fur for a single hat, and spread it out and combined it by the operation of bowing. The bow or stang ABC (fig. 1) was about

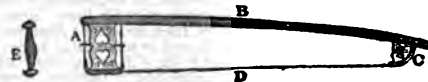

FIG. 1.

7 ft. long, and it stretched a single cord of catgut D, which the workman vibrated by means of a wooden pin E, furnished with a half knob at each end. Holding the bow in his left hand, and the pin in his right, he caused the vibrating string to come in contact with the heap of tangled fur, which did not cover a space greater than that of the hand. At each vibration some of the filaments started up to the height of a few inches, and fell away from the mass, a little to the right of the bow, their excursions being restrained by a concave frame of wicker work called the basket. One half of the material was first operated on, and by bowing and gathering, or a patting use of the basket, the stuff was loosely matted into a triangular figure, about 50 by 36 in., called a bat. In this formation care was taken to work about two-thirds of the fur down towards what was intended for the brim, and this having been effected, greater density was induced by gentle pressure with the basket. It was then covered with a wetish linen cloth, upon which was laid the hardening skin, a piece of dry half-tanned horse hide. On this the workman pressed until the stuff adhered closely to the damp cloth, in which it was then doubled up, freely pressed with the hand, and laid aside. By this process, called *basoning*, the bat became compactly felted and thinned toward the sides and point. The other half of the fur was next subjected to precisely the same processes, after which a cone-shaped slip of stiff paper was laid on its surface, and the sides of the bat were folded over its edges to its form and size. It was then laid paper-side downward upon the first bat, which was now replaced on the hurdle, and its edges were transversely doubled over the introverted side-lays of the second bat, thus giving equal thickness to the whole body. In this condition it was reintroduced between folds of damp linen cloth, and again hardened, so as to unite the two halves, the knitting together of which was quickly effected. The paper was then withdrawn, and the body in the form of a large cone removed to the plank or battery room.

The battery consisted of an open iron boiler or kettle A (fig. 2), filled with scalding hot water, with shelves, B, C, partly of mahogany

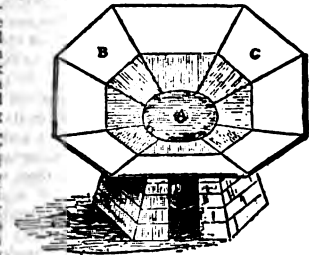

FIG. 2.

and partly of lead, sloping down to it. Here the body was first dipped in the water, and then withdrawn to the plank to cool and drain, when it was unfolded, rolled gently with a pin tapering towards the ends, turned, and worked in every direction, to toughen and shrink it, and at the same time prevent adhesion of its sides. Stopping or thickening any thin spots seen on looking through the body, was carefully performed by dabbing on additional stuff in succes-

sive supplies from the hot liquor with a brush frequently dipped into the kettle, until the body was shrunk sufficiently (about one-half) and thoroughly equalized. When quite dried, stiffening was effected with a brush dipped into a thin varnish of shellac, and rubbed into the body; the surface intended for the inside having much more laid on it than the outer, while the brim was made to absorb many times the quantity applied to any other part.

On being again dried, the body was ready to be covered with a nap of beaver hair. For this, in inferior qualities, the hair of the otter, nutria or other fine fur was sometimes substituted. The requisite quantity of one or other of these was taken and mixed with a proportion of cotton, and the whole was bowed up into a thin uniform lap. The cotton merely served to give sufficient body to the material to enable the workman to handle the lap. The body of the hat

being damped, the workman spread over it a covering of this lap, and by moistening and gentle patting with a brush the cut ends of the hair penetrated and fixed themselves in the felt body. The hat was then put into a coarse hair cloth, dipped and rolled in the hot liquor until the fur was quite worked in, the cotton being left on the surface loose and ready for removal. The blocking, dyeing and finishing processes in the case of beaver hats were similar to those employed for ordinary felts, except that greater care and dexterity were required on the part of the workmen, and further that the coarse hairs or kemps which might be in the fur were cut off by shaving the surface with a razor. The nap also had to be laid in one direction, smoothed and rendered glossy by repeated wettings, ironings and brushings. A hat so finished was very durable and much more light, cool and easy-fitting to the head than the silk hat which has now so largely superseded it.

The first efficient machinery for making felt hats was devised in America, and from the United States the machine-making processes were introduced into England about the year 1858; and now in all large establishments machinery such as that alluded to below is employed. For the forming of hat bodies two kinds of machine are used, according as the material employed is fur or wool. In the case of fur, the essential portion of the apparatus is a "former," consisting of a metal cone of the size and form of the body or hat to be made, perforated all over with small holes. The cone is made to revolve on its axis slowly over an orifice under which there is a powerful fan, which maintains a strong inward draught of air through the holes in the cone. At the side of the cone, and with an opening towards it, is a trunk or box from which the fur to be made into a hat is thrown out by the rapid revolution of a brush-like cylinder, and as the cloud of separate hairs is expelled from the trunk, the current of air being sucked through the cone carries the fibres to it and causes them to cling closely to its surface. Thus a coating of loose fibres is accumulated on the copper cone, and these are kept in position only by the exhaust at work under it. When sufficient for a hat body has been deposited, it is damped and a cloth is wrapped round it; then an outer cone is slipped over it and the whole is removed for felting, while another copper cone is placed in position for continuing the work. The fur is next felted by being rolled and pressed, these operations being performed partly by hand and partly by machine.

In the case of wool hats the hat or body is prepared by first carding in a modified form of carding machine. The wool is divided into two separate slivers as delivered from the cards, and these are wound simultaneously on a double conical block of wood mounted and geared to revolve slowly with a reciprocating horizontal motion, so that there is a continual crossing and recrossing of the wool as the sliver is wound around the cone. This diagonal arrangement of the sliver is an essential feature in the apparatus, as thereby the strength of the finished felt is made equal in every direction; and when strained in the blocking the texture yields in a uniform manner without rupture. The wool wound on the double block forms the material of two hats, which are separated by cutting around the median or base line, and slipping each half off at its own end. Into each cone of wool or bat an "inlayer" is now placed to prevent the inside from matting, after which they are folded in cloths, and placed over a perforated iron plate through which steam is blown. When well moistened and heated, they are placed between boards, and subjected to a rubbing action sufficient to harden them for bearing the subsequent strong planking or felting operations. The planking of wool hats is generally done by machine, in some cases a form of fulling mill being used; but in all forms the agencies are heat, moisture, pressure, rubbing and turning.

When by thorough felting the hat bodies of any kind have been reduced to dense leathery cones about one-half the size of the original bat, they are dried, and, if hard felts are to be made, the bodies are at this stage hardened or stiffened with a varnish of shellac. Next follows the operations of blocking, in which the felt for the first time assumes approximately the form it is ultimately to possess. For this purpose the conical body is softened in boiling water, and forcibly drawn over and over a hat-shaped wooden block. The operation of dyeing next follows, and the finishing processes include shaping on a block, over which crown and brim receive ultimately their accurate form, and pouncing or pumicing, which consists of smoothing the surface with fine emery paper, the hat being for this purpose mounted on a rapidly revolving block. The trimmer finally binds the outer brim and inserts the lining, after which the brim may be given more or less of a curl or turn over according to prevailing fashion.

Silk Hats.—The silk hat, which has now become co-extensive with civilization, is an article of comparatively recent introduction. It was invented in Florence about 1760, but it was more than half a century before it was worn to any great extent.

A silk hat consists of a light stiff body covered with a plush of silk, the manufacture of which in a brilliant glossy condition is the most important element in the industry. Originally the bodies were made of felt and various other materials, but now calico is chiefly used. The calico is first stiffened with a varnish of shellac, and then cut into pieces sufficient for crown, side and brim. The side-piece is wound round a wooden hat block, and its edges are

joined by hot ironing, and the crown-piece is put on and similarly attached to the side. The brim, consisting of three thicknesses of calico cemented together, is now slipped over and brought to its position, and thereafter a second side-piece and another crown are cemented on. The whole of the body, thus prepared, now receives a coat of size, and subsequently it is varnished over, and thus it is ready for the operation of covering. In covering this body, the under brim, generally of merino, is first attached, then the upper brim, and lastly the crown and side sewn together are drawn over. All these by hot ironing and stretching are drawn smooth and tight, and as the varnish of the body softens with the heat, body and cover adhere all over to each other without wrinkle or pucker. Dressing and polishing by means of damping, brushing and ironing, come next, after which the hat is "velured" in a revolving machine by the application of haircloth and velvet velures, which cleave the nap and gives it a smooth and glossy surface. The brim has only then to be bound, the linings inserted, and the brim finally curled, when the hat is ready for use.

HATCH, EDWIN (1835-1889), English theologian, was born at Derby on the 14th of September 1835, and was educated at King Edward's school, Birmingham, under James Prince Lee, afterwards bishop of Manchester. He had many struggles to pass through in early life, which tended to discipline his character and to form the habits of severe study and the mental independence for which he came to be distinguished. Hatch became scholar of Pembroke College, Oxford, took a second-class in classics in 1857, and won the Ellerton prize in 1858. He was professor of classics in Trinity College, Toronto, from 1859 to 1862, when he became rector of the high school at Quebec. In 1867 he returned to Oxford, and was made vice-principal of St Mary Hall, a post which he held until 1885. In 1883 he was presented to the living of Purling in Essex, and in 1884 was appointed university reader in ecclesiastical history. In 1880 he was Bampton lecturer, and from 1880 to 1884 Grinfield lecturer on the Septuagint. In 1883 the university of Edinburgh conferred on him the D.D. degree. He was the first editor of the university official *Gazette* (1870), and of the *Student's Handbook to the University*. A reputation acquired through certain contributions to the *Dictionary of Christian Antiquities* was confirmed by his treatises *On the Organization of the Early Christian Churches* (1881, his Bampton lectures), and on *The Influence of Greek Ideas and Usages on the Christian Church* (the Hibbert lectures for 1888). These works provoked no little criticism on account of the challenge they threw down to the high-church party, but the research and fairness displayed were admitted on all hands. The Bampton lectures were translated into German by Harnack. Among his other works are *The Growth of Church Institutions* (1887); *Essays in Biblical Greek* (1889); *A Concordance to the Septuagint* (in collaboration with H. A. Redpath); *Towards Fields of Light* (verse, 1889); *The God of Hope* (sermons with memoir, 1800). Hatch died on the 10th of November 1889.

An appreciation by W. Sanday appeared in *The Expositor* for February 1890.

HATCH. 1. (In Mid. Eng. *hache*; the word is of obscure origin, but cognate forms appear in Swed. *håcka*, and Dan. *hække*; it has been connected with "hatch," grating, with possible reference to a coop, and with "hack" in the sense "to peck," of chickens coming out of the shell), to bring out young from the egg, by incubation or other process, natural or artificial. The word is also used as a substantive of a brood of chickens brought out from the eggs. "Hatchery" is particularly applied to a place for the hatching of fish spawn, where the natural process is aided by artificial means. In a figurative sense "to hatch" is often used of the development or contrivance of a plot or conspiracy.

2. (From the Fr. *hacher*, to cut, *hache*, hatchet), to engrave or draw by means of cutting lines on wood, metal, &c., or to ornament by inlaying with strips of some other substance as gold or silver. Engraved lines, especially those used in shading, are called "hatches" or "hachures" (see HACHURE).

3. (O.E. *hæc*, a gate, rack in a stable; found in various Teutonic languages; cf. Dutch *hek*, Dan. *hekke*; the ultimate origin is obscure; Skeat suggests a connexion with the root seen in "hook"), the name given to the lower half of a divided

door, as in "buttery-hatch," the half-door leading from the buttery or kitchen, through which the dishes could be passed into the dining-hall. It was used formerly as another name for a ship's deck, and thus the phrase "under hatches" meant properly below deck; the word is now applied to the doors of grated framework covering the openings (the "hatchways") which lead from one deck to another into the hold through which the cargo is lowered. In Cornwall the word is used to denote certain dams or mounds used to prevent the tin-washes and the water coming from the stream-works from flowing into the fresh rivers.

HATCHET (adapted from the Fr. *hachette*, diminutive of *hache*, axe, *hacher*, to cut, hack), a small, light form of axe with a short handle (see *TOOT*); for the war-hatchet of the North American Indians and the symbolical ceremonies connected with it see *TOMAHAWK*.

HATCHETTITE, sometimes termed *Mountain Tallow*, *Mineral Adipocire*, or *Adipocerite*, a mineral hydrocarbon occurring in the Coal-measures of Belgium and elsewhere, occupying in some cases the interior of hollow concretions of iron-ore, but more generally the cavities of fossil shells or crevices in the rocks. It is of yellow colour, and translucent, but darkens and becomes opaque on exposure. It has no odour, is greasy to the touch, and has a slightly glistening lustre. Its hardness is that of soft wax. The melting point is 46° to 47° C., and the composition is C. 85.55, H. 14.45.

HATCHMENT, properly, in heraldry, an escutcheon or armorial shield granted for some act of distinction or "achievement," of which word it is a corruption through such forms as *atchement*, *achment*, *hachement*, &c. "Achievement" is an adaptation of the Fr. *achèvement*, from *achever*, à *chef venir*, Lat. *ad caput venire*, to come to a head, or conclusion, hence accomplish, achieve. The term "hatchment" is now usually applied to funeral escutcheons or armorial shields enclosed in a black lozenge-shaped frame suspended against the wall of a deceased person's house. It is usually placed over the entrance at the level of the second floor, and remains for from six to twelve months, when it is removed to the parish church. This custom is falling into disuse, though still not uncommon. It is usual to hang the hatchment of a deceased head of a house at the universities of Oxford and Cambridge over the entrance to his lodge or residence.

If for a bachelor the hatchment bears upon a shield his arms, crest, and other appendages, the whole on a black ground. If for a single woman, her arms are represented upon a lozenge,

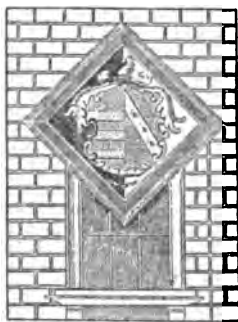

bordered with knotted ribbons, also on a black ground. If the hatchment be for a married man (as in the illustration), his arms upon a shield impale those of his surviving wife; or if she be an heiress they are placed upon a scutcheon of pretence, and crest and other appendages are added. The dexter half of the ground is black, the sinister white. For a wife whose husband is alive the same arrangement is used, but the sinister ground only is black. For a widower the same is used as for a married man, but the whole ground is black; for a widow the husband's arms are given with her own, but upon a lozenge, with ribbons, without crest or appendages, and the whole ground is black. When there have been two wives or two husbands the ground is divided into three parts per pale, and the division behind the arms of the survivor is white. Colours and military or naval emblems are sometimes placed behind the arms of military or naval officers. It is thus easy to discern from the hatchment the sex, condition and quality, and possibly the name of the deceased.

In Scottish hatchments it is not unusual to place the arms of the father and mother of the deceased in the two lateral angles of the lozenge, and sometimes the 4, 8 or 16 genealogical escutcheons are ranged along the margin.

HATFIELD, a town in the Mid or St Albans parliamentary division of Hertfordshire, England, 17½ m. N. of London by the Great Northern railway. Pop. (1901), 4754. It lies picturesquely on the flank of a wooded hill, and about its foot, past which runs the Great North Road. The church of St Eitheldreda, well situated towards the top of the hill, contains an Early English round arch with the dog-tooth moulding, but for the rest is Decorated and Perpendicular, and largely restored. The chapel north of the chancel is known as the Selisbury chapel, and was erected by Robert Cecil, first earl of Salisbury (d. 1612), who was buried here. It is in a mixture of classic and Gothic styles. In a private portion of the churchyard is buried, among others of the family, the third marquess of Salisbury (d. 1903). In the vicinity is Hatfield House, close to the site of a palace of the bishops of Ely, which was erected about the beginning of the 12th century. From this palace comes the proper form of the name of the town, Bishop's Hatfield. In 1538 the manor was resigned to Henry VIII. by Bishop Thomas Goodrich of Ely, in exchange for certain lands in Cambridge, Essex and Norfolk; and after that monarch the palace was successively the residence of Edward VI. immediately before his accession, of Queen Elizabeth during the reign of her sister Mary, and of James I. The last-named exchanged it in 1607 for Theobalds, near Cheam, in the same county, an estate of Robert Cecil, earl of Salisbury, in whose family Hatfield House has since remained. The west wing of the present mansion, built for Cecil in 1608-1611, was destroyed by fire in November 1835, the dowager marchioness of Salisbury, widow of the 1st marquess, perishing in the flames. Hatfield House was built, and has been restored and maintained, in the richest style of its period, both without and within. The buildings of mellowed red brick now used as stables and offices are, however, of a period far anterior to Cecil's time, and are probably part of the erection of John Morton, bishop of Ely in 1478-1486. The park measures some 10 m. in circumference. From the eminence on which the mansion stands the ground falls towards the river Lea, which here expands into a small lake. Beyond this is a rare example of a monks' walled vineyard. In the park is also an ancient oak under which Elizabeth is said to have been seated when the news of her sister's death was brought to her. Brocket Park is another fine demesne, at the neighbouring village of Lemsford, and the Brocket chapel in Hatfield church contains memorials of the families who have held this seat.

HATHERLEY, WILLIAM PAGE WOOD, 1ST BARON (1801-1881), lord chancellor of Great Britain, son of Sir Matthew Wood, a London alderman and lord mayor who became famous for befriending Queen Caroline and braving George IV., was born in London on the 29th of November 1801. He was educated at Winchester, Geneva University, and Trinity College, Cambridge, where he became a fellow after being 24th wrangler in 1824. He entered Lincoln's Inn, and was called to the bar in 1824, studying conveyancing in Mr John Tyrrell's chambers. He soon obtained a good practice as an equity draughtsman and before parliamentary committees, and in 1830 married Miss Charlotte Moor. In 1845 he became Q.C., and in 1847 was elected to parliament for the city of Oxford as a Liberal. In 1849 he was appointed vice-chancellor of the county palatine of Lancaster, and in 1851 was made solicitor-general and knighted, vacating that position in 1852. When his party returned to power in 1853, he was raised to the bench as a vice-chancellor. In 1868 he was made a lord justice of appeal, but before the end of the year was selected by Mr Gladstone to be lord chancellor, and was raised to the peerage as Lord Hatherley of Down Hatherley. He retired in 1872 owing to failing eyesight, but sat occasionally as a law lord. His wife's death in 1878 was a great blow, from which he never recovered, and he died in London on the 10th of July 1881. Dean Hook said that Lord Hatherley—who was a sound and benevolent supporter of the Church of

England—was the best man he had ever known. He was a particularly clear-headed lawyer, and his judgments—always delivered extempore—commanded the greatest confidence both with the public and the legal profession. He left no issue and the title became extinct on his death.

HATHERTON, EDWARD JOHN LITTLETON, 1ST BARON (1791–1863), was born on the 18th of March 1791 and was educated at Rugby school and at Brasenose College, Oxford. He was the only son of Moreton Walhouse of Hatherton, Staffordshire; but in 1812, in accordance with the will of his great-uncle Sir Edward Littleton, Bart. (d. 1802), he took the name of Littleton. From 1812 to 1832 he was member of parliament for Staffordshire and from 1832 to 1835 for the southern division of that county, being specially prominent in the House of Commons as an advocate of Roman Catholic emancipation. In January 1833, against his own wish, he was put forward by the Radicals as a candidate for the office of speaker, but he was not elected and in May 1833 he became chief secretary to the lord-lieutenant of Ireland in the ministry of Earl Grey. His duties in this capacity brought him frequently into conflict with O'Connell, but he was obviously unequal to the great Irishman, although he told his colleagues to "leave me to manage Dan." He had to deal with the vexed and difficult question of the Irish tithes on which the government was divided, and with his colleagues had to face the problem of a new coercion act. Rather hastily he made a compact with O'Connell on the assumption that the new act could not contain certain clauses which were part of the old act. The clauses, however, were inserted; O'Connell charged Littleton with deception; and in July 1834 Grey, Althorp (afterwards Earl Spencer) and the Irish secretary resigned. The two latter were induced to serve under the new premier, Lord Melbourne, and they remained in office until Melbourne was dismissed in November 1834. In 1835 Littleton was created Baron Hatherton, and he died at his Staffordshire residence, Teddesley Hall, on the 4th of May 1863. In 1888 his grandson, Edward George Littleton (b. 1842), became 3rd Baron Hatherton.

See Hatherton's *Memoirs and Correspondence relating to Political Occurrences, June–July 1834*, edited by H. Reeve (1872); and Sir S. Walpole, *History of England*, vol. iii. (1890).

HATHRAS, a town of British India, in the Aligarh district of the United Provinces, 29 m. N. of Agra. Pop. (1901), 42,578. At the end of the 18th century it was held by a Jat chieftain, whose ruined fort still stands at the east end of the town, and was annexed by the British in 1803, but insubordination on the part of the chief necessitated the siege of the fort in 1817. Since it came under British rule, Hathras has rapidly risen to commercial importance, and now ranks second to Cawnpore among the trading centres of the Doab. The chief articles of commerce are sugar and grain, there are also factories for ginning and pressing cotton, and a cotton spinning-mill. Hathras is connected by a light railway with Muttra, and by a branch with Hathras junction, on the East Indian main line.

HATTIESBURG, a city and the county-seat of Forrest county, Mississippi, U.S.A., on the Hastahatchee (or Leaf) river, about 90 m. S.E. of Jackson. Pop. (1890) 1172; (1900) 4175 (1687 negroes); (1910) 11,733. Hattiesburg is served by the Gulf & Ship Island, the Mississippi Central, the New Orleans, Mobile & Chicago and the New Orleans & North Eastern railways. The officers and employees of the Gulf & Ship Island railway own and maintain a hospital here. The city is in a rich farming, truck-gardening and lumbering country. Among its manufactures are lumber (especially yellow-pine), wood-alcohol, turpentine, paper and pulp, fertilizers, wagons, mattresses and machine-shop products. Hattiesburg was founded about 1882 and was named in honour of the wife of W. H. Hardy, a railway official, who planned a town at the intersection of the New Orleans & North-Eastern (which built a round house and repair shops here in 1885) and the Gulf & Ship Island railways. The latter railway was opened from Gulfport to Hattiesburg in January 1897, and from Hattiesburg to Jackson in September 1900. Hattiesburg was incorporated as a town in 1884 and was chartered as a city in 1899. Formerly the "court house" of the second judicial

district of Perry county, Hattiesburg became on the 1st of January 1908 the county-seat of Forrest county, erected from the W. part of Perry county.

HATTINGEN, a town of Germany, in the Prussian province of Westphalia, on the river Ruhr, 21 m. N.E. of Düsseldorf. Pop. (1900), 8975. It has two Evangelical and a Roman Catholic church. The manufactures include tobacco, and iron and steel goods. In the neighbourhood are the ruins of the Isenburg, demolished in 1226. Hattingen, which received communal rights in 1396, was one of the Hanse towns.

HATTO I. (c. 850–913), archbishop of Mainz, belonged to a Swabian family, and was probably educated at the monastery of Reichenau, of which he became abbot in 888. He soon became known to the German king, Arnulf, who appointed him archbishop of Mainz in 891; and he became such a trustworthy and confidential counsellor that he was popularly called "the heart of the king." He presided over the important synod at Tribur in 895, and accompanied the king to Italy in 894 and 895, where he was received with great favour by Pope Formosus. In 899, when Arnulf died, Hatto became regent of Germany, and guardian of the young king, Louis the Child, whose authority he compelled Zwentibold, king of Lorraine, an illegitimate son of Arnulf, to recognize. During these years he did not neglect his own interests, for in 896 he secured for himself the abbey of Ellwangen and in 898 that of Lorsch. He assisted the Franconian family of the Conradines in its feud with the Babenbergs, and was accused of betraying Adalbert, count of Babenberg, to death. He retained his influence during the whole of the reign of Louis; and on the king's death in 911 was prominent in securing the election of Conrad, duke of Franconia, to the vacant throne. When trouble arose between Conrad and Henry, duke of Saxony, afterwards King Henry the Fowler, the attitude of Conrad was ascribed by the Saxons to the influence of Hatto, who wished to prevent Henry from securing authority in Thuringia, where the see of Mainz had extensive possessions. He was accused of complicity in a plot to murder Duke Henry, who in return ravaged the archiepiscopal lands in Saxony and Thuringia. He died on the 15th of May 913, one tradition saying he was struck by lightning, and another that he was thrown alive by the devil into the crater of Mount Etna. His memory was long regarded in Saxony with great abhorrence, and stories of cruelty and treachery gathered round his name. The legend of the Mouse Tower at Bingen is connected with Hatto II., who was archbishop of Mainz from 968 to 970. This Hatto built the church of St George on the island of Reichenau, was generous to the see of Mainz and to the abbey of Fulda and Reichenau, and was a patron of the chronicler Regino, abbot of Prüm.

See E. Dümmler, *Geschichte des ostfränkischen Reichs* (Leipzig, 1887–1888); G. Phillips, *Die grosse Synode von Tribur* (Vienna, 1865); J. Heidemann, *Hatto I., Erzbischof von Mainz* (Berlin, 1865); G. Watz, *Jahrbücher der deutschen Geschichte unter Heinrich I.* (Berlin and Leipzig, 1863); and J. F. Böhmer, *Regesta archiepiscoporum Maguntinensium*, edited by C. Will (Innsbruck, 1877–1886).

HATTON, SIR CHRISTOPHER (1540–1591), lord chancellor of England and favourite of Queen Elizabeth, was a son of William Hatton (d. 1546) of Holdenby, Northamptonshire, and was educated at St Mary Hall, Oxford. A handsome and accomplished man, being especially distinguished for his elegant dancing, he soon attracted the notice of Queen Elizabeth, became one of her gentlemen pensioners in 1564, and captain of her bodyguard in 1572. He received numerous estates and many positions of trust and profit from the queen, and suspicion was not slow to assert that he was Elizabeth's lover, a charge which was definitely made by Mary queen of Scots in 1584. Hatton, who was probably innocent in this matter, had been made vice-chamberlain of the royal household and a member of the privy council in 1578, and had been a member of parliament since 1571, first representing the borough of Higham Ferrers and afterwards the county of Northampton. In 1578 he was knighted, and was now regarded as the queen's spokesman in the House of Commons, being an active agent in the prosecutions of John Stubbs and William Parry. He was one of those who were appointed to arrange a marriage between Elizabeth and Francis, duke of

Alençon, in 1581; was a member of the court which tried Anthony Babington in 1586; and was one of the commissioners who found Mary queen of Scots guilty. He besought Elizabeth not to marry the French prince; and according to one account repeatedly assured Mary that he would fetch her to London if the English queen died. Whether or no this story be true, Hatton's loyalty was not questioned; and he was the foremost figure in that striking scene in the House of Commons in December 1584, when four hundred kneeling members repeated after him a prayer for Elizabeth's safety. Having been the constant recipient of substantial marks of the queen's favour, he vigorously denounced Mary Stuart in parliament, and advised William Davison to forward the warrant for her execution to Fotheringay. In the same year (1587) Hatton was made lord chancellor, and although he had no great knowledge of the law, he appears to have acted with sound sense and good judgment in his new position. He is said to have been a Roman Catholic in all but name, yet he treated religious questions in a moderate and tolerant way. He died in London on the 20th of November 1591, and was buried in St Paul's cathedral. Although mention has been made of a secret marriage, Hatton appears to have remained single, and his large and valuable estates descended to his nephew, Sir William Newport, who took the name of Hatton. Sir Christopher was a knight of the Garter and chancellor of the university of Oxford. Elizabeth frequently showed her affection for her favourite in an extravagant and ostentatious manner. She called him her *mouton*, and forced the bishop of Ely to give him the freehold of Ely Place, Holborn, which became his residence, his name being perpetuated in the neighbouring Hatton Garden. Hatton is reported to have been a very mean man, but he patronized men of letters, and among his friends was Edmund Spenser. He wrote the fourth act of a tragedy, *Tancred and Gismund*, and his death occasioned several panegyrics in both prose and verse.

When Hatton's nephew, Sir William Hatton, died without sons in 1597, his estates passed to a kinsman, another Sir Christopher Hatton (d. 1619), whose son and successor, Christopher (c. 1605-1670), was elected a member of the Long Parliament in 1640, and during the Civil War was a partisan of Charles I. In 1643 he was created Baron Hatton of Kirby; and, acting as comptroller of the royal household, he represented the king during the negotiations at Uxbridge in 1645. Later he lived for some years in France, and after the Restoration was made a privy councillor and governor of Guernsey. He died at Kirby on the 4th of July 1670, and was buried in Westminster Abbey. By his wife Elizabeth (d. 1672), daughter of Sir Charles Montagu of Boughton, he had two sons and three daughters. His eldest son Christopher (1632-1706), succeeded his father as Baron Hatton and also as governor of Guernsey in 1670. In 1683 he was created Viscount Hatton of Grendon. He was married three times, and left two sons: William (1690-1760), who succeeded to his father's titles and estates, and Henry Charles (c. 1700-1762), who enjoyed the same dignities for a short time after his brother's death. When Henry Charles died, the titles became extinct, and the family is now represented by the Finch-Hattons, earls of Winchelsea and Nottingham, whose ancestor, Daniel Finch, 2nd earl of Nottingham, married Anne (d. 1743), daughter of the 1st Viscount Hatton.

See Sir N. H. Nicolas, *Life and Times of Sir Christopher Hatton* (London, 1847); and *Correspondence of the Family of Hatton, being chiefly Letters addressed to Christopher, first Viscount Hatton, 1601-1704*, edited with introduction by E. M. Thompson (London, 1878).

HATTON, JOHN LIPTRÖT (1809-1886), English musical composer, was born at Liverpool on the 12th of October 1809. He was virtually a self-taught musician, and besides holding several appointments as organist in Liverpool, appeared as an actor on the Liverpool stage, subsequently finding his way to London as a member of Macready's company at Drury Lane in 1832. Ten years after this he was appointed conductor at the same theatre for a series of English operas, and in 1843 his own first opera, *Queen of the Thames*, was given with success. Staudigl, the eminent German bass, was a member of the com-

pany, and at his suggestion Hatton wrote a more ambitious work, *Pascal Bruno*, which, in a German translation, was presented at Vienna, with Staudigl in the principal part; the opera contained a song, "Revenge," which the basso made very popular in England, though the piece as a whole was not successful enough to be produced here. Hatton's excellent pianoforte playing attracted much attention in Vienna; he took the opportunity of studying counterpoint under Sechter, and wrote a number of songs, obviously modelled on the style of German classics. In 1846 he appeared at the Hereford festival as a singer, and also played a pianoforte concerto of Mozart. He undertook concert tours about this time with Sivori, Vieuxtemps and others. From 1848 to 1850 he was in America; on his return he became conductor of the Glee and Madrigal Union, and from about 1853 was engaged at the Princess's theatre to provide and conduct the music for Charles Kean's Shakespearean revivals. He seems to have kept this appointment for about five years. In 1856 a cantata, *Robin Hood*, was given at the Bradford festival, and a third opera, *Rose, or Love's Ransom*, at Covent Garden in 1864, without much success. In 1866 he went again to America, and from this year Hatton held the post of accompanist at the Ballad Concerts, St James's Hall, for nine seasons. In 1875 he went to Stuttgart, and wrote an oratorio, *Hesekiah*, given at the Crystal Palace in 1877; like all his larger works it met with very moderate success. Hatton excelled in the lyrical forms of music, and, in spite of his distinct skill in the severer styles of the madrigal, &c., he won popularity by such songs as "To Anthea," "Good-bye, Sweetheart," and "Simon the Cellarer," the first of which may be called a classic in its own way. His glees and part-songs, such as "When Evening's Twilight," are still reckoned among the best of their class; and he might have gained a place of higher distinction among English composers had it not been for his irresistible animal spirits and a want of artistic reverence, which made it uncertain in his younger days whether, when he appeared at a concert, he would play a fugue of Bach or sing a comic song. He died at Margate on the 20th of September 1886.

HAUGH, JOHANNES CARSTEN (1790-1872), Danish poet, was born of Danish parents residing at Frederikshald in Norway, on the 12th of May 1790. In 1802 he lost his mother, and in 1803 returned with his father to Denmark. In 1807 he fought as a volunteer against the English invasion. He entered the university of Copenhagen in 1808, and in 1821 took his doctor's degree. He became the friend and associate of Steffens and Oehlenschläger, warmly adopting the romantic views about poetry and philosophy. His first two dramatic poems, *The Journey to Ginistan* and *The Power of Fancy*, appeared in 1816, and were followed by a lyrical drama, *Rosaura* (1817); but these works attracted little or no attention. Hauch therefore gave up all hope of fame as a poet, and resigned himself entirely to the study of science. He took his doctor's degree in zoology in 1821, and went abroad to pursue his studies. At Nice he had an accident which obliged him to submit to the amputation of one foot. He returned to literature, publishing a dramatized fairy tale, the *Hamadryad*, and the tragedies of *Bajazet*, *Tiberius*, *Gregory VII.*, in 1828-1829, *The Death of Charles V.* (1831), and *The Siege of Maastricht* (1832). These plays were violently attacked and enjoyed no success. Hauch then turned to novel-writing, and published in succession five romances—*Vilhelm Zabern* (1834); *The Alchemist* (1836); *A Polish Family* (1839); *The Castle on the Rhine* (1845); and *Robert Fulton* (1853). In 1842 he collected his shorter *Poems*. In 1846 he was appointed professor of the Scandinavian languages in Kiel, but returned to Copenhagen when the war broke out in 1848. About this time his dramatic talent was at its height, and he produced one admirable tragedy after another; among these may be mentioned *Send Gratie* (1841); *The Sisters at Kinnekulle* (1849); *Marshal Stig* (1850); *Honour Lost and Won* (1851); and *Tycho Brahe's Youth* (1852). From 1858 to 1860 Hauch was director of the Danish National Theatre; he produced three more tragedies—*The King's Favourite* (1859); *Henry of Navarre* (1863); and *Julian the Apostate* (1866). In 1861 he

published another collection of *Lyrical Poems and Romances*; and in 1862 the historical epic of *Valdemar Sejr*, volumes which contain his best work. From 1851, when he succeeded Oehlenschläger, to his death, he held the honorary post of professor of aesthetics at the university of Copenhagen. He died in Rome in 1872. Hauch was one of the most prolific of the Danish poets, though his writings are unequal in value. His lyrics and romances in verse are always fine in form and often strongly imaginative. In all his writings, but especially in his tragedies, he displays a strong bias in favour of what is mystical and supernatural. Of his dramas *Marshall Stig* is perhaps the best, and of his novels the patriotic tale of *Vilhelm Zabern* is admired the most.

See G. Brandes, "Carsten Hauch" (1872) in *Danske Digtere* (1877); F. Rönning, *J. C. Hauch* (1890), and in *Dansk Biografisk-Lexicon*, (vol. vii. Copenhagen, 1893). Hauch's novels were collected (1873-1874) and his dramatic works (3 vols., 2nd ed., 1852-1859).

HAUER, FRANZ, RITTER VON (1822-1899), Austrian geologist, born in Vienna on the 30th of January 1822, was son of Joseph von Hauer (1778-1863), who was equally distinguished as a high Austrian official and authority on finance and as a palaeontologist. He was educated in Vienna, afterwards studied geology at the mining academy of Schemnitz (1839-1843), and for a time was engaged in official mining work in Styria. In 1846 he became assistant to W. von Haidinger at the mineralogical museum in Vienna; three years later he joined the imperial geological institute, and in 1866 he was appointed director. In 1886 he became superintendent of the imperial natural history museum in Vienna. Among his special geological works are those on the Cephalopoda of the Triassic and Jurassic formations of Alpine regions (1855-1856). His most important general work was that of the *Geological Map of Austro-Hungary*, in twelve sheets (1867-1871; 4th ed., 1884, including Bosnia and Montenegro). This map was accompanied by a series of explanatory pamphlets. In 1882 he was awarded the Wollaston medal by the Geological Society of London. In 1892 von Hauer became a life-member of the upper house of the Austrian parliament. He died on the 20th of March 1899.

PUBLICATIONS.—*Beiträge zur Paläontologie von Österreich* (1858-1859); *Die Geologie und ihre Anwendung auf die Kenntnis der Bodenbeschaffenheit der österr.-ungar. Monarchie* (1875; ed. 2, 1878).

Memoir by Dr E. Tietze; *Jahrbuch der K. K. geol. Reichsanstalt* (1899, reprinted 1900, with portrait).

HAUFF, WILHELM (1802-1827), German poet and novelist, was born at Stuttgart on the 20th of November 1802, the son of a secretary in the ministry of foreign affairs. Young Hauff lost his father when he was but seven years of age, and his early education was practically self-gained in the library of his maternal grandfather at Tübingen, to which place his mother had removed. In 1818 he was sent to the Klosterschule at Blaubeuren, whence he passed in 1820 to the university of Tübingen. In four years he completed his philosophical and theological studies, and on leaving the university became tutor to the children of the famous Württemberg minister of war, General Baron Ernst Eugen von Hügel (1774-1840), and for them wrote his *Märchen*, which he published in his *Märchenalbum auf das Jahr 1826*. He also wrote there the first part of the *Mitteilungen aus den Memoiren des Saton* (1826) and *Der Mann im Monde* (1825). The latter, a parody of the sentimental and sensual novels of H. Claren (pseudonym of Karl Gottlieb Samuel Heun (1771-1854)), became, in course of composition, a close imitation of that author's style and was actually published under his name. Claren, in consequence, brought an action for damages against Hauff and gained his case. Whereupon Hauff followed up the attack in his witty and sarcastic *Kontroverspredigt über H. Claren und den Mann im Monde* (1826) and attained his original object—the moral annihilation of the mawkish and unhealthy literature with which Claren was flooding the country. Meanwhile, animated by Sir Walter Scott's novels, Hauff wrote the historical romance *Lichtenstein* (1826), which acquired great popularity in Germany and especially in Swabia, treating as it did the most interesting period in the history of that country, the reign

of Duke Ulrich (1487-1550). While on a journey to France, the Netherlands and north Germany he wrote the second part of the *Memoiren des Saton* and some short novels, among them the charming *Bettlerin vom Pont des Arts* and his masterpiece, the *Phantasien im Bremer Rathhaller* (1827). He also published some short poems which have passed into *Volkslieder*, among them *Morgenrot, Morgenrot, leuchtet mir zum frühen Tod*; and *Steh' ich in finst'rer Mitternacht*. In January 1827, Hauff undertook the editorship of the Stuttgart *Morgenblatt* and in the following month married, but his happiness was prematurely cut short by his death from fever on the 18th of November 1827.

Considering his brief life, Hauff was an extraordinarily prolific writer. The freshness and originality of his talent, his inventiveness, and his genial humour have won him a high place among the south German prose writers of the early nineteenth century.

His *Ständische Werke* were published, with a biography, by G. Schwab (3 vols., 1830-1834; 5 vols., 18th ed., 1862), and by F. Bobertag (1891-1897), and a selection by M. Mendheim (3 vols., 1891). For his life cf. J. Klüber, *Wilhelm Hauff, ein Lebensbild* (1881); M. Mendheim, *Hauffs Leben und Werke* (1894); and H. Hofmann, *W. Hauff* (1902).

HAUG, MARTIN (1827-1876), German Orientalist, was born at Ostdorf near Balingen, Württemberg, on the 30th of January 1827. He became a pupil in the gymnasium at Stuttgart at a comparatively late age, and in 1848 he entered the university of Tübingen, where he studied Oriental languages, especially Sanskrit. He afterwards attended lectures in Göttingen, and in 1854 settled as *Privatdozent* at Bonn. In 1856 he removed to Heidelberg, where he assisted Bunsen in his literary undertakings; and in 1859 he accepted an invitation to India, where he became superintendent of Sanskrit studies and professor of Sanskrit in Poona. Here his acquaintance with the Zend language and literature afforded him excellent opportunities for extending his knowledge of this branch of literature. The result of his researches was a volume of *Essays on the sacred language, writings and religion of the Parsees* (Bombay, 1862). Having returned to Stuttgart in 1866, he was called to Munich as professor of Sanskrit and comparative philology in 1868. He died on the 3rd of June 1876.

Besides the *Essays on the Parsees*, of which a new edition, by E. W. West, greatly enriched from the posthumous papers of the author, appeared in 1878, Haug published a number of works of considerable importance to the student of the literatures of ancient India and Persia. They include *Die Pehlewische Sprache und der Bundesheusch* (1854); *Die Schrift und Sprache der zweiten Keilschriftstellung* (1855); *Die fünf Galhas*, edited, translated and expounded (1858-1860); an edition, with translation and explanation, of the *Aitareya Brahmana of the Rigveda* (Bombay, 1863), which is accounted his best work in the province of ancient Indian literature; *A Lecture on an original Speech of Zoroaster* (1865); *An old Zend-Pahlavi Glossary* (1867); *Über den Charakter der Pehlewische Sprache* (1869); *Das 18. Kapitel der Wendidad* (1869); *Über das Ardat-Viraf-nameh* (1870); *An old Pahlavi-Puzand Glossary* (1870); and *Vedische Rätsellagen und Rätselsprache* (1875).

For particulars of Haug's life and work, see A. Bezenberger, *Beiträge zur Kunde der indogermanischen Sprachen*, vol. i. pp. 70 seq.

HAUGE, HANS NIELSEN (1771-1824), Norwegian Lutheran divine, was born in the parish of Thund, Norway, on the 3rd of April 1771, the son of a peasant. With the aid of various religious works which he found in his father's house, he laboured to supplement his scanty education. In his twenty-sixth year, believing himself to be a divinely-commissioned prophet, he began to preach in his native parish and afterwards throughout Norway, calling people to repentance and attacking rationalism. In 1800 he passed to Denmark, where, as at home, he gained many followers and assistants, chiefly among the lower orders. Proceeding to Christiansand in 1804, Hauge set up a printing-press to disseminate his views more widely, but was almost immediately arrested for holding illegal religious meetings, and for insulting the regular clergy in his books, all of which were confiscated; he was also heavily fined. After being in confinement for some years, he was released in 1814 on payment of a fine, and retiring to an estate at Breddwill, near Christiania, he died there on the 29th of March 1824. His adherents, who did not formally break with the church, were called *Haugianer* or *Læser* (i.e. Readers). He unquestionably did much to revive

the spiritual life of the northern Lutheran Church. His views were of a pietistic nature. Though he cannot be said to have rejected any article of the Lutheran creed, the peculiar emphasis which he laid upon the evangelical doctrines of faith and grace involved considerable antagonism to the rationalistic or sacerdotal views commonly held by the established clergy.

Hauge's principal writings are *Forsøg til Afhandling om Guds Vidom* (1796); *Avvisning til nogle mærkelige Sprog i Bibelen* (1798); *Forblaring over Loven og Evangelium* (1803). For an account of his life and doctrines see C. Bang's *Hans Nielsen Hauge og hans Samtid* (Christiania; 2nd ed., 1875); O. Rost, *Nogle Bemærkninger om Hans Nielsen Hauge og hans Retning* (1883), and the article in Herzog-Hauck, *Realencyklopædie*.

HAUGESUND, a seaport of Norway in Stavanger amt (county), on the west coast, 34 m. N. by W. of Stavanger. Pop. (1900), 7935. It is an important fishing centre. Herrings are exported to the annual value of £100,000 to £200,000, also mackerel and lobsters. The principal imports are coal and salt. There are factories for woollen goods and a margarine factory. Haugesund is the reputed death-place of Harald Haarfager, to whom an obelisk of red granite was erected in 1872 on the thousandth anniversary of his victory at the Hafsford (near Stavanger) whereby he won the sovereignty of Norway. The memorial stands 1½ m. north of the town, on the Haraldshaug, where the hero's supposed tombstone is shown.

HAUGHTON, SAMUEL (1821-1897), Irish scientific writer, the son of James Haughton (1795-1873), was born at Carlow on the 21st of December 1821. His father, the son of a Quaker, but himself a Unitarian, was an active philanthropist, a strong supporter of Father Theobald Mathew, a vegetarian, and an anti-slavery worker and writer. After a distinguished career in Trinity College, Dublin, Samuel was elected a fellow in 1844. He was ordained priest in 1847, but seldom preached. In 1851 he was appointed professor of geology in Trinity College, and this post he held for thirty years. He began the study of medicine in 1850, and in 1862 took the degree of M.D. in the university of Dublin. He was then made registrar of the Medical School, the status of which he did much to improve, and he represented the university on the General Medical Council from 1878 to 1896. He was elected F.R.S. in 1858, and in course of time Oxford conferred upon him the hon. degree of D.C.L., and Cambridge and Edinburgh that of LL.D. He was a man of remarkable knowledge and ability, and he communicated papers on widely different subjects to various learned societies and scientific journals in London and Dublin. He wrote on the laws of equilibrium and motion of solid and fluid bodies (1846), on sun-heat, terrestrial radiation, geological climates and on tides. He wrote also on the granites of Leinster and Donegal, and on the cleavage and joint-planes in the Old Red Sandstone of Waterford (1857-1858). He was president of the Royal Irish Academy from 1886 to 1891, and for twenty years he was secretary of the Royal Zoological Society of Ireland. He died in Dublin on the 31st of October 1897.

PUBLICATIONS.—*Manual of Geology* (1865); *Principles of Animal Mechanics* (1873); *Six Lectures on Physical Geography* (1880). In conjunction with his friend, Professor J. Galbraith, he issued a series of *Manuals of Mathematical and Physical Science*.

HAUGHTON, WILLIAM (fl. 1598), English playwright. He collaborated in many plays with Henry Chettle, Thomas Dekker, John Day and Richard Hathway. The only certain biographical information about him is derived from Philip Henslowe, who on the 10th of March 1600 lent him ten shillings "to release him out of the Clink." Mr Fleay credits him with a considerable share in *The Patient Grissill* (1599), and a merry comedy entitled *English-Men for my Money, or A Woman will have her Will* (1598) is ascribed to his sole authorship. *The Devil and his Dame*, mentioned as a forthcoming play by Henslowe in March 1600, is identified by Mr Fleay as *Grim, the Collier of Croydon*, which was printed in 1662. In this play an emissary is sent from the infernal regions to report on the conditions of married life on earth.

Grim is reprinted in vol. viii., and *English-Men for my Money* in vol. x., of W. C. Hazlitt's edition of Dodsley's *Old Plays*.

HAUGWITZ, CHRISTIAN AUGUST HEINRICH KURT, COUNT VON, FREIHERR VON KRAPPITZ (1758-1831), Prussian statesman, was born on the 11th of June 1752, at Peucke near Ols. He belonged to the Silesian (Protestant) branch of the ancient family of Haugwitz, of which the Catholic branch is established in Moravia. He studied law, spent some time in Italy, returned to settle on his estates in Silesia, and in 1791 was elected by the Silesian estates general director of the province. At the urgent instance of King Frederick William II. he entered the Prussian service, became ambassador at Vienna in 1792 and at the end of the same year a member of the cabinet at Berlin.

Haugwitz, who had attended the young emperor Francis II. at his coronation and been present at the conferences held at Mainz to consider the attitude of the German powers towards the Revolution, was opposed to the exaggerated attitude of the French *émigrés* and to any interference in the internal affairs of France. After the war broke out, however, the defiant temper of the Committee of Public Safety made an honourable peace impossible, while the strained relations between Austria and Prussia on the question of territorial "compensations" crippled the power of the Allies to carry the war to a successful conclusion. It was in these circumstances that Haugwitz entered on the negotiations that resulted in the subsidy treaty between Great Britain and Prussia, and Great Britain and Holland, signed at the Hague on the 10th of April 1794. Haugwitz, however, was not the man to direct a strong and aggressive policy; the failure of Prussia to make any effective use of the money supplied broke the patience of Pitt, and in October the denunciation by Great Britain of the Hague treaty broke the last tie that bound Prussia to the Coalition. The separate treaty with France, signed at Basel on the 5th of April 1795, was mainly due to the influence of Haugwitz.

His object was now to save the provinces on the left bank of the Rhine from being lost to the Empire. No guarantee of their maintenance had been inserted in the Basel treaty; but Haugwitz and the king hoped to preserve them by establishing the armed neutrality of North Germany and securing its recognition by the French Republic. This policy was rendered futile by the victories of Napoleon Bonaparte and the virtual conquest of South Germany by the French. Haugwitz, who had continued to enjoy the confidence of the new king, Frederick William III., recognized this fact, and urged his master to join the new Coalition in 1798. But the king clung blindly to the illusion of neutrality, and Haugwitz allowed himself to be made the instrument of a policy of which he increasingly disapproved. It was not till 1803, when the king refused his urgent advice to demand the evacuation of Hanover by the French, that he tendered his resignation. In August 1804 he was definitely replaced by Hardenberg, and retired to his estates.

In his retirement Haugwitz was still consulted, and he used all his influence against Hardenberg's policy of a *rapprochement* with France. His representations had little weight, however, until Napoleon's high-handed action in violating Prussian territory by marching troops through Ansbach, roused the anger of the king. Haugwitz was now once more appointed foreign minister, as Hardenberg's colleague, and it was he who was charged to carry to Napoleon the Prussian ultimatum which was the outcome of the visit of the tsar Alexander I. to Berlin in November. But in this crisis his courage failed him; his nature was one that ever let "I dare not wait upon I will"; he delayed his journey pending some turn in events and to give time for the mobilization of the duke of Brunswick's army; he was frightened by reports of separate negotiations between Austria and Napoleon, not realizing that a bold declaration by Prussia would nip them in the bud. Napoleon, when at last they met, read him like a book and humoured his diplomatic weakness until the whole issue was decided at Austerlitz. On the 15th of December, instead of delivering an ultimatum, Haugwitz signed at Schönbrunn the treaty which gave Hanover to Prussia in return for Ansbach, Cleves and Neuchâtel.

The humiliation of Prussia and her minister was, however,

not yet complete. In February 1806 Haugwitz went to Paris to ratify the treaty of Schönbrunn and to attempt to secure some modifications in favour of Prussia. He was received with a storm of abuse by Napoleon, who insisted on tearing up the treaty and drawing up a fresh one, which doubled the amount of territory to be ceded by Prussia and forced her to a breach with Great Britain by binding her to close the Hanoverian ports to British commerce. The treaty, signed on the 15th of February, left Prussia wholly isolated in Europe. What followed belongs to the history of Europe rather than to the biography of Haugwitz. He remained, indeed, at the head of the Prussian ministry of foreign affairs, but the course of Prussian policy it was beyond his power to control. The Prussian ultimatum to Napoleon was forced upon him by overwhelming circumstances, and with the battle of Jena, on the 14th of October, his political career came to an end. He accompanied the flight of the king into East Prussia, there took leave of him and retired to his Silesian estates. In 1811 he was appointed *Curator* of the university of Breslau; in 1820, owing to falling health, he went to live in Italy, where he remained till his death at Venice in 1831.

Haugwitz was a man of great intellectual gifts, of dignified presence and a charming address which endeared him to his sovereigns and his colleagues; but as a statesman he failed, not through want of perspicacity, but through lack of will power and a fatal habit of procrastination. During his retirement in Italy he wrote memoirs in justification of his policy, a fragment of which dealing with the episode of the treaty of Schönbrunn was published at Jena in 1837.

¹ See J. von Minutoli, *Der Graf von Haugwitz und Job von Witleben* (Berlin, 1844); L. von Ranke, *Hardenberg u. d. Gesch. des preuss. Staates* (Leipzig, 1879-1881), note on Haugwitz's memoirs in vol. ii.; *Denkwürdigkeiten des Staatskanzlers Fürsten von Hardenberg*, ed. Ranke (5 vols., Leipzig, 1877); A. Sorel, *L'Europe et la Révol. Franç., passim*.

HAUNTINGS (from "to haunt," Fr. *hanter*, of uncertain origin, but possibly from Lat. *ambulare*, *ambire*, to go about, frequent), the supposed manifestations of existence by spirits of the dead in houses or places familiar to them in life. The savage practice of tying up the corpse before burying it is clearly intended to prevent the dead from "walking"; and cremation, whether in savage lands or in classical times, may have originally had the same motive. The "spirit" manifests himself, as a rule, either in his bodily form, as when he lived, or in the shape of some animal, or by disturbing noises, as in the case of the poltergeist (*q.v.*). Classical examples occur in Plautus (*Moskilaria*), Lucian (*Philopseudes*), Pliny, Suetonius, St Augustine, St Gregory, Plutarch and elsewhere, while Lucretius has his theory of apparitions of the dead. He does not deny the fact; he explains it by "films" diffused from the living body and persisting in the atmosphere.

A somewhat similar hypothesis, to account for certain alleged phenomena, was invented by Mr Edmund Gurney. Some visionary appearances in haunted houses do not suggest the idea of an ambulatory spirit, but rather of the photograph of a past event, impressed we know not how on we know not what. In this theory there is no room for the agency of spirits of the dead. The belief in hauntings was naturally persistent through the middle ages, and example and theory abound in the *Loca infesta* (Cologne, 1508) of Petrus Thyraeus, S.J.; Wierius (*c.* 1560), in *De præstigiis daemorum*, is in the same tale. According to Thyraeus, hauntings appeal to the senses of sight, hearing and touch. The auditory phenomena are mainly thumping noises, sounds of footsteps, laughing and moaning. Rackets in general are caused by *lares domestici* ("brownies") or the Poltergeist. In the tactile way ghosts *push* the living; "I have been thrice pushed by an invisible power," writes the Rev. Samuel Wesley, in 1717, in his narrative of the disturbances at his rectory at Epworth. Once he was pushed against the corner of his desk in the study; once up against the door of the matted chamber; and, thirdly, "against the right-hand side of the frame of my study door, as I was going in." We have thus Protestant corroboration of the statement of the learned Jesuit.

Thyraeus raises the question, Are the experiences hallucinatory? Did Mr Wesley (to take his case) receive a mere hallucinatory set of pushes? Was the hair of a friend of the writer's, who occupied a haunted house, only pulled in a subjective way? Thyraeus remarks that, in cases of noisy phenomena, not all persons present hear them; and, rather curiously, Mr Wesley records the same experience; he sometimes did not hear sounds that seemed violently loud to his wife and family, who were with him at prayers. Thyraeus says that, as collective hallucinations of sight are rare—all present not usually seeing the apparition—so audible phenomena are not always experienced by all persons present. In such cases, he thinks that the sights and sounds have no external cause, he regards the sights and sounds as delusions—caused by spirits. This is a difficult question. He mentions that we hear all the furniture being tossed about (as Sir Walter and Lady Scott heard it at Abbotsford; see Lockhart's *Life*, v. 311-315). Yet, on inspection, we find all the furniture in its proper place. There is abundant evidence to experience of this phenomenon, which remains as inexplicable as it was in the days of Thyraeus. When the sounds are heard, has the atmosphere vibrated, or has the impression only been made on "the inner ear"? In reply, Mr. Procter, who for sixteen years (1831-1847) endured the unexplained disturbances at Willington Mill, avers that the material objects on which the knocks appeared to be struck did certainly vibrate (see POLTERGEIST). Is then the felt vibration part of the hallucination?

As for visual phenomena, "ghosts," Thyraeus does not regard them as space-filling entities, but as hallucinations imposed by spirits on the human senses; the spirit, in each case, not being necessarily the soul of the dead man or woman whom the phantasm represents.

In the matter of alleged hauntings, the symptoms, the phenomena, to-day, are exactly the same as those recorded by Thyraeus. The belief in them is so far a living thing that it greatly lowers the letting value of a house when it is reported to be haunted. (An action for libelling a house as haunted was reported in the London newspapers of the 7th of March 1907). It is true that ancient family legends of haunts are gloried in by the inheritors of stately homes in England, or castles in Scotland, and to discredit the traditional ghost—in the days of Sir Walter Scott—was to come within measurable distance of a duel. But the time-honoured phantasms of old houses usually survive only in the memory of "the oldest aunt telling the saddest tale." Their historical basis can no more endure criticism than does the family portrait of Queen Mary,—signed by Medina about 1750-1770, and described by the family as "given to our ancestor by the Queen herself." After many years' experience of a baronial dwelling credited with seven distinct and separate phantasms, not one of which was ever seen by hosts, guests or domestics, scepticism as regards traditional ghosts is excusable. Legend reports that they punctually appear on the anniversaries of their misfortunes, but no evidence of such punctuality has been produced.

The Society for Psychical Research has investigated hundreds of cases of the alleged haunting of houses, and the reports are in the archives of the society. But, as the mere rumour of a haunt greatly lowers the value of a house, it is seldom possible to publish the names of the witnesses, and hardly ever permitted to publish the name of the house. From the point of view of science this is unfortunate (see *Proceedings S.P.R.* vol. viii. pp. 311-332 and *Proceedings* of 1882-1883, 1883-1884). As far as inquiry had any results, they were to the following effect. The spectres were of the most shy and fugitive kind, seen now by one person, now by another, crossing a room, walking along a corridor, and entering chambers in which, on inspection, they were not found. There was almost never any story to account for the appearances, as in magazine ghost-stories, and, if story there were, it lacked evidence. Recognitions of known dead persons were infrequent; occasionally there was recognition of a portrait in the house. The apparitions spoke in only one or two recorded cases, and, as a rule, seemed to have no motive for appearing.

The "ghost" resembles nothing so much as a somnambulist, or the dream-walk of one living person made visible, telepathically, to another living person. Almost the only sign of consciousness given by the appearances is their shyness; on being spoken to or approached they generally vanish. Not infrequently they are taken, at first sight, for living human beings. In darkness they are often luminous, otherwise they would be invisible. Unexplained noises often, but not always, occur in houses where these phenomena are perceived. Evidence is only good, approximately, when a series of persons, in the same house, behold the same appearance, without being aware that it has previously been seen by others. Naturally it is almost impossible to prove this ignorance.

When inquirers believe that the appearances are due to the agency of spirits of the dead, they usually suppose the method to be a telepathic impact on the mind of the living by some "mere automatic projection from a consciousness which has its centre elsewhere" (Myers, *Proceedings S.P.R.* vol. xv. p. 64). Myers, in *Human Personality*, fell back on "palaeolithic psychology," and a theory of a phantasmogenetic agency producing a phantasm which had some actual relation to space. But space forbids us to give examples of modern experiences in haunted houses, endured by persons sane, healthy and well educated. The cases, abundantly offered in *Proceedings S.P.R.*, suggest that certain localities, more than others, are "centres of permanent possibilities of being hallucinated in a manner more or less uniform." The causes of this fact (if causes there be, beyond a casual hallucination or illusion of A, which, when reported, begets by suggestion, or, when not reported, by telepathy, hallucinations in B, C, D and E), remain unknown (*Proceedings S.P.R.* vol. viii. p. 133 et seq.). Mr Podmore proposed this hypothesis of causation, which was not accepted by Myers; he thought that the theory laid too heavy a burden on telepathy and suggestion. Neither cause, nor any other cause of similar results, ever affects members of the S.P.R. who may be sent to dwell in haunted houses. They have no weird experiences, except when they are visionaries who see phantoms wherever they go. (A. L.)

HAUPT, MORITZ (1808-1874), German philologist, was born at Zittau, in Lusatia, on the 27th of July 1808. His early education was mainly conducted by his father, Ernst Friedrich Haupt, burgomaster of Zittau, a man of good scholarly attainment, who used to take pleasure in turning German hymns or Goethe's poems into Latin, and whose memoranda were employed by G. Freytag in the 4th volume of his *Bilder aus der deutschen Vergangenheit*. From the Zittau gymnasium, where he spent the five years 1821-1826, Haupt removed to the university of Leipzig with the intention of studying theology; but the natural bent of his mind and the influence of Professor G. Hermann soon turned all his energies in the direction of philosophy. On the close of his university course (1830) he returned to his father's house, and the next seven years were devoted to quiet work, not only at Greek, Latin and German, but at Old French, Provençal and Bohemian. He formed with Lachmann at Berlin a friendship which had great effect on his intellectual development. In September 1837 he "habilitated" at Leipzig as *Privatdozent*, and his first lectures, dealing with such diverse subjects as Catullus and the *Nibelungenlied*, indicated the twofold direction of his labours. A new chair of German language and literature being founded for his benefit, he became professor extraordinarius (1841) and then professor ordinarius (1843); and in 1842 he married Louise Hermann, the daughter of his master and colleague. But the peaceful and prosperous course opening out before him at the university of Leipzig was brought to a sudden close. Having taken part in 1849 with Otto Jahn and Theodor Mommsen in a political agitation for the maintenance of the imperial constitution, Haupt was deprived of his professorship by a decree of the 27th of April 1851. Two years later, however, he was called to succeed Lachmann at the university of Berlin; and at the same time the Berlin academy, which had made him a corresponding member in 1841, elected him an ordinary member. For twenty-one years he continued to hold a prominent

place among the scholars of the Prussian capital, making his presence felt, not only by the prestige of his erudition and the clearness of his intellect, but by the tirelessness of his energy and the ardent fearlessness of his temperament. He died, of heart disease, on the 5th of February 1874.

Haupt's critical work is distinguished by a happy union of the most painstaking investigation with intrepidity of conjecture, and while in his lectures and addresses he was frequently carried away by the excitement of the moment, and made sharp and questionable attacks on his opponents, in his writings he exhibits great self-control. The results of many of his researches are altogether lost, because he could not be prevailed upon to publish what fell much short of his own high ideal of excellence. To the progress of classical scholarship he contributed by *Quaestiones Catullianae* (1837), *Observationes criticae* (1841), and editions of Ovid's *Halvatica* and the *Cynegetica* of Gratius and Nemesianus (1838), of Catullus, Tibullus and Propertius (3rd ed., 1868), of Horace (3rd ed., 1871) and of Virgil (2nd ed., 1873). As early as 1836, with Hoffmann von Fallersleben, he started the *Alldeutsche Blätter*, which in 1841 gave place to the *Zeitschrift für deutsches Alterthum*, of which he continued editor till his death. Hartmann von Aue's *Erec* (1839) and his *Lieder, Buchlein und Der arme Heinrich* (1842), Rudolf von Embs's *Galer Gerhard* (1840) and Conrad von Würzburg's *Engelhard* (1844) are the principal German works which he edited. To form a collection of the French songs of the 16th century was one of his favourite schemes, but a little volume published after his death, *Französische Volkslieder* (1877), is the only monument of his labours in that direction. Three volumes of his *Opuscula* were published at Leipzig (1875-1877).

See Kirchhoff, "Gedächtnisrede," in *Abhandl. der Königl. Akad. der Wissenschaften zu Berlin* (1875); Otto Belger, *Moritz Haupt als Lehrer* (1879); Sandys, *Hist. Class. Schol.* iii. (1908).

HAUPTMANN, GERHART (1862-), German dramatist, was born on the 15th of November 1862 at Obersalsbrunn in Silesia, the son of an hotel-keeper. From the village school of his native place he passed to the Realschule in Breslau, and was then sent to learn agriculture on his uncle's farm at Jauer. Having, however, no taste for country life, he soon returned to Breslau and entered the art school, intending to become a sculptor. He then studied at Jena, and spent the greater part of the years 1883 and 1884 in Italy. In May 1885 Hauptmann married and settled in Berlin, and, devoting himself henceforth entirely to literary work, soon attained a great reputation as one of the chief representatives of the modern drama. In 1891 he retired to Schreiberhau in Silesia. Hauptmann's first drama, *Vor Sonnenaufgang* (1890) inaugurated the realistic movement in modern German literature; it was followed by *Das Friedensfest* (1890), *Einsame Menschen* (1891) and *Die Weber* (1892), a powerful drama depicting the rising of the Silesian weavers in 1844. Of Hauptmann's subsequent work mention may be made of the comedies *Kollege Crampton* (1892), *Der Biberpelz* (1893) and *Der rote Hahn* (1901), a "dream poem," *Hawnde* (1893), and an historical drama *Florian Geyer* (1895). He also wrote two tragedies of Silesian peasant life, *Fuhrmann Henschel* (1898) and *Rose Berndt* (1903), and the "dramatic fairy-tales" *Die versunkene Glocke* (1897) and *Und Pippa tanzt* (1905). Several of his works have been translated into English.

Biographies of Hauptmann and critical studies of his dramas have been published by A. Bartels (1897); P. Schlenker (1898); and U. C. Woerner (2nd ed., 1900). See also L. Benoist-Hanappier, *Le Drame naturaliste en Allemagne* (1905).

HAUPTMANN, MORITZ (1792-1868), German musical composer and writer, was born at Dresden, on the 13th of October 1792, and studied music under Scholz, Lanska, Grosse and Morlacchi, the rival of Weber. Afterwards he completed his education as a violinist and composer under Spohr, and till 1820 held various appointments in private families, varying his musical occupations with mathematical and other studies bearing chiefly on acoustics and kindred subjects. For a time also Hauptmann was employed as an architect, but all other pursuits gave place to music, and a grand tragic opera, *Mathilde*, belongs to the period just referred to. In 1822 he entered the orchestra of Cassel, again under Spohr's direction, and it was then that he first taught composition and musical theory to such men as Ferdinand David, Burgmüller, Kiel and others. His compositions at this time chiefly consisted of motets, masses, cantatas and songs. His opera *Mathilde* was performed at Cassel

with great success. In 1849 Hauptmann obtained the position of cantor at the Thomas-school of Leipzig (long previously occupied by the great Johann Sebastian Bach) together with that of professor at the conservatoire, and it was in this capacity that his unique gift as a teacher developed itself and was acknowledged by a crowd of enthusiastic and more or less distinguished pupils. He died on the 3rd of January 1868, and the universal regret felt at his death at Leipzig is said to have been all but equal to that caused by the loss of his friend Mendelssohn many years before. Hauptmann's compositions are marked by symmetry and perfection of workmanship rather than by spontaneous invention.

Amongst his vocal compositions—by far the most important portion of his work—may be mentioned two masses, choral songs for mixed voices (*Op.* 32, 47), and numerous part songs. The results of his scientific research were embodied in his book *Die Natur der Harmonik und Metrik* (1853), a standard work of its kind, in which a philosophic explanation of the forms of music is attempted.

HAURÉAU, (JEAN) BARTHÉLEMY (1812–1896), French historian and miscellaneous writer, was born in Paris. At the age of twenty he published a series of apologetic studies on the *Montagnards*. In later years he regretted the youthful enthusiasm of these papers, and endeavoured to destroy the copies. He joined the staff of the *National*, and was praised by Théophile Gautier as the "tribune" of romanticism. At that time he seemed to be destined to a political career, and, indeed, after the revolution of the 24th of February 1848 was elected member of the National Assembly; but close contact with revolutionary men and ideas gradually cooled his old ardour. Throughout his life he was an enemy to innovators, not only in politics and religion, but also in literature. This attitude sometimes led him to form unjust estimates, but only on very rare occasions, for his character was as just as his erudition was scrupulous. After the *coup d'état* he resigned his position as director of the MS. department of the Bibliothèque Nationale, to which he had been appointed in 1848, and he refused to accept any administrative post until after the fall of the empire. After having acted as director of the national printing press from 1870 to 1881, he retired, but in 1893 accepted the post of director of the Fondation Thiérs. He was also a member of the council of improvement of the *École des Chartes*. He died on the 29th of April 1896. For over half a century he was engaged in writing on the religious, philosophical, and more particularly the literary history of the middle ages. Appointed librarian of the town of Le Mans in 1838, he was first attracted by the history of Maine, and in 1843 published the first volume of his *Histoire littéraire du Maine* (4 vols., 1843–1852), which he subsequently recast on a new plan (10 vols., 1870–1877). In 1845 he brought out an edition of vol. ii. of G. Ménage's *Histoire de Sablé*. He then undertook the continuation of the *Gallia christiana*, and produced vol. xiv. (1856) for the province of Tours, vol. xv. (1862) for the province of Besançon, and vol. xvi. (1865–1870) for the province of Vienne. This important work gained him admission to the Académie des Inscriptions et Belles-Lettres (1862). In the *Notices et extraits des manuscrits* he inserted several papers which were afterwards published separately, with additions and corrections, under the title *Notices et extraits de quelques manuscrits de la Bibliothèque Nationale* (6 vols., 1890–1893). To the *Histoire littéraire de la France* he contributed a number of studies, among which must be mentioned that relating to the sermon-writers (vol. xxvi., 1873), whose works, being often anonymous, raise many problems of attribution, and, though deficient in originality of thought and style, reflect the very spirit of the middle ages. Among his other works mention must be made of his remarkable *Histoire de la philosophie scolastique* (1872–1880), extending from the time of Charlemagne to the 13th century, which was expanded from a paper crowned by the Académie des Sciences Morales et Politiques in 1850; *Les Mélanges poétiques d'Hilдебert de Lavardin* (1882); an edition of the *Works of Hugh of St Victor* (1886); a critical study of the Latin poems attributed to St Bernard (1890); and *Bernard Dilectus et l'inquisition albigeoise* (1877). To these must be added his contributions to the *Dictionnaire des sciences philosophiques*, Didot's *Biographie générale*, the *Biblio-*

thèque de l'École des Chartes, and the *Journal des savants*. From the time of his appointment to the Bibliothèque Nationale up to the last days of his life he was engaged in making abstracts of all the medieval Latin writings (many anonymous or of doubtful attribution) relating to philosophy, theology, grammar, canon law, and poetry, carefully noting on cards the first words of each passage. After his death this index of *incipits*, arranged alphabetically, was presented to the Académie des Inscriptions, and a copy was placed in the MS. department of the Bibliothèque Nationale.

See obituary notice read by Henri Wallon at a meeting of the Académie des Inscriptions on the 12th of November 1897; and the notice by Paul Meyer prefixed to vol. xxxiii. of the *Histoire littéraire de la France*.

HAUSA, sometimes incorrectly written HAUSSA, HOUSSA or HAOUSSA, a people inhabiting about half a million square miles in the western and central Sudan from the river Niger in the west to Bornu in the east. Heinrich Barth identifies them with the Atarantians of Herodotus. According to their own traditions the earliest home of the race was the divide between the Sokoto and Chad basins, and more particularly the eastern watershed, whence they spread gradually westward. In the middle ages, to which period the first authentic records refer, the Hausa, though never a conquering race, attained great political power. They were then divided into seven states known as "Hausa bokoy" ("the seven Hausa") and named Biram, Daura, Gober, Kano, Rano, Katsena and Zegzeg, after the sons of their legendary ancestor. This confederation extended its authority over many of the neighbouring countries, and remained paramount till the Fula under Sheikh Dan Fodio in 1810 conquered the Hausa states and founded the Fula empire of Sokoto (see FULA).

The Hausa, who number upwards of 5,000,000, form the most important nation of the central Sudan. They are undoubtedly nigritic, though in places with a strong crossing of Fula and Arab blood. Morally and intellectually they are, however, far superior to the typical Negro. They are a powerful, heavily built race, with skin as black as most Negroes, but with lips not so thick nor hair so woolly. They excel in physical strength. The average Hausa will carry on his head a load of ninety or a hundred pounds without showing the slightest signs of fatigue during a long day's march. When carrying their own goods it is by no means uncommon for them to take double this weight. They are a peaceful and industrious people, living partly in farmsteads amid their crops, partly in large trading centres such as Kano, Katsena and Yakoba (Bauchi). They are extremely intelligent and even cultured, and have exercised a civilizing effect upon their Fula conquerors to whose oppressive rule they submitted. They are excellent agriculturists, and, almost unaided by foreign influence, they have developed a variety of industries, such as the making of cloth, mats, leather and glass. In Sierra Leone and the Gold Coast territory they form the backbone of the military police, and under English leadership have again and again shown themselves to be admirable fighters and capable of a high degree of discipline and good conduct. Their food consists chiefly of guinea corn (*sorghum vulgare*), which is ground up and eaten as a sort of porridge mixed with large quantities of red pepper. The Hausa attribute their superiority in strength to the fact that they live on guinea corn instead of yams and bananas, which form the staple food of the tribes on the river Niger. The Hausa carried on agriculture chiefly by slave labour; they are themselves born traders, and as such are to be met with in almost every part of Africa north of the equator. Small colonies of them are to be found in towns as far distant from one another as Lagos, Tunis, Tripoli, Alexandria and Suakin.

Language.—The Hausa language has a wider range over Africa north of the equator, south of Barbary and west of the valley of the Nile, than any other tongue. It is a rich sonorous language, with a vocabulary containing perhaps 10,000 words. As an example of the richness of the vocabulary Bishop Crowther mentions that there are eight names for different parts of the day from cockcrow till after sunset. About a third of the words are connected with Arabic roots, nor are these such as the Hausa could well have borrowed in anything like recent times from the Arabs. Many words representing

ideas or things with which the Hausa must have been familiar from the very earliest time are obviously connected with Arabic or Semitic roots. There is a certain amount of resemblance between the Hausa language and that spoken by the Berbers to the south of Tripoli and Tunis. This language, again, has several striking points of resemblance with Coptic. If, as seems likely, the connexion between these three languages should be demonstrated, such connexion would serve to corroborate the Hausa tradition that their ancestors came from the very far east away beyond Mecca. The Hausa language has been reduced to writing for at least a century, possibly very much longer. It is the only language in tropical Africa which has been reduced to writing by the natives themselves, unless the Vai alphabet, introduced by a native inventor in the interior of Liberia in the first half of the 19th century be excepted; the character used is a modified form of Arabic. Some fragments of literature exist, consisting of political and religious poems, together with a limited amount of native history. A volume, consisting of history and poems reproduced in facsimile, with translations, has been published by the Cambridge University Press.

Religion.—About one-third of the people are professed Mahomedans, one-third are heathen, and the remainder have apparently no definite form of religion. Their Mahomedanism dates from the 14th century, but became more general when the Fula sheikh Dan Fodio initiated the religious war which ended in the founding of the Fula empire. Ever since then the ruler of Sokoto has been acknowledged as the religious head of the whole country, and tribute has been paid to him as such. The Hausa who profess Mahomedanism are extremely ignorant of their own faith, and what little religious fanaticism exists is chiefly confined to the Fula. Large numbers of the Hausa start every year on the pilgrimage to Mecca, travelling sometimes across the Sahara desert and by way of Tripoli and Alexandria, sometimes by way of Wadai, Darfur, Khartoum and Suakin. The journey often occupies five or six years, and is undertaken quite as much from trading as from religious motives. Mahomedanism is making very slow, if any, progress amongst the Hausa. The greatest obstacle to its general acceptance is the institution of the Ramadan fast. In a climate so hot as that of Hausaland, the obligation to abstain from food and drink from sunrise to sunset during one month in the year is a serious difficulty. Until the last decade of the 19th century no important attempt had been made to introduce Christianity, but the fact that the Hausa are fond of reading, and that native schools exist in all parts of the country, should greatly facilitate the work of Christian missionaries.

BIBLIOGRAPHY.—El Hage Abd Salam Shabeeny, *Account of Timbuctoo and Hausa Territories* (1820); Norris, *Dialogues and part of the New Testament in the English, Arabic, Hausa and Bornu Languages* (1853); Koelle, *Polyglotta Africana* (1854); Schön, *Grammar of the Hausa Language* (London, 1862), *Hausa Reading Book* (1877), and also *A Dictionary of the Hausa Language* (1877). Schön has also produced Hausa translations of Gen. (1858), Matt. (1857) and Luke (1858). Heinrich Barth, *Travels in North and Central Africa* (2 vols., London, 1857); *Central-afrikanische Vocabularien* (Gotha, 1867); C. H. Robinson, *Hausaland, or Fifteen Hundred Miles through the Central Soudan* (1865); *Specimens of Hausa Literature* (1865); *Hausa Grammar* (1867); *Hausa Dictionary* (1869); P. L. Monteil, *De St-Louis à Tripoli par le lac Tchad* (Paris, 1895); Lt. Seymour Vandeleur, *Campaigning on the Upper Nile and Niger* (1898).

HAUSER, KASPAR, a German youth whose life was remarkable from the circumstances of apparently inexplicable mystery in which it was involved. He appeared on the 26th of May 1828, in the streets of Nuremberg, dressed in the garb of a peasant, and with such a helpless and bewildered air that he attracted the attention of the passers-by. In his possession was found a letter purporting to be written by a poor labourer, stating that the boy was given into his custody on the 7th of October 1812, and that according to agreement he had instructed him in reading, writing, and the Christian religion, but that up to the time fixed for relinquishing his custody he had kept him in close confinement. Along with this letter was enclosed another purporting to be written by the boy's mother, stating that he was born on the 30th of April 1812, that his name was Kaspar, and that his father, formerly a cavalry officer in the 6th regiment at Nuremberg, was dead. The appearance, bearing, and professions of the youth corresponded closely with these credentials. He showed a repugnance to all nourishment except bread and water, was seemingly ignorant of outward objects, wrote his name as Kaspar Hauser, and said that he wished to be a cavalry officer like his father. For some time he was detained in prison at Nuremberg as a vagrant, but on the 18th of July 1828 he was delivered over by the town authorities to the care of a schoolmaster, Professor Daumer, who undertook to be his guardian and to take the charge of his education. Further mysteries

accumulated about Kaspar's personality and conduct, not altogether unconnected with the vogue in Germany, at that time, of "animal magnetism," "somnambulism," and similar theories of the occult and strange. People associated him with all sorts of possibilities. On the 17th of October 1829 he was found to have received a wound in the forehead, which, according to his own statement, had been inflicted on him by a man with a blackened face. Having on this account been removed to the house of a magistrate and placed under close surveillance, he was visited by Earl Stanhope, who became so interested in his history that he sent him in 1832 to Ansbach to be educated under a certain Dr Meyer. After this he became clerk in the office of Paul John Anselm von Feuerbach, president of the court of appeal, who had begun to pay attention to his case in 1828; and his strange history was almost forgotten by the public when the interest in it was suddenly revived by his receiving a deep wound on his left breast, on the 14th of December 1833, and dying from it three or four days afterwards. He affirmed that the wound was inflicted by a stranger, but many believed it to be the work of his own hand, and that he did not intend it to be fatal, but only so severe as to give a sufficient colouring of truth to his story. The affair created a great sensation, and produced a long literary agitation. But the whole story remains somewhat mysterious. Lord Stanhope eventually became decidedly sceptical as to Kaspar's stories, and ended by being accused of contriving his death!

In 1830 a pamphlet was published at Berlin, entitled *Kaspar Hauser nicht unwahrscheinlich ein Betrüger*; but the truthfulness of his statements was defended by Daumer, who published *Mitteilungen über Kaspar Hauser* (Nuremberg, 1832), and *Entküllungen über Kaspar Hauser* (Frankfurt, 1859); as well as *Kaspar Hauser, sein Wesen, seine Unschuld, &c.* (Regensburg, 1873), in answer to Meyer's (a son of Kaspar's tutor) *Authentische Mitteilungen über Kaspar Hauser* (Ansbach, 1872). Feuerbach awakened considerable psychological interest in the case by his pamphlet *Kaspar Hauser, Beispiel eines Verbrechens am Seelenleben* (Ansbach, 1832), and Earl Stanhope also took part in the discussion by publishing *Materialien zur Geschichte K. Hausers* (Heidelberg, 1836). The theory of Daumer and Feuerbach and other pamphleteers (finally presented in 1892 by Miss Elizabeth E. Evans in her *Story of Kaspar Hauser from Authentic Records*) was that the youth was the crown prince of Baden, the legitimate son of the grand-duke Charles of Baden, and that he had been kidnapped at Karlsruhe in October 1812 by minions of the countess of Hochberg (morganatic wife of the grand-duke) in order to secure the succession to her offspring; but this theory was answered in 1875 by the publication in the *Augsburg Allgemeine Zeitung* of the official record of the baptism, post-mortem examination and burial of the heir supposed to have been kidnapped. See *Kaspar Hauser und sein badisches Prinzenthum* (Heidelberg, 1876). In 1883 the story was again revived in a Regensburg pamphlet attacking, among other people, Dr Meyer; and the sons of the latter, who was dead, brought an action for libel, under the German law, to which no defence was made; all the copies of the pamphlet were ordered to be destroyed. The evidence has been subtly analyzed by Andrew Lang in his *Historical Mysteries* (1904), with results unfavourable to the "romantic" version of the story. Lang's view is that possibly Kaspar was a sort of "ambulatory automatist," an instance of a phenomenon, known by other cases to students of psychical abnormalities, of which the characteristics are a mania for straying away and the persistence of delusions as to identity; but he inclines to regard Kaspar as simply a "humbug." The "authentic records" purporting to confirm the kidnapping story Lang stigmatizes as worthless and impudent rubbish." The evidence is in any case in complete confusion.

HAUSMANN, JOHANN FRIEDRICH LUDWIG (1782-1859), German mineralogist, was born at Hanover on the 22nd of February 1782. He was educated at Göttingen, where he obtained the degree of Ph.D. After making a geological tour in Denmark, Norway and Sweden in 1807, he was two years later placed at the head of a government mining establishment in Westphalia, and he established a school of mines at Clausthal in the Harz mountains. In 1811 he was appointed professor of geology and mining, and afterwards of geology and mineralogy in the university of Göttingen, and this chair he occupied until a short time before his death. He was also for many years secretary of the Royal Academy of Sciences of Göttingen. He published observations on geology and mineralogy in Spain and Italy as well as in central and northern Europe: he wrote on gypsum, pyrites, felspar, tachylite, cordierite and on some eruptive

rocks, and he devoted much attention to the crystals developed during metallurgical processes. He died at Hanover on the 26th of December 1839.

PUBLICATIONS—*Grundlinien einer Encyclopädie der Bergwerkswissenschaften* (1811); *Reise durch Skandinavien* (5 vols., 1811-1818); *Handbuch der Mineralogie* (3 vols., 1813, 2nd ed., 1828-1847).

HAUSRATH, ADOLPH (1837-1909), German theologian, was born at Karlsruhe on the 13th of January 1837 and was educated at Jena, Göttingen, Berlin and Heidelberg, where he became *Privatdozent* in 1861, professor extraordinary in 1867 and ordinary professor in 1872. He was a disciple of the Tübingen school and a strong Protestant. Among other works he wrote *Der Apostel Paulus* (1865), *Neutestamentliche Zeitgeschichte* (1868-1873, 4 vols.; Eng. trans.), *D. F. Strauss und die Theologie seiner Zeit* (1876-1878, 2 vols.), and lives of *Richard Rothe* (2 vols., 1902), and *Luther* (1904). His scholarship was sound and his style vigorous. Under the pseudonym George Taylor he wrote several historical romances, especially *Antinous* (1880), which quickly ran through five editions, and is the story of a soul "which courted death because the objective restraints of faith had been lost." *Klytia* (1883) was a 16th-century story, *Jetta* (1884) a tale of the great immigrations, and *Elfriede* "a romance of the Rhine." He died on the 2nd of August 1909.

HÄUSSER, LUDWIG (1818-1867), German historian, was born at Kleeburg, in Alsace. Studying philology at Heidelberg in 1835, he was led by F. C. Schlosser to give it up for history, and after continuing his historical work at Jena and teaching in the gymnasium at Wertheim he made his mark by his *Die deutschen Geschichtsschreiber vom Anfang des Frankeneiches bis auf die Hohenstaufen* (1839). Next year appeared his *Sage von Tell*. After a short period of study in Paris on the French Revolution, he spent some time working in the archives of Baden and Bavaria, and published in 1845 *Die Geschichte der rheinischen Pfalz*, which won for him a professorship *extraordinarius* at Heidelberg. In 1850 he became *professor ordinarius*. Häusser also interested himself in politics while at Heidelberg, publishing in 1846 *Schleswig-Holstein, Dänemark und Deutschland*, and editing with Gervinus the *Deutsche Zeitung*. In 1848 he was elected to the lower legislative chamber of Baden, and in 1850 advocated the project of union with Prussia at the parliament held at Erfurt. Another timely work was his edition of Friedrich List's *Gesammelte Schriften* (1850), accompanied with a life of the author. His greatest achievement, and the one on which his fame as an historian rests, is his *Deutsche Geschichte vom Tode Friedrichs des Grossen bis zur Gründung des deutschen Bundes* (Leipzig, 1854-1857, 4 vols.). This was the first work covering that period based on a scientific study of the archival sources. In 1859 he again took part in politics, resuming his place in the lower chamber, opposing in 1863 the project of Austria for the reform of the Confederation brought forward in the assembly of princes at Frankfurt, in his book *Die Reform des deutschen Bundestages*, and becoming one of the leaders of the "little German" (*kleindeutsche*) party, which advocated the exclusion of Austria from Germany. In addition to various essays (in his *Gesammelte Schriften*, Berlin, 1869-1870, 2 vols.), Häusser's lectures have been edited by W. Oncken in the *Geschichte des Zeitalters der Reformation* (1869, 2nd ed. 1880), and *Geschichte der französischen Revolution* (1869, 2nd ed. 1870). These lectures reveal all the charm of style and directness of presentation which made Häusser's work as a professor so vital.

See W. Wattenbach, *Lud. Häusser, ein Vortrag* (Heidelberg, 1867).

HAUSSMANN, GEORGES EUGÈNE, BARON (1809-1891), whose name is associated with the rebuilding of Paris, was born in that city on the 27th of March 1809 of a Protestant family, German in origin. He was educated at the Collège Henri IV, and subsequently studied law, attending simultaneously the classes at the Paris conservatoire of music, for he was a good musician. He became *sous-préfet* of Nérac in 1830, and advanced rapidly in the civil service until in 1853 he was chosen by Persigny *prefect* of the Seine in succession to Jean Jacques Berger, who hesitated to incur the vast expenses of the imperial schemes

for the embellishment of Paris. Haussmann laid out the Bois de Boulogne, and made extensive improvements in the smaller parks. The gardens of the Luxembourg Palace were cut down to allow of the formation of new streets, and the Boulevard de Sebastopol, the southern half of which is now the Boulevard St Michel, was driven through a populous district. A new water supply, a gigantic system of sewers, new bridges, the opera, and other public buildings, the inclusion of outlying districts—these were among the new *prefect's* achievements, accomplished by the aid of a bold handling of the public funds which called forth Jules Ferry's indictment, *Les Complexes fantastiques de Haussmann*, in 1867. A loan of 250 million francs was sanctioned for the city of Paris in 1865, and another of 260 million in 1869. These sums represented only part of his financial schemes, which led to his dismissal by the government of Émile Ollivier. After the fall of the Empire he spent about a year abroad, but he re-entered public life in 1877, when he became Bonapartist deputy for Ajaccio. He died in Paris on the 11th of January 1891. Haussmann had been made senator in 1857, member of the Academy of Fine Arts in 1867, and grand cross of the Legion of Honour in 1862. His name is preserved in the Boulevard Haussmann. His later years were occupied with the preparation of his *Mémoires* (3 vols., 1890-1893).

HAUSSONVILLE, JOSEPH OTHENIN BERNARD DE CLÉRON, COMTE D' (1809-1884), French politician and historian, was born in Paris on the 27th of May 1809. His grandfather had been "grand loupvetier" of France; his father Charles Louis Bernard de Cléron, comte d'Haussonville (1770-1846), was chamberlain at the court of Napoleon, a count of the French empire, and under the Restoration a peer of France and an opponent of the Villèle ministry. Comte Joseph had filled a series of diplomatic appointments at Brussels, Turin and Naples before he entered the chamber of deputies in 1842 for Provins. Under the Second Empire he published a liberal anti-imperial paper at Brussels, *Le Bulletin français*, and in 1863 he actively supported the candidature of Prévost Paradol. He was elected to the French Academy in 1869, in recognition of his historical writings, *Histoire de la politique extérieure du gouvernement français de 1830 à 1848* (2 vols., 1850), *Histoire de la réunion de la Lorraine à la France* (4 vols., 1854-1859), *L'Église romaine et le premier empire 1800-1814* (5 vols., 1864-1879). In 1870 he published a pamphlet directed against the Prussian treatment of France, *La France et la Prusse devant l'Europe*, the sale of which was prohibited in Belgium at the request of King William of Prussia. He was the president of an association formed to provide new homes in Algeria for the inhabitants of Alsace-Lorraine who elected to retain their French nationality. In 1878 he was made a life-senator, in which capacity he allied himself with the Right Centre in defence of the religious associations against the anti-clericals. He died in Paris on the 28th of May 1884.

His wife Louise (1818-1882), a daughter of Duc Victor de Broglie, published in 1858 a novel *Robert Emmet*, followed by *Marguerite de Valois reine de Navarre* (1870), *La Jeunesse de Lord Byron* (1872), and *Les Dernières Amées de Lord Byron* (1874).

His son, GABRIEL PAUL OTHENIN DE CLÉRON, comte d'Haussonville, was born at Gurcy de Châtel (Seine-et-Marne) on the 21st of September 1843, and married in 1865 Mlle Pauline d'Harcourt. He represented Seine-et-Marne in the National Assembly (1871) and voted with the Right Centre. Though he was not elected to the chamber of deputies he became the right-hand man of his maternal uncle, the duc de Broglie, in the attempted *coup* of the 16th of May. His *Établissements pénitentiaires en France et aux colonies* (1875) was crowned by the Academy, of which he was admitted a member in 1888. In 1891 the resignation of Henri Édouard Bocher from the administration of the Orleans estates led to the appointment of M d'Haussonville as accredited representative of the comte de Paris in France. He at once set to work to strengthen the Orleanist party by recruiting from the smaller nobility the officials of the local monarchical committees. He established

new Orleanist organs, and sent out lecturers with instructions to emphasize the modern and democratic principles of the comte de Paris; but the prospects of the party were dashed in 1894 by the death of the comte de Paris. In 1904 he was admitted to the Academy of Moral and Political Science. The comte d'Haussonville published:—*C. A. Sainte-Beuve, sa vie et ses œuvres* (1875), *Études biographiques et littéraires*, 2 series (1879 and 1883), *Le Salon de Mme Necker* (1882, 2 vols.), *Madame de La Fayette* (1891), *Madame Achermann* (1892), *Le Comte de Paris, souvenirs personnels* (1895), *La Duchesse de Bourgogne et l'alliance savoyarde* (1898-1903), *Salaires et misères de femme* (1900), and, with G. Hanotaux, *Souvenirs sur Madame de Maintenon* (3 vols., 1902-1904).

HAUTE-GARONNE, a frontier department of south-western France, formed in 1790 from portions of the provinces of Languedoc (Toulousain and Lauraguais) and Gascony (Comminges and Nébouzan). Pop. (1906), 442,065. Area, 2458 sq. m. It is bounded N. by the department of Tarn-et-Garonne, E. by Tarn, Aude and Ariège, S. by Spain and W. by Gers and Hautes-Pyrénées. Long and narrow in shape, the department consists in the north of an undulating stretch of country with continual interchange of hill and valley nowhere thrown into striking relief; while towards the south the land rises gradually to the Pyrenees, which on the Spanish border attain heights of upwards of 10,000 ft. Two passes, the Port d'Oo, near the beautiful lake and waterfall of Oo, and the Port de Vénasque, exceed 9800 and 7900 ft. in altitude respectively. Entering the department in the south-east, the Garonne flows in a northerly direction and traverses almost its entire length, receiving in its course the Pique, the Salat, the Louge, the Ariège, the Touch and the Save. Except in the mountainous region the climate is mild, the mean annual temperature being rather higher than that of Paris. The rainfall, which averages 24 in. at Toulouse, exceeds 40 in. in some parts of the mountains; and sudden and destructive inundations of the Garonne—of which that of 1875 is a celebrated example—are always to be feared. The valley of the Garonne is also frequently visited by severe hail-storms. Thick forests of oak, fir and pine exist in the mountains and furnish timber for shipbuilding. The arable land of the plains and valleys is well adapted for the cultivation of wheat, maize and other grain crops; and the produce of cereals is generally much more than is required for the local consumption. Market-gardening flourishes around Toulouse. A large area is occupied by vineyards, though the wine is only of medium quality; and chestnuts, apples and peaches are grown. As pasture land is abundant a good deal of attention is given to the rearing of cattle and sheep, and co-operative dairies are numerous in the mountains; but deforestation has tended to reduce the area of pasture-land, because the soil, unrestrained by the roots of trees, has been gradually washed away. Haute-Garonne has deposits of zinc and lead, and salt-workings; there is an ancient and active marble-working industry at St Bât. Mineral springs are common, those of Bagnères-de-Luchon Encausse, Barbazan and Salies-du-Salat being well known. The manufactures are various though not individually extensive, and include iron and copper goods, woollen, cotton and linen goods, leather, paper, boots and shoes, tobacco and table delicacies. Flour-mills, iron-works and brick-works are numerous. Railway communication is furnished by the Southern and the Orléans railways, the main line of the former from Bordeaux to Cette passing through Toulouse. The Canal du Midi traverses the department for 32 m. and the lateral canal of the Garonne for 15 m. The Garonne is navigable below its confluence with the Salat. There are four arrondissements—Toulouse, Villefranche, Muret and St Gaudens, subdivided into 39 cantons and 588 communes. The chief town is Toulouse, which is the seat of a court of appeal and of an archbishop, the headquarters of the XVIIth army corps and the centre of an academy; and St Gaudens, Bagnères-de-Luchon and, from an architectural and historical standpoint, St Bertrand-de-Comminges are of importance and receive separate treatment. Other places of interest are St Avenin, Montsaunès and Vénéque, which possess ancient churches in the Romanesque style. The

church of St Just at Valcabrère is of still greater age, the choir dating from the 8th or 9th century and part of the nave from the 11th century. There are ruins of a celebrated Cistercian abbey at Bonnefont near St Martory. Gallo-Roman remains and works of art have been discovered at Martres. Near Revel is the fine reservoir of St Ferréol, constructed for the canal du Midi in the 17th century.

HAUTE-LOIRE, a department of central France, formed in 1790 of Velay and portions of Vivarais and Gévaudan, three districts formerly belonging to the old province of Languedoc, of a portion of Forez formerly belonging to Lyonnais, and a portion of lower Auvergne. Pop. (1906), 314,770. Area, 1931 sq. m. It is bounded N. by Puy-de-Dôme and Loire, E. by Loire and Ardèche, S. by Ardèche and Lozère and W. by Lozère and Cantal. Haute-Loire, which is situated on the central plateau of France, is traversed from north to south by four mountain ranges. Its highest point, the Mont Mézenc (5755 ft.), in the south-east of the department, belongs to the mountains of Vivarais, which are continued along the eastern border by the Boutières chain. The Lignon divides the Boutières from the Massif du Mégal, which is separated by the Loire itself from the mountains of Velay, a granitic range overlaid with the eruptions of more than one hundred and fifty craters. The Margeride mountains run along the western border of the department. The Loire enters the department at a point 16 m. distant from its source in Ardèche, and first flowing northwards and then north-east, waters its eastern half. The Allier, which joins the Loire at Nevers, traverses the western portion of Haute-Loire in a northerly direction. The chief affluents of the Loire within the limits of the department are the Borne on the left, joining it near Le Puy, and the Lignon, which descends from the Mézenc, between the Boutières and Mégal ranges, on the right. The climate, owing to the altitude, the northward direction of the valleys, and the winds from the Cévennes, is cold, the winters being long and rigorous. Storms and violent rains are frequent on the higher grounds, and would give rise to serious inundations were not the rivers for the most part confined within deep rocky channels. Cereals, chiefly rye, oats, barley and wheat, are cultivated in the lowlands and on the plateaus, on which aromatic and medicinal plants are abundant. Lentils, peas, mangel-wurzels and other forage and potatoes are also grown. Horned cattle belong principally to the Mézenc breed; goats are numerous. The woods yield pine, fir, oak and beech. Lace-making, which employs about 90,000 women, and coal-mining are main industries; the coal basins are those of Brassac and Langeac. There are also mines of antimony and stone-quarries. Silk-milling, caoutchouc-making, various kinds of smith's work, paper-making, glass-blowing, brewing, wood-sawing and flour-milling are also carried on. The principal imports are flour, brandy, wine, live-stock, lace-thread and agricultural implements. Exports include fat stock, wool, aromatic plants, coal, lace. The department is served chiefly by the Paris-Lyon-Méditerranée company. There are three arrondissements—Le Puy, Brioude and Yssingeaux, with 28 cantons and 265 communes.

Haute-Loire forms the diocese of Le Puy and part of the ecclesiastical province of Bourges, and belongs to the académie (educational division) of Clermont-Ferrand. Its court of appeal is at Riom. Le Puy the capital, Brioude and La Chaise-Dieu the principal towns of the department, receive separate treatment. It has some notable churches, of which those of Chamalières, St Paulien and Sainte-Marie-des-Chazes are Romanesque in style; Le Monastier preserves the church, in part Romanesque, and the buildings of the abbey to which it owes its origin. Arlempdes and Bouzols (near Coubon) have the ruins of large feudal châteaux. The rocky plateau overlooking Polignac is occupied by the ruins of the imposing stronghold of the ancient family of Polignac, including a square donjon of the 14th century. Interesting Gallo-Roman remains have been found on the site.

HAUTE-MARNE, a department of north-eastern France, made up for the most part of districts belonging to the former province of Champagne (Bassigny, Perthois, Vallage), with smaller portions of Lorraine and Burgundy, and some fragments of

Franche-Comté. Area, 2415 sq. m. Pop. (1906), 221,724. It is bounded N.E. by Meuse, E. by Vosges, S.E. by Haute-Saône, S. and S.W. by Côte d'Or, W. by Aube, and N.W. by Marne. Its greatest elevation (1693 ft.) is in the plateau of Langres in the south between the sources of the Marne and those of the Aube; the watershed between the basin of the Rhone on the south and those of the Seine and Meuse on the north, which is formed by the plateau of Langres continued north-east by the Monts Faucilles, has an average height of 1500 or 1600 ft. The country descends rapidly towards the south, but in very gentle slopes northwards. To the north is Bassigny (the *paybas* or low country, as distinguished from the highlands), a district characterized by monotonous flats of little fertility and extensive wooded tracts. The lowest level of the department is 361 ft. Hydrographically Haute-Marne belongs for the most part to the basin of the Seine, the remainder to those of the Rhone and the Meuse. The principal river is the Marne, which rises here, and has a course of 75 m. within the department. Among its more important affluents are, on the right the Rognon, and on the left the Blaise. The Saulx, another tributary of the Marne on the right, also rises in Haute-Marne. Westward the department is watered by the Aube and its tributary the Aujon, both of which have their sources on the plateau of Langres. The Meuse also rises in the Monts Faucilles, and has a course of 31 m. within the department. On the Mediterranean side the department sends to the Saône the Apance, the Amance, the Salon and the Vingeanne. The climate is partly that of the Seine region, partly that of the Vosges, and partly that of the Rhone; the mean temperature is 51° F., nearly that of Paris; the rainfall is slightly below the average for France.

The agriculture of the department is carried on chiefly by small proprietors. The chief crops are wheat and oats, which are more than sufficient for the needs of the inhabitants; potatoes, lucerne and mangel wurzels are next in importance. Natural pasture is abundant, especially in Bassigny, where horse and cattle-raising flourish. The vineyards produce some fair wines, notably the white wine of Soyers. More than a quarter of the territory is under wood. The department is rich in iron and building and other varieties of stone are quarried. The warm springs of Bourbonne-les-Bains are among the earliest known and most frequented in France. The leading industry is the metallurgical; its establishments include blast furnaces, foundries, forges, plate-rolling works, and shops for nailmaking and smith's work of various descriptions. St Dizier is the chief centre of manufacture and distribution. The cutlery trade occupies thousands of hands at Nogent-en-Bassigny and in the neighbourhood of Langres. Val d'Ogne is well known for its production of fountains, statues, &c., in metal-work. Flour-milling, glove-making (at Chaumont), basket-making, brewing, tanning and other industries are also carried on. The principal import is coal, while manufactured goods, iron, stone, wood and cereals are exported. The department is served by the Eastern railway, of which the line from Paris to Belfort passes through Chaumont and Langres. The canal from the Marne to the Saône and the canal of the Haute-Marne, which accompany the Marne, together cover 99 m.; there is a canal 14 m. long from St Dizier to Wassy. There are three arrondissements (Chaumont, Langres and Wassy), with 28 cantons and 550 communes. Chaumont is the capital. The department forms the diocese of Langres; it belongs to the VII. military region and to the educational circumscription (académie) of Dijon, where also is its court of appeal. The principal towns—Chaumont, Langres, St Dizier and Bourbonne-les-Bains—receive separate notice. At Montier-en-Der the remains of an abbey founded in the 7th century include a fine church with nave and aisles of the 10th, and choir of the 13th century. Wassy, the scene in 1562 of the celebrated massacre of Protestants by the troops of Francis, duke of Guise, has among its old buildings a church much of which dates from the Romanesque period. Vignory has a church of the 11th century. Joinville, a metallurgical centre, preserves a château of the dukes of Guise in the Renaissance style. Pailly, near Langres, has a fine château of the last half of the 16th century.

HAUTERIVE, ALEXANDRE MAURICE BLANC DE LANAUTTE, COMTE D' (1754-1830), French statesman and diplomatist, was born at Aspres (Hautes-Alpes) on the 14th of April 1754, and was educated at Grenoble, where he became a professor. Later he held a similar position at Tours, and there he attracted the attention of the duc de Choiseul, who invited him to visit him at Chanteloup. Hauterive thus came in contact with the great men who visited the duke, and one of these, the comte de Choiseul-Goiffier, on his appointment as ambassadeur to Constantinople in 1784 took him with him. Hauterive was enriched for a time by his marriage with a widow, Madame de Marchais, but was ruined by the Revolution. In 1790 he applied for and received the post of consul at New York. Under the Consulate, however, he was accused of embezzlement and recalled; and, though the charge was proved to be false, was not reinstated. In 1798, after trying his hand at farming in America, Hauterive was appointed to a post in the French foreign office. In this capacity he made a sensation by his *L'Etat de la France à la fin de l'an VIII* (1800), which he had been commissioned by Bonaparte to draw up, as a manifesto to foreign nations, after the *coup d'Etat* of the 18th Brumaire. This won him the confidence of Bonaparte, and he was henceforth employed in drawing up many of the more important documents. In 1805 he was made a councillor of state and member of the Legion of Honour, and between 1805 and 1813 he was more than once temporarily minister of foreign affairs. He attempted, though vainly, to use his influence to moderate Napoleon's policy, especially in the matter of Spain and the treatment of the pope. In 1805 a difference of opinion with Talleyrand on the question of the Austrian alliance, which Hauterive favoured, led to his withdrawal from the political side of the ministry of foreign affairs, and he was appointed keeper of the archives of the same department. In this capacity he did very useful work, and after the Restoration continued in this post at the request of the duc de Richelieu, his work being recognized by his election as a member of the Académie des Inscriptions et Belles-Lettres in 1820. He died at Paris on the 28th of July 1830.

There is a detailed account of Hauterive, with considerable extracts from his correspondence with Talleyrand, in the *Biographie universelle* by A. F. Artand de Montor, who published a separate life in 1831. Criticisms of his *Etat de la France* appeared in Germany and England by F. von Gentz (*Von dem politischen Zustande*, 1801), and by T. B. Clarke (*A Hist. and Pol. View* . . . 1803).

HAUTES ALPES, a department in S.E. France, formed in 1790 out of the south-eastern portion of the old province of Dauphiné, together with a small part of N. Provence. It is bounded N. by the department of Savoie, E. by Italy and the department of the Basses Alpes, S. by the last-named department and that of the Drôme, and W. by the departments of the Drôme and of the Isère. Its area is 2178 sq. m., its greatest length is 85 m. and its greatest breadth 62 m. It is very mountainous, and includes the Pointe des Ecrins (13,462 ft.), the loftiest summit in France before the annexation of Savoy in 1860, as well as the Meije (13,081 ft.), the Ailefroide (12,989 ft.) and the Mont Pelvoux (12,973 ft.), though Monte Viso (12,609 ft.) is wholly in Italy, rising just over the border. The department is to a large extent made up of the basins of the upper Durance (with its tributaries, the Guisane, the Gyrone and the Gull), of the upper Drac and of the Buëch—all being to a very large extent wild mountain torrents in their upper course. The department is divided into three arrondissements (Gap, Briançon and Embrun), 24 cantons and 186 communes. In 1906 its population was 107,498. It is a very poor department owing to its great elevation above the sea-level. There are no industries of any extent, and its commerce is almost wholly of local importance. The prolonged winter greatly hinders agricultural development, while the pastoral region has been greatly damaged and the forests destroyed by the ravages of the Provençal sheep, vast flocks of which are driven up here in the summer, as the pastures are leased out to a large extent, and but little utilized by the inhabitants. It now forms the diocese of Gap (this see is first certainly mentioned in the 6th century), which is in the ecclesiastical province of Aix en Provence; in 1791 there was annexed

to it the archiepiscopal see of Embrun, which was then suppressed. There are 114 m. of railway in the department. This includes the main line from Briançon past Gap towards Grenoble. About 16½ m. W. of Gap is the important railway junction of Veynes, whence branch off the lines to Grenoble, to Valence by Die and Livron, and to Sisteron for Marseilles. The chief town is Gap, while Briançon and Embrun are the only other important places.

See J. Roman, *Dictionnaire topographique du dép. des Htes-Alpes* (Paris, 1884), *Tableau historique du dép. des Htes-Alpes* (Paris, 1887-1890, 2 vols.), and *Répertoire archéologique du dép. des Htes-Alpes* (Paris, 1888); J. C. F. Ladoucette, *Histoire, topographie, &c., des Hautes-Alpes* (3rd ed., Paris, 1848). (W. A. B. C.)

HAUTE-SAÔNE, a department of eastern France, formed in 1790 from the northern portion of Franche Comté. It is traversed by the river Saône, bounded N. by the department of the Vosges, E. by the territory of Belfort, S. by Doubs and Jura, and W. by Côte-d'Or and Haute-Marne. Pop. (1906), 263,890; area, 2075 sq. m. On the north-east, where they are formed by the Vosges, and to the south along the course of the Ognon the limits are natural. The highest point of the department is the Ballon de Servance (3970 ft.), and the lowest the confluence of the Saône and Ognon (610 ft.). The general slope is from north-east to south-west, the direction followed by those two streams. In the north-east the department belongs to the Vosgian formation, consisting of forest-clad mountains of sandstone and granite, and is of a marshy nature; but throughout the greater part of its extent it is composed of limestone plateaus 800 to 1000 ft. high pierced with crevasses and subterranean caves, into which the rain water disappears to issue again as springs in the valleys 200 ft. lower down. In its passage through the department the Saône receives from the right the Amance and the Salon from the Langres plateau, and from the left the Coney, the Lanterne (augmented by the Breuchin which passes by Luxeuil), the Durgeon (passing Vesoul), and the Ognon. The north-eastern districts are cold and have an annual rainfall ranging from 36 to 48 in. Towards the south-west the climate becomes more temperate. At Vesoul and Gray the rainfall only reaches 24 in. per annum.

Haute-Saône is primarily agricultural. Of its total area nearly half is arable land; wheat, oats, meslin and rye are the chief cereals and potatoes are largely grown. The vine flourishes mainly in the arrondissement of Gray. Apples, plums and cherries (from which the kirsch, for which the department is famous, is distilled) are the chief fruits. The woods which cover a quarter of the department are composed mainly of firs in the Vosges and of oak, beech, hornbeam and aspen in the other districts. The river-valleys furnish good pasture for the rearing of horses and of horned cattle. The department possesses mines of coal (at Ronchamp) and rock-salt (at Couhenans) and stone quarries are worked. Of the many mineral waters of Haute-Saône the best known are the hot springs of Luxeuil (*q.v.*). Besides iron-working establishments (smelting furnaces, foundries and wire-drawing mills), Haute-Saône possesses copper-foundries, engineering works, steel-foundries and factories at Plancher-les-Mines and elsewhere for producing ironmongery, nails, pins, files, saws, screws, shot, chains, agricultural implements, locks, spinning machinery, edge tools. Window-glass and glass wares, pottery and earthenware are manufactured; there are also brick and tile-works. The spinning and weaving of cotton, of which Héricourt (pop. in 1906, 5194) is the chief centre, stand next in importance to metal working, and there are numerous paper-mills. Print-works, fulling mills, hosiery factories and straw-hat factories are also of some account; as well as sugar works, distilleries, dye-works, saw-mills, starch-works, the chemical works at Couhenans, oil-mills, tanyards and flour-mills. The department exports wheat, cattle, cheese, butter, iron, wood, pottery, kirschwasser, plaster, leather, glass, &c. The Saône provides a navigable channel of about 70 m., which is connected with the Moselle and the Meuse at Corre by the Canal de l'Est along the valley of the Coney. Gray is the chief emporium of the water-borne trade of the Saône. Haute-Saône

is served chiefly by the Eastern railway. There are three arrondissements—Vesoul, Gray, Lure—comprising 38 cantons, 583 communes. Haute-Saône is in the district of the VII. army corps, and in its legal, ecclesiastical and educational relations depends on Besançon.

Vesoul, the capital of the department, Gray and Luxeuil are the principal towns. There is an important school of agriculture at St Rémy in the arrondissement of Vesoul. The Roman ruins and mosaics at Membrey in the arrondissement of Gray and the church (13th and 15th centuries) and abbey buildings at Faverney, in the arrondissement of Vesoul, are of antiquarian interest.

HAUTE-SAVOIE, a frontier department of France, formed in 1860 of the old provinces of the Genevois, the Chablais and the Faucigny, which constituted the northern portion of the duchy of Savoy. It is bounded N. by the canton and Lake of Geneva, E. by the Swiss canton of the Valais, S. by Italy and the department of Savoie, and W. by the department of the Ain. It is mainly made up of the river-basins of the Arve (flowing along the northern foot of the Mont Blanc range, and receiving the Giffre, on the right, and the Borne and Foron, on the left—the Arve joins the Rhone, close to Geneva), of the Dranse (with several branches, all flowing into the Lake of Geneva), of the Usse and of the Fier (both flowing direct into the Rhone, the latter after forming the Lake of Annecy). The upper course of the Arly is also in the department, but the river then leaves it to fall into the Isère. The whole of the department is mountainous. But the hills attain no very great height, save at its south-east end, where rises the snowclad chain of Mont Blanc, with many high peaks (culminating in Mont Blanc, 15,782 ft.) and many glaciers. That portion of the department is alone frequented by travellers, whose centre is Chamonix in the upper Arve valley. The lowest point (945 ft.) in the department is at the junction of the Fier with the Rhone. The whole of the department is included in that portion of the duchy of Savoy which was neutralized in 1815. In 1906 the population of the department was 260,617. Its area is 1775 sq. m., and it is divided into four arrondissements (Annecy, the chief town, Bonneville, St Julien and Thonon), 28 cantons and 314 communes. It forms the diocese of Annecy. There are in the department 176 m. of broad-gauge railways, and 70 m. of narrow-gauge lines. There are also a number of mineral springs, only three of which are known to foreigners—the chalybeate waters of Évian and Amphion, close to each other on the south shore of the Lake of Geneva, and the chalybeate and sulphurous waters of St Gervais, at the north-west end of the chain of Mont Blanc. Anthracite and asphalt mines are numerous, as well as stone quarries. Cotton is manufactured at Annecy, while Cluses is the centre of the clock-making industry. There is a well-known bell foundry at Annecy le Vieux. Thonon (the old capital of the Chablais) is the most important town on the southern shore of the Lake of Geneva and, after Annecy, the most populous place in the department. (W. A. B. C.)

HAUTES-PYRÉNÉES, a department of south-western France, on the Spanish frontier, formed in 1790, half of it being taken from Bigorre and the remainder from Armagnac, Nébouzan, Astarac and Quatre Vallées, districts which all belonged to the province of Gascony. Pop. (1906), 209,397. Area, 1750 sq. m. Hautes-Pyrénées is bounded S. by Spain, W. by the department of Basses-Pyrénées (which encloses on its eastern border five communes belonging to Hautes-Pyrénées), N. by Gers and E. by Haute-Garonne. Except on the south its boundaries are conventional. The south of the department, comprising two-thirds of its area, is occupied by the central Pyrénées. Some of the peaks reach or exceed the height of 10,000 ft., the Vignemale (10,820 ft.) being the highest in the French Pyrénées. The imposing *cirques* (Cirques de Troumouse, Gavarnie and Estaubé), with their glaciers and waterfalls, and the pleasant valleys attract a large number of tourists, the most noted point being the Cirque de Gavarnie. The northern portion of the department is a region of plains and undulating hills clothed with corn-fields, vineyards and meadows. To the north-east, however, the

cold and wind-swept plateau of Lannemezan (about 2000 ft.), the watershed of the streams that come down on the French side of the Pyrenees, presents in its bleakness and barrenness a striking contrast to the plain that lies below. The department is drained by three principal streams, the Gave de Pau, the Adour and the Neste, an affluent of the Garonne. The sources of the first and third lie close together in the Cirque de Gavarnie and on the slopes of Troumouse, whence they flow respectively to the north-west and north-east. An important section of the Pyrenees, which carries the Massif Néouvielle and the Pic du Midi de Bigorre (with its meteorological observatory), runs northward between these two valleys. From the Pic du Midi descends the Adour, which, after watering the pleasant valley of Campan, leaves the mountains at Bagnères and then divides into a multitude of channels, to irrigate the rich plain of Tarbes. The chief of these is the Canal d'Alaric with a length of 36 m. Beyond Hautes-Pyrénées it receives on the right the Arros, which flows through the department from south to north-north-west; on the left it receives the Gave de Pau. This latter stream, rising in Gavarnie, is joined at Luz by the Gave de Bastan from Néouvielle, and at Pierrefitte by the Gave de Cauterets, fed by streams from the Vignemale. The Gave de Pau, after passing Argelès, a well-known centre for excursions, and Lourdes, leaves the mountains and turns sharply from north to west; it has a greater volume of water than the Adour, but, being more of a mountain torrent, is regarded as a tributary of the Adour, which is navigable in the latter part of its course. The Neste d'Aure, descending from the peaks of Néouvielle and Troumouse, receives at Arreau the Neste de Louron from the pass of Clarabide and flows northwards through a beautiful valley as far as La Barthe, where it turns east; it is important as furnishing the plateau of Lannemezan with a canal, the Canal de la Neste, the waters of which are partly used for irrigation and partly for supplying the streams that rise there and are dried up in summer—the Gers and the Baise, affluents of the Garonne. This latter only touches the department. The climate of Hautes-Pyrénées, though very cold on the highlands, is warm and moist in the plains, where there are hot summers, fine autumns, mild winters and rainy springs. On the plateau of Lannemezan, while the summers are dry and scorching, the winters are very severe. The average annual rainfall at Tarbes, in the north of the department, is about 34 in.; at the higher altitudes it is much greater. The mean annual temperature at Tarbes is 59° Fahr.

Hautes-Pyrénées is agricultural in the plains, pastoral in the highlands. The more important cereals are wheat and maize, which is much used for the feeding of pigs and poultry, especially geese; rye, oats and barley are grown in the mountain districts. The wines of Madiran and Peyriguère are well known and tobacco is also cultivated; chestnut trees and fruit trees are grown on the lower slopes. In the neighbourhood of Tarbes and Bagnères-de-Bigorre horse-breeding is the principal occupation and there is a famous stud at Tarbes. The horse of the region is the result of a fusion of Arab, English and Navarrese blood and is well fitted for saddle and harness; it is largely used by light cavalry regiments. Cattle raising is important; the milch-cows of Lourdes and the oxen of Tarbes and the valley of the Aure are highly esteemed. Sheep and goats are also reared. The forests, which occur chiefly in the highlands, contain bears, boars, wolves and other wild animals. There are at Campan and Sarrancolin quarries of fine marble, which is sawn and worked at Bagnères. There is a group of slate quarries at Labassère. Deposits of lignite, lead, manganese and zinc are found. The mineral springs of Hautes-Pyrénées are numerous and much visited. The principal in the valley of the Gave de Pau are Cauterets (hot springs containing sulphur and sodium), St Sauveur (springs with sulphur and sodium), and Barèges (hot springs with sulphur and sodium), and in the valley of the Adour Bagnères (hot or cold springs containing calcium sulphates, iron, sulphur and sodium) and Capvern near Lannemezan (springs containing calcium sulphates).

The department has flour-mills and saw-mills, a large military

arsenal at Tarbes, paper-mills, tanneries and manufactories of agricultural implements and looms. The spinning and weaving of wool and the manufacture of knitted goods are carried on; Bagnères-de-Bigorre is the chief centre of the textile industry.

Of the passes (*ports*) into Spain, even the chief, Gavarnie (7398 ft.), is not accessible to carriages. The department is served by the Southern railway and is traversed from west to east by the main line from Bayonne to Toulouse. There are three arrondissements, those of Tarbes, Argelès and Bagnères-de-Bigorre, 26 cantons and 480 communes. Tarbes is the capital of Hautes-Pyrénées, which constitutes the diocese of Tarbes, and is attached to the appeal court of Pau; it forms part of the region of the XVIII. army corps. In educational matters it falls within the circumscription of the académie of Toulouse. Tarbes, Lourdes, Bagnères-de-Bigorre and Luz-St Sauveur are the principal towns. St Savin, in the valley of the Gave de Pau, and Sarrancolin have interesting Romanesque churches. The church of Maubourguet built by the Templars in the 12th century is also remarkable.

HAUTE-VIENNE, a department of central France, formed in 1790 of Haut-Limousin and of portions of Marche, Poitou and Berry. Pop. (1906), 385,732. Area, 2144 sq. m. It is bounded N. by Indre, E. by Creuse, S.E. by Corrèze, S.W. by Dordogne, W. by Charente and N.W. by Vienne. Haute-Vienne belongs to the central plateau of France, and drains partly to the Loire and partly to the Garonne. The highest altitude (2540 ft.) is in the extreme south-east, and belongs to the treeless but well-watered plateau of Millevalches, formed of granite, gneiss and mica. From that point the department slopes towards the west, south-west and north. To the north-west of the Millevalches are the Ambazac and Blond Hills, both separating the valley of the Vienne from that of the Gartempe, a tributary of the Creuse. The Vienne traverses the department from east to west, passing Eymoutiers, St Léonard, Limoges and St Junien, and receiving on the right the Maude and the Taurion. The Isle, which flows into the Dordogne, with its tributaries the Auvézère and the Dronne, and the Tardoire and the Bandiat, tributaries of the Charente, all rise in the south of the department. The altitude and inland position of Haute-Vienne, its geological character, and the northern exposure of its valleys make the winters long and severe; but the climate is milder in the west and north-west. The annual rainfall often reaches 36 or 37 in. and even more in the mountains. Haute-Vienne is on the whole unproductive. Rye, wheat, buckwheat and oats are the cereals most grown, but the chestnut, which is a characteristic product of the department, still forms the staple food of large numbers of the population. Potatoes, mangolds, hemp and colza are cultivated. After the chestnut, walnuts and cider-apples are the principal fruits. Good breeds of horned cattle and sheep are reared and find a ready market in Paris. Horses for remount purposes are also raised. The quarries furnish granite and large quantities of kaolin, which is both exported and used in the porcelain works of the department. Amianthus, emeralds and garnets are found. Limoges is the centre of the porcelain industry and has important liqueur distilleries. Woollen goods, starch, paper and pasteboard, wooden and leather shoes, gloves, agricultural implements and hats are other industrial products, and there are flour-mills, breweries, dye-works, tanneries, iron foundries and printing works. Wine and alcohol for the liqueur-manufacture, coal, raw materials for textile industries, hops, skins and various manufactured articles are among the imports.

The department is served almost entirely by the Orléans Railway. It is divided into the arrondissements of Limoges, Bellac, Rochechouart and St Yrieix (29 cantons and 205 communes), and belongs to the académie (educational division) of Poitiers and the ecclesiastical province of Bourges. Limoges, the capital, is the seat of a bishopric and of a court of appeal, and is the headquarters of the XII. army corps. The other principal towns are St Yrieix and St Junien. Solignac, St Léonard and Le Dorat have fine Romanesque churches. The remains

of the château of Chalusset (S.S.E. of Limoges), the most remarkable feudal ruins in Limousin, and the château of Rochechouart, which dates from the 13th, 15th and 16th centuries, are also of interest.

HAUT-RHIN, before 1871 a department of eastern France, formed in 1790 from the southern portion of Alsace. The name "Haut-Rhin" is sometimes used of the territory of Belfort (*q.v.*).

HAÛY, RENÉ JUST (1743-1822), French mineralogist, commonly styled the Abbé Haüy, from being an honorary canon of Notre Dame, was born at St Just, in the department of Oise, on the 28th of February 1743. His parents were in a humble rank of life, and were only enabled by the kindness of friends to send their son to the college of Navarre and afterwards to that of Lemoine. Becoming one of the teachers at the latter, he began to devote his leisure hours to the study of botany; but an accident directed his attention to another field in natural history. Happening to let fall a specimen of calcareous spar belonging to a friend, he was led by examination of the fragments to make experiments which resulted in the statement of the geometrical law of crystallization associated with his name (see **CRYSTALLOGRAPHY**). The value of this discovery, the mathematical theory of which is given by Haüy in his *Traité de minéralogie*, was immediately recognized, and when communicated to the Academy, it secured for its author a place in that society. Haüy's name is also known for the observations he made in pyro-electricity. When the Revolution broke out, he was thrown into prison, and his life was even in danger, when he was saved by the intercession of E. Geoffroy Saint-Hilaire. In 1802, under Napoleon, he became professor of mineralogy at the museum of natural history, but after 1814 he was deprived of his appointments by the government of the Restoration. His latter days were consequently clouded by poverty, but the courage and high moral qualities which had helped him forward in his youth did not desert him in his old age; and he lived cheerful and respected till his death at Paris on the 3rd of June 1822.

The following are his principal works: *Essai d'une théorie sur la structure des cristaux* (1784); *Exposition raisonnée de la théorie de l'électricité et du magnétisme, d'après les principes d'Aepinus* (1787); *De la structure considérée comme caractère distinctif des minéraux* (1793); *Exposition abrégée de la théorie de la structure des cristaux* (1793); *Extrait d'un traité élémentaire de minéralogie* (1797); *Traité de minéralogie* (4 vols., 1801); *Traité élémentaire de physique* (2 vols., 1803, 1806); *Tableau comparatif des résultats de la cristallographie, et de l'analyse chimique relativement à la classification des minéraux* (1809); *Traité des pierres précieuses* (1817); *Traité de cristallographie* (2 vols., 1822). He also contributed papers, of which 100 are enumerated in the Royal Society's catalogue, to various scientific journals, especially the *Journal de physique* and the *Annals du Muséum d'Histoire Naturelle*.

HAVANA (the name is of aboriginal origin; Span. Habana or, more fully, San Cristóbal de la Habana), the capital of Cuba, the largest city of the West Indies, and one of the principal seats of commerce in the New World, situated on the northern coast of the island in 23° 9' N. lat. and 82° 22' W. long. Pop. (1899), 235,081; (1907), 297,159. The city occupies a peninsula to the W. of the harbour, between its waters and those of the sea. Several small streams, of which the Almendares river is the largest, empty into the harbour. The pouch-shaped, landlocked bay is spacious and easy of access. Large merchantmen and men-of-war can come up and unload along at least a considerable part of the water-front. The entrance, which is encumbered by neither bar nor rock, averages about 200 yds. in width and is about 1400 yds. long. Within, the bay breaks up into three distinct arms, Marimaleña or Regla Bay, Guanabacoa Bay and the Bay of Atarés. On the left hand of the entrance stands the lofty lighthouse tower of the Morro. The sewage of the city and other impurities were for centuries allowed to pollute the bay, but the extent to which the harbour was thereby filled up has been exaggerated. Though certainly very much smaller than it once was, there is a difference of opinion as to whether the harbour has grown smaller since the end of the 18th century.

From the sea the city presents a picturesque appearance.

The Havana side of the bay has a sea-wall and an excellent drive. The city walls, begun in 1671 and completed about 1740, were almost entirely demolished between 1863 and 1880, only a few insignificant remnants having survived the American military occupation of 1899-1902; but it is still usual to speak of the "intramural" and the "extramural" city. The former, the old city, lying close to the harbour front, has streets as narrow as is consistent with wheel traffic. Obispo (Pi y Margall in the new republican nomenclature), O'Reilly and San Rafael are the finest retail business streets, and the Prado and the Cerro the handsomest residential streets in the city proper. The new city, including the suburbs to the W. overlooking the sea, has been laid out on a somewhat more spacious plan, with isolated dwellings and wide thoroughfares, some planted with trees. Most of the houses, and especially those of the planter aristocracy, are massively built of stone, with large grated windows, flat roofs with heavy parapets and inner courts. As the erection of wooden buildings was illegal long after 1772, it is only in the suburban districts that they are to be seen. The limestone which underlies almost all the island affords excellent building stone. The poorer houses are built of brick with plaster fronts. Three-fourths of all the buildings of the city are of one very high storey; there are but a few dozen buildings as high as four storeys. Under Spanish rule, Havana was reputed to be a city of noises and smells. There was no satisfactory cleaning of the streets or draining of the sub-soil, and the harbour was rendered visibly foul by the impurities of the town. A revolution was worked in this respect during the United States military occupation of the city, and the republic continued the work.

Climate.—The general characteristics of the climate of Havana are described in the article CUBA. A temperature as low as 40° F. is extraordinary; and freezing point is only reached on extremely rare occasions, such as during hurricanes or electric storms. The mean annual temperature is about 57.7° C. (78° F.); that of the hottest month is about 28.8° C. (84° F.), and that of the coldest, 21° C. (70° F.). The means of the four seasons are approximately— for December, January, February and successive quarters—23°, 27°, 28° and 26° C. (73.4°, 80.6°, 82.4° and 78.8° F.). The mean relative humidity is between 75 and 80 for all seasons save spring, when it is least and may be from 65 upward. A difference of 30° C. (54° F.) at mid-day in the temperature of two spots close together, one in sun and one in shade, is not unusual. The daily variation of temperature is also considerable. The depressing effect of the heat and humidity is greatly relieved by afternoon breezes from the sea, and the nights are invariably comfortable and generally cool.

Defences.—The principal defences of Havana under Spanish rule, when the city was maintained as a military stronghold of the first rank, were (to use the original and unabbreviated form of the names) the Castillo de San Salvador de la Punta, to the W. of the harbour entrance; the Castillo de Los Tres Reyes del Morro and San Carlos de la Cabaña, to the E.; the Santo Domingo de Atarés, at the head of the western arm of the bay, commanding the city and its vicinity; and the Castillo del Principe (1767-1780), situated inland on an eminence to the W. El Morro, as it is popularly called, was first erected in 1590-1640, and La Punta, a much smaller fort, is of the same period; both were reconstructed after the evacuation of the city by the English in 1763, from which time also date the castles of Principe, Atarés and the Cabaña. The Cabaña, which alone can accommodate some 6000 men, fronts the bay for a distance of more than 800 yds., and was long supposed, at least by Spaniards, to be the strongest fortress of America. Here is the "laurel ditch" or "dead-line"—commemorated by a handsome bronze relief set in the wall of the fortress—where scores of Cuban patriots were shot. To the E. and W. inland are several small forts. The military establishment of the republic is very small.

Churches.—Of the many old churches in the city, the most noteworthy is the cathedral. The original building was abandoned in 1762. The present one, originally the church of the Jesuits, was erected in 1656-1724. The interior decoration dates largely from the last decade of the 18th century and the first two decades of the 19th. In the wall of the chancel, a medallion and inscription long distinguished the tomb of Columbus, whose remains were removed hither from Santo Domingo in 1796. In 1898 they were taken to Spain. Mention may also be made of the churches of Santo Domingo (begun in 1578), Santa Catalina (1700), San Agustín (1608), Santa Clara (1644), La Merced (1744, with a collection of oil paintings) and San Felipe (1693). Monasteries and nunneries were very numerous until the suppression of the religious orders in 1842, when many became simple churches. Some of the convents were successful in conserving their wealth. The former monastery of the Jesuits, now the Jesuit church of Belén (1704), at the corner of Luz

and Compostela Streets, is one of the most elegant and richly ornamented in Cuba.

Public Buildings.—The Palace, which served as a residence for the captains-general during the Spanish rule, is the home of the city government and the residence of the president of the republic. It is a large and handsome stone structure (tinted in white and yellow), and stands on the site of the original parish church, facing the Plaza de Armas from the east. It was erected in 1773-1792 and radically altered in 1835 and 1851. A large municipal gaol (1834-1837), capable of receiving 500 inmates, with barracks for a regiment, is a striking object on the Prado. The Castillo del Principe now serves as the state penitentiary. Among other public buildings are the exchange (El Muelle), the custom-house (formerly the church of San Francisco; begun about 1575, rebuilt in 1731-1737), and the Maestranza (c. 1723), once the navy yard and the headquarters of the artillery and now the home of the national library. All these are in the old city. Some of the older structures—notably the church of Santo Domingo and the Maestranza—are built of grey limestone. In the old city also are the Plaza Vieja, dating from the middle of the 16th century (with the modern Mercado de Cristina, of 1837—destroyed 1908), the old stronghold La Fuerza, erected by Hernando de Soto in 1538, once the treasury of the flotas and galleons, and residence of the governors, with its old watch-tower (La Vigia); and the Plaza de Armas, with the palace, the Senate building, a statue of Fernando VII. (1833), and a commemorative chapel (El Templete, 1828) to mark the supposed spot where mass was first said at the establishment of the city. Mention must be made of the large and interesting markets, especially those of Colón and Tacón. Of the theatres, which until the end of the Spanish period had to compete with the bull-ring and the cockpit, the most important is the Tacón (now "Nacional") erected in 1838.

Havana is famous for its promenades, drives and public gardens. On the city's E. harbour front runs the Paseo (Alameda) de Paula (1772-1775, improved 1844-1845), an embanked drive, continued by the Paseo de Rocali and the Cortina de Valdes, with fine views of the forts and the harbour. On the N., along the sea, beginning at the Punta fortress and running W. for several miles along the sea-wall, is a speedway and pleasure-drive, known—from the wall—is the Malecón. Beginning at the Punta fortress—where a park was laid out in 1890 in the place of an ugly quarter, with a memorial to the students judicially murdered by the Spanish volunteers in 1871—and running along the line of the former city walls, past the Parque Central, through the Parque de Isabel II. and the Parque de la India (these two names are now practically abandoned) to the Parque de Colón or Campo de Marte, is the Prado, a wide and handsome promenade and drive, shaded with laurels and lined with fine houses and clubs. In 1907 a hurricane destroyed the greater part of the laurels of the Prado and the royal palms of the Parque de Colón. Central Park is surrounded by hotels, theatres, cafés and clubs, the last including the Centro Asturiano and Casino Español. In the centre is a monument to José Martí (1853-1895), "the apostle of independence," and in an adjoining square is the city's fine monument to the Cuban engineer Francisco de Albezar, to whom she owes her water system. From the Parque de Colón the Calle (or Calzada) de la Reina—an ordinary business street, once a promenade and known as the Alameda de Isabel II.—with its continuations, the Paseo de Carlos III. and Paseo de Tacón, runs westward through the city past the botanical gardens and the Quinta de los Molinos to the ciudad of El Principe (1774-1794). A statue of Charles III. by Canova (1803), fountains, pavilions and four rows of trees adorn the Paseo de Carlos III. The gardens of Los Molinos, where the captains-general formerly maintained their summer residence, and the adjoining botanical gardens of the university, contain beautiful avenues of palm trees. Near El Principe is the Columbus cemetery, with a fine gateway, a handsome monument (1888) to the students shot in 1871, and another (1897; 75 ft. high) to the firemen lost in a great fire in 1890, besides many smaller memorials. The Calzada de la Infanta is a fine street at the W. end of the new city; the Cerro, in the S.W., is lined with massive residences, once the homes of Cuban aristocracy.

Suburbs.—In the coral rock of the coast sea-baths are excavated, so that bathers may run no risk from sharks. On the S. and W. the city is backed by an amphitheatre of hills, which are crowned in the W. by the conspicuous fortifications of Castillo del Principe. On the lower heights near the city lie Vedado, Jesus del Monte, Luyanó and other healthy suburbs. Chorrera, Puentes Grandes, Marianao (founded 1830; pop. 1907, 9332) and Guanabacoa (with mineral springs), are attractive places of resort. Regla, just across the bay (now part of the *municipio*), has large business interests.

Charities and Education.—Among the numerous charitable institutions the most important hospital is the Casa de Beneficencia y Maternidad (Charity and Maternity Asylum), opened in 1794, and containing an orphan asylum, a maternity ward, a home for vagrants, a lunatic asylum and an infirmary. There is also in the city an immense lazaretto for lepers. The Centro Asturiano, a club with a membership of some ten or fifteen thousand (not limited to Asturians),

maintains for the benefit of its members a large and well-managed sanatorium in spacious grounds in the midst of the city.

Of the schools of the city the most noteworthy is the university (581 regular students, 1907), founded in 1728. Its quarters were in the old convent of Santo Domingo until 1900, when the American military government prepared better quarters for it in the former Pirotecnica Militar, near El Principe. There are various laboratories in the city. Other schools are the provincial Institute of Secondary Education (490 regular students in 1907; library of 12,863 vols.), a provincial school of arts and trades (opened 1882), a theological seminary; a boys' technical school, a school of painting and sculpture, a conservatory of music, normal school, mercantile school and a military academy. The Jesuit church (Belén) has a large college for boys, laboratories, an observatory, a museum of natural history, and an historical library. Great progress has been made in education, which was extremely backward until after the end of Spanish rule. The Sociedad Economica de Amigos del Pais, established in 1792, has always had considerable influence. It has a library of some 42,000 volumes, rich in material for Cuban history. Among other similar organizations are an Academy of Medical, Physical and Natural Sciences (1863); a national library, established in 1901, and having in 1908 about 40,000 volumes, including the finest collection in the world of materials for Cuban history; an anthropological society; various medical societies; and a Bar association. An association of sugar planters is a very important factor in the economic development of the island.

Of the newspapers of Havana the most notable is the *El Diario de la Marina* (established in 1838; under its present name, 1844; morning and evening), which was almost from its foundation an official organ of the Spanish government, and generally the mouth-piece of the most intransigent peninsular opinion in all that concerned the politics of the island. *El Anzador Comercial* (1868; evening) is devoted almost exclusively to commercial and financial news. Of the other newspapers the leading ones in 1909 were *La Discusion* (1888; evening), *La Lucha* (1884; evening) and *El Mundo* (1902; morning).

Trade.—Havana commands the wholesale trade of all the western half of the island, and is the centre of commercial and banking interests. Its foreign trade in the five calendar years 1902-1906 (average imports \$57,201,276; exports, \$40,563,637) amounted to 68.9% of the imports and 44.6% of the exports of the island. The average number of vessels entering the port annually in the ten years from 1864 to 1873 was 1981 (771,196 tons), and the average entries in the five years 1902-1906 were 3968 of 3,904,906 gross tons (coast trade alone, 2162 of 333,795 tons).

In spite of high tariffs and civil wars, and the competition of Matanzas, Cárdenas, Cienfuegos and other Cuban ports opened to foreign trade in modern times, the commerce of Havana has steadily increased. The chief foreign customers are Great Britain and the United States. The two staple articles of export are sugar and tobacco-wares. Other exports of importance are rum, wax and honey; and of less primary importance, fruits, fine cabinet woods, oils and starch. The leading imports are grains, flour, lard and various other foodstuffs, coal, lumber, petroleum and machinery, all mainly from the United States; wines and olive oil from Spain; jerked beef from South America; fabrics and other staples from varied sources. Rice is a principal food of the people; it was formerly taken from the East Indies, but is now mostly raised in the island.

The chief manufacturing industry of Havana is that of tobacco. Of the cigar factories, some of which are in former public and private palaces, more than a hundred may be reckoned as of the first class. Besides the making of boxes and barrels and other articles necessarily involved in its sugar and tobacco trade, Havana also, to some extent, builds carriages and small ships, and manufactures iron and machinery; but the weight of taxation during the Spanish period was always a heavy deterrent on the development of any business requiring great capital. There are minor manufacturing interests in tanneries, and in the manufacture of sweetmeats, malt and distilled liquors, especially rum, besides soaps, candles, starch, perfume, &c. There is one large and complete petroleum refinery (1905).

Havana has frequent steam-boat communication with New York, Baltimore, Philadelphia, Tampa, Mobile, New Orleans and other ports of the United States; and about as frequent with several ports in England, Spain and France. It is the starting-point of a railway system which reaches the six provincial capitals between Pinar del Rio and Santiago, Cárdenas, Cienfuegos and other ports. Telegraphs radiate to all parts of the island; a submarine cable to Key West forms part of the line of communication between Colon and New York, and by other cables the island has connexion with various parts of the West Indies and with South America.

Population and Health.—The population of Havana was reported as 51,307 in 1791; 96,304 in 1811; 94,023 in 1817; 184,508 in 1841. In 1890 the American census showed 235,981, of whom about 25% were foreign (20% Spanish); and the census of 1907 showed 297,159 (not including the attached country districts) and 302,526 (including these country districts), the last being for the "municipio" of Havana. The industrial population is very densely crowded. Owing to this, as well as to the entire lack of proper sanitary customs among the people, the horrible condition of sewerage and the

¹ Renamed Paseo de Martí by the republic, but the name is never used.

prevalence of yellow fever (first brought to Havana, it is thought, in 1761, from Vera Cruz), the reputation of the city as regards health was long very bad. The practical extermination of yellow fever during the U.S. military occupation following 1899 was a remarkable achievement. In 1895-1899, owing to the war, there were few non-immune persons in the city, and there was no trouble with the fever, but from the autumn of 1899 a heavy immigration from Spain began, and a fever epidemic was raging in 1900. The American military authorities found that the most extraordinary measures for cleansing the city—involving repeated house-to-house inspection, enforced cleanliness, improved drainage and sewerage, the destruction of various public buildings, and thorough cleansing of the streets—although decidedly effective in reducing the general death-rate of the city (average, 1890-1899, 45.83; 1900, 24.40; 1901, 22.11; 1902, 20.63; general death-rate of U.S. soldiers in 1898, 67.94; in 1901-1902, 7.00), apparently did not affect yellow fever at all. In 1900-1901 Major Walter Reed (1851-1902), a surgeon in the United States army, proved by experiments on voluntary human subjects that the infection was spread by the *Sigomyia* mosquito,¹ and the prevention of the disease was then undertaken by Major William C. Gorgas—all patients being screened and mosquitoes practically exterminated.² The number of subsequent deaths from yellow fever has depended solely on the degree to which the necessary precautionary measures were taken.

The entire administrative system of the island, when a Spanish colony, was centred at Havana. Under the republic this remains the capital and the residence of the president, the supreme court, Congress when in session and the chief administrative officers. None of the public services was good in the Spanish period, except the water-supply, which was excellent. The water is derived from the Vento springs, 9 m. from Havana, and is conducted through aqueducts constructed between 1859 and 1894 at a cost of some \$5,000,000. About 40,000,000 gallons are supplied daily. The system is owned by the municipality. The older Fernando VII. aqueduct (1831-1835) is still usable in case of need; its supply was the Alameda river (until long after the construction of this, a still older aqueduct, opened at the end of the 16th century, was in use). The sewerage system and conditions of house sanitation were found extremely inadequate when the American army occupied the city in 1899. Several public buildings were so foul that they were demolished and burned. The improvement since the end of Spanish rule has been steady.

History.—Havana, originally founded by Diego Velasquez in 1514 on an unhealthy site near the present Batabanó (pop. in 1907, 15,435, including attached country districts), on the south coast, was soon removed to its present position, was granted an ayuntamiento (town council), and shortly came to be considered one of the most important places in the New World. Its commanding position gained it in 1634, by royal decree, the title of "Llave del Nuevo Mundo y Antemural de las Indias Occidentales" (Key of the New World and Bulwark of the West Indies), in reference to which it bears on its coat of arms a symbolic key and representations of the Morro, Punta and Fuerza. In the history of the place in the 16th century few things stand out except the investments by buccaneers: in 1537 it was sacked and burned, and in 1555 plundered by French buccaneers, and in 1586 it was threatened by Drake. In 1589 Philip II. of Spain ordered the erection of the Punta and the Morro. In the same year the residence of the governor of the island was moved from Santiago de Cuba to Havana. Philip II. granted Havana the title of "ciudad" in 1592. Sugar plantations in the environs appeared before the end of the 16th century. The population of the city, probably about 3000 at the beginning of the 17th century, was doubled in the years following 1655 by the coming of Spaniards from Jamaica. In the course of the 17th century the port became the great

¹ Dr Carlos Finlay of Havana, arguing from the coincidence between the climatic limitation of yellow fever and the geographical limitation of the mosquito, urged (1881 sqq.) that there was some relation between the disease and the insect. Reed worked from the observation of Dr H. R. Carter (U.S. Marine Hospital Service) that although the incubation of the disease was 5 days, 15 to 20 days had to elapse before the "infection" of the house, and from Ross's demonstration of the part played in malaria by the *Anopheles*. See H. A. Kelly, *Walter Reed and Yellow Fever* (New York, 1907).

² The average number of deaths from yellow fever annually from 1885 (when reliable registration began) to 1898 was 455; maximum 1282 in 1896 (supposed average for 4 years, 1856-1859, being 1489.8 and for 7 years, 1873-1879, 1395.1); minimum 136 in 1898; average deaths of military, 1885-1896, 278.4 (in 1896-1897 constituting 1966 out of a total of 2140); deaths of American soldiers, 1899-1900, 18 out of 431.

rendezvous for the royal merchant and treasure fleets that monopolized trade with America, and the commercial centre of the Spanish-American possessions. It was blockaded four times by the Dutch (who were continually molesting the treasure fleets) in the first half of the 17th century. In 1671 the city walls were begun; they were completed in 1702. The European wars of the 17th and 18th centuries were marked by various incidents in local history. After the end of the Spanish War of Succession (1713) came a period of comparative prosperity in slave-trading and general commerce. The creation in 1740 of a monopolistic trading-company was an event of importance in the history of the island. English squadrons threatened the city several times in the first half of the 18th century, but it was not until 1762 than an investment, made by Admiral Sir George Pocock and the earl of Albemarle, was successful. The siege lasted from June to August and was attended by heavy loss to both besiegers and besieged. The British commanders wrung great sums from the church and the city as prize of war and price of good order. By the treaty of the 10th of February 1763, at the close of the Seven Years' War, Havana was restored to Spain in exchange for the Floridas. The English turned over the control of the city on the 6th of July. Their occupation greatly stimulated commerce, and from it dates the modern history of the city and of the island (see CUBA). The gradual removal of obstacles from the commerce of the island from 1766 to 1818 particularly benefited Havana. At the end of the 18th century the city was one of the seven or eight great commercial centres of the world, and in the first quarter of the 19th century was a rival in population and in trade of Rio Janeiro, Buenos Aires and New York. In 1789 a bishopric was created at Havana suffragan to the archbishopric at Santiago. From the end of the 18th century Havana, as the centre of government, was the centre of movement and interest. During the administration of Miguel Tacón Havana was improved by many important public works; his name is frequent in the nomenclature of the city. The railway from Havana to Güines was built between 1835 and 1838. Fifty Americans under Lieut. Crittenden, members of the Bahía Honda filibustering expedition of Narciso Lopez, were shot at Fort Atarés in 1851. Like the rest of Cuba, Havana has frequently suffered severely from hurricanes, the most violent being those of 1768 (St Theresa's), 1810 and 1846. The destruction of the U.S. battleship "Maine" in the harbour of Havana on the 15th of February 1898 was an influential factor in causing the outbreak of the Spanish-American War, and during the war the city was blockaded by a United States fleet.

See J. de la Pezuela, *Diccionario de la Isla de Cuba*, vol. iii. (Madrid, 1863), for minute details of history, administration and economic conditions down to 1862; J. M. de la Torre, *Lo que fuimos y lo que somos, ó la Habana antigua y moderna* (Havana, 1857); P. J. Guitéras, *Historia de la conquista de la Habana 1762* (Philadelphia, 1856); J. de la Pezuela, *Sitio y rendición de la Habana en 1762* (Madrid, 1859); A. Bachiller y Morales, *Monografía histórica* (Havana, 1883), minutely covering the English occupation (the best account) of 1762-1763; Maria de los Mercedes, comtesse de Merlin, *La Habana* (3 vols., Paris, 1844); and the works cited under CUBA.

HAVANT, a market-town in the Fareham parliamentary division of Hampshire, England, 67 m. S.W. from London by the London & South Western and the London, Brighton & South Coast railways. Pop. of urban district (1901), 3837. The urban district of Warblington, 1 m. S.E. (pop. 3639), has a fine church, Norman and later, with traces of pre-Norman work, and some remains of a Tudor castle. Havant lies in a flat coastal district, near the head of Langstone Harbour, a wide shallow inlet of the English Channel. The church of St Faith was largely rebuilt in 1875, but retains some good Early English work. There are breweries and tanneries, and the manufacture of parchment is carried on. Off the mainland near Havant lies Hayling, a flat island of irregular form lying between the harbours of Langstone and Chichester. It measures 4 m. in length from N. to S., and is nearly the same in breadth at the south, but the breadth generally is about 1½ m. It is well wooded and fertile. A railway serves the village of South Hayling, which is in some

favour as a seaside resort, having a wide sandy beach and good golf links. The island was in the possession of successive religious bodies from the Conquest (when it was given to the Benedictines of Jumitges, near Rouen), until the Dissolution. The church of South Hayling is a fine Early English building.

HAVEL, a river of Prussia, Germany, having its origin in Lake Dambeck (223 ft.) on the Mecklenburg plateau, a few miles north-west of Neu-Strelitz, and after threading several lakes flowing south as far as Spandau. Thence it curves south-west, past Potsdam and Brandenburg, traversing another chain of lakes, and finally continues north-west until it joins the Elbe from the right some miles above Wittenberge after a total course of 221 m. and a total fall of only 158 ft. Its banks are mostly marshy or sandy, and the stream is navigable from the Mecklenburg lakes downwards. Several canals connect it with these lakes, as well as with other rivers—e.g. the Finow canal with the Oder, the Ruppian canal with the Rhin, the Berlin-Spandau navigable canal (5½ m.) with the Spree, and the Plauenthal canal with the Elbe. The Sakrow-Paritz canal, 11 m. long, cuts off the deep bend at Potsdam. The most notable of the tributaries is the Spree (227 m. long), which bisects Berlin and joins the Havel at Spandau. Area of river basin, 10,159 sq. m.

HAVELBERG, a town of Germany, in the Prussian province of Brandenburg, on the Havel and the railway Glöwen-Havelberg. Pop. (1905), 5988. The town is built partly on an island in the Havel, and partly on hills on the right bank of the river, on one of which stands the fine Romanesque cathedral dating from the 12th century. The two parts, which are connected by a bridge, were incorporated as one town in 1875. The inhabitants are chiefly engaged in tobacco manufacturing, sugar-refining and boat-building, and in the timber trade.

Otto I. founded a bishopric at Havelberg in 946; the bishop, however, who was a prince of the Empire, generally resided at Plattenburg, or Wittstock, a few miles to the north. In 1548 the bishopric was seized by the elector of Brandenburg, who finally took possession of it sixty years later, and the cathedral passed to the Protestant Church, retaining its endowments till the edict of 1810, by which all former ecclesiastical possessions were assumed by the crown. The final secularization was delayed till 1810. Havelberg was formerly a strong fortress, but in the Thirty Years' War it was taken from the Danish by the imperial troops in 1627. Recaptured by the Swedes in 1631, and again in 1635 and 1636, it was in 1637 retaken by the Saxons. It suffered severely from a conflagration in 1870.

HAVELOCK, SIR HENRY (1795–1857), British soldier, one of the heroes of the Indian Mutiny, the second of four brothers (all of whom entered the army), was born at Ford Hall, Bishop-Wearmouth, Sunderland, on the 5th of April 1795. His parents were William Havelock, a wealthy shipbuilder in Sunderland, and Jane, daughter of John Carter, solicitor at Stockton-on-Tees. When about five years old Henry accompanied his elder brother William to Mr Bradley's school at Swanscombe, whence at the age of ten he removed for seven years to Charterhouse school. In accordance with the desire of his mother, who had died in 1811, he entered the Middle Temple in 1813, studying under Chitty the eminent special pleader. His legal studies having been abridged by a misunderstanding with his father, he in 1815 accepted a second lieutenancy in the Rifle Brigade (95th), procured for him by the interest of his brother William. During the following eight years of service in Britain he read extensively and acquired a good acquaintance with the theory of war. In 1823, having exchanged into the 21st and thence into the 13th Light Infantry, he followed his brothers William and Charles to India, first qualifying himself in Hindustani under Dr Gilchrist, a celebrated Orientalist.

At the close of twenty-three years' service he was still a lieutenant, and it was not until 1838 that, after three years' adjutancy of his regiment, he became captain. Before this, however, he had held several staff appointments, notably that of deputy assistant-adjutant-general of the forces in Burma till the peace of Yandabu, of which he, with Lumsden and Knox, procured the ratifications at Ava from the "Golden Foot,"

who bestowed on him the "gold leaf" insignia of Burmese nobility. His first command had been at a stockade capture in the war, and he was present also at the battles of Napadee, Patanago and Pagan. He had also held during his lieutenancy various interpreferments and the adjutancy of the king's troops at Chinsura. In 1828 he published at Serampore *Campaigns in Ava*, and in 1829 he married Hannah Shepherd, daughter of Dr Marshman, the eminent missionary. About the same time he became a Baptist, being baptized by Mr John Mack at Serampore. During the first Afghan war he was present as aide-de-camp to Sir Willoughby Cotton at the capture of Ghazni, on the 23rd of July 1839, and at the occupation of Kabul. After a short absence in Bengal to secure the publication of his *Memoirs of the Afghan Campaign*, he returned to Kabul in charge of recruits, and became interpreter to General Elphinstone. In 1840, being attached to Sir Robert Sale's force, he took part in the Khurd-Kabul fight, in the celebrated passage of the defiles of the Ghilzais (1841) and in the fighting from Tezeen to Jalalabad. Here, after many months' siege, his column in a sortie *en masse* defeated Akbar Khan on the 7th of April 1842. He was now made deputy adjutant-general of the infantry division in Kabul, and in September he assisted at Jagdalak, at Tezeen, and at the release of the British prisoners at Kabul, besides taking a prominent part at Istaliff. Having obtained a regimental majority he next went through the Mahratta campaign as Persian interpreter to Sir Hugh (Viscount) Gough, and distinguished himself at Maharajpore in 1843, and also in the Sikh campaign at Moodkee, Ferozeshah and Sohraon in 1845. For these services he was made deputy adjutant-general at Bombay. He exchanged from the 13th to the 39th, then as second major into the 53rd at the beginning of 1849, and soon afterwards left for England, where he spent two years. In 1854 he became quartermaster-general, then full colonel, and lastly adjutant-general of the troops in India.

In 1857 he was selected by Sir James Outram for the command of a division in the Persian campaign, during which he was present at the actions of Muhamra and Ahwaz. Peace with Persia set him free just as the Mutiny broke out; and he was chosen to command a column "to quell disturbances in Allahabad, to support Lawrence at Lucknow and Wheeler at Cawnpore, to disperse and utterly destroy all mutineers and insurgents." At this time Lady Canning wrote of him in her diary: "General Havelock is not in fashion, but all the same we believe that he will do well. No doubt he is fussy and tiresome, but his little old stiff figure looks as active and fit for use as if he were made of steel." But in spite of this lukewarm commendation Havelock proved himself the man for the occasion, and won the reputation of a great military leader. At Fatehpur, on the 12th of July, at Aong and Pandoobridge on the 15th, at Cawnpore on the 16th, at Unao on the 29th, at Busherutunge on the 29th and again on the 5th of August, at Boorhya on the 12th of August, and at Bithur on the 16th, he defeated overwhelming forces. Twice he advanced for the relief of Lucknow, but twice prudence forbade a reckless exposure of troops wasted by battle and disease in the almost impracticable task. Reinforcements arriving at last under Outram, he was enabled by the generosity of his superior officer to crown his successes on the 25th of September 1857 by the capture of Lucknow. There he died on the 24th of November 1857, of dysentery, brought on by the anxieties and fatigues connected with his victorious march and with the subsequent blockade of the British troops. He lived long enough to receive the intelligence that he had been created K.C.B. for the first three battles of the campaign; but of the major-generalship which was shortly afterwards conferred he never knew. On the 26th of November, before tidings of his death had reached England, letters-patent were directed to create him a baronet and a pension of £1000 a year was voted at the assembling of parliament. The baronetcy was afterwards bestowed upon his eldest son; while to his widow, by royal order, was given the rank to which she would have been entitled had her husband survived and been created a baronet. To both widow and son pensions of £1000 were awarded by parliament.

See Marshman, *Life of Havelok* (1866); L. J. Trotter, *The Bayard of India* (1903); F. M. Holmes, *Four Heroes of India*; G. B. Smith, *Heroes of the Nineteenth Century* (1901); and A. Forbes, *Havelok* ("English Men of Action" series, 1890).

HAVELOK THE DANE, an Anglo-Danish romance. The hero, under the name of CUHERAN or CUARAN, was a scullion-jongleur at the court of Edelsi (Alsi) or Godric, king of Lincoln and Lindsey. At the same court was brought up Argentille or Goldborough, the orphan daughter of Adelbrict, the Danish king of Norfolk, and his wife Orwain, Edelsi's sister; and Edelsi, to humiliate his ward, married her to the scullion Cuaran. But, inspired by a vision, Cuaran and Goldborough set out for Grimsby, where Cuaran learned that Grim, his supposed father, was dead. His foster-sister, moreover, told him that his real name was Havelok, that he was the son of Gunter (or Birkabeyn), king of Denmark, and had been rescued by Grim, who though a poor fisherman was a noble in his own country, when Gunter perished by treason. The hero then wins back his own and Goldborough's kingdoms, punishing traitors and rewarding the faithful. The story exists in two French versions: as an interpolation between Geffrei Gaimar's *Brut* and his *Estorie des Engles* (c. 1150) and in the Anglo-Norman *Lai d'Havelok* (12th century). The English *Havelok* (c. 1300) is written in a Lincolnshire dialect and embodies abundant local tradition. A short version of the tale is interpolated in the Lambeth MS. of Robert Mannyng's *Handlyng Synne*. The story reappears more than once in English literature, notably in the ballad of "Argentille and Curan" in William Warner's *Albion's England*. The name of Havelok (Hablok, Abloek, Abloyc) is said to correspond in Welsh to Anlaf or Olaf. Now the historical Anlaf Curan was the son of a Viking chief Sihtric, who was king of Northumbria in 925 and died in 927. Anlaf Sihtricon was driven into exile by his stepmother's brother Æthelstan, and took refuge in Scotland at the court of Constantine II., whose daughter he married. He was defeated with Constantine¹ at Brunanburh (937), but was nevertheless for two short periods joint ruler in Northumbria with his cousin Anlaf Godfreyson. He reigned in Dublin till 980, when he was defeated. He died the next year as a monk at Iona. Round the name of Anlaf Curan a number of legends rapidly gathered, and the legend of the Danish hero probably filtered through Celtic channels, as the Welsh names of Argentille and Orwain indicate. The close similarity between the Havelok saga and the story of Hamlet (Amlethus) as told by Saxo Grammaticus was pointed out long ago by Scandinavian scholars. The individual points they have in common are found in other legends, but the series of coincidences between the adventurous history of Anlaf Curan and the life of Amlethus can hardly be fortuitous. Interesting light is thrown on the whole question by Professor I. Gollancz (*Hamlet in Iceland*, 1898) by the identification of Amhlaide—who is said by Queen Gormfláith² in the *Annals of Ireland by the Four Masters* to have slain Niall Glundubh—with Anlaf's father Sihtric. The exploits of father and son were likely to be confused.

The mythical elements in the Havelok story are numerous. Argentille, as H. L. Ward points out, is a disguised Valkyrie. Like Svava she inspired a dull and nameless youth, and as Hild raised the dead to fight by magic, so Argentille in *Havelok* and Hermuthruda in *Amleth* prop up dead or wounded men with stakes to bluff the enemy. Havelok's royal lineage is betrayed by his flame breath when he is asleep, a phenomenon which has parallels in the history of Servius Tullius and of Dietrich of Bern. Part of the Havelok legend lingers in local tradition. Havelok destroyed his enemies in Denmark by casting down great stones upon them from the top of a tower, and Grim is said to have

¹ H. L. Ward (*Cat. of Romances*, i. 426) suggests that it was the mention of Constantine in the Havelok legend which led Gaimar to place the tale in the 6th century in the days of the Constantine who succeeded King Arthur. Gaimar voices more than once an Anglo-Danish legend of a Danish dynasty in Britain anterior to the Saxon invasion.

² A different person from the second wife of Anlaf Curan, also Gormfláith, who forms another link with Amlethus, as she was a woman of the Hermuthruda type and married her husband's conqueror.

kicked three of the turrets from the church tower in his efforts to destroy the enemy's ships. John Weever (*Ancient Funeral Monuments*, 1631, p. 749) says that the privilege of the town in Elnisore, where its merchants were free from toll, was due to the interest of Havelok, the Danish prince, and the common seal of the town of Grimsby represents Grim, with "Hablok" on his right hand and Goldeburgh on his left.

The English MS. of *Havelok* (MSS. Laud Misc. 108) in the Bodleian library is unique. It was edited for the Roxburghe Club by Sir F. Madden in 1828. This edition contains, besides the English text, the two French versions. There are subsequent editions by W. W. Skeat (1868) for the E.E. Text Society, by F. Holthausen (London, New York and Heidelberg, 1901), and by W. W. Skeat (Clarendon Press, Oxford, 1902, where further bibliographical references will be found); and a modern English version by Miss E. Hickey (London, 1902). Gaimar's text and the French *lai* are edited by Sir T. D. Hardy and C. F. Martin in *Rerum Brit. med. æv. scriptores*, vol. I (1886). See also the account of the saga by H. L. Ward (*Cat. of Romances*, i. 423-446); for the identification of Havelok with Anlaf Curan see G. Storm, *Englische Studien* (1880), iii. 533; a reprint of an earlier article; E. K. Putnam, *The Lambeth Version of Havelok* (Baltimore, 1900).

HAVERFORDWEST (Welsh *Hwffordd*, -the English name being perhaps a corruption of the Scandinavian *Hafna-Fjord*), the chief town of Pembrokeshire, S. Wales, a contributory parliamentary and municipal borough, and a county of itself with its own lord-lieutenant. Pop. (1901), 6007. It is picturesquely situated on the slopes overlooking the West Cleddau river, which is here crossed by two stone bridges. It has a station on the Great Western Railway on the east side of the river, and when viewed from this point the town presents an imposing appearance with its castle-keep and its many ancient buildings. The river is tidal and navigable for vessels of not more than 150 tons. Coal, cattle, butter and grain are exported, but the commercial importance of the place has greatly declined, as the many ruined warehouses near the river plainly testify. The old walls and fortifications have almost disappeared, but Haverfordwest is still rich in memorials of its past greatness. The huge castle-keep, which dominates the town, was probably built by Gilbert de Clare, early in the 12th century; formerly used as the county gaol, it now serves as the police-station. The large church of St Mary, at the top of the steep High Street, has fine clerestory windows, clustered columns and an elaborate carved-oak ceiling of the 15th century; it contains several interesting monuments of the 17th and 18th centuries, some of which commemorate members of the family of Philipps of Picton Castle. At the N. corner of the adjacent churchyard stands an ancient building with a vaulted roof, once the record office, but now used as a fish-market. St Martin's, with a low tower and spire, close to the castle, is probably the oldest church in the town, but has been much modernized. Near St Thomas's church on the Green stands an old Moravian chapel which is closely associated with the great scholar and divine, Bishop John Gambold (1711-1771). In a meadow on the W. bank of the river are the considerable remains of the Augustinian Priory of St Mary and St Thomas, built by Robert de Hwlfordd, lord of Haverford, about the year 1200. On the E. bank are the suburbs of Cartlet and Prendergast, the latter of which contains the ancient parish church of St David and the ruins of a large mansion originally built by Maurice de Prendergast (12th century) and subsequently the seat of the Stepney family. A little to the S. of the town are the remains of Haroldstone, once the residence of the powerful Perrot family. The charities belonging to the town, which include John Perrot's bequest (1579), yielding about £350 annually for the improvement of the town, and Tasker's charity school (1684), are very considerable.

Haverfordwest owes its origin to the advent of the Flemings, who were permitted by Henry I. to settle in the hundred of Roose, or Rhôs, in the years 1106-1108, in 1111, and again in 1156. English is exclusively spoken in the town and district, and its inhabitants exhibit their foreign extraction by their language, customs and appearance. Haverfordwest is, in fact, the capital of that English-speaking portion of Pembrokeshire, which has been nicknamed "Little England beyond Wales."

This new settlement of intruding foreigners had naturally to be protected against the infuriated natives, and the castle was accordingly built c. 1113 by Gilbert de Clare, first earl of Pembroke, who subsequently conferred the seignory of Haverford on his castellan, Richard Fitz-Tancred. On the death of Robert de Hwiford, the benefactor and perhaps founder of the priory of St Mary and St Thomas, in 1213, the lordship of the castle reverted to the Crown, and was purchased for 1000 marks from King John by William Marshal, earl of Pembroke, who gave various privileges to the town. Of the numerous charters the earliest known (through an allusion found in a document of Bishop Houghton of St Davids, c. 1370) is one from Henry II., who therein confirms all former rights granted by his grandfather, Henry I. John in 1207 gave certain rights to the town concerning the Port of Milford, while William Marshal II., earl of Pembroke, presented it with three charters, the earliest of which is dated 1210. An important charter of Edward V., as prince of Wales and lord of Haverford, enacted that the town should be incorporated under a mayor, two sheriffs and two bailiffs, duly chosen by the burgesses. In 1536, under Henry VIII., Haverfordwest was declared a town and county of itself and was further empowered to send a representative burgess to parliament.

The town long played a prominent part in South Welsh history. In 1220 Llewelyn ap Iorwerth, prince of North Wales, during the absence of William Marshal II., earl of Pembroke, attacked and burnt the suburbs, but failed to reduce the castle by assault. Several of the Plantagenet kings visited the town, including Richard II., who stopped here some time on his return from Ireland in 1299, and is said to have performed here his last regal act—the confirmation of the grant of a burghage to the Friars Preachers. Oliver Cromwell spent some days here on his way to Ireland, and his original warrant to the mayor and council for the demolition of the castle is still preserved in the council chamber. The prosperity and local importance of Haverfordwest continued unimpaired throughout the 17th and 18th centuries, and Richard Fenton, the historian of Pembrokeshire, describes it in 1810, as "the largest town in the county, if not in all Wales." With the rise of Milford, however, the shipping trade greatly declined, and Haverfordwest has now the appearance of a quiet country town.

HAVERGAL, FRANCES RIDLEY (1836-1879), English hymn-writer, daughter of the Rev. William Henry Havergal, was born at Astley, Worcestershire, on the 14th of December 1836. At the age of seven she began to write verse, most of it of a religious character. As a hymn-writer she was particularly successful, and the modern English Church collections include several of her compositions. Her collected *Poetical Works* were published in 1884. She died at Caswell Bay, Swansea, on the 3rd of June 1879.

See *Memorials of Frances Ridley Havergal* (1880), by her sister.

HAVERHILL, a market town of England, in the Sudbury parliamentary division of Suffolk, and the Saffron Walden division of Essex. Pop. of urban district (1901), 4862. It is 55 m. N.N.E. from London by the Great Eastern railway, on the Long Melford-Cambridge branch, and is the terminus of the Colne Valley railway from Chappel in Essex. The church of St Mary is Perpendicular, but extensively restored. There are large manufactures of cloth, silk, matting, bricks, and boots and shoes, and a considerable agricultural trade.

HAVERHILL, a city of Essex county, Massachusetts, U.S.A., situated on the Merrimac river, at the head of tide and navigation, and on the Boston & Maine railway, 33 m. N. of Boston. Pop. (1880) 18,472; (1890) 27,412; (1900) 37,175, of whom 8530 were foreign-born (including 2403 French Canadians, 1651 English Canadians and 2144 Irish), and 15,077 were of foreign parentage (both parents foreign-born); (1910 census) 44,115. The city, 3 m. wide and 10 m. long, lies for its entire length along the Merrimac river, from which it rises picturesquely, its surface being undulating, with several detached round hills (maximum 339 ft.). Like all old New England cities, it is irregularly laid out. A number of lakes within its limits are the

source of an abundant and excellent water supply. There are fifteen public parks, the largest of which, Winnikenni Park (214 acres), contiguous to Lake Kenosza, is of great natural beauty. The city has three well-equipped hospitals, the beautiful Pentucket club house, a children's home, an old ladies' home and numerous charitable organizations. The schools of the city, both public and private, are of high standing; they include Bradford Academy (1803) for girls and the St James School (Roman Catholic). The public library is generously endowed, and in 1908 had about 90,000 volumes. Almost from the beginning of its history Haverhill was active industrially. Thomas Dustin, the husband of Hannah Dustin, manufactured bricks, and this industry has been carried on in the same locality for more than two hundred years. The large Stevens woollen mills are the outgrowth of mills established in 1835. The manufacture of woollen hats, established in the middle of the 18th century, is one of the prominent industries. There are large morocco factories. By far the leading industry of the city is the manufacture of boots, shoes and slippers, chiefly of the finer kinds, of which it is one of the largest producers in the world. In 1905 Haverhill ranked fourth among the cities of the United States in the product value of this manufacture, which was 4.8% of the total value of boots and shoes made in the United States. This industry began about 1795. In 1905 Haverhill's manufacturing establishments produced goods valued at \$24,446,594, 83.9% of this output being represented by boots and shoes or their accessories. One of the largest sole-leather manufactories in the world is here.

Haverhill was settled in June 1640 by a small colony from Newbury and Ipswich, and its Indian name, Pentucket, was replaced by that of Haverhill in compliment to the first minister, Rev. John Ward, who was born at Haverhill, England. In its earlier years this frontier town suffered severely from the forays of the Indians, and in 1690 the abandonment of the settlement was contemplated. Two Indian attacks are particularly noteworthy—one in 1698, in which Hannah Dustin, her newborn babe, and her nurse were carried away to the vicinity of Penacook, now Concord, New Hampshire. Here in the night Mrs Dustin, assisted by her nurse and by a captive English boy, tomahawked and scalped ten Indians (two men, the others children and women) and escaped down the river to Haverhill; a monument to her stands in City Hall Park. In 1708 250 French and Indians attacked the village, killing 40 of its inhabitants. In 1873 a destructive fire caused the loss of 35 places of business, and on the 17th of February 1882 almost the entire shoe district (consisting of 10 acres) was burned, with a loss of more than \$2,000,000; but a greater business district was built on the ruins of the old. Haverhill was the birthplace of Whittier, who lived here in 1807-1836, and who in his poem *Haverhill*, written for the 250th anniversary of the town in 1890, and in many of his other poems, gave the poet's touch to the history, the legends and the scenery of his native city. His birthplace, the scene of *Snow-Bound* in the eastern part of the city, is owned by the Whittier Association and is open to visitors. A petition from Haverhill to the national House of Representatives in 1842, praying for a peaceable dissolution of the Union, raised about J. Q. Adams, its presenter, perhaps the most violent storm in the long course of his defence of the right of petition. Haverhill was incorporated as a town in 1645 and became a city in 1869. Bradford, a town (largely residential) lying on the opposite bank of the river, became a part of the city in 1897. In October 1908, by popular vote, the city adopted a new charter providing for government by commission.

HAVERSACK, or **HAVRESACK** (through the French from Ger. *Habersack*, an oat-sack, a nose-bag, *Hafer* or *Haver*, oats), the bag in which horsemen carried the oats for their horses. In Scotland and the north of England *haver*, meaning oats, is still used, as haver-meal or haver-bread. Haversack is now used for the strong bag made of linen or canvas, in which soldiers, sportsmen or travellers, carry their personal belongings, or more usually the provisions for the day.

HAVERSTRAW, a village of Rockland county, New York, U.S.A., in a township of the same name, 32 m. N. of New York City, and finely situated on the W. shore of Haverstraw Bay, an enlargement of the Hudson river. Pop. of the village (1890), 5070; (1900) 5935, of whom 1231 were foreign-born and 568 were negroes; (1905, state census) 6182; (1910) 5669; of the township (1910) 9335. Haverstraw is served by the West Shore, the New Jersey & New York (Erie), and the New York, Ontario, & Western railways, and is connected by steamboat lines with Peekskill and Newburgh. The village lies at the N. base of High Tor (832 ft.). It has a public library, founded by the King's Daughters' Society in 1895 and housed in the Fowler library building. Excellent clay is found in the township, and Haverstraw is one of the largest brick manufacturing centres in the world; brick-machines also are manufactured here. The Minesongo creek furnishes water power for silk mills, dye works and print works. Haverstraw was settled by the Dutch probably as early as 1648. Near the village of Haverstraw (in the township of Stony Point), in the Joshua Hett Smith House, or "Old Treason House," as it is generally called, Benedict Arnold and Major André met before daylight on the 22nd of September 1780 to arrange plans for the betrayal of West Point. In 1826 a short-lived Owenite Community (of about 80 members) was established near West Haverstraw and Garnerville (in the township of Haverstraw). The members of the community established a Church of Reason, in which lectures were delivered on ethics, philosophy and science. Dissensions soon arose in the community, the experiment was abandoned within five months, and most of the members joined in turn the Coxsackie Community, also in New York, and the Kendal Community, near Canton, Ohio, both of which were also short-lived. The village of Haverstraw was originally known as Warren and was incorporated under that name in 1854; in 1873 it became officially the village of Haverstraw—both names had previously been used locally. The village of West Haverstraw (pop. in 1890, 180; in 1900, 2079; and in 1910, 2369), also in Haverstraw township, was founded in 1830, was long known as Samsondale, and was incorporated under its present name in 1883.

See F. B. Green, *History of Rockland County* (New York, 1886).

HAVET, EUGÈNE AUGUSTE ERNEST (1815-1889), French scholar, was born in Paris on the 11th of April 1815. Educated at the Lycée Saint-Louis and the École Normale, he was for many years before his death on the 21st of December 1889 professor of Latin eloquence at the Collège de France. His two capital works were a commentary on the works of Pascal, *Pensées de Pascal publiées dans leur texte authentique avec un commentaire suivi* (1852; 2nd ed. 2 vols., 1881), and *Le Christianisme et ses origines* (4 vols., 1871-1884), the chief thesis of which was that Christianity owed more to Greek philosophy than to the writings of the Hebrew prophets. His elder son, Pierre Antoine Louis Havet (b. 1849), was professor of Latin philology at the Collège de France and a member of the Institute. The younger, Julien, is separately noticed.

HAVET, JULIEN (PIERRE EUGÈNE) (1853-1893), French historian, was born at Vitry-sur-Seine on the 4th of April 1853, the second son of Ernest Havet. He early showed a remarkable aptitude for learning, but had a pronounced aversion for pure rhetoric. His studies at the École des Chartes (where he took first place both on entering and leaving) and at the École des Hautes Études did much to develop his critical faculty, and the historical method taught and practised at these establishments brought home to him the dignity of history, which thenceforth became his ruling passion. His valedictory thesis at the École des Chartes, *Série chronologique des gardiens et seigneurs des Îles Normandes* (1876), was a definitive work and but slightly affected by later research. In 1878 he followed his thesis by a study called *Les Cours royales dans les Îles Normandes*. Both these works were composed entirely from the original documents at the Public Record Office, London, and the archives of Jersey and Guernsey. On the history of Merovingian institutions, Havet's conclusions were widely accepted (see *La Formule N. rex Francor., v. ind.*,

1885). His first work in this province was *Des sens du mot "romain" dans les lois franques* (1876), a critical study on a theory of Fustel de Coulanges. In this he showed that the status of the *homo Romanus* of the barbarian laws was inferior to that of the German freeman; that the Gallo-Romans had been subjected by the Germans to a state of servitude; and, consequently, that the Germans had conquered the Gallo-Romans. He aimed a further blow at Fustel's system by showing that the Frankish kings had never borne the Roman title of *vir iuluster*, and that they could not therefore be considered as being in the first place Roman magistrates; and that in the royal diplomas the king issued his commands as *rex Francorum* and addressed his functionaries as *virii iuluster*. His attention having been drawn to questions of authenticity by the forgeries of Vrain Lucas, he devoted himself to tracing the spurious documents that encumbered and perverted Merovingian and Carolingian history. In his *A propos des découvertes de Jérôme Vignier* (1880), he exposed the forgeries committed in the 17th century by this priest. He then turned his attention to a group of documents relating to ecclesiastical history in the Carolingian period and bearing on the question of false decretals, and produced *Les Chartes de St-Calais* (1887) and *Les Actes de l'évêché de Meaux* (1894). On the problems afforded by the chronology of Gerbert's (Pope Sylvester II.) letters and by the notes in cipher in the MS. of his letters, he wrote *L'Écriture secrète de Gerbert* (1877), which may be compared with his *Notes tirées des diplômes mérovingiens* (1885). In 1889 he brought out an edition of Gerbert's letters, which was a model of critical sagacity. Each new work increased his reputation, in Germany as well as France. At the Bibliothèque Nationale, where he obtained a post, he rendered great service by his wide knowledge of foreign languages, and read voraciously everything that related, however remotely, to his favourite studies. He was finally appointed assistant curator in the department of printed books. He died prematurely at St Cloud on the 19th of August 1893.

After his death his published and unpublished writings were collected and published (with the exception of *Les Cours royales des Îles Normandes* and *Lettres de Gerbert*) in two volumes called *Questions mérovingiennes* and *Opuscules inédits* (1896), containing, besides important papers on diplomatic and on Carolingian and Merovingian history, a large number of short monographs ranging over a great variety of subjects. A collection of his articles was published by his friends under the title of *Mélanges Havet* (1895), prefixed by a bibliography of his works compiled by his friend Henri Omont. (C. B.)

HAVRE, LE, a seaport of north-western France, in the department of Seine-Inférieure, on the north bank of the estuary of the Seine, 143 m. W.N.W. of Paris and 55 m. W. of Rouen by the Western railway. Pop. (1906), 129,403. The greater part of the town stands on the level strip of ground bordering the estuary, but on the N. rises an eminence, la Côte, covered by the gardens and villas of the richer quarter. The central point of the town is the Place de l'hôtel de ville in which are the public gardens. It is crossed by the Boulevard de Strasbourg, running from the sea on the west to the railway station and the barracks on the east. The rue de Paris, the busiest street, starts at the Grand Quai, overlooking the outer harbour, and, intersecting the Place Gambetta, runs north and enters the Place de l'hôtel de ville on its southern side. The docks start immediately to the east of this street and extend over a large area to the south and south-east of the town. Apart from the church of Notre-Dame, dating from the 16th and 17th centuries, the chief buildings of Havre, including the hôtel de ville, the law courts, and the exchange, are of modern erection. The museum contains a collection of antiquities and paintings. Havre is the seat of a sub-prefect, and forms part of the maritime arrondissement of Cherbourg. Among the public institutions are a tribunal of first instance, a tribunal of commerce, a board of trade arbitrators, a tribunal of maritime commerce, a chamber of commerce and a branch of the Bank of France. There are lycées for boys and girls, schools of commerce and other educational establishments. Havre, which is a fortified place of the second class, ranks second to Marseilles among French seaports. There are nine basins (the oldest of which

dates back to 1669) with an area of about 200 acres and more than 8 m. of quays. They extend to the east of the outer harbour which on the west opens into the new outer harbour, formed by two breakwaters converging from the land and leaving an entrance facing west. The chief docks (see Dock for plan) are the Bassin Bellot and the Bassin de l'Eure. In the latter the mail-steamers of the Compagnie Générale Transatlantique are berthed; and the Tancarville canal, by which river-boats unable to attempt the estuary of the Seine can make the port direct, enters the harbour by this basin. There are, besides, several repairing docks and a petroleum dock for the use of vessels carrying that dangerous commodity. The port, which is an important point of emigration, has regular steam-communication with New York (by the vessels of the Compagnie Générale Transatlantique) and with many of the other chief ports of Europe, North, South and Central America, the West Indies and Africa. Imports in 1907 reached a value of £57,686,000. The chief were cotton, for which Havre is the great French market, coffee, copper and other metals, cacao, cotton goods, rubber, skins and hides, silk goods, dye-woods, tobacco, oil-seeds, coal, cereals and wool. In the same year exports were valued at £47,130,000, the most important being cotton, silk and woollen goods, coffee, hides, leather, wine and spirits, rubber, tools and metal ware, earthenware and glass, clothes and millinery, cacao and fancy goods. In 1907 the total tonnage of shipping (with cargoes) reached its highest point, viz. 5,671,975 tons (4018 vessels) compared with 3,816,340 tons (3832 vessels) in 1898. Forty-two per cent of this shipping sailed under the British flag. France and Germany were Great Britain's most serious rivals. Havre possesses oil works, soap works, saw mills, flour mills, works for extracting dyes and tannin from dye-woods, an important tobacco manufactory, chemical works and rope works. It also has metallurgical and engineering works which construct commercial and war-vessels of every kind as well as engines and machinery, cables, boilers, &c.

Until 1516 Havre was only a fishing village possessing a chapel dedicated to Notre-Dame de Grâce, to which it owes the name, Havre (harbour) de Grâce, given to it by Francis I. when he began the construction of its harbour. The town in 1562 was delivered over to the keeping of Queen Elizabeth by Louis I., prince de Condé, leader of the Huguenots, and the command of it was entrusted to Ambrose Dudley, earl of Warwick; but the English were expelled in 1593, after a most obstinate siege, which was pressed forward by Charles IX. and his mother, Catherine de' Medici, in person. The defences of the town and the harbour-works were continued by Richelieu and completed by Vauban. In 1694 it was vainly besieged by the English, who also bombarded it in 1750, 1794 and 1795. It was a port of considerable importance as early as 1572, and despatched vessels to the whale and cod-fishing at Spitsbergen and Newfoundland. In 1672 it became the entrepôt of the French East India Company, and afterwards of the Senegal and Guinea companies. Napoleon I. raised it to a war harbour of the first rank, and under Napoleon III. works begun by Louis XVI. were completed.

See A. E. Borely, *Histoire de la ville du Havre* (Le Havre, 1880-1891).

HAWAII (HAWAIIAN or SANDWICH ISLANDS), a Territory of the United States of America, consisting of a chain of islands in the North Pacific Ocean, eight inhabited and several uninhabited. The inhabited islands lie between latitudes 18° 54' and 22° 15' N., and between longitudes 154° 50' and 160° 30' W., and extend about 380 m. from E.S.E. to W.N.W.; the uninhabited ones, mere rocks and reefs, valuable only for their guano deposits and shark-fishing grounds, continue the chain several hundred miles farther W.N.W. From Honolulu, the capital, which is about 100 m. N.W. of the middle of the inhabited group, the distance to San Francisco is about 2100 m.; to Auckland, New Zealand, about 3810 m.; to Sydney, New South Wales, about 4410 m.; to Yokohama, about 3400 m.; to Hong-Kong, about 4920 m.; to Manila, about 4890 m. The total area of the inhabited islands is 6631 sq. m., distributed as

follows: Hawaii, 4210; Maui, 728; Oahu, about 600; Kauai, 547; Molokai, 261; Lanai, 139; Nihoa, 97; Kahoolawe, 69.

All the islands are of volcanic origin, and have been built up by the eruptive process from a base about 15,000 ft. below the sea to a maximum height (Mauna Kea) on the largest island (Hawaii) of 13,823 ft. above the sea; altogether there are forty volcanic peaks. Evidence of slight upheaval is occasionally afforded by an elevated coral-reef along the shore, and evidence of the subsidence of the S. portion of Oahu for several hundred feet has been discovered by artesian borings through coral-rock. In some instances, notably the high and nearly vertical wall along the N. shore of the E. half of Molokai, there is evidence of a fracture followed by the submergence of a portion of a volcano. With the exception of the coral and a small amount of calcareous sandstone, the rocks are entirely volcanic and range from basalt to trachyte, but are mainly basalt. Cinder cones and tufa cones abound, but one of the most distinguishing features of the Hawaiian volcanoes is the great number of craters of the engulfment type, i.e. pit-craters which enlarge slowly by the breaking off and falling in of their walls, and discharge vast lava-flows with comparatively little violence. The age of the several inhabited islands, or at least the time since the last eruptions on them, decreases from W. to E., and on the most easterly (Hawaii) volcanic forces are still in operation. That those to the westward have long been inactive is shown by the destruction of craters by denudation, by deep ravines, valleys and tall cliffs eroded on the mountain sides, especially on the windward side, by the depth of soil formed from the disintegrated rocks, and by the amount as well as variety of vegetable life.

Hawaii Island, from which the group and later the Territory was named, has the shape of a rude triangle with sides of 90 m., 75 m. and 65 m. Its coast, unlike that of the other islands of the archipelago, has few coral reefs. Its surface consists mainly of the gentle slopes of five volcanic mountains which have encroached much upon one another by their eruptions.

Mauna Loa ("Great Mountain"), on the S., is by far the largest volcano in the world; from a base measuring at sea-level about 75 m. from N. to S. and 50 m. from E. to W., it rises gradually to a height of 13,675 ft. On its E.S.E. side, at an elevation of 4000 ft. above the sea (300 ft. above the adjoining plain on the W.) is Kilauea, from whose lava-flows the island has been extended to form its S.E. angle. To the N.N.E. of Mauna Loa, and blending with it in an intervening plateau, is Mauna Kea ("White Mountain," so named from the snow on its summit), with a much smaller base but with steeper slopes and a crowning cinder cone 13,823 ft. above the sea, the maximum height in the Pacific Ocean; blending with Mauna Loa on the N.N.W. is Mauna Hualalai, 8266 ft. in height; and rising abruptly from the extreme N.W. shore are the remains of the oldest mountains of the island, the Kohala, with a summit 5505 ft. in height. On the land side the Kohala Mountains have been covered with lava from Mauna Kea, and form the broad plains of Kohala, having a maximum elevation of about 3000 ft.; on the ocean side, wherever this lava has not extended, erosion has gone on until bluffs 1000 ft. in height face the sea and the enormous gorges of Waipio and Waimanu, with nearly perpendicular walls as much as 3000 ft. high and extending inland 5-6 m., have been formed. Mauna Kea is not nearly so old as the Kohala Mountains, but there is no record of its eruption, nor have its lavas a modern aspect. The last eruption of Mauna Hualalai was in 1801. Mauna Loa and Kilauea are still active. Cinder cones are the predominant type of craters on both Mauna Kea and the Kohala Mountains, and they are also numerous on the upper slopes of Mauna Hualalai; but the more typically Hawaiian pit or engulfment craters also abound on Mauna Hualalai and Mokuawewe, crowning the summit of Mauna Loa, as well as Kilauea, to the S.E. of it, are prominent representatives of this type. Kilauea is the largest active crater in the world (8 m. in circumference) and is easily accessible. Enclosed by a circular wall from 200 to 700 ft. in height is a black and slightly undulating plain having an area of 4-14 sq. m., and within this plain is a pit, Halemaumau, of varying area (about 2000 ft. in diameter in 1905), now full of boiling lava, now empty to a depth of perhaps 1000 ft. When most active, Halemaumau affords a grand spectacle, especially at night: across the crust run glowing cracks, the crust is then broken into cakes, the cakes plunge beneath, lakes of liquid lava are formed, over whose surface play fire-fountains 10 to 30 ft. in height, the surface again solidifies and the process is repeated.¹ According to an account of the natives, a violent eruption of Kilauea occurred in 1789, or about that time, and deposits of volcanic sand, large stones, sponge-like scoria (pumice) and ashes for miles around are evidence of such an eruption. Since the Rev. William Ellis and a party of American missionaries first made the volcano known to the civilized

¹ Among the minor phenomena of Hawaiian volcanoes are the delicate glassy fibres called Pele's hair by the Hawaiians, which are spun by the wind from the rising and falling drops of liquid lava, and blown over the edge or into the crevices of the crater. Pele in idolatrous times was the dreaded goddess of Kilauea.

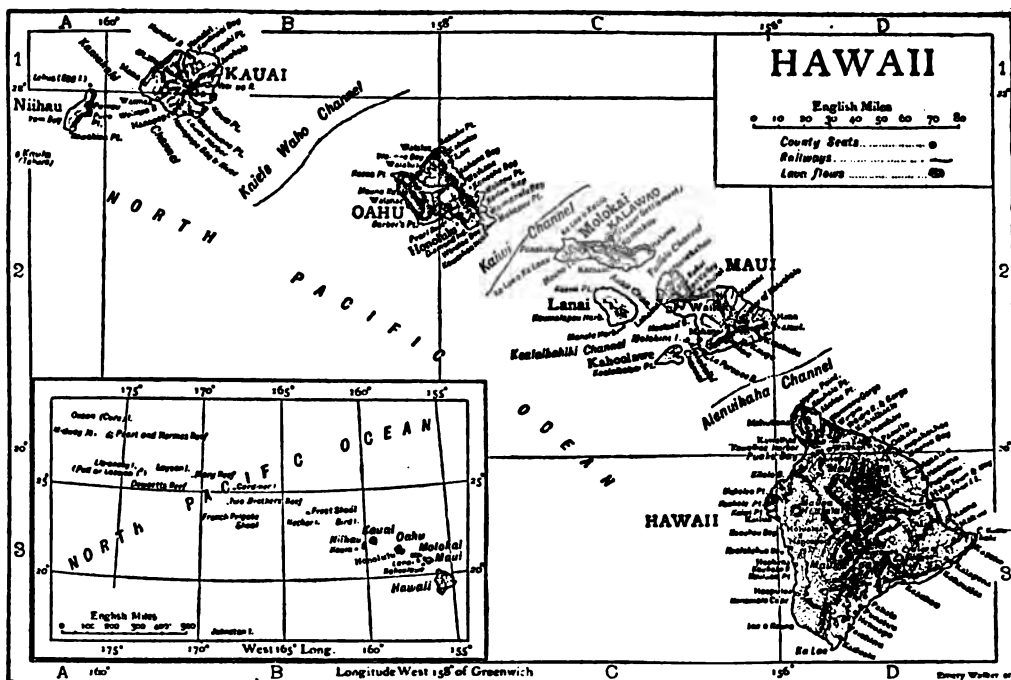

world in 1823, the eruptions have consisted mainly in the quiet discharge of lava through a subterranean passage into the sea. In the eruptions of 1823, 1832, 1840 and 1868 the floor of the crater rose on the eve of an eruption and then sank, sometimes hundreds of feet, with the discharge of lava; but since 1868 (in 1879, 1886, 1891, 1894 and 1907; and once, before 1868, in 1855) this action has been confined to Halemaoumau and such other pits as at the time existed.

Mokuawewewo, on the flat top of Mauna Loa, is a pit crater with a floor 3.7 sq. m. in area and sunk 500-600 ft. within walls that are almost vertical and that measure 9.47 m. in circumference. Formerly, on the eve of a great eruption of Mauna Loa, this crater often spouted forth great columns of flame and emitted clouds of vapour, but in modern times this action has usually been followed by a fracture of the mountain side from the summit down to a point 1000 ft. or more below where the lava was discharged in great streams, the action at the summit diminishing or wholly ceasing when this discharge began. The first recorded eruption of Mauna Loa was in 1832; since then there have been eruptions in 1851, 1852, 1855, 1859, 1868, 1880-1881, 1887, 1896, 1899 and 1907. The eruptions of 1868, 1887 and 1907 were attended by earthquakes; in 1868 huge sea waves, 40 ft. in height, were raised, and, as they broke on the S. shore, they destroyed the villages of Punaluu, Ninole, Kawaa and Honuapa. But the eruptions of Mauna Loa have consisted mainly in the quiet discharge of enormous flows of lava: in 1859 the lava-stream, which began to run on the 23rd of January, flowed N.W., reached the sea, 33 m. distant, eight days later, and continued to flow into it until the 25th of November; and the average length of the flows from seven other eruptions is nearly 14 m. The surface of the upper slopes of Mauna Loa is almost wholly of two widely different kinds of barren lava-flows, called by the Hawaiians the *pahoehoe* and the *aa*. The *pahoehoe* has a smooth but billowy or hummocky surface, and is marked by lines which show that it cooled as it flowed. The *aa* is lava broken into fragments having sharp and jagged edges. As the same stream sometimes changes abruptly from one kind to the other, the two kinds must be due to different conditions affecting the flow, and among the conditions which may cause a stream to break up into the *aa* have been mentioned the greater depth of the stream, a sluggish current, impediments in its course just as it is granulating, and, what is more probable, subterranean moisture which causes it to cool from below upward instead of from above downward as in the *pahoehoe*. The natives are in the habit of making holes in the *aa*, and planting in them banana shoots or sweet-potato cuttings, and though the holes are simply filled with stones or fern leaves, the

plants grow and in due time are productive. Another curious feature of Mauna Loa, and to some extent of other Hawaiian volcanoes, is the great number of caves, some of them as much as 60 to 80 ft. in height and several miles in length; they were produced by the escape of lava over which a crust had formed. In the midst of barren wastes to the S.E. and S.W. of Kilauea are small channels with steam cracks, along which appears the only vegetation of the region.

Maui, lying 26 m. N.W. of Hawaii, is composed of two mountains connected by an isthmus, Wailuku, 7 or 8 m. long, about 6 m. across, and about 160 ft. above the sea in its highest part.

Mauna Haleakala, on the E. peninsula, has a height of 10,032 ft., and forms a great dome-like mass, with a circumference at the base of 90 m. and regular slopes of only 8° or 9°. It has numerous cinder cones on its S.W. slope, is well wooded on the N. and E. slopes, and has on its summit an extinct pit-crater which is one of the largest in the world. This crater is 7.48 m. long, 2.37 m. wide, and covers 19 sq. m.; the circuit of its walls, which are composed of a hard grey clinkstone much fissured, is 20 m.; its greatest depth is 2720 ft. At opposite ends are breaks in the walls a mile or more in width—one about 1000 ft., the other at least 3000 ft. in depth—through which poured the lava of probably the last great eruption. From the floor of the crater rise sixteen well-preserved cinder-cones, which range from more than 400 ft. to 900 ft. in height. Along the N. base of the mountain are numerous ravines (several hundred feet deep), to the bottom of which small streams of water fall in long cascades, but elsewhere on the eastern mountain there is little erosion or other mark of age. That the mountainous mass of western Maui is much older is shown by the destruction of its crater, by its sharp ridges and by deeply eroded gorges or valleys. Its highest peak, Puu Kukui, rises 5788 ft. above the sea, and directly under this is the head of Iao Valley, 5 m. long and 2 m. wide, which has been cut in the mountain to a depth of 4000 ft. This and the smaller valleys are noted for the beauty of their tropical scenery.

Kahoalawe is a small island 6 m. S.W. of Maui. It is 14 m. long by 6 m. wide. Its mountains, which rise to a height of 1472 ft., are rugged and nearly destitute of verdure, but the intervening valleys afford pasture for sheep.

Lanai is another small island, 7 m. W. of Maui, about 18 m. long and 12 m. wide. It has a mountain range which rises to a

maximum height, S.E. of its centre, of about 3480 ft. The N.E. slope is cut by deep gorges, and at the bottom of one of these, which is 2000 ft. deep, is the only water-supply on the island. On the S. side is a rolling table-land affording considerable pasturage for sheep, but over the whole N.W. portion of the island the trade winds, driving through the channel between Maui and Molokai, sweep the rocks bare. Kahoolawe and Lanai are both privately owned.

Molokai, 8 m. N.W. of Maui, extends 40 m. from E. to W. and has an average width of nearly 7 m. From the S.W. extremity of the island rises the backbone of a ridge which extends E.N.E. about 10 m., where it culminates in the round-topped hill of Mauna Loa, 1382 ft. above the sea. Both the northern and southern slopes of this ridge are cut by ravines and gulches, and along the N. shore is a steep sea-cliff. At the E. extremity of the ridge there is a sudden drop to a low and gently rolling plain, but farther on the surface rises gradually towards a range of mountains which comprises more than one-half the island and attains a maximum height of 4958 ft. in the peak of Kama-kou. The S. slope of this range is gradual but is cut by many straight and narrow ravines, in some instances to a great depth. The N. slope is abrupt, with precipices from 1000 to 4000 ft. in height. Extending N. from the foot of the precipice, a little E. of the centre of the island, is a comparatively low peninsula (separated from the mainland by a rock wall 2000 ft. high), on which is a famous leper settlement. The peninsula forms a separate county, Kalawao.

Oahu, 23 m. N.W. of Molokai, has an irregular quadrangular form. It is traversed from S.E. to N.W. by two roughly parallel ranges of hill separated by a plain that is 20 m. long and in some parts 9 to 10 m. wide. The highest point in the island is Mauna Keala, 4030 ft., in the Waianae or W. range; but the Koolau or E. range is much longer than the other, and its ridge is very much broken; on the land side there are many ravines formed by lateral spurs, but to the sea for 30 m. it presents a nearly vertical wall without a break. The valleys are remarkable for beautiful scenery,—peaks, cliffs, lateral ravines, cascades and tropical vegetation. There are few craters on the loftier heights, but on the coasts there are several groups of small cones with craters, some of lava, others of tufa. The greater part of the coast is surrounded by a coral reef, often half a mile wide; in several localities an old reef upheaved, sometimes 100 ft. high, forms part of the land.

Kauai, 63 m. W.N.W. of Oahu, has an irregularly circular form with a maximum diameter of about 25 m. On the N.W. is a precipice 2000 ft. or more in height and above this is a mountain plain, but elsewhere around the island is a shore plain, from which rises Mount Waialeale to a height of 5250 ft. The peaks of the mountain are irregular, abrupt and broken; its sides are deeply furrowed by gorges and ravines; the shore plain is broken by ridges and by broad and deep valleys; no other island of the group is so well watered on all sides by large mountain streams; and it is called "garden isle."

Niihau, the most westerly of the inhabited islands, is 18 m. W. by S. of Kauai. It is 10 m. long and 6 m. wide. The western two-thirds consists of a low plain, composed of an uplifted coral reef and matter washed down from the mountains; but on the E. side the island rises precipitously from the sea and attains a maximum height of 1304 ft. at Paniau. There are large salt lagoons on the southern coast.

Climate.—The climate is cooler than that of other regions in the same latitude, and is very healthy. The sky is usually cloudless or only partly cloudy. The N.E. trades blow with periodic variations from March to December; and the leeward coast, being protected by high mountains, is refreshed by regular land and sea breezes. During January, February and a part of March the wind blows strongly from the S. or S.W.; and at this season an unpleasant hot, damp wind is sometimes felt. More rain falls from January to May than during the other months; very much more falls on the windward side of the principal islands than on the leeward; and the amount increases with the elevation also up to about 4000 ft. The greatest recorded extremes of local rainfall for a year within the larger islands range from 12 to 300 in. For Honolulu the mean annual rainfall (1884-1899) was 28.18 in.; the maximum 49.82; and the

minimum 13.46. At sea level the daily average temperature for July is 76.4° F., for December 70.7° F.; the mean annual temperature is about 73° F.—68° during the night, 86° during the day—and for each 200 ft. of elevation the temperature falls about 1° F., and snow lies for most of the time on the highest mountains.

Flora.—The Hawaiian Islands have a peculiar flora. As a result of their isolation, the proportion of endemic plants is greater here than in any other region, and the great elevation of the mountains, with the consequent variation in temperature, moisture and barometric pressure, has multiplied the number of species. Towards the close of the 19th century William Hillebrand found 365 genera and 999 species, and of this number of species 653 were peculiar to this part of the Pacific. The number of species is greatest on the older islands, particularly Kauai and Oahu, and the total number for the group has been constantly increasing, some being introduced, others possibly being produced by the varying climatic conditions from those already existing. Among the peculiar dicotyledonous plants there is not a single annual, and by far the greater number are perennial and woody. Hawaiian forests are distinctly tropical, and are composed for the most part of trees below the medium height. They are most common between elevations of 2000 and 8000 ft.; there are only a few species below 2000 ft., and above 8000 ft. the growth is stunted. The destruction of considerable portions of the forests by cattle, goats, insects, fire and cutting has been followed by re-foresting, the planting of hitherto barren tracts, the passage of severe forest fire laws, and the establishment of forest reserves, of which the area in 1909 was 545,746 acres, of which 357,180 were government land. In regions of heavy rainfall the ohia-lehua (*Metrosideros polymorpha*), a tree growing from 30 to 100 ft. in height, is predominant, and on account of the dense undergrowth chiefly of ferns and climbing vines, forms the most impenetrable of the forests; its hard wood is used chiefly for fuel. The koa (*Acacia koa*), from the wood of which the natives used to make the bodies of their canoes, and the only tree of the islands that furnishes much valuable lumber (a hard cabinet wood marketed as "Hawaiian mahogany"), forms extensive forests on Hawaii and Maui between elevations of 2000 and 4000 ft. The mamane (*Sophora chryzophylla*), which furnishes the best posts, grows principally on the high slopes of Mauna Kea and Hualalai. Posts and railway ties are also made from ohia-ha (*Eugenia sandwicensis*). In many districts between elevations of 2000 and 6000 ft., where there is only a moderate amount of moisture, occur mixed forests of koa, koaia (*Acacia koaia*), kopiko (*Straussia uncarpa* and *S. hawaiiensis*), kolea (*Myrsine hawaiiensis* and *M. lanaiensis*), naio or bastard sandalwood (*Myoporum sandwicense*) and pua (*Olea sandwicensis*); of these the koaia furnishes a hard wood suitable for the manufacture of furniture, and out of it the natives formerly made spears and fancy paddles. The wood of the naio when dry has a fragrance resembling that of sandalwood, and is used for torches in fishing. The kukui (*Aleurites triloba*) and the algaroba (*Prosopis juliflora*) are the principal species of forest trees that occur below elevations of 2000 ft. The kukui grows along streams and gulches; from its nuts, which are very oily, the natives used to make candles, and it is still frequently called the candle-nut tree. On the leeward side, from near the sea level to elevations of 1500 ft., and on ground that was formerly barren, the algaroba tree has formed dense forests since its introduction in 1837. Forests of iron-wood and blue gum have also been planted. Sandalwood (*Santalum album* or *freycinetianum*) was once abundant on rugged and rather inaccessible heights, but so great a demand arose for it in China, where it was used for incense and for the manufacture of fancy articles, that the supply was nearly exhausted between 1802 and 1836; since then some young trees have sprung up, but the number is relatively small. Other peculiar trees prized for their wood are: the kauila (*Alphitonia ponderosa*), used for making spears, mallets and other tools; the kela (*Meconeuron hawaiiense*), the hard wood of which resembles ebony; the halapepe (*Dracaena aurea*), out of the soft wood of which the natives carved many of their idols; and the wilwili (*Erythrina monosperma*), the wood of which is as light as cork and is used for outriggers. In 1909, on six large rubber plantations, mostly on the windward side of the island of Maui, there were planted 444,450 ceara trees, 66,700 bevea trees, and 600 castilloa trees. About the only indigenous fruit-bearing plants are the Chilean strawberry (*Fragaria chilensis*) and the obelo berry (*Vaccinium reticulatum*), both of which grow at high elevations on Hawaii and Maui. The obelo berry is famous in song and story, and formerly served as a propitiatory offering to Pele. The number of fruit-bearing trees, shrubs and plants that have been introduced and are successfully cultivated or grow wild is much greater; among them are the mango, orange, banana, pineapple, coconut, palm, grape, fig, strawberry, litchi (*Nephelium litchi*)—the favourite fruit of the Chinese—avocado or alligator pear (*Persea gratissima*), Sapodilla pear (*Achras zapota*), loquat or mesquillo plum (*Eriobotrya japonica*), Cape gooseberry (*Physalis peruviana*), tamarind (*Tamarindus indica*), papaw (*Carica papaya*), resembling in appearance the cantaloupe, granadilla (*Passiflora quadrangularis*) and guava (*Psidium guajava*). Most of the native grasses are too coarse for grazing, and some of

¹ The Chinese name for the Hawaiian Islands means "Sandalwood Islands."

them, particularly the hilo grass (*Paspalum conjugatum*), which forms a dense mat over the ground, prevent the spread of forests. The pili grass (*Heteropogon contortus*) is also noxious, for its awns get badly entangled in the wool of sheep. The native manieie (*Stenolophrum americanum*) and kukai (*Panicum pruriens*), however, are relished by stock and are found on all the inhabited islands; the Bermuda grass (*Cynodon dactylon*), a June grass (*Poa annua*), and Guinea grass (*Panicum jumentorum*) have also been successfully introduced. The *Paspalum orbiculare* is the large swamp grass with which the natives covered their houses. On the island of Niihau is a fine grass (*Cyperus laevigatus*), out of which the beautiful Niihau mats were formerly made; it is used in making Panama hats. Mats were also made of the leaves of the hala tree (*Pandanus odoratissimus*). The wauke plant (*Broussonetia papyrifera*), and to a less extent the mamake (*Pipturus albidus*) and *Boehmeria stipularis*, furnished the bark out of which the famous kapa cloth was made, while the olopa (*Cheirandendron gaudichaudii*) and the koolen (*Myrsine laevisiana*) furnished the dyes with which it was coloured. From several species of *Cibotium* is obtained a glossy yellowish wool, used for making pillows and mattresses. Ferns, of which there are about 130 species varying from a few inches to 30 ft. in height, form a luxuriant undergrowth in the ohia-koa and the koa forests, and the islands are noted for the profusion and beautiful colours of their flowering plants. Kalo (*Colocasia antiquorum*, var., *esculenta*), which furnishes the principal food of the natives, and sugar cane (*Saccharum officinarum*), the cultivation of which has become the chief industry of the islands, were introduced before the discovery of the group by Captain Cook in 1778. Sisal hemp has been introduced, and there is a large plantation of it W. of Honolulu.

Over seventy varieties of seaweeds, growing in the fresh-water pools and in the waters near the coast, are used by the natives as food. These *limus*, as they are called by the Kanakas, are washed, salted, broken and eaten as a relish or as a flavouring for fish or other meat. The culture of such algae may prove of economic importance; gelatine, glue and agar-agar would be valuable by-products.

Fauna.—A day-flying bat, whales and dolphins are about the only indigenous mammals; hogs, dogs and rats had been introduced before Cook's discovery. Fish in an interesting variety of colours and shapes abound in the sea and in artificial ponds along the coasts.¹ There are some fine species of birds, and the native avifauna is so distinctive that Wallace argued from it that the Hawaiian Archipelago had long been separated from any other land. There were native names for 89 varieties. The most typical family is the *Drepanidæ*, so named for the stout sickle-shaped beak with which the birds extract insects from heavily-barked trees; Gadow considers the family American in its origin, and thinks that the *Moho*,² a family of honey-suckers, were later comers and from Australia. The *mamo* (*Drepanis pacifica*) has large golden feathers on its back; it is now very rare, and is seldom found except on Mauna Loa, Hawaii, about 4000 ft. above the sea. The smaller yellow feathers, once used for the war cloaks of the native chiefs, were furnished by the *oo* (*Moho nobilis*) and the *oa* (*Moho braccatus*), now found only occasionally in the valleys of Kaula near Hanalei, on the N. side of the island; scarlet feathers for similar mantles were taken from the *iviv* (*Vestiaria coccinea*), a black-bodied, scarlet-winged song-bird, which feeds on nectar and on insects found in the bark of the koa and ohia trees, and from the *Fringilla coccinea*. In the old times birds were protected by the native belief that divine messages were conveyed by bird cries, and by royal edict forbidding the killing of species furnishing the material for feather cloaks, contributions towards which were long almost the only taxes paid. Thus the downfall of the monarchy and of the ancient cults have been nearly fatal to some of the more beautiful birds; feather ornaments, formerly worn only by nobles, came to be a common decoration; and many species (for example the Hawaiian gallinule, *Gallinula sandwicensis*, which, because of its crimson frontal plate and bill, was said by the natives to have played the part of Prometheus, burning its head with fire stolen from the gods and bestowed on mortals) have been nearly destroyed by the mongoose, or have been driven from their lowland homes to the mountains, such being the fate of the *mamo*, mentioned above, and of the Sandwich Island goose (*Bernicla sandwicensis*), which is here a remarkable example of adaptation, as its present habitat is quite arid. This goose has been introduced successfully into Europe. A bird called *moho*, but actually of a different family, was the *Pennisia scodudata* or *millsii*, which had hardly any tail, and had wings so degenerate that it was commonly thought wingless. The turnstone (*Sireptilus interpres*) arrives in the islands in August after breeding in Alaska. There are no parrots. The only reptiles are three species of skinks and four of the gecko; the islands are famed for their freedom from

snakes. Land-snails, mostly *Achatinellidæ*, are remarkably frequent and diverse; over 300 varieties exist. Insects are numerous, and of about 500 species of beetle some 80% are not known to exist elsewhere; cockroaches and grebe locusts are pests, as are, also, mosquitoes,³ wasps, scorpions, centipedes and white ants, which have all been introduced from elsewhere.

Soil.—The soil of the Territory is almost wholly a decomposition of lava, and in general differs much from the soils of the United States, particularly in the large amount of nitrogen (often more than 1.25% in cane and coffee soil, and occasionally 2.2%) and iron, and in the high degree of acidity. High up on the windward side of a mountain it is thin, light red or yellow, and of inferior quality. Low down on the leeward side it is dark red and fertile, but still too pervious to retain moisture well. In the older valleys on the islands of Kauai, Oahu and Maui, as well as on the lowland plain of Molokai, the soil is deeper and usually, too, the moisture is retained by a heavy clay. In some places along the coast there is a narrow strip of decomposed coral limestone; often, too, a coral reef has served to catch the sediment washed down the mountain side until a deep sedimentary soil has been deposited. On the still lower levels the soil is deepest and most productive.

Agriculture.—The tenure by which lands were held before 1898 was strictly feudal, resembling that of Germany in the 11th century, and lands were sometimes enfeoffed to the seventh degree. But in the "Great Division" which took place in 1848 and forms the foundation of present land titles, about 98,000 acres, nearly one-fourth of the inhabited area, were set apart for the crown, about 1,495,000 acres for the government, and about 1,619,000 acres for the several chiefs; and the common people received fee-simple titles⁴ for their house lots and the pieces of land which they cultivated for themselves, about 28,600 acres, almost entirely in isolated patches of irregular shape hemmed in by the holdings of the crown, the government or the great chiefs. Generally the chiefs ran into debt; many died without heirs; and their lands passed largely into the hands of foreigners. At the abolition of the monarchy in 1893, the crown domains were declared to be public lands, and, with the other government lands, were by the terms of annexation turned over to the United States in 1898. They had been offered for sale or lease in accordance with land acts (of 1884 and 1895—the latter corresponding generally to the land laws of New Zealand) designed to promote division into small farms and their immediate improvement. In 1909 the area of the public land was about 1,700,000 acres. In 1900 there were in the Territory 2273 farms, of which 1209 contained less than 10 acres, 785 contained between 10 and 100 acres, and 116 contained 1000 acres or more. The natives seldom cultivate more than half an acre apiece, and the Portuguese settlers usually only 25 or 30 acres at most. Of the total area of the Territory only 86,854 acres, or 2.77%, were under cultivation in 1900, and of this 65,687 acres, or 75.6%, were divided into 170 farms and planted to sugar-cane. In 1900 it was estimated that 213,000 acres (about half of which was irrigated) were planted to sugar, one half being cropped each year. The average yield per acre of cane-sugar is the greatest in the world, 30 to 40 tons of cane being an average per acre, and as much as 10½ tons of sugar having been produced from a single acre under irrigation. The cultivation of the cane was greatly encouraged by the Reciprocity Treaty of 1875, which established practically free trade between the islands and the United States, and since 1879 it has been widely extended by means of irrigation, the water being obtained both by pumping from numerous artesian wells and by conducting surface water through canals and ditches. The sugar farms are mostly on the islands of Hawaii, Oahu, Maui and Kauai, at the bases of mountains; those on the leeward side have the better soil, but require much more irrigating. The product increased from 26,072,429 lb in 1876 to 259,789,462 lb in 1890, 542,098,500 lb in 1899 and about 1,060,000,000 lb (valued at more than \$40,000,000) in 1909. Nearly all of it is exported to the United States. Rice was the second product in importance until competition with Japan, Louisiana and Texas made the crop a poor investment; improved culture and machinery may restore rice culture to its former importance. It is grown almost wholly by Japanese and Chinese on small low farms along the coasts, mostly on the islands of Kauai and Oahu. In 1899 the product amounted to 33,442,400 lb; in 1907 about 12,000 acres were planted, and the crop was estimated to be worth \$2,500,000. Coffee of good quality is grown at elevations ranging between 1000 to 3000 ft. above the sea; the Hawaiian product is called Kona coffee—from Kona, a district of the S. side of Hawaii island, where much of it is grown. In 1909 about 4500 acres were in coffee, the value of the crop was \$350,000; and 1,763,119 lb of coffee, valued at \$211,535, were exported from Hawaii to the mainland of the United States. A few bananas and (especially from Oahu) pineapples of fine quality are exported; since 1901 the canning of

¹ Partly described by T. S. Streets, *Contributions to the Natural History of the Hawaiian and Fanning Islands*, Bulletin 7 of U.S. National Museum (Washington, 1877). Several new species are described in U.S. Bureau of Fisheries Document, No. 623 (Washington, 1907).

² So Lesson called the family from the native name in 1831; Cabanis (1847) suggested *Aerolocercus*.

³ The entomological department of the Hawaii Experiment Station undertakes "mosquito control," and in 1905-1906 imported top-minnows (*Poeciliidæ*) to destroy mosquito larvae.

⁴ These and other title-holders received corresponding rights to the use of irrigation ditches, and to fish in certain sea areas adjacent to their holdings.

pineapples has been successfully carried on, and in the year ending May 31, 1907, 186,700 cases were exported, being packed in nine canneries. Oranges, lemons, limes, figs, mangoes, grapes and peaches, besides a considerable variety of vegetables, are raised in small quantities for local consumption. In 1909 the exports of fruits and nuts to the continental United States were valued at \$1,457,644. An excellent quality of sisal is grown. Rubber trees have been planted with some success, particularly on the eastern part of the island of Maui; they were not tapped for commercial use until 1909. In 1907 there were vanilla plantations in the islands of Oahu and Hawaii. Tobacco of a high grade, especially for wrappers, has been grown at the Agricultural Experiment Station's farm at Hamakua, on the island of Hawaii, where the tobacco is practically "shade grown" under the afternoon fogs from Mauna Kea. Cotton and silk culture have been experimented with on the islands; and the work of the Hawaiian Agricultural Experiment Station is of great value, in introducing new crops, in improving old, in studying soils and fertilizers and in entomological research. Honey is a crop of some importance; in 1908 the yield was about 950 tons of honey and 15 tons of wax. The small islands of Lanai, Nihaui and Kahoolawe are devoted chiefly to the raising of sheep and cattle—Nihaui is one large privately owned sheep-ranch. There are large cattle-ranches on the islands supplying nearly all the meat for domestic consumption, and cattle-raising is second in importance to the sugar industry. It was estimated in 1908 that there were about 130,500 cattle and about 99,300 sheep on the islands. The "native" cattle, descended from those left on the islands by early navigators, are being improved by breeding with imported Hereford, Shorthorn, Angus and Holstein bulls, the Herefords being the best for the purpose. In the fiscal year 1908, 359,413 lb of wool (valued at \$58,133) and 928,599 lb of raw hides (valued at \$87,599) were shipped from the Territory to the United States.

Minerals.—The islands have large (unworked) supplies of pumice, sandstone, sulphur, gypsum, alum and mineral-paint ochres, and some salt, kaolin and sal-ammoniac, but otherwise they are without mineral wealth other than lava rocks for building purposes.

Manufactures.—The manufactures are chiefly sugar, fertilizers, and such products of the foundry and machine shop as are required for the machinery of the sugar factories. Most of the manufacturing industries, indeed, are maintained for supplying the local market, there being only three important exceptions—the manufacture of sugar, the cleaning of coffee and the cleaning and polishing of rice. The manufacture of sugar, which began between 1830 and 1840, has long been much the most important of the manufacturing industries; thus in 1900 the value of the sugar production was \$19,254,773, and the total value of all manufactures, including custom work and repairing, was only \$24,992,068. Next to sugar, fertilizers were the most important manufactured product, their value being \$1,150,625; the products of the establishments for the polishing and cleaning of rice were valued at \$664,300. Of the total product in 1900, only 18.5% (by value) is to be credited to the city of Honolulu. The growth of manufacturing is much hampered by the lack of labour. Excellent water power is utilized on the island of Kauai in an electric plant.

Communications.—There are good wagon roads on the islands, some of them macadamized, built of the hard blue lava rock. Hawaii had in 1909 about 200 m. of railway, of which the principal line is that of the Oahu Railway & Land Company (about 89 m.), extending from Honolulu W. and N. along the coast to Kahuku about one-half the distance around Oahu; another line from Kahuku Mill, the most northerly point of the island, S.E. to Honolulu, was projected in 1905; on the island of Hawaii is the Hilo Railroad (about 46 m.), carrying sugar, pineapples, rubber and lumber; other railways are for the most part short lines on sugar estates and in coffee-producing sections of the islands of Hawaii and Maui. Each of the larger islands has one or more ports which a local steamboat serves regularly, and Honolulu has the regular service of seven trans-Pacific lines (the American-Hawaiian Steamship Co., the Canadian-Australian Steamship Co., the Matson Navigation Co., the Oceanic Steamship Co., the Pacific Mail Steamship Co., the Mexican Oriental and the Toyo Kisen Kaisha); it is a midway station for vessels between the United States (mainland) and Australia and Southern Asia. In 1908 five steamship companies were engaged in traffic between island ports and the mainland (including Mexico). Honolulu has cable connexion with San Francisco and the East, and the several islands of the group are served by wireless telegraph.

Commerce.—The position of the archipelago, at the "cross-roads" of the North Pacific, has made it commercially important since the days of the whale fishery, and it has a practical monopoly of coaling, watering and victualling. Its main disadvantage is the lack of harbours—Honolulu and Pearl Harbor are the only ones in the archipelago; but under the River and Harbour Act of 1905 examinations and surveys were made to improve Hilo Bay on the island of Hawaii. Pearl Harbor is the U.S. naval station, and a great naval dock, nearly 1200 ft. long, was projected for the station in 1908. Within recent years commerce has grown greatly in volume; it has always been almost entirely with the United States. In 1880 the value of imports from the United States was \$2,086,000, that of exports to the United States was \$4,606,000; in 1907 the value of shipments

of domestic merchandise from the United States to Hawaii was \$15,357,907, and the value of shipments of domestic merchandise from Hawaii to the United States was \$31,984,433, of which \$30,111,524 was the value of brown sugar, \$133,133 the value of rice, \$601,748 the value of canned fruits, \$124,146 the value of green, ripe or dried fruits, \$117,403 the value of hides and skins, and \$105,515 the value of green or raw coffee. The shipments of foreign merchandise each way are relatively insignificant. In the fiscal year 1908 the exports from Hawaii to foreign countries were valued at \$597,640, ten times as much as in 1905 (\$59,541); the imports into Hawaii from foreign countries were valued at \$4,682,399 in the fiscal year 1908, as against \$3,014,964 in 1905.

Population.—The total population of the islands in 1890 was 89,990; in 1900 it was 154,001, an increase within the decade of 71.13%; in 1910 it was 191,909. In 1908 there were about 72,000 Japanese, 18,000 Chinese, 5000 Koreans, 23,000 Portuguese, 2000 Spanish, 2000 Porto Ricans, 35,000 Hawaiians and part Hawaiians and 12,000 Teutons. Of the total for 1900 there were 61,111 Japanese, 25,767 Chinese and 233 negroes; of the same total there were 90,780 foreign-born, of whom 56,234 were natives of Japan, and 6512 were natives of Portugal. There were in all in 1900, 106,369 males (69.1%); a preponderance due to the large number of Mongolian labourers, whose wives are left in Asia) and only 47,632 females. About three-fifths of the Hawaiians and nearly all of American, British or North European descent are Protestants. Most of the Portuguese and about one-third of the native Hawaiians are Roman Catholics. The Mormons claim more than 4000 adherents, whose principal settlement is at Laie, on the north-east shore of Oahu; the first Mormon missionaries came to the islands in 1850. The population of 1910 was distributed among the several islands as follows: Oahu, 82,028; Hawaii, 55,382; Kauai and Nihaui, 23,952; Kalawao, 785; and Maui, Lanai, Kahoolawe and Molokai, 29,762. The population of Honolulu district, the entire urban population of the Territory, was 22,907 in 1890, 39,306 in 1900, and 52,183 in 1910.

The aboriginal Hawaiians (sometimes called Kanakas, from a Hawaiian word *kanaka*, meaning "man") belong to the Malayo-Polynesian race; they probably settled in Hawaii in the 10th century, having formerly lived in Samoa, and possibly before that in Tahiti and the Marquesas. Their reddish-brown skin has been compared in hue to tarnished copper. Their hair is dark brown or black, straight, wavy or curly; the beard is thin, the face broad, the profile not prominent, the eyes large and expressive, the nose somewhat flattened, the lips thick, the teeth excellent in shape and of a pearly whiteness. The skull is sub-brachycephalic in type, with an index of 82.6 from living "specimens" and 79 from a large collection of skulls; it is never prognathous. Most of the people are of moderate stature, but the chiefs and the women of their families have been remarkable for their height, and 400 pounds was formerly not an unusual weight for one of this class. This corpulence was due not alone to over-feeding but to an almost purely vegetable diet; stoutness was a part of the ideal of feminine beauty. The superiority in physique of the nobles to the common people may have been due in part to a system of massage, the *lomi-lomi*; it is certainly contrary to the belief in the bad effects of inbreeding—among the upper classes marriage was almost entirely between near relatives.

The Rev. William Ellis, an early English missionary, described the natives as follows: "The inhabitants of these islands are, considered physically, amongst the finest races in the Pacific, bearing the strongest resemblance to the New Zealanders in stature, and in their well-developed muscular limbs. The tattooing of their bodies is less artistic than that of the New Zealanders, and much more limited than among some of the other islanders. They are also more hardy and industrious than those living nearer the equator. This in all probability arises from their salubrious climate, and the comparative sterility of their soil rendering them dependent upon the cultivation of the ground for the yam, the arum, and the sweet potato, their chief articles of food. Though, like all undisciplined races, the Sandwich Islanders [Hawaiians] have proved deficient in firm and steady perseverance, they manifest considerable intellectual capability. Their moral character, when first visited by Europeans, was not

Native
popula-
tion.

superior to that of other islanders; and excepting when improved and preserved by the influence of Christianity, it has suffered much from the vices of intemperance and licentiousness introduced by foreigners. Polygamy prevailed among the chiefs and rulers, and women were subject to all the humiliations of the tabu system, which subjected them to many privations, and kept them socially in a condition of inferiority to the other sex. Infanticide was practised to some extent, the children destroyed being chiefly females. Though less superstitious than the Tahitians, the idolatry of the Sandwich Islanders was equally barbarous and sanguinary, as, in addition to the chief objects of worship included in the mythology of the other islands, the supernatural beings supposed to reside in the volcanoes and direct the action of subterranean fires rendered the gods objects of peculiar terror. Human sacrifices were slain on several occasions, and vast offerings presented to the spirits supposed to preside over the volcanoes, especially during the periods of actual eruptions. The requisitions of their idolatry were severe and its rites cruel and bloody. Grotesque and repulsive wooden figures, animals and the bones of chiefs were the objects of worship. Human sacrifices were offered whenever a temple was to be dedicated, or a chief was sick, or a war was to be undertaken; and these occasions were frequent. The apprehensions of the people with regard to a future state were undefined, but fearful. The lower orders expected to be slowly devoured by evil spirits, or to dwell with the gods in burning mountains. The several trades, such as that of fisherman, the tiller of the ground, and the builder of canoes and houses, had each their presiding deities. Household gods were also kept, which the natives worshipped in their habitations. One merciful provision, however, had existed from time immemorial, and that was [the *punohonus*] sacred inclosures, places of refuge, into which those who fled in time of war, or from any violent pursuer, might enter and be safe. To violate their sanctity was one of the greatest crimes of which a man could be guilty." The native religion was an admixture of idolatry and hero-worship, of some ethical but little moral force. The king was war chief, priest and god in one, and the shocking licence at the death of a king was probably due to the feeling that all law or restraint was annulled by the death of the king—incarnate law. The mythic and religious legends of the people were preserved in chants, handed down from generation to generation; and in like poetic form was kept the knowledge of the people of botany, medicine and other sciences. Name-songs, written at the birth of a chief, gave his genealogy and the deeds of his ancestors; dirges and love-songs were common. These were without rhyme or rhythm, but had alliteration and a parallelism resembling Hebrew poetry. Drums, gourd and bamboo flutes, and a kind of guitar, were known before Cook's day.

When the islands first became known to Europeans, the Hawaiian family was in a stage including both polyandry and polygyny, and, according to Morgan, older than either: two or more brothers, with their wives, or two or more sisters with their husbands, cohabited with seeming promiscuity. This system called *punalua* (a word which in the modern vernacular means merely "dear friend") was first brought to the attention of ethnologists in 1871 by Lewis H. Morgan (who was incorrect in many of his premises) and was made the basis of his second stage, the *punaluan*, in the evolution of the family. These conditions did not last long after the coming of the missionaries. Descent was more commonly traced through the female line. As regard cannibalism, it appears that the heart and liver of the human victims offered in the temples were eaten as a religious rite, and that the same parts of any prominent warrior slain in battle were devoured by the victor chiefs, who believed that they would thereby inherit the valour of the dead man. Under *taboo* as late as 1819 women were to be put to death if they ate bananas, cocoa-nuts, pork, turtles or certain fish. In the days of idolatry the only dress worn by the men was a narrow strip of cloth wound around the loins and passed between the legs. Women wore a short petticoat made of *kapa* cloth (already referred to), which reached from the waist to the knee. But now

the common class of men wear a shirt and trousers; the better class are attired in the European fashion. The women are clad in the *holoka*, a loose white or coloured garment with sleeves, reaching from the neck to the feet. A coloured handkerchief is twisted around the head or a straw hat is worn. Both sexes delight in adorning themselves with garlands (*leis*) of flowers and necklaces of coloured seeds. The Hawaiians are a good-tempered, light-hearted and pleasure-loving race. They have many games and sports, including boxing, wrestling (both in and out of water), hill-sliding, spear-throwing, and a game of bowls played with stone discs. Both sexes are passionately fond of riding. They delight to be in the water and swim with remarkable skill and ease. In the exciting sport of surf-riding, which always astonishes strangers, they balance themselves lying, kneeling or standing on a small board which is carried landwards on the curling crest of a great roller. All games were accompanied by gambling. Dances, especially the indecent *hula*, "danse du ventre," were favourite entertainments.

Even at the time when they were first known to Europeans, they had stone and lava hatchets, shark's-tooth knives, hard-wood spades, *kapa* cloth or paper, mats, fans, fish-hooks and nets, woven baskets, &c., and they had introduced a rough sort of irrigation of the inland country with long canals from highlands to plains. They derived their sustenance chiefly from pork and fish (both fresh and dried), from seaweed (*limu*), and from the *kalo* (*Colocasia antiquorum*, var. *esculenta*), the banana, sweet potato, yam, bread-fruit and cocoa-nut. From the root of the *kalo* is made the national dish called *poi*; after having been baked and well beaten on a board with a stone pestle it is made into a paste with water and then allowed to ferment for a few days, when it is ready to be eaten. One of the table delicacies of former days was a particular breed of dog which was fed exclusively on *poi* before it was killed, cooked and served. Like other South Sea Islanders they made an intoxicating drink, *ava* or *kava*, from the roots of the *Macropiper latifolium* or *Piper methysticum*; in early times this could be drunk only by nobles and priests. The native dwellings are constructed of wood, or occasionally are huts thatched with grass at the sides and top. What little cooking is undertaken among the poorer natives is usually done outside. The oven consists of a hole in the ground in which a fire is lighted and stones made hot; and the fire having been removed, the food is wrapped up in leaves and placed in the hole beside the hot stones and covered up until ready; or else, as is now more common, the cooking is done in an old kerosene-oil can over a fire.

The Hawaiian language is a member of the widely-diffused Malayo-Polynesian group and closely resembles the dialect of the Marquesas; Hawaiians and New Zealanders, although occupying the most remote regions north and south at which the race has been found, can understand each other without much difficulty. Various unsuccessful attempts have been made to prove the language Aryan in its origin. It is soft and harmonious, being highly vocalic in structure. Every syllable is open, ending in a vowel sound, and short sentences may be constructed wholly of vocalic sounds. The only consonants are *k*, *l*, *m*, *n* and *p*, which with the gently aspirated *h*, the five vowels, and the vocalic *w*, make up all the letters in use. The letters *r* and *t* have been discarded in favour of *l* and *k*, as expressing more accurately the native pronunciation, so that, for example, *laro*, the former name of the *Colocasia* plant, is now *kalo*. The language was not reduced to a written form until after the arrival of the missionaries. A Hawaiian spelling book was printed in 1822; in 1834 two newspapers were founded; and in 1839 the first translation of the Bible was published.

In spite of moral and material progress—indeed largely because of changes in their food, clothing, dwellings and of other "advantages" of civilization—the race is probably dying out. Captain Cook estimated the number of natives at 400,000, probably an over-estimate; in 1833 the American missionaries estimated their number at 142,000; the census of 1832 showed the population to be 130,313; the census of 1878 proved that the number of natives was no more than 44,088. In 1890 they numbered

34,436; in 1900, 29,834, a decrease of 4602 or 13.3% within the decade. To account for this it is said that the blood of the race has become poisoned by the introduction of foreign diseases. The women are much less numerous than the men; and the married ones have few children at the most; two out of three have none. Moreover, the mothers appear to have little maternal instinct and neglect their offspring. It is, however, thought by some that these causes are now diminishing in force, and that the "fittest" of the race may survive. The part-Hawaiians, the offspring of intermarriage between Hawaiian women and men of other races, increased from 3420 in 1878 to 6186 in 1890 and 7835 in 1900.

The pressing demand for labour created by the Reciprocity Treaty of 1875 with the United States led to great changes in the population of the Hawaiian Islands. It became the policy of the government to assist immigrants from different countries.

In 1877 arrangements were made for the importation of Portuguese families from the Azores and Madeira, and during the next ten years about 7000 of these people were brought to the islands; in 1906-1907 there was a second immigration from the Azores and Madeira of 1235 people. In 1900 the total number of Portuguese in the islands, including those born there, was not far from 16,000, about 2400 of whom were employed in sugar plantations. They have shown themselves to be industrious, thrifty and law-abiding.

In 1907 2201 Spanish immigrants from the sugar district about Malaga arrived in Hawaii, and about the same number of Portuguese immigrated in the same year. The Board of Immigration, using funds contributed by planters, was very active in its efforts to encourage the immigration of suitable labourers, but the general immigration law of 1907 prohibited the securing of such immigration through contributions from corporations. Persistent efforts have also been made to introduce Polynesian islanders, as being of a congenate race with the Hawaiians, but the results have been wholly unsatisfactory. About 2000, mainly from the Gilbert Islands, were brought in at the expense of the government between 1878 and 1884; but they did not give satisfaction either as labourers or as citizens, and most of them have been returned to their homes. There never existed any treaty or labour convention between Hawaii and China. In early days a limited number of Chinese settled in the islands, intermarried with the natives and by their industry and economy generally prospered. About 750 of them were naturalized under the monarchy. The first importation of Chinese labourers was in 1852. In 1878 the number of Chinese had risen to 5916. During the next few years there was such a steady influx of Chinese free immigrants that in the spring of 1881 the Hawaiian government sent a despatch to the governor of Hong Kong to stop this invasion. Again, in April 1883, it was suddenly renewed, and within twenty days five steamers arrived from Hong Kong bringing 2253 Chinese passengers, followed the next month by 1100 more, with the news that several thousand more were ready to embark. Accordingly, the Hawaiian government sent another despatch to the governor of Hong Kong, refusing to permit any further immigration of male Chinese from that port. Various regulations restricting Chinese immigration were enacted from time to time, until in 1886 the landing of any Chinese passenger without a passport was prohibited. The number of Chinese in the islands had then risen to 21,000.

The consent of the Japanese government to the immigration of its subjects to Hawaii was obtained with difficulty in 1884, and in 1886 a labour convention was ratified. Subsequently the increase of the Japanese element in the population was rapid. It rose from 116 in 1884 to 12,360 in 1890 and 24,400 in 1896. Most of these were recruited from the lowest classes in Japan. Unlike the Chinese, they show no inclination to intermarry with the Hawaiians. The effect of making Hawaii a Territory of the United States was to put an end to all assisted immigration, of whatever race, and to exclude all Chinese labourers. No Chinese labourer is allowed to enter any other Territory of the Union from Hawaii; and the act of Congress of the 26th of February 1885, "to prohibit the importation and migration of foreigners and aliens under contract or agreement to perform labour in the United States, its Territories and the District of Columbia," and the amending and supplementary acts, are extended to it. But in the treaty of 1894 between the United States and Japan there is nothing to limit the free immigration of Japanese; and several companies have been formed to promote it. The system of contract labour, which was abolished by the act of Congress in 1900, and under which labourers had been restrained from leaving their work before the end of the contract term, concerned few labourers except the Japanese. Various methods of co-operation or profit-sharing are in successful operation on some plantations.

An interesting sociological problem is raised by the presence of the large Asiatic element in the population. The Japanese and Koreans, and in less measure the Chinese, act as domestic servants, work under white contractors on irrigating ditches and reservoirs, do most of the plantation labour and compete successfully with whites and native islanders in all save skilled urban occupations, such as printing and the manufacture of machinery. The "Yellow

Peril" is considered less dangerous in Hawaii than formerly, although it was used as a political cry in the campaign for American annexation. No success met the apparently well-meaning efforts of the Central Japanese League which was organized in November and December 1903 to promote the observance of law and order by the Japanese in the islands, who assumed a too independent attitude and felt themselves free from governmental control whether Japanese or American; indeed, after the League had been in operation for a year or more, it almost seemed that it contributed to industrial disorders among the Japanese. At about the same time Japanese immigration to Hawaii fell off upon the opening of new fields for colonization by the Russo-Japanese War, and Korean immigration was promoted by employers on the islands. From the first of January 1903 to the 30th of June 1905 Japanese immigrants numbered 18,027; Koreans 7388 (four Koreans to every ten Japanese); but in the last twelve months of this same period there were 4733 Koreans to 5941 Japanese (eight Koreans to every ten Japanese). Another fact which is possibly contributing to the solution of the problem is that the Japanese are leaving the islands in large numbers as compared with the Koreans. The Japanese leaving Hawaii between the 14th of June 1900 and the 31st of December 1905 numbered 42,313, or 4284 more than the number of Japanese immigrants arriving during the same period. The corresponding figures for Koreans during the same period are as follows: number leaving between the 14th of June 1900 and the 31st of December 1905, 721, or 6673 less than the Korean immigrants for the same period. The acceleration of the departure of the Japanese is shown by the fact that in the eighteen months (July 1904 to January 1906) occurred 19,114 of the 42,313 departures in the sixty-six months from July 1900 to January 1906.¹ After 1906, owing to restrictions by the Japanese government, immigration to Hawaii greatly decreased. At the same time the number of departures was decreasing rapidly. The change in the character of the immigration of Japanese is shown by the fact that in the fiscal year 1906-1907 the ratio of female immigrants to males was as 1 to 8, in the fiscal year 1907-1908 it was as 1 to 2, and in the latter year, of 4593 births in the Territory, 2445 were Japanese.

Administration.—The Hawaiian Islands are governed under an Act of Congress, signed by the president on the 30th of April 1900, which first organized them as a Territory of the United States. The legislature, which meets biennially at Honolulu, consists of a Senate of 15 members holding office for four years, and a House of Representatives of 30 members holding office for two years. In order to vote for Representatives or Senators, the elector must be a male citizen of the United States who has attained the age of twenty-one years, has lived in the Territory not less than one year preceding, and is able to speak, read and write the English or Hawaiian language. No person is allowed to vote by reason of being in or attached to the army or navy. The executive power is vested in a governor, appointed by the president and holding office for four years. He must not be less than thirty-five years of age and must be a citizen of the Territory. The secretary of the Territory is appointed in like manner for a term of the same length. The governor appoints, by and with the consent of the Senate of the Territory, an attorney-general, treasurer, commissioner of public lands, commissioner of agriculture and forestry, superintendent of public works, superintendent of public instruction, commissioners of public instruction, auditor and deputy-auditor, surveyor, high sheriff, members of the board of health, board of prison inspectors, board of registration, inspectors of election, &c. All such officers are appointed for four years except the commissioners of public instruction and the members of the said

¹ Large numbers of Japanese immigrants have used the Hawaiian Islands merely as a means of gaining admission at the mainland ports of the United States. For, as the Japanese government would issue only a limited number of passports to the mainland but would quite readily grant passports to Honolulu, the latter were accepted, and after a short stay on some one of the islands the immigrants would depart on a "coastwise" voyage to some mainland port. The increasing numbers arriving by this means, however, provoked serious hostility in the Pacific coast states, especially in San Francisco, and to remedy the difficulty Congress inserted a clause in the general immigration act of the 20th of February 1907 which provides that whenever the president is satisfied that passports issued by any foreign government to any other country than the United States, or to any of its insular possessions, or to the Canal Zone, "are being used for the purpose of enabling the holders to come to the continental territory of the United States to the detriment of labour conditions therein," he may refuse to admit them. This provision has been successful in reducing the number of Japanese coming to the mainland from Hawaii.

boards, whose terms are as provided by the laws of the Territory; all must be citizens of the Territory. The judicial power is vested in a supreme court, 5 circuit courts, and 29 district courts, each having a jurisdiction corresponding to similar courts in each state in the Union; and, entirely distinct from these territorial courts, Hawaii has a United States district court. A Supplementary Act of the 3rd of March 1903 provides that writs of error and appeals may be taken from the Supreme Court of Hawaii to the Supreme Court of the United States "in all cases where the amount involved exclusive of costs or value exceeds the sum of five thousand dollars." The Territory was without the forms of local government common to the United States until 1905, when the Territorial legislature divided it into five counties¹ without, however, giving to them the usual powers of taxation. Each county has the following officers: a board of supervisors, a clerk, a treasurer, an auditor, an assessor and tax-collector, a sheriff and coroner, and an attorney. The members (from five to nine) of the board of supervisors are elected by districts into which the county is divided, usually only one from each. All county officers are elected for a term of two years. The act of 1900 provides for the election of a delegate to Congress, and prescribes that the delegate shall have the qualifications necessary for membership in the Hawaiian Senate, and shall be elected by voters qualified to vote for members of the House of Representatives of Hawaii. As usual, the delegate has a right to take part in the debates in the national House of Representatives, but may not vote.

Charities.—The principal public charity of the Territory is the leper asylum on a peninsula about 10 sq. m. in area on the N. side of the island of Molokai. A steep precipice forms a natural wall between it and the rest of the island. The place became an asylum for lepers and the caring for them began to be a charity under government charge in 1866; but conditions here were at first unspeakably unhygienic, their improvement being largely due to Father Damien, who devoted himself to this work in 1873. The patients are almost exclusively native Hawaiians, and their number "is slowly but steadily decreasing; in 1908 they numbered 791, and there were at Molokai 46 non-leprosy helpers and 27 officers and assistants, including the Roman Catholic brothers and sisters in charge of the homes. In 1905 the United States government appropriated \$100,000 for a hospital station and laboratory "for the study of the methods of transmission, cause and treatment of leprosy," and \$50,000 a year for their maintenance; the station and laboratory to be established when the territorial government should have ceded to the United States a tract of 1 sq. m. on the leper reservation. The cession was made soon afterward by the territorial government. In 1907-1908 a home for non-leprosy boys of leprosy parents was established at Honolulu. Another public charity of Hawaii is the general free dispensary maintained by the territorial government at Honolulu.

Education.—Education is universal, compulsory and free. Every child between the ages of six and fifteen must attend either a public school or a duly authorized private school. Consequently the percentage of illiteracy is extremely low. The school system is essentially American in its text-books and in its methods, thanks to the foundations laid by American missionaries. Between 1820 and 1824 the missionaries taught about 2000 natives to read. Several important schools were founded before 1840, when the first written laws were published. Among these was a law providing for compulsory education, and decreeing that no illiterate born after the beginning of Liholiho's reign should hold office, and that no illiterate man or woman, born after the same date, could marry. The first Hawaiian minister of public instruction was the Rev. William Richards (1792-1847), who held office from 1843 to 1847, and was followed by Richard Armstrong (1805-1860), an American Presbyterian missionary, the father of General S. C. Armstrong. He laid stress on the importance of manual and industrial training during his term of office (1847-1855), and was succeeded by a board of education (1855-1865), of which he was first president; then an inspector-general of schools was appointed, Judge Abraham For- nander being the first inspector; in 1866 an executive department was created under a minister of public instruction and six com-

missioners; in 1900 a superintendent of public instruction was first appointed. English is by law the medium of instruction in all schools, both public and private, although other languages may be taught in addition. Formal instruction in Hawaiian ceased in 1898. The schools are in session forty weeks during the year. In 1908 there were 154 public schools with 18,564 pupils (27.06% of whom were Japanese, 20.89% Hawaiian, 13.54% part Hawaiian, 18.72% Portuguese and 10.63% Chinese) and 51 private schools with 481 pupils. A normal school has been established at Honolulu, with a practice school attached to it. The territorial legislature of 1907 established the College of Agriculture and Mechanic Arts of the Territory of Hawaii, and also founded a public library. The Honolulu high school does excellent work and has beautiful buildings and grounds. The Lahainaluna Seminary on west Maui, founded in 1831 as a training school for teachers, furnishes instruction to Hawaiian boys in agriculture, carpentry, printing and mechanical drawing. The boys in the industrial school (1902) at Waialeale, on the island of Oahu, are taught useful trades. The teaching of sewing in the public schools has met with great success, and a simple form of the Swedish sloyd was introduced into many of the schools in 1894. Lace work was introduced into the public schools in 1903. But the best industrial instruction is furnished by the independent schools, among which the Kamehameha schools take the first place. They were founded by Mrs. Bernice Pauahi Bishop (1831-1884), the last lineal descendant of Kamehameha I., who left her extensive landed estates in the hands of trustees for their support. They furnish a good manual and technical training to Hawaiian boys and girls, in addition to a primary and grammar school course of study, and exert a strong religious influence. There are six boarding schools for Hawaiian girls, supported by private resources. The most advanced courses of study are offered by Oahu College, which occupies a beautiful site near the beach just E. of Honolulu; it was founded in 1847 as the Punahou School for missionaries' children, and was chartered as Oahu College in 1852. It is well equipped with buildings and apparatus, and has an endowment of about \$300,000.

Finance.—The revenue of the Territory for the fiscal year ending the 30th of June 1908 amounted to \$2,669,748.32, of which \$640,051.42 was the proceeds of the tax on real estate, \$635,265.81 was the proceeds of the tax on personal property; and among the larger of the remaining items were the income tax (\$266,241.74), waterworks (\$141,898.04), public lands (sales, \$37,585.75; revenue, \$122,541.71) and licenses (\$206,374.28). On the 30th of June 1908 the bonded debt of the Territory was \$3,979,000; there was on hand net cash, without floating debt, \$677,648.48.

History.—The history of the islands before their discovery by Captain James Cook, in 1778, is obscure.² This famous navigator, who named the islands in honour of the earl of Sandwich, was received by the natives with many demonstrations of astonishment and delight; and offerings and prayers were presented to him by their priest in one of the temples; and though in the following year he was killed by a native when he landed in Kealakekua Bay in Hawaii, his bones were preserved by the priests and continued to receive offerings and homage from the people until the abolition of idolatry. At the time of Cook's visit the archipelago seems to have been divided into three distinct kingdoms: Hawaii; Oahu and Maui; and Lanai and Molokai. On the death of the chief who ruled Hawaii at that time there succeeded one named Kamehameha (1736-1819), who appears to have been a man of quick perception and great force of character. When Vancouver visited the islands in 1792, he left sheep and neat cattle,³ protected by a ten years' taboo, and laid down the keel of a European ship for Kamehameha. Ten or twelve years later Kamehameha had 20 vessels (of 25 to 50 tons), which traded among the islands. He afterwards purchased others from foreigners. Having encouraged a warlike spirit in his people and having introduced firearms, Kamehameha attacked and overcame the chiefs of the other kingdoms one after another, until (in 1795) he became undisputed master of the whole group. He made John Young (c. 1775-1835) and Isaac Davis, Americans from one of the ships of Captain Metcalf which visited the island in 1789, his advisers, encouraged trade with foreigners,

¹ These are: the county of Hawaii, consisting of the island of the same name; the county of Maui, including the islands of Maui, Lanai and Kahoolawe, and the greater part of Molokai; the county of Kalawao, being the leper settlement on Molokai; the city and county of Honolulu (created from the former county of Oahu by an act of 1907, which came into effect in 1909), consisting of the island of Oahu and various small islands, of which the only ones of any importance are the Midway Islands, 1232 m. from Honolulu, a Pacific cable relay station and a post of the U.S. navy marines; and the county of Kauai, including Kauai and Niihau islands.

² Their discovery in the 16th century (in 1542 or 1555 by Juan Gaetan, or in 1528 when two of the vessels of Alvaro de Saavedra were shipwrecked here and the captain of one, with his sister, survived and intermarried with the natives) seems probable, because there are traces of Spanish customs in the islands; and they are marked in their correct latitude on an English chart of 1687, which is apparently based on Spanish maps; a later Spanish chart (1743) gives a group of islands 10° E. of the true position of the Hawaiian Islands.

³ The first horses were left by Captain R. J. Cleveland in 1803.

and derived from its profits a large increase of revenue as well as the means of consolidating his power. He died in 1819, and was succeeded by his son, Lihilo, or Kamehameha II., a mild and well-disposed prince, but destitute of his father's energy. One of the first acts of Kamehameha II. was, for vicious and selfish reasons, to abolish taboo and idolatry throughout the islands. Some disturbances were caused thereby, but the insurgents were defeated.

On the 31st of March 1820 missionaries of the American Board of Commissioners for Foreign Missions—two clergymen, two teachers, a physician, a farmer, and a printer, each with his wife—and three Hawaiians educated in the Cornwall (Connecticut) Foreign Missionary School, arrived from America and began their labours at Honolulu. A short time afterwards the British government presented a small schooner to the king, and this afforded an opportunity for the Rev. William Ellis, the well-known missionary, to visit Honolulu with a number of Christian natives from the Society Islands. Finding the language of the two groups nearly the same, Mr Ellis, who had spent several years in the southern islands, was able to assist the American missionaries in reducing the Hawaiian language to a written form. In 1825 the ten commandments were recognized by the king as the basis of a code of laws. In the years 1830-1845 the educational work of the American missionaries was so successful that hardly a native was unable to read and write. A law prohibiting drunkenness (1835) was followed in 1838 by a licence law and in 1839 by a law prohibiting the importation of spirits and taxing wines fifty cents a gallon; in 1840 another prohibitory law was enacted; but licence laws soon made the sale of liquor common. Missionary effort was particularly fruitful in Hilo, where Titus Coan (1801-1882), sent out in 1835 by the American Board of Commissioners for Foreign Missions, worked in repeated revivals, induced most of his church members to give up tobacco even, and received prior to 1860 more than 12,000 members into a church which became self-supporting and sent missions to the Gilbert Islands and the Marquesas. In 1823 Keopuolani, the king's mother, was baptized; and on a single Sunday in 1838 Coan baptized 1705 converts at Hilo. In 1864 the American Board withdrew its control of evangelical work.

In 1824 the king and queen of the Hawaiian Islands paid a visit to England, and both died there of measles. His successor, Kamehameha III. ruled from 1825 to 1854. In 1839 Kamehameha III. signed a Bill of Rights and in 1840 he promulgated the first constitution of the realm; in 1842 a code of laws was proclaimed; by 1848 the feudal system of land tenure was completely abolished; the first legislature met in 1845 and full suffrage was granted in 1852, but in 1864 suffrage was restricted. Progress was at times interrupted by the conduct of the officers of foreign powers. On one occasion (July 1839) French officers abrogated the laws (particularly against the importation of liquor), dictated treaties, extorted \$20,000 and by force of arms procured privileges for Roman Catholic priests in the country; and at another time (February 1843) a British officer, Captain Paullet of the "Carysfort," went so far as to take possession of Oahu and establish a commission for its government. The act of the British officer was disavowed by his superiors as soon as known.

These incidents led to a representation on the part of the native sovereign to the governments of Great Britain, France and the United States, and the independence of the islands (recognized by the United States in 1842) was recognized in 1844 by France and Great Britain. In 1844 John Ricord, an American lawyer, became the first minister of foreign affairs. A new constitution came into effect in 1852. It was the aim of Kamehameha III. and his advisers to combine the native and the foreign elements under one government; to make the king the sovereign not of one race or class, but of all; and to extend equal and impartial laws over all inhabitants of the

¹ The first Roman Catholic priests came in 1827 and were banished in 1831, but returned in 1837. An edict of toleration in 1839 shortly preceded the visit of the "Artemise."

country. Kamehameha IV. and his queen, Emma, ruled from 1855 to 1863 and were succeeded by his brother, Kamehameha V., who died in 1872, and in whose reign a third (and a reactionary) constitution went into effect in 1864, by mere royal proclamation. Lunalilo, a grandson of Kamehameha I., was king for two years, and in 1874, backed by American influence, Kalakaua was elected his successor, in preference to Queen Emma, a member of the Anglican Church and the candidate of the pro-British party. Kalakaua considered residents of European or American descent as alien invaders, and he aimed to restore largely the ancient system of personal government, under which he should have control of the public treasury. On the 2nd of July 1878, and again on the 14th of August 1880, he dismissed a ministry without assigning any reason, after it had been triumphantly sustained by a test vote of the legislature. On the latter occasion he appointed C. C. Moreno, who had come to Honolulu in the interest of a Chinese steamship company, as Premier and minister of foreign affairs. This called forth the protest of the representatives of Great Britain, France and the United States, and aroused such opposition on the part of both the foreigners and the better class of natives that the king was obliged, after four days of popular excitement, to remove the obnoxious minister. During the king's absence on a tour round the world in 1881, his sister, Mrs Lydia Dominis (b. 1838), also styled Liliuokalani, acted as regent. After his return the contest was renewed between the so-called National party, which favoured absolutism, and the Reform party, which sought to establish parliamentary government. The king took an active part in the elections, and used his patronage to the utmost to influence legislation. For three successive sessions a majority of the legislature was composed of office-holders, dependent on the favour of the executive. Among the measures urged by the king and opposed by the Reform party were the project of a ten-million dollar loan, chiefly for military purposes; the removal of the prohibition of the sale of alcoholic liquor to Hawaiians, which was carried in 1882; the licensing of the sale of opium; the chartering of a lottery company; the licensing of *kahunas*, or medicine men, &c. Systematic efforts were made to turn the constitutional question into a race issue, and the party cry was raised of "Hawaii for Hawaiians." Adroit politicians flattered the king's vanity, defended his follies and taught him how to violate the spirit of the constitution while keeping the letter of the law. From 1882 till 1887 his prime minister was Walter Murray Gibson (1823-1888), a singular and romantic genius, a visionary adventurer and a shrewd politician, who had been imprisoned by the Dutch government in Batavia in 1852 on a charge of inciting insurrection in Sumatra, and had arrived at Honolulu in 1861 with the intention of leading a Mormon colony to the East Indies. To exalt his royal dignity, which was lowered, he thought, by his being only an elected king, Kalakaua caused himself to be crowned with imposing ceremonies on the ninth anniversary of his election (Feb. 12, 1883).

Kalakaua was now no longer satisfied with being merely king of Hawaii, but aspired to what was termed the "Primacy of the Pacific." Accordingly Mr Gibson addressed a protest to the great powers, deprecating any further annexation of the islands of the Pacific Ocean, and claiming for Hawaii the exclusive right "to assist them in improving their political and social condition." In pursuance of this policy, two commissioners were sent to the Gilbert Islands in 1883 to prepare the way for a Hawaiian protectorate. On the 23rd of December 1886 Mr J. E. Bush was commissioned as minister plenipotentiary to the king of Samoa, the king of Tonga and the other independent chiefs of Polynesia. He arrived in Samoa on the 3rd of January 1887, and remained there six months, during which time he concluded a treaty of alliance with Malietoa, which was ratified by his government. The "Explorer," a steamer of 170 tons, which had been employed in the copra trade, was purchased for \$20,000, and refitted as a man-of-war, to form the "nest-egg" of the future Hawaiian navy. She was renamed the "Kaimiloa," and was despatched to Samoa on the 17th of May 1887

to strengthen the hands of the embassy. As R. L. Stevenson wrote: "The history of the 'Kaimiloa' is a story of debauchery, wotiny and waste of government property." At length the intrigues of the Hawaiian embassy gave umbrage to the German government, and it was deemed prudent to recall it to Honolulu in July 1887. Meanwhile a reform league had been formed to stop the prevailing misrule and extravagance; it was supported by a volunteer military force, the "Honolulu Rifles." The king carried through the legislature of 1886 a bill for an opium licence, as well as a Loan Act, under which a million dollars were borrowed in London. Under his influence the Hale Naua Society was organized in 1886 for the spread of idolatry and king-worship; and in the same year a "Board of Health" was formed which revived the vicious practices of the *hakunas* or medicine-men.

The king's acceptance of two bribes—one of \$75,000 and another of \$80,000 for the assignment of an opium licence—precipitated the revolution of 1887. An immense mass meeting was held on the 30th of June, which sent a committee to the king with specific demands for radical reforms. Finding himself without support, he yielded without a struggle, dismissed his ministry and signed a constitution on the 7th of July 1887, revising that of 1864, and intended to put an end to personal government and to make the cabinet responsible only to the legislature; this was called the "bayonet constitution," because it was so largely the result of the show of force made by the Honolulu Rifles. By its terms office-holders were made ineligible for seats in the legislature, and no member of the legislature could be appointed to any civil office under the government during the term for which he had been elected. The members of the Upper House, instead of being appointed by the king for life, were henceforth to be elected for terms of six years by electors possessing a moderate property qualification. The remainder of Kalakaua's reign teemed with intrigues and conspiracies to restore autocratic rule. One of these came to a head on the 30th of July 1889, but this "Wilcox rebellion," led by R. W. Wilcox, a half-breed, educated in Italy, and a friend of the king and of his sister, was promptly suppressed. Seven of the insurgents were killed and a large number wounded. For his health the king visited California in the United States cruiser "Charleston" in November 1890, and died on the 20th of January 1891 in San Francisco. On the 29th of January at noon his sister, the regent, took the oath to maintain the constitution of 1887, and was proclaimed queen, under the title of Liliuokalani.

The history of her reign shows that it was her constant purpose to restore autocratic government. The legislative session of 1892, during which four changes of ministry took place, was protracted to eight months chiefly by her determination to carry through the opium and lottery bills and to have a pliable cabinet. She had a new constitution drawn up, practically providing for an absolute monarchy, and disfranchising a large class of citizens who had voted since 1887; this constitution (drawn up, so the royal party declared, in reply to a petition signed by thousands of natives) she undertook to force on the country after proroguing the legislature on the 14th of January 1893, but her ministers shrank from the responsibility of so revolutionary an act, and with difficulty prevailed upon her to postpone the execution of her design. An uprising similar to that of 1887 declared the monarchy forfeited by its own act. A third party proposed a regency during the minority of the heir-apparent, Princess Kaiulani, but in her absence this scheme found few supporters. A Committee of Safety was appointed at a public meeting, which formed a provisional government and reorganized the volunteer military companies, which had been disbanded in 1890. Its leading spirits were the "Sons of Missionaries" (as E. L. Godkin styled them), who were accused of using their knowledge of local affairs and their inherited prestige among the natives for private ends—of founding a "Gospel Republic" which was actually a business enterprise. The provisional government called a mass meeting of citizens, which met on the afternoon of the 6th and ratified its action.

The United States steamer "Boston," which had unexpectedly arrived from Hilo on the 14th, landed a small force on the evening of the 16th, at the request of the United States minister, Mr J. L. Stevens, and a committee of residents, to protect the lives and property of American citizens in case of riot or incendiarianism. On the 17th the Committee of Safety took possession of the government building, and issued a proclamation declaring a monarchy to be abrogated, and establishing a provisional government, to exist "until terms of union with the United States of America shall have been negotiated and agreed upon." Meanwhile two companies of volunteer troops arrived and occupied the grounds. By the advice of her ministers, and to avoid bloodshed, the queen surrendered under protest, in view of the landing of United States troops, appealing to the government of the United States to reinstate her in authority. A treaty of annexation was negotiated with the United States during the next month, just before the close of President Benjamin Harrison's administration, but it was withdrawn on the 9th of March 1893 by President Harrison's successor, President Cleveland, who then despatched James H. Blount (1837-1903) of Macon, Georgia, as commissioner paramount, to investigate the situation in the Hawaiian Islands. On receiving Blount's report to the effect that the revolution had been accomplished by the aid of the United States minister and by the landing of troops from the "Boston," President Cleveland sent Albert Sydney Willis (1843-1897) of Kentucky to Honolulu with secret instructions as United States minister. Willis with much difficulty and delay obtained the queen's promise to grant an amnesty, and made a formal demand on the provisional government for her reinstatement on the 19th of December 1893. On the 23rd President Sanford B. Dole sent a reply to Willis, declining to surrender the authority of the provisional government to the deposed queen. The United States Congress declared against any further intervention by adopting on the 31st of May 1894 the Turpie Resolution. On the 30th of May 1894 a convention was held to frame a constitution for the republic of Hawaii, which was proclaimed on the 4th of July following, with S. B. Dole as its first president. Toward the end of the same year a plot was formed to overthrow the republic and to restore the monarchy. A cargo of arms and ammunition from San Francisco was secretly landed at a point near Honolulu, where a company of native royalists were collected on the 6th of January 1895, intending to capture the government buildings by surprise that night, with the aid of their allies in the city. A premature encounter with a squad of police alarmed the town and broke up their plans. There were several other skirmishes during the following week, resulting in the capture of the leading conspirators, with most of their followers. The ex-queen, on whose premises arms and ammunition and a number of incriminating documents were found, was arrested and was imprisoned for nine months in the former palace. On the 24th of January 1895 she formally renounced all claim to the throne and took the oath of allegiance to the republic. The ex-queen and forty-eight others were granted conditional pardon on the 7th of September, and on the following New Year's Day the remaining prisoners were set at liberty.

On the inauguration of President McKinley, in March 1897, negotiations with the United States were resumed, and on the 16th of June a new treaty of annexation was signed at Washington. As its ratification by the Senate had appeared to be uncertain, extreme measures were taken: the Newlands joint resolution, by which the cession was "accepted, ratified and confirmed," was passed by the Senate by a vote of 42 to 21 and by the House of Representatives by a vote of 209 to 91, and was signed by the president on the 7th of July 1898. The formal transfer of sovereignty took place on the 12th of August 1898, when the flag of the United States (the same flag hauled down by order of Commissioner Blount) was raised over the Executive Building with impressive ceremonies.

The sovereigns of the monarchy, the president of the republic and the governors of the Territory up to 1910 were as follows:

Sovereigns: Kamehameha I., 1795-1819; Kamehameha II., 1819-1824; Kaahumanu (regent), 1824-1832; Kamehameha III., 1832-1854; Kamehameha IV., 1855-1863; Kamehameha V., 1863-1872; Lunalilo, 1873-1874; Kalakaua, 1874-1891; Liliuokalani, 1891-1893. **President:** Sanford B. Dole, 1893-1898. **Governors:** S. B. Dole, 1898-1904; George R. Carter, 1904-1907; W. F. Frear, 1907.

AUTHORITIES.—Consult the bibliography in Adolf Marcuse, *Die hawaiischen Inseln* (Berlin, 1894); A. P. C. Griffen, *List of Books relating to Hawaii* (Washington, 1898); C. E. Dutton, *Hawaiian Volcanoes*, in the fourth annual report of the United States Geological Survey (Washington, 1884); J. D. Dana, *Characteristics of Volcanoes with Contribution of Facts and Principles from the Hawaiian Islands* (New York, 1890); W. H. Pickering, *Lunar and Hawaiian Physical Features compared* (1906); C. H. Hitchcock, *Hawaii and its Volcanoes* (Honolulu, 1909); Augustin Kramer, *Hawaii, Ostmikronesien und Samoa* (Stuttgart, 1906); Sharp, *Fauna* (London, 1899); Walter Maxwell, *Lavas and Soils of the Hawaiian Islands* (Honolulu, 1898); W. Hillebrand, *Flora of the Hawaiian Islands* (London, 1888); G. P. Wilder, *Fruits of the Hawaiian Islands* (3 vols., Honolulu, 1907); H. W. Henshaw, *Birds of the Hawaiian Islands* (Washington, 1902); A. Fornander, *Account of the Polynesian Race and the Ancient History of the Hawaiian People to the Times of Kamehameha I.* (3 vols., London, 1878-1885); W. D. Alexander, *A Brief History of the Hawaiian People* (New York, 1899); C. H. Forbes-Lindsay, *American Insular Possessions* (Philadelphia, 1906); José de Olivares, *Our Islands and their People* (New York, 1899); J. A. Owen, *Story of Hawaii* (London, 1898); E. J. Carpenter, *America in Hawaii* (Boston, 1899); W. F. Blackman, *The Making of Hawaii, a Study in Social Evolution* (New York, 1899), with bibliography; T. G. Thrum, *Hawaiian Almanac and Annual* (Honolulu); Lucien Young, *The Real Hawaii* (New York, 1899), written by a lieutenant of the "Boston," an ardent defender of Stevens; Liliuokalani, *Hawaii's Story* (Boston, 1898); C. T. Rodgers, *Education in the Hawaiian Islands* (Honolulu, 1897); Henry E. Chambers, *Constitutional History of Hawaii* (Baltimore, 1896), in *Johns Hopkins University Studies*; W. Ellis, *Tour Around Hawaii* (London, 1829); J. J. Jarves, *History of the Sandwich Islands* (Honolulu, 1847); H. Bingham, *A Residence of Twenty-one Years in the Sandwich Islands* (Hartford, 1848); Isabella Bird, *Six Months in the Sandwich Islands* (New York, 1881); Adolf Bastian, *Zur Kenntnis Hawaii's* (Berlin, 1883); the annual Reports of the governor of Hawaii, of the Hawaii Agricultural Experiment Station, of the Hawaiian Sugar Planters' Experiment Station, of the Board of Commissioners on Agriculture and Forestry, and of the Hawaii Promotion Committee; and the *Papers of the Hawaiian Historical Society*.

HAWARDEN (pronounced Harden, Welsh *Penarldg*), a market-town of Flintshire, North Wales, 6 m. W. of Chester, on a height commanding an extensive prospect, connected by a branch with the London & North-Western railway. Pop. (1901), 5372. It lies in a coal district, with clay beds near. Coarse earthenware, draining tiles and fire-clay bricks are the chief manufactures. The Maudes take the title of viscount from the town. Hawarden castle—built in 1752, added to and altered in the Gothic style in 1814—stands in a fine wooded park near the old castle of the same name, which William the Conqueror gave to his nephew, Hugh Lupus. It was taken in 1282 by Dafydd, brother of Llewelyn, prince of Wales, destroyed by the Parliamentarians in the Civil War, and came into the possession of Sergeant Glynn, lord chief justice of England under Cromwell. The last baronet, Sir Stephen R. Glynn, dying in 1874, Castell Penarldg passed to his brother-in-law, William Ewart Gladstone. St Deiniol church, early English, was restored in 1857 and 1878. There are also a grammar school (1606), a Gladstone golden-wedding fountain (1889), and St Deiniol's Hostel (with accommodation for students and an Anglican clerical warden); west of the church, on Truman's hill, is an old British camp.

HAWAWIR (HAUWAUIN), an African tribe of Semitic origin, dwelling in the Bayuda desert, Anglo-Egyptian Sudan. They are found along the road from Debba to Khartum as far as Bir Gamr, and from Ambigol to Wadi Bishra. They have adopted none of the negro customs, such as gashing the cheeks or elaborate hairdressing. They own large herds of oxen, sheep and camels.

HAWES, HUGH REGINALD (1838-1901), English preacher and writer, was born at Egham, Surrey, on the 3rd of April 1838. On leaving Trinity College, Cambridge, he travelled in

Italy and served under Garibaldi in 1860. On his return to England he was ordained and held various curacies in London, becoming in 1866 incumbent of St James's, Marylebone. His unconventional methods of conducting the service, combined with his dwarfish figure and lively manner, soon attracted crowded congregations. He married Miss M. E. Joy in 1866, and both he and Mrs Hawes (d. 1898) contributed largely to periodical literature and travelled a good deal abroad. Hawes was Lowell lecturer at Boston, U.S.A., in 1885, and represented the Anglican Church at the Chicago Parliament of Religions in 1893. He was much interested in music, and wrote books on violins and church bells, besides contributing an article to the 9th edition of the *Encyclopædia Britannica* on bell-ringing. His best-known book was *Music and Morals* (3rd ed., 1873); and for a time he was editor of *Cassell's Magazine*. He also wrote five volumes on *Christ and Christianity* (a popular church history, 1886-1887). Other writings include *Travel and Talk* (1896), and similar chatty and entertaining books. He died on the 29th of January 1901.

HAWES, STEPHEN (fl. 1502-1521), English poet, was probably a native of Suffolk, and, if his own statement of his age may be trusted, was born about 1474. He was educated at Oxford, and travelled in England, Scotland and France. On his return his various accomplishments, especially his "most excellent vein" in poetry, procured him a place at court. He was groom of the chamber to Henry VII. as early as 1502. He could repeat by heart the works of most of the English poets, especially the poems of John Lydgate, whom he called his master. He was still living in 1521, when it is stated in Henry VIII.'s household accounts that £6, 13s. 4d. was paid "to Mr Hawes for his play," and he died before 1530, when Thomas Field, in his "Conversation between a Lover and a Jay," wrote "Young Steven Hawse, whose soule God pardon, Treated of love so clerly and well." His capital work is *The Passetyme of Pleasure, or the History of Graunde Amour and la Bel Pucel, containing the knowledge of the Seven Sciences and the Course of Man's Life in this Worlde*, printed by Wynkyn de Worde, 1509, but finished three years earlier. It was also printed with slightly varying titles by the same printer in 1517, by J. Wayland in 1554, by Richard Tottel and by John Waley in 1555. Tottel's edition was edited by T. Wright and reprinted by the Percy Society in 1845. The poem is a long allegory in seven-lined stanzas of man's life in this world. It is divided into sections after the manner of the *Morte Arthur* and borrows the machinery of romance. Its main motive is the education of the knight, Graunde Amour, based, according to Mr W. J. Courthope (*Hist. of Eng. Poetry*, vol. i. 382), on the *Marriage of Mercury and Philology*, by Martianus Capella, and the details of the description prove Hawes to have been well acquainted with medieval systems of philosophy. At the suggestion of Fame, and accompanied by her two greyhounds, Grace and Governance, Graunde Amour starts out in quest of La Bel Pucel. He first visits the Tower of Doctrine or Science where he acquaints himself with the arts of grammar, logic, rhetoric and arithmetic. After a long disputation with the lady in the Tower of Music he returns to his studies, and after sojourns at the Tower of Geometry, the Tower of Doctrine, the Castle of Chivalry, &c., he arrives at the Castle of La Bel Pucel, where he is met by Peace, Mercy, Justice, Reason and Memory. His happy marriage does not end the story, which goes on to tell of the oncoming of Age, with the concomitant evils of Avarice and Cunning. The admonition of Death brings Contrition and Conscience, and it is only when Remembrance has delivered an epitaph chiefly dealing with the Seven Deadly Sins, and Fame has enrolled Graunde Amour's name with the knights of antiquity, that we are allowed to part with the hero. This long imaginative poem was widely read and esteemed, and certainly exercised an influence on the genius of Spenser.

The remaining works of Hawes are all of them bibliographical rarities. *The Conversion of Swenens* (1509) and *A Joyfull Medytacyon to all Englonde*, a coronation poem (1509), was edited by David Laing for the Abbotsford Club (Edinburgh, 1865). A

Compendious Story . . . called the *Example of Vertu* (p. 1512) and the *Comfort of Lovers* (not dated) complete the list of his extant work.

See also G. Saintsbury, *The Flourishing of Romance and the Rise of Allegory* (Edin. and Lond., 1897); the same writer's *Hist. of English Prose* (vol. i. 1906); and an article by W. Murison in the *Cambridge History of English Literature* (vol. ii. 1908).

HAWES, WILLIAM (1785-1846), English musician, was born in London in 1785, and was for eight years (1793-1801) a chorister of the Chapel Royal, where he studied music chiefly under Dr Ayrton. He subsequently held various musical posts, being in 1817 appointed master of the children of the Chapel Royal. He also carried on the business of a music publisher, and was for many years musical director of the Lyceum theatre, then devoted to English opera. In the last-named capacity (July 23rd, 1824), he introduced Weber's *Der Freischütz* for the first time in England, at first slightly curtailed, but soon afterwards in its entirety. Winter's *Interrupted Sacrifice*, Mozart's *Così fan tutte*, Marschner's *Vampyre* and other important works were also brought out under his auspices. Hawes also wrote or compiled the music for numerous pieces. Better were his glees and madrigals, of which he published several collections. He also superintended a new edition of the celebrated *Triumph of Oriana*. He died on the 18th of February 1846.

HAWFINCH, a bird so called from the belief that the fruit of the hawthorn (*Crataegus oxyacantha*) forms its chief food, the *Loxia coccoltraustes* of Linnaeus, and the *Coccoltraustes vulgaris* of modern ornithologists, one of the largest of the finch family (*Fringillidae*), and found over nearly the whole of Europe, in Africa north of the Atlas and in Asia from Palestine to Japan. It was formerly thought to be only an autumnal or winter-visitor to Britain, but later experience has proved that, though there may very likely be an immigration in the fall of the year, it breeds in nearly all the English counties to Yorkshire, and abundantly in those nearest to London. In coloration it bears some resemblance to a chaffinch, but its much larger size and enormous beak make it easily recognizable, while on closer inspection the singular bull-hook form of some of its wing-feathers will be found to be very remarkable. Though not uncommonly frequenting gardens and orchards, in which as well as in woods it builds its nest, it is exceedingly shy in its habits, so as seldom to afford opportunities for observation. (A. N.)

HAWICK, a municipal and police burgh of Roxburghshire, Scotland. Pop. (1891), 19,204; (1901), 17,303. It is situated at the confluence of the Slitrig (which flows through the town) with the Teviot, 10 m. S.W. of Jedburgh by road and 5½ m. S.E. of Edinburgh by the North British railway. The name has been derived from the O. Eng. *heah-wic*, "the village on the flat meadow," or *haga-wic*, "the fenced-in dwelling," the Gadeni being supposed to have had a settlement at this spot. Hawick is a substantial and flourishing town, the prosperity of which dates from the beginning of the 19th century, its enterprise having won for it the designation of "The Glasgow of the Borders." The municipal buildings, which contain the free library and reading-room, stand on the site of the old town hall. The Buccleuch memorial hall, commemorating the 5th duke of Buccleuch, contains the Science and Art Institute and a museum rich in exhibits illustrating Border history. The Academy furnishes both secondary and technical education. The only church of historical interest is that of St Mary's, the third of the name, built in 1763. The first church, believed to have been founded by St Cuthbert (d. 687), was succeeded by one dedicated in 1214, which was the scene of the seizure of Sir Alexander Ramsay of Dalhousie in 1342 by Sir William Douglas. The modern Episcopal church of St Cuthbert was designed by Sir Gilbert Scott. The Moat or Moat hill at the south end of the town—an earthen mound 30 ft. high and 300 ft. in circumference—is conjectured to have been the place where formerly the court of the manor met; though some authorities think it was a primitive form of fortification. The Baron's Tower, founded in 1155 by the Lovels, lords of Branxholm and Hawick, and afterwards the residence of the Douglasses of Drumlanrig, is said to have been the only building that was not burned down during

the raid of Thomas Radcliffe, 3rd earl of Sussex, in April 1570. At a later date it was the abode of Anne, duchess of Buccleuch and Monmouth, after the execution of her husband, James, duke of Monmouth in 1585, and finally became the Tower Hotel. Bridges across the Teviot connect Hawick with the suburb of Wilton, in which a public park has been laid out, and St Leonard's Park and race-course are situated on the Common, 2 m. S.W. The town is governed by a provost, bailies and council, and unites with Selkirk and Galashiels (together known as the Border burghs) to send a member to parliament. The leading industries are the manufacture of hosiery, established in 1771, and woollens, dating from 1830, including blankets, shepherd's plaiding and tweeds. There are, besides, tanneries, dye works, oil-works, saw-mills, iron-founding and engineering works, quarries and nursery gardens. The markets for live stock and grain are also important.

In 1537 Hawick received from Sir James Douglas of Drumlanrig a charter which was confirmed by the infant Queen Mary in 1545, and remained in force until 1861, when the corporation was reconstituted by act of parliament. Owing to its situation Hawick was often imperilled by Border warfare and marauding freebooters. Sir Robert Umfraville (d. 1436), governor of Berwick, burned it about 1417, and in 1562 the regent Moray had to suppress the lawless with a strong hand. Neither of the Jacobite risings aroused enthusiasm. In 1715 the discontented Highlanders mutinied on the Common, 500 of them abandoning their cause, and in 1745 Prince Charles Edward's cavalry passed southward through the town. In 1514, the year after the battle of Flodden, in which the burghers had suffered severely, a number of young men surprised an English force at Hornshole, a spot on the Teviot 2 m. below the town, routed them and bore away their flag. This event is celebrated every June in the ceremony of "Riding the Common"—in which a facsimile of the captured pennon is carried in procession to the accompaniment of a chorus "Teribus, ye Teri Odin," supposed to be an invocation to Thor and Odin—a survival of Northumbrian paganism. Two of the most eminent natives of the burgh were Dr Thomas Somerville (1741-1830), the historian, and James Wilson (1805-1860), founder of the *Economist* newspaper and the first financial member of the council for India.

Minto House, 5 m. N.E., is the seat of the earl of Minto. Denholm, about midway between Hawick and Jedburgh, was the birthplace of John Leyden the poet. The cottage in which Leyden was born is now the property of the Edinburgh Border Counties Association, and a monument to his memory has been erected in the centre of Denholm green. Cavers, nearer Hawick, was once the home of a branch of the Douglasses, and it is said that in Cavers House are still preserved the pennon that was borne before the Douglas at the battle of Otterburn (Chevy Chase), and the gauntlets that were then taken from the Percy (1388). Two m. S.W. of Hawick is the massive peel of Goldielands—the "watch-tower of Branxholm," a well-preserved typical Border stronghold. One mile beyond it, occupying a commanding site on the left bank of the Teviot, stands Branxholm Castle, the Branksome Hall of *The Lay of the Last Minstrel*, once owned by the Lovels, but since the middle of the 15th century the property of the Scots of Buccleuch, and up to 1756 the chief seat of the duke. It suffered repeatedly in English invasions and was destroyed in 1570. It was rebuilt next year, the peel, finished five years later, forming part of the modern mansion. About 3 m. W. of Hawick, finely situated on high ground above Harden Burn, a left-hand affluent of Borthwick Water, is Harden the home of Walter Scott (1750-1830), an ancestor of the novelist.

HAWK (O. Eng. *hafoc* or *heafoc*, a common Teutonic word, cf. Dutch *hawk*, Ger. *Hebich*; the root is *hab-*, *haf-*, to hold, cf. Lat. *accipiter*, from *capere*), a word of somewhat indefinite meaning, being often used to signify all diurnal birds-of-prey which are neither vultures nor eagles, and again more exclusively for those of the remainder which are not buzzards, falcons, harriers or kites. Even with this restriction it is comprehensive enough, and will include more than a hundred species, which have been arrayed in genera varying in number from a dozen to above a score, according to the fancy of the systematizer. Speaking generally, hawks may be characterized by possessing comparatively short wings and long legs, a bill which begins to decurve directly from the cere (or soft bare skin that covers its base), and has the cutting edges of its maxilla (or upper mandible)

situated¹ but never notched. To these may be added as characters, structurally perhaps of less value, but in other respects quite as important, that the sexes differ very greatly in size, that in most species the irides are yellow, deepening with age into orange or even red, and that the immature plumage is almost invariably more or less striped or mottled with heart-shaped spots beneath, while that of the adults is generally much barred, though the old males have in many instances the breast and belly quite free from markings. Nearly all are of small or moderate size—the largest among them being the gos-hawk (*g.v.*) and its immediate allies, and the male of the smallest, *Accipiter linus*, is not bigger than a song-thrush. They are all birds of great boldness in attacking a quarry, but if foiled in the first attempts they are apt to leave the pursuit. Thoroughly arboreal in their habits, they seek their prey, chiefly consisting of birds (though reptiles and small mammals are also taken), among trees or bushes, patiently waiting for a victim to shew

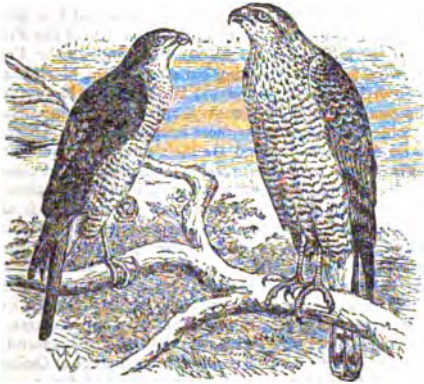

European Sparrow-Hawk (Male and Female).

itself, and gliding upon it when it appears to be unwary with a rapid swoop, clutching it in their talons, and bearing it away to eat it in some convenient spot.

Systematic ornithologists differ as to the groups into which the numerous forms known as hawks should be divided. There is at the outset a difference of opinion as to the scientific name which the largest and best known of these groups should bear—some authors terming it *Nisus*, and others who seem to have the most justice on their side, *Accipiter*. In Europe there are two species—first, *A. nisus*, the common sparrow-hawk, which has a wide distribution from Ireland to Japan, extending also to northern India, Egypt and Algeria, and secondly, *A. brevipes* (by some placed in the group *Micronisus* and by others called an *Astur*), which only appears in the south-east and the adjoining parts of Asia Minor and Persia. In North America the place of the former is taken by two very distinct species, a small one, *A. fuscus*, usually known in Canada and the United States as the sharp-shinned hawk, and Stanley's or Cooper's hawk, *A. cooperi* (by some placed in another genus, *Cooperastur*), which is larger and has not so northerly a range. In South America there are four or five more, including *A. linus*, before mentioned as the smallest of all, while a species not much larger, *A. minullus*, together with several others of greater size, inhabits South Africa. Madagascar and its neighbouring islands have three or four species sufficiently distinct, and India has *A. badius*. A good many more forms are found in south-eastern Asia, in the Indo-Malay Archipelago, and in Australia three or four species, of which *A. cirrocephalus* most nearly represents the sparrow-hawk of Europe and northern Asia, while *A. radiatus* and *A. approximans* show some affinity to the gos-hawks (*Astur*)

¹ In one form, *Nisoides*, which on that account has been generically separated, they are said to be perfectly straight.

with which they are often classed. The differences between all the forms above named and the much larger number here unnamed are such as can be only appreciated by the specialist. The so-called "sparrow-hawk" of New Zealand (*Hieracidea*) does not belong to this group of birds at all, and by many authors has been deemed akin to the falcons. For hawking see FALCONRY. (A. N.)

HAWKE, EDWARD HAWKE, BARON (1705-1781), British admiral, was the only son of Edward Hawke, a barrister. On his mother's side he was the nephew of Colonel Martin Bladen (1680-1746), a politician of some note, and was connected with the family of Fairfax. Edward Hawke entered the navy on the 20th of February 1720 and served the time required to qualify him to hold a lieutenant's commission on the North American and West Indian stations. Though he passed his examination on the 2nd of June 1725, he was not appointed to a ship to act in that rank till 1729, when he was named third lieutenant of the "Portland" in the Channel. The continuance of peace allowed him no opportunities of distinction, but he was fortunate in obtaining promotion as commander of the "Wolf" sloop in 1733, and as post captain of the "Flamborough" (20) in 1734. When war began with Spain in 1739, he served as captain of the "Portland" (50) in the West Indies. His ship was old and rotten. She nearly drowned her captain and crew, and was broken up after she was paid off in 1742. In the following year Hawke was appointed to the "Berwick" (70), a fine new vessel, and was attached to the Mediterranean fleet then under the command of Thomas Mathews. The "Berwick" was manned badly, and suffered severely from sickness, but in the ill-managed battle of Toulon on the 11th of January 1744 Hawke gained great distinction by the spirit with which he fought his ship. The only prize taken by the British fleet, the Spanish "Poder" (74), surrendered to him, and though she was not kept by the admiral, Hawke was not in any degree to blame for the loss of the only trophy of the fight. His gallantry attracted the attention of the king. There is a story that he was dismissed the service for having left the line to engage the "Poder," and was restored by the king's order. The legend grew not unnaturally out of the confusing series of courts martial which arose out of the battle, but it has no foundation. There is better reason to believe that when at a later period the Admiralty intended to pass over Hawke's name in a promotion of admirals, the king, George II., did insist that he should not be put on the retired list.

He had no further chance of making his energy and ability known out of the ranks of his own profession, where they were fully realized, till 1747. In July of that year he attained flag rank, and was named second in command of the Channel fleet. Owing to the ill health of his superior he was sent in command of the fourteen ships detached to intercept a French convoy on its way to the West Indies. On the 14th of October 1747 he fell in with it in the Bay of Biscay. The French force, under M. Desherbiers de l'Étenduère, consisted of nine ships, which were, however, on the average larger than Hawke's. He attacked at once. The French admiral sent one of his liners to escort the merchant ships on their way to the West Indies, and with the other eight fought a very gallant action with the British squadron. Six of the eight French ships were taken. The French admiral did for a time succeed in saving the trading vessels under his charge, but most of them fell into the hands of the British cruisers in the West Indies. Hawke was made a knight of the Bath for this timely piece of service, a reward which cannot be said to have been lavish.

In 1747 Hawke had been elected M.P. for Portsmouth, which he continued to represent for thirty years, though he can seldom have been in his place, and it does not appear that he often spoke. A seat in parliament was always valuable to a naval officer at that time, since it enabled him to be useful to ministers, and increased his chances of obtaining employment. Hawke had married a lady of fortune in Yorkshire, Catherine Brook, in 1737, and was able to meet the expenses entailed by a seat in parliament, which were considerable at a time when votes were openly paid for by money down. In the interval between the war of

the Austrian Succession and the Seven Years' War, Hawke was almost always on active service. From 1748 till 1752 he was in command at home, and he rehoisted his flag in 1755 as admiral in command of the Western Squadron. Although war was not declared for some time, England and France were on very hostile terms, and conflicts between the officers of the two powers in America had already taken place. Neither government was scrupulous in abstaining from the use of force while peace was still nominally unbroken. Hawke was sent to sea to intercept a French squadron which had been cruising near Gibraltar, but a restriction was put on the limits within which he might cruise, and he failed to meet the French. The fleet was much weakened by ill-health. In June 1756 the news of John Byng's retreat from Minorca reached England and aroused the utmost indignation. Hawke was at once sent out to relieve him in the Mediterranean command, and to send him home for trial. He sailed in the "Antelope," carrying, as the wits of the day put it, "a cargo of courage" to supply deficiencies in that respect among the officers then in the Mediterranean. Minorca had fallen, from want of resources rather than the attacks of the French, before he could do anything for the assistance of the garrison of Fort St. Philip. In winter he was recalled to England, and he reached home on the 14th of January 1757. On the 24th of February following he was promoted full admiral.

It is said, but on no very good authority, that he was not on good terms with Pitt (afterwards earl of Chatham), and it is certain that when Pitt's great ministry was formed in June 1757, he was not included in the Board of Admiralty. Yet as he was continued in command of important forces in the Channel, it is obvious that his great capacity was fully recognized. In the late summer of 1757 he was entrusted with the naval side of an expedition to the coast of France. These operations, which were scottishly described at the time as breaking windows with guineas, were a favourite device of Pitt's for weakening the French and raising the confidence of the country. The expedition of 1757 was directed against Rochefort, and it effected nothing. Hawke, who probably expected very little good from it, did his own work as admiral punctually, but he cannot be said to have shown zeal, or any wish to inspire the military officers into making greater efforts than they were disposed naturally to make. The expedition returned to Spithead by the 6th of October. No part of the disappointment of the public, which was acute, was visited on Hawke. During the end of 1757 and the beginning of 1758 he continued cruising in the Channel in search of the French naval forces, without any striking success. In May of that year he was ordered to detach a squadron under the command of Howe to carry out further combined operations. Hawke considered himself as treated with a want of due respect, and was at the time in bad humour with the Admiralty. He somewhat pettishly threw up his command, but was induced to resume it by the board, which knew his value, and was not wanting in flattery. He retired in June for a time on the ground of health, but happily for his own glory and the service of the country he was able to hoist his flag in May 1759, the "wonderful year" of Garrick's song.

France was then elaborating a scheme of invasion which bears much resemblance to the plan afterwards formed by Napoleon. An army of invasion was collected at the Morbihan in Brittany, and the intention was to transport it under the protection of a powerful fleet which was to be made up by uniting the squadron at Brest with the ships at Toulon. The plan, like Napoleon's, had slight chance of success, since the naval part of the invading force must necessarily be brought together from distant points at the risk of interruption by the British squadrons. The naval forces of England were amply sufficient to provide whatever was needed to upset the plans of the French government. But the country was not so confident in the capacity of the navy to serve as a defence as it was taught to be in later generations. It had been seized by a most shameful panic at the beginning of the war in face of a mere threat of invasion. Therefore the anxiety of Pitt to baffle the schemes of the French

decisively was great, and the country looked on at the development of the naval campaign with nervous attention. The proposed combination of the French fleet was defeated by the annihilation of the Toulon squadron on the coast of Portugal by Boscawen in May, but the Brest fleet was still untouched and the troops were still at Morbihan. It was the duty of Hawke to prevent attack from this quarter. The manner in which he discharged his task marks an epoch in the history of the navy. Until his time, or very nearly so, it was still believed that there was rashness in keeping the great ships out after September. Hawke maintained his blockade of Brest till far into November. Long cruises had always entailed much bad health on the crews, but by the care he took to obtain fresh food, and the energy he showed in pressing the Admiralty for stores, he was able to keep his men healthy. Early in November a series of severe gales forced him off the French coast, and he was compelled to anchor in Torbay. His absence was brief, but it allowed the French admiral, M. de Conflans (1690?-1777), time to put to sea, and to steer for the Morbihan. Hawke, who had left Torbay on the 13th of November, learnt of the departure of the French at sea on the 17th from a look-out ship, and as the French admiral could have done nothing but steer for the Morbihan, he followed him thither. The news that M. de Conflans had got to sea spread a panic through the country, and for some days Hawke was the object of abuse of the most irrational kind. There was in fact no danger, for behind Hawke's fleet there were ample reserves in the straits of Dover, and in the North Sea. Following his enemy as fast as the bad weather, a mixture of calms and head winds would allow, the admiral sighted the French about 40 m. to the west of Belleisle on the morning of the 20th of November. The British fleet was of twenty-one sail, the French of twenty. There was also a small squadron of British ships engaged in watching the Morbihan as an inshore squadron, which was in danger of being cut off. M. de Conflans had a sufficient force to fight in the open sea without rashness, but after making a motion to give battle, he changed his mind and gave the signal to his fleet to steer for the anchorage at Quiberon. He did not believe that the British admiral would dare to follow him, for the coast is one of the most dangerous in the world, and the wind was blowing hard from the west and rising to a storm. Hawke, however, pursued without hesitation, though it was well on in the afternoon before he caught up the rear of the French fleet, and dark by the time the two fleets were in the bay. The action, which was more a test of seamanship than of gunnery, or capacity to manoeuvre in order, ended in the destruction of the French. Five ships only were taken or destroyed, but others ran ashore, and the French navy as a whole lost all confidence. Two British vessels were lost, but the price was little to pay for such a victory. No more fighting remained to be done. The fleet in Quiberon Bay suffered from want of food, and its distress is recorded in the lines:—

"Ere Hawke did bang
Mounseer Conflang
You sent us beef and beer;
Now Mounseer's beat
We've nought to eat,
Since you have nought to fear."

Hawke returned to England in January 1760 and had no further service at sea. He was not made a peer till the 20th of May 1776, and then only as Baron Hawke of Towton. From 1776 to 1777 he was first lord of the Admiralty. His administration was much criticized, perhaps more from party spirit than because of its real defects. Whatever his relations with Lord Chatham may have been he was no favourite with Chatham's partisans. It is very credible that, having spent all his life at sea, his faculty did not show in the uncongenial life of the shore. As an admiral at sea and on his own element Hawke has had no superior. It is true that he was not put to the test of having to meet opponents of equal strength and efficiency, but then neither has any other British admiral since the Dutch wars of the 17th century. On his death on the 17th of October 1781 his title passed to his son, Martin Bladen (1744-1805), and it is

still held by his descendants, the 7th Baron (b. 1860) being best known as a great Yorkshire cricketer.

There is a portrait of Hawke in the Painted Hall at Greenwich. His *Life* by Montagu Burrows (1883) has superseded all other authorities; it is supplemented in a few early particulars by Sir J. K. Laughton's article in the *Dict. Nat. Biog.* (1891).

HAWKER, ROBERT STEPHEN (1803-1874), English antiquary and poet, was born at Stoke Damerel, Devonshire, on the 3rd of December 1803. His father, Jacob Stephen Hawker, was at that time a doctor, but afterwards curate and vicar of Stratton, Cornwall. Robert was sent to Liskeard grammar school, and when he was about sixteen was apprenticed to a solicitor. He was soon removed to Cheltenham grammar school, and in April 1823 matriculated at Pembroke College, Oxford. In the same year he married Charlotte l'Ans, a lady much older than himself. On returning to Oxford he migrated to Magdalen Hall, where he graduated in 1828, having already won the Newdigate prize for poetry in 1827. He became vicar of Morwenstow, a village on the north Cornish coast, in 1834. Hawker described the bulk of his parishioners as a "mixed multitude of smugglers, wreckers and dissenters of various hues." He was himself a high churchman, and carried things with a high hand in his parish, but was much beloved by his people. He was a man of great originality, and numerous stories were told of his striking sayings and eccentric conduct. He was the original of Mortimer Collins's *Canon Tremaine in Sweet and Twenty*. His first wife died in 1863, and in 1864 he married Pauline Kuczyński, daughter of a Polish exile. He died in Plymouth on the 15th of August 1875. Before his death he was formally received into the Roman Catholic Church, a proceeding which aroused a bitter newspaper controversy. The best of his poems is *The Quest of the Sangraal: Chant the First* (Exeter, 1864). Among his *Cornish Ballads* (1860) the most famous is on "Trelawny," the refrain of which, "And shall Trelawny die," &c., he declared to be an old Cornish saying.

See *The Vicar of Morwenstow* (1875; later and corrected editions, 1876 and 1886), by the Rev. S. Baring-Gould, which was severely criticized by Hawker's friend, W. Maskell, in the *Athenaeum* (March 26, 1876); *Memorials of the late Robert Stephen Hawker* (1876), by the late Dr F. G. Lee. These were superseded in 1905 by *The Life and Letters of R. S. Hawker*, by his son-in-law, C. E. Byles, which contains a bibliography of his works, now very valuable to collectors. See also Boase and Courtney, *Bibliotheca Cornubiensis*. His *Poetical Works* (1879) and his *Prose Works* (1893) were edited by J. G. Godwin. Another edition of his *Poetical Works* (1899) has a preface and bibliography by Alfred Wallis, and a complete edition of his poems by C. E. Byles, with the title *Cornish Ballads and other Poems*, appeared in 1904.

HAWKERS and PEDLARS, the designation of itinerant dealers who convey their goods from place to place to sell. The word "hawker" seems to have come into English from the Ger. *Höher* or Dutch *houker* in the early 16th century. In an act of 1533 (25 Henry VIII. c. 9, § 6) we find "Sundry evil disposed persons which commonly be called hawkers . . . buying and selling of Brasse and Pewter." The earlier word for such an itinerant dealer is "huckster," which is found in 1200, "For that they have turned God's house intill hucksteress bothe" (*Ormulum*, 15,817). The base of the two words is the same, and is probably to be referred to German *hocken*, to squat, crouch; cf. "hucklebone," the hip-bone; and the hawkers or hucksters were so called either because they stooped under their packs, or squatted at booths in markets, &c. Another derivation finds the origin in the Dutch *hoek*, a hole, corner. It may be noticed that the termination of "huckster" is feminine; though there are examples of its application to women it was always applied indiscriminately to either sex.

"Pedlar" occurs much earlier than the verbal form "to peddle," which is therefore a derivative from the substantive. The origin is to be found in the still older word "pedder," one who carries about goods for sale in a "ped," a basket or hamper. This is now only used dialectically and in Scotland. In the *Ancien Rivule* (c. 1225), *peoddare* is found with the meaning of "pedlar," though the *Promptorium parvulorum* (c. 1440) defines it as *calatharius*, i.e. a maker of panniers or baskets.

The French term for a hawker or pedlar of books, *colporteur* (*col*, neck, *porter*, to carry), has been adopted by the Bible Society and other English religious bodies as a name for itinerant vendors and distributors of Bibles and other religious literature.

The occupation of hawkers and pedlars has been regulated in the United Kingdom, and the two classes have also been technically distinguished. The Pedlars Act 1871 defines a pedlar as "any hawker, pedlar, petty chapman, tinker, caster of metals, mender of chairs, or other person who, without any horse or other beast bearing or drawing burden, travels and trades on foot and goes from town to town or to other men's houses, carrying to sell or exposing for sale any goods, wares or merchandise . . . or selling or offering for sale his skill in handicraft." Any person who acts as a pedlar must have a certificate, which is to be obtained from the chief officer of police of the police district in which the person applying for the certificate has resided during one month previous to his application. He must satisfy the officer that he is above seventeen years of age, is of good character, and in good faith intends to carry on the trade of a pedlar. The fee for a pedlar's certificate is five shillings, and the certificate remains in force for a year from the date of issue. The act requires a register of certificates to be kept in each district, and imposes a penalty for the assigning, borrowing or forging of any certificate. It does not exempt any one from vagrant law, and requires the pedlar to show his certificate on demand to certain persons. It empowers the police to inspect a pedlar's pack, and provides for the arrest of an uncertificated pedlar or one refusing to show his certificate. A pedlar's certificate is not required by commercial travellers, sellers of vegetables, fish, fruit or victuals, or sellers in fairs. The Hawkers Act 1888 defines a hawker as "any one who travels with a horse or other beast of burden, selling goods," &c. An excise licence (expiring on the 31st of March in each year) must be taken out by every hawker in the United Kingdom. The duty imposed upon such licence is £2. A hawker's licence is not granted, otherwise than by way of licence, except on production of a certificate signed by a clergyman and two householders of the parish or place wherein the applicant resides, or by a justice of the county or place, or a superintendent or inspector of police for the district, attesting that the person is of good character and a proper person to be licensed as a hawker. There are certain exemptions from taking out a licence—commercial travellers, sellers of fish, coal, &c., sellers in fairs, and the real worker or maker of any goods. The act also lays down certain provisions to be observed by hawkers and others, and imposes penalties for infringements. In the United States hawkers and pedlars must take out licences under State laws and Federal laws.

HAWKESWORTH, JOHN (c. 1715-1773), English miscellaneous writer, was born in London about 1715. He is said to have been clerk to an attorney, and was certainly self-educated. In 1744 he succeeded Samuel Johnson as compiler of the parliamentary debates for the *Gentleman's Magazine*, and from 1746 to 1749 he contributed poems signed Greville, or H. Greville, to that journal. In company with Johnson and others he started a periodical called *The Adventurer*, which ran to 140 numbers, of which 70 were from the pen of Hawkesworth himself. On account of what was regarded as its powerful defence of morality and religion, Hawkesworth was rewarded by the archbishop of Canterbury with the degree of LL.D. In 1754-1755 he published an edition (12 vols.) of Swift's works, with a life prefixed which Johnson praised in his *Lives of the Poets*. A larger edition (27 vols.) appeared in 1766-1770. He adapted Dryden's *Amphitryon* for the Drury Lane stage in 1756, and Southerne's *Oronooko* in 1759. He wrote the libretto of an oratorio *Zimri* in 1760, and the next year *Edgar and Emmeline; a Fairy Tale*, was produced at Drury Lane. His *Almorán and Hamet* (2 vols., 1761) was first of all drafted as a play, and a tragedy founded on it by S. J. Pratt, *The Fair Circassian* (1781), met with some success. He was commissioned by the admiralty to edit Captain Cook's papers relative to his first voyage. For this work, *An Account of the Voyages undertaken . . . for making discoveries in the Southern Hemisphere and performed by Commodore Byrnes, Captain Wallis, Captain Carteret and Captain Cook (from 1764 to 1771) drawn up from the Journals . . .* (3 vols., 1773), Hawkesworth is said to have received from the publishers the sum of £6000. His descriptions of the manners and customs of the South Seas were, however, regarded by many critics as inexact and hurtful to the interests of morality, and the severity of their strictures is said to have hastened his death, which took place on the 16th of November 1773. He was buried

at Bromley, Kent, where he and his wife had kept a school. Hawkesworth was a close imitator of Johnson both in style and thought, and was at one time on very friendly terms with him. It is said that he presumed on his success, and lost Johnson's friendship as early as 1756.

HAWKHURST, a town in the southern parliamentary division of Kent, England, 47 m. S.E. of London, on a branch of the South-Eastern & Chatham railway. Pop. (1901), 3136. It lies mainly on a ridge above the valley of the Kent Ditch, a tributary of the Rother. The neighbouring country is hilly, rich and well wooded, and the pleasant and healthy situation has led to the considerable extension of the old village as a residential locality. The Kent Sanatorium and one of the Barnardo homes are established here. The church of St Lawrence, founded from Battle Abbey in Sussex, is Decorated and Perpendicular and its east window, of the earlier period, is specially beautiful.

HAWKINS, CAESAR HENRY (1798-1884), British surgeon, son of the Rev. E. Hawkins and grandson of the Sir Caesar Hawkins (1711-1786), who was serjeant-surgeon to Kings George II. and George III., was born at Bisley, Gloucestershire, on the 19th of September 1798, was educated at Christ's Hospital, and entered St George's Hospital, London, in 1818. He was surgeon to the hospital from 1820 to 1861, and in 1862 was made serjeant-surgeon to Queen Victoria. He was president of the College of Surgeons in 1852, and again in 1861; and he delivered the Hunterian oration in 1849. His success in complex surgical cases gave him a great reputation. For long he was noted as the only surgeon who had succeeded in the operation of ovariotomy in a London hospital. This occurred in 1846, when anaesthetics were unknown. He did much to popularize colotomy. A successful operator, he nevertheless was attached to conservative surgery, and was always more anxious to teach his pupils how to save a limb than how to remove it. He reprinted his contributions to the medical journals in two volumes, 1874, the more valuable papers being on *Tumours, Excision of the Ovarium, Hydrophobia and Snake-bites, Stricture of the Colon, and The Relative Claims of Sir Charles Bell and Magendie to the Discovery of the Functions of the Spinal Nerves*. He died on the 20th of July 1884. His brother, Edward Hawkins (1789-1882), was the well-known provost of Oriel, Oxford, who played so great a part in the Tractarian movement.

HAWKINS, or HAWKYN, SIR JOHN (1532-1595), British admiral, was born at Plymouth in 1532, and belonged to a family of Devonshire shipowners and skippers—occupations then more closely connected than is now usual. His father, William Hawkins (d. 1553), was a prosperous freeman of Plymouth, who thrice represented that town in parliament, and is described by Hakluyt as one of the principal sea-captains in the west parts of England; his elder brother, also called William (d. 1589), was closely associated with him in his Spanish expeditions, and took an active part in fitting out ships to meet the Armada; and his nephew, the eldest son of the last named and of the same name, sailed with Sir Francis Drake to the South Sea in 1577, and served as lieutenant under Edward Fenton (f.n.) in the expedition which started for the East Indies and China in 1582. His son, Sir Richard Hawkins, is separately noticed.

Sir John Hawkins was bred to the sea in the ships of his family. When the great epoch of Elizabethan maritime adventure began, he took an active part by sailing to the Guinea coast, where he robbed the Portuguese slavers, and then smuggled the negroes he had captured into the Spanish possessions in the New World. After a first successful voyage in 1562-1563, two vessels which he had rashly sent to Seville were confiscated by the Spanish government. With the help of friends, and the open approval of the queen, who hired one of her vessels to him, he sailed again in 1564, and repeated his voyage with success, trading with the Creoles by force when the officials of the king endeavoured to prevent him. These two voyages brought him reputation, and he was granted a coat of arms with a demi-Moor, or negro, chained, as his crest. The rivalry with Spain was now

becoming very acute, and when Hawkins sailed for the third time in 1567, he went in fact, though not technically, on a national venture. Again he kidnapped negroes, and forced his goods on the Spanish colonies. Encouraged by his discovery that these settlements were small and unfortified, he on this occasion ventured to enter Vera Cruz, the port of Mexico, after capturing some Spaniards at sea to be held as hostages. He alleged that he had been driven in by bad weather. The falsity of the story was glaring, but the Spanish officers on the spot were too weak to offer resistance. Hawkins was allowed to enter the harbour, and to refit at the small rocky island of San Juan de Ulloa by which it is formed. Unfortunately for him, and for a French corsair whom he had in his company, a strong Spanish force arrived, bringing the new viceroy. The Spaniards, who were no more scrupulous of the truth than himself, pretended to accept the arrangement made before their arrival, and then when they thought he was off his guard attacked him on the 24th of September. Only two vessels escaped, his own, the "Minion," and the "Judith," a small vessel belonging to his cousin Francis Drake. The voyage home was miserable, and the sufferings of all were great.

For some years Hawkins did not return to the sea, though he continued to be interested in privateering voyages as a capitalist. In the course of 1572 he recovered part of his loss by pretending to betray the queen for a bribe to Spain. He acted with the knowledge of Lord Burleigh. In 1573 he became treasurer of the navy in succession to his father-in-law Benjamin Gonson. The office of comptroller was conferred on him soon after, and for the rest of his life he remained the principal administrative officer of the navy. Burleigh noted that he was suspected of fraud in his office, but the queen's ships were kept by him in good condition. In 1588 he served as rear-admiral against the Spanish Armada and was knighted. In 1590 he was sent to the coast of Portugal to intercept the Spanish treasure fleet, but did not meet it. In giving an account of his failure to the queen he quoted the text "Paul doth plant, Apollo doth water, but God giveth the increase," which exhibition of piety is said to have provoked the queen into exclaiming, "God's death! This fool went out a soldier, and has come home a divine." In 1595 he accompanied Drake on another treasure-hunting voyage to the West Indies, which was even less successful, and he died at sea off Porto Rico on the 12th of November 1595.

Hawkins was twice married, first to Katharine Gonson and then to Margaret Vaughan. He was counted a puritan when puritanism meant little beyond hatred of Spain and popery, and when these principles were an ever-ready excuse for voyages in search of slaves and plunder. In the course of one of his voyages, when he was becalmed and his negroes were dying, he consoled himself by the reflection that God would not suffer His elect to perish. Contemporary evidence can be produced to show that he was greedy, unscrupulous and rude. But if he had been a more delicate man he would not have risked the gallows by making piratical attacks on the Portuguese and by appearing in the West Indies as an armed smuggler; and in that case he would not have played an important part in history by setting the example of breaking down the pretension of the Spaniards to exclude all comers from the New World. His morality was that of the average stirring man of his time, whether in England or elsewhere.

See R. A. J. Walling, *A Sea-dog of Devon* (1907); and Southey in his *British Admirals*, vol. iii. The original accounts of his voyages compiled by Hakluyt have been reprinted by the Hakluyt Society, with a preface by Sir C. R. Markham.

HAWKINS, SIR JOHN (1719-1789), English writer on music, was born on the 30th of March 1719, in London, the son of an architect who destined him for his own profession. Ultimately, however, Hawkins took to the law, devoting his leisure hours to his favourite study of music. A wealthy marriage in 1753 enabled him to indulge his passion for acquiring rare works of music, and he bought, for example, the collection formed by Dr Pepusch, and subsequently presented by Hawkins to the British Museum. It was on such materials that Hawkins

founded his celebrated work on the *General History of the Science and Practice of Music*, in 5 vols. (republished in 2 vols., 1876). It was brought out in 1776, the same year which witnessed the appearance of the first volume of Burney's work on the same subject. The relative merits of the two works were eagerly discussed by contemporary critics. Burney no doubt is infinitely superior as a literary man, and his work accordingly comes much nearer the idea of a systematic treatise on the subject than Hawkins's, which is essentially a collection of rare and valuable pieces of music with a more or less continuous commentary. But by rescuing these from oblivion Hawkins has given a permanent value to his work. Of Hawkins's literary efforts apart from music it will be sufficient to mention his occasional contributions to the *Gentleman's Magazine*, his edition (1760) of the *Complete Angler* (1787) and his biography of Dr Johnson, with whom he was intimately acquainted. He was one of the original members of the Ivy Lane Club, and ultimately became one of Dr Johnson's executors. If there were any doubt as to his intimacy with Johnson, it would be settled by the slighting way in which Boswell refers to him. Speaking of the Ivy Lane Club, he mentions amongst the members "Mr John Hawkins, an attorney," and adds the following footnote, which at the same time may serve as a summary of the remaining facts of Hawkins's life: "He was for several years chairman of the Middlesex justices, and upon presenting an address to the king accepted the usual offer of knighthood (1772). He is the author of a *History of Music* in five volumes in quarto. By assiduous attendance upon Johnson in his last illness he obtained the office of one of his executors—in consequence of which the booksellers of London employed him to publish an edition of Dr Johnson's works and to write his life." Sir John Hawkins died on the 21st of May 1789, and was buried in the cloisters of Westminster Abbey.

HAWKINS, or HAWKINS, SIR RICHARD (c. 1562–1622), British seaman, was the only son of Admiral Sir John Hawkins (q.v.) by his first marriage. He was from his earliest days familiar with ships and the sea, and in 1582 he accompanied his uncle, William Hawkins, to the West Indies. In 1585 he was captain of a galliot in Drake's expedition to the Spanish main, in 1588 he commanded a queen's ship against the Armada, and in 1590 served with his father's expedition to the coast of Portugal. In 1593 he purchased the "Dainty," a ship originally built for his father and used by him in his expeditions, and sailed for the West Indies, the Spanish main and the South Seas. It seems clear that his project was to prey on the oversea possessions of the king of Spain. Hawkins, however, in an account of the voyage written thirty years afterwards, maintained, and by that time perhaps had really persuaded himself, that his expedition was undertaken purely for the purpose of geographical discovery. After visiting the coast of Brazil, the "Dainty" passed through the Straits of Magellan, and in due course reached Valparaiso. Having plundered the town, Hawkins pushed north, and in June 1594, a year after leaving Plymouth, arrived in the bay of San Mateo. Here the "Dainty" was attacked by two Spanish ships. Hawkins was hopelessly outmatched, but defended himself with great courage. At last, when he himself had been severely wounded, many of his men killed, and the "Dainty" was nearly sinking, he surrendered on the promise of a safe-conduct out of the country for himself and his crew. Through no fault of the Spanish commander this promise was not kept. In 1597 Hawkins was sent to Spain, and imprisoned first at Seville and subsequently at Madrid. He was released in 1602, and, returning to England, was knighted in 1603. In 1604 he became member of parliament for Plymouth and vice-admiral of Devon, a post which, as the coast was swarming with pirates, was no sinecure. In 1620–1621 he was vice-admiral under Sir Robert Mansell, of the fleet sent into the Mediterranean to reduce the Algerian corsairs. He died in London on the 17th of April 1622.

See his *Observations in his Voyage into the South Sea* (1622), re-published by the Hakluyt Society.

HAWKS, FRANCIS LISTER (1708–1866), American clergyman, was born at Newbern, North Carolina, on the 10th of June 1708,

and graduated at the university of his native state in 1815. After practising law with some distinction he entered the Episcopal ministry in 1827 and proved a brilliant and impressive preacher, holding livings in New Haven, Philadelphia, New York and New Orleans, and declining several bishoprics. On his appointment as historiographer of his church in 1835, he went to England, and collected the abundant materials afterwards utilized in his *Contributions to the Ecclesiastical History of U.S.A.* (New York, 1836–1839). These two volumes dealt with Maryland and Virginia, while two later ones (1863–1864) were devoted to Connecticut. He was the first president of the university of Louisiana (now merged in Tulane). He died in New York on the 26th of September 1866.

HAWKSHAW, SIR JOHN (1811–1891), English engineer, was born in Yorkshire in 1811, and was educated at Leeds grammar school. Before he was twenty-one he had been engaged for six or seven years in railway engineering and the construction of roads in his native county, and in the year of his majority he obtained an appointment as engineer to the Bolivar Mining Association in Venezuela. But the climate there was more than his health could stand, and in 1834 he was obliged to return to England. He soon obtained employment under Jesse Hartley at the Liverpool docks, and subsequently was made engineer in charge of the railway and navigation works of the Manchester, Bury and Bolton Canal Company. In 1845 he became chief engineer to the Manchester & Leeds railway, and in 1847 to its successor, the Lancashire & Yorkshire railway, for which he constructed a large number of branch lines. In 1850 he removed to London and began to practise as a consulting engineer, at first alone, but subsequently in partnership with Harrison Hayter. In that capacity his work was of an extremely varied nature, embracing almost every branch of engineering. He retained his connexion with the Lancashire & Yorkshire Company until his retirement from professional work in 1888, and was consulted on all the important engineering points that affected it in that long period. In London he was responsible for the Charing Cross and Cannon Street railways, together with the two bridges which carried them over the Thames; he was engineer of the East London railway, which passes under the Thames through Sir M. I. Brunel's well-known tunnel; and jointly with Sir J. Wolfe Barry he constructed the section of the Underground railway which completed the "inner circle" between the Aldgate and Mansion House stations. In addition, many railway works claimed his attention in all parts of the world—Germany; Russia, India, Mauritius &c. One noteworthy point in his railway practice was his advocacy, in opposition to Robert Stephenson, of steeper gradients than had previously been thought desirable or possible, and so far back as 1838 he expressed decided disapproval of the maintenance of the broad gauge on the Great Western, because of the troubles he foresaw it would lead to in connexion with future railway extension, and because he objected in general to breaks of gauge in the lines of a country. The construction of canals was another branch of engineering in which he was actively engaged. In 1862 he became engineer of the Amsterdam ship-canal, and in the succeeding year he may fairly be said to have been the saviour of the Suez Canal. About that time the scheme was in very bad odour, and the khedive determined to get the opinion of an English engineer as to its practicability, having made up his mind to stop the works if that opinion was unfavourable. Hawkshaw was chosen to make the inquiry, and it was because his report was entirely favourable that M. de Lesseps was able to say at the opening ceremony that to him he owed the canal. As a member of the International Congress which considered the construction of an interoceanic canal across central America, he thought best of the Nicaraguan route, and privately he regarded the Panama scheme as impracticable at a reasonable cost, although publicly he expressed no opinion on the matter and left the Congress without voting. Sir John Hawkshaw also had a wide experience in constructing harbours (e.g. Holyhead) and docks (e.g. Penarth, the Albert Dock at Hull, and the south dock of the East and West India Docks in London), in river-engineering, in drainage and sewerage.

in water-supply, &c. He was engineer, with Sir James Brunlees, of the original Channel Tunnel Company from 1872, but many years previously he had investigated for himself the question of a tunnel under the Strait of Dover from an engineering point of view, and had come to a belief in its feasibility, so far as that could be determined from borings and surveys. Subsequently, however, he became convinced that the tunnel would not be to the advantage of Great Britain, and thereafter would have nothing to do with the project. He was also engineer of the Severn Tunnel, which, from its magnitude and the difficulties encountered in its construction, must rank as one of the most notable engineering undertakings of the 19th century. He died in London on the 2nd of June 1891.

HAWKSLEY, THOMAS (1807-1893), English engineer, was born on the 12th of July 1807, at Arnold, near Nottingham. He was at Nottingham grammar school till the age of fifteen, but was indebted to his private studies for his knowledge of mathematics, chemistry and geology. In 1822 he was articled to an architect in Nottingham, subsequently becoming a partner in the firm, which also undertook engineering work; and in 1852 he removed to London, where he continued in active practice till he was well past eighty. His work was chiefly concerned with water and gas supply and with main-drainage. Of water-works he used to say that he had constructed 150, and a long list might be drawn up of important towns that owe their water to his skill, including Liverpool, Sheffield, Leicester, Leeds, Derby, Darlington, Oxford, Cambridge and Northampton in England, and Stockholm, Altona and Bridgetown (Barbados) in other countries. To his native town of Nottingham he was water engineer for fifty years, and the system he designed for it was noteworthy from the fact that the principle of constant supply was adopted for the first time. The gas-works at Nottingham, and at many other towns for which he provided water supplies were also constructed by him. He designed main-drainage systems for Birmingham, Worcester and Windsor among other places, and in 1857 he was called in, together with G. P. Bidder and Sir J. Bazalgette, to report on the best solution of the vexed question of a main-drainage scheme for London. In 1872 he was president of the Institution of Civil Engineers—an office in which his son Charles followed him in 1901. He died in London on the 23rd of September 1893.

HAWKSMOOR, NICHOLAS (1661-1736), English architect, of Nottinghamshire birth, became a pupil of Sir Christopher Wren at the age of eighteen, and his name is intimately associated with those of Wren and Sir J. Vanbrugh in the English architecture of his time. Through Wren's influence he obtained various official posts, as deputy-surveyor at Chelsea hospital, clerk of the works and deputy-surveyor at Greenwich hospital, clerk of the works at Whitehall, St James's and Westminster, and he succeeded Wren as surveyor-general of Westminster Abbey. He took part in much of the work done by Wren and Vanbrugh, and it is difficult often to assign among them the credit for the designs of various features. Hawksmoor appears, however, to have been responsible for the early Gothic designs of the two towers of All Souls' (Oxford) north quadrangle, and the library and other features at Queen's College (Oxford). At the close of Queen Anne's reign he had a principal part in the scheme for building fifty new churches in London, and himself designed five or six of them, including St Mary Woolnoth. (1716-1719) and St George's, Bloomsbury (1720-1730). A number of his drawings have been preserved. He died in London on the 25th of March 1736.

HAWKWOOD, SIR JOHN (d. 1394), an English adventurer who attained great wealth and renown as a condottiere in the Italian wars of the 14th century. His name is variously spelt as Haccoude, Aucud, Aguto, &c., by contemporaries. It is said that he was the son of a tanner of Hedingham Sibil in Essex, and was apprenticed in London, whence he went, in the English army, to France under Edward III. and the Black Prince. It is said also that he obtained the favour of the Black Prince, and received knighthood from King Edward III., but though it is certain that he was of knightly rank, there is no evidence as to

the time or place at which he won it. On the peace of Bretigny in 1360, he collected a band of men-at-arms, and moved southward to Italy, where we find the White Company, as his men were called, assisting the marquis of Monferrato against Milan in 1362-63, and the Pisans against Florence in 1364. After several campaigns in various parts of central Italy, Hawkwood in 1368 entered the service of Bernabò Visconti. In 1369 he fought for Perugia against the pope, and in 1370 for the Visconti against Pisa, Florence and other enemies. In 1372 he defeated the marquis of Monferrato, but soon afterwards, resenting the interference of a council of war with his plans, Hawkwood resigned his command, and the White Company passed into the papal service, in which he fought against the Visconti in 1373-1375. In 1375 the Florentines entered into an agreement with him, by which they were to pay him and his companion 130,000 gold florins in three months on condition that he undertook no engagement against them; and in the same year the priors of the arts and the gonfalonier decided to give him a pension of 1200 florins per annum for as long as he should remain in Italy. In 1377, under the orders of the cardinal Robert of Geneva, legate of Bologna, he massacred the inhabitants of Cesena, but in May of the same year, disliking the executioner's work put upon him by the legate, he joined the anti-papal league, and married, at Milan, Donnina, an illegitimate daughter of Bernabò Visconti. In 1378 and 1379 Hawkwood was constantly in the field; he quarrelled with Bernabò in 1378, and entered the service of Florence, receiving, as in 1375, 130,000 gold florins. He rendered good service to the republic up to 1382, when for a time he was one of the English ambassadors at the papal court. He engaged in a brief campaign in Naples in 1383, fought for the marquis of Padua against Verona in 1386, and in 1388 made an unsuccessful effort against Gian Galeazzo Visconti, who had murdered Bernabò. In 1390 the Florentines took up the war against Gian Galeazzo in earnest, and appointed Hawkwood commander-in-chief. His campaign against the Milanese army in the Veronese and the Bergamask was reckoned a triumph of generalship, and in 1392 Florence exacted a satisfactory peace from Gian Galeazzo. His latter years were spent in a villa in the neighbourhood of Florence. On his death in 1394 the republic gave him a public funeral of great magnificence, and decreed the erection of a marble monument in the cathedral. This, however, was never executed; but Paolo Uccelli painted his portrait in terre-verte on the inner façade of the building, where it still remains, though damaged by removal from the plaster to canvas. Richard II. of England, probably at the instigation of Hawkwood's sons, who returned to their native country, requested the Florentines to let him remove the good knight's bones, and the Florentine government signified its consent.

Of his children by Donnina Visconti, who appears to have been his second wife, the eldest daughter married Count Brezaglia of Porciglia, podestà of Ferrara, who succeeded him as Florentine commander-in-chief, and another a German condottiere named Conrad Prospergh. His son, John, returned to England and settled at Hedingham Sibil, where, it is supposed, Sir John Hawkwood was buried. The children of the first marriage were two sons and three daughters, and of the latter the youngest married John Shelley, an ancestor of the poet.

AUTHORITIES.—Muratori, *Rerum Italicarum scriptores*, and supplement by Tartinius and Manni; *Archivio storico italiano*; Temple-Leader and Marcotti, *Giovanni Acuto* (Florence, 1889; Eng. transl., Leader Scott, London, 1889); Nichol, *Bibliotheca topographica Britannica*, vol. vi.; J. G. Alger in *Register and Magazine of Biography*, v. 1.; and article in *Dict. Nat. Biog.*

HAWLEY, HENRY (c. 1670-1759), British lieutenant-general, entered the army, it is said, in 1694. He saw service in the War of Spanish Succession as a captain of Erle's (the 19th) Foot. After Almanza he returned to England, and a few years later had become lieutenant-colonel of the 19th. With this regiment he served at Sheriffmuir in 1715, where he was wounded. After this for some years he served in the United Kingdom, obtaining promotion in the usual course, and in 1739 he arrived at the grade of major general. Four years later he accompanied George II.

and Stair to Germany, and, as a general officer of cavalry under Sir John Cope, was present at Dettingen. Becoming lieutenant-general somewhat later, he was second-in-command of the cavalry at Fontenoy, and on the 30th of December 1745 became commander-in-chief in Scotland. Less than a month later Hawley suffered a severe defeat at Falkirk at the hands of the Highland insurgents. This, however, did not cost him his command, for the duke of Cumberland, who was soon afterwards sent north, was captain-general. Under Cumberland's orders Hawley led the cavalry in the campaign of Culloden, and at that battle his dragoons distinguished themselves by their ruthless butchery of the fugitive rebels. After the end of the "Forty-Five" he accompanied Cumberland to the Low Countries and led the allied cavalry at Lauffeld (Val). He ended his career as governor of Portsmouth and died at that place in 1759. James Wolfe, his brigade-major, wrote of General Hawley in no flattering terms. "The troops dread his severity, hate the man and hold his military knowledge in contempt," he wrote. But, whether it be true or false that he was the natural son of George II., Hawley was always treated with the greatest favour by that king and by his son the duke of Cumberland.

HAWLEY, JOSEPH ROSWELL (1826-1905), American political leader, was born on the 31st of October at Stewartville, Richmond county, North Carolina, where his father, a native of Connecticut, was pastor of a Baptist church. The father returned to Connecticut in 1837 and the son graduated at Hamilton College (Clinton, N.Y.) in 1847. He was admitted to the bar in 1850, and practised at Hartford, Conn., for six years. An ardent opponent of slavery, he became a Free Soiler, was a delegate to the National Convention which nominated John P. Hale for the presidency in 1852, and subsequently served as chairman of the State Committee, having at the same time editorial control of the *Charter Oak*, the party organ. In 1856 he took a leading part in organizing the Republican party in Connecticut, and in 1857 became editor of the *Hartford Evening Press*, a newly established Republican newspaper. He served in the Federal army throughout the Civil War, rising from the rank of captain (April 22, 1861) to that of brigadier-general of volunteers (Sept. 1864); took part in the Port Royal Expedition, in the capture of Fort Pulaski (April 1862), in the siege of Charleston and the capture of Fort Wagner (Sept. 1863), in the battle of Olustee (Feb. 20, 1864), in the siege operations about Petersburg, and in General W. T. Sherman's campaign in the Carolinas; and in September 1865 received the brevet of major-general of volunteers. From April 1866 to April 1867 he was governor of Connecticut, and in 1867 he bought the *Hartford Courant*, with which he combined the *Press*, and which became under his editorship the most influential newspaper in Connecticut and one of the leading Republican papers in the country. He was the permanent chairman of the Republican National Convention in 1868, was a delegate to the conventions of 1872, 1876 and 1880, was a member of Congress from December 1872 until March 1875 and again in 1879-1881, and was a United States senator from 1881 until the 3rd of March 1905, being one of the Republican leaders both in the House and the Senate. From 1873 to 1876 he was president of the United States Centennial Commission, the great success of the Centennial Exhibition being largely due to him. He died at Washington, D.C., on the 17th of March 1905.

HAWORTH, an urban district in the Keighley parliamentary division of the West Riding of Yorkshire, England, 10 m. N.W. of Bradford, on a branch of the Midland railway. Pop. (1901), 7492. It is picturesquely situated on a steep slope, lying high, and surrounded by moorland. The Rev. Patrick Brontë (d. 1861) was incumbent here for forty-one years, and a memorial near the west window of St Michael's church bears his name and the names of his gifted daughters upon it. The grave of Charlotte and Emily Brontë is also marked by a brass. In 1895 a museum was opened by the Brontë society. There is a large worsted industry.

HAWSER (in sense and form as if from "hawse," which, from the 16th-century form *halse*, is derived from Teutonic

hals, neck, of which there is a Scandinavian use in the sense of the forepart of a ship; the two words are not etymologically connected; "hawser" is from an O. Fr. *haucier*, *hausser*, to raise, tow, hoist, from the Late Lat. *altiare*, to lift, *altus*, high), a small cable or thick rope used at sea for the purposes of mooring or warping, in the case of large vessels made of steel. When a cable or tow line is made of three or more small ropes it is said to be "hawser-laid." The "hawse" of a ship is that part of the bows where the "hawse-holes" are made. These are two holes cut in the bows of a vessel for the cables to pass through, having small cast-iron pipes, called "hawse-pipes," fitted into them to prevent abrasion. In bad weather at sea these holes are plugged up with "hawse-plugs" to prevent the water entering. The phrase to enter the service by the "hawse-holes" is used of those who have risen from before the mast to commissioned rank in the navy. When the ship is at anchor the space between her head and the anchor is called "hawse," as in the phrase "athwart the hawse." The term also applies to the position of the ship's anchors when moored; when they are laid out in a line at right angles to the wind it is said to be moored with an "open hawse"; when both cables are laid out straight to their anchors without crossing, it is a "clear hawse."

HAWTHORN, a city of Bourke county, Victoria, Australia, 4½ m. by rail E. of and suburban to Melbourne. Pop. (1901), 21,339. It is the seat of the important Methodist Ladies' College. The majority of the inhabitants are professional and business men engaged in Melbourne and their residences are numerous at Hawthorn.

HAWTHORN (O. Eng. *haga*, *hag*, or *hege-thorn*, i.e. "hedgethorn"), the common name for *Crataegus*, in botany, a genus of shrubs or small trees belonging to the natural order Rosaceae, native of the north temperate regions, especially America. It is represented in the British Isles by the hawthorn, white-thorn or may (Ger. *Hagedorn* and *Christdorn*; Fr. *aubépine*), *C. oxyacantha*, a small, round-headed, much-branched tree, 10 to 20 ft. high, the branches often ending in single sharp spines. The leaves, which are deeply cut, are 1 to 2 in. long and very variable in shape. The flowers are sweet-scented, in flat-topped clusters, and ½ to ¾ in. in diameter, with five spreading white petals alternating with five persistent green sepals, a large number of stamens with pinkish-brown anthers, and one to three carpels sunk in the cup-shaped floral axis. The fruit, or haw, as in the apple, consists of the swollen floral axis, which is usually scarlet, and forms a fleshy envelope surrounding the hard stone.

The common hawthorn is a native of Europe as far north as 60½° in Sweden, and of North Africa, western Asia and Siberia, and has been naturalized in North America and Australia. It thrives best in dry soils, and in height varies from 4 or 5 to 12, 15 or, in exceptional cases, as much as between 20 and 30 ft. It may be propagated from seed or from cuttings. The seeds must be from ripe fruit, and if fresh gathered should be freed from pulp by maceration in water. They germinate only in the second year after sowing; in the course of their first year the seedlings attain a height of 6 to 12 in. Hawthorn has been for many centuries a favourite park and hedge plant in Europe, and numerous varieties have been developed by cultivation; these differ in the form of the leaf, the white, pink or red, single or double flowers, and the yellow, orange or red fruit. In England the hawthorn, owing to its hardness and closeness of growth, has been employed for enclosure of land since the Roman occupation, but for ordinary field hedges it is believed it was generally in use till about the end of the 17th century. James I. of Scotland, in his *Quair*, ii. 14 (early 15th century), mentions the "hawthorn hedges knet" of Windsor Castle. The first hawthorn hedges in Scotland are said to have been planted by soldiers of Cromwell at Inch Bucking Brae in East Lothian and Finlarig in Perthshire. Annual pruning, to which the hawthorn is particularly amenable, is necessary if the hedge is to maintain its compactness and sturdiness. When the lower part shows a tendency to go bare the strong stems may be "plashed," i.e. split, bent over and pegged to the ground so that new growths may start. The wood of the hawthorn is white in colour, with

a yellowish tinge. Fresh cut it weighs 68 lb 12 oz. per cubic foot, and dry 57 lb 3 oz. It can seldom be obtained in large portions, and has the disadvantage of being apt to warp; its great hardness, however, renders it valuable for the manufacture of various articles, such as the cogs of mill-wheels, flails and mallets, and handles of hammers. Both green and dry it forms excellent fuel. The bark possesses tanning properties, and in Scotland in past times yielded with ferrous sulphate a black dye for wool. The leaves are eaten by cattle, and have been employed as a substitute for tea. Birds and deer feed upon the haws, which are used in the preparation of a fermented and highly intoxicating liquor. The hawthorn serves as a stock for grafting other trees. As an ornamental feature in landscapes, it is worthy of notice; and the pleasing shelter it affords and the beauty of its blossoms have frequently been alluded to by poets. The custom of employing the flowering branches for decorative purposes on the 1st of May is of very early origin; but since the alteration in the calendar the tree has rarely been in full bloom in England before the second week of that month. In the Scottish Highlands the flowers may be seen as late as the middle of June. The hawthorn has been regarded as the emblem of hope, and its branches are stated to have been carried by the ancient Greeks in wedding processions, and to have been used by them to deck the altar of Hymen. The supposition that the tree was the source of Christ's crown of thorns gave rise doubtless to the tradition current among the French peasantry that it utters groans and cries on Good Friday, and probably also to the old popular superstition in Great Britain and Ireland that ill-luck attended the uprooting of hawthorns. Branches of the Glastonbury thorn, *C. oxyacantha*, var. *præcox*, which flowers both in December and in spring, were formerly highly valued in England, on account of the legend that the tree was originally the staff of Joseph of Arimathea.

The number of species in the genus is from fifty to seventy, according to the view taken as to whether or not some of the forms, especially of those occurring in the United States, represent distinct species. *C. coccinea*, a native of Canada and the eastern United States, with bright scarlet fruits, was introduced into English gardens towards the end of the 17th century. *C. Crus-Galli*, with a somewhat similar distribution and introduced about the same time, is a very decorative species with showy, bright red fruit, often remaining on the branches till spring, and leaves assuming a brilliant scarlet and orange in the autumn; numerous varieties are in cultivation. *C. Pyracantha*, known in gardens as pyracantha, is evergreen and has white flowers, appearing in May, and fine scarlet fruits of the size of a pea which remain on the tree nearly all the winter. It is a native of south Europe and was introduced into Britain early in the 17th century.

HAWTHORNE, NATHANIEL (1804-1864), American writer, son of Nathaniel Hathorne (1776-1808), was born at Salem, Massachusetts, on the 4th of July 1804. The head of the American branch of the family, William Hathorne of Wiltor, Wiltshire, England, emigrated with Winthrop and his company, and arrived at Salem Bay, Mass., on the 12th of June 1630. He had grants of land at Dorchester, where he resided for upwards of six years, when he was persuaded to remove to Salem by the tender of further grants of land there, it being considered a public benefit that he should become an inhabitant of that town. He represented his fellow-townsmen in the legislature, and served them in a military capacity as a captain in the first regular troop organized in Salem, which he led to victory through an Indian campaign in Maine. Originally a determined "Separatist," and opposed to compulsion for conscience, he signaled himself when a magistrate by the active part which he took in the Quaker persecutions of the time (1657-1662), going so far on one occasion as to order the whipping of Anne Coleman and four other Friends through Salem, Boston and Dedham. He died, an old man, in the odour of sanctity, and left a good property to his son John, who inherited his father's capacity and intolerance, and was in turn a legislator, a magistrate, a soldier and a bitter persecutor of witches. Before the death of Justice Hathorne in 1717, the

destiny of the family suffered a sea-change, and they began to be noted as mariners. One of these seafaring Hathornes figured in the Revolution as a privateer, who had the good fortune to escape from a British prison-ship; and another, Captain Daniel Hathorne, has left his mark on early American ballad-lore. He too was a privateer, commander of the brig "Fair American," which, cruising off the coast of Portugal, fell in with a British scow laden with troops for General Howe, which scow the bold Hathorne and his valiant crew at once engaged and fought for over an hour, until the vanquished enemy was glad to cut the Yankee grapplings and quickly bear away. The last of the Hathornes with whom we are concerned was a son of this sturdy old privateer, Nathaniel Hathorne. He was born in 1776, and about the beginning of the 19th century married Miss Elizabeth Clarke Manning, a daughter of Richard Manning of Salem, whose ancestors emigrated to America about fifty years after the arrival of William Hathorne. Young Nathaniel took his hereditary place before the mast, passed from the forecastle to the cabin, made voyages to the East and West Indies, Brazil and Africa, and finally died of fever at Surinam, in the spring of 1808. He was the father of three children, the second of whom was the subject of this article. The form of the family name was changed by the latter to "Hawthorne" in his early manhood.

After the death of her husband Mrs Hawthorne removed to the house of her father with her little family of children. Of the boyhood of Nathaniel no particulars have reached us, except that he was fond of taking long walks alone, and that he used to declare to his mother that he would go to sea some time and would never return. Among the books that he is known to have read as a child were Shakespeare, Milton, Pope and Thomson, *The Castle of Indolence* being an especial favourite. In the autumn of 1818 his mother removed to Raymond, a town in Cumberland county, Maine, where his uncle, Richard Manning, had built a large and ambitious dwelling. Here the lad resumed his solitary walks, exchanging the narrow streets of Salem for the boundless, primeval wilderness, and its sluggish harbour for the fresh bright waters of Sebago lake. He roamed the woods by day, with his gun and rod, and in the moonlight nights of winter skated upon the lake alone till midnight. When he found himself away from home, and wearied with his exercise, he took refuge in a log cabin where half a tree would be burning upon the hearth. He had by this time acquired a taste for writing, that showed itself in a little blank-book, in which he jotted down his woodland adventures and feelings, and which was remarkable for minute observation and nice perception of nature.

After a year's residence at Raymond, Nathaniel returned to Salem in order to prepare for college. He amused himself by publishing a manuscript periodical, which he called the *Spectator*, and which displayed considerable vivacity and talent. He speculated upon the profession that he would follow, with a sort of prophetic insight into his future. "I do not want to be a doctor and live by men's diseases," he wrote to his mother, "nor a minister to live by their sins, nor a lawyer and live by their quarrels. So I don't see that there is anything left for me but to be an author. How would you like some day to see a whole shelf full of books, written by your son, with 'Hawthorne's Works' printed on their backs?"

Nathaniel entered Bowdoin College, Brunswick, Maine, in the autumn of 1821, where he became acquainted with two students who were destined to distinction—Henry W. Longfellow and Franklin Pierce. He was an excellent classical scholar, his Latin compositions, even in his freshman year, being remarkable for their elegance, while his Greek (which was less) was good. He made graceful translations from the Roman poets, and wrote several English poems which were creditable to him. After graduation three years later (1825) he returned to Salem, and to a life of isolation. He devoted his mornings to study, his afternoons to writing, and his evenings to long walks along the rocky coast. He was scarcely known by sight to his townsmen, and he held so little communication with the members of his own family that his meals were frequently left at his

locked door. He wrote largely, but destroyed many of his manuscripts, his taste was so difficult to please. He thought well enough, however, of one of his compositions to print it anonymously in 1828. A crude melodramatic story, entitled *Fanshawe*, it was unworthy even of his immature powers, and should never have been rescued from the oblivion which speedily overtook it. The name of Nathaniel Hawthorne finally became known to his countrymen as a writer in *The Token*, a holiday annual which was commenced in 1828 by Mr S. G. Goodrich (better known as "Peter Parley"), by whom it was conducted for fourteen years. This forgotten publication numbered among its contributors most of the prominent American writers of the time, none of whom appear to have added to their reputation in its pages, except the least popular of all—Hawthorne, who was for years the obscurest man of letters in America, though he gradually made admirers in a quiet way. His first public recognition came from England, where his genius was discovered in 1835 by Henry F. Chorley, one of the editors of the *Athenaeum*, in which he copied three of Hawthorne's most characteristic papers from *The Token*. He had but little encouragement to continue in literature, for Mr Goodrich was so much more a publisher than an author that he paid him wretchedly for his contributions, and still more wretchedly for his work upon an *American Magazine of Useful and Entertaining Knowledge*, which he persuaded him to edit. This author-publisher consented, however, at a later period (1837) to bring out a collection of Hawthorne's writings under the title of *Twice-told Tales*. A moderate edition was got rid of, but the great body of the reading public ignored the book altogether. It was generously reviewed in the *North American Review* by his college friend Longfellow, who said it came from the hand of a man of genius, and praised it for the exceeding beauty of its style, which was as clear as running waters.

The want of pecuniary success which had so far attended his authorship led Hawthorne to accept a situation which was tendered him by George Bancroft, the historian, collector of the port of Boston under the Democratic rule of President Van Buren. He was appointed a weigher in the custom-house at a salary of about \$1200 a year, and entered upon the duties of his office, which consisted for the most part in measuring coal, salt and other bulky commodities on foreign vessels. It was irksome employment, but faithfully performed for two years, when he was superseded through a change in the national administration. Master of himself once more, he returned to Salem, where he remained until the spring of 1841, when he wrote a collection of children's stories entitled *Grandfather's Chair*, and joined an industrial association at West Roxbury, Mass. Brook Farm, as it was called, was a social Utopia, composed of a number of advanced thinkers, whose object was so to distribute manual labour as to give its members time for intellectual culture. The scheme worked admirably—on paper; but it was suited neither to the temperament nor the taste of Hawthorne, and after trying it patiently for nearly a year he returned to the everyday life of mankind.

One of Hawthorne's earliest admirers was Miss Sophia Peabody, a lady of Salem, whom he married in the summer of 1842. He made himself a new home in an old manse, at Concord, Mass., situated on historic ground, in sight of an old revolutionary battlefield, and devoted himself diligently to literature. He was known to the few by his *Twice-told Tales*, and to the many by his papers in the *Democratic Review*. He published in 1842 a further portion of *Grandfather's Chair*, and also a second volume of *Twice-told Tales*. He also edited, during 1845, the *African Journals* of Horatio Bridge, an officer of the navy, who had been at college with him; and in the following year he published in two volumes a collection of his later writings, under the title of *Mosses from an Old Manse*.

After a residence of nearly four years at Concord, Hawthorne returned to Salem, having been appointed surveyor of the custom-house of that port by a new Democratic administration. He filled the duties of this position until the incoming of the Whig administration again led to his retirement. He seems to

have written little during his official term, but, as he had leisure enough and to spare, he read much, and pondered over subjects for future stories. His next work, *The Scarlet Letter*, which was begun after his removal from the custom-house, was published in 1850. If there had been any doubt of his genius before, it was settled for ever by this powerful romance.

Shortly after the publication of *The Scarlet Letter* Hawthorne removed from Salem to Lenox, Berkshire, Mass., where he wrote *The House of the Seven Gables* (1851) and *The Wonder-Book* (1851). From Lenox he removed to West Newton, near Boston, Mass., where he wrote *The Blithedale Romance* (1852) and *The Snow Image and other Twice-told Tales* (1852). In the spring of 1852 he removed back to Concord, where he purchased an old house which he called *The Wayside*, and where he wrote *Life of Franklin Pierce* (1852) and *Tanglewood Tales* (1853). Mr Pierce was the Democratic candidate for the presidency, and it was only at his urgent solicitation that Hawthorne consented to become his biographer. He declared that he would accept no office in case he were elected, lest it might compromise him; but his friends gave him such weighty reasons for reconsidering his decision that he accepted the consulate at Liverpool, which was understood to be one of the best gifts at the disposal of the president.

Hawthorne departed for Europe in the summer of 1853, and returned to the United States in the summer of 1860. Of the seven years which he passed in Europe five were spent in attending to the duties of his consulate at Liverpool, and in little journeys to Scotland, the Lakes and elsewhere, and the remaining two in France and Italy. They were quiet and uneventful, coloured by observation and reflection, as his note-books show, but productive of only one elaborate work, *Transformation, or The Marble Faun*, which he sketched out during his residence in Italy, and prepared for the press at Leamington, England, whence it was despatched to America and published in 1860.

Hawthorne took up his abode at *The Wayside*, not much richer than when he left it, and sat down at his desk once more with a heavy heart. He was surrounded by the throes of a great civil war, and the political party with which he had always acted was under a cloud. His friend ex-President Pierce was stigmatized as a traitor, and when Hawthorne dedicated his next book to him—a volume of English impressions entitled *Our Old Home* (1863)—it was at the risk of his own popularity. His pen was soon to be laid aside for ever; for, with the exception of the unfinished story of *Septimius Felton*, which was published after his death by his daughter Una (1872), and the fragment of *The Dolliver Romance*, the beginning of which was published in the *Atlantic Monthly* in July 1864, he wrote no more. His health gradually declined, his hair grew white as snow, and the once stalwart figure that in early manhood flashed along the airy cliffs and glittering sands sauntered idly on the little hill behind his house. In the beginning of April 1864 he made a short southern tour with his publisher Mr William D. Ticknor, and was benefited by the change of scene until he reached Philadelphia, where he was shocked by the sudden death of Mr Ticknor. He returned to *The Wayside*, and after a short season of rest joined his friend ex-President Pierce. He died at Plymouth, New Hampshire, on the 19th of May 1864, and five days later was buried at Sleepy Hollow, a beautiful cemetery at Concord, where he used to walk under the pines when he was living at the Old Manse, and where his ashes moulder under a simple stone, inscribed with the single word "Hawthorne."

The writings of Hawthorne are marked by subtle imagination, curious power of analysis and exquisite purity of diction. He studied exceptional developments of character, and was fond of exploring secret crypts of emotion. His shorter stories are remarkable for originality and suggestiveness, and his larger ones are as absolute creations as *Hamlet* or *Undine*. Lacking the accomplishment of verse, he was in the highest sense a poet. His work is pervaded by a manly personality, and by an almost feminine delicacy and gentleness. He inherited the gravity of his Puritan ancestors without their superstition, and learned in his solitary meditations a knowledge of the night-side of life

which would have filled them with suspicion. A profound anatomist of the heart, he was singularly free from morbidness, and in his darkest speculations concerning evil was robustly right-minded. He worshipped conscience with his intellectual as well as his moral nature; it is supreme in all he wrote. Besides these mental traits, he possessed the literary quality of style—a grace, a charm, a perfection of language which no other American writer ever possessed in the same degree, and which places him among the great masters of English prose.

His *Complete Writings* (22 vols., Boston, 1901) were edited, with introduction, including a bibliography, by H. S. Scudder. The standard authority for Hawthorne's biography is *Nathaniel Hawthorne and his Wife* (2 vols., Boston, 1884), by his son Julian Hawthorne (b. 1846), himself a novelist and critic of distinction. See also Henry James, *Hawthorne* (London, 1879), in the "English Men of Letters" series; Julian Hawthorne, *Hawthorne and his Circle* (New York, 1903); a paper in R. H. Hutton's *Essays Theological and Literary* (London, 1871); George B. Smith, *Poets and Novelists* (London, 1875); Moncure D. Conway, *Life of Nathaniel Hawthorne* (London, 1890, in the "Great Writers" series); Horatio Bridge, *Personal Recollections of Nathaniel Hawthorne* (New York, 1893); Rose Hawthorne Lathrop, *Memoirs of Hawthorne* (Boston, 1897); W. C. Lawton, *The New England Poets* (New York, 1898); Sir L. Stephen, *Hours in a Library* (1874); Annie Fields, *Nathaniel Hawthorne* (Boston, 1899); G. E. Woodberry, *Life of Hawthorne* (1902); and bibliography by N. E. Browne (1905). (R. H. S.)

HAWTREY, CHARLES HENRY (1858—), English actor, was born at Eton, where his father was master of the lower school, and educated at Rugby and Oxford. He took to the stage in 1881, and in 1883 adapted von Moser's *Bibliothekar* as *The Private Secretary*, which had an enormous success. He then appeared in London in a number of modern plays, in which he was conspicuous as a comedian. He was unapproachable for parts in which cool imperturbable lying constituted the leading characteristic. Among his later successes *A Message from Mars* was particularly popular in London and in America.

HAWTREY, EDWARD CRAVEN (1789-1862), English educationalist, was born at Burnham on the 7th of May 1789, the son of the vicar of the parish. He was educated at Eton and King's College, Cambridge, and in 1814 was appointed assistant master at Eton under Dr Keate. In 1834 he became headmaster of the college, and his administration was a vigorous one. New buildings were erected, including the school library and the sanatorium, the college chapel was restored, the Old Christopher Inn was closed, and the custom of "Montem," the collection by street begging of funds for the university expenses of the captain of the school, was suppressed. He is supposed to have suggested the prince consort's modern language prizes, while the prize for English essay he founded himself. In 1852 he became provost of Eton, and in 1854 vicar of Mapledurham. He died on the 27th of January 1862, and was buried in the Eton College chapel. On account of his command of languages ancient and modern, he was known in London as "the English Mezzofanti," and he was a book collector of the finest taste. Among his own books are some excellent translations from the English into Italian, German and Greek. He had a considerable reputation as a writer of English hexameters and as a judge of Homeric translation.

HAXO, FRANÇOIS NICOLAS, BENOÎT, BARON (1774-1838), French general and military engineer, was born at Lunéville on the 24th of June 1774, and entered the Engineers in 1793. He remained unknown, doing duty as a regimental officer for many years, until, as major, he had his first chance of distinction in the second siege of Saragossa in 1809, after which Napoleon made him a colonel. Haxo took part in the campaign of Wagram, and then returned to the Peninsula to direct the siege operations of Suchet's army in Catalonia and Valencia. In 1810 he was made general of brigade, in 1811 a baron, and in the same year he was employed in preparing the occupied fortresses of Germany against a possible Russian invasion. In 1812 he was chief engineer of Davout's I. corps, and after the retreat from Moscow he was made general of division. In 1813 he constructed the works around Hamburg which made possible the famous defence of that fortress by Davout, and commanded the Guard Engineers until he fell into the enemy's hands at Kulm. After the Restora-

tion Louis XVIII. wished to give Haxo a command in the Royal Guards, but the general remained faithful to Napoleon, and in the Hundred Days laid out the provisional fortifications of Paris and fought at Waterloo. It was, however, after the second Restoration that the best work of his career as a military engineer was done. As inspector-general he managed, though not without meeting considerable opposition, to reconstruct in accordance with the requirements of the time, and the designs which he had evolved to meet them, the old Vauban and Cormontaigne fortresses which had failed to check the invasions of 1814 and 1815. For his services he was made a peer of France by Louis Philippe (1832). Soon after this came the French intervention in Belgium and the famous scientific siege of Antwerp citadel. Under Marshal Gérard Haxo directed the besiegers and completely outmatched the opposing engineers, the fortress being reduced to surrender after a siege of a little more than three weeks (December 23, 1832). He was after this regarded as the first engineer in Europe, and his latter years were spent in urging upon the government and the French people the fortification of Paris and Lyons, a project which was partly realized in his time and after his death fully carried out. General Haxo died at Paris on the 25th of June 1838. He wrote *Mémoire sur le figuré du terrain dans les cartes topographiques* (Paris, N.D.), and a memoir of General Dejean (1824).

HAXTHAUSEN, AUGUST FRANZ LUDWIG MARIA, FREIHERR VON (1792-1866), German political economist, was born near Paderborn in Westphalia on the 3rd of February 1792. Having studied at the school of mining at Klausthal, and having served in the Hanoverian army, he entered the university of Göttingen in 1815. Finishing his course there in 1818 he was engaged in managing his estates and in studying the land law. The result of his studies appeared in 1829 when he published *Über die Agrarverfassung in den Fürstentümern Paderborn und Corvey*, a work which attracted much attention and which procured for its author a commission to investigate and report upon the land laws of the Prussian provinces with a view to a new code. After nine years of labour he published in 1839 an exhaustive treatise, *Die ländliche Verfassung in der Provinz Preussen*, and in 1843, at the request of the emperor Nicholas, he undertook a similar work for Russia, the fruits of his investigations in that country being contained in his *Studien über die innern Zustände des Volkstums, und insbesondere die ländlichen Einrichtungen Russlands* (Hanover, 1847-1852). He received various honours, was a member of the combined diet in Berlin in 1847 and 1848, and afterwards of the Prussian upper house. Haxthausen died at Hanover on the 31st of December 1866.

In addition to the works already mentioned he wrote *Die ländliche Verfassung Russlands* (Leipzig, 1866). His *Studien* has been translated into French and into English by R. Farie as *The Russian Empire* (1856). Other works of his which have appeared in English are: *Transcaucasia: Sketches of the Nations and Races between the Black Sea and the Caspian* (1854), and *The Tribes of the Caucasus* (1855). Haxthausen edited *Das konstitutionelle Prinzip* (Leipzig, 1864), a collection of political writings by various authors, which has been translated into French (1865).

HAY, GEORGE (1729-1811), Scottish Roman Catholic divine, was born at Edinburgh on the 24th of August 1729. He was accused of sympathizing with the rebellion of 1745 and served a term of imprisonment 1746-1747. He then entered the Roman Catholic Church, studied in the Scots College at Rome, and in 1750 accompanied John Geddes (1735-1799), afterwards bishop of Morocco, on a Scottish mission. Ten years later he was appointed bishop of Daulis *in partibus* and coadjutor to Bishop James Grant (1706-1778). In 1778 he became vicar apostolic of the lowland district. During the Protestant riots in Edinburgh in 1779 his furniture and library were destroyed by fire. From 1788 to 1793 he was in charge of the Scaln seminary; in 1802 he retired to that of Aquhories near Inverury which he had founded in 1799. He died there on the 15th of October 1811.

His theological works, including *The Sincere Christian, The Devout Christian, The Pious Christian and The Scripture Doctrine of Miracles*, were edited by Bishop Strain in 1871-1873.

HAY, GILBERT, or "SIR GILBERT THE HAYE" (fl. 1490), Scottish poet and translator, was perhaps a kinsman of the house of Errol. If he be the student named in the registers of the university of St Andrews in 1418-1419, his birth may be fixed about 1403. He was in France in 1432, perhaps some years earlier, for a "Gilbert de la Haye" is mentioned as present at Reims; in July 1430, at the coronation of Charles VII. He has left it on record, in the Prologue to his *Buks of the Law of Armys*, that he was "chaumerlayn umquhyle to the maist worthy King Charles of France." In 1456 he was back in Scotland, in the service of the chancellor, William, earl of Orkney and Caithness, "in his castell of Roselyn," south of Edinburgh. The date of his death is unknown.

Hay is named by Dunbar (*q.v.*) in his *Lament for the Makaris*, and by Sir David Lyndsay (*q.v.*) in his *Testament and Complaynt of the Popyngis*. His only political work is *The Buik of Alexander the Conquerour*, of which a portion, in copy, remains at Taymouth Castle. He has left three translations, extant in one volume (in old binding) in the collection of Abbotsford: (a) *The Buks of the Law of Armys or The Buks of Botailis*, a translation of Honoré Bomet's *Arbre des batailles*; (b) *The Buks of the Order of Knichthood from the Livre de l'ordre de chevalerie*; and (c) *The Buks of the Governauce of Princes*, from a French version of the pseudo-Aristotelean *Sacra secretorum*. The second of these precedes Caxton's independent translation by at least ten years.

For the *Buik of Alexander* see Albert Hertmann's *The Taymouth Castle MS. of Sir Gilbert Hay's Buik, &c.* (Berlin, 1898). The complete Abbotsford MS. has been reprinted by the Scottish Text Society (ed. J. H. Stevenson). The first volume, containing *The Buks of the Law of Armys*, appeared in 1901. *The Order of Knichthood* was printed by David Laing for the Abbotsford Club (1847). See also S.T.S. edition (*s.v.*) "Introduction," and Gregory Smith's *Specimens of Middle Scots*, in which annotated extracts are given from the Abbotsford MS., the oldest known example of literary Scots prose.

HAY, JOHN (1838-1905), American statesman and author, was born at Salem, Indiana, on the 8th of October 1838. He graduated from Brown University in 1858, studied law in the office of Abraham Lincoln, was admitted to the bar in Springfield, Illinois, in 1861, and soon afterwards was selected by President Lincoln as assistant private secretary, in which capacity he served till the president's death, being associated with John George Nicolay (1832-1901). Hay was secretary of the U.S. legation at Paris in 1865-1867, at Vienna in 1867-1869 and at Madrid in 1869-1870. After his return he was for five years an editorial writer on the *New York Tribune*; in 1879-1881 he was first assistant secretary of state to W. M. Everts; and in 1881 was a delegate to the International Sanitary Conference, which met in Washington, D.C., and of which he was chosen president. Upon the inauguration of President McKinley in 1897 Hay was appointed ambassador to Great Britain, from which post he was transferred in 1898 to that of secretary of state, succeeding W. R. Day, who was sent to Paris as a member of the Peace Conference. He remained in this office until his death at Newburg, New Hampshire, on the 1st of July 1905. He directed the peace negotiations with Spain after the war of 1898, and not only secured American interests in the imbroglio caused by the Boxers in China, but grasped the opportunity to insist on "the administrative entity" of China; influenced the powers to declare publicly for the "open door" in China; challenged Russia as to her intentions in Manchuria, securing a promise to evacuate the country on the 8th of October 1903; and in 1904 again urged "the administrative entity" of China and took the initiative in inducing Russia and Japan to "localize and limit" the area of hostilities. It was largely due to his tact and good management, in concert with Lord Pauncefote, the British ambassador, that negotiations for abrogating the Clayton-Bulwer Treaty and for making a new treaty with Great Britain regarding the Isthmian Canal were successfully concluded at the end of 1901; subsequently he negotiated treaties with Colombia and with Panama, looking towards the construction by the United States of a trans-isthmian canal. He also arranged the settlement of difficulties with Germany over Samoa in December

1899, and the settlement, by joint commission, of the question concerning the disputed Alaskan boundary in 1903. John Hay was a man of quiet and unassuming disposition, whose training in diplomacy gave a cool and judicious character to his statesmanship. As secretary of state under Presidents McKinley and Roosevelt his guidance was invaluable during a rather critical period in foreign affairs, and no man of his time did more to create confidence in the increased interest taken by the United States in international matters. He also represented, in another capacity, the best American traditions—namely in literature. He published *Pike County Ballads* (1871)—the most famous being "Little Breeces"—a volume worthy to rank with Bret Harte, if not with the Lowell of the *Biglow Papers*; *Castilian Days* (1871), recording his observations in Spain; and a volume of *Poems* (1890); with John G. Nicolay he wrote *Abraham Lincoln: A History* (10 vols., 1890), a monumental work indispensable to the student of the Civil War period in America, and published an edition of Lincoln's *Complete Works* (2 vols., 1894). The authorship of the brilliant novel *The Breadwinners* (1883) is now certainly attributed to him. Hay was an excellent public speaker; some of his best addresses are *In Praise of Omar*; *On the Unweiling of the Bust of Sir Walter Scott in Westminster Abbey*, May 21, 1897; and a memorial address in honour of President McKinley.

The best of his previously unpublished speeches appeared in *Addresses of John Hay* (1906).

HAY, a town of Warwidgey county, New South Wales, Australia, on the Murrumbidgee river, 454 m. by rail W.S.W. of Sydney. Pop. (1901), 3012. It is the cathedral town of the Anglican diocese of Riverina, the terminus of the South Western railway, and the principal depot for the wool produced at the numerous stations on the banks of the Murrumbidgee and Lachlan rivers.

HAY, a market town and urban district of Breconshire, south Wales, on the Hereford and Brecon section of the Midland railway, 164½ m. from London, 20 m. W. of Hereford and 17 m. N.E. of Brecon by rail. Pop. (1901), 1680. The Golden Valley railway to Pontrilas (18½ m.), now a branch of the Great Western, also starts from Hay. The town occupies rising ground on the south (right) bank of the Wye, which here separates the counties of Brecknock and Radnor but immediately below enters Herefordshire, from which the town is separated on the E. by the river Dulas.

Leland and Camden ascribe a Roman origin to the town, and the former states that quantities of Roman coin (called by the country people "Jews' money") and some pottery had been found near by, but of this no other record is known. The Wye valley in this district served as the gate between the present counties of Brecknock and Hereford, and, though Welsh continued for two or three centuries after the Norman Conquest to be the spoken language of the adjoining part of Herefordshire south of the Wye (known as Archenfield), there must have been a "burh" serving as a Mercian outpost at Glasbury, 4 m. W. of Hay, which was itself several miles west of Offa's Dyke. But the earliest settlement at Hay probably dates from the Norman conquest of the district by Bernard Newmarch about 1088 (in which year he granted Glasbury, probably as the first fruits of his invasion, to St Peter's, Gloucester). The manor of Hay, which probably corresponded to some existing Welsh division, he gave to Sir Philip Walwyn, but it soon reverted to the donor, and its subsequent devolution down to its forfeiture to the crown as part of the duke of Buckingham's estate in 1521, was identical with that of the lordship of Brecknock (see BRECKNOCKSHIRE). The castle, which was probably built in Newmarch's time and rebuilt by his great-grandson William de Breos, passed on the latter's attainder to the crown, but was again seized by de Breos's second son, Giles, bishop of Hereford, in 1215, and retaken by King John in the following year. In 1231 it was burnt by Llewelyn ab Iorwerth, and in the Barons' War it was taken in 1263 by Prince Edward, but in the following year was burnt by Simon Montfort and the last Llewelyn. From the 16th century the castle has been used as a private residence.

The Welsh name of the town is Y Gelli ("the wood"), or formerly in full (Y) Gelli ganddryll (literally "the wood all to pieces"), which roughly corresponds to *Sepes Inscissa*, by which name Walter Map (a native of the district) designates it. Its Norman name, La Haia (from the Fr. *haie*, cf. English "hedge"), was probably intended as a translation of Gelli. The same word is found in Urishay and Oldhay, both between Hay and the Golden Valley. The town is still locally called *the Hay*, as it also is by Leland.

Even down to Leland's time Hay was surrounded by a "right strong wall," which had three gates and a postern, but the town within the wall has "wonderfully decayed," its ruin being ascribed to Owen Glendower, while to the west of it was a flourishing suburb with the church of St Mary on a precipitous eminence overlooking the river. This was rebuilt in 1834. The old parish church of St John within the walls, used as a school-house in the 17th century, has entirely disappeared. The Baptists, Calvinistic Methodists, Congregationalists and Primitive Methodists have a chapel each. The other public buildings are the market house (1833); a masonic hall, formerly the town hall, its basement still serving as a cheese market; a clock tower (1884); parish hall (1890); and a drill hall. The Wye is here crossed by an iron bridge built in 1864. There are also eighteen almshouses for poor women, built and endowed by Miss Frances Harley in 1832-1836, and Gwyn's almshouses for six aged persons, founded in 1702 and rebuilt in 1878.

Scarcely anything but provisions are sold in the weekly market, the farmers of the district now resorting to the markets of Brecon and Hereford. There are good monthly stock fairs and a hiring fair in May. There is rich agricultural land in the district.

Hay was reputed to be a borough by prescription, but it never had any municipal institutions. Its manor, like that of Talgarth, consisted of an Englishry and a Welshry, the latter, known as Haya Wallensis, comprising the parish of Llanigon with the hamlet of Glynfach, and in this Welsh tenures and customs prevailed. The manor is specially mentioned in the act of Henry VIII. (1535) as one of those which were then taken to constitute the new county of Brecknock. (D. L. T.)

HAY a word common in various forms to Teutonic languages; cf. Ger. *Hew*, Dutch *hoof*; the root from which it is derived, meaning "to cut," is also seen in "to hew"; cf. "hoe"), grass mown and dried in the sun and used as fodder for cattle. It is properly applied only to the grass when cut, but is often also used of the standing crop. (See *Haymaking* below). Another word "hay," meaning a fence, must be distinguished; the root from which it is derived is seen in its doublet "hedge"; cf. "haw-thorn," i.e. "hedge thorn." In this sense it survives in legal history in "hay bote," i.e. hedge-bote, the right of a tenant, copyholder, &c. to take wood to repair fences, hedges, &c. (see *ESTOVZAS*), and also in "hayward," an official of a manor whose duty was to protect the enclosed lands from cattle breaking out of the common land.

Haymaking.—The term "haymaking" signifies the process of drying and curing grass or other herbage so as to fit it for storage in stacks or sheds for future use. As a regular part of farm work it was unknown in ancient times. Before its introduction into Great Britain the animals intended for beef and mutton were slaughtered in autumn and salted down; the others were turned out to fend for themselves, and often lost all the fat in winter they had gained the previous summer. The introduction of haymaking gave unlimited scope for the production of winter food, and improved treatment of live stock became possible.

Though every country has its own methods of haymaking, the principal stages in the process everywhere are: (1) mowing, (2) drying or "making," (3) "carrying" and storage in stacks or sheds.

In a wet district such as the west of Ireland the "making" is a difficult affair and large quantities of hay are often spoiled, while much labour has to be spent in cocking up, turning over, ricking, &c., before it is fit to be stacked up. On the other hand, in the dry districts of south-eastern England it is often possible to cut and carry the hay without any special "making," as the

sun and wind will dry it quickly enough to fit it for stacking up without the expenditure of much labour. This rule also applies to dry countries like the United States and several of the British colonies, and it is for this reason that most of the modern implements used for quickly handling a bulk of hay have been invented or improved in those countries. Forage of all kinds intended for hay should be cut at or before the flowering stage if possible. The full growth and food value of the plant are reached then, and further change consists in the formation and ripening of the seed at the expense of the leaves and stems, leaving these hard and woody and of less feeding value.

Grass or other forage, when growing, contains a large proportion of water, and after cutting must be left to dry in the sun and wind, a process which may at times be assisted by turning over or shaking up. In fine weather in the south of England grass is sufficiently dried in from two to four days to be stacked straight away. In Scotland or other districts where the rainfall is heavy and the air moist, it is first put into small field-ricks or "pykes" of from 10 to 20 cwt. each. In the drying process the 75% of water usually present in grass should be reduced to approximately 15% in the hay, and in wet or broken weather it is exceedingly difficult to secure this reduction. With a heavy crop or in damp weather grass may need turning in the swathe, raking up into "windrows," and then making up into cocks or "quiles," i.e. round beehive-like heaps, before it can be "carried." A properly made cock will stand bad weather for a week, as only the outside straws are weathered, and therefore the hay is kept fresh and green. Indeed, it is a good rule always to cock hay, for even in sunny weather undue exposure ends in bleaching, which is almost as detrimental to its quality as wet-weathering.

In the last quarter of the 19th century the methods of hay-making were completely changed, and even some of the principles underlying its practice were revised. Generally speaking, before that time the only implements used were the scythe, the rake and the pitchfork; nowadays—with the exception of the pitchfork—these implements are seldom used, except where the work is carried on in a small way. Instead of the scythe, for instance, the mowing machine is employed for cutting the crop, and with a modern improved machine taking a swathe as wide as 5 or 6 ft. some 10 acres per day can easily be mown by one man and a pair of horses (figs. 1 and 2).

It will be seen from the figures that a mower consists of three principal parts: (1) a truck or carriage on two high wheels carrying the driving gear; (2) the cutting mechanism, comprising a reciprocating knife or sickle operating through slots in the guards or "fingers"

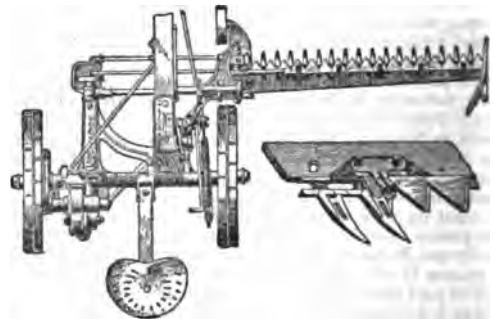

FIG. 1.—Mower (viewed from above) with enlarged detail of Blade. (Harrison, M'Gregor & Co.)

fastened to the cutting bar which projects to either the right or left of the truck; and (3) the pole with whiplettes, by which the horses are attached to give the motive power. The reciprocating knife has a separate blade to correspond to each finger, and is driven by a connecting rod and crank on the fore part of the truck. In work the pointed "fingers" pass in between the stalks of grass and the knives shear them off, acting against the fingers as the crank drives them backwards and forwards. In the swathe of grass left

behind by the machine, the stalks are, in a manner, thatched over one another, so that it is in the best position for drying in the sun, or, per contra, for shedding off the rain if the weather is wet. This is a great point in favour of the use of the machine, because the swathe left by the scythe required to be "tedded" out, i.e. the grass had to be shaken out or spread to allow it to be more easily dried.

After the grass has lain in the swathe a day or two till it is partly dried, it is necessary to turn it over to dry the other side. This used to be done with the hand rake, and a band of men or women would advance in *echelon* across a field, each turning the

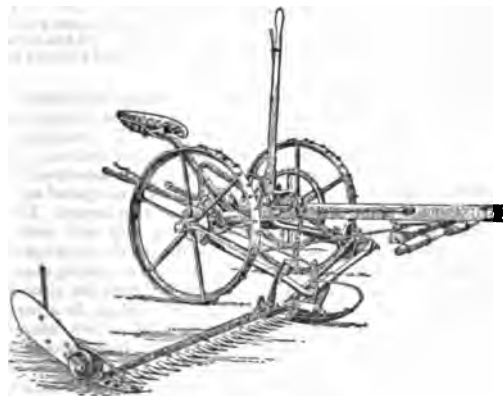

FIG. 2.—Mower (side view).

swathe of hay by regular strokes of the rake at each step: "driving the dusky wave along the mead" as described in Thomson's *Seasons*. This part of the work was the act of "haymaking" proper, and the subject of much sentiment in both prose and poetry. The swathes as laid by the mowing machine lent themselves to this treatment in the old days when the swathe was only some 3 to 4 ft. wide, but with the wide cut of the present day it becomes impracticable. If the hay is turned and "made" at all, the operation is now generally performed by a machine made for the purpose. There is a wide selection of "tedders" or "kickers," and "swathe-turners" on the market. The one illustrated in fig. 3 is the first prize winner at the Royal Agricultural Society's trials (1907). It



FIG. 3.—Swathe-turner. (Blackstone & Co., Ltd.).

takes two swathes at a time, and it will be seen that the working part consists of a wheel or circle of prongs or tines, which revolves across the line of the swathe. Each prong in turn catches the edge of the swathe of grass and kicks it up and over, thus turning it and leaving it loose for the wind to blow through.

The "kicker" is mounted on two wheels, and carries in bearings at the rear of the frame a multiple-cranked shaft, provided with a series of forks sleeved on the cranks and having their upper ends connected by links to the frame. As the crank-shaft is driven from the wheels by proper gearing the forks move

upward and forward, then downward and rearward, in an elliptical path, and kick the hay sharply to the rear, thus scattering and turning it.

It is a moot point, however, whether grass should be turned at all, or left to "make" as it falls from the mowing machine. In a dry sunny season and with a moderate crop it is only a waste of time and labour to turn it, for it will be cured quite well as it lies, especially if raked up into loose "windrows" a little before carrying to the stack. On the other hand, where the crop is heavy (say over 2 tons per acre) or the climate is wet, turning will be necessary.

With heavy crops of clover, lucerne and similar forage crops, turning may be an absolute necessity, because a thick swathe of a succulent crop will be difficult to dry or "make" excepting in hot sunny weather, but with ordinary meadow grass or with a mixture of "artificial" grasses it may often be dispensed with. It must be remembered, however, that the process of turning breaks the stalks (thus letting out the albuminoid and saccharine juices), and should be avoided as far as possible in order to save both labour and the quality of the hay.

One of the earlier mechanical inventions in connexion with hay-making was that of the horse rake (fig. 4). Before its introduction the hay, after making, had to be gathered up by the hand rake—a tedious and laborious process—but the introduction of this implement, whereby one horse and one man can do work before requiring six or eight men, marked a great advance. The horse rake is a framework on two wheels carrying hinged steel teeth placed 3 in. apart, so that their points slide along the ground below the hay. In work it gathers up the loose hay, and when full a tipping mechanism permits the emptying of the load.

The tipping is effected by pulling down a handle which sets a leverage device in motion, whereby the teeth are lifted up and the load of hay dropped below and left behind. On some rakes a

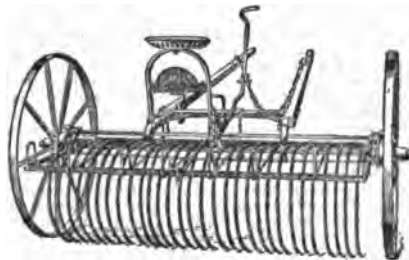

FIG. 4.—Self-acting Horse Rake. (Ransomes, Sims & Jefferies, Ltd.).

clutch is worked by the driver's foot, and this put in action causes the ordinary forward revolving motion of the driving wheels to do the tipping.

The loads are tipped end to end as the rake passes and repasses at the work, and thus the hay is left loose in long parallel rows on the field. Each row is termed a "windrow," the passage of the wind through the hay greatly aiding the drying and "making" thereof. When hay is in this form it may either be carried direct to the stack if sufficiently "made," or else put into cocks to season a little longer. The original width of horse rakes was about 8 ft., but nowadays they range up to 16 and 18 ft. The width should be suited to that of the swathes as left by the mower, and as the latter is now made to cut 5 and 6 ft. wide, it is necessary to have a rake to cover two widths. The very wide rakes are only suitable for even, level land; those of less width must be used where the land has been laid down in ridge and furrow. As the swathes lie in long parallel rows, it is a great convenience in working for two to be taken in width at a time, so that the horse can walk in the space between.

The side-delivery rake, a development of the ordinary horse rake, is a useful implement, adapted for gathering and laying a quantity of hay in one continuous windrow. It is customary with this to go up the field throwing two swathes to one side, and then back down on the adjacent swathes, so that thus four are thrown into one central windrow. The implement consists of a frame carried on two wheels with shafts for a horse; across the frame are fixed travelling or revolving prongs of different varieties which pick up the hay off the ground and pass it along sideways across the line of travel, leaving it in one continuous line. Some makes of swathe-turners are designed to do this work as well as the turning of the hay.

Perhaps the greatest improvement of modern times is the method

of carrying the hay from the field to the stack. An American invention known as the sweep rake was introduced by the writer into England in 1894, and now in many modified forms is in very general use in the Midlands and south of England, where the hay is carried from the cock, windrow or swathe straight to the stack. This implement consists of a wheeled framework fitted with long wooden iron-pointed teeth which slide along the ground; two horses are yoked to it—one at each side—the driver directing from a central seat behind the framework. When in use it is taken to the farther end of a row of cocks, a windrow, or even to a row of untouched swathes on the ground, and walked forward. As it advances it scoops up a load, and when full is drawn to where the stack is being erected (fig. 5). In ordinary circumstances the sweep rake will

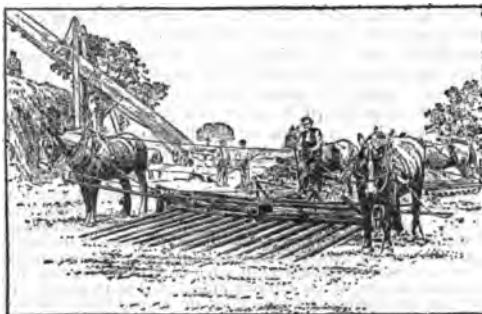

FIG. 5.—Sweep Rake.

pick up at a load two-thirds of an ordinary cart-load, but, where the hay is in good order and it is swept down hill, a whole one-horse cart-load can be carried each time. The drier the hay the better will the sweep rake work, and if it is not working sweetly but has a tendency to clog or make rolls of hay, it may be inferred that the latter is not in a condition fit for stacking. Where the loads must be taken through a gateway or a long distance to the stack, it is necessary to use carts or wagons, and the loading of these in the field out of the windrow is largely expedited by the use of the "loader," also an American invention of which many varieties are in the market. Generally speaking, it consists of a frame carrying a revolving web with tines or prongs. The implement is hitched on behind a cart or wagon, and as it moves forward the web picks the loose hay off the ground and delivers it on the top, where a man levels it with a pitchfork and builds it into a load ready to move to the stack. At the stack the most convenient method of transferring the hay from a cart, wagon or sweep rake is the elevator, a tall structure with a revolving web carrying teeth or spikes (fig. 6). The hay is thrown in forkfuls on at the bottom, a pony-gear causes the web to revolve, and the hay is carried in an almost continuous stream up the elevator and dropped over the top on to the stack. The whole implement is made to fold down, and is provided with wheels so that it can be moved from stack to stack. In the older forms there is a "hopper" or box at the bottom into which the hay is thrown to enable the teeth of the web to catch it, but in the modern forms there is no hopper, the web reaching down to the ground so that hay can be picked up from the ground level. Where the hay is brought to the stack on carts or wagons it can be unloaded by means of the horse fork. This is an adaptation of the principle of the ordinary crane; a central pole and jib are supported by guy ropes, and from the end of the jib a rope runs over a pulley. At the end of this rope is a "fork" formed of two sets of prongs which open and shut. This is lowered on to the load of hay, the prongs are forced into it, a horse pulls at the other end of the rope, and the prongs close and "grab" several cwt. of hay which are swung up and dropped on the stack. In this way a large cart or wagon load is hoisted on to the stack in three or four "forkfuls." The horse fork is not suited for use with the sweep rake, however, because the hay is brought up to the stack in a loose flat heap without sufficient body for the fork to get hold of.

In northern and wet districts of England it is customary to "make" the hay as in the south, but it is then built up into little stacks in the field where it grew (ricks, pykes or tramp-cocks are names used for these in different districts), each containing about 10 to 15 cwt. These are made in the same way as the ordinary stack—one person on top building, another on the ground pitching up the hay—and are carefully roped and raked down. In these the hay gets a preliminary sweating or tempering while at the same time it is rendered safe from the weather, and, thus stored, it may remain for weeks before being

carried to the big stacks at the homestead. The practice of putting up the hay into little ricks in the field has brought about the introduction of another set of implements for carrying these to the stackyard.

Various forms of rick-lifters are in use, the characteristic feature of which is a tipping platform on wheels to which a horse is attached between shafts. The vehicle is backed against a rick, and a chain passed round the bottom of the latter, which is then pulled up the slant of the tipped platform by means of a small windlass. When the centre of the balance is passed, the platform carrying the rick tips back to the level, and the whole is thus loaded ready to move. Another variety of loader is formed of three shear-legs with block and tackle. These are placed over a rick, under which the grab-irons are passed, and the whole hauled up by a horse. When high enough a cart is backed in below, the rick lowered, and the load is ready to carry away.

When put into a stack the next stage in curing the hay begins—the heating or sweating. In the growing plants the tissues are composed of living cells containing protoplasm. This continues its life action as long as it gets sufficient moisture and air. As life action involves the development of heat, the temperature in a confined space like a stack where the heat is not dissipated may rise to such a point that spontaneous combustion occurs. The chemical or physical reasons for this are not very well understood. The starch and sugar contents of the tissues are changed in part into alcohol. In the analogous process of making silage (*i.e.* stacking wet green grass in a closed building) the alcohol develops into acetic acid, thus making "sour" silage. In a hay-stack the intermediate body, acetaldehyde, which is both inflammable and suffocating, is produced—men having been suffocated when sleeping on the top of a heating stack. The production of this gas leads to slow combustion and ignition. One explanation of the process is that the protoplasm of the cells acts as a fermenting agent (like yeast) until a temperature sufficient to kill germ life, say 150° F., is reached, beyond which the action which leads up to the temperature of ignition must be purely chemical. If the stack contains no air at all it does not heat, or if it has excess

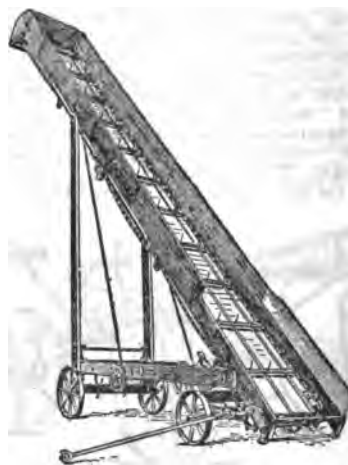

FIG. 6.—Hay Elevator. (Maldon Iron Works Co.).

of air it is safe. The danger-point in a stack is the centre at about 6 ft. from the ground; below this the weight of the hay itself squeezes out the air, and at the sides and top the heat is dissipated outwards. If a stack shows signs of overheating (a process that may take weeks or even months to develop) it can be saved by cutting a gap in the side of it with the hay knife, thus letting out the heat and fumes, and admitting fresh air to the centre. The essential point in haymaking is that the hay should be dried sufficiently to ensure the sweating process in the stack reaching no further than the stage of the formation of

sugar. Good hay should come out green and with the odour of coumarin—to which is due the scent of new-mown hay. Only part of a stack can ever attain to a perfect state: the tops, bottom and outsides are generally wasted by the weather after stacking, while there may be three or four intermediate qualities present. In some markets hay that has been sweated till it is brown in colour is desired, but for general purposes green hay is the best.

Hay often becomes musty when the weather during "making" has been too wet to allow of its getting sufficiently dry for stacking. Mustiness is caused by the growth of various moulds (*Penicillium*, *Aspergillus*, &c.) on the damp stems, with the result that the hay when cut out for use is dusty and shows white streaks and spots. Such hay is inferior to that which has been overheated, and in practice it is found that a strong heating will prevent mouldiness by killing the fungi.

Heavy lush crops—especially those containing a large proportion of clover or other leguminous plants—are proportionately more difficult to "make" than light grassy ones. Thus, if one ton is taken as a fair yield off one acre, a two-ton crop will probably require four times as much work in curing as the smaller crop. In the treacherous climate of Great Britain hay is frequently spoiled because the weather does not hold good long enough to permit of its being properly "made." Consequently many experienced haymakers regard a moderate crop as the more profitable because it can be stacked in first-class condition, whereas a heavy crop forced by "high farming" is grown at a loss, owing to the weather waste and the heavier expenses involved in securing it.

In handling or marketing out of the stack hay may be transported loose on a cart or wagon, but it is more usual to truss or bale it. A truss is a rectangular block cut out of the solid stack, usually about 3 ft. long and 2 ft. wide, and of a thickness sufficient to give a weight of 56 lb.; thirty-six of these constitute a "load" of 18 cwt.—the unit of sale in many markets. A truss is generally bound with two bands of twisted straw, but if it has to undergo much handling it is compressed in a hay-press and tied with two string bands. In some districts a baler is used: a square box with a compressible lid. The hay is tumbled in loose, the lid forced down by a leverage arrangement and the bale tied by three strings. It is usually made to weigh from 1 to 1½ cwt. The customs of different markets vary very much in their methods of handling hay, and in the overseas hay trade the size and style of the trusses or bales are adapted for packing on ship-board.

HAYASHI, TADASU, COUNT (1850—), Japanese statesman, was born in Tōkyō (then Yedo), and was one of the first batch of students sent by the Tokugawa government to study in England. He returned on the eve of the abolition of the Shōgunate, and followed Enomoto (q.v.) when the latter, sailing with the Tokugawa fleet to Yezo, attempted to establish a republic there in defiance of the newly organized government of the emperor. Thrown into prison on account of this affair, Hayashi did not obtain office until 1871. Thereafter he rose rapidly, until, after a long period of service as vice-minister of foreign affairs, he was appointed to represent his country first in Peking, then in St Petersburg and finally in London, where he acted an important part in negotiating the first Anglo-Japanese Alliance, for which service he received the title of viscount. He remained in London throughout the Russo-Japanese War, and was the first Japanese ambassador at the court of St James after the war. Returning to Tōkyō in 1906 to take the portfolio of foreign affairs, he remained in office until the resignation of the Saionji cabinet in 1908. He was raised to the rank of count for eminent services performed during the war between his country and Russia, and in connexion with the second Anglo-Japanese Alliance of 1905.

HAYDEN, FERDINAND VANDEVEER (1820—1887), American geologist, was born at Westfield, Massachusetts, on the 7th of September 1820. He graduated from Oberlin College in 1850 and from the Albany Medical College in 1853, where he attracted the notice of Professor James Hall, state geologist of New York, through whose influence he was induced to join in an exploration of Nebraska. In 1856 he was engaged under the United States government, and commenced a series of investigations of the

Western Territories, one result of which was his *Geological Report of the Exploration of the Yellowstone and Missouri Rivers in 1859-1860* (1860). During the Civil War he was actively employed as an army surgeon. In 1867 he was appointed geologist-in-charge of the United States Geological and Geographical Survey of the Territories, and from his twelve years of labour there resulted a most valuable series of volumes in all branches of natural history and economic science; and he issued in 1877 his *Geological and Geographical Atlas of Colorado*. Upon the reorganization and establishment of the United States Geological Survey in 1879 he acted for seven years as one of the geologists. He died at Philadelphia on the 22nd of December 1887.

His other publications were: *Sun Pictures of Rocky Mountain Scenery* (1870); *The Yellowstone National Park*, illustrated by chromolithographic reproductions of water-colour sketches by Thomas Moran (1876); *The Great West: its Attractions and Resources* (1880). With F. B. Meek, he wrote (*Smithsonian Institution Contributions*, v. 14, Art. 4) "Palaontology of the Upper Missouri, Pt. 1, Invertebrate." His valuable notes on Indian dialects are in *The Transactions of the American Philosophical Society* (1862), in *The American Journal of Science* (1862) and in *The Proceedings of the American Philosophical Society* (1866). With A. R. C. Selwyn he wrote *North America* (1883) for Stanford's *Compendium*.

HAYDN, FRANZ JOSEPH (1732—1809), Austrian composer, was born on the 31st of March 1732 at Rohrau (Trstnik), a village on the borders of Lower Austria and Hungary. There is sufficient evidence that his family was of Croatian stock: a fact which throws light upon the distinctively Slavonic character of much of his music. He received the first rudiments of education from his father, a wheelwright with twelve children, and at an early age evinced a decided musical talent. This attracted the attention of a distant relative named Johann Mathias Frankh, who was schoolmaster in the neighbouring town of Hainburg, and who, in 1738, took the child and for the next two years trained him as a chorister. In 1740, on the recommendation of the Dean of Hainburg, Haydn obtained a place in the cathedral choir of St Stephen's, Vienna, where he took the solo-part in the services and received, at the choir school, some further instruction on the violin and the harpsichord. In 1749 his voice broke, and the director, Georg von Reutter, took the occasion of a boyish escapade to turn him into the streets. A few friends lent him money and found him pupils, and in this way he was enabled to enter upon a rigorous course of study (he is said to have worked for sixteen hours a day), partly devoted to Fux's treatise on counterpoint, partly to the "Friedrich" and "Württemberg" sonatas of C. P. E. Bach, from which he gained his earliest acquaintance with the principles of musical structure. The first fruits of his work were a comic opera, *Der neue krumme Teufel*, and a Mass in F major (both written in 1751), the former of which was produced with success. About the same time he made the acquaintance of Metastasio, who was lodging in the same house, and who introduced him to one or two patrons; among others Señor Martinez, to whose daughter he gave lessons, and Porpora, who, in 1753, took him for the summer to Männersdorf, and there gave him instruction in singing and in the Italian language.

The turning-point of his career came in 1755, when he accepted an invitation to the country-house of Freiherr von Fürnberg, an accomplished amateur who was in the habit of collecting parties of musicians for the performance of chamber-works. Here Haydn wrote, in rapid succession, eighteen divertimenti which include his first symphony and his first quartet; the two earliest examples of the forms with which his name is most closely associated. Thenceforward his prospects improved. On his return to Vienna in 1756 he became famous as teacher and composer, in 1759 he was appointed conductor to the private band of Count Morzin, for whom he wrote several orchestral works (including a symphony in D major erroneously called his first), and in 1760 he was promoted to the sub-directorship of Prince Paul Esterhazy's *Kapelle*, at that time the best in Austria. During the tenure of his appointment with Count Morzin he married the daughter of a Viennese hairdresser named Keller, who had befriended him in his days of poverty, but the

marriage turned out ill and he was shortly afterwards separated from his wife, though he continued to support her until her death in 1800. From 1760 to 1790 he remained with the Esterházys, principally at their country-seats of Esterház and Eisenstadt, with occasional visits to Vienna in the winter. In 1762 Prince Paul Esterházy died and was succeeded by his brother Nicholas, surnamed the Magnificent, who increased Haydn's salary, showed him every mark of favour, and, on the death of Werner in 1766, appointed him *Oberkapellmeister*. With the encouragement of a discriminating patron, a small but excellent orchestra and a free hand, Haydn made the most of his opportunity and produced a continuous stream of compositions in every known musical form. To this period belong five Masses, a dozen operas, over thirty clavier-sonatas, over forty quartets, over a hundred orchestral symphonies and overtures, a *Stabat Mater*, a set of interludes for the service of the Seven Words, an Oratorio *Tobias* written for the *Tonkünstler-Societät* of Vienna, and a vast number of concertos, divertimenti and smaller pieces, among which were no less than 175 for Prince Nicholas' favourite instrument, the baryton.

Meanwhile his reputation was spreading throughout Europe. A Viennese notice of his appointment as *Oberkapellmeister* spoke of him as "the darling of our nation," his works were reprinted or performed in every capital from Madrid to St Petersburg. He received commissions from the cathedral of Cadiz, from the grand duke Paul, from the king of Prussia, from the directors of the *Concert Spirituel* at Paris; beside his transactions with Brettkopf and Härtel, and with La Chevardière, he sold to one English firm the copyright of no less than 120 compositions. But the most important fact of biography during these thirty years was his friendship with Mozart, whose acquaintance he made at Vienna in the winter of 1781-1782. There can have been little personal intercourse between them, for Haydn was rarely in the capital, and Mozart seems never to have visited Eisenstadt; but the cordiality of their relations and the mutual influence which they exercised upon one another are of the highest moment in the history of 18th-century music. "It was from Haydn that I first learned to write a quartet," said Mozart; it was from Mozart that Haydn learned the richer style and the fuller mastery of orchestral effect by which his later symphonies are distinguished.

In 1790 Prince Nicholas Esterházy died and the *Kapelle* was disbanded. Haydn, thus released from his official duties, forthwith accepted a commission from Salomon, the London concert-director, to write and conduct six symphonies for the concerts in the Hanover Square Rooms. He arrived in England at the beginning of 1792 and was welcomed with the greatest enthusiasm, receiving among other honours the degree of D Mus. from the university of Oxford. In June 1792 he returned home, and, breaking his journey at Bonn, was presented with a Cantata by Beethoven, then aged two-and-twenty, whom he invited to come to Vienna as his pupil. The lessons, which were not very successful, lasted for about a year, and were then interrupted by Haydn's second visit to England (January 1794 to July 1795), where he produced the last six of his "Salomon" symphonies. From 1795 onward he resided in the Mariabühl suburb of Vienna, and there wrote his last eight Masses, the last and finest of his chamber works, the Austrian national anthem (1797), the *Creation* (1799) and the *Seasons* (1801). His last choral composition which can be dated with any certainty was the Mass in C minor, written in 1802 for the name-day of Princess Esterházy. Thenceforward his health declined, and his closing years, surrounded by the love of friends and the esteem of all musicians, were spent almost wholly in retirement. On the 27th of March 1808 he was able to attend a performance of the *Creation*, given in his honour, but it was his last effort, and on the 31st of May 1809 he died, aged seventy-seven. Among the mourners who followed him to the grave were many French officers from Napoleon's army, which was then occupying Vienna.

Haydn's place in musical history is best determined by his instrumental compositions. His operas, for all their daintiness and melody, no longer hold the stage; the Masses in which he

"praised God with a cheerful heart" have been condemned by the severer decorum of our own day; of his oratorios the *Creation* alone survives. In all these his work belongs mainly to the style and idiom of a bygone generation: they are monuments, not landmarks, and their beauty and invention seem rather to close an epoch than to inaugurate its successor. Even the half pictorial suggestion, of which free use is made in the *Creation* and in the *Seasons*, is closer to the manner of Handel than to that of the 19th century: it is less the precursor of romance than the descendant of an earlier realism. But as the first great master of the quartet and the symphony his claim is incontestable. He began, half-consciously, by applying through the fuller medium the lessons of design which he had learned from C. P. E. Bach's sonatas; then the medium itself began to suggest wider horizons and new possibilities of treatment; his position at Eisenstadt enabled him to experiment without reserve; his genius, essentially symphonic in character, found its true outlet in the opportunities of pure musical structure. The quartets in particular exhibit a wider range and variety of structural invention than those of any other composer except Beethoven. Again it is here that we can most readily trace the important changes which he wrought in melodic idiom. Before his time instrumental music was chiefly written for the *Paradiesensaal*, and its melody often sacrificed vitality of idea to a ceremonial courtliness of phrase. Haydn broke through this convention by frankly introducing his native folk-music, and by writing many of his own tunes in the same direct, vigorous and simple style. The innovation was at first received with some disfavour; critics accustomed to polite formalism censured it as extravagant and undignified; but the freshness and beauty of its melody soon silenced all opposition, and did more than anything else throughout the 18th century to establish the principle of nationalism in musical art. The actual employment of Croatian folk-tunes may be illustrated from the string quartets Op. 17, No. 1; Op. 33, No. 3; Op. 50, No. 1; Op. 77, No. 1, and the Salomon Symphonies in D and E♭, while there is hardly an instrumental composition of Haydn's in which his own melodies do not show some traces of the same influence. His natural idiom in short was that of a heightened and ennobled folk-song, and one of the most remarkable evidences of his genius was the power with which he adapted all his perfection and symmetry of style to the requirements of popular speech. His music is in this way singularly expressive; its humour and pathos are not only absolutely sincere, but so outspoken that we cannot fail to catch their significance.

In the development of instrumental polyphony Haydn's work was almost as important as that of Mozart. Having at his disposal a band of picked virtuosi he could produce effects as different from the tentative experiments of C. P. E. Bach as these were from the orchestral platitudes of Reutter or Hasse. His symphony *Le Midi* (written in 1761) already shows a remarkable freedom and independence in the handling of orchestral forces, and further stages of advance were reached in the oratorio of *Tobias*, in the Paris and Salomon symphonies, and above all in the *Creation*, which turns to good account some of the debt which he owed to his younger contemporary. The importance of this lies not only in a greater richness of musical colour, but in the effect which it produced on the actual substance and texture of composition. The polyphony of Beethoven was unquestionably influenced by it and, even in his latest sonatas and quartets, may be regarded as its logical outcome.

The compositions of Haydn include 104 symphonies, 16 overtures, 76 quartets, 68 trios, 54 sonatas, 31 concertos and a large number of divertimentos, cassations and other instrumental pieces; 24 operas and dramatic pieces, 16 Masses, a *Stabat Mater*, interludes for the "Seven Words," 3 oratorios, 2 Te Deums and many smaller pieces for the church, over 40 songs, over 50 canons and arrangements of Scottish and Welsh national melodies.

His younger brother, JOHANN MICHAEL HAYDN (1737-1806), was also a chorister at St Stephen's, and shortly after leaving the choir-school was appointed *Kapellmeister* at Grosswardein (1755) and at Salzburg (1762). The latter office he held for forty-three years, during which time he wrote over 360 compositions

for the church and much instrumental music, which, though unequal, deserves more consideration than it has received. He was the intimate friend of Mozart, who had a high opinion of his genius, and the teacher of C. M. von Weber. His most important works were the *Missa hispanica*, which he exchanged for his diploma at Stockholm, a Mass in D minor, a Lauda Sion, a set of graduals, forty-two of which are reprinted in Diabelli's *Ecclesiasticon*, three symphonies (1785), and a string quintet in C major which has been erroneously attributed to Joseph Haydn. Another brother, JOHANN EVANGELIST HAYDN (1743-1805), gained some reputation as a tenor vocalist, and was for many years a member of Prince Esterhazy's *Kapelle*.

BIBLIOGRAPHY.—S. Mayr, *Brevi notizie storiche della vita e delle opere di Giuseppe Haydn* (1809); Griesinger, *Biographische Notizen über Joseph Haydn* (1810); Carpani, *Le Hayden* (1812 and 1823); Bombet (M. de Stendhal), *Vies de Haydn, de Mozart et de Métopastie* (Paris, 1834); Karajan, *Joseph Haydn in London* (1861); C. F. Pohl, *Mozart und Haydn in London* (1867); *Joseph Haydn* (vol. i. 1875, vol. ii. 1882: this, the standard biography, was left unfinished at Dr Pohl's death and needs a third volume to complete it); article on Haydn in Grove's *Dictionary of Music and Musicians*; Fr. S. Kuhač, *Josip Haydn i Hrvatske Narodne Pjesmice* (Joseph Haydn and the Croatian Folk-songs) (Agram, 1880); A. Niggli, *Joseph Haydn, sein Leben und Werke* (Basel, 1882); L. Nohl, *Biographie Haydns* (Leipzig, Reclam); P. D. Townsend; *Joseph Haydn* (London, 1884); Biography in H. Reimann's *Berühmte Musiker* (Berlin, 1898); J. C. Hadden, *Joseph Haydn* (Great Musicians series) (London, 1902). To these should be added the list of Haydn's symphonies printed in Alfred Wotquenne's *Catalogue de la Bibliothèque du Conservatoire Royal de Bruxelles*, vol. ii. (1902). (W. H. HA.)

HAYDON, BENJAMIN ROBERT (1786-1846), English historical painter and writer, was born at Plymouth on the 26th of January 1786. His mother was the daughter of the Rev. Benjamin Copley, rector of Dodbrook, Devon, whose son, General Sir Thomas Copley, signalized himself in the Russian service at the siege of Ismail. His father, a prosperous printer, stationer and publisher, was a man of literary taste, and was well known and esteemed amongst all classes in Plymouth. Haydon, an only son, at an early date gave evidence of his taste for study, which was carefully fostered and promoted by his mother. At the age of six he was placed in Plymouth grammar school, and at twelve in Plympton St Mary school. He completed his education in this institution, where Sir Joshua Reynolds also had acquired all the scholastic training he ever received. On the ceiling of the school-room was a sketch by Reynolds in burnt cork, which it used to be Haydon's delight to sit and contemplate. Whilst at school he had some thought of adopting the medical profession, but he was so shocked at the sight of an operation that he gave up the idea. A perusal of Albinus, however, inspired him with a love for anatomy; and Reynolds's discourses revived within him a smouldering taste for painting, which from childhood had been the absorbing idea of his mind.

Sanguine of success, full of energy and vigour, he started from the parental roof, on the 14th of May 1804, for London, and entered his name as a student of the Royal Academy. He began and prosecuted his studies with such unwaried ardour that Fuseli wondered when he ever found time to eat. At the age of twenty-one (1807) Haydon exhibited, for the first time, at the Royal Academy, "The Repose in Egypt," which was bought by Mr Thomas Hope the year after. This was a good start for the young artist, who shortly received a commission from Lord Mulgrave and an introduction to Sir George Beaumont. In 1809 he finished his well-known picture of "Dentatus," which, though it brought him a great increase of fame, involved him in a lifelong quarrel with the Royal Academy, whose committee had hung the picture in a small side-room instead of the great hall. In 1810 his difficulties began through the stoppage of an allowance of £500 a year he had received from his father. His disappointment was embittered by the controversies in which he now became involved with Sir George Beaumont, for whom he had painted his picture of "Macbeth," and Payne Knight, who had denied the beauties as well as the money value of the Elgin Marbles. "The Judgment of Solomon," his next pro-

duction, gained him £700, besides £500 voted to him by the directors of the British Institution, and the freedom of the borough of Plymouth. To recruit his health and escape for a time from the cares of London life, Haydon joined his intimate friend Wilkie in a trip to Paris; he studied at the Louvre; and on his return to England produced his "Christ's Entry into Jerusalem," which afterwards formed the nucleus of the American Gallery of Painting, erected by his cousin, John Haviland of Philadelphia. Whilst painting another large work, the "Resurrection of Lazarus," his pecuniary difficulties increased, and for the first time he was arrested but not imprisoned, the sheriff-officer taking his word for his appearance. Amidst all these harassing cares he married in October 1821 a beautiful young widow who had some children, Mrs Hyman, to whom he was devotedly attached.

In 1823 Haydon was lodged in the King's Bench, where he received consoling letters from the first men of the day. Whilst a prisoner he drew up a petition to parliament in favour of the appointment of "a committee to inquire into the state of encouragement of historical painting," which was presented by Brougham. He also, during a second imprisonment in 1827, produced the picture of the "Mock Election," the idea of which had been suggested by an incident that happened in the prison. The king (George IV.) gave him £500 for this work. Among Haydon's other pictures were—1829, "Euclis" and "Punch"; 1831, "Napoleon at St Helena," for Sir Robert Peel; "Xenophon, on his Retreat with the 'Ten Thousand,' first seeing the Sea"; and "Waiting for the *Times*," purchased by the marquis of Stafford; 1832, "Falstaff" and "Achilles playing the Lyre." In 1834 he completed the "Reform Banquet," for Lord Grey—this painting contained 197 portraits; in 1843, "Curtius Leaping into the Gulf," and "Uriel and Satan." There was also the "Meeting of the Anti-Slavery Society," energetically treated, now in the National Portrait Gallery. When the competition took place at Westminster Hall, Haydon sent two cartoons, "The Curse of Adam" and "Edward the Black Prince," but, with some unfairness, he was not allowed a prize for either. He then painted "The Banishment of Aristides," which was exhibited with other productions under the same roof where the American dwarf Tom Thumb was then making his début in London. The exhibition was unsuccessful; and the artist's difficulties increased to such an extent that, whilst employed on his last grand effort, "Alfred and the Trial by Jury," overcome by debt, disappointment and ingratitude, he wrote "Stretch me no longer on this rough world," and put an end to his existence with a pistol-shot, on the 22nd of June 1846, in the sixty-first year of his age. He left a widow and three children (various others had died), who, by the generosity of their father's friends, were rescued from their pecuniary difficulties and comfortably provided for; amongst the foremost of these friends were Sir Robert Peel, Count D'Orsay, Mr Justice Talfourd and Lord Carlisle.

Haydon began his first lecture on painting and design in 1835, and afterwards visited all the principal towns in England and Scotland. His delivery was energetic and imposing, his language powerful, flowing and apt, and replete with wit and humour; and to look at the lecturer, excited by his subject, one could scarcely fancy him a man overwhelmed with difficulties and anxieties. The height of Haydon's ambition was to behold the chief buildings of his country adorned with historical representations of her glory. He lived to see the acknowledgment of his principles by government in the establishment of schools of design, and the embellishment of the new houses of parliament; but in the competition of artists for the carrying out of this object, the commissioners (amongst whom was one of his former pupils) considered, or affected to consider, that he had failed. Haydon was well versed in all points of his profession; and his *Lectures*, which were published shortly after their delivery, showed that he was as bold a writer as painter. It may be mentioned in this connexion that he was the author of the long and elaborate article, "Painting," in the 7th edition of the *Encyclopaedia Britannica*.

To form a correct estimate of Haydon it is necessary to read his autobiography. This is one of the most natural books ever written, full of various and abundant power, and fascinating to the reader. The author seems to have daguerreotyped his feelings and sentiments without restraint as they rose in his mind, and his portrait stands in these volumes limned to the life by his own hand. His love for his art was both a passion and a principle. He found patrons difficult to manage; and, not having the tact to lead them gently, he tried to drive them fiercely. He failed, abused patrons and patronage, and intermingled talk of the noblest independence with acts not always dignified. He was self-willed to perversity, but his perseverance was such as is seldom associated with so much vehemence and passion. With a large fund of genuine self-reliance he combined a considerable measure of vanity. To the last he believed in his own powers and in the ultimate triumph of art. In taste he was deficient, at least as concerned himself. Hence the tone of self-assertion which he assumed in his advertisements, catalogues and other appeals to the public. He proclaimed himself the apostle and martyr of high art, and, not without some justice, he believed himself to have on that account a claim on the sympathy and support of the nation. It must be confessed that he often tested severely those whom he called his friends. Every reader of his autobiography will be struck at the frequency and fervour of the short prayers interspersed throughout the work. Haydon had an overwhelming sense of a personal, overruling and merciful providence, which influenced his relations with his family, and to some extent with the world. His conduct as a husband and father entitles him to the utmost sympathy. In art his powers and attainments were undoubtedly very great, although his actual performances mostly fall short of the faculty which was manifestly within him; his general range and force of mind were also most remarkable, and would have qualified him to shine in almost any path of intellectual exertion or of practical work. His eager and combative character was partly his enemy; but he had other enemies actuated by motives as unworthy as his own were always high-pitched and on abstract grounds laudable. Of his three great works—the "Solomon," the "Entry into Jerusalem" and the "Lazarus"—the second has generally been regarded as the finest. The "Solomon" is also a very admirable production, showing his executive power at its loftiest, and of itself enough to place Haydon at the head of British historical painting in his own time. The "Lazarus" (which belongs to the National Gallery, but is not now on view there) is a more unequal performance, and in various respects open to criticism and censure; yet the head of Lazarus is so majestic and impressive that, if its author had done nothing else, we must still pronounce him a potent pictorial genius.

The chief authorities for the life of Haydon are *Life of B. R. Haydon, from his Autobiography and Journals*, edited and compiled by Tom Taylor (3 vols., 1853); and *B. R. Haydon's Correspondence and Table Talk*, with a memoir by his son, F. W. Haydon (2 vols., 1876). (W. M. R.)

HAYES, RUTHERFORD BIRCHARD (1822-1893), nineteenth president of the United States, was born in Delaware, Ohio, on the 4th of October 1822. He received his first education in the common schools, graduated in 1842 at Kenyon College, Gambier, Ohio, and was a student at the law school of Harvard University from 1843 until his graduation in 1845. He was admitted to the bar in 1845, and practised law, first at Lower Sandusky (now Fremont), and then at Cincinnati, where he won a very respectable standing, and in 1858-1861 served as city solicitor. In politics he was at first an anti-slavery Whig and then from the time of its organization in 1854 until his death was a member of the Republican party. In December 1852 he married Lucy Ware Webb of Chillicothe, Ohio, who survived him. After the breaking out of the Civil War the governor of Ohio, on the 7th of June 1861, appointed him a major of a volunteer regiment, and in July he was sent to western Virginia for active service. He served throughout the war, distinguished himself particularly at South Mountain, Winchester, Fisher's Hill and Cedar Creek, and by successive promotions became a brigadier-general of volunteers and, by brevet, a major-general

of volunteers. While still in the field he was elected a member of the National House of Representatives, and took his seat in December 1865. He was re-elected in 1866, and supported the reconstruction measures advocated by his party. From 1868 to 1872 he was governor of Ohio. In 1873 he removed from Cincinnati to Fremont, his intention being to withdraw from public life; but in 1875 the Republican party in Ohio once more selected him as its candidate for the governorship. He accepted the nomination with great reluctance. The Democrats adopted a platform declaring in favour of indefinitely enlarging the volume of the irredeemable paper currency which the Civil War had left behind it. Hayes stoutly advocated the speediest practicable resumption of specie payments, and carried the election. The "sound-money campaign" in Ohio having attracted the attention of the whole country, Hayes was marked out as a candidate for the presidency, and he obtained the nomination of the Republican National Convention of 1876, his chief competitor being James G. Blaine. The candidate of the Democratic party, Samuel J. Tilden, by his reputation as a statesman and a reformer of uncommon ability, drew many Republican votes. An excited controversy having arisen about the result of the balloting in the states of South Carolina, Florida, Oregon and Louisiana, the two parties in Congress in order to allay a crisis dangerous to public peace agreed to pass an act referring all contested election returns to an extraordinary commission, called the "Electoral Commission" (*q.v.*), which decided each contest by eight against seven votes in favour of the Republican candidates. Hayes was accordingly on the 2nd of March 1877 declared duly elected.

During his administration President Hayes devoted his efforts mainly to civil service reform, resumption of specie payments and the pacification of the Southern States, recently in rebellion. In order to win the co-operation of the white people in the South in maintaining peace and order, he put himself in communication with their leaders. He then withdrew the Federal troops which since the Civil War had been stationed at the southern State capitals. An end was thus made of the "carpet-bag governments" conducted by Republican politicians from the North, some of which were very corrupt, and had been upheld mainly by the Federal forces. This policy found much favour with the people generally, but displeased many of the Republican politicians, because it loosened the hold of the Republican party upon the Southern States. Though it did not secure to the negroes sufficient protection in the exercise of their political rights, it did much to extinguish the animosities still existing between the two sections of the Union and to promote the material prosperity of the South. President Hayes endeavoured in vain to induce Congress to appropriate money for a Civil Service Commission; and whenever he made an effort to restrict the operation of the traditional "spoils system," he met the strenuous opposition of a majority of the most powerful politicians of his party. Nevertheless the system of competitive examinations for appointments was introduced in some of the great executive departments in Washington, and in the custom-house and the post-office in New York. Moreover, he ordered that "no officer should be required or permitted to take part in the management of political organizations, caucuses, conventions or election campaigns," and that "no assessment for political purposes on officers or subordinates should be allowed"; and he removed from their offices the heads of the post-office in St. Louis and of the custom-house in New York—influential party managers—on the ground that they had misused their official positions for partisan ends. In New York the three men removed were Chester A. Arthur, the collector; Alonzo B. Cornell, the naval officer of the Port; and George H. Sharpe, the surveyor of the customs. While these measures were of limited scope and effect, they served greatly to facilitate the more extensive reform of the civil service which subsequently took place, though at the same time they alienated a powerful faction of the Republican party in New York under the leadership of Roscoe Conkling. Although the resumption of specie payments had been provided for, to begin at a given

time by the Resumption Act of January 1873, opposition to it did not cease. A bill went through both Houses of Congress providing that a silver dollar should be coined of the weight of 412½ grains, to be full legal tender for all debts and dues, public and private, except where otherwise expressly stipulated in the contract. President Hayes returned this bill with his veto, but the veto was overruled in both Houses of Congress. Meanwhile, however, the preparations for the return to specie payments were continued by the Administration with unflinching constancy and on the 1st of January 1879 specie payments were resumed without difficulty. None of the evils predicted appeared. A marked revival of business and a period of general prosperity ensued. In his annual message of the 1st of December 1879 President Hayes urged the suspension of the silver coinage and also the withdrawal of the United States legal tender notes, but Congress failed to act upon the recommendation. His administration also did much to ameliorate the condition of the Indian tribes and to arrest the spoliation of the public forest lands.

Although President Hayes was not popular with the professional politicians of his own party, and was exposed to bitter attacks on the part of the Democratic opposition on account of the cloud which hung over his election, his conduct of public affairs gave much satisfaction to the people generally. In the presidential election of 1880 the Republican party carried the day after an unusually quiet canvass, a result largely due to popular contentment with the then existing state of public affairs. On the 4th of March 1881 President Hayes retired to his home at Fremont, Ohio. Various universities and colleges conferred honorary degrees upon him. His remaining years he devoted to active participation in philanthropic enterprises; thus he served as president of the National Prison Association and of the Board of Trustees chosen to administer the John F. Slater fund for the promotion of industrial education among the negroes of the South, and was a member, also, of the Board of Trustees of the Peabody Education fund for the promotion of education in the South. He died at Fremont, after a short illness, on the 17th of January 1893.

There is no adequate biography, but three "campaign lives" may be mentioned: *Life, Public Services and Select Speeches of Rutherford B. Hayes*, by James Quay Howard (Cincinnati, 1876); *Life of R. B. Hayes*, by William D. Howells (New York, 1876); and a *Life* by Russell H. Conwell (Boston, 1876). See also Paul L. Haworth, *The Hayes-Tilden Disputed Presidential Election of 1876* (Cleveland, O., 1906).

HAY FEVER, HAY ASTHMA, or SUMMER CATARRH, a catarrhal affection of the mucous membrane of the upper respiratory tract, due to the action of the pollen of certain grasses. It is often associated with asthmatic attacks. The disease affects certain families, and is hereditary in about one-third of the cases. It is more common among women than men, city than country dwellers, and the educated and highly nervous than the lower classes. It has no connexion with the coryzas that are produced in nervous people by the odour of cats, &c. The complaint has been investigated by Professor W. P. Dunbar of Hamburg, who has shown that it is due to the pollens of certain grasses (notably rye) and plants, and that the severity of the attack is directly proportional to the amount of pollen in the air. He has isolated an albuminoid poison which, when applied to the nose of a susceptible individual, causes an attack, while there is no result in the case of a normal person. By injecting the poison into animals, he has obtained an anti-toxin, which is capable of aborting an attack of hay fever. The symptoms are those commonly experienced in the case of a severe cold, consisting of headache, violent sneezing and watery discharge from the nostrils and eyes, together with a hard dry cough, and occasionally severe asthmatic paroxysms. The period of liability to infection naturally coincides with the pollen season.

The radical treatment is to avoid vegetation. Local treatment consisting of thorough destruction of the sensitive area of the mucous membrane of the nose often produces good results. There are various drugs, the best of which are cocaine and the extract of the suprarenal body, which, when applied to the nose,

are sometimes effectual; in practice, however, it is found that larger and larger doses are required, and that sooner or later they afford no relief. The same remarks apply to a number of patent specifics, of which the principal constituent is one of the above drugs. An additional and stronger objection to the use of cocaine is that a "habit" is often contracted, with the most disastrous results. Finally Dunbar's serum may be applied to the nose and eyes on rising, and on the slightest suggestion of irritation during the day; it will, in the large majority of cases, be found to be quite effectual.

HAYLEY, WILLIAM (1745-1820), English writer, the friend and biographer of William Cowper, was born at Chichester on the 9th of November 1745. He was sent to Eton in 1757, and to Trinity Hall, Cambridge, in 1763; his connexion with the Middle Temple, London, where he was admitted in 1766, was merely nominal. In 1767 he left Cambridge and went to live in London. Two years later he married Eliza, daughter of Thomas Ball, dean of Chichester. His private means enabled Hayley to live on his patrimonial estate at Earham, Sussex, and he retired there in 1774. He had already written many occasional poetical pieces, when in 1771 his tragedy, *The Afflicted Father*, was rejected by David Garrick. In the same year his translation of Pierre Corneille's *Rodogune* as *The Syrian Queen* was also declined by George Colman. Hayley won the fame he enjoyed amongst his contemporaries by his poetical *Essays and Epistles*; a *Poetical Epistle to an Eminent Painter* (1780), addressed to his friend George Romney, an *Essay on History* (1780), in three epistles, addressed to Edward Gibbon: *Essay on Epic Poetry* (1782) addressed to William Mason; *A Philosophical Essay on Old Maids* (1783); and *The Triumphs of Temper* (1781). The last-mentioned work was so popular as to run to twelve or fourteen editions; together with the *Triumphs of Music* (Chichester, 1804) it was ridiculed by Byron in *English Bards and Scotch Reviewers*. So great was Hayley's fame that on Thomas Warton's death in 1790 he was offered the laureateship, which he refused. In 1792, while writing the *Life of Milton* (1794), Hayley made Cowper's acquaintance. A warm friendship sprang up between the two which lasted till Cowper's death in 1800. Hayley indeed was mainly instrumental in getting Cowper his pension. In 1800 Hayley also lost his natural son, Thomas Alphonso Hayley, to whom he was devotedly attached. He had been a pupil of John Flaxman's, to whom Hayley's *Essay on Sculpture* (1800) is addressed. Flaxman introduced William Blake to Hayley, and after the latter had moved in 1800 to his "marine hermitage" at Felpham, Sussex, Blake settled near him for three years to engrave the illustrations for the *Life of Cowper*. This, Hayley's best known work, was published in 1803-1804 (Chichester) in 3 vols. In 1805 he published *Ballads founded on Anecdotes of Animals* (Chichester), with illustrations by Blake, and in 1809 *The Life of Romney*. For the last twelve years of his life Hayley received an allowance for writing his *Memoirs*. He died at Felpham on the 12th of November 1820. Hayley's first wife died in 1797; her mind had been seriously affected, and since 1780 they had been separated. He married in 1809 Mary Welford, but they also separated after three years. He left no children.

Hayley's Poetical Works were published in 3 vols. (1785); his *Poems and Plays* in 6 vols. (1788).

See *Memoirs . . . of William Hayley . . . and Memoirs of his son T. A. Hayley*, ed. John Johnson (2 vols., 1823) (containing many of Hayley's letters); an article on these memoirs by Robert Southey in the *Quarterly Review*, vol. xxxi., 1825; *William Blake*, by A. C. Swinburne (2nd ed., 1868, pp. 28 et seq.); *Life of William Blake*, by Alexander Gilchrist (vol. 1., 1880), with some of Blake's letters to Hayley; *The Correspondence of William Cowper*, arranged by Thomas Wright (vol. iv., 1904), containing many letters to Hayley.

HAYM, RUDOLF (1821-1901), German publicist and philosopher, was born at Grünberg, in Silesia, on the 5th of October 1821, and died at St Anton (Arlberg) on the 27th of August 1901. He studied philosophy and theology at Halle and Berlin, and lived at Halle during 1846 and 1847. He was a member of the National Assembly at Frankfort in 1848, and wrote an account of the proceedings from the standpoint of the Right Centre.

From 1851 he lectured in literature and philosophy at the university of Halle, and became professor in 1860. His writings are biographical and critical, devoted mainly to modern German philosophy and literature. In 1870 he published a masterly history of the Romantic school. He also wrote biographies of W. von Humboldt (1856), Hegel (1857), Schopenhauer (1864), Herder (1877-1885), Max Duncker (1890). In 1901 he published *Erinnerungen aus meinem Leben*.

HAYNAU, JULIUS JACOB (1786-1853), Austrian general, was the natural son of the landgrave—afterwards elector—of Hesse-Cassel, William IX. He entered the Austrian army as an infantry officer in 1801, and saw much service in the Napoleonic wars. He was wounded at Wagram, and distinguished during the operations in Italy in 1813 and 1814. Between 1815 and 1847 he rose to the rank of field marshal lieutenant. A violent temper, which he made no attempt to control or conceal, led him into trouble with his superiors. His hatred of revolutionary principles was fanatical. When the insurrectionary movements of 1848 broke out in Italy, his known zeal for the cause of legitimacy, as much as his reputation as an officer, marked him out for command. He fought with success in Italy, but was chiefly noted for the severity he showed in suppressing and punishing a rising in Brescia. It ought to be remembered that the mob of Brescia had massacred invalid Austrian soldiers in the hospital, a provocation which always leads to reprisals. In June 1849 Haynau was called to Vienna to command first an army of reserve, and then in the field against the Hungarians. His successes against the declining revolutionary cause were numerous and rapid. In Hungary, as in Italy, he was accused of brutality. It was, for instance, asserted that he caused women who showed any sympathy with the insurgents to be whipped. His ostentatious hatred of the revolutionary parties marked him out as the natural object for these accusations. On the restoration of peace he was appointed to high command in Hungary. His temper quickly led him into quarrels with the minister of war, and he resigned his command in 1850. He then travelled abroad. The refugees had spread his evil reputation. In London he was attacked and beaten by Messrs Barclay & Perkins' draymen when visiting the brewery, and he was saved from mob violence in Brussels with some difficulty. He died on the 14th of March 1853. On the 11th of October 1808 Haynau had married Thérèse von Weber, the daughter of Field Marshal Lieutenant Weber, who was slain at Aspern. She died, leaving one daughter, in 1850.

See R. v. Schönahls, *Biographie des K. K. Feldzeugmeisters Julius Freiherrn von Haynau* (Vienna, 1875).

HAYNE, ROBERT YOUNG (1791-1839), American political leader, born in St Paul's parish, Colleton district, South Carolina, on the 10th of November 1791. He studied law in the office of Langdon Cheves (1776-1857) in Charleston, S.C., and in November 1812 was admitted to the bar there, soon obtaining a large practice. For a short time during the War of 1812 against Great Britain, he was captain in the Third South Carolina Regiment. He was a member of the lower house of the state legislature from 1814 to 1818, serving as speaker in the latter year; was attorney-general of the state from 1818 to 1822, and in 1823 was elected, as a Democrat, to the United States Senate. Here he was conspicuous as an ardent free-trader and an uncompromising advocate of "States Rights," opposed the protectionist tariff bills of 1824 and 1828, and consistently upheld the doctrine that slavery was a domestic institution and should be dealt with only by the individual states. In one of his speeches opposing the sending by the United States of representatives to the Panama Congress, he said, "The moment the federal government shall make the unhallowed attempt to interfere with the domestic concerns of the states, those states will consider themselves driven from the Union." Hayne is best remembered, however, for his great debate with Daniel Webster (q.v.) in January 1830. The debate arose over the so-called "Foote's Resolution," introduced by Senator Samuel A. Foote (1780-1846) of Connecticut, calling for the restriction of the sale of public lands to those already in the market, but was con-

cerned primarily with the relation to one another and the respective powers of the federal government and the individual states, Hayne contending that the constitution was essentially a compact between the states, and the national government and the states, and that any state might, at will, nullify any federal law which it considered to be in contravention of that compact. He vigorously opposed the tariff of 1832, was a member of the South Carolina Nullification Convention of November 1832, and reported the ordinance of nullification passed by that body on the 24th of November. Resigning from the Senate, he was governor of the state from December 1832 to December 1834, and as such took a strong stand against President Jackson, though he was more conservative than many of the nullificationists in the state. He was intendant (mayor) of Charleston, S.C., from 1835 to 1837, and was president of the Louisville, Cincinnati & Charleston railway from 1837 to 1839. He died at Asheville, N.C., on the 24th of September 1839. His son, Paul Hamilton Hayne (1830-1886), was a poet of some distinction, and in 1878 published a life of his father.

See Theodore D. Jervey, *Robert Y. Hayne and his Times* (New York, 1909).

HAYTER, SIR GEORGE (1792-1871), English painter, was the son of a popular drawing-master and teacher of perspective who published a well-known introduction to perspective and other works. He was born in London, and in his early youth went to sea. He afterwards studied in the Royal Academy, became a miniature-painter, and was appointed in 1816 miniature-painter to the princess Charlotte. He passed some years in Italy, more especially in Rome, between 1816 and 1831, returned to London in the last-named year, resumed portrait-painting, now chiefly in oil-colour, executed many likenesses of the royal family, and attained such a reputation for finish and refinement in his work that he received the appointment of principal painter to Queen Victoria and teacher of drawing to the princesses. In 1842 he was knighted. He painted various works on a large scale of a public and semi-historical character, but essentially works of portraiture; such as "The Trial of Queen Caroline" (189 likenesses), "The Meeting of the First Reformed Parliament," now in the National Portrait Gallery, "Queen Victoria taking the Coronation Oath" (accounted his finest production), "The Marriage of the Queen," and the "Trial of Lord William Russell." The artistic merits of Hayter's works are not, however, such as to preserve to him with posterity an amount of *prestige* corresponding to that which court patronage procured him.

He is not to be confounded with a contemporary artist, John Hayter, who produced illustrations for the *Book of Beauty*, &c.

HAYTON (ՀԱՅՏՈՒՆ, ՀԵՏՐՈՒՆ), king of Little Armenia or Cilicia from 1224 to 1269, traveller in western and central Asia, Mongolia, &c., was the son of Constantine Rupen, and became heir to the throne of Lesser Armenia by his marriage with Isabella, daughter and only child of Leo II. After a reign of forty-five years he abdicated (1269) in favour of his son Leo III., became a monk and died in 1271. Before his accession he had been "constable," or head of the Armenian army, and "ballif" of the realm. Throughout his reign he followed the policy of friendship and alliance with the overwhelming power of the Mongols. In about 1248 he sent his brother Sempad, who was now constable in his place, on a mission to Kuyuk Khan, the supreme Mongol emperor. Sempad was well received and returned home in 1250, bringing letters from Kuyuk. After Mangu's accession in 1251, Batu (the most powerful of the Mongol princes and generals, and the conqueror—in name at least—of eastern Europe, now commanding on the line of the Volga) summoned Hayton to the court of the new grand khan. Carefully disguised, so as to pass safely through the Turkish states in the interior of eastern Asia Minor (where he was hated as an ally of the Mongols against Islam), Hayton made his way to Kars, the central Mongol camp in Great Armenia, where the famous general Bachu, or Baiju, commanded. Here he reported himself, and was permitted to remain some time in the Ararat region, at the foot of Mt. Alagos, near the metropolitan church of

Echmiadzin. Being joined by his suite, especially the clerical diplomatists Basil the Priest, and James the Abbot, Hayton next passed through eastern Caucasia, threading the pass of the Iron Gates of Derbent, and so reached the camp of Batu on the Volga, where he was cordially welcomed. Thence he set out (May 13th, 1254) on the "very long road beyond the Caspian Sea" to the residence of Mangu at or near Karakorum, south of Lake Baikal. After passing the Ural river, we only hear of his arrival at Or, probably the present Ili province, east of Balkhash, and of his reaching the Irtish, entering the Naiman country, and passing through "Karakhitai" (apparently the capital of the ruined Karakhitai empire is intended, a place perhaps situated on the Chu, mentioned out of its proper place in Hayton's record). On the 13th of September the travellers entered Mongolia, and on the 14th (?) of September were received by Mangu. Here the king remained till the 1st of November, when he left with diplomats, seals and letters of enfranchisement which promised great things for the Armenian state, church and people. His return journey was by very unusual and interesting routes—through the Urumtsi region, the basin of "the sea of milk," Lake Sairam, the valley of the Ili, the neighbourhood of Kulja, and so over mountains, which probably answer to certain outliers of the Alexander range, to Talas near the present Aulie Ata, midway between the Syr Daria and the Chu. Here he met and conferred with Hulagu Khan, Mangu's brother, the future conqueror of Bagdad: probably Hayton was expected to aid in the coming forward movement of the Mongol armies against the Moslem world. From Talas Hayton made a detour to the north-west to meet another Mongol prince, Sartach the son of Batu; after which he ascended the valley of the Syr Daria, crossed into Trans-Oxiana, visited Samarkand and Bokhara, and passed the Oxus apparently near Charjuj. By way of Merv and Sarakhs he then entered Khorasan and traversed north Persia, passing through Rai near Tehran, Kazvin and Tabriz, and so returning to the camp of Bachu in Armenia, now at Sisian near Lake Gokcha (July 1255). Thanks to his powerful friends, Hayton's journey was unusually rapid. Eight months after quitting Mangu's horde, he was back in Great Armenia. The narrative of this journey, which was written by a member of the king's suite, one Kirakos of Gandsak (the modern Elizavetpol), concludes with some interesting references to Buddhist tenets, to Chinese habits, to various monstrous races and to certain "women endowed with reason" dwelling "beyond Cathay." It also gives some notes, compounded of truth and legend, on the wild tribes and animals of the Gobi and adjoining regions.

The record drawn up by Kirakos Gandsaketsi was in Armenian. A MS. of his, dated 1616, was found in the Sanahin monastery in Georgia, and translated into Russian by Prince Argutinsky in the *Sibirsky Vvestnik* for 1822, pp. 69, &c. This Russian version was again translated into French by Klaproth in the *Nouveau Journal asiatique* for 1833 (vol. xii, pp. 273, &c.). Another French translation was made direct from the Armenian by M. Brosset in the *Mémoires de l'Académie des Sciences de St Pétersbourg* for 1870; a fresh Russian version of the original, by Professor Patkanov, appeared in 1874. See also E. Breitschneider, *Medieval Researches from Eastern Asiatic Sources*, i. 164-172 (London, 1888, "Trübner's Oriental" Series); C. R. Beazley, *Dawn of Modern Geography*, ii. 381-391 (1901). (C. R. B.)

HAYWARD, ABRAHAM (1801-1884), English man of letters, son of Joseph Hayward, of an old Wiltshire family, was born at Wilton, near Salisbury, on the 22nd of November 1801. After education at Blundell's school, Tiverton, he entered the Inner Temple in 1824, and was called to the bar in June 1832. He took part as a conservative in the discussions of the London Debating Society, where his opponents were J. A. Roebuck and John Stuart Mill. The editorship of the *Law Magazine*; or, *Quarterly Review of Jurisprudence*, which he held from 1829 to 1844, brought him into connexion with John Austin, G. Cornewall Lewis, and such foreign jurists as Savigny, whose tractate on contemporary legislation and jurisprudence he rendered into English. In 1833 he travelled abroad, and on his return printed privately a translation of Goethe's *Faust* into English prose (pronounced by Carlyle to be the best version

extant in his time). A second and revised edition was published after another visit to Germany in January 1834, in the course of which Hayward met Tieck, Chamisso, De La Motte Fouqué, Varnhagen von Ense and Madame Goethe. In 1878 he contributed the rather colourless volume on Goethe to Blackwood's *Foreign Classics*. A successful translation was in those days a first-rate credential for a reviewer, and Hayward began contributing to the *New Monthly*, the *Foreign Quarterly*, the *Quarterly Review* and the *Edinburgh Review*. His first successes in this new field were won in 1835-1836 by articles on Walker's "Original" and on "Gastronomy." The essays were reprinted to form one of his best volumes, *The Art of Dining*, in 1852. In February 1835 he was elected to the Athenæum Club under Rule II., and he remained for nearly fifty years one of its most conspicuous and most influential members. He was also a subscriber to the Carlton, but ceased to frequent it when he became a Peelite. At the Temple, Hayward, whose reputation was rapidly growing as a connoisseur not only of a bill of fare but also (as Swift would have said) of a bill of company, gave *recherche* dinners, at which ladies of rank and fashion appreciated the wit of Sydney Smith and Theodore Hook, the dignity of Lockhart and Lyndhurst and the oratory of Macaulay. At the Athenæum and in political society he to some extent succeeded to the position of Croker. He and Macaulay were commonly said to be the two best-read men in town. Hayward got up every important subject of discussion immediately it came into prominence, and concentrated his information in such a way that he habitually had the last word to say on a topic. When Rogers died, when *Vanity Fair* was published, when the *Greville Memoirs* was issued or a revolution occurred on the continent, Hayward, whose memory was as retentive as his power of accumulating documentary evidence was exhaustive, wrote an elaborate essay on the subject for the *Quarterly* or the *Edinburgh*. He followed up his paper by giving his acquaintances no rest until they either assimilated or undertook to combat his views. Political ladies first, and statesmen afterwards, came to recognize the advantage of obtaining Hayward's good opinion. In this way the "old reviewing hand" became an acknowledged link between society, letters and politics. As a professional man he was less successful; his promotion to be Q.C. in 1845 excited a storm of opposition, and, disgusted at not being elected a Bencher of his Inn in the usual course, Hayward virtually withdrew from legal practice. In February 1848 he became one of the chief leader-writers for the Peelite organ, the *Morning Chronicle*. The morbid activity of his memory, however, continued to make him many enemies. He alienated Disraeli by tracing a purple patch in his official eulogy of Wellington to a newspaper translation from Thiers's funeral panegyric on General St Cyr. His sharp tongue made an enemy of Roebuck, and he disgusted the friends of Mill by the stories he raked up for an obituary notice of the great economist (*The Times*, 10th May 1873). He broke with Henry Reeve in 1874 by a venomous review of the *Greville Memoirs*, in which Reeve was compared to the beggarly Scot deputed to let off the blunderbuss which Bolingbroke (Greville) had charged. His enemies prevented him from enjoying a well-selected *quasi-sinecure*, which both Palmerston and Aberdeen admitted to be his due. Samuel Warren attacked him (very unjustly, for Hayward was anything but a parasite) as Venom Tuft in *Ten Thousand a Year*; and Disraeli aimed at him partially in *Ste Barbe* (in *Endymion*), though the satire here was directed primarily against Thackeray. After his break with Reeve, Hayward devoted himself more exclusively to the *Quarterly*. His essays on Chesterfield and Selwyn were reprinted in 1854. Collective editions of his articles appeared in volume form in 1858, 1873 and 1874, and *Selected Essays* in two volumes, 1878. In his useful but far from flawless edition of the *Autobiography, Letters and Literary Remains of Mrs (Thrale) Pissot* (1861), he again appears as a supplementer and continuator of J. W. Croker. His *Eminent Statesmen and Writers* (1880) commemorates to a large extent personal friendships with such men as Dumas, Cavour and Thiers, whom he knew intimately. As a counsellor of great ladies and of politicians, to whom he

held forth with a sense of all-round responsibility surpassing that of a cabinet minister, Hayward retained his influence to the last years of his life. But he had little sympathy with modern ideas. He used to say that he had outlived every one that he could really look up to. He died, a bachelor, in his rooms at 8 St James's Street (a small museum of autograph portraits and reviewing trophies) on the 2nd of February 1884.

Two volumes of Hayward's *Correspondence* (edited by H. E. Carlisle) were published in 1886. In *Vanity Fair* (27th November 1875) he may be seen as he appeared in later life. (T. St.)

HAYWARD, SIR JOHN (c. 1560–1627), English historian, was born at or near Felixstowe, Suffolk, where he was educated, and afterwards proceeded to Pembroke College, Cambridge, where he took the degrees of B.A., M.A. and LL.D. In 1599 he published *The First Part of the Life and Reign of King Henry IV.* dedicated to Robert Devereux, earl of Essex. This was reprinted in 1642. Queen Elizabeth and her advisers disliked the tone of the book and its dedication, and the queen ordered Francis Bacon to search it for "places in it that might be drawn within case of treason." Bacon reported "for treason surely I find none; but for felony very many," explaining that many of the sentences were stolen from Tacitus; but nevertheless Hayward was put in prison, where he remained until about 1601. On the accession of James I. in 1603 he courted the new king's favour by publishing two pamphlets—"An Answer to the first part of a certain conference concerning succession," and "A Treatise of Union of England and Scotland." The former pamphlet, an argument in favour of the divine right of kings, was reprinted in 1683 as "The Right of Succession" by the friends of the duke of York during the struggle over the Exclusion Bill. In 1610 Hayward was appointed one of the historiographers of the college which James founded at Chelsea; in 1613 he published his *Lives of the Three Norman Kings of England*, written at the request of James's son, Prince Henry; in 1616 he became a member of the College of Advocates; and in 1619 he was knighted. He died in London on the 27th of June 1627. Among his manuscripts was found *The Life and Reign of King Edward VI.*, first published in 1630, and *Certain Yeres of Queen Elizabeth's Reign*, the beginning of which was printed in an edition of his *Edward VI.*, published in 1636, but which was first published in a complete form in 1840 for the Camden Society under the editorship of John Bruce, who prefixed an introduction on the life and writings of the author. Hayward was conscientious and diligent in obtaining information, and although his reasoning on questions of morality is often childish, his descriptions are generally graphic and vigorous. Notwithstanding his imprisonment under Elizabeth, his portrait of the qualities of the queen's mind and person is flattering rather than detractive. He also wrote several works of a devotional character.

HAYWOOD, ELIZA (c. 1693–1756), English writer, daughter of a London tradesman named Fowler, was born about 1693. She made an early and unhappy marriage with a man named Hayward, and her literary enemies circulated scandalous stories about her, possibly founded on her works rather than her real history. She appeared on the stage as early as 1715, and in 1721 she revised for Lincoln's Inn Fields *The Fair Captive*, by a Captain Hurst. Two other pieces followed, but Eliza Haywood made her mark as a follower of Mrs Manley in writing scandalous and voluminous novels. To *Memoirs of a certain Island adjacent to Utopia*, written by a celebrated author of that country. Now translated into English (1725), she appended a key in which the characters were explained by initials denoting living persons. The names are supplied to these initials in the copy in the British Museum. *The Secret History of the Present Intrigues of the Court of Caramania* (1727) was explained in a similar manner. The style of these productions is as extravagant as their matter. Pope attacked her in a coarse passage in *The Dunciad* (bk. ii. ll. 157 et seq.), which is aggravated by a note alluding to the "profligate licentiousness of those shameless scribblers (for the most part of that sex which ought least to be capable of such malice or impudence) who in libellous Memoirs and Novels reveal the faults or misfortunes of both sexes, to

the ruin of public fame, or disturbance of private happiness." Swift, writing to Lady Suffolk, says, "Mrs Haywood I have heard of as a stupid, infamous, scribbling woman, but have not seen any of her productions." She continued to be a prolific writer of novels until her death on the 25th of February 1756, but her later works are characterized by extreme propriety; though an anonymous story of *The Fortunate Foundlings* (1744), purporting to be an account of the children of Lord Charles Manners, is generally ascribed to her.

A collected edition of her novels, plays and poems appeared in 1724, and her *Secret Histories, Novels and Poems* in 1725. See also an article by S. L. Lee in the *Dictionary of National Biography*.

HAZARA, a race of Afghanistan. The Hazaras are of Mongolian origin, speak a dialect of Persian, and belong to the Shia sect of Mahomedans. They are of middle size but stoutly made, with small grey eyes, high cheek bones and smooth faces. They are descendants of military colonists introduced by Jenghiz Khan, who occupy all the highlands of the upper Helmund valley, spreading through the country between Kabul and Herat, as well as into a strip of territory on the frontier slopes of the Hindu Kush north of Kabul. In the western provinces they are known as the Chahar Aimak (Hazaras, Jamshidis, Taimanis and Ferozkhois), and in other districts they are distinguished by the name of the territory they occupy. They are pure Mongols, intermixing with no other races (chiefly for the reason that no other races will intermix with them), preserving their language and their Mongol characteristics uninfluenced by their surroundings, having absolutely displaced the former occupants of the Hazarajat and Ghor. They make good soldiers and excellent pioneers. The amir's companies of engineers are recruited from the Hazaras, and they form perhaps the most effective corps in his heterogeneous army. They are now recruited into the British service in India.

HAZARA, a district of British India, in the Peshawar division of the North-West Frontier Province, with an area of 3391 sq. m. It is bounded on the N. by the Black Mountain, the Swat country, Kohistan and Chilas; on the E. by the native state of Kashmir; on the S. by Rawalpindi district; and on the W. by the river Indus. On the creation of the North-West Frontier Province in 1901 the district was reconstituted, the Tahsil of Attock being transferred to Rawalpindi. The district forms a wedge of territory extending far into the heart of the outer Himalayas, and consisting of a long narrow valley, shut in on both sides by lofty mountains, whose peaks rise to a height of 17,000 ft. above sea level. Towards the centre of the district the vale of Kagan is bounded by mountain chains, which sweep southward still maintaining a general parallel direction, and send off spurs on every side which divide the country into numerous minor dales. The district is well watered by the tributaries of the Indus, the Kunhar, which flows through the Kagan Valley into the Jhelum, and many rivulets. Throughout the scenery is picturesque. To the north rise the distant peaks of the snow-clad ranges; midway, the central mountains stand clothed to their rounded summits with pines and other forest trees, while grass and brushwood spread a green cloak over the nearer hills, and cultivation covers every available slope. The chief frontier tribes on the border are the cis-Indus Swatis, Hassanzais, Akazais, Chagarzais, Pariari Syads, Madda Khels, Amazais and Umarzais. Within the district Pathans are not numerous.

The name Hazara possibly belonged originally to a Turki family which entered India with Timur in the 14th century, and subsequently settled in this remote region. During the prosperous period of the Mogul dynasty the population included a number of mixed tribes, which each began to assert its independence, so that the utmost anarchy prevailed until Hazara attracted the attention of the rising Sikh monarchy. Ranjit Singh first obtained a footing here in 1818, and, after eight years of constant aggression, became master of the whole country. During the minority of the young maharaja Dhuleep Singh, the Sikh kingdom fell into a state of complete disorganization; the people seized the opportunity for recovering their independence,

and rose in 1845 in rebellion. They stormed the Sikh forts, laid siege to Hariপুর, and drove the governor across the borders. After the first Sikh War it was proposed to transfer Hazara with Kashmir to Gulab Singh, but it remained under the Lahore government in charge of James Abbott, who pacified it in less than a year and held it single-handed throughout the troubles of the second Sikh War. It was also undisturbed during the Mutiny. The population in 1901 was 560,288, showing an increase of 8.52% in the decade. The headquarters are at Abbotabad; pop. (1901) 7764. Through the Kagan valley and over the Babusar pass at its head lies the most direct route from the Punjab to Chilas and Gilgit.

HAZARD (O. Fr. *hasard*, from Span. *azar*, unlucky throw at dice, misfortune, from Arab. *al*, and *zar*, dice), a game of dice (called Craps in America), once very popular in England and played for large stakes at the famous rooms of Crookford (St James's Street, London) and Almack (Pall Mall, London). The player or "caster" calls a "main" (that is, any number from five to nine inclusive). He then throws with two dice. If he "throws in," or "nicks," he wins the sum played for from the banker or "setter." Five is a nick to five, six and twelve are nicks to six, seven and eleven to seven, eight and twelve to eight and nine to nine. If the caster "throws out" by throwing aces, or deuce-ace (called crabs or craps), he loses. When the main is five or nine the caster throws out with 11 or 12; when the main is six or eight he throws out with 11; when the main is seven he throws out with 12. If the caster neither nicks nor throws out, the number thrown is his "chance," and he keeps on throwing till either the chance comes up, when he wins, or till the main comes up, when he loses. When a chance is thrown the "odds" for or against the chance are laid by the setter to the amount of the original stake. Seven is the best main for the caster to call, as it can be thrown in six different ways out of the thirty-six casts which are possible with dice. Supposing seven to be the main; then the caster wins if he throws 7 or 11; he loses if he throws crabs or 12. If he throws any other number, 4 for example, that is his chance. The odds against him are two to one, as 7 can be thrown in six ways, but 4 only in three; hence six to three, or two to one, are the correct odds, and if the original stake was £1, the setter now lays £2 to £1 in addition. It is useful to remember that 2 and 12 can be thrown in one way; 3 and 11 in two ways; 4 and 10 in three ways; 5 and 9 in four ways; 6 and 8 in five ways. The odds against the caster are thus given by Hoyle: If 7 is the main and 4 the chance, two to one; 6 and 4, five to three; 5 and 4, four to three; 7 and 9, three to two; 7 and 6, six to five; 7 and 5, three to two; 6 and 5, five to four; 8 and 5, five to four, &c.

HAZARIBAGH, a town and district of British India, in the Chota Nagpur division of Bengal. The town is well situated at an elevation of 2000 ft. Pop. (1901) 15,799. Hazaribagh has ceased to be a military cantonment since the European penitentiary was abolished. There are a central jail and a reformatory school. The Dublin University Mission maintains a First Arts college.

The DISTRICT comprises an area of 7021 sq. m. In 1901 the population was 1,177,961, showing an increase of 1% in the decade. The physical formation of Hazaribagh exhibits three distinct features: (1) a high central plateau occupying the western section, the surface of which is undulating and cultivated; (2) a lower and more extensive plateau stretching along the north and eastern portions; to the north, the land is well cultivated, while to the east the country is of a more varied character, the elevation is lower, and the character of a plateau is gradually lost; (3) the central valley of the Damodar river occupying the entire southern section. Indeed, although the characteristics of the district are rock, hill and wide-spreading jungle, fine patches of cultivation are met with in all parts, and the scenery is generally pleasing and often striking. The district forms a part of the chain of high land which extends across the continent of India, south of the Nerbudda on the west, and south of the Sonc river on the east. The most important river is the Damodar, with its many tributaries, which drains an area of 2480 sq. m.

The history of the district is involved in obscurity until 1755, about which time a certain Mukund Singh was chief of the country. In a few years he was superseded by Tej Singh, who had gained the assistance of the British. In 1780 Hazaribagh, along with the surrounding territory, passed under direct British rule.

The district contains an important coal-field at Giridih which supplies the East Indian railway. There are altogether six mines. There are also mica mines which are gaining in importance. Rice and oilseeds are the principal crops. Tea cultivation has been tried but does not flourish, and is almost extinct. The only railways are the branch of the East Indian to the coal-field at Giridih, where there is a technical school maintained by the railway company, and the newly-opened Gaya-Katrasgarh chord line; but the district is traversed by the Grand Trunk road. Parasnath hill is annually visited by large numbers of Jain worshippers.

HAZEBROUCK, a town of northern France, capital of an arrondissement in the department of Nord, on the canalized Bourre, 29 m. W.N.W. of Lille, on the Northern railway, between that town and St Omer. Pop. (1906), town, 8798; commune, 12,819. With the exception of the church of St Eloi, a building of the 16th century with a spire of fine open work 260 ft. high, and the hospice, occupying a convent built in the 16th and 17th centuries, there is little of architectural interest in the town. Hazebrouck is the seat of a sub prefect, and has a tribunal of first instance and a board of trade arbitration. It is the market for a fertile agricultural district, and has trade in live-stock, grain and hops. Cloth-weaving is the chief industry. Hazebrouck is an important junction, and railway employes form a large part of its population.

HAZEL (O. Eng. *hæsel*¹; cf. Ger. *Hasel*, Swed. and Dan. *hassel*, &c.; Fr. *noisetier*, *coudrier*), botanically *Corylus*, a genus of shrubs or low trees of the natural order Corylaceae. The common hazel, *Corylus Avellana* (fig. 1), occurs throughout Europe, in North Africa and in central and Russian Asia, except the northernmost parts. It is commonly found in hedges and coppices, and as an undergrowth in woods, and reaches a height of some 12 ft.; occasionally, as at



FIG. 1.—Hazel (*Corylus Avellana*).—1, Female catkin (enlarged); 2, Pair of fruits (nuts) each enclosed in its involucre (reduced).

According to Evelyn (*Sylva*, p. 35, 1664), hazels "above all affect cold, barren, dry, and sandy soils; also mountains, and even rockie ground produce them; but more plentifully if somewhat moist, dankish, and mossie." In Kent they flourish best in a calcareous soil. The bark of the older stems is of a bright brown, mottled with grey, that of the young twigs is ash-coloured, and glandular and hairy. The leaves are alternate, from 2 to 4 in. in length, downy below, roundish heart-shaped, pointed and shortly stalked. In the variety *C. purpurea*, the leaves, as also the pellicle of the kernel and the husk of the nut, are purple, and in *C. heterophylla* they are thickly clothed with hairs. In autumn the rich yellow tint acquired by the leaves of the hazel adds greatly to the beauty of landscapes. The flowers are monoecious, and appear in Great Britain in February and March, before the leaves. The cylindrical drooping yellow male catkins (fig. 2) are 1 to 2½ in. long, and occur 2 to 4 in a raceme; when in unusual numbers they may be terminal in position. The female flowers are small, sub-globose and sessile,

¹ It has been supposed that the origin is to be found in O. Eng. *has*, a behest, connected with *halan* = Ger. *heissen*, to give orders: the hazel-wand was the sceptre of authority of the shepherd chieftain (ρομφο λαδω) of olden times, see Grimm, *Gesch. d. deutsch. Sprache*, p. 1016, 1848. The root is *has*-, cf. Lat. *corulus*, *corylus*; and the original meaning is unknown.

resembling leaf-buds, and have protruding crimson stigmas; the minute inner bracts, by their enlargement, form the palmately lobed and cut involucre or husk of the nut. The ovary is not visible till nearly midsummer, and is not fully developed before autumn. The nuts have a length of from $\frac{1}{4}$ to $\frac{1}{2}$ in., and grow in clusters. Double nuts are the result of the equal development of the two carpels of the original flower, of which ordinarily one becomes abortive; fusion of two or more nuts is not uncommon. From the light-brown or brown colour of the nuts the terms *hazel* and *hazelly*, i.e. "in hue as hazel nuts" (Shakespeare, *Taming of the Shrew*, ii. 1), derive their significance.¹



FIG. 2.—Catkin of Hazel (*Corylus Avellana*), consisting of an axis covered with bracts in the form of scales, each of which covers a male flower, the stamens of which are seen projecting beyond the scale. The catkin falls off entire, separating from the branch by an articulation.

gatherer, who "with active vigour crushes down the tree" (Thomson's *Seasons*, "Autumn"), and otherwise damages it.

The filbert,² among the numerous varieties of *Corylus Avellana*, is extensively cultivated, especially in Kent, for the sake of its nuts, which are readily distinguished from cob-nuts by their ample involucre and greater length. It may be propagated by suckers and layers, by grafting and by sowing. Suckers afford the strongest and earliest-bearing plants. Grafted filberts are less liable than others to be encumbered by suckers at the root. By the Maidstone growers the best plants are considered to be obtained from layers. These become well rooted in about a twelvemonth, and then, after pruning, are bedded out in the nursery for two or three years. The filbert is economically grown on the borders of plantations or orchards, or in open spots in woods. It thrives most in a light loam with a dry subsoil; rich and, in particular, wet soils are unsuitable, conducing to the formation of too much wood. Plantations of filberts are made in autumn, in well-drained ground, and a space of about 10 ft. by 8 has to be allowed for each tree. In the third year after planting the trees may require root-pruning; in the fifth or sixth they should bear well. The nuts grow in greatest abundance on the extremities of second year's branches, where light and air have ready access. To obtain a good tree, the practice in Kent is to select a stout upright shoot 3 ft. in length; this is cut down to about 18 in. of which the lower 12 are kept free from outgrowth. The head is pruned to form six or eight strong offsets; and by judicious use of the knife, and by training, preferably on a hoop placed within them, these are caused to grow outwards and upwards to a height of about 6 ft. so as to form a bowl-like shape. Excessive luxuriance of the laterals may be combated by root-pruning, or by checking them early in the season, and again later, and by cutting back to a female blossom bud, or else spurring nearly down to the main branch in the following spring.

Filbert nuts required for keeping must be gathered only when quite ripe; they may then be preserved in dry sand, or, after drying, by packing with a sprinkling of salt in sound casks or new

¹ On the expression "hazel eyes," see *Notes and Queries*, 2nd ser. xii. 337, and 3rd ser. iii. 18, 39.

² For derivations of the word see Latham's *Johnson's Dictionary*.

flower-pots. Their different forms include the *Cosford*, which are thin-shelled and oblong; the *Downton*, or large square nut, having a lacinated husk; the white or Wrotham Park filbert; and the red hazel or filbert, the kernel of which has a red pellicle. The last two, on account of their elongated husk, have been distinguished as a species, under the name *Corylus tubulosa*. Like these, apparently, were the nuts of Abella, or Avella, in the Campania (cf. *Fr. avellana*, filbert), said by Pliny to have been originally designated "Pontic," from their introduction into Asia and Greece from Pontus (see *Nat. Hist.* xv. 24, xxiii. 78). Hazel-nuts, under the name of Barcelona or Spanish nuts, are largely exported from France and Portugal, and especially Tarragona and other places in Spain. They afford 60% of a colourless or pale-yellow, sweet-tasting, non-drying oil, which has a specific gravity of 0.92 nearly, becomes solid at -19° C. (Clocz), and consists approximately of carbon 77, and hydrogen and oxygen each 11.5%. Hazel nuts formed part of the food of the ancient lake-dwellers of Switzerland and other countries of Europe (see Keller, *Lake Dwellings*, trans. Lee, 2nd ed., 1878). By the Romans they were sometimes eaten roasted. Kaltenbach (*Pflanzenfauna*, pp. 631-638, 1874) enumerates ninety-eight insects which attack the hazel. Among these the beetle *Balaninus nucum*, the nut-weevil, seen on hazel and oak stems from the end of May till July, is highly destructive to the nuts. The female lays an egg in the unripe nut, on the kernel of which the larva subsists till September, when it bores its way through the shell, and enters the earth, to undergo transformation into a chrysalis in the ensuing spring. The leaves of the hazel are frequently found mined on the upper and under side respectively by the larvae of the moths *Lithocolletis coryli* and *L. Nicellii*. Squirrels and dormice are very destructive to the nut crop, as they not only take for present consumption but for a store for future supply. Parasitic on the roots of the hazel is found the curious leafless *Lathraea Squamaria* or toothwort.

The Hebrew word *luz*, translated "hazel" in the authorized version of the English Bible (Gen. xxx. 37), is believed to signify "almond" (see Kitto, *Cycl. of Bib. Lit.* ii. 869, and iii. 811, 1864). A belief in the efficacy of divining-rods of hazel for the discovery of concealed objects is probably of remote origin (cf. Hosea iv. 12). G. Agricola, in his treatise *Vom Bergwerck* (pp. xxx. xxxi., Basel, 1557), gives an account, accompanied by a woodcut, of their employment in searching for mineral veins. By certain persons, who for different metals used rods of various materials, rods of hazel, he says, were held serviceable simply for silver lodes, and by the skilled miner, who trusted to natural signs of mineral veins, they were regarded as of no avail at all. The virtue of the hazel wand was supposed to be dependent on its having two forks; these were to be grasped in the fists, with the fingers uppermost, but with moderate firmness only, lest the free motion of the opposite end downwards towards the looked-for object should be interfered with. According to Cornish tradition, the divining or dowling rod is guided to lodes by the pixies, the guardians of the treasures of the earth. By Vallemont, who wrote towards the end of the 17th century, the divining-rod of hazel, or "baguette divinatoire," is described as instrumental in the pursuit of criminals. The Jesuit Vanière, who flourished in the early part of the 18th century, in the *Prædium rusticum* (pp. 12, 13, new ed., Toulouse, 1742) amusingly relates the manner in which he exposed the chicanery of one who pretended by the aid of a hazel divining-rod to point out hidden water-courses and gold. The burning of hazel nuts for the magical investigation of the future is alluded to by John Gay in *Thursday, or the Spell*, and by Burns in *Hallowe'en*. The hazel is very frequently mentioned by the old French romance writers. *Corylus rostrata* and *C. americana* of North America have edible fruits like those of *C. Avellana*.

The witch hazel is quite a distinct plant, *Hamamelis virginica*, of the natural order Hamamelidæ, the astringent bark of which is used in medicine. It is a hardy deciduous shrub, native of North America, which bears a profusion of rich yellow flowers in autumn and wither when the plant is leafless.

HAZLETON, a city of Luzerne county, Pennsylvania, U.S.A., about 25 m. S. of Wilkes-Barré. Pop. (1890) 11,872; (1900) 14,250, of whom 2732 were foreign-born; (1910 census) 25,452. It is served by the Lehigh Valley, the Pennsylvania (for freight), and the Wilkes-Barré & Hazleton (electric) railways. The city is built on a broad tableland on Nescopeck or Buck Mountain, a spur of the Blue Mountains, about 1620 ft. above sea-level. It has a park and a number of handsome residences; and its agreeable climate and picturesque situation make it attractive as a summer resort. The city has a public library. Hazleton is near the centre of one of the richest coal regions (the Lehigh or "Eastern Middle Coal Field") of the state, and its principal industry is the mining and shipping of anthracite coal. It has silk mills, knitting mills, shirt factories, breweries, macaroni factories, lumber and planing mills, important iron works, a casket factory and a large electric power plant. The value of

the city's factory products increased from \$908,823 in 1900 to \$2,185,876 in 1905, or 118.8%, only three other cities in the state having a population of 8000 or more in 1900 showing a greater rate of increase. There is a state hospital here for the treatment of persons injured in mines. Hazleton was settled in 1820, was laid out in 1836, was incorporated as a borough in 1856 and received a city charter in 1891. The local coal industry dates from 1837.

HAZLITT, WILLIAM (1778-1830), British literary critic and essayist, was born on the 10th of April 1778 at Maidstone, where his father, William Hazlitt, was minister of a Unitarian congregation. The father took the side of the Americans in their struggle with the mother-country, and during a residence at Bandon, Co. Cork, interested himself in the welfare of some American prisoners at Kinsale. In 1783 he migrated with his family to America, but in the winter of 1786-1787 returned to England, and settled at Wem in Shropshire, where he ministered to a small congregation. There his son William went to school, till in 1793 he was sent to the Hackney theological college in the hope that he would become a dissenting minister. For this career, however, he had no inclination, and returned, probably in 1794, to Wem, where he led a desultory life until 1802, and then decided to become a portrait painter. His elder brother John was already established as a miniature painter in London. The monotony of life at Wem was broken in January 1798 by the visit of Samuel Taylor Coleridge to Shrewsbury, where young Hazlitt went to hear him preach. Coleridge encouraged William Hazlitt's interest in metaphysics, and in the spring of the next year Hazlitt visited Coleridge at Nether Stowey and made the acquaintance of William Wordsworth. The circumstances of this early intercourse with Coleridge are related with inimitable skill in a paper in Hazlitt's *Literary Remains* (1839). On visits to his brother in London he made many acquaintances, the most important being a friendship with Charles Lamb, said to have been founded on a remark of Lamb's interpolated in a discussion between Coleridge, Godwin and Holcroft, "Give me man as he is *not* to be." He also formed an acquaintance with John Stoddart, whose sister Sarah he married in 1808. In October 1802 he went to Paris to copy portraits in the Louvre, and spent four happy months in Paris. When he returned to London he undertook commissions for portraits, but soon found he was not likely to excel in his art; his last portrait, one of Charles Lamb as a Venetian senator (now in the National Portrait Gallery), was executed in 1805. In that year he published his first book, *An Essay on the Principles of Human Action: being an argument in favour of the Natural Disinterestedness of the Human Mind*, which had occupied him at intervals for six or seven years. It attracted little attention, but remained a favourite with its author. Other works belonging to this period are: *Free Thoughts on Public Affairs* (1806); *An Abridgment of the Light of Nature Revealed, by Abraham Tucker...* (1807); *The Eloquence of the British Senate...* (2 vols., 1807); *A Reply to Malthus, on his Essay on Population* (1807); *A New and Improved Grammar of the English Tongue...* (1810).

Hazlitt married in 1808. His domestic life was unhappy. His wife was an unromantic, business-like woman, while he himself was fitful and moody, and impatient of restraint. The dissolution of the ill-assorted union was nevertheless deferred for fourteen years, during which much of Hazlitt's best literary work had been produced. Mrs Hazlitt had inherited a small estate at Winterslow near Salisbury, and here the Hazlitts lived until 1812, when they removed to 19 York Street, Westminster, a house that was once Milton's. Hazlitt delivered in 1812 a course of lectures at the Russell Institution on the *Rise and Progress of Modern Philosophy*. He soon abandoned philosophy, however, to give his whole attention to journalism. He was parliamentary reporter and subsequently dramatic critic for the *Morning Chronicle*; he also contributed to the *Champion* and *The Times*; but his closest connexion was with the *Examiner*, owned by John and Leigh Hunt. In conjunction with Leigh Hunt he undertook the series of articles called *The Round Table*,

a collection of essays on literature, men and manners which were originally contributed to the *Examiner*. To this time belong his *View of the English Stage* (1818), and *Lectures on the English Poets* (1818), on the *English Comic Writers* (1819), and on the *Dramatic Literature of the Age of Elizabeth* (1821). By these works, together with his *Characters of Shakespeare's Plays* (1817), and his *Table Talk; or Original Essays on Men and Manners* (1821-1822), his reputation as a critic and essayist was established.

Next to Coleridge, Hazlitt was perhaps the most powerful exponent of the dawning perception that Shakespeare's art was no less marvellous than his genius; and Hazlitt's criticism did not, like Coleridge's, remain in the condition of a series of brilliant but fitful glimpses of insight, but was elaborated with steady care. His lectures on the Elizabethan dramatists performed a similar service for the earlier, sweeter and simpler among them, such as Dekker, till then unduly eclipsed by later writers like Massinger, better playwrights but worse poets. Treating of the contemporary drama, he successfully vindicated for Edmund Kean, whose genius he recognized from the first, the high place which he has retained as an actor, and his enthusiasm for Mrs Siddons knew no bounds. His criticisms on the English comic writers and men of letters in general are masterpieces of ingenious and felicitous exposition, though rarely, like Coleridge's, penetrating to the inmost core of the subject. Moreover, at the time when the lectures were written, Hazlitt's views, orthodox as they may seem now, were novel enough.

As an essayist Hazlitt is even more effective than as a critic. Being enabled to select his own subjects, he escapes dependence upon others either for his matter or his illustrations, and presents himself by turns as a metaphysician, a moralist, a humorist, a painter of manners and characteristics, but always, whatever his ostensible theme, deriving the essence of his commentary from himself. This combination of intense subjectivity with strict adherence to his subject is one of Hazlitt's most distinctive and creditable traits. Intellectual truthfulness is a passion with him. He steeps his topic in the hues of his own individuality, but never uses it as a means of self-display. The first reception of his admirable essays was by no means in accordance with their deserts. Hazlitt's political sympathies and antipathies were vehement, and he had taken the unfashionable side. *The Quarterly Review* attacked him with deliberate malignity, stopped the sale of his writings for a time and blighted his credit with publishers. Hazlitt retaliated by his *Letter to William Gifford* (1819), accusing the editor of deliberate misrepresentation. In downright abuse and hard-hitting, Hazlitt proved himself more than a match even for Gifford. By the writers in *Blackwood's Magazine* Hazlitt was also scurrilously treated.¹ He had become estranged from his early friends, the Lake poets, by what he uncharitably but not unnaturally regarded as their political apostasy; and he had no scruples about recording his often very unfavourable opinions of his contemporaries. He displayed, moreover, an exasperating facility in grounding his criticisms on facts that his victims were unable to deny. His inequalities of temper separated him for a time even from Leigh Hunt and Charles Lamb, and on the whole the period of his most brilliant literary success was that when he was most soured and broken. Domestic troubles supervened; he had gone to live in Southampton Buildings in September 1819, and his marriage, long little more than nominal, was dissolved in consequence of the infatuated passion he had conceived for his landlord's daughter, Sarah Walker, a most ordinary person in the eyes of every one else. It is impossible to regard Hazlitt as a responsible agent while he continued subject to this influence. His own record of the transaction, published by himself under the title of *Liber Amoris, or the New Pygmalion* (1823), is an unpleasant but remarkable psychological document. It consists of conversations between Hazlitt and Sarah Walker, drawn up in the spring of 1822, of a correspondence between Hazlitt and his friend P. G. Patmore between March and July, and an account of the rupture of his relations with Sarah. The business-like dissolution of his marriage under the law of Scotland is related with amazing

¹ For some quotations see Alexander Ireland's bibliography.

naïveté by the family biographer. Rid of his wife and cured of his mistress, he shortly afterwards astonished his friends by marrying a widow. "All I know," says his grandson, "is that Mrs Bridgewater became Mrs Hazlitt." They travelled on the continent for a year and then parted finally. Hazlitt's study of the Italian masters during this tour, described in a series of letters contributed to the *Morning Chronicle*, had a deep effect upon him, and perhaps conducted to that intimacy with the cynical old painter Northcote which, shortly after his return, engendered a curious but eminently readable volume of *The Conversations of James Northcote, R.A.* (1830). The respective shares of author and artist are not always easy to determine. During the recent agitations of his life he had been writing essays, collected in 1826 under the title of *The Plain Speaker: opinions on Books, Men and Things* (1826). *The Spirit of the Age; or Contemporary Portraits* (1825), a series of criticisms on the leading intellectual characters of the day, is in point of style perhaps the most splendid and copious of his compositions. It is eager and animated to impetuosity, though without any trace of carelessness or disorder. He now undertook a work which was to have crowned his literary reputation, but which can hardly be said to have even enhanced it—*The Life of Napoleon Buonaparte* (4 vols., 1828-1830). The undertaking was at best premature, and was inevitably disfigured by partiality to Napoleon as the representative of the popular cause, excusable in a Liberal politician writing in the days of the Holy Alliance. Owing to the failure of his publishers Hazlitt received no recompense for this laborious work. Pecuniary anxieties and disappointments may have contributed to hasten his death, which took place on the 18th of September 1830. Charles Lamb was with him to the last.

Hazlitt had many serious defects of temper. His consistency was gained at the expense of refusing to revise his early impressions and prejudices. His estimate of a man's work was too apt to be decided by sympathy or the reverse with his politics. For Scott, however, he had a great admiration, although they were far enough apart in politics. He was a compound of intellect and passion, and the refinement of his critical analysis is associated with vehement eloquence and glowing imagery. He was essentially a critic, a dissector and, as Bulwer justly remarks, a much better judge of men of thought than of men of action. The paradoxes with which his works abound never spring from affectation; they are in general the sallies of a mind so agile and ardent as to overrun its own goal. His style is perfectly natural, and yet admirably calculated for effect. His diction, always rich and masculine, seems to kindle as he proceeds; and when thoroughly animated by his subject, he advances with a succession of energetic, hard-hitting sentences, each carrying his argument a step further, like a champion dealing out blows as he presses upon the enemy. Although, however, his grasp upon his subject is strenuous, his insight into it is rarely profound. He can amply satisfy men of taste and culture; he cannot, like Coleridge or Burke, dissatisfy them with themselves by showing them how much they would have missed without him. He is a critic who exhibits, rather than reveals, the beauties of an author. But all shortcomings are forgotten in the genuineness and fervour of the writer's self-portraiture. The intensity of his personal convictions causes all he wrote to appear in a manner autobiographic. Other men have been said to speak like books, Hazlitt's books speak like men. To read his works in connexion with Leigh Hunt's and Charles Lamb's is to be introduced into one of the most attractive of English literary circles, and this alone will long preserve them from oblivion.

His son, WILLIAM HAZLITT (1811-1803), was born on the 26th of September 1811. The separation between his parents did not prevent him from being on affectionate terms with both of them. He early began to write for the *Morning Chronicle*, and in 1833 married Caroline Reynell. He was the author of many translations, chiefly from the French, and of some works on the law of bankruptcy. He was called to the bar at the Middle Temple in 1844, and became registrar in the court of

bankruptcy. He held this position for more than thirty years, retiring two years before his death, which took place at Addlestone, Surrey, on the 23rd of February 1893.

Hazlitt's grandson, WILLIAM CAREW HAZLITT, the bibliographer, was born on the 22nd of August 1834. He was educated at the Merchant Taylors' school and was called to the bar of the Inner Temple in 1861. Among his many publications may be noted his invaluable *Handbook to the Popular, Poetical and Dramatic Literature of Great Britain, from the Invention of Printing to the Restoration* (1867), supplemented in 1876, 1882, 1887 and 1889, a *General Index* by J. G. Gray appearing in 1893. He published further contributions to the subject in *Bibliographical Collections and Notes on Early English Literature made during the years 1893-1903* (1903), and a *Manual for the Collector and Amateur of Old English Plays* . . . (1892). He was the chief editor of the useful 1871 edition of Warton's *History of English Poetry*, and compiled the *Catalogue of the Huth Library* (1880).

The list of the first William Hazlitt's works also includes: *Political Essays, with Sketches of Public Characters* (1819); *Sketches of the Principal Picture Galleries in England* . . . (1824); *Characteristics; in the Manner of Rochefoucauld's Maxims* (1823); *Select Poets of Great Britain: to which are prefixed Critical Notices of each Author* (1825); *Notes of a Journey through France and Italy* . . . (1826); *The Life of Titian; with Anecdotes of the Distinguished Persons of his Time* (1830), nominally by James Northcote; an article on the "Fine Arts" contributed to the seventh edition of the *Encyclopædia Britannica*; and posthumous collections made by his son.

A comprehensive edition of *The Collected Works of William Hazlitt* (12 vols., 1902-1904) does not include the life of Napoleon. It contains an introduction by W. E. Henley, and was issued under the superintendence of A. R. Waller and Arnold Glover, and there are many modern reprints of isolated works. The most copious source of information respecting Hazlitt is the *Memoirs of William Hazlitt, with Portions of his Correspondence* (2 vols., 1867), by his grandson, W. C. Hazlitt, a medley rather than a memoir, yet full of interest. A slight but appropriate sketch had previously been prefixed by his son to his *Literary Remains* . . . (2 vols., 1836), accompanied by estimates of his intellectual character by Bulwer and by Talouard, who had been his fast friend. There is an excellent monograph on *William Hazlitt* (1902) by Mr Augustine Birrell, in the "English Men of Letters" series, and one in French by J. Donady (Paris, 1907), who also published a bibliography of his works. Valuable biographical particulars have been preserved in Barry Cornwall's memoirs of Lamb; in the *My Friends and Acquaintances* (1854) of Mr F. G. Fatmore, Hazlitt's most intimate associate in his later years; in Crabb Robinson's *Diary*; and in Lamb's correspondence. A full bibliographical list of his writings, with a collection of the most remarkable critical judgments upon them from all quarters, was prepared by Alexander Ireland (1868). Further information on the Hazlitt family is to be found in Mr W. C. Hazlitt's *Four Generations of a Literary Family* (2 vols., 1897). The chief interest of this desultory book is the considerable extracts from the diary of Margaret [Peggy] Hazlitt, which describes the Hazlitt experiences in America. See also "William Hazlitt" in Sir L. Stephen's *Hours in a Library* (ed. 1892, vol. ii.), and *Lamb and Hazlitt, further Letters and Records hitherto unpublished* (1906), by W. C. Hazlitt.

HEAD, SIR EDMUND WALKER, BART. (1805-1868), English colonial governor and writer on art, was the son of the Rev. Sir John Head, Bart., rector of Rayleigh, Essex. He was educated at Winchester school and Oriel College, Oxford, and taking his degree with first-class honours in classics, he became fellow of Merton College. On his father's death in 1838, he succeeded to the baronetcy as 8th baronet. His services as poor-law commissioner, to which post he was appointed in 1841 after five years as assistant-commissioner, procured for him in 1847 the office of lieutenant-governor of New Brunswick, whence he passed in 1854 to the governor-generalship of Canada, which he retained till 1861. The following year, having returned to England, Head was nominated a civil service commissioner. In 1857 he was sworn of the Privy Council, and in 1860 was decorated as K.C.B., while in the course of his career he received the degrees of D.C.L. at Oxford and LL.D. at Cambridge. He died in London on the 28th of January 1868, the baronetcy becoming extinct, as his only son had died in 1859.

Sir Edmund Head wrote the article "Painting" in the *Penny Cyclopædia: A Handbook of the Spanish and French Schools of Painting* (1845); *Shall and Will, or two Chapters on Future Auxiliary Verbs* (1856); and *Ballads and other Poems, Original and Translated* (1868). He also edited F. T. Kugler's *Handbook of Painting of the*

German, Flemish, Dutch, Spanish, and French Schools (1854) and the *Essays on the Administrations of Great Britain* (1864), written by his lifelong friend, Sir George Cornewall Lewis. His translation from the Icelandic of *Viga Glum's Saga* appeared in 1866.

HEAD, SIR FRANCIS BOND, BART. (1793-1875), English soldier, traveller and author, son of James Roper Head of the Hermitage, Higham, Kent, was born there on the 1st of January 1793. He was educated at Rochester grammar school and the Royal Military Academy, whence in 1811 he was commissioned to the Royal Engineers. He was for some years stationed in the Mediterranean, and he served in the campaign of 1815, being present at the battle of Waterloo. He went on half-pay in 1825, when he accepted the charge of an association formed to work the gold and silver mines of Rio de La Plata. In connexion with this enterprise he made several rapid journeys across the Pampas and among the Andes, his *Rough Notes* of which, published in 1826, and written in a clear and spirited style, obtained for him the name of "Galloping Head." On his return in 1827, he became involved in a controversy with the directors of his company, and in defence of his conduct he published *Reports of the La Plata Mining Association* (London, 1827). He was soon afterwards restored to the active list of the army as a major unattached, mainly owing to his efforts to introduce the South American lasso into the British service for auxiliary draught. In 1830 he published a life of Bruce, the African traveller, and in 1834 *Bubbles from the Brunns of Nassau, by an Old Man*. In 1835 he was knighted, and in the following year created a baronet. In 1835 he was appointed lieutenant-governor of Upper Canada, and in this capacity he had to deal with a political situation of great difficulty, being called upon in 1837 to suppress a serious insurrection. Shortly afterwards, in consequence of a dispute with the home government, he resigned his post and returned to England, via New York (see *Quarterly Review*, vols. 63-64). Thereafter he devoted himself to writing, chiefly for the *Quarterly Review*, and to hunting. He rode to hounds until he was seventy-five. In 1869 Sir Francis Head was made a privy councillor. He died on the 20th of July 1875, at Duppas Hall, Croydon.

Head was the author of a considerable number of works, chiefly of travel, written in a clever, amusing and graphic fashion, and displaying both acute observation and genial humour. His principal works, beside those mentioned above, and a narrative of his Canadian administration (1839), were *The Emigrant* (1846); *Highways and Dryways, the Britannia and Conway Tubular Bridges* (1849); *Stokers and Pokers, a sketch of the working of a railway line* (1849); *The Defenceless State of Great Britain* (1850); *A Faggot of French Sticks* (1852); *A Fortnight in Ireland* (1852); *Descriptive Essays* (1856); comments on Kinglake's *Crimean War* (1853); *The Horse and his Rider* (1860); *The Royal Engineer* (1870); and a sketch of the life of Sir John Burgoyne (1872).

His brother, SIR GEORGE HEAD (1782-1855), was educated at the Charterhouse. In 1808 he received an appointment in the commissariat of the British army in the Peninsula, where he was a witness of many exciting scenes and important battles, of which he gave an interesting account in "Memoirs of an Assistant Commissary-General" attached to the second volume of his *Home Tour*, published in 1837. In 1814 he was sent to America to take charge of the commissariat in a naval establishment on the Canadian lakes, and he subsequently held appointments at Halifax and Nova Scotia. Some of his Canadian experiences were narrated by him in *Forest Scenery and Incidents in the Wilds of North America* (1829). In 1831 he was knighted.

He published in 1835 *A Home Tour through the Manufacturing Districts of England*, and in 1837 a sequel to it, entitled *A Home Tour through various parts of the United Kingdom*. Both works are amusing and instructive, but his *Rome, a Tour of many Days*, published in 1849, is somewhat dull and tedious. He also translated *Historical Memoirs of Cardinal Pasca* (1850), and the *Metamorphoses of Apuleius* (1851).

HEAD (in O. Eng. *hēafod*), the word is common to Teutonic languages; cf. Dutch *hoofd*, Ger. *Haupt*, generally taken to be in origin connected with Lat. *caput*, Gr. *κεφαλή*), the upper portion of the body in man, consisting of the skull with its integuments and contents, &c., connected with the trunk by the neck (see ANATOMY, SKULL and BRAIN); also the anterior

or fore part of other animals. The word is used in a large number of transferred and figurative senses, generally with reference to the position of the head as the uppermost part, hence the leading, chief portion of anything.

HEAD-HUNTING, or **HEAD-SNAPPING**, as the Dutch call it, a custom once prevalent among all Malay races and surviving even to-day among the Dyaks (q.v.) of Borneo and elsewhere. Martin de Rada, provincial of the Augustinians, reported its existence in Luzon (Philippine Islands) as early as 1577. The practice is believed to have had its origin in religious motives, the worship of skulls being universal among the Malays. Severe repressive measures have led to its decrease. Among the Igorrotes all that remains is the dance, accompanied by singing, around the bare pole on which the head was formerly fixed. With the Ilongotes a bridegroom must bring his bride a number of heads, those of Christians being preferred. The chief examples of head-hunters are the Was, a hill-tribe on the north-eastern frontier of India, and the Nagas and Kukis of Assam.

See Bock, *Headhunters of Borneo* (1887); W. H. Furness, *Home Life of Borneo Head-hunters* (Philadelphia, 1902); T. C. Hodson, "Head-hunting in Assam," in *Folk-Lore*, xx. 2. 132.

HEALTH, a condition of physical soundness or well-being, in which an organism discharges its functions efficiently; also in a transferred sense a state of moral or intellectual well-being (see HYGIENE, THERAPEUTICS and PUBLIC HEALTH). "Health" represents the O. Eng. *hæth*, the condition or state of being *hæl*, safe or sound. This word took in northern dialects the form "hale," in southern or midland English *hole*, hence "whole," with the addition of an initial *w*, as in "whoop," and in the pronunciation of "one." "Hail," properly an exclamation of greeting, good health to you, hence, to greet, to call out to, is directly Scandinavian in origin, from Old Norwegian *heil*, cognate with the O. Eng. *hæl*, used also in this sense. "To heal" (O. Eng. *hælan*), to make in sound health, to cure, is also cognate.

Drinking of Healths.—The custom of drinking "health" to the living is most probably derived from the ancient religious rite of drinking to the gods and the dead. The Greeks and Romans at meals poured out libations to their gods, and at ceremonial banquets drank to them and to the dead. The Norsemen drank the "minni" of Thor, Odin and Freya, and of their kings at their funeral feasts. With the advent of Christianity the pagan custom survived among the Scandinavian and Teutonic peoples. Such festal formulae as "God's minne!" "A bowl to God in Heaven!" occur, and Christ, the Virgin and the Saints were invoked, instead of heathen gods and heroes. The Norse "minne" was at once love, memory and thought of the absent one, and it survived in medieval and later England in the "minnying" or "mynde" days, on which the memory of the dead was celebrated by services and feasting. Intimately associated with these quasi-sacrificial drinking customs must have ever been the drinking to the health of living men. The Greeks drank to one another and the Romans adopted the custom. The Goths pledged each other with the cry "Hails!" a greeting which had its counterpart in the Anglo-Saxon "wæs hæl" (see WASSAIL). Most modern drinking-usages have had their equivalents in classic times. Thus the Greek practice of drinking to the Nine Muses as three times survives to-day in England and elsewhere. The Roman gallants drank as many glasses to their mistresses as there were letters in each one's name. Thus Martial:

"Six cups to Naevia's health go quickly round,
And be with seven the fair Justina's crown'd."

The English drinking phrase—a "toast," to "toast" anyone—not older than the 17th century, had reference at first to this custom of drinking to the ladies. A toast was at first invariably a woman, and the origin of the phrase is curious. In Stuart days there appears to have been a time-honoured custom of putting a piece of toast in the wine-cup before drinking, from a fanciful notion that it gave the liquor a better flavour. In the *Taller* No. 24 the connexion between this sipnet of toast and the fair one pledged is explained as follows: "It happened that on a publick day" (speaking of Bath in Charles II.'s reign)

"a celebrated beauty of those times was in the cross bath, and one of the crowd of her admirers took a glass of the water in which the fair one stood, and drank her health to the company. There was in the place a gay fellow, half fuddled, who offered to jump in, and swore, though he liked not the liquor, he would have the toast. He was opposed in his resolution; yet this whim gave foundation to the present honour which is done to the lady we mention in our liquor, who has ever since been called a toast." Skeat adds (*Elym. Dict.*, 1908), "whether the story be true or not, it may be seen that a 'toast,' i.e. a health, easily took its name from being the usual accompaniment to liquor, especially in loving cups," &c.

Health drinking had by the beginning of the 17th century become a very ceremonious business in England. At Christmas 1623 the members of the Middle Temple, according to one of the Harleian MSS. quoted in *The Life of Sir Simonds D'Ewes*, drank to the health of the princess Elizabeth, who, with her husband the king of Bohemia, was then suffering great misfortunes, and stood up, one after the other, cup in one hand, sword in the other, and pledged her, swearing to die in her service. Toasts were often drunk solemnly on bended knees; according to one authority, Samuel Ward of Ipswich, in his *Woe to Drunkards* (1622), on bare knees. In 1668 at Sir George Carteret's at Cranbourne the health of the duke of York was drunk by all in turn, each on his knees, the king, who was a guest, doing the like. A Scotch custom, still surviving, was to drink a toast with one foot on the table and one on the chair. Healths, too, were drunk in a definite order. Braithwaite says: "These cups proceed either in order or out of order. In order when no person transgresseth or drinks out of course, but the cup goes round according to their manner of sitting: and this we call a health-cup, because in our wishing or confirming of any one's health, bare headed and standing, it is performed by all the company" (*Laws of Drinking*, 1617). Francis Douce's MSS. notes say: "It was the custom in Beaumont and Fletcher's time for the young gallants to stab themselves in the arms or elsewhere, in order to drink the health of their mistresses." Pepys, in his *Diary* for the 19th of June 1663, writes: "To the Rhenish wine house, where Mr Moore showed us the French manner when a health is drunk, to bow to him that drunk to you, and then apply yourself to him, whose lady's health is drunk, and then to the person that you drink to, which I never knew before; but it seems it is now the fashion." A Frenchman visiting England in Charles II.'s time speaks of the custom of drinking but half your cup, which is then filled up again and presented to him or her to whose health you drank. England's divided loyalty in the 18th century bequeathed to modern times a custom which possibly yet survives. At dinners to royalties, until the accession of Edward VII., finger-glasses were not placed on the table, because in early Georgian days those who were secretly Jacobites passed their wine-glasses over the finger-bowls before drinking the loyal toasts, in allusion to the royal exiles "over the water," thus salving their consciences. Lord Cockburn (1779-1854), in his *Memorials of his Time* (1856), states that in his day the drinking of toasts had become a perfect social tyranny; "every glass during dinner had to be dedicated to some one. It was thought sottish and rude to take wine without this, as if forsooth there was nobody present worth drinking with. I was present about 1803 when the late duke of Buccleuch took a glass of sherry by himself at the table of Charles Hope, then lord advocate, and this was noticed afterwards as a piece of direct contempt." In Germany to-day it is an insult to refuse to drink with any one; and at one time in the west of America a man took his life in his hands by declining to pledge another. All this is a survival of that very early and universal belief that drinking to one another was a proof of fair play, whether it be in a simple bargain or in matters of life and death. The ceremony surrounding the Loving Cup to-day is reminiscent of the perils of those times when every man's hand was raised against his fellow. This cup, known at the universities as the Grace Cup, was originated, says Miss Strickland in her *Lives of the Queens of Scotland*, by Margaret Atheling, wife of Malcolm Canmore, who, in order to induce the Scots to remain at table for

grace had a cup of the choicest wine handed round immediately after it had been said. The modern "loving cup" sometimes has a cover, and in this case each guest rises and bows to his immediate neighbour on the right, who, also rising, removes and holds the cover with his right hand while the other drinks; the little comedy is a survival of the days when he who drank was glad to have the assurance that the right or dagger hand of his neighbour was occupied in holding the lid of the chalice. When there is no cover it is a common custom for both the left- and the right-hand neighbour to rise while the loving cup is drunk, with the similar object of protecting the drinker from attack. The Stirrup Cup is probably the Roman *poculum boni genii*, the last glass drunk at the banquet to a general "good night."

See Chambers, *Book of Days*; Valpy, *History of Toasting* (1881); F. W. Hackwood, *Inns, Ales, and Drinking Customs* (London, 1909).

HEALY, GEORGE PETER ALEXANDER (1808-1894), American painter, was born in Boston, Massachusetts, on the 15th of July 1808. Going to Europe in 1835 Healy studied under Baron Gros in Paris and in Rome. He received a third-class medal in Paris in 1840, and one of the second class in 1855, when he exhibited his "Franklin urging the claims of the American Colonies before Louis XVI." Among his portraits of eminent men are those of Webster, Clay, Calhoun, Guyot, Seward, Louis Philippe, and the presidents of the United States from John Quincy Adams to Grant—this series being painted for the Corcoran Gallery, Washington. His large group, "Webster replying to Hayne," containing 150 portraits, is in Faneuil Hall, Boston, Mass. He was one of the most prolific and popular painters of his day. He died in Chicago, Illinois, on the 24th of June 1894.

HEANOR, an urban district in the Ilkeston parliamentary division of Derbyshire, England, 10 m. N.W. of Nottingham, on the Great Northern and Midland railways. Pop. (1901) 16,249. Large hosiery works employ many of the inhabitants, and collieries are worked in the parish. The urban district includes Codnor-cum-Loscoe. Shipley Hall, to the south of Heanor, is a mansion built on a hill, amidst fine gardens. The ruin of the ancient moated castle of Codnor stands, overlooking the vale of the Erewash, on land which was once Codnor Park, and is now the site of large ironworks.

HEARING (formed from the verb "to hear," O. Eng. *hyran*, *heran*, &c., a common Teutonic verb; cf. Ger. *hören*, Dutch *hooren*, &c.; the O. Teut. form is seen in Goth. *haurjan*; the initial *h* makes any connexion with "ear." Lat. *audire*, or Gr. *ἀκούω* very doubtful), in physiology, the function of the ear (*q.v.*), and the general term for the sense or special sensation, the cause of which is an excitation of the auditory nerves by the vibrations of sonorous bodies. The anatomy of the ear is described in the separate article on that organ. A description of sonorous vibrations is given in the article SOUND; here we shall consider the transmission of such vibrations from the external ear to the auditory nerve, and the physiological characters of auditory sensation.

1. *Transmission in External Ear*.—The external ear consists of the *pinna*, or auricle, and the *external auditory meatus*, or canal, at the bottom of which we find the *membrana tympani*, or drum head. In many animals the auricle is trumpet-shaped, and, being freely movable by muscles, serves to collect sonorous waves coming from various directions. The auricle of the human ear presents many irregularities of surface. If these irregularities are abolished by filling them up with a soft material such as wax or oil, leaving the entrance to the canal free, experiment shows that the intensity of sounds is weakened, and that there is more difficulty in judging of their direction. When waves of sound strike the auricle, they are partly reflected outwards, while the remainder, impinging at various angles, undergo a number of reflections so as to be directed into the auditory canal. Vibrations are transmitted along the auditory canal, partly by the air it contains and partly by its walls, to the *membrana tympani*. The absence of the auricle, as the result of accident or injury, does not cause diminution of hearing.

In the auditory canal waves of sound are reflected from side to side until they reach the membrana tympani. From the obliquity in position and peculiar curvature of this membrane, most of the waves strike it nearly perpendicularly, and in the most advantageous direction.

2. *Transmission in Middle Ear.*—The middle ear is a small cavity, the walls of which are rigid with the exception of the portions consisting of the membrana tympani, and the membrane of the round window and of the apparatus filling the oval window. This cavity communicates with the pharynx by the *Eustachian tube*, which forms an air-tube between the pharynx and the tympanum for the purpose of regulating pressure on the membrana tympani. During rest the tube is open, but it is closed during the act of deglutition. As this action is frequently taking place, not only when food or drink is introduced, but when saliva is swallowed, it is evident that the pressure of the air in the tympanum will be kept in a state of equilibrium with that of the external air on the outer surface of the membrana tympani, and that thus the membrana tympani will be rendered independent of variations of atmospheric pressure such as occur when we descend in a diving bell or ascend in a balloon. By a forcible expiration, the oral and nasal cavities being closed, air may be driven into the tympanum, while a forcible inspiration (Valsalva's experiment) will draw air from that cavity. In the first case, the membrana tympani will bulge outwards, in the second case inwards, and in both, from excessive stretching of the membrane, there will be partial deafness, especially for sounds of high pitch. Permanent occlusion of the tube is one of the most common causes of deafness.

The membrana tympani is capable of being set into vibration by a sound of any pitch included in the range of perceptible sounds. It responds exactly as to number of vibrations (pitch), intensity of vibrations (intensity), and complexity of vibration (quality or timbre). Consequently we can hear a sound of any given pitch, of a certain intensity, and in its own specific timbre or quality. Generally speaking, very high tones are heard more easily than low tones of the same intensity. As the membrana tympani is not only fixed by its margin to a ring or tube of bone, but is also adherent to the handle of the malleus, which follows its movements, its vibrations meet with considerable resistance. This diminishes the intensity of its vibrations, and prevents also the continued vibration of the membrane after an external pressure has ceased, so that a sound is not heard much longer than its physical cause lasts. The tension of the membrane may be affected (1) by differences of pressure on the two surfaces of the membrana tympani, as may occur during forcible expiration or inspiration, and (2) by muscular action, due to contraction of the *tensor tympani* muscle. This small muscle arises from the apex of the petrous temporal and the cartilage of the Eustachian tube, enters the tympanum at its anterior wall, and is inserted into the malleus near its root. The handle of the malleus is inserted between the layers of the membrana tympani, and, as the malleus and incus move round an axis passing through the neck of the malleus from before backwards, the action of the muscle is to pull the membrana tympani inwards towards the tympanic cavity in the form of a cone, the meridians of which are not straight but curved, with convexity outwards. When the muscle contracts, the handle of the malleus is drawn still farther inwards, and thus a greater tension of the tympanic membrane is produced. On relaxation of the muscle, the membrane returns to its position of equilibrium by its elasticity and by the elasticity of the chain of bones. This power of varying the tension of the membrane is an accommodating mechanism for receiving and transmitting sounds of different pitch. With different degrees of tension it will respond more readily to sounds of different pitch. Thus, when the membrane is tense, it will readily respond to high sounds, while relaxation will be the condition most adapted for low tones. In addition, increased tension of the membrane, by increasing the resistance, will diminish the intensity of vibrations. This is especially the case for sounds of low pitch.

The vibrations of the membrana tympani are transmitted to

the internal ear partly by the air which the middle ear or tympanum contains, and partly by the chain of bones, consisting of the malleus, incus and stapes. Of these, transmission by the chain of bones is by far the most important. In birds and in the amphibia, this chain is represented by a single rod-like ossicle, the *columella*, but in man the two membranes—the membrana tympani and the membrane filling the fenestra ovalis—are connected by a compound lever consisting of three bones, namely, the *malleus*, or hammer, inserted into the membrana tympani, the *incus*, or anvil, and the *stapes*, or stirrup, the base of which is attached to a membrane covering the oval window. It must also be noted that in the transmission of vibrations of the membrana tympani to the fluid in the labyrinth or internal ear, through the oval window, the chain of ossicles vibrates as a whole and acts efficiently, although its length may be only a fraction of the wave-length of the sound transmitted. The chain is a lever in which the handle of the malleus forms the long arm, the fulcrum is where the short process of the incus abuts against the wall of the tympanum, while the long process of the incus, carrying the stapes, forms the short arm. The mechanism is a lever of the second order. Measurements show that the ratio of the lengths of the two arms is as 1.5:1; the ratio of the resulting force at the stapes is therefore as 1:1.5; while the amplitudes of the movements at the tip of the handle of the malleus and the stapes is as 1.5:1. Hence, while there is a diminution in amplitude there is a gain in power, and thus the pressures are conveyed with great efficiency from the membrana tympani to the labyrinth, while the amplitude of the oscillation is diminished so as to be adapted to the small capacity of the labyrinth. As the drum-head is nearly twenty times greater in area than the membrane covering the oval window, with which the base of the stapes is connected, the energy of the movements of the membrana tympani is concentrated on an area twenty times smaller; hence the pressure is increased thirtyfold (1.5 × 20) when it acts at the base of the stapes. Experiments on the human ear have shown that the movement of greatest amplitude was at the tip of the handle of the malleus, 0.76 mm.; the movement of the tip of the long arm process of the incus was 0.21 mm.; while the greatest amplitude at the base of the stapes was only 0.14 mm. Other observations have shown the movements at the stapes to have a still smaller amplitude, varying from 0.001 to 0.032 mm. With tones of feeble intensity the movements must be almost infinitesimal. There may also be very minute transverse movements at the base of the stapes.

3. *Transmission in the Internal Ear.*—The internal ear is composed of the labyrinth, formed of the vestibule or central part, the semicircular canals, and the cochlea, each of which consists of an osseous and a membranous portion. The osseous labyrinth may be regarded as an osseous mould in the petrous portion of the temporal bone, lined by tessellated endothelium, and containing a small quantity of fluid called the *perilymph*. In this mould, partially surrounded by, and to some extent floating in, this fluid, there is the membranous labyrinth, in certain parts of which we find the terminal apparatus in connexion with the auditory nerve, immersed in another fluid called the *endolymph*. The membranous labyrinth consists of a vestibular portion formed by two small sac-like dilatations, called the *sacculle* and the *utricle*, the latter of which communicates with the semicircular canals by five openings. Each canal consists of a tube, bulging out at each extremity so as to form the so-called *ampulla*, in which, on a projecting ridge, called the *crista acustica*, there are cells bearing long *auditory hairs*, which are the peripheral end-organs of the vestibular branches of the auditory nerve. The cochlear division of the membranous labyrinth consists of the *ductus cochlearis*, a tube of triangular form fitting in between the two cavities in the cochlea, called the *scala vestibuli*, because it commences in the vestibule, and the *scala tympani*, because it ends in the tympanum, at the round window. These two scalae communicate at the apex of the cochlea. The roof of the ductus cochlearis is formed by a thin membrane called the *membrana of Reissner*, while its floor consists of the *basilar membrane*, on which we find the remarkable *organ of Corti*, which constitutes

while a complex tone, although occurring in the same duration of time, will cause the drum-head to move out and in in a much more complicated manner. The complex movement will be conveyed to the base of the stapes, thence to the vestibule, and thence to the cochlea, in which we find the ductus cochlearis containing the organ of Corti. It is to be noted also that the parts in the cochlea are so small as to constitute only a fraction of the wave-length of most tones audible to the human ear. Now it is evident that the cochlea must act either as a whole, all the nerve fibres being affected by any variations of pressure, or the nerve fibres may have a selective action, each fibre being excited by a wave of a definite period, or there may exist small vibratile bodies between the nerve filaments and the pressures sent into the organ. The last hypothesis gives the most rational explanation of the phenomena, and on it is founded a theory generally accepted and associated with the names of Thomas Young and Hermann Helmholtz. It may be shortly stated as follows:—

"(1) In the cochlea there are vibrators, tuned to frequencies within the limits of hearing, say from 30 to 40,000 or 50,000 viba. per second. (2) Each vibrator is capable of exciting its appropriate nerve filament or filaments, so that a nervous impulse, corresponding to the frequency of the vibrator, is transmitted to the brain—not corresponding necessarily, as regards the number of nervous impulses, but in such a way that when the impulses along a particular nerve filament reach the brain, a state of consciousness is aroused which does correspond with the number of the physical stimuli and with the period of the auditory vibrator. (3) The mass of each vibrator is such that it will be easily set in motion, and after the stimulus has ceased it will readily come to rest. (4) Damping arrangements exist in the ear, so as quickly to extinguish movements of the vibrators. (5) If a simple tone falls on the ear, there is a pendular movement of the base of the stapes, which will affect all the parts, causing them to move; but any part whose natural period is nearly the same as that of the sound will respond on the principle of sympathetic resonance, a particular nerve filament or nerve filaments will be affected, and a sensation of a tone of definite pitch will be experienced, thus accounting for discrimination in pitch. (6) Intensity or loudness will depend on the amplitude of movement of the vibrating body, and consequently on the intensity of nerve stimulation. (7) If a compound wave of pressure be communicated by the base of the stapes, it will be resolved into its constituents by the vibrators corresponding to tones existing in it, each picking out its appropriate portion of the wave, and thus irritating corresponding nerve filaments, so that nervous impulses are transmitted to the brain, where they are fused in such a way as to give rise to a sensation of a particular quality or character, but still so imperfectly fused that each constituent, by a strong effort of attention, may be specially recognized" (article "Ear," by M'Kendrick, Schäfer's *Text-Book*, loc. cit.).

The structure of the ductus cochlearis meets the demands of this theory, it is highly differentiated, and it can be shown that in it there are a sufficient number of elements to account for the delicate appreciation of pitch possessed by the human ear, and on the basis that the highly trained ear of a violinist can detect a difference of $\frac{1}{4}$ th of a semitone (M'Kendrick, *Trans. Roy. Soc. Ed.*, 1896, vol. xxviii, p. 780; also Schäfer's *Text-Book*, loc. cit.). Measurements of the cochlea have also shown such differentiation as to make it difficult to imagine that it can act as a whole. A much less complex organ might have served this purpose (M'Kendrick, *op. cit.*). The following table, given by Retzius (*Das Gehörorgan der Wirbeltiere*, Bd. ii, S. 356), shows differentiations in the cochlea of man, the cat and the rabbit, all of which no doubt hear tones, although in all probability they have very different powers of discrimination:—

	Man.	Cat.	Rabbit.
Ear-teeth	2,490	2,430	1,550
Holes in habenula for nerves	3,985	2,780	1,650
Holes of Corti's organ	5,590	4,700	2,800
Outer rods of Corti's organ	3,848	3,300	1,900
Inner hair-cells (one row)	3,487	2,600	1,600
Outer hair-cells (several rows)	11,750	9,900	6,100
Fibres in basilar membrane	33,750	15,700	10,500

7. *Dissonance*.—The theory can also be used to explain dissonance. When two tones sufficiently near in pitch are simultaneously sounded, beats are produced. If the beats are few in number they can be counted, because they give rise to separate and distinct sensations; but if they are numerous they blend so as to give roughness or dissonance to the interval. The roughness or dissonance is most disagreeable with about 33 beats falling on the ear per second. When two compound tones are sounded, say a minor third on a harmonium in the lower part of the keyboard, then we have beats not only between the primaries, but also between the upper partials of each of the primaries. The beating distance may, for tones of medium pitch, be fixed at about a m'nor-third, but this interval will expand for intervals on low tones and contract for intervals on high ones. This explains why the same interval in the lower part of the scale may give slow beats that are not disagreeable, while in the higher part it may cause harsh and unpleasant dissonance. The partials up to the seventh are beyond beating distance, but above this they

come close together. Consequently instruments (such as tongues, or reeds) that abound in upper partials cause an intolerable dissonance if one of the primaries is slightly out of tune. Some intervals are pleasant and satisfying when produced on instruments having few partials in their tones. These are concords. Others are less so, and they may give rise to an uncomfortable sensation. These are discords. In this way unison, $\frac{1}{2}$, minor third $\frac{3}{4}$, major third $\frac{4}{5}$, fourth $\frac{5}{6}$, fifth $\frac{6}{7}$, minor sixth $\frac{7}{8}$, major sixth $\frac{8}{9}$ and octave $\frac{9}{10}$, are all concords; while a second $\frac{2}{3}$, minor seventh $\frac{9}{10}$ and major seventh $\frac{10}{11}$, are discords. Helmholtz compares the sensation of dissonance to that of a flickering light on the eye. "Something similar I have found to be produced by simultaneously stimulating the skin, or margin of the lips, by bristles attached to tuning-forks giving forth beats. If the frequency of the forks is great, the sensation is that of a most disagreeable tickling. It may be that the instinctive effort at analysis of tones close in pitch causes the disagreeable sensation" (Schäfer's *Text-Book*, *op. cit.* p. 1187).

8. *Other Theories*.—In 1865 Rinty objected to the analysis theory, and urged that the cochlea acted as a whole (*Ztschr. f. rat. Med.*, Dritte Reihe, Bd. xxiv, Heft 1, S. 12-64). This view was revived by Voltolini (Virchow's *Archiv*, Bd. c, S. 27) some years later, and in 1886 it was urged by E. Rutherford (*Rep. Brit. Assoc. Ad. Sc.*, 1886), who compared the action of the cochlea to that of a telephone plate. According to this theory, all the hairs of the auditory cells vibrate to every note, and the hair-cells transform sound vibrations into nerve vibrations or impulses, similar in frequency, amplitude and character to the sound vibrations. There is no analysis in the peripheral organ. A. D. Waller, in 1891 (*Proc. Physiol. Soc.*, Jan. 20, 1891) suggested that the basilar membrane as a whole vibrates to every note, thus repeating the vibrations of the membrana tympani; and since the hair-cells move with the basilar membrane, they produce what may be called pressure patterns against the tectorial membranes, and filaments of the auditory nerve are stimulated by these pressures. Waller admits a certain degree of peripheral analysis, but he relegates ultimate analysis to the brain. These theories, dispensing with peripheral analysis, leave out of account the highly complex structure of the cochlea, or, in other words, they assign to that structure a comparatively simple function which could be performed by a simple membrane capable of vibrating. We find that the cochlea becomes more elaborate as we ascend the scale of animals, until in man, who possesses greater powers of analysis than any other being, the number of hair-cells, fibres of the basilar membrane and arches of Corti are all much increased in number (see Retzius's table, *supra*). The principle of sympathetic resonance appears, therefore, to offer the most likely solution of the problem. Hurst's view is that with each movement of the stapes a wave is generated which travels up the scala vestibuli, through the helicotrema into the scala tympani and down the latter to the fenestra rotunda. The wave, however, is not merely a movement of the basilar membrane, but an actual movement of fluid or a transmission of pressure. As the one wave ascends while the other descends, a pressure of the basilar membrane occurs at the point where they meet; this causes the basilar membrane to move towards the tectorial membrane, forcing this membrane suddenly against the apices of the hair-cells, thus irritating the nerves. The point at which the waves meet will depend on the time interval between the waves (Hurst, "A New Theory of Hearing," *Trans. Biol. Soc. Liverpool*, 1895, vol. ix, p. 321). More recently Max Mayer has advanced a theory somewhat similar. He supposes that with each movement of the stapes corresponding to a vibration, a wave travels up the scala vestibuli, pressing the basilar membrane downwards. As it meets with resistance in passing upwards, its amplitude therefore diminishes, and in this way the distance up the scala through which the wave progresses will be determined by its amplitude. The wave in its progress irritates a certain number of nerve terminations, consequently feeble tones will irritate only those nerve fibres that are near the fenestra ovalis, while stronger tones will pass farther up and irritate a larger number of nerve fibres the same number of times per unit of time. Pitch, according to this view, depends on the number of stimuli per second, while loudness depends on the number of nerve fibres irritated. Mayer also applies the theory to the explanation of the powers of the cochlea as an analyser, by supposing that with a compound tone these are at maxima and minima of stimulation. As the compound wave travels up the scala, portions of the wave corresponding to maxima and minima die away in consecutive series, until only a maximum and minimum are left; and, finally, as the wave travels farther, these also disappear. With each maximum and minimum different parts of the basilar membrane are affected, and affected a different number of times per second, according to the frequencies of the partials existing in the compound tone. Thus with a fifth, 2 : 3, there are three maxima and three minima; but the compound tone is resolved into three tones having vibration frequencies in the ratio of 3 : 2 : 1. According to Mayer, we actually hear when a fifth is sounded tones of the relationship of 3 : 2 : 1, the last (1) being the differential tone. He holds, also, that combinational tones are entirely subjective (Max Mayer, *Ztschr. f. Psych. und Phys. d. Sinnesorgane*, Leipzig, Bd. xvi, and xvii; also *Verhandl. d. physiolog. Gesellsch. zu Berlin*, Feb. 18, 1898, S. 49). Two fatal objections can be urged to these theories, namely, first, it is impossible to conceive of minute waves following each other in

rapid succession in the minute tubes forming the scalae—the length of the scala being only a very small part of the wave-length of the sound; and, secondly, neither theory takes into account the differentiation of structure found in the epithelium of the organ of Corti. Each push in and out of the base of the stapes must cause a movement of the fluid, or a pressure, in the scalae as a whole.

There are difficulties in the way of applying the resonance theory to the perception of noises. Noises have pitch, and also each noise has a special character; if so, if the noise is analysed into its constituents, why is it that it seems impossible to analyse a noise, or to perceive any musical element in it? Helmholtz assumed that a sound is noisy when the wave is irregular in rhythm, and he suggested that the crista and macula acustica, structures that exist not in the cochlea but in the vestibule, have to do with the perception of noise. These structures, however, are concerned rather in the sense of the perception of equilibrium than of sound (see EQUILIBRIUM).

9. Hitherto we have considered only the audition of a single sound, but it is possible also to have simultaneous auditive sensations, as in musical harmony. It is difficult to ascertain what is the limit beyond which distinct auditory sensations may be perceived. We have in listening to an orchestra a multiplicity of sensations which produces a total effect, while, at the same time, we can with ease single out and notice attentively the tones of one or two special instruments. Thus the pleasure of music may arise partly from listening to simultaneous, and partly from the effect of contrast or suggestion in passing through successive, auditory sensations.

The principles of harmony belong to the subject of music (see HARMONY), but it is necessary here briefly to refer to these from the physiological point of view. If two musical sounds reach the ear at the same moment, an agreeable or disagreeable sensation is experienced, which may be termed a *concord* or a *discord*, and it can be shown by experiment with the syren that this depends upon the vibrational numbers of the two tones. The octave (1:2), the twelfth (1:3), and double octave (1:4) are absolutely consonant sounds; the fifth (2:3) is said to be perfectly consonant; then follow, in the direction of dissonance, the fourth (3:4), major sixth (3:5), major third (4:5), minor sixth (5:8) and the minor third (5:6). Helmholtz has attempted to account for this by the application of his theory of beats.

Beats are observed when two sounds of nearly the same pitch are produced together, and the number of beats per second is equal to the difference of the number of vibrations of the two sounds. Beats give rise to a peculiarly disagreeable intermittent sensation. The maximum roughness of beats is attained by 33 per second; beyond 132 per second, the individual impulses are blended into one uniform auditory sensation. When two notes are sounded, say on a piano, not only may the first, fundamental or prime tones beat, but partial tones of each of the primaries may beat also, and as the difference of pitch of two simultaneous sounds augments, the number of beats, both of prime tones and of harmonics, augments also. The physiological effect of beats, though these may not be individually distinguishable, is to give roughness to the ear. If harmonics or partial tones of prime tones coincide, there are no beats; if they do not coincide, the beats produced will give a character of roughness to the interval. Thus in the octave and twelfth, all the partial tones of the acute sound coincide with the partial tones of the grave sound; in the fourth, major sixth and major third, only two pairs of the partial tones coincide, while in the minor sixth, minor third and minor seventh only one pair of the harmonics coincide.

It is possible by means of beats to measure the sensitiveness of the ear by determining the smallest difference in pitch that may give rise to a beat. In no part of the scale can a difference smaller than 0.2 vibration per second be distinguished. The sensitiveness varies with pitch. Thus at 120 vibs. per second 0.4 vib. per second, at 500 about 0.3 vib. per second, and at 1000, 0.5 vib. per second can be distinguished. This is a remarkable illustration of the sensitiveness of the ear. When tones of low pitch are produced that do not rapidly die away, as by sounding heavy tuning-forks, not only may the beats be perceived corresponding to the difference between the frequencies of the forks, but also other sets of beats. Thus, if the two tones have frequencies of 40 and 74, a two-order beat may be heard, one having a frequency of 34 and the other of 6, as $74 + 40 = 1 + a$ positive remainder of 34, and $74 + 40 = 2 - 6$, or 80-74, a negative remainder of 6. The lower beat is heard most distinctly when the number is less than half the frequency of the lower primary, and the upper when the number is greater. The beats we have been considering are produced when two notes are sounded slightly differing in frequency, or at all events their frequencies are not so great as those of two notes separated by a musical interval, such as an octave or a fifth. But Lord Kelvin has shown that beats may also be produced on slightly inharmonious musical intervals (*Proc. Roy. Soc. Ed.* 1878, vol. ix. p. 602). Thus, take two tuning-forks, $u_1 = 256$ and $u_2 = 512$; slightly flatten u_1 so as to make its frequency 510, and we hear, not a roughness corresponding to 254 beats, but a slow beat of 2 per second. The sensation also passes through a cycle, the beats now sounding loudly and fading away in intensity, again sounding loudly, and so on. One might suppose that the beat occurred between 510 (the frequency of u_2 flattened) and

512, the first partial of u_2 , namely u_1 , but this is not so, as the beat is most audible when u_2 is sounded feebly. In a similar way, beats may be produced on the approximate harmonics 2, 3, 3:4, 4:5, 5:6, 6:7, 7:8, 1:3, 3:5, and beats may even be produced on the major chord 4:5:6 by sounding u_1 , u_2 , u_3 , with u_2 or u_3 slightly flattened, when a peculiar beat will be heard as if a wheel were being turned against a surface, one small part of which was rougher than the rest." These beats on imperfect harmonics appear to indicate that the ear does distinguish between an increase of pressure on the drum-head and a diminution, or between a push and a pull, or, in other words, that it is affected by phase. This was denied by Helmholtz.

10. *Beat Tones*.—Considerable difference of opinion exists as to whether beats can blend so as to give a sensation of tone; but R. König, by using pure tones of high pitch, has settled the question. These tones were produced by large tuning-forks. Thus $u_1 = 2048$ and $u_2 = 2304$. Then the beat tone is $u_1 + u_2 = 256$ (2304-2048). If we strike the two forks, u_1 sounds as a grave or lower beat tone. Again, $u_1 = 2048$ and $u_2 = 3840$. Then (3048)-3840 = 256, a negative remainder, u_2 , as before, and when both forks are sounded u_1 will be heard. Again, $u_1 = 2048$ and $u_2 = 3072$, and 3072-2048 = 1024, or u_1 , which will be distinctly heard when u_1 and u_2 are sounded (König, *Quelques expériences d'acoustique*, Paris, 1882, p. 87).

11. *Combination Tones*.—Frequently, when two tones are sounded, not only do we hear the compound sound, from which we can pick out the constituent tones, but we may hear other tones, one of which is lower in pitch than the lowest primary, and the other is higher in pitch than the higher primary. These, known as combination tones, are of two classes: *differential tones*, in which the frequency is the difference of the frequencies of the generating tones, and *summational tones*, having a frequency which is the sum of the frequencies of the tones producing them. Differential tones, first noticed by Sorge about 1740, are easily heard. Thus an interval of a fifth, 2:3, gives a differential tone 1, that is, an octave below 2; a fourth, 3:4, gives 1, a twelfth below 3; a major third, 4:5, gives 1, two octaves below 4; a minor third, 5:6, gives 1, two octaves and a major third below 5; a major sixth, 3:5, gives 2, that is, a fifth below 3; and a minor sixth, 5:8, gives 3, that is, a major sixth below 5. Summational tones, first noticed by Helmholtz, are so difficult to hear that much controversy has taken place as to their very existence. Some have contended that they are produced by beats. It appears to be proved physically that they may exist in the air outside of the ear. Further differential tones may be generated in the middle ear. Helmholtz also demonstrated their independent existence, and he states that "whenever the vibrations of the air or of other elastic bodies, which are set in motion at the same time by two generating simple tones, are so powerful that they can no longer be considered infinitely small, mathematical theory shows that vibrations of the air must arise which have the same vibrational numbers as the combination tones" (Helmholtz, *Sensations of Tone*, p. 235). The importance of these combination tones in the theory of hearing is obvious. If the ear can only analyse compound waves into simple pendular vibrations of a certain order (simple multiples of the prime tone), how can it detect combination tones, which do not belong to that order? Again, if such tones are purely subjective and only exist in the mind of the listener, the fact would be fatal to the resonance theory. There can be no doubt, however, that the ear, in dealing with them, vibrates in some part of its mechanism with each generator, while it also is affected by the combination tone itself, according to its frequency.

12. Hearing with two ears does not appear materially to influence auditive sensation, but probably the two organs are enabled, not only to correct each other's errors, but also to aid us in determining the locality in which a sound originates. It is asserted by G. T. Fechner that one ear may perceive the same tone at a slightly higher pitch than the other, but this may probably be due to some slight pathological condition in one ear. If two tones, produced by two tuning-forks, of equal pitch, are produced one near each ear, there is a uniform single sensation; if one of the tuning-forks be made to revolve round its axis in such a way that its tone increases and diminishes in intensity, neither fork is heard continuously, but both sound alternately, the fixed one being only audible when the revolving one is not. It is difficult to decide whether excitations of corresponding elements in the two ears can be distinguished from each other. It is probable that the resulting sensations may be distinguished, provided one of the generating tones differs from the other in intensity or quality, although it may be the same in pitch. Our judgment as to the direction of sounds is formed mainly from the different degrees of intensity with which they are heard by two ears. Lord Rayleigh states that diffraction of the sound-waves will occur as they pass round the head to the ear farthest from the source of sound; thus partial tones will reach the two ears with different intensities, and thus quality of tone may be affected (*Trans. Music. Soc.*, London, 1876). Silvanus P. Thompson advocates a similar view, and he shows that the direction of a complex tone can be more accurately determined than the direction of a simple tone, especially if it be of low pitch (*Phil. Mag.*, 1882). (J. C. M.)

HEARN, LAFCADIO (1850-1904), author of books about Japan, was born on the 27th of June 1850 in Leucadia (pronounced Lefcadia, whence his name, which was one adopted by himself), one of the Greek Ionian Islands. He was the son of Surgeon-major Charles Hearn, of King's County, Ireland, who, during the English occupation of the Ionian Islands, was stationed there, and who married a Greek wife. Artistic and rather bohemian tastes were in Lafcadio Hearn's blood. His father's brother Richard was at one time a well-known member of the Barbizon set of artists, though he made no mark as a painter through his lack of energy. Young Hearn had rather a casual education, but was for a time (1865) at Ushaw Roman Catholic College, Durham. The religious faith in which he was brought up was, however, soon lost; and at nineteen, being thrown on his own resources, he went to America and at first picked up a living in the lower grades of newspaper work. The details are obscure, but he continued to occupy himself with journalism and with out-of-the-way observation and reading, and meanwhile his erratic, romantic and rather morbid idiosyncrasies developed. He was for some time in New Orleans, writing for the *Times Democrat*, and was sent by that paper for two years as correspondent to the West Indies, where he gathered material for his *Two Years in the French West Indies* (1890). At last, in 1891, he went to Japan with a commission as a newspaper correspondent, which was quickly broken off. But here he found his true sphere. The list of his books on Japanese subjects tells its own tale: *Glimpses of Unfamiliar Japan* (1894); *Out of the East* (1895); *Kokoro* (1896); *Gleanings in Buddha Fields* (1897); *Exotics and Retrospections* (1898); *In Ghostly Japan* (1899); *Shadowings* (1900); *A Japanese Miscellany* (1901); *Koto* (1902); *Japanese Fairy Tales and Kwaidan* (1903), and (published just after his death) *Japan, an Attempt at Interpretation* (1904), a study full of knowledge and insight. He became a teacher of English at the University of Tokyo, and soon fell completely under the spell of Japanese ideas. He married a Japanese wife, became a naturalized Japanese under the name of Yakumo Koizumi, and adopted the Buddhist religion. For the last two years of his life (he died on the 26th of September 1904) his health was failing, and he was deprived of his lectureship at the University. But he had gradually become known to the world at large by the originality, power and literary charm of his writings. This wayward bohemian genius, who had seen life in so many climes, and turned from Roman Catholic to atheist and then to Buddhist, was curiously qualified, among all those who were "interpreting" the new and the old Japan to the Western world, to see it with unfettered understanding, and to express its life and thought with most intimate and most artistic sincerity. Lafcadio Hearn's books were indeed unique for their day in the literature about Japan, in their combination of real knowledge with a literary art which is often exquisite.

See Elizabeth Bisland, *The Life and Letters of Lafcadio Hearn* (2 vols., 1906); G. M. Gould, *Concerning Lafcadio Hearn* (1908).

HEARNE, SAMUEL (1745-1792), English explorer, was born in London. In 1756 he entered the navy, and was some time with Lord Hood; at the end of the Seven Years' War (1763) he took service with the Hudson's Bay Company. In 1768 he examined portions of the Hudson's Bay coasts with a view to improving the cod fishery, and in 1769-1772 he was employed in north-western discovery, searching especially for certain copper mines described by Indians. His first attempt (from the 6th of November 1769) failed through the desertion of his Indians, his second (from the 23rd of February 1770) through the breaking of his quadrant; but in his third (December 1770 to June 1772) he was successful, not only discovering the copper of the Coppermine river basin, but tracing this river to the Arctic Ocean. He reappeared at Fort Prince of Wales on the 30th of June 1772. Becoming governor of this fort in 1775, he was taken prisoner by the French under La Pérouse in 1782. He returned to England in 1787 and died there in 1792.

See his posthumous *Journey from Prince of Wales Fort in Hudson's Bay to the Northern Ocean* (London, 1795).

HEARNE, THOMAS (1678-1735), English antiquary, was born in July 1678 at Littlefield Green in the parish of White Waltham, Berkshire. Having received his early education from his father, George Hearne, the parish clerk, he showed such taste for study that a wealthy neighbour, Francis Cherry of Shottesbrooke (c. 1665-1713), a celebrated nonjuror, interested himself in the boy, and sent him to the school at Bray "on purpose to learn the Latin tongue." Soon Cherry took him into his own house, and his education was continued at Bray until Easter 1696, when he matriculated at St Edmund Hall, Oxford. At the university he attracted the attention of Dr John Mill (1645-1707), the principal of St Edmund Hall, who employed him to compare manuscripts and in other ways. Having taken the degree of B.A. in 1699 he was made assistant keeper of the Bodleian Library, where he worked on the catalogue of books, and in 1712 he was appointed second keeper. In 1715 Hearne was elected archtypographer and esquire bedell in civil law in the university, but objection having been made to his holding this office together with that of second librarian, he resigned it in the same year. As a nonjuror he refused to take the oaths of allegiance to King George I., and early in 1716 he was deprived of his librarianship. However he continued to reside in Oxford, and occupied himself in editing the English chroniclers. Having refused several important academical positions, including the librarianship of the Bodleian and the Camden professorship of ancient history, rather than take the oaths, he died on the 10th of June 1735.

Hearne's most important work was done as editor of many of the English chroniclers, and until the appearance of the "Rolls" series his editions were in many cases the only ones extant. Very carefully prepared, they were, and indeed are still, of the greatest value to historical students. Perhaps the most important of a long list are: Benedict of Peterborough's (*Benedictus Abbas De vita et gestis Henrici II. et Ricardi I.* (1735); John of Fordun's *Scotichronicon* (1722); the monk of Evesham's *Historia vite et regni Ricardi II.* (1729); Robert Mannyng's translation of Peter Langtoft's *Chronicle* (1725); the work of Thomas Otterbourne and John Whethamstede as *Duo rerum Anglicarum scriptores veteres* (1732); Robert of Gloucester's *Chronicle* (1724); J. Sprott's *Chronica* (1719); the *Vita et gesta Henrici V.*, wrongly attributed to Thomas Elmham (1727); Titus Livy's *Vita Henrici V.* (1716); Walter of Hemingburgh's *Chronicon* (1731); and William of Newburgh's *Historia rerum Anglicarum* (1719). He also edited John Leland's *Itinerary* (1710-1712) and the same author's *Collectanea* (1715); W. Camden's *Annales rerum Anglicarum et Hibernicarum regnanie Elizabetha* (1717); Sir John Spelman's *Life of Alfred* (1709); and W. Koper's *Life of Sir Thomas More* (1716). He brought out an edition of Livy (1708); one of Pliny's *Epistolae et panegyricus* (1703); and one of the Acts of the Apostles (1715). Among his other compilations may be mentioned: *Doctor historicus; a Short System of Universal History* (1704, 1705, 1714, 1724); *A Collection of Curious Discourses by Eminent Antiquaries* (1720); and *Reliquiae Bodleianae* (1703).

Hearne left his manuscripts to William Bedford, who sold them to Dr Richard Rawlinson, who in his turn bequeathed them to the Bodleian. Two volumes of extracts from his voluminous diary were published by Philip Bliss (Oxford, 1857), and afterwards an enlarged edition in three volumes appeared (London, 1869). A large part of his diary entitled *Remarks and Collections, 1705-1714*, edited by C. E. Doble and D. W. Rannie, has been published by the Oxford Historical Society (1885-1898). *Bibliotheca Hearniana*, excerpts from the catalogue of Hearne's library, has been edited by B. Botfield (1848).

See *Impartial Memorials of the Life and Writings of Thomas Hearne by several hands* (1736); and W. D. Macray, *Annals of the Bodleian Library* (1890). Hearne's autobiography is published in W. Huddesford's *Lives of Leland, Hearne and Wood* (Oxford, 1772). T. Ouyry's *Letters addressed to Thomas Hearne* has been privately printed (London, 1874).

HEARSE (an adaptation of Fr. *herse*, a harrow, from Lat. *hirpes*, *hirpicem*, rake or harrow, Greek *ἄραξ*), a vehicle for the conveyance of a dead body at a funeral. The most usual shape is a four-wheeled car, with a roofed and enclosed body, sometimes with glass panels, which contains the coffin. This is the only current use of the word. In its earlier forms it is usually found as "herse," and meant, as its French word did, a harrow (q.v.). It was then applied to other objects resembling a harrow, following the French. It was then used of a portcullis, and thus becomes a heraldic term, the "herse" being frequently borne as a "charge," as in the arms of the City of Westminster. The

chief application of the word is, however, to various objects used in funeral ceremonies. A "herse" or "hearse" seems first to have been a barrow-shaped framework of wood, to hold lighted tapers and decorations placed on a bier or coffin; this later developed into an elaborate pagoda-shaped erection of woodwork or metal for the funerals of royal or other distinguished persons. This held banners, candles, armorial bearings and other heraldic devices. Complimentary verses or epitaphs were often attached to the "hearse." An elaborate "hearse" was designed by Inigo Jones for the funeral of James I. The "hearse" is also found as a permanent erection over tombs. It is generally made of iron or other metal, and was used, not only to carry lighted candles, but also for the support of a pall during the funeral ceremony. There is a brass "hearse" in the Beauchamp Chapel at Warwick Castle, and one over the tomb of Robert Marjion and his wife at Tanfield Church near Ripon.

HEART, in anatomy.—The heart¹ is a four-chambered muscular bag, which lies in the cavity of the thorax between the two lungs. It is surrounded by another bag, the pericardium, for protective and lubricating purposes (see **COELOM AND SEROUS MEMBRANES**). Externally the heart is somewhat conical, its base being directed upward, backward and to the right, its apex downward, forward and to the left. In transverse section the cone is flattened, so that there is an anterior and a posterior surface and a superior and inferior border. The superior border, running obliquely downward and to the left, is very thick, and so gains the name of *margo obtusus*, while the inferior border is horizontal and sharp and is called *margo acutus* (see fig. 1). The divisions between the four chambers of the heart (namely, the two auricles and two ventricles) are indicated on the surface by grooves, and when these are followed it will be seen that the

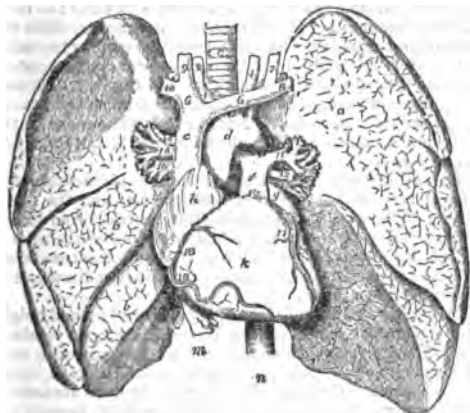

FIG. 1. The Thoracic Viscera.—In this diagram the lungs are turned to the side, and the pericardium removed to display the heart. *a*, upper, *a'*, lower lobe of left lung; *b*, upper, *b'*, middle, *b''*, lower lobe of right lung; *c*, trachea; *d*, arch of aorta; *e*, superior vena cava; *f*, pulmonary artery; *g*, left, and *h*, right auricle; *i*, right, and *l*, left ventricle; *m*, inferior vena cava; *n*, descending aorta; *1*, innominate artery; *2*, right, and *4*, left common carotid artery; *3*, right, and *5*, left subclavian artery; *6*, *6*, right and left innominate vein; *7* and *9*, left and right internal jugular veins; *8* and *10*, left and right subclavian veins; *11*, *12*, *13*, left pulmonary artery, bronchus and vein; *14*, *15*, *16*, right pulmonary bronchus, artery and vein; *17* and *18*, left and right coronary arteries.

right auricle and ventricle lie on the front and right side, while the left auricle and ventricle are behind and on the left.

The *right auricle* is situated at the base of the heart, and its outline is seen on looking at the organ from in front. Into the

¹ In O. Eng. *heorte*; this is a common Teut. word, cf. Dut. *hart*, Ger. *Hers*, Goth. *hairio*; related by root are Lat. *cor* and Gr. *καρδια*: the ultimate root is *hard-*, to quiver, shake.

posterior part of it open the two *venae cavae* (see fig. 2), the superior (*a*) above and the inferior (*b*) below. In front and to the left of the superior vena cava is the right auricular appendage (*c*) which overlaps the front of the root of the aorta, while running obliquely from the front of one vena cava to the other is a shallow groove called the *sulcus terminalis*, which indicates the original separation between the true auricle in front and the sinus venosus behind. When the auricle is opened by turning the front wall to the right as a flap the following structures are exposed:

1. A muscular ridge, called the *crista terminalis*, corresponding to the *sulcus terminalis* on the exterior.

2. A series of ridges on the anterior wall and in the appendage, running downward from the last and at right angles to it, like *k*, mouth of coronary vein; *l*, *m*, *n*, cusps the teeth of a comb; of the tricuspid valve; *o*, *o*, papillary muscles; *p*, semilunar valve; *q*, corpus *musculi pectinati*.

3. The orifice of the superior vena cava (fig. 2, *a*) at the upper and back part of the chamber.

4. The orifice of the inferior vena cava (fig. 2, *b*) at the lower and back part.

5. Attached to the right and lower margins of this opening are the remains of the *Eustachian valve* (fig. 2, *h*), which in the foetus directs the blood from the inferior vena cava, through the *foramen ovale*, into the left auricle.

6. Below and to the left of this is the opening of the *coronary sinus* (fig. 2, *k*), which collects most of the veins returning blood from the substance of the heart.

7. Guarding this opening is the *coronary valve* or *valve of Thebesius*.

8. On the posterior or septal wall, between the two auricles, is an oval depression, called the *fossa ovalis* (fig. 2, *g*), the remains of the original communication between the two auricles. In about a quarter of all normal hearts there is a small valvular communication between the two auricles in the left margin of this depression (see "7th Report of the Committee of Collective Investigation," *J. Anat. and Phys.* vol. xxxii. p. 164).

9. The *annulus ovalis* is the raised margin surrounding this depression.

10. On the left side, opening into the right ventricle, is the *right auriculo-ventricular opening*.

11. On the right wall, between the two caval openings, may occasionally be seen a slight eminence, the *tubercle of Lower*, which is supposed to separate the two streams of blood in the embryo.

12. Scattered all over the auricular wall are minute depressions, the *foramina Thebesii*, some of which receive small veins from the substance of the heart.

The *right ventricle* is a triangular cavity (see fig. 2) the base of which is largely formed by the auriculo-ventricular orifice. To the left of this it is continued up into the root of the pulmonary artery, and this part is known as the *insundibulum*. Its anterior wall forms part of the anterior surface of the heart, while its posterior wall is chiefly formed by the septum ventriculorum,



FIG. 2. Cavities of the Right Side of the Heart.—*a*, superior, and *b*, inferior vena cava; *c*, arch of aorta; *d*, pulmonary artery; *e*, right, and *f*, left auricular appendage; *g*, fossa ovalis; *h*, Eustachian valve; *i*, right angles to it, like *k*, mouth of coronary vein; *l*, *m*, *n*, cusps the teeth of a comb; of the tricuspid valve; *o*, *o*, papillary muscles; *p*, semilunar valve; *q*, corpus *musculi pectinati*.

between it and the left ventricle. Its lower border is the *margo acutus* already mentioned. In transverse section it is crescentic, since the septal wall bulges into its cavity. In its interior the following structures are seen:

1. The *tricuspid valve* (fig. 2, *l, m, n*) guarding against reflux of blood into the right auricle. This consists of a short cylindrical curtain of fibrous tissue, which projects into the ventricle from the margin of the auriculo-ventricular aperture, while from its free edge three triangular flaps hang down, the bases of which touch one another. These cusps are spoken of as septal, marginal and infundibular, from their position.

2. The *chordae tendineae* are fine fibrous cords which fasten the cusps to the *musculi papillares* and ventricular wall, and prevent the valve being turned inside out when the ventricle contracts.

3. The *columnae carneae* are fleshy columns, and are of three kinds. The first are attached to the wall of the ventricle in their whole length and are merely sculptured in relief, as it were; the second are attached by both ends and are free in the middle; while the third are known as the *musculi papillares* and are attached by one end to the ventricular wall, the other end giving attachment to the chordae tendineae. These musculi papillares are grouped into three bundles (fig. 2, *o*).

4. The *moderator band* is really one of the second kind of columnae carneae which stretches from the septal to the anterior wall of the ventricle.

5. The *pulmonary valve* (fig. 2, *p*) at the opening of the pulmonary artery has three crescentic, pocket-like cusps, which, when the ventricle is filling, completely close the aperture, but during the contraction of the ventricle fit into three small niches known as the *sinuses of Valsalva*, and so are quite out of the way of the escaping blood. In the middle of the free margin of each is a small knob called the *corpus Arantii* (fig. 2, *q*), and on each side of this a thin crescent-shaped flap, the *lunula* (fig. 2, *r*), which is only made of two layers of endocardium, whereas in the rest of the cusp there is a fibrous backing between these two layers.

The *left auricle* is situated at the back of the base of the heart, behind and to the left of the right auricle. Running down behind it are the oesophagus and the thoracic aorta. When it is opened it is seen to have a much lighter colour than the other cavities, owing to the greater thickness of its endocardium obscuring the red muscle beneath. There are no musculi pectinati except in the auricular appendage. The openings of the four pulmonary veins are placed two on each side of the posterior wall, but sometimes there may be three on the right side, and only one on the left. On the septal wall is a small depression like the mark of a finger-nail, which corresponds to the anterior part of the fossa ovalis and often forms a valvular communication with the right auricle. The auriculo-ventricular orifice is large and oval, and is directed downward and to the left. Foramina Thebesii and venae minimae cordis are found in this auricle, as in the right, although the chamber is one for arterial or oxidized blood.

At the lower part of the posterior surface of the unopened auricle, lying in the left auriculo-ventricular furrow, is the coronary sinus, which receives most of the veins returning the blood from the heart substance; these are the right and left coronary veins at each extremity and the posterior and left cardiac veins from below. One small vein, called the oblique vein of Marshall, runs down into it across the posterior surface of the auricle, from below the left lower pulmonary vein, and is of morphological interest.

The *left ventricle* is conical, the base being above, behind and to the right, while the apex corresponds to the apex of the heart and lies opposite the fifth intercostal space, $\frac{3}{4}$ in. from the mid line. The following structures are seen inside it:—

1. The *mitral valve* guarding the auriculo-ventricular opening has the same arrangement as the tricuspid, already described, save that there are only two cusps, named marginal and aortic, the latter of which is the larger.

2. The chordae tendineae and columnae carneae resemble those of the right ventricle, though there are only two bundles

of musculi papillares instead of three. These are very large. A moderator band has been found as an abnormality (see *J. Anat. and Phys.* vol. xxx. p. 568).

3. The *aortic valve* has the same structure as the pulmonary, though the cusps are more massive. From the anterior and left posterior sinuses of Valsalva the coronary arteries arise. That part of the ventricle just below the aortic valve, corresponding to the infundibulum on the right, is known as the aortic vestibule.

The walls of the left ventricle are three times as thick as those of the right, except at the apex, where they are thinner. The septum ventriculorum is concave towards the left ventricle, so that a transverse section of that cavity is nearly circular. The greater part of it has nearly the same thickness as the rest of the left ventricular wall and is muscular, but a small portion of the upper part is membranous and thin, and is called the *pars membranacea septi*; it lies between the aortic and pulmonary orifices.

Structure of the Heart.—The arrangement of the muscular fibres of the heart is very complicated and only imperfectly known. For details one of the larger manuals, such as Cunningham's *Anatomy* (London, 1910), or Gray's *Anatomy* (London, 1909), should be consulted. The general scheme is that there are superficial fibres common to the two auricles and two ventricles and deeper fibres for each cavity. Until recently no fibres had been traced from the auricles to the ventricles, though Gaskell predicted that these would be found, and the credit for first demonstrating them is due to Stanley Kent, their details having subsequently been worked out by W. His, Junr., and S. Tawara. The fibres of this *auriculo-ventricular bundle* begin, in the right auricle, below the opening of the coronary sinus, and run forward on the right side of the auricular septum, below the fossa ovalis, and close to the auriculo-ventricular septum. Above the septal flap of the tricuspid valve they thicken and divide into two main branches, one on either side of the ventricular septum, which run down to the bases of the anterior and posterior papillary muscles, and so reach the walls of the ventricle, where their secondary branches form the *fibres of Purkinje*. The bundle is best seen in the hearts of young Ruminants, and it is presumably through it that the wave of contraction passes from the auricles to the ventricles (see article by A. Keith and M. Flack, *Lancet*, 11th of August 1906, p. 359).

The *central fibrous body* is a triangular mass of fibro-cartilage, situated between the two auriculo-ventricular and the aortic orifices. The upper part of the septum ventriculorum blends with it. The *endocardium* is a delicate layer of endothelial cells backed by a very thin layer of fibro-elastic tissue; it is continuous with the endothelium of the great vessels and lines the whole of the cavities of the heart.

The heart is roughly about the size of the closed fist and weighs from 8 to 12 oz.; it continues to increase in size up to about fifty years of age, but the increase is more marked in the male than in the female. Each ventricle holds about 4 l. oz. of blood, and each auricle rather less. The nerves of the heart are derived from the vagus, spinal accessory and sympathetic, through the superficial and deep cardiac plexuses.

Embryology.

In the article on the arteries (*q.v.*) the formation and coalescence of the two *primitive ventral aortae* to form the heart are noticed, so that we may here start with a straight median tube lying ventral to the pharynx and being prolonged cephalad into the ventral aortae and caudad into the vitelline veins. This soon shows four dilatations, which, from the tail towards the head end, are called the sinus venosus, the auricle, the ventricle and the truncus¹ arteriosus. As the tubular heart grows more rapidly than the pericardium which contains it, it becomes bent into the form of an S laid on its side (∞), the ventral convexity being the ventricle and the dorsal the auricle. The passage from the auricle to the ventricle is known as the *auricular canal*, and in the dorsal and ventral parts of this appear two thickenings

¹ This is often called *bulbus arteriosus*, but it will be seen that the term is used rather differently in comparative anatomy.

known as *endocardial cushions*, which approach one another and leave a transverse slit between them (fig. 3, E.C.). Eventually these two cushions fuse in the middle line, obliterating the central part of the slit, while the lateral parts remain as the two auriculo-ventricular orifices; this fusion is known as the *septum intermedium*. From the bottom (ventral convexity) of the ventricle an antero-posterior median septum grows up, which is

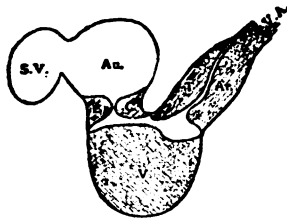

FIG. 3.—Formation of Septa. Diagram of the formation of some of the septa of the heart (viewed from the right side).

- S.V. Sinus venosus.
 Au. Auricle.
 E.C. Endocardial cushions forming septum intermedium.
 V. Septum ventriculorum.
 T.Ar. Septum aorticum intrinsecum arteriosus.
 V.A. Ventral aorta.

later) becomes twisted in such a way that the right ventricle is continuous with the last pair of aortic arches (pulmonary artery), while the left ventricle communicates with the other arches (the permanent ventral aorta and its branches); it joins the septum ventriculorum in the upper part of the ventricular cavity and so forms the *pars membranacea septi* (fig. 3, T. Ar).

The fate of the sinus venosus and auricle must now be followed. Into the former, at first, only the two vitelline veins open, but later, as they develop, the *ducts of Cuvier* and the *umbilical veins* join in (see VEINS). As the ducts of Cuvier come from each side the sinus spreads out to meet them and becomes transversely elongated. The slight constriction, which at first is the only separation between the sinus and the auricle, becomes more marked, and later the opening is into the right part of the auricle, and is guarded by two valvular folds of endocardium (the *venous valves*) which project into that cavity, and are continuous above with a temporary downgrowth from the roof, known as the *septum spurium*. Later the right side of the sinus enlarges, and so does the right part of the aperture, until the back part of the right side of the auricle and the right part of the sinus venosus are thrown into one, and the only remnants of the partition are the *crista terminalis* and the *Eustachian* and *Thebesian valves*. The left part of the sinus venosus, which does not enlarge at the same rate as the right part, remains as the coronary sinus. It will now be seen why, in the adult heart, all the veins which open into the right auricle open into its posterior part, behind the *crista terminalis*. The *septum spurium* has been referred to as a temporary structure; the real division between the two auricles occurs at a later date than that between the ventricles and to the left of the *septum spurium*. It is formed by two partitions, the first of which, called the *septum primum*, grows down from the auricular roof. At first it does not quite reach the endocardial cushions in the auricular canal, already mentioned, but leaves a gap, called the *ostium primum*, between. This has nothing to do with the *foramen ovale*, which occurs as an independent perforation higher up, and at first is known as the *ostium secundum*. When it is established the *septum primum* grows down and meets the endocardial cushions, and so the *ostium primum* is obliterated. The *septum secundum* grows down on the right of the *septum primum* and is never complete; it grows round and largely overlaps the *foramen ovale* and its edges form the annulus

ovalis, so that, in the later months of foetal life, the *foramen ovale* is a valvular opening, the floor of which is formed by the *septum primum* and the margins by the *septum secundum*. The closure of the foramen is brought about by adhesion of the two septa.

The pulmonary veins of the two sides at first join one another, dorsal to the left auricle, and open into that cavity by a single median trunk, but, as the auricle grows, this trunk and part of the right and left veins are absorbed into its cavity.

The mitral and tricuspid valves are formed by the shortening of the auricular canal which becomes telescoped into the ventricle, and the cusps are the remnants of this telescoping process.

The *columnae carneae* and *chordae tendineae* are the remains of a spongy network which originally filled the cavity of the primary ventricle.

The aortic and pulmonary valves are laid down in the ventral aorta, before it is divided into aorta and pulmonary artery, as four endocardial cushions; anterior, posterior and two lateral. The *septum aorticum* cuts the latter two into two, so that each artery has the rudiments of three cusps.

Abnormalities of the heart are very numerous, and can usually be explained by a knowledge of its development. They often cause grave clinical symptoms. A clear and well-illustrated review of the most important of them will be found in the chapter on congenital disease of the heart in *Clinical Applied Anatomy*, by C. R. Box and W. McAdam Eccles, London, 1906.

For further details of the embryology of the heart see Oscar Hertwig's *Entwickelungslehre der Wirbeltiere* (Jena, 1902); G. Born, "Entwicklung des Säugtierherzens," *Archiv f. mik. Anat.* Bd. 33 (1889); W. His, *Anatomie menschlicher Embryonen* (Leipzig, 1881-1885); Quain's *Anatomy*, vol. 1. (1908); C. S. Minot, *Human Embryology* (New York, 1892); and A. Keith, *Human Embryology and Morphology* (London, 1905).

Comparative Anatomy.

In the *Acrania* (e.g. lancelet) there is no heart, though the vessels are specially contractile in the ventral part of the pharynx.

In the *Cyclostomata* (lamprey and hag), and Fishes, the heart has the same arrangement which has been noticed in the human embryo. There is a smooth, thin-walled sinus venosus, a thin reticulate-walled auricle, produced laterally into two appendages, a thick-walled ventricle, and a *conus arteriosus* containing valves. In addition to these the beginning of the ventral aorta is often thickened and expanded to form a *bulbus arteriosus*, which is non-contractile, and, strictly speaking, should rather be described with the arteries than with the heart. In relation to human embryology the smooth sinus venosus and reticulated auricle are interesting. Between the auricle and ventricle is the auriculo-ventricular valve, which primarily consists of two cusps, comparable to the two endocardial cushions of the human embryo, though in some forms they may be subdivided. In the interior of the ventricle is a network of muscular trabeculae. The *conus arteriosus* in the *Elasmobranchs* (sharks and rays) and *Ganoids* (sturgeon) is large and provided with several rows of semilunar valves, but in the *Cyclostomes* (lamprey) and *Teleosts* (bony fishes) the *conus* is reduced and only the anterior (cephalic) row of valves retained. With the reduction of the *conus* the *bulbus arteriosus* is enlarged. So far the heart is a single tubular organ expanded into various cavities and having the characteristic *Ω*-shaped form seen in the human embryo; it contains only venous blood which is forced through the gills to be oxidized on its way to the tissues. In the *Dipnoi* (mud fish), in which rudimentary lungs, as well as gills, are developed, the auricle is divided into two, and the sinus venosus opens into the right auricle. The *conus arteriosus* too begins to be divided into two chambers, and in *Protopteron* this division is complete. This division of the heart is one instance in which mammalian ontogeny does not repeat the processes of phylogeny, because, in the human embryo, it has been shown that the ventricular septum appears before the auricular. This want of harmony is sometimes spoken of as the "falsification of the embryological record."

In the *Amphibia* there are also two auricles and one ventricle,

though in the Urodela (tailed amphibians) the auricular septum is often fenestrated. The sinus venosus is still a separate chamber, and the conus arteriosus, which may contain many or few valves, is usually divided into two by a spiral fold. Structurally the amphibian heart closely resembles the dipnoan, though the increased size of the left auricle is an advance. In the Anura (frogs and toads) the whole ventricle is filled with a spongy network which prevents the arterial and venous blood from the two auricles mixing to any great extent. (For the anatomy and physiology of the frog's heart, see *The Frog*, by Milnes Marshall.)

In the Reptiles the ventricular septum begins to appear; this in the lizards is quite incomplete, but in the crocodiles, which are usually regarded as the highest order of living reptiles, the partition has nearly reached the top of the ventricle, and the condition resembles that of the human embryo before the pars membranacea septi is formed. The conus arteriosus becomes included in the ventricular cavity, but the sinus venosus still remains distinct, and its opening into the right ventricle is guarded by two valves which closely resemble the two venous valves in the auricle of the human embryo already referred to.

In the Birds the auricular and ventricular septa are complete; the right ventricle is thin-walled and crescentic in section, as in Man, and the musculi papillares are developed. The left auriculo-ventricular valve has three membranous cusps with chordae tendinae attached to them, but the right auriculo-ventricular valve has a large fleshy cusp without chordae tendinae. The sinus venosus is largely included in the right auricle, but remains of the two venous valves are seen on each side of the orifice of the inferior vena cava.

In the Mammals the structure of the heart corresponds closely with the description of that of Man already given. In the Ornithorynchus, among the Monotremes, the right auriculo-ventricular valve has two fleshy and two membranous cusps, thus showing a resemblance to that of the bird. In the Echidna, the other member of the order, however, both auriculo-ventricular valves are membranous. In the Edentates the remains of the venous valves at the opening of the inferior vena cava are better marked than in other orders. In the Ungulates the moderator band in the right ventricle is especially well developed, and the central fibrous body at the base of the heart is often ossified, forming the os cordis so well known in the heart of the ox.

The position of the heart in the lower mammals is not so oblique as it is in Man.

For further details, see C. Rose, *Beitr. z. vergl. Anat. des Herzens der Wirbelthiere Morph. Jahrb.*, Bd. xvi. (1890); R. Widersheim, *Vergleichende Anatomie der Wirbelthiere* (Jena, 1902) (for literature); also Parker and Haswell's *Zoology* (London, 1897). (F. G. P.)

HEART DISEASE.—In the early ages of medicine, the absence of correct anatomical, physiological and pathological knowledge prevented diseases of the heart from being recognized with any certainty during life, and almost entirely precluded them from becoming the object of medical treatment. But no sooner did Harvey (1628) publish his discovery of the circulation of the blood, and its dependence on the heart as its central organ, than derangements of the circulation began to be recognized as signs of disease of that central organ. (See also under VASCULAR SYSTEM.)

Among the earliest to profit by this discovery and to make important contributions to the literature of diseases of the heart and circulation were, R. Lower (1631-1691), R. Viuessens (1641-1716), H. Boerhave. (1668-1738) and the great pathologists at the beginning of the 18th century, G. M. Lancisi (1654-1720), G. B. Morgagni (1682-1771) and J. B. Senac (1693-1770). The works of these writers form very interesting reading, and it is remarkable how careful were the observations made, and how sound the conclusions drawn, by these pioneers of scientific medicine. J. N. Corvisart (1755-1821) was one of the earliest to make practical use of R. T. Auenbrugger's (1722-1800) invention of percussion to determine the size of the heart. R. T. H. Laennec (1781-1826) was the first to make a scientific application of mediate auscultation to the diagnosis of disease of

the chest, by the invention of the stethoscope. J. Bouillaud (1796-1881) extended its use to the diagnosis of disease of the heart. To James Hope (1801-1841) we owe much of the precision we have now attained in diagnosis of valvular disease from abnormalities in the sounds produced during cardiac movements. This short list by no means exhausts the earlier literature on the subject, but each of these names marks an era in the progress of the diagnosis of cardiac disease. In later years the literature on this subject has become very copious.

The heart and great vessels occupy a position immediately to the left of the centre of the thoracic cavity. The anterior surface of the heart is projected against the chest wall and is surrounded on either side by the lungs, which are resonant organs, so that any increase in the size of the heart, "dilatation," can be detected by percussion. By placing the hand on the chest, palpation, the impulse of the left ventricle, or apex beat, can normally be felt just below and internal to the nipple. Deviations from the normal in the position or force of the apex beat will afford important information as to the nature of the pathological changes in the heart. Thus, displacement downwards and outwards of the apex beat, with a forcible thrusting impulse, will indicate hypertrophy, or increase of the muscular wall and increased driving power of the left ventricle, whereas a similar displacement with a feeble diffuse impulse will indicate dilatation, or over-distension of its cavity from stretching of the walls.

By auscultation, or listening with a suitable instrument named a stethoscope over appropriate areas, we can detect any abnormality in the sounds of the heart, and the presence of murmurs indicative of disease of one or other of the valves of the heart.

The pericardium is a fibro-serous sac which loosely envelops the heart and the origin of the great vessels. Inflammation of this sac, or *pericarditis*, is apt to occur as a result of rheumatism, more especially in children. It may also occur as a complication of pneumonia. It is a serious affection associated with pain over the heart, fever, shortness of breath, rapid pulse and dilatation of the heart. As a result of the inflammation, fluid may accumulate in the pericardial sac, or the walls of the sac may become adherent to the heart and tend to embarrass its action. In favourable cases, however, recovery may take place without any untoward sequelae.

Diseases of the heart may be classified in two main groups, (1) Disease of the valves, and (2) Disease of the walls of the heart.

1. *Valvular Disease.*—Inflammation of the valves of the heart, or *endocarditis*, is one of the most common complications of rheumatism in children and young adults. More severe types, which are apt to prove fatal from a form of blood poisoning, may result when the valves of the heart are attacked by certain micro-organisms, such as the pneumococcus, which is responsible for pneumonia, the streptococcus and the staphylococcus pyogenes, the gonococcus and the influenza bacillus.

As a result of endocarditis, one or more of the valves may be seriously damaged, so that it leaks or becomes incompetent. The valves of the left side of the heart, the aortic and mitral valves, are affected far more commonly than those of the right side. It is indeed comparatively rarely that the latter are attacked. In the process of healing of a damaged valve, scar tissue is formed which has a tendency to contract, so that in some cases the orifice of the valve becomes narrowed, and the resulting stenosis or narrowing gives rise to obstruction of the blood stream. We may thus have incompetence or stenosis of a valve or both combined.

Valvular lesions are detected on auscultation over appropriate areas by the blowing sounds or murmurs to which they give rise, which modify or replace the normal heart sounds. Thus, lesions of the mitral valve give rise to murmurs which are heard at the apex beat of the heart, and lesions of the aortic valves to murmurs which are heard over the aortic area, in the second right intercostal space. Accurate timing of the murmurs in relation to the heart sounds enables us to judge whether the murmur is due to stenosis or incompetence of the valve affected.

If the valvular lesion is severe, it is essential for the proper maintenance of the circulation that certain changes should take place in the heart to compensate for or neutralize the effects of the regurgitation or obstruction, as the case may be. In affections of the aortic valve, the extra work falls on the left ventricle, which enlarges proportionately and undergoes hypertrophy. In affections of the mitral valve the effect is felt primarily by the left auricle, which is a thin walled structure incapable of undergoing the requisite increase in power to resist the backward flow through the mitral orifice in case of leakage, or to overcome the effects of obstruction in case of stenosis. The back pressure is therefore transmitted to the pulmonary circulation, and as the right ventricle is responsible for maintaining the flow of blood through the lungs, the strain and extra work fall on the right ventricle, which in turn enlarges and undergoes hypertrophy. The degree of hypertrophy of the left or right ventricle is thus, up to a certain point, a measure of the extent of the lesion of the aortic or mitral valve respectively. When the effects of the valvular lesion are so neutralized by these structural changes in the heart that the circulation is equably maintained, "compensation" is said to be efficient.

When the heart gives way under the strain, compensation is said to break down, and dropsy, shortness of breath, cough and cyanosis, are among the distressing symptoms which may set in. The mere existence of a valvular lesion does not call for any special treatment so long as compensation is efficient, and a large number of people with slight valvular lesions are living lives indistinguishable from those of their neighbours. It will, however, be readily understood that in the case of the more serious lesions certain precautions should be observed in regard to over-exertion, excitement, over-indulgence in tobacco or alcohol, &c., as the balance is more readily upset and any undue strain on the heart may cause a breakdown of compensation. When this occurs treatment is required. A period of rest in bed is often sufficient to enable the heart to recover, and this may be supplemented as required by the administration of mercurial and saline purgatives to relieve the embarrassed circulation, and of suitable cardiac tonics, such as digitalis and strychnin, to reinforce and strengthen the heart's action.

2. *Affections of the Muscular Wall of the Heart.*—Dilatation of the heart, or stretching of the walls of the heart, is an incident, as has already been stated, in pericarditis and in the earlier stages of valvular disease antecedent to hypertrophy. Temporary over-distension or dilatation of the cavities of the heart occurs in violent and protracted exertion, but rapidly subsides and is in no wise harmful to the sound and vigorous heart of the young. It is otherwise if the heart is weak and flabby from a too sedentary life or degenerative changes in its walls or during convalescence from a severe illness, when the same circumstances which will not injure a healthy heart, may give rise to serious dilatation from which recovery may be very protracted.

Influenza is a common cause of cardiac dilatation, and is liable to be a source of trouble after the acute illness has subsided, if the patient goes about and resumes his ordinary avocations too soon.

Fatty or fibroid degeneration of the heart wall may occur in later life from impaired nutrition of the muscle, due to partial obstruction of the blood-vessels supplying it, when they are the seat of the degenerative changes known as arteriosclerosis or atheroma. The affection known as *angina pectoris* (q.v.) may be a further consequence of this defective blood-supply.

The treatment will vary according to the nature of the case. In serious cases of dilatation, rest in bed, purgatives and cardiac tonics may be required.

In commencing degenerative change the Oertel treatment, consisting of graduated exercise up a gentle slope, limitation of fluids and a special diet, may be indicated.

In cases of slight dilatation after influenza or recent illness, the Schott treatment by baths and exercises as carried out at Nauheim may be sometimes beneficial. The change of air and scene, the enforced rest, the placid life, together with freedom

from excitement and worry, are among the most important factors which contribute to success in this class of case.

Disorders of Rhythm of the Heart's Action.—Under this heading may be grouped a number of conditions to which the name "functional affections of the heart" has sometimes been applied, inasmuch as the disturbances in question cannot usually be attributed to definite organic disease of the heart. We must, of course, exclude from this category the irregularity in the force and frequency of the pulse, which is commonly associated with incompetence of the mitral valve.

The heart is a muscular organ possessing certain properties, rhythmicity, excitability, contractility, conductivity and tonicity, as pointed out by Gaskell, in virtue of which it is able to maintain a regular automatic beat independently of nerve stimulation. It is, however, intimately connected with the brain, blood-vessels and the abdominal and thoracic viscera, by innumerable nerves, through which impulses or messages are being constantly sent to and received from these various portions of the body. Such messages may give rise to disturbances of rhythm with which we are all familiar. For instance, sudden fright or emotion may cause a momentary arrest of the heart's action, and excitement or apprehension may set up a rapid action of the heart or *palpitation*. Palpitation, again, is often the result of digestive disorders, the message in this case being received from the stomach, instead of the brain as in emotional disturbances. It may also result from over-indulgence in tobacco and alcohol.

Tachycardia is the name applied to a more or less permanent increase in the rate of the heart-beat. It is usually a prominent feature in the affection known as Graves' disease or exophthalmic goitre. It may also result from chronic alcoholism. In the condition known as paroxysmal tachycardia there appears to be no adequate explanation for its onset.

Bradycardia or abnormal slowness of the heart-beat, is the converse of tachycardia. An abnormally slow pulse is met with in melancholia, cerebral tumour, jaundice and certain toxic conditions, or may follow an attack of influenza. There is, however, a peculiar affection characterized by abnormal slowness of pulse (often ranging as low as 30), and the onset, from time to time, of epileptiform or syncopal attacks. To this the name "Stokes-Adams disease" has been applied, as it was first called attention to by Adams in 1827, and subsequently fully described by Stokes in 1836. It is usually associated with senile degenerative change of the heart and vascular system, and is held to be due to impairment of conductivity in the muscular fibres (bundle of His) which transmit the wave of contraction from the auricle to the ventricle. It is of serious significance in view of the symptoms associated with it.

Intermittency of the Pulse.—By this is understood a pulse in which a beat is dropped from time to time. The dropping of a beat may occur at regular intervals every two, four or six beats, &c., or occasionally at irregular intervals after a series of normal beats. On examining the heart, it is found, as a rule, that the cause of the intermission at the wrist is not actual omission of a heart-beat, but the occurrence of a hurried imperfect cardiac contraction which does not transmit a pulse-wave to the wrist. It is not characteristic of any special form of heart affection, and is rarely of serious import. It may be due to reflex digestive disturbances, or be associated with conditions of nervous breakdown and irritability, or with an atonic and relaxed condition of the heart muscle. The treatment of these disorders of rhythm of the heart will vary greatly according to the cause and is often a matter of considerable difficulty. (J. F. H. B.)

Surgery of Heart and Pericardium.—As the result of acute or chronic inflammation of the lining membrane of the fibrous sac which surrounds the heart and the neighbouring parts of the large blood-vessels, a dropsical or a purulent collection may form in it, or the sac may be quietly distended by a thin watery fluid. In either case, but especially in the latter, the heart may be so embarrassed in its work that death seems imminent. The condition is generally due to the cultivation

in the pericardium of the germs of rheumatism, influenza or gonorrhoea, or of those of ordinary suppuration. Respiration as well as circulation is embarrassed, and there is a marked fullness and dulness of the front wall of the chest to the left of the breast-bone. In that region also pain and tenderness are complained of. By using the slender, hollow needle of an aspirator great relief may be afforded, but the tapping may have to be repeated from time to time. If the fluid drawn off is found to be purulent, it may be necessary to make a trap-door opening into the chest by cutting across the 4th and 5th ribs, incising and evacuating the pericardium and providing for drainage. In short, an abscess in the pericardium must be treated like an abscess in the pleura.

Wounds of the heart are apt to be quickly fatal. If the probability is that the enfeebled action of the heart is due to pressure from blood which is leaking into, and is locked up in the pericardium, the proper treatment will be to open the pericardium, as described above, and, if possible, to close the opening in the auricle, ventricle or large vessel, by sutures. (E. O.*)

HEART-BURIAL, the burial of the heart apart from the body. This is a very ancient practice, the special reverence shown towards the heart being doubtless due to its early association with the soul of man, his affections, courage and conscience. In medieval Europe heart-burial was fairly common. Some of the more notable cases are those of Richard I., whose heart, preserved in a casket, was placed in Rouen cathedral; Henry III., buried in Normandy; Eleanor, queen of Edward I., at Lincoln; Edward I., at Jerusalem; Louis IX., Philip III., Louis XIII. and Louis XIV., in Paris. Since the 17th century the hearts of deceased members of the house of Habsburg have been buried apart from the body in the Loretto chapel in the Augustiner Kirche, Vienna. The most romantic story of heart-burial is that of Robert Bruce. He wished his heart to rest at Jerusalem in the church of the Holy Sepulchre, and on his deathbed entrusted the fulfilment of his wish to Douglas. The latter broke his journey to join the Spaniards in their war with the Moorish king of Granada, and was killed in battle, the heart of Bruce enclosed in a silver casket hanging round his neck. Subsequently the heart was buried at Melrose Abbey. The heart of James, marquess of Montrose, executed by the Scottish Covenanters in 1650, was recovered from his body, which had been buried by the roadside outside Edinburgh, and, enclosed in a steel box, was sent to the duke of Montrose, then in exile. It was lost on its journey, and years afterwards was discovered in a curiosity shop in Flanders. Taken by a member of the Montrose family to India, it was stolen as an amulet by a native chief, was once more regained, and finally lost in France during the Revolution. Of notable 17th-century cases there is that of James II., whose heart was buried in the church of the convent of the Visitation at Chaillot near Paris, and that of Sir William Temple, at Moor Park, Farnham. The last ceremonial burial of a heart in England was that of Paul Whitehead, secretary to the Monks of Medmenham club, in 1775, the interment taking place in the Le Despenser mausoleum at High Wycombe, Bucks. Of later cases the most notable are those of Daniel O'Connell, whose heart is at Rome, Shelley at Bournemouth, Louis XVII. at Venice, Kosciusko at the Polish museum at Rapperschwyll, Lake Zürich, and the marquess of Bute, taken by his widow to Jerusalem for burial in 1900. Sometimes other parts of the body, removed in the process of embalming, are given separate and solemn burial. Thus the viscera of the popes from Sixtus V. (1590) onward have been preserved in the parish church of the Quirinal. The custom of heart-burial was forbidden by Pope Boniface VIII. (1294-1303), but Benedict XI. withdrew the prohibition.

See Pettigrew, *Chronicles of the Tombs* (1857).

HEARTH (a word which appears in various forms in several Teutonic languages, cf. Dutch *haard*, German *Herd*, in the sense of "floor"), the part of a room where a fire is made, usually constructed of stone, bricks, tiles or earth, beaten hard and having a chimney above; the fire being lighted either on the hearth itself, or in a receptacle placed there for the purpose.

Like the Latin *focus*, especially in the phrase for "hearth and home" answering to *pro aris et focis*, the word is used as equivalent to the home or household. The word is also applied to the fire and cooking apparatus on board ship; the floor of a smith's forge; the floor of a reverberatory furnace on which the ore is exposed to the flame; the lower part of a blast furnace through which the metal goes down into the crucible; in soldering, a portable brazier or chafing dish, and an iron box sunk in the middle of a flat iron plate or table. An "open-hearth furnace" is a regenerative furnace of the reverberatory type used in making steel, hence "open-hearth steel" (see IRON AND STEEL).

Hearth-money, hearth tax or chimney-money, was a tax imposed in England on all houses except cottages at a rate of two shillings for every hearth. It was first levied in 1662, but owing to its unpopularity, chiefly caused by the domiciliary visits of the collectors, it was repealed in 1689, although it was producing £170,000 a year. The principle of the tax was not new in the history of taxation, for in Anglo-Saxon times the king derived a part of his revenue from a *sumage* or tax of smoke farthings levied on all hearths except those of the poor. It appears also in the hearth-penny or tax of a penny on every hearth, which as early as the 10th century was paid annually to the pope (see PETER'S PENCE).

HEARTS, a game of cards of recent origin, though founded upon the same principle as many old games, such as *Slobberhannes*, *Four Jacks* and *Enflé*, namely, that of losing instead of winning as many tricks as possible. Hearts is played with a full pack, ace counting highest and deuce lowest. In the four-handed game, which is usually played, the entire pack is dealt out as at whist (but without turning up the last card, since there are no trumps), and the player at the dealer's left begins by leading any card he chooses, the trick being taken by the highest card of the suit led. Each player must follow suit if he can; if he has no cards of the suit led he is privileged to throw away any card he likes, thus having an opportunity of getting rid of his hearts, which is the object of the game. When all thirteen tricks have been played each player counts the hearts he has taken in and pays into the pool a certain number of counters for them, according to an arrangement made before beginning play. In the four-handed, or sweepstake, game the method of settling called "Howell's," from the name of the inventor, has been generally adopted, according to which each player begins with an equal number of chips, say 100, and, after the hand has been played, pays into the pool as many chips for each heart he had taken as there are players besides himself. Then each player takes out of the pool one chip for every heart he did not win. The pool is thus exhausted with every deal. Hearts may be played by two, three, four or even more players, each playing for himself.

Spot Hearts.—In this variation the hearts count according to the number of spots on the cards, excepting that the ace counts 14, the king 13, queen 12 and knave 11, the combined score of the thirteen hearts being thus 104.

Auction Hearts.—In this the eldest hand examines his hand and bids a certain number of counters for the privilege of naming the suit to be got rid of, but without naming the suit. The other players in succession have the privilege of outbidding him, and whoever bids most declares the suit and pays the amount of his bid into the pool, the winner taking it.

Joker Hearts.—Here the deuce of hearts is discarded, and an extra card, called the joker, takes its place, ranking in value between ten and knave. It cannot be thrown away, excepting when hearts are led and an ace or court card is played, though if an opponent discards the ace or a court card of hearts, then the holder of the joker may discard it. The joker is usually considered worth five chips, which are either paid into the pool or to the player who succeeds in discarding the joker.

Heartselle.—In this variation the deuce of spades is deleted and the three cards left after dealing twelve cards to each player are called the *widow* (or *bitly*), and are left face downward on the table. The winner of the first trick must take the widow without showing it to his opponents.

Slobberhannes.—The object of this older form of Hearts is to avoid taking either the first or last trick or a trick containing the queen of clubs. A euchre pack (thirty-two cards, lacking all below the 7) is used, and each player is given 10 counters, one being forfeited to the pool if a player takes the first or last trick, or that containing the club queen. If he takes all three he forfeits four points.

Four Jacks (Poisgnac or Quatre-Valets) is usually played with a piquet pack, the cards ranking in France as at *carté*, but in Great Britain and America as at piquet. There is no trump suit. Counters are used, and the object of the game is to avoid taking any trick containing a knave, especially the knave of spades, called *Poisgnac*. The player taking such a trick forfeits one counter to the pool. *Enfilé (or Schmetzen)* is usually played by four persons with a piquet pack and for a pool. The cards rank as at Hearts, and there is no trump suit. A player must follow suit if he can, but if he cannot he may not discard, but must take up all tricks already won and add them to his hand. Play is continued until one player gets rid of all his cards and thus wins.

HEAT (O. E. *hætu*, which like "hot," Old Eng. *hæt*, is from the Teutonic type *haita*, *hit*, to be hot, cf. Ger. *hitze*, *heiss*; Dutch, *hitte*, *heet*, &c.), a general term applied to that branch of physical science which deals with the effects produced by heat on material bodies, with the laws of transference of heat, and with the transformations of heat into other kinds of energy. The object of the present article is to give a brief sketch of the historical development of the science of heat, and to indicate the relation of the different branches of the subject, which are discussed in greater detail with reference to the latest progress in separate articles.

1. *Meanings of the Term Heat.*—The term heat is employed in ordinary language in a number of different senses. This makes it a convenient term to employ for the general title of the science, but the different meanings must be carefully distinguished in scientific reasoning. For the present purpose, omitting metaphorical significations, we may distinguish four principal uses of the term: (a) Sensation of heat; (b) Temperature, or degree of hotness; (c) Quantity of thermal energy; (d) Radiant heat, or energy of radiation.

(a) From the sense of heat, aided in the case of very hot bodies by the sense of sight, we obtain our first rough notions of heat as a physical entity, which alters the state of a body and its condition in respect of warmth, and is capable of passing from one body to another. By touching a body we can tell whether it is warmer or colder than the hand, and, by touching two similar bodies in succession, we can form a rough estimate, by the acuteness of the sensation experienced, of their difference in hotness or coldness over a limited range. If a hot iron is placed on a cold iron plate, we may observe that the plate is heated and the iron cooled until both attain appreciably the same degree of warmth; and we infer from similar cases that something which we call "heat" tends to pass from hot to cold bodies, and to attain finally a state of equable diffusion when all the bodies concerned are equally warm or cold. Ideas such as these derived entirely from the sense of heat, are, so to speak, embedded in the language of every nation from the earliest times.

(b) From the sense of heat, again, we naturally derive the idea of a continuous scale or order, expressed by such terms as summer heat, blood heat, fever heat, red heat, white heat, in which all bodies may be placed with regard to their degrees of hotness, and we speak of the *temperature* of a body as denoting its place in the scale, in contradistinction to the quantity of heat it may contain.

(c) The quantity of heat contained in a body obviously depends on the size of the body considered. Thus a large kettleful of boiling water will evidently contain more heat than a teacupful, though both may be at the same temperature. The temperature does not depend on the size of the body, but on the degree of concentration of the heat in it, i.e. on the quantity of heat per unit mass, other things being equal. We may regard it as axiomatic that a given body (say a pound of water) in a given state (say boiling under a given pressure) must always contain the same quantity of heat, and conversely that, if it contains a given quantity of heat, and if it is under conditions in other respects, it must be at a definite temperature, which will always be the same for the same given conditions.

(d) It is a matter of common observation that rays of the sun or of a fire falling on a body warm it, and it was in the first instance natural to suppose that heat itself somehow travelled across the intervening space from the sun or fire to the body warmed, in such the same way as heat may be carried by a current of hot air or water. But we now know that energy of radiation is not the same thing as heat, though it is converted into heat when the rays strike an absorbing substance. The term "radiant heat," however, is generally retained, because radiation is commonly measured in terms of the heat it produces, and because the transference of energy by radiation and absorption is the most important agency in the diffusion of heat.

2. *Evolution of the Thermometer.*—The first step in the development of the science of heat was necessarily the invention of a thermometer, an instrument for indicating temperature and measuring its changes. The first requisite in the case of such an

instrument is that it should always give, at least approximately, the same indication at the same temperature. The air-thermoscope of Galileo, illustrated in fig. 1, which consisted of a glass bulb containing air, connected to a glass tube of small bore dipping into a coloured liquid, though very sensitive to variations of temperature, was not satisfactory as a measuring instrument, because it was also affected by variations of atmospheric pressure. The invention of the type of thermometer familiar at the present day, containing a liquid hermetically sealed in a glass bulb with a fine tube attached,

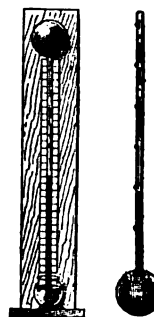

FIG. 1. FIG. 2.

is also generally attributed to Galileo at a slightly later date, about 1612. Alcohol was the liquid first employed, and the degrees, intended to represent thousandths of the volume of the bulb, were marked with small beads of enamel fused on the stem, as shown in fig. 2. In order to render the readings of such instruments comparable with each other, it was necessary to select a fixed point or standard temperature as the zero or starting-point of the graduations. Instead of making each degree a given fraction of the volume of the bulb, which would be difficult in practice, and would give different values for the degree with different liquids, it was soon found to be preferable to take *two fixed points*, and to divide the interval between them into the same number of degrees. It was natural in the first instance to take the temperature of the human body as one of the fixed points. In 1701 Sir Isaac Newton proposed a scale in which the freezing-point of water was taken as zero, and the temperature of the human body as 12°. About the same date (1714) Gabriel Daniel Fahrenheit proposed to take as zero the lowest temperature obtainable with a freezing mixture of ice and salt, and to divide the interval between this temperature and that of the human body into 12°. To obtain finer graduations the number was subsequently increased to 96°. The freezing-point of water was at that time supposed to be somewhat variable, because as a matter of fact it is possible to cool water several degrees below its freezing-point in the absence of ice. Fahrenheit showed, however, that as soon as ice began to form the temperature always rose to the same point, and that a mixture of ice or snow with pure water always gave the same temperature. At a later period he also showed that the temperature of boiling water varied with the barometric pressure, but that it was always the same at the same pressure, and might therefore be used as the second fixed point (as Edmund Halley and others had suggested) provided that a definite pressure, such as the average atmospheric pressure, were specified. The freezing and boiling-points on one of his thermometers, graduated as already explained, with the temperature of the body as 96°, came out in the neighbourhood of 32° and 212° respectively, giving an interval of 180° between these points. Shortly after Fahrenheit's death (1736) the freezing and boiling-points of water were generally recognized as the most convenient fixed points to adopt, but different systems of subdivision were employed. Fahrenheit's scale, with its small degrees and its zero below the freezing-point, possesses undoubted advantages for meteorological work, and is still retained in most English-speaking countries. But for general scientific purposes, the centigrade system, in which the freezing-point is marked 0° and the boiling-point 100°, is now almost universally employed, on account of its greater simplicity from an arithmetical point of view. For work of precision the fixed points have been more exactly defined (see THERMOMETRY), but no change has been made in the fundamental principle of graduation.

3. *Comparison of Scales based on Expansion.*—Thermometers constructed in the manner already described will give strictly comparable readings, provided that the tubes be of uniform bore, and that the same liquid and glass be employed in their

construction. But they possess one obvious defect from a theoretical point of view, namely, that the subdivision of the temperature scale depends on the expansion of the particular liquid selected as the standard. A liquid such as water, which, when continuously heated at a uniform rate from its freezing-point, first contracts and then expands, at a rapidly increasing rate, would obviously be unsuitable. But there is no a priori reason why other liquids should not behave to some extent in a similar way. As a matter of fact, it was soon observed that thermometers carefully constructed with different liquids, such as alcohol, oil and mercury, did not agree precisely in their indications at points of the scale intermediate between the fixed points, and diverged even more widely outside these limits. Another possible method, proposed in 1694 by Carlo Renaldini (1615-1698), professor of mathematics and philosophy at Pisa, would be to determine the intermediate points of the scale by observing the temperatures of mixtures of ice-cold and boiling water in varying proportions. On this method, the temperature of 50° C. would be defined as that obtained by mixing equal weights of water at 0° C. and 100° C.; 20° C., that obtained by mixing 80 parts of water at 0° C. with 20 parts of water at 100° C. and so on. Each degree rise of temperature in a mass of water would then represent the addition of the same quantity of heat. The scale thus obtained would, as a matter of fact, agree very closely with that of a mercury thermometer, but the method would be very difficult to put in practice, and would still have the disadvantage of depending on the properties of a particular liquid, namely, water, which is known to behave in an anomalous manner in other respects. At a later date, the researches of Gay-Lussac (1802) and Regnault (1847) showed that the laws of the expansion of gases are much simpler than those of liquids. Whereas the expansion of alcohol between 0° C. and 100° C. is nearly seven times as great as that of mercury, all gases (excluding easily condensable vapours) expand equally, or so nearly equally that the differences between them cannot be detected without the most refined observations. This equality of expansion affords a strong a priori argument for selecting the scale given by the expansion of a gas as the standard scale of temperature, but there are still stronger theoretical grounds for this choice, which will be indicated in discussing the absolute scale (§ 21). Among liquids mercury is found to agree most nearly with the gas-scale, and is generally employed in thermometers for scientific purposes on account of its high boiling-point and for other reasons. The differences of the mercurial scale from the gas scale having been carefully determined, the mercury thermometer can be used as a secondary standard to replace the gas thermometer within certain limits, as the gas thermometer would be very troublesome to employ directly in ordinary investigations. For certain purposes, and especially at temperatures beyond the range of mercury thermometers, electrical thermometers, also standardized by reference to the gas thermometer, have been very generally employed in recent years, while for still higher temperatures beyond the range of the gas thermometer, thermometers based on the recently established laws of radiation are the only instruments available. For a further discussion of the theory and practice of the measurement of temperature, the reader is referred to the article THERMOMETRY.

4. *Change of State.*—Among the most important effects of heat is that of changing the state of a substance from solid to liquid, or from liquid to vapour. With very few exceptions, all substances, whether simple or compound, are known to be capable of existing in each of the three states under suitable conditions of temperature and pressure. The transition of any substance, from the state of liquid to that of solid or vapour under the ordinary atmospheric pressure, takes place at fixed temperatures, the freezing and boiling-points, which are very sharply defined for pure crystalline substances, and serve in fact as fixed points of the thermometric scale. A change of state cannot, however, be effected in any case without the addition or subtraction of a certain definite quantity of heat. If a piece of ice below the freezing-point is gradually heated at a uniform rate, its temperature may be observed to rise regularly till the freezing-point

is reached. At this point it begins to melt, and its temperature ceases to rise. The melting takes a considerable time, during the whole of which heat is being continuously supplied without producing any rise of temperature, although if the same quantity of heat were supplied to an equal mass of water, the temperature of the water would be raised nearly 80° C. Heat thus absorbed in producing a change of state without rise of temperature is called "Latent Heat," a term introduced by Joseph Black, who was one of the first to study the subject of change of state from the point of view of heat absorbed, and who in many cases actually adopted the comparatively rough method described above of estimating quantities of heat by observing the time required to produce a given change when the substance was receiving heat at a steady rate from its surroundings. For every change of state a definite quantity of heat is required, without which the change cannot take place. Heat must be added to melt a solid, or to vaporize a solid or a liquid, and conversely, heat must be subtracted to reverse the change, i.e. to condense a vapour or freeze a liquid. The quantity required for any given change depends on the nature of the substance and the change considered, and varies to some extent with the conditions (as to pressure, &c.) under which the change is made, but is always the same for the same change under the same conditions. A rough measurement of the latent heat of steam was made as early as 1764 by James Watt, who found that steam at 212° F., when passed from a kettle into a jar of cold water, was capable of raising nearly six times its weight of water to the boiling point. He gives the volume of the steam as about 1800 times that of an equal weight of water.

The phenomena which accompany change of state, and the physical laws by which such changes are governed, are discussed in a series of special articles dealing with particular cases. The articles on FUSION and ALLOYS deal with the change from the solid to the liquid state, and the analogous case of solution is discussed in the article on SOLUTION. The articles on CONDENSATION OF GASES, LIQUID GASES and VAPORIZATION deal with the theory of the change of state from liquid to vapour, and with the important applications of liquid gases to other researches. The methods of measuring the latent heat of fusion or vaporization are described in the article CALORIMETRY, and need not be further discussed here except as an introduction to the history of the evolution of knowledge with regard to the nature of heat.

5. *Calorimetry by Latent Heat.*—In principle, the simplest and most direct method of measuring quantities of heat consists in observing the effects produced in melting a solid or vaporizing a liquid. It was, in fact, by the fusion of ice that quantities of heat were first measured. If a hot body is placed in a cavity in a block of ice at 0° C., and is covered by a closely fitting slab of ice, the quantity of ice melted will be directly proportional to the quantity of heat lost by the body in cooling to 0° C. None of the heat can possibly escape through the ice, and conversely no heat can possibly get in from outside. The body must cool exactly to 0° C., and every fraction of the heat it loses must melt an equivalent quantity of ice. Apart from heat lost in transferring the heated body to the ice block, the method is theoretically perfect. The only difficulty consists in the practical measurement of the quantity of ice melted. Black estimated this quantity by mopping out the cavity with a sponge before and after the operation. But there is a variable film of water adhering to the walls of the cavity, which gives trouble in accurate work. In 1780 Laplace and Lavoisier used a double-walled metallic vessel containing broken ice, which was in many respects more convenient than the block, but aggravated the difficulty of the film of water adhering to the ice. In spite of this practical difficulty, the quantity of heat required to melt unit weight of ice was for a long time taken as the unit of heat. This unit possesses the great advantage that it is independent of the scale of temperature adopted. At a much later date R. Bunsen (*Phil. Mag.*, 1871), adopting a suggestion of Sir John Herschel's, devised an ice-calorimeter suitable for measuring small quantities of heat, in which the difficulty of the water film was overcome by measuring the change in volume due to the melting of the ice. The volume of unit mass of ice is approximately 1.0950 times that of unit mass of water, so that the diminution of volume

is 0.009 of a cubic centimetre for each gramme of ice melted. The method requires careful attention to details of manipulation, which are more fully discussed in the article on CALORIMETRY.

For measuring large quantities of heat, such as those produced by the combustion of fuel in a boiler, the most convenient method is the evaporation of water, which is commonly employed by engineers for the purpose. The natural unit in this case is the quantity of heat required to evaporate unit mass of water at the boiling point under atmospheric pressure. In boilers working at a higher pressure, or supplied with water at a lower temperature, appropriate corrections are applied to deduce the quantity evaporated in terms of this unit.

For laboratory work on a small scale the converse method of condensation has been successfully applied by John Joly, in whose steam-calorimeter the quantity of heat required to raise the temperature of a body from the atmospheric temperature to that of steam condensing at atmospheric pressure is observed by weighing the mass of steam condensed on it. (See CALORIMETRY.)

6. *Thermometric Calorimetry.*—For the majority of purposes the most convenient and the most readily applicable method of measuring quantities of heat, is to observe the rise of temperature produced in a known mass of water contained in a suitable vessel or calorimeter. This method was employed from a very early date by Count Rumford and other investigators, and was brought to a high pitch of perfection by Regnault in his extensive calorimetric researches (*Mémoires de l'Institut de Paris*, 1847); but it is only within comparatively recent years that it has really been placed on a satisfactory basis by the accurate definition of the units involved. The theoretical objections to the method, as compared with latent heat calorimetry, are that some heat is necessarily lost by the calorimeter when its temperature is raised above that of the surroundings, and that some heat is used in heating the vessel containing the water. These are small corrections, which can be estimated with considerable accuracy in practice. A more serious difficulty, which has impaired the value of much careful work by this method, is that the quantity of heat required to raise the temperature of a given mass of water 1° C. depends on the temperature at which the water is taken, and also on the scale of the thermometer employed. It is for this reason, in many cases, impossible to say, at the present time, what was the precise value, within $\frac{1}{2}$ or even 1% of the heat unit, in terms of which many of the older results, such as those of Regnault, were expressed. For many purposes this would not be a serious matter, but for work of scientific precision such a limitation of accuracy would constitute a very serious bar to progress. The unit generally adopted for scientific purposes is the quantity of heat required to raise 1 gram (or kilogram) of water 1° C., and is called the calorie (or kilo-calorie). English engineers usually state results in terms of the British Thermal Unit (B.Th.U.), which is the quantity of heat required to raise 1 lb of water 1° F.

7. *Watt's Indicator Diagram; Work of Expansion.*—The rapid development of the steam-engine (*q.v.*) in England during the latter part of the 18th century had a marked effect on the progress of the science of heat. In the first steam-engines the working cylinder served both as boiler and condenser, a very wasteful method, as most of the heat was transferred directly from the fire to the condensing water without useful effect. The first improvement (about 1700) was to use a separate boiler, but the greater part of the steam supplied was still wasted in reheating the cylinder, which had been cooled by the injection of cold water to condense the steam after the previous stroke. In 1769 James Watt showed how to avoid this waste by using a separate condenser and keeping the cylinder as hot as possible. In his earlier engines the steam at full boiler pressure was allowed to raise the piston through nearly the whole of its stroke. Connexion with the boiler was then cut off, and the steam at full pressure was discharged into the condenser. Here again there was unnecessary waste, as the steam was still capable of doing useful work. He subsequently introduced "expansive working," which effected still further economy. The connexion

with the boiler was cut off when a fraction only, say $\frac{1}{2}$, of the stroke had been completed, the remainder of the stroke being effected by the expansion of the steam already in the cylinder with continually diminishing pressure. By the end of the stroke, when connexion was made to the condenser, the pressure was so reduced that there was comparatively little waste from this cause. Watt also devised an instrument called an *indicator* (see STEAM ENGINE), in which a pencil, moved up and down vertically by the steam pressure, recorded the pressure in the cylinder at every point of the stroke on a sheet of paper moving horizontally in time with the stroke of the piston. The diagram thus obtained made it possible to study what was happening inside the cylinder, and to deduce the work done by the steam in each stroke. The method of the indicator diagram has since proved of great utility in physics in studying the properties of gases and vapours. The work done, or the useful effect obtained from an engine or any kind of machine, is measured by the product of the resistance overcome and the distance through which it is overcome. The result is generally expressed in terms of the equivalent weight raised through a certain height against the force of gravity.¹ If, for instance, the pressure on a piston

¹ *Units of Work, Energy and Power.*—In English-speaking countries work is generally measured in *foot-pounds*. Elsewhere it is generally measured in *kilogrammetres*, or in terms of the work done in raising 1 kilogramme weight through the height of 1 metre. In the middle of the 19th century the terms "force" and "motive power" were commonly employed in the sense of "power of doing work." The term "energy" is now employed in this sense. A quantity of energy is measured by the work it is capable of performing. A body may possess energy in virtue of its state (gas or steam under pressure), or in virtue of its position (a raised weight), or in various other ways, when at rest. In these cases it is said to possess *potential energy*. It may also possess energy in virtue of its motion or rotation (as a fly-wheel or a cannon-ball). In this case it is said to possess *kinetic energy*, or energy of motion. In many cases the energy (as in the case of a vibrating body, like a pendulum) is partly kinetic and partly potential, and changes continually from one to the other throughout the motion. For instance, the energy of a pendulum is wholly potential when it is momentarily at rest at the top of its swing, but is wholly kinetic when the pendulum is moving with its maximum velocity at the lowest point of its swing. The whole energy at any moment is the sum of the potential and kinetic energy, and this sum remains constant so long as the amplitude of the vibration remains the same. The potential energy of a weight W lb raised to a height h ft. above the earth, is Wh foot-pounds. If allowed to fall freely, without doing work, its kinetic energy on reaching the earth would be Wh foot-pounds, and its velocity of motion would be such that if projected upwards with the same velocity it would rise to the height h from which it fell. We have here a simple and familiar case of the conversion of one kind of energy into a different kind. But the two kinds of energy are mechanically equivalent, and they can both be measured in terms of the same units. The units already considered, namely foot-pounds or kilogrammetres, are gravitational units, depending on the force of gravity. This is the most obvious and natural method of measuring the potential energy of a raised weight, but it has the disadvantage of varying with the force of gravity at different places. The natural measure of the kinetic energy of a moving body is the product of its mass by half the square of its velocity, which gives a measure in kinetic or absolute units independent of the force of gravity. Kinetic and gravitational units are merely different ways of measuring the same thing. Just as foot-pounds may be reduced to kilogrammetres by dividing by the number of foot-pounds in one kilogrammetre, so kinetic may be reduced to gravitational units by dividing by the kinetic measure of the intensity of gravity, namely, the work in kinetic units done by the weight of unit mass acting through unit distance. For scientific purposes, it is necessary to take account of the variation of gravity. The scientific unit of energy is called the *erg*. The erg is the kinetic energy of a mass of 2 gm. moving with a velocity of 1 cm. per sec. The work in ergs done by a force acting through a distance of 1 cm. is the absolute measure of the force. A force equal to the weight of 1 gm. (in England) acting through a distance of 1 cm. does 981 ergs of work. A force equal to the weight of 1000 gm. (1 kilogramme) acting through a distance of 1 metre (100 cm.) does 98.1 million ergs of work. As the erg is a very small unit, for many purposes, a unit equal to 10 million ergs, called a *joule*, is employed. In England, where the weight of 1 gm. is 981 ergs per cm., a foot-pound is equal to 1,356 joules, and a kilogrammetre is equal to 9.81 joules.

The term *power* is now generally restricted to mean "rate of working." Watt estimated that an average horse was capable of raising 550 lb 1 ft. in each second, or doing work at the rate of 550 foot-pounds per second, or 33,000 foot-pounds per minute. This conventional horse-power is the unit commonly employed for estimating

is 50 lb per sq. in., and the area of the piston is 100 sq. in., the force on the piston is 5000 lb weight. If the stroke of the piston is 1 ft., the work done per stroke is capable of raising a weight of 5000 lb through a height of 1 ft., or 50 lb through a height of 100 ft. and so on.

Fig. 3 represents an imaginary indicator diagram for a steam-engine, taken from one of Watt's patents. Steam is admitted to the cylinder when the piston is at the beginning of its stroke, at S. ST represents the length of the stroke or the limit of horizontal movement of the paper on which the diagram is drawn. The indicating pencil rises to the point A, representing the absolute pressure of 60 lb per sq. in. As the piston moves outwards the pencil traces

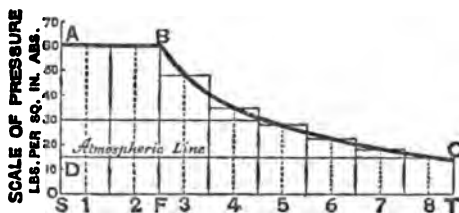

Fig. 3.—Watt's Indicator Diagram. Patent of 1782.

the horizontal line AB, the pressure remaining constant till the point B is reached, at which connexion to the boiler is cut off. The work done so far is represented by the area of the rectangle ABSF, namely $AS \times SF$, multiplied by the area of the piston in sq. in. The result is in foot-pounds if the fraction of the stroke SF is taken in feet. After cut-off at B the steam expands under diminishing pressure, and the pencil falls gradually from B to C, following the steam pressure until the exhaust valve opens at the end of the stroke. The pressure then falls rapidly to that of the condenser, which for an ideal case may be taken as zero, following Watt. The work done during expansion is found by dividing the remainder of the stroke FT into a number of equal parts (say 8, Watt takes 20) and measuring the pressure at the points 1, 2, 3, 4, &c., corresponding to the middle of each. We thus obtain a number of small rectangles, the sum of which is evidently very nearly equal to the whole area BCFT under the expansion curve, or to the remainder of the stroke FT multiplied by the average or mean value of the pressure. The whole work done in the forward stroke is represented by the area ABCTSA, or by the average value of the pressure P over the whole stroke multiplied by the stroke L. This area must be multiplied by the area of the piston A in sq. in. as before, to get the work done per stroke in foot-pounds, which is PLA. If the engine repeats this cycle N times per minute, the work done per minute is PLAN foot-pounds, which is reduced to horse-power by dividing by 33,000. If the steam is ejected by the piston at atmospheric pressure (15 lb per sq. in.) instead of being condensed at zero pressure, the area CDST under the atmospheric line CD, representing work done against back-pressure on the return stroke must be subtracted. If the engine repeats the same cycle or series of operations continuously, the indicator diagram will be a closed curve, and the net work done per cycle will be represented by the included area, whatever the form of the curve.

8. Thermal Efficiency.—The thermal efficiency of an engine is the ratio of the work done by the engine to the heat supplied to it. According to Watt's observations, confirmed later by Clément and Désormes, the total heat required to produce 1 lb of saturated steam at any temperature from water at 60° C. was approximately 650 times the quantity of heat required to raise 1 lb of water 1° C. Since 1 lb of steam represented on this assumption a certain quantity of heat, the efficiency could be measured naturally in foot-pounds of work obtainable per lb of steam, or conversely in pounds of steam consumed per horse-power-hour.

In his patent of 1782 Watt gives the following example of the improvement in thermal efficiency obtained by expansive work—the power of engines. The *horse-power-hour*, or the work done by one horse-power in one hour, is nearly 2 million foot-pounds. For electrical and scientific purposes the unit of power employed is called the *watt*. The watt is the work per second done by an electromotive force of 1 volt in driving a current of 1 ampere, and is equal to 10 million ergs or 1 joule per second. One horse-power is 746 watts or nearly $\frac{1}{3}$ of a kilowatt. The *kilowatt-hour*, which is the unit by which electrical energy is sold, is 3.6 million joules or 2.65 million foot-pounds, or 366,000 kilogrammetres, and is capable of raising nearly 19 lb of water from the freezing to the boiling point.

Taking the diagram already given, if the quantity of steam represented by AB, or 300 cub. in. at 60 lb pressure, were employed without expansion, the work realized, represented by the area ABSF, would be $6000/4 = 1500$ foot-pounds. With expansion to 4 times its original volume, as shown in the diagram by the whole area ABCTSA, the mean pressure (as calculated by Watt, assuming Boyle's law) would be 0.58 of the original pressure, and the work done would be $6000 \times 0.58 = 3480$ foot-pounds for the same quantity of steam, or the thermal efficiency would be 2.32 times greater. The advantage actually obtained would not be so great as this, on account of losses by condensation, back-pressure, &c., which are neglected in Watt's calculation, but the margin would still be very considerable. Three hundred cub. in. of steam at 60 lb pressure would represent about 0.245 of 1 lb of steam, or 28.7 B.Th.U., so that, neglecting all losses, the possible thermal efficiency attainable with steam at this pressure and four expansions ($\frac{1}{4}$ cut-off) would be $3480/28.7$, or 121 foot-pounds per B.Th.U. At a later date, about 1820, it was usual to include the efficiency of the boiler with that of the engine, and to reckon the efficiency or "duty" in foot-pounds per bushel or cwt. of coal. The best Cornish pumping-engines of that date achieved about 70 million foot-pounds per cwt., or consumed about 3.2 lb per horse-power-hour, which is roughly equivalent to 43 foot-pounds per B.Th.U. The efficiency gradually increased as higher pressures were used, with more complete expansion, but the conditions upon which the efficiency depended were not fully worked out till a much later date. Much additional knowledge with regard to the nature of heat, and the properties of gases and vapours, was required before the problem could be attacked theoretically.

9. Of the Nature of Heat.—In the early days of the science it was natural to ascribe the manifestations of heat to the action of a subtle imponderable fluid called "caloric," with the power of penetrating, expanding and dissolving bodies, or dissipating them in vapour. The fluid was imponderable, because the most careful experiments failed to show that heat produced any increase in weight. The opposite property of levitation was often ascribed to heat, but it was shown by more cautious investigators that the apparent loss of weight due to heating was to be attributed to evaporation or to upward air currents. The fundamental idea of an imaginary fluid to represent heat was useful as helping the mind to a conception of something remaining invariable in quantity through many transformations, but in some respects the analogy was misleading, and tended greatly to retard the progress of science. The caloric theory was very simple in its application to the majority of calorimetric experiments, and gave a fair account of the elementary phenomena of change of state, but it encountered serious difficulties in explaining the production of heat by friction, or the changes of temperature accompanying the compression or expansion of a gas. The explanation which the calorists offered of the production of heat by friction or compression was that some of the latent caloric was squeezed or ground out of the bodies concerned and became "sensible." In the case of heat developed by friction, they supposed that the abraded portions of the material were capable of holding a smaller quantity of heat, or had less "capacity for heat," than the original material. From a logical point of view, this was a perfectly tenable hypothesis, and one difficult to refute. It was easy to account in this way for the heat produced in boring cannon and similar operations, where the amount of abraded material was large. To refute this explanation, Rumford (*Phil. Trans.*, 1798) made his celebrated experiments with a blunt borer, in one of which he succeeded in boiling by friction 26.5 lb of cold water in 2½ hours, with the production of only 4145 grains of metallic powder. He then showed by experiment that the metallic powder required the same amount of heat to raise its temperature 1° , as an equal weight of the original metal, or that its "capacity for heat" (in this sense) was unaltered by reducing it to powder; and he argued that "in any case so small a quantity of powder could not possibly account for all the heat generated, that the supply of heat appeared to be inexhaustible,

and that heat could not be a material substance, but must be something of the nature of motion." Unfortunately Rumford's argument was not quite conclusive. The supporters of the caloric theory appear, whether consciously or unconsciously, to have used the phrase "capacity for heat" in two entirely distinct senses without any clear definition of the difference. The phrase "capacity for heat" might very naturally denote the total quantity of heat contained in a body, which we have no means of measuring, but it was generally used to signify the quantity of heat required to raise the temperature of a body one degree, which is quite a different thing, and has no necessary relation to the total heat. In proving that the powder and the solid metal required the same quantity of heat to raise the temperature of equal masses of either one degree, Rumford did not prove that they contained equal quantities of heat, which was the real point at issue in this instance. The metal tin actually changes into powder below a certain temperature, and in so doing evolves a measurable quantity of heat. A mixture of the gases oxygen and hydrogen, in the proportions in which they combine to form water, evolves when burnt sufficient heat to raise more than thirty times its weight of water from the freezing to the boiling point; and the mixture of gases may, in this sense, be said to contain so much more heat than the water, although its capacity for heat in the ordinary sense is only about half that of the water produced. To complete the refutation of the calorists' explanation of the heat produced by friction, it would have been necessary for Rumford to show that the powder when reconverted into the same state as the solid metal did not absorb a quantity of heat equivalent to that evolved in the grinding; in other words that the heat produced by friction was not simply that due to the change of state of the metal from solid to powder.

Shortly afterwards, in 1799, Davy¹ described an experiment in which he melted ice by rubbing two blocks together. This experiment afforded a very direct refutation of the calorists' view, because it was a well-known fact that ice required to have a quantity of heat added to it to convert it into water, so that the water produced by the friction contained more heat than the ice. In stating as the conclusion to be drawn from this experiment that "friction consequently does not diminish the capacity of bodies for heat," Davy apparently uses the phrase capacity for heat in the sense of total heat contained in a body, because in a later section of the same essay he definitely gives the phrase this meaning, and uses the term "capability of temperature" to denote what we now term capacity for heat.

The delay in the overthrow of the caloric theory, and in the acceptance of the view that heat is a mode of motion, was no doubt partly due to some fundamental confusion of ideas in the use of the term "capacity for heat" and similar phrases. A still greater obstacle lay in the comparative vagueness of the motion or vibration theory. Davy speaks of heat as being "repulsive motion," and distinguishes it from light, which is "projective motion"; though heat is certainly not a substance—according to Davy in the essay under discussion—and may not even be treated as an imponderable fluid, light as certainly is a material substance, and is capable of forming chemical compounds with ordinary matter, such as oxygen gas, which is not a simple substance, but a compound, termed phos oxygen, of light and oxygen. Accepting the conclusions of Davy and Rumford that heat is not a material substance but a mode of motion, there still remains the question, what definite conception is to be attached to a quantity of heat? What do we mean by a quantity of vibratory motion, how is the quantity of motion to be estimated, and why should it remain invariable in many transformations? The idea that heat was a "mode of motion" was applicable as a qualitative explanation of many of the effects of heat, but it lacked the quantitative precision of a scientific statement, and could not be applied to the calculation and prediction of definite results. The state of science at the time of Rumford's and Davy's experiments did not admit of a

¹ In an essay on "Heat, Light, and Combinations of Light," republished in Sir H. Davy's *Collected Works*, ii. (London, 1836).

more exact generalization. The way was paved in the first instance by a more complete study of the laws of gases, to which Laplace, Dalton, Gay-Lussac, Dulong and many others contributed both on the experimental and theoretical side. Although the development proceeded simultaneously along many parallel lines, it is interesting and instructive to take the investigation of the properties of gases, and to endeavour to trace the steps by which the true theory was finally attained.

10. *Thermal Properties of Gases.*—The most characteristic property of a gaseous or elastic fluid, namely, the elasticity, or resistance to compression, was first investigated scientifically by Robert Boyle (1662), who showed that the pressure p of a given mass of gas varied inversely as the volume v , provided that the temperature remained constant. This is generally expressed by the formula $pv = C$, where C is a constant for any given temperature, and v is taken to represent the specific volume, or the volume of unit mass, of the gas at the given pressure and temperature. Boyle was well aware of the effect of heat in expanding a gas, but he was unable to investigate this properly as no thermometric scale had been defined at that date. According to Boyle's law, when a mass of gas is compressed by a small amount at constant temperature, the percentage increase of pressure is equal to the percentage diminution of volume (if the compression is $v/100$, the increase of pressure is very nearly $p/100$). Adopting this law, Newton showed, by a most ingenious piece of reasoning (*Principia*, ii., sect. 8), that the velocity of sound in air should be equal to the velocity acquired by a body falling under gravity through a distance equal to half the height of the atmosphere, considered as being of uniform density equal to that at the surface of the earth. This gave the result 918 ft. per sec. (280 metres per sec.) for the velocity at the freezing point. Newton was aware that the actual velocity of sound was somewhat greater than this, but supposed that the difference might be due in some way to the size of the air particles, of which no account could be taken in the calculation. The first accurate measurement of the velocity of sound by the French Académie des Sciences in 1738 gave the value 332 metres per sec. as the velocity at 0° C. The true explanation of the discrepancy was not discovered till nearly 100 years later.

The law of expansion of gases with change of temperature was investigated by Dalton and Gay-Lussac (1802), who found that the volume of a gas under constant pressure increased by $1/267$ th part of its volume at 0° C. for each 1° C. rise in temperature. This value was generally assumed in all calculations for nearly 50 years. More exact researches, especially those of Regnault, at a later date, showed that the law was very nearly correct for all permanent gases, but that the value of the coefficient should be $1/273$ rd. According to this law the volume of a gas at any temperature t ° C. should be proportional to $273+t$, i.e. to the temperature reckoned from a zero 273° below that of the Centigrade scale, which was called the absolute zero of the gas thermometer. If $T = 273+t$, denotes the temperature measured from this zero, the law of expansion of a gas may be combined with Boyle's law in the simple formula

$$pv = RT \quad (1)$$

which is generally taken as the expression of the gaseous laws. If equal volumes of different gases are taken at the same temperature and pressure, it follows that the constant R is the same for all gases. If equal masses are taken, the value of the constant R for different gases varies inversely as the molecular weight or as the density relative to hydrogen.

Dalton also investigated the laws of vapours, and of mixtures of gases and vapours. He found that condensable vapours approximately followed Boyle's law when compressed, until the condensation pressure was reached, at which the vapour liquefied without further increase of pressure. He found that when a liquid was introduced into a closed space, and allowed to evaporate until the space was saturated with the vapour and evaporation ceased, the increase of pressure in the space was equal to the condensation pressure of the vapour, and did not depend on the volume of the space or the presence of any other gas or vapour

provided that there was no solution or chemical action. He showed that the condensation or saturation-pressure of a vapour depended only on the temperature, and increased by nearly the same fraction of itself per degree rise of temperature, and that the pressures of different vapours were nearly the same at equal distances from their boiling points. The increase of pressure per degree C. at the boiling point was about $\frac{1}{14}$ th of 760 mm. or 27.2 mm., but increased in geometrical progression with rise of temperature. These results of Dalton's were confirmed, and in part corrected, as regards increase of vapour-pressure, by Gay-Lussac, Dulong, Regnault and other investigators, but were found to be as close an approximation to the truth as could be obtained with such simple expressions. More accurate, empirical expressions for the increase of vapour-pressure of a liquid with temperature were soon obtained by Thomas Young, J. P. L. A. Roche and others, but the explanation of the relation was not arrived at until a much later date (see VAPORIZATION).

11. *Specific Heats of Gases.*—In order to estimate the quantities of heat concerned in experiments with gases, it was necessary in the first instance to measure their specific heats, which presented formidable difficulties. The earlier attempts by Lavoisier and others, employing the ordinary methods of calorimetry, gave very uncertain and discordant results, which were not regarded with any confidence even by the experimentalists themselves. Gay-Lussac (*Mémoires d'Arcueil*, 1807) devised an ingenious experiment, which, though misinterpreted at the time, is very interesting and instructive. With the object of comparing the specific heats of different gases, he took two equal globes A and B connected by a tube with a stop-cock. The globe B was exhausted, the other A being filled with gas. On opening the tap between the vessels, the gas flowed from A to B and the pressure was rapidly equalized. He observed that the fall of temperature in A was nearly equal to the rise of temperature in B, and that for the same initial pressure the change of temperature was very nearly the same for all the gases he tried, except hydrogen, which showed greater changes of temperature than other gases. He concluded from this experiment that equal volumes of gases had the same capacity for heat, except hydrogen, which he supposed to have a larger capacity, because it showed a greater effect. The method does not in reality afford any direct information with regard to the specific heats, and the conclusion with regard to hydrogen is evidently wrong. At a later date (*Ann. de Chim.*, 1812, 81, p. 98) Gay-Lussac adopted A. Crawford's method of mixture, allowing two equal streams of different gases, one heated and the other cooled about 20° C., to mix in a tube containing a thermometer. The resulting temperature was in all cases nearly the mean of the two, from which he concluded that equal volumes of all the gases tried, namely, hydrogen, carbon dioxide, air, oxygen and nitrogen, had the same thermal capacity. This was correct, except as regards carbon dioxide, but did not give any information as to the actual specific heats referred to water or any known substance. About the same time, F. Delaroché and J. E. Bérard (*Ann. de chim.*, 1813, 85, p. 72) made direct determinations of the specific heats of air, oxygen, hydrogen, carbon monoxide, carbon dioxide, nitrous oxide and ethylene, by passing a stream of gas heated to nearly 100° C. through a spiral tube in a calorimeter containing water. Their work was a great advance on previous attempts, and gave the first trustworthy results. With the exception of hydrogen, which presents peculiar difficulties, they found that equal volumes of the permanent gases, air, oxygen and carbon monoxide, had nearly the same thermal capacity, but that the compound condensable gases, carbon dioxide, nitrous oxide and ethylene, had larger thermal capacities in the order given. They were unable to state whether the specific heats of the gases increased or diminished with temperature, but from experiments on air at pressures of 740 mm. and 1000 mm., they found the specific heats to be .269 and .245 respectively, and concluded that the specific heat diminished with increase of pressure. The difference they observed was really due to errors of experiment, but they regarded it as proving beyond doubt the truth of the calorists' contention that the heat disengaged on the

compression of a gas was due to the diminution of its thermal capacity.

Dalton and others had endeavoured to measure directly the rise of temperature produced by the compression of a gas. Dalton had observed a rise of 50° F. in a gas when suddenly compressed to half its volume, but no thermometers at that time were sufficiently sensitive to indicate more than a fraction of the change of temperature. Laplace was the first to see in this phenomenon the probable explanation of the discrepancy between Newton's calculation of the velocity of sound and the observed value. The increase of pressure due to a sudden compression, in which no heat was allowed to escape, or as we now call it an "adiabatic" compression, would necessarily be greater than the increase of pressure in a slow isothermal compression, on account of the rise of temperature. As the rapid compressions and rarefactions occurring in the propagation of a sound wave were perfectly adiabatic, it was necessary to take account of the rise of temperature due to compression in calculating the velocity. To reconcile the observed and calculated values of the velocity, the increase of pressure in adiabatic compression must be 1.410 times greater than in isothermal compression. This is the ratio of the adiabatic elasticity of air to the isothermal elasticity. It was a long time, however, before Laplace saw his way to any direct experimental verification of the value of this ratio. At a later date (*Ann. de chim.*, 1816, 3, p. 238) he stated that he had succeeded in proving that the ratio in question must be the same as the ratio of the specific heat of air at constant pressure to the specific heat at constant volume.

In the method of measuring the specific heat adopted by Delaroché and Bérard, the gas under experiment, while passing through a tube at practically constant pressure, contracts in cooling, as it gives up its heat to the calorimeter. Part of the heat surrendered to the calorimeter is due to the contraction of volume. If a gramme of gas at pressure p , volume v and temperature T abs. is heated 1° C. at constant pressure p , it absorbs a quantity of heat $S = 2.38$ calories (according to Regnault) the specific heat at constant pressure. At the same time the gas expands by a fraction $1/T$ of v , which is the same as $1/273$ of its volume at 0° C. If now the air is suddenly compressed by an amount v/T , it will be restored to its original volume, and its temperature will be raised by the liberation of a quantity of heat R' , the latent heat of expansion for an increase of volume v/T . If no heat has been allowed to escape, the air will now be in the same state as if a quantity of heat S had been communicated to it at its original volume v without expansion. The rise of temperature above the original temperature T will be S/γ degrees, where γ is the specific heat at constant volume, which is obviously equal to $S - R'$. Since p/T is the increase of pressure for 1° C. rise of temperature at constant volume, the increase of pressure for a rise of S/γ degrees will be $\gamma p/T$, where γ is the ratio S/s . But this is the rise of pressure produced by a sudden compression v/T , and is seen to be γ times the rise of pressure p/T produced by the same compression at constant temperature. The ratio of the adiabatic to the isothermal elasticity, required for calculating the velocity of sound, is therefore the same as the ratio of the specific heat at constant pressure to that at constant volume.

12. *Experimental Verification of the Ratio of Specific Heats.*—This was a most interesting and important theoretical relation to discover, but unfortunately it did not help much in the determination of the ratio required, because it was not practically possible at that time to measure the specific heat of air at constant volume in a closed vessel. Attempts had been made to do this, but they had signally failed, on account of the small heat capacity of the gas as compared with the containing vessel. Laplace endeavoured to extract some confirmation of his views from the values given by Delaroché and Bérard for the specific heat of air at 1000 and 740 mm. pressure. On the assumption that the quantities of heat contained in a given mass of air increased in direct proportion to its volume when heated at constant pressure, he deduced, by some rather obscure reasoning, that the ratio of the specific heats S and s should be about 1.5 to 1, which he regarded as a fairly satisfactory agreement with the value $\gamma = 1.41$ deduced from the velocity of sound.

The ratio of the specific heats could not be directly measured, but a few years later, Clément and Désormes (*Journ. de Phys.*, Nov. 1819) succeeded in making a direct measurement of the ratio of the elasticities in a very simple manner. They took a large globe containing air at atmospheric pressure and temperature, and removed a small quantity of air. They then observed the defect of pressure p_0 when the air had regained its original temperature. By suddenly opening the globe, and immediately closing it, the pressure was restored almost instantaneously to the atmospheric, the rise of pressure p_0 corresponding to the sudden compression produced. The air, having been heated by the compression, was

allowed to regain its original temperature, the tap remaining closed, and the final defect of pressure p' was noted. The change of pressure for the same compression performed isothermally is then $p_0 - p'$. The ratio $p_0/(p_0 - p')$ is the ratio of the adiabatic and isothermal elasticities, provided that p_0 is small compared with the whole atmospheric pressure. In this way they found the ratio 1.354, which is not much smaller than the value 1.410 required to reconcile the observed and calculated values of the velocity of sound. Gay-Lussac and J. J. Welter (*Ann. de chim.*, 1822) repeated the experiment with slight improvements, using expansion instead of compression, and found the ratio 1.375. The experiment has often been repeated since that time, and there is no doubt that the value of the ratio deduced from the velocity of sound is correct, the defect of the value obtained by direct experiment being due to the fact that the compression or expansion is not perfectly adiabatic. Gay-Lussac and Welter found the ratio practically constant for a range of pressure 144 to 1460 mm., and for a range of temperature from -20° to $+40^\circ$ C. The velocity of sound at Quito, at a pressure of 544 mm. was found to be the same as at Paris at 760 mm. at the same temperature. Assuming on this evidence the constancy of the ratio of the specific heats of air, Laplace (*Mécanique céleste*, v. 143) showed that, if the specific heat at constant pressure was independent of the temperature, the specific heat per unit volume at a pressure p must vary as $p^{1/\gamma}$, according to the caloric theory. The specific

heat per unit mass must then vary as $p^{1/\gamma - 1}$, which he found agreed precisely with the experiment of Delaroche and Bérard already cited. This was undoubtedly a strong confirmation of the caloric theory. Poisson by the same assumptions (*Ann. de chim.*, 1823, 23, p. 337) obtained the same results, and also showed that the relation between the pressure and the volume of a gas in adiabatic compression or expansion must be of the form $pV^\gamma = \text{constant}$.

P. L. Dulong (*Ann. de chim.*, 1809, 41, p. 156), adopting a method due to E. F. Chladni, compared the velocities of sound in different gases by observing the pitch of the note given by the same tube when filled with the gases in question. He thus obtained the values of the ratios of the elasticities or of the specific heats for the gases employed. For oxygen, hydrogen and carbonic oxide, these ratios were the same as for air. But for carbonic acid, nitrous oxide and olefiant gas, the values were much smaller, showing that these gases experienced a smaller change of temperature in compression. On comparing his results with the values of the specific heats for the same gases found by Delaroche and Bérard, Dulong observed that the changes of temperature for the same compression were in the inverse ratio of the specific heats at constant volume, and deduced the important conclusion that "Equal volumes of all gases under the same conditions evolve on compression the same quantity of heat." This is equivalent to the statement that the difference of the specific heats, or the latent heat of expansion R' per 1° , is the same for all gases if equal volumes are taken. Assuming the ratio $\gamma = 1.410$, and taking Delaroche and Bérard's value for the specific heat of air at constant pressure $S = .267$, we have $s = S/1.41 = .189$, and the difference of the specific heats per unit mass of air $S - s = R' = .078$. Adopting Regnault's value of the specific heat of air, namely, $S = .238$, we should have $S - s = .069$. This quantity represents the heat absorbed by unit mass of air in expanding at constant temperature T by a fraction $1/T$ of its volume v , or by $v/1,174$ of its volume 0° C.

If, instead of taking unit mass, we take a volume $v_0 = 22.39$ litres at 0° C. and 760 mm. being the volume of the molecular weight of the gas in grammes, the quantity of heat evolved by a compression equal to v/T will be approximately 2 calories, and is the same for all gases. The work done in this compression is $p_0 v/T = R$, and is also the same for all gases, namely, 8.3 joules. Dulong's experimental result, therefore, shows that the heat evolved in the compression of a gas is proportional to the work done. This result had previously been deduced theoretically by Carnot (1824). At a later date it was assumed by Mayer, Clausius and others, on the evidence of these experiments, that the heat evolved was not merely proportional to the work done, but was equivalent to it. The further experimental evidence required to justify this assumption was first supplied by Joule.

Latent heat of expansion $R' = .069$ calorie per gramme of air, per 1° C.
 $= 2.0$ calories per gramme-molecule of any gas.

Work done in expansion $R = .267$ joule per gramme of air per 1° C.
 $= 8.3$ joules per gramme-molecule of any gas.

13. *Carnot: On the Motive Power of Heat*—A practical and theoretical question of the greatest importance was first answered by Sadi Carnot about this time in his *Reflections on the Motive Power of Heat* (1824). How much motive power (defined by Carnot as weight lifted through a certain height) can be obtained from heat alone by means of an engine repeating a regular success-

ion or "cycle" of operations continuously? Is the efficiency limited, and, if so, how is it limited? Are other agents preferable to steam for developing motive power from heat? In discussing this problem, we cannot do better than follow Carnot's reasoning which, in its main features, could hardly be improved at the present day.

Carnot points out that in order to obtain an answer to this question, it is necessary to consider the essential conditions of the process, apart from the mechanism of the engine and the working substance or agent employed. Work cannot be said to be produced from heat alone unless nothing but heat is supplied, and the working substance and all parts of the engine are at the end of the process in precisely the same state as at the beginning.¹

Carnot's Axiom.—Carnot here, and throughout his reasoning, makes a fundamental assumption, which he states as follows: "When a body has undergone any changes and after a certain number of transformations is brought back identically to its original state, considered relatively to density, temperature and mode of aggregation, it must contain the same quantity of heat as it contained originally."²

Heat, according to Carnot, in the type of engine we are considering, can evidently be a cause of motive power only by virtue of changes of volume or form produced by alternate heating and cooling. This involves the existence of cold and hot bodies to act as boiler and condenser, or source and sink of heat, respectively. Wherever there exists a difference of temperature, it is possible to have the production of motive power from heat; and conversely, production of motive power, from heat alone, is impossible without difference of temperature. In other words the production of motive power from heat is not merely a question of the consumption of heat, but always requires transference of heat from hot to cold. What then are the conditions which enable the difference of temperature to be most advantageously employed in the production of motive power, and how much motive power can be obtained with a given difference of temperature from a given quantity of heat?

Carnot's Rule for Maximum Effect.—In order to realize the maximum effect, it is necessary that, in the process employed, there should not be any direct interchange of heat between bodies at different temperatures. Direct transference of heat by conduction or radiation between bodies at different temperatures is equivalent to wasting a difference of temperature which might have been utilized to produce motive power. The working substance must throughout every stage of the process be in equilibrium with itself (i.e. at uniform temperature and pressure) and also with external bodies, such as the boiler and condenser, at such times as it is put in communication with them. In the actual engine there is always some interchange of heat between the steam and the cylinder, and some loss of heat to external bodies. There may also be some difference of temperature between the boiler steam and the cylinder on admission, or between the waste steam and the condenser at release. These differences represent losses of efficiency which may be reduced indefinitely, at least in imagination, by suitable means, and designers had even at that date been very successful in reducing

¹ For instance a mass of compressed air, if allowed to expand in a cylinder at the ordinary temperature, will do work, and will at the same time absorb a quantity of heat which, as we now know, is the thermal equivalent of the work done. But this work cannot be said to have been produced solely from the heat absorbed in the process, because the air at the end of the process is in a changed condition, and could not be restored to its original state at the same temperature without having work done upon it precisely equal to that obtained by its expansion. The process could not be repeated indefinitely without a continual supply of compressed air. The source of the work in this case is work previously done in compressing the air, and no part of the work is really generated at the expense of heat alone, unless the compression is effected at a lower temperature than the expansion.

² Clausius (*Pogg Ann.* 70, p. 369) and others have misinterpreted this assumption, and have taken it to mean that the quantity of heat required to produce any given change of state is independent of the manner in which the change is effected, which Carnot does not here assume.

them. All such losses are supposed to be absent in deducing the ideal limit of efficiency, beyond which it would be impossible to go.

14. *Carnot's Description of his Ideal Cycle.*—Carnot first gives a rough illustration of an incomplete cycle, using steam much in the same way as it is employed in an ordinary steam-engine. After expansion down to condenser pressure the steam is completely condensed to water, and is then returned as cold water to the hot boiler. He points out that the last step does not conform exactly to the condition he laid down, because although the water is restored to its initial state, there is direct passage of heat from a hot body to a cold body in the last process. He points out that this difficulty might be overcome by supposing the difference of temperature small, and by employing a series of engines, each working through a small range, to cover a finite interval of temperature. Having established the general notions of a perfect cycle, he proceeds to give a more exact illustration, employing a gas as the working substance. He takes as the basis of his demonstration the well-established experimental fact that a gas is heated by rapid compression and cooled by rapid expansion, and that if compressed or expanded slowly in contact with conducting bodies, the gas will give out heat in compression or absorb heat in expansion while its temperature remains constant. He then goes on to say:—

"This preliminary notion being settled, let us imagine an elastic fluid, atmospheric air for example, enclosed in a cylinder *abcd*, fig. 4, fitted with a movable diaphragm or piston *cd*. Let there also be two bodies A, B, each maintained at a constant temperature, that of A being more elevated than that of B. Let us now suppose the following series of operations to be performed:—

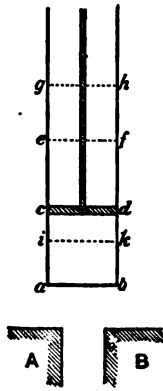

FIG. 4.
Carnot's Cylinder.

"1. Contact of the body A with the air contained in the space *abcd*, or with the bottom of the cylinder, which we will suppose to transmit heat easily. The air is now at the temperature of the body A, and *cd* is the actual position of the piston.

"2. The piston is gradually raised, and takes the position *ef*. The air remains in contact with the body A, and is thereby maintained at a constant temperature during the expansion. The body A furnishes the heat necessary to maintain the constancy of temperature.

"3. The body A is removed, and the air no longer being in contact with any body capable of giving it heat, the piston continues nevertheless to rise, and passes from the position *ef* to *gh*. The air expands without receiving heat and its temperature falls. Let us imagine that it falls until it is just equal to that of the body B. At this moment the piston is stopped and occupies the position *gh*.

"4. The air is placed in contact with the body B; it is compressed by the return of the piston, which is brought from the position *gh* to the position *cd*. The air remains meanwhile at a constant temperature, because of its contact with the body B to which it gives up its heat.

"5. The body B is removed, and the compression of the air is continued. The air being now isolated, rises in temperature. The compression is continued until the air has acquired the temperature of the body A. The piston passes meanwhile from the position *cd* to the position *ik*.

"6. The air is replaced in contact with the body A, and the piston returns from the position *ik* to the position *ef*, the temperature remaining invariable.

"7. The period described under (3) is repeated, then successively the periods (4), (5), (6); (3), (4), (5), (6); (3), (4), (5), (6); and so on.

"During these operations the air enclosed in the cylinder exerts an effort more or less great on the piston. The pressure of the air varies both on account of changes of volume and on account of changes of temperature; but it should be observed that for equal volumes, that is to say, for like positions of the piston, the temperature is higher during the dilatation than during the compression. Since the pressure is greater during the expansion, the quantity of motive power produced by the dilatation is greater than that consumed by the compression. We shall thus obtain a balance of motive power, which may be employed for any purpose. The air has served as working substance in a heat-engine; it has also been employed in the most advantageous manner possible, since no useless re-establishment of the equilibrium of heat has been allowed to occur.

"All the operations above described may be executed in the reverse order and direction. Let us imagine that after the sixth period, that is to say, when the piston has reached the position *ef*, we make it return to the position *ik*, and that at the same time we keep the air in contact with the hot body A; the heat furnished by this body during the sixth period will return to its source, that is, to the body A, and everything will be as it was at the end of the fifth period. If now we remove the body A, and if we make the piston move from *ik* to *cd*, the temperature of the air will decrease by just as many degrees as it increased during the fifth period, and will become that of the body B. We can evidently continue in this way a series of operations the exact reverse of those which were previously described, it suffices to place oneself in the same circumstances and to execute for each period a movement of expansion in place of a movement of compression, and vice versa.

"The result of the first series of operations was the production of a certain quantity of motive power, and the transport of heat from the body A to the body B; the result of the reverse operations is the consumption of the motive power produced in the first case, and the return of heat from the body B to the body A, in such sort that these two series of operations annul and neutralize each other.

"The impossibility of producing by the agency of heat alone a quantity of motive power greater than that which we have obtained in our first series of operations is now easy to prove. It is demonstrated by reasoning exactly similar to that which we have already given. The reasoning will have in this case a greater degree of exactitude; the air of which we made use to develop the motive power is brought back at the end of each cycle of operations precisely to its initial state, whereas this was not quite exactly the case for the vapour of water, as we have already remarked."

15. *Proof of Carnot's Principle.*—Carnot considered the proof too obvious to be worth repeating, but, unfortunately, his previous demonstration, referring to an incomplete cycle, is not so exactly worded that exception cannot be taken to it. We will therefore repeat his proof in a slightly more definite and exact form. Suppose that a reversible engine R, working in the cycle above described, takes a quantity of heat *H* from the source in each cycle, and performs a quantity of useful work *W*. If it were possible for any other engine S, working with the same two bodies A and B as source and refrigerator, to perform a greater amount of useful work *W*, per cycle for the same quantity of heat *H* taken from the source, it would suffice to take a portion *W*, of this motive power (since *W*, is by hypothesis greater than *W*), to drive the engine R backwards, and return a quantity of heat *H* to the source in each cycle. The process might be repeated indefinitely, and we should obtain at each repetition a balance of useful work *W* - *W*, without taking any heat from the source, which is contrary to experience. Whether the quantity of heat taken from the condenser by R is equal to that given to the condenser by S is immaterial. The hot body A might be a comparatively small boiler, since no heat is taken from it. The cold body B might be the ocean, or the whole earth. We might thus obtain without any consumption of fuel a practically unlimited supply of motive power. Which is absurd.

*Carnot's Statement of his Principle.*¹—If the above reasoning be admitted, we must conclude with Carnot that the motive power obtainable from heat is independent of the agents employed to realize it. The efficiency is fixed solely by the temperatures of the bodies between which, in the last resort, the transfer of heat is effected. "We must understand here that each of the methods of developing motive power attains the perfection of which it is susceptible. This condition is fulfilled if, according to our rule, there is produced in the body no change of temperature that is not due to change of volume, or in other words, if there is no direct interchange of heat between bodies of sensibly different temperatures."

It is characteristic of a state of frictionless mechanical equilibrium that an indefinitely small difference of pressure suffices to upset the equilibrium and reverse the motion. Similarly in thermal equilibrium between bodies at the same temperature, an indefinitely small difference of temperature suffices to reverse the transfer of heat. Carnot's rule is therefore the criterion of the reversibility of a cycle of operations as regards transfer of heat. It is assumed that the ideal engine is mechanically

¹ Carnot's description of his cycle and statement of his principle have been given as nearly as possible in his own words, because some injustice has been done him by erroneous descriptions and statements.

reversible, that there is not, for instance, any communication between reservoirs of gas or vapour at sensibly different pressures, and that there is no waste of power in friction. If there is equilibrium both mechanical and thermal at every stage of the cycle, the ideal engine will be perfectly reversible. That is to say, all its operations will be exactly reversed as regards transfer of heat and work, when the operations are performed in the reverse order and direction. On this understanding Carnot's principle may be put in a different way, which is often adopted, but is really only the same thing put in different words: *The efficiency of a perfectly reversible engine is the maximum possible, and is a function solely of the limits of temperature between which it works.* This result depends essentially on the existence of a state of thermal equilibrium defined by equality of temperature, and independent, in the majority of cases, of the state of a body in other respects. In order to apply the principle to the calculation and prediction of results, it is sufficient to determine the manner in which the efficiency depends on the temperature for one particular case, since the efficiency must be the same for all reversible engines.

16. *Experimental Verification of Carnot's Principle.*—Carnot endeavoured to test his result by the following simple calculations. Suppose that we have a cylinder fitted with a frictionless piston, containing 1 gram of water at 100° C., and that the pressure of the steam, namely 760 mm., is in equilibrium with the external pressure on the piston at this temperature. Place the cylinder in connexion with a boiler or hot body at 101° C. The water will then acquire the temperature of 101° C., and will absorb 1 gram-calorie of heat. Some waste of motive power occurs here because heat is allowed to pass from one body to another at a different temperature, but the waste in this case is so small as to be immaterial. Keep the cylinder in contact with the hot body at 101° C. and allow the piston to rise. It may be made to perform useful work as the pressure is now 27.7 mm. (or 37.7 grams per sq. cm.) in excess of the external pressure. Continue the process till all the water is converted into steam. The heat absorbed from the hot body will be nearly 540 gram-calories, the latent heat of steam at this temperature. The increase of volume will be approximately 1620 c.c., the volume of 1 gram of steam at this pressure and temperature. The work done by the excess pressure will be $37.7 \times 1620 = 61,000$ gram-centimetres or 0.61 J of a kilogrammetre. Remove the hot body, and allow the steam to expand further till its pressure is 760 mm. and its temperature has fallen to 100° C. The work which might be done in this expansion is less than $\frac{1}{100}$ th part of a kilogrammetre, and may be neglected for the present purpose. Place the cylinder in contact with the cold body at 100° C., and allow the steam to condense at this temperature. No work is done on the piston, because there is equilibrium of pressure, but a quantity of heat equal to the latent heat of steam at 100° C. is given to the cold body. The water is now in its initial condition, and the result of the process has been to gain 0.61 of a kilogrammetre of work by allowing 540 gram-calories of heat to pass from a body at 101° C. to a body at 100° C. by means of an ideally simple steam-engine. The work obtainable in this way from 1000 gram-calories of heat, or 1 kilo-calorie, would evidently be 1.13 kilogrammetre ($= 0.61 \times \frac{1000}{540}$).

Taking the same range of temperature, namely 101° to 100° C., we may perform a similar series of operations with air in the cylinder, instead of water and steam. Suppose the cylinder to contain 1 gramme of air at 100° C. and 760 mm. pressure instead of water. Compress it without loss of heat (adiabatically), so as to raise its temperature to 101° C. Place it in contact with the hot body at 101° C., and allow it to expand at this temperature, absorbing heat from the hot body, until its volume is increased by $\frac{1}{100}$ th part (the expansion per degree at constant pressure). The quantity of heat absorbed in this expansion, as explained in § 14, will be the difference of the specific heats or the latent heat of expansion $R' = .069$ calorie. Remove the hot body, and allow the gas to expand further without gain of heat till its temperature falls to 100° C. Compress it at 100° C. to its original volume, abstracting the heat of compression by contact with the cold body at 100° C. The air is now in its original state, and the process has been carried out in strict accordance with Carnot's rule. The quantity of external work done in the cycle is easily obtained by the aid of the indicator diagram ABCD (fig. 5), which is approximately a parallelogram in this instance. The area of the diagram is equal to that of the rectangle BEHG, being the product of the vertical height BE, namely, the increase of pressure per 1° at constant volume, by the increase of volume BG, which is $\frac{1}{100}$ of the volume at 0° C. and 760 mm., or 2.83 c.c. The increase of pressure BE is $\frac{1}{100}$, or 2.03 mm., which is equivalent to 2.76 gm. per sq. cm. The work done in the cycle is $2.76 \times 2.83 = 7.82$ gm. cm., or .0782 gram-metre. The heat absorbed at 101° C. was .069 gram-calorie, so that the work obtained is .0782/.069 or 1.13 gram-metre per gram-calorie, or 1.13 kilogrammetre per kilogram-calorie. This result is precisely the same as that obtained by using

steam with the same range of temperature, but a very different kind of cycle. Carnot in making the same calculation did not obtain quite so good an agreement, because the experimental data at that time available were not so accurate. He used the value $\frac{1}{100}$ for the coefficient of expansion, and .267 for the specific heat of air. Moreover, he did not feel justified in assuming, as above, that the difference of the specific heats was the same at 100° C. as at the ordinary temperature of 15° to 20° C., at which it had been experimentally determined. He made similar calculations for the vapour of alcohol, which differed slightly from the vapour of water. But the agreement he found was close enough to satisfy him that his theoretical deductions were correct, and that the resulting ratio of work to heat should be the same for all substances at the same temperature.

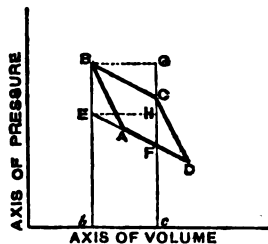

FIG. 5.—Elementary Carnot Cycle for Gas.

17. *Carnot's Function. Variation of Efficiency with Temperature.*—By means of calculations, similar to those given above, Carnot endeavoured to find the amount of motive power obtainable from one unit of heat per degree fall at various temperatures with various substances. The value found above, namely 1.13 kilogrammetre per kilo-calorie per 1° fall, is the value of the efficiency per 1° fall at 100° C. He was able to show that the efficiency per degree fall probably diminished with rise of temperature, but the experimental data at that time were too inconsistent to suggest the true relation. He took as the analytical expression of his principle that the efficiency W/H of a perfect engine taking in heat H at a temperature t' ° C., and rejecting heat at the temperature t'' ° C., must be some function F of the temperature t' , which would be the same for all substances. The efficiency per degree fall at a temperature t' be represented by F' , the derived function of F . The function F' would be the same F' for all substances at the same temperature, but would have different values at different temperatures. In terms of this function, which is generally known as Carnot's function, the results obtained in the previous section might be expressed as follows:—

"The increase of volume of a mixture of liquid and vapour per unit-mass vaporized at any temperature, multiplied by the increase of vapour-pressure per degree, is equal to the product of the function F' by the latent heat of vaporization.

"The difference of the specific heats, or the latent heat of expansion for any substance multiplied by the function F' , is equal to the product of the expansion per degree at constant pressure by the increase of pressure per degree at constant volume."

Since the last two coefficients are the same for all gases if equal volumes are taken, Carnot concluded that: "The difference of the specific heats at constant pressure and volume is the same for equal volumes of all gases at the same temperature and pressure."

Taking the expression $W = RT \log \frac{r}{1}$ for the whole work done by a gas obeying the gaseous laws $pV = RT$ in expanding at a temperature T from a volume 1 (unity) to a volume r , or for a ratio of expansion r , and putting $W' = R \log \frac{r}{1}$ for the work done in a cycle of range 1°, Carnot obtained the expression for the heat absorbed by a gas in isothermal expansion

$$H = R \log \frac{r}{1} / F' t \quad (2)$$

He gives several important deductions which follow from this formula, which is the analytical expression of the experimental result already quoted as having been discovered subsequently by Dulong. Employing the above expression for the latent heat of expansion, Carnot deduced a general expression for the specific heat of a gas at constant volume on the basis of the caloric theory. He showed that if the specific heat was independent of the temperature (the hypothesis already adopted by Laplace and Poisson) the function $F' t$ must be of the form

$$F' t = R/C(t + \epsilon) \quad (3)$$

where C and ϵ are unknown constants. A similar result follows from his expression for the difference of the specific heats. If this is assumed to be constant and equal to C , the expression for $F' t$ becomes R/CT , which is the same as the above if $\epsilon = 273$. Assuming the specific heat to be also independent of the volume, he shows that the function $F' t$ should be constant. But this assumption is inconsistent with the caloric theory of latent heat of expansion, which requires the specific heat to be a function of the volume. It appears in fact impossible to reconcile Carnot's principle with the caloric theory on any simple assumptions. As Carnot remarks: "The main principles on which the theory of heat rests require more careful examination. Many experimental facts appear almost inexplicable in the present state of this theory."

Carnot's work was subsequently put in a more complete analytical form by B. P. E. Clapeyron (*Journ. de l'éc. polytechn.*,

Paris, 1832, 14, p. 153), who also made use of Watt's indicator diagram for the first time in discussing physical problems. Clapeyron gave the general expressions for the latent heat of a vapour, and for the latent heat of isothermal expansion of any substance, in terms of Carnot's function, employing the notation of the calculus. The expressions he gave are the same in form as those in use at the present day. He also gave the general expression for Carnot's function, and endeavoured to find its variation with temperature; but having no better data, he succeeded no better than Carnot. Unfortunately, in describing Carnot's cycle, he assumed the caloric theory of heat, and made some unnecessary mistakes, which Carnot (who, we now know, was a believer in the mechanical theory) had been very careful to avoid. Clapeyron directs one to compress the gas at the lower temperature in contact with the body B until the heat disengaged is equal to that which has been absorbed at the higher temperature.¹ He assumes that the gas at this point contains the same quantity of heat as it contained in its original state at the higher temperature, and that, when the body B is removed, the gas will be restored to its original temperature, when compressed to its initial volume. This mistake is still attributed to Carnot, and regarded as a fatal objection to his reasoning by nearly all writers at the present day.

18. *Mechanical Theory of Heat.*—According to the caloric theory, the heat absorbed in the expansion of a gas became latent, like the latent heat of vaporization of a liquid, but remained in the gas and was again evolved on compressing the gas. This theory gave no explanation of the source of the motive power produced by expansion. The mechanical theory had explained the production of heat by friction as being due to transformation of visible motion into a brisk agitation of the ultimate molecules, but it had not so far given any definite explanation of the converse production of motive power at the expense of heat. The theory could not be regarded as complete until it had been shown that in the production of work from heat, a certain quantity of heat disappeared, and ceased to exist as heat; and that this quantity was the same as that which could be generated by the expenditure of the work produced. The earliest complete statement of the mechanical theory from this point of view is contained in some notes written by Carnot, about 1830, but published by his brother (*Life of Sadi Carnot*, Paris, 1878). Taking the difference of the specific heats to be .078, he estimated the mechanical equivalent at 370 kilogrammetres. But he fully recognized that there were no experimental data at that time available for a quantitative test of the theory, although it appeared to afford a good qualitative explanation of the phenomena. He therefore planned a number of crucial experiments such as the "porous plug" experiment, to test the equivalence of heat and motive power. His early death in 1836 put a stop to these experiments, but many of them have since been independently carried out by other observers.

The most obvious case of the production of work from heat is in the expansion of a gas or vapour, which served in the first instance as a means of calculating the ratio of equivalence, on the assumption that all the heat which disappeared had been transformed into work and had not merely become latent. Marc Séguin, in his *De l'influence des chemins de fer* (Paris, 1830), made a rough estimate in this manner of the mechanical equivalent of heat, assuming that the loss of heat represented by the fall of temperature of steam on expanding was equivalent to the mechanical effect produced by the expansion. He also remarks (*loc. cit.* p. 382) that it was absurd to suppose that "a finite quantity of heat could produce an indefinite quantity of mechanical action, and that it was more natural to assume that a certain quantity of heat disappeared in the very act of producing motive power." J. R. Mayer (*Liebig's Annalen*, 1842, 42, p. 233) stated the equivalence of heat and work more

¹ It was for this reason that Professor W. Thomson (Lord Kelvin) stated (*Phil. Mag.*, 1852, 4) that "Carnot's original demonstration utterly fails," and that he introduced the "corrections" attributed to James Thomson and Clerk Maxwell respectively. In reality Carnot's original demonstration requires no correction.

definitely, deducing it from the old principle, *causa aequalis effectum*. Assuming that the sinking of a mercury column by which a gas was compressed was equivalent to the heat set free by the compression, he deduced that the warming of a kilogramme of water 1° C. would correspond to the fall of a weight of one kilogramme from a height of about 365 metres. But Mayer did not adduce any fresh experimental evidence, and made no attempt to apply his theory to the fundamental equations of thermodynamics. It has since been urged that the experiment of Gay-Lussac (1807), on the expansion of gas from one globe to another (see above, § 11), was sufficient justification for the assumption tacitly involved in Mayer's calculation. But Joule was the first to supply the correct interpretation of this experiment, and to repeat it on an adequate scale with suitable precautions. Joule was also the first to measure directly the amount of heat liberated by the compression of a gas, and to prove that heat was not merely rendered latent, but disappeared altogether as heat, when a gas did work in expansion.

19. *Joule's Determinations of the Mechanical Equivalent.*—The honour of placing the mechanical theory of heat on a sound experimental basis belongs almost exclusively to J. P. Joule, who showed by direct experiment that in all the most important cases in which heat was generated by the expenditure of mechanical work, or mechanical work was produced at the expense of heat, there was a constant ratio of equivalence between the heat generated and the work expended and vice versa. His first experiments were on the relation of the chemical and electric energy expended to the heat produced in metallic conductors and voltaic and electrolytic cells; these experiments were described in a series of papers published in the *Phil. Mag.*, 1840-1843. He first proved the relation, known as Joule's law, that the heat produced in a conductor of resistance R by a current C is proportional to CR² per second. He went on to show that the total heat produced in any voltaic circuit was proportional to the electromotive force E of the battery and to the number of equivalents electrolysed in it. Faraday had shown that electromotive force depends on chemical affinity. Joule measured the corresponding heats of combustion, and showed that the electromotive force corresponding to a chemical reaction is proportional to the heat of combustion of the electrochemical equivalent. He also measured the E.M.F. required to decompose water, and showed that when part of the electric energy EC is thus expended in a voltmeter, the heat generated is less than the heat of combustion corresponding to EC by a quantity representing the heat of combustion of the decomposed gases. His papers so far had been concerned with the relations between electrical energy, chemical energy and heat which he showed to be mutually equivalent. The first paper in which he discussed the relation of heat to mechanical power was entitled "On the Caloric Effects of Magneto-Electricity; and on the Mechanical Value of Heat" (*Brit. Assoc.*, 1843; *Phil. Mag.*, 23, p. 263). In this paper he showed that the heat produced by currents generated by magneto-electric induction followed the same law as voltaic currents. By a simple and ingenious arrangement he succeeded in measuring the mechanical power expended in producing the currents, and deduced the mechanical equivalent of heat and of electrical energy. The amount of mechanical work required to raise 1 lb of water 1° F. (1 B.Th.U.), as found by this method, was 838 foot-pounds. In a note added to the paper he states that he found the value 770 foot-pounds by the more direct method of forcing water through fine tubes. In a paper "On the Changes of Temperature produced by the Rarefaction and Condensation of Air" (*Phil. Mag.*, May 1845), he made the first direct measurements of the quantity of heat disengaged by compressing air, and also of the heat absorbed when the air was allowed to expand against atmospheric pressure; as the result he deduced the value 798 foot-pounds for the mechanical equivalent of 1 B.Th.U. He also showed that there was no appreciable absorption of heat when air was allowed to expand in such a manner as not to develop mechanical power, and he pointed out that the mechanical equivalent of heat could not be satisfactorily deduced from

the relations of the specific heats, because the knowledge of the specific heats of gases at that time was of so uncertain a character. He attributed most weight to his later determinations of the mechanical equivalent made by the direct method of friction of liquids. He showed that the results obtained with different liquids, water, mercury and sperm oil, were the same, namely, 782 foot-pounds; and finally repeating the method with water, using all the precautions and improvements which his experience had suggested, he obtained the value 772 foot-pounds, which was accepted universally for many years, and has only recently required alteration on account of the more exact definition of the heat unit, and the standard scale of temperature (see CALORIMETRY). The great value of Joule's work for the general establishment of the principle of the conservation of energy lay in the variety and completeness of the experimental evidence he adduced. It was not sufficient to find the relation between heat and mechanical work or other forms of energy in one particular case. It was necessary to show that the same relation held in all cases which could be examined experimentally, and that the ratio of equivalence of the different forms of energy, measured in different ways, was independent of the manner in which the conversion was effected and of the material or working substance employed.

As the result of Joule's experiments, we are justified in concluding that heat is a form of energy, and that all its transformations are subject to the general principle of the conservation of energy. As applied to heat, the principle is called the first law of thermo-dynamics, and may be stated as follows: *When heat is transformed into any other kind of energy, or vice versa, the total quantity of energy remains invariable; that is to say, the quantity of heat which disappears is equivalent to the quantity of the other kind of energy produced and vice versa.*

The number of units of mechanical work equivalent to one unit of heat is generally called the mechanical equivalent of heat, or Joule's equivalent, and is denoted by the letter J. Its numerical value depends on the units employed for heat and mechanical energy respectively. The values of the equivalent in terms of the units most commonly employed at the present time are as follows:—

777 foot-pounds (Lat. 45°)	are equivalent to	1 B. Th. U. (lb deg. Fahr.)
1399 foot-pounds	" "	1 lb deg. C.
426·3 kilogrammetres	" "	1 kilogram-deg. C. or kilocalorie.
426·3 grammetres	" "	1 gram-deg. C. or calorie.
4·180 joules	" "	1 gram-deg. C. or calorie.

The water for the heat units is supposed to be taken at 20° C. or 68° F., and the degree of temperature is supposed to be measured by the hydrogen thermometer. The acceleration of gravity in latitude 45° is taken as 980·7 C.G.S. For details of more recent and accurate methods of determination, the reader should refer to the article CALORIMETRY, where tables of the variation of the specific heat of water with temperature are also given.

The second law of thermodynamics is a title often used to denote Carnot's principle or some equivalent mathematical expression. In some cases this title is not conferred on Carnot's principle itself, but on some axiom from which the principle may be indirectly deduced. These axioms, however, cannot as a rule be directly applied, so that it would appear preferable to take Carnot's principle itself as the second law. It may be observed that, as a matter of history, Carnot's principle was established and generally admitted before the principle of the conservation of energy as applied to heat, and that from this point of view the titles, first and second laws, are not particularly appropriate.

20. *Combination of Carnot's Principle with the Mechanical Theory.*—A very instructive paper, as showing the state of the science of heat about this time, is that of C. H. A. Holtzmann, "On the Heat and Elasticity of Gases and Vapours" (Mannheim, 1845; Taylor's *Scientific Memoirs*, iv. 186). He points out that the theory of Laplace and Poisson does not agree with facts when applied to vapours, and that Clapeyron's formulæ,

though probably correct, contain an undetermined function (Carnot's F' , Clapeyron's t/C) of the temperature. He determines the value of this function to be J/T by assuming, with Séguin and Mayer, that the work done in the isothermal expansion of a gas is a measure of the heat absorbed. From the then accepted value ·078 of the difference of the specific heats of air, he finds the numerical value of J to be 374 kilogrammetres per kilo-calorie. Assuming the heat equivalent of the work to remain in the gas, he obtains expressions similar to Clapeyron's for the total heat and the specific heats. In consequence of this assumption, the formulæ he obtained for adiabatic expansion were necessarily wrong, but no data existed at that time for testing them. In applying his formulæ to vapours, he obtained an expression for the saturation-pressure of steam, which agreed with the empirical formula of Roche, and satisfied other experimental data on the supposition that the co-efficient of expansion of steam was ·00423, and its specific heat 1·66—values which are now known to be impossible, but which appeared at the time to give a very satisfactory explanation of the phenomena.

The essay of Hermann Helmholtz, *On the Conservation of Force* (Berlin, 1847), discusses all the known cases of the transformation of energy, and is justly regarded as one of the chief landmarks in the establishment of the energy-principle. Helmholtz gives an admirable statement of the fundamental principle as applied to heat, but makes no attempt to formulate the correct equations of thermodynamics on the mechanical theory. He points out the fallacy of Holtzmann's (and Mayer's) calculation of the equivalent, but admits that it is supported by Joule's experiments, though he does not seem to appreciate the true value of Joule's work. He considers that Holtzmann's formulæ are well supported by experiment, and are much preferable to Clapeyron's, because the value of the undetermined function F' is found. But he fails to notice that Holtzmann's equations are fundamentally inconsistent with the conservation of energy, because the heat equivalent of the external work done is supposed to remain in the gas.

That a quantity of heat equivalent to the work performed actually disappears when a gas does work in expansion, was first shown by Joule in the paper on condensation and rarefaction of air (1845) already referred to. At the conclusion of this paper he felt justified by direct experimental evidence in reasserting definitely the hypothesis of Séguin (*loc. cit.* p. 383) that "the steam while expanding in the cylinder loses heat in quantity exactly proportional to the mechanical force developed, and that on the condensation of the steam the heat thus converted into power is not given back." He did not see his way to reconcile this conclusion with Clapeyron's description of Carnot's cycle. At a later date, in a letter to Professor W. Thomson (Lord Kelvin) (1848), he pointed out that, since, according to his own experiments, the work done in the expansion of a gas at constant temperature is equivalent to the heat absorbed, by equating Carnot's expressions (given in § 17) for the work done and the heat absorbed, the value of Carnot's function F' must be equal to J/T , in order to reconcile his principle with the mechanical theory.

Professor W. Thomson gave an account of Carnot's theory (*Trans. Roy. Soc. Edin.*, Jan. 1849), in which he recognized the discrepancy between Clapeyron's statement and Joule's experiments, but did not see his way out of the difficulty. He therefore adopted Carnot's principle provisionally, and proceeded to calculate a table of values of Carnot's function F' , from the values of the total-heat and vapour-pressure of steam then recently determined by Regnault (*Mémoires de l'Institut de Paris*, 1847). In making the calculation, he assumed that the specific volume v of saturated steam at any temperature T and pressure p is that given by the gaseous laws, $pv = RT$. The results are otherwise correct so far as Regnault's data are accurate, because the values of the efficiency per degree F'/t are not affected by any assumption with regard to the nature of heat. He obtained the values of the efficiency F' over a finite range from t to 0° C., by adding up the values of F'/t for the separate degrees. This latter proceeding is inconsistent with the mechanical theory, but is the

correct method on the assumption that the heat given up to the condenser is equal to that taken from the source. The values he obtained for $F't$ agreed very well with those previously given by Carnot and Clapeyron, and showed that this function diminishes with rise of temperature roughly in the inverse ratio of T , as suggested by Joule.

R. J. E. Clausius (*Pogg. Ann.*, 1850, 79, p. 369) and W. J. M. Rankine (*Trans. Roy. Soc. Edin.*, 1850) were the first to develop the correct equations of thermodynamics on the mechanical theory. When heat was supplied to a body to change its temperature or state, part remained in the body as intrinsic heat energy E , but part was converted into external work of expansion W and ceased to exist as heat. The part remaining in the body was always the same for the same change of state, however performed, as required by Carnot's fundamental axiom, but the part corresponding to the external work was necessarily different for different values of the work done. Thus in any cycle in which the body was exactly restored to its initial state, the heat remaining in the body would always be the same, or as Carnot puts it, the quantities of heat absorbed and given out in its diverse transformations are exactly "compensated," so far as the body is concerned. But the quantities of heat absorbed and given out are not necessarily equal. On the contrary, they differ by the equivalent of the external work done in the cycle. Applying this principle to the case of steam, Clausius deduced a fact previously unknown, that the specific heat of steam maintained in a state of saturation is negative, which was also deduced by Rankine (*loc. cit.*) about the same time. In applying the principle to gases Clausius assumes (with Mayer and Holtzmann) that the heat absorbed by a gas in isothermal expansion is equivalent to the work done, but he does not appear to be acquainted with Joule's experiment, and the reasons he adduces in support of this assumption are not conclusive. This being admitted, he deduces from the energy principle alone the propositions already given by Carnot with reference to gases, and shows in addition that the specific heat of a perfect gas must be independent of the density. In the second part of his paper he introduces Carnot's principle, which he quotes as follows: "The performance of work is equivalent to a transference of heat from a hot to a cold body without the quantity of heat being thereby diminished." This is not Carnot's way of stating his principle (see § 15), but has the effect of exaggerating the importance of Clapeyron's unnecessary assumption. By equating the expressions given by Carnot for the work done and the heat absorbed in the expansion of a gas, he deduces (following Holtzmann) the value J/T for Carnot's function $F't$ (which Clapeyron denotes by $1/C$). He shows that this assumption gives values of Carnot's function which agree fairly well with those calculated by Clapeyron and Thomson, and that it leads to values of the mechanical equivalent not differing greatly from those of Joule. Substituting the value J/T for C in the analytical expressions given by Clapeyron for the latent heat of expansion and vaporization, these relations are immediately reduced to their modern form (see THERMODYNAMICS, § 4). Being unacquainted with Carnot's original work, but recognizing the invalidity of Clapeyron's description of Carnot's cycle, Clausius substituted a proof consistent with the mechanical theory, which he based on the axiom that "heat cannot of itself pass from cold to hot." The proof on this basis involves the application of the energy principle, which does not appear to be necessary, and the axiom to which final appeal is made does not appear more convincing than Carnot's. Strange to say, Clausius did not in this paper give the expression for the efficiency in a Carnot cycle of finite range (Carnot's F) which follows immediately from the value J/T assumed for the efficiency $F't$ of a cycle of infinitesimal range at the temperature t C or T Abs.

Rankine did not make the same assumption as Clausius explicitly, but applied the mechanical theory of heat to the development of his hypothesis of molecular vortices, and deduced from it a number of results similar to those obtained by Clausius. Unfortunately the paper (*loc. cit.*) was not published till some time later, but in a summary given in the *Phil. Mag.* (July 1851)

the principal results were detailed. Assuming the value of Joule's equivalent, Rankine deduced the value 0.2404 for the specific heat of air at constant pressure, in place of 0.267 as found by Delaroché and Bérard. The subsequent verification of this value by Regnault (*Comptes rendus*, 1853) afforded strong confirmation of the accuracy of Joule's work. In a note appended to the abstract in the *Phil. Mag.* Rankine states that he has succeeded in proving that the maximum efficiency of an engine working in a Carnot cycle of finite range t_1 to t_2 is of the form $(t_1 - t_2)/(t_1 - k)$, where k is a constant, the same for all substances. This is correct if t represents temperature Centigrade, and $k = -273$.

Professor W. Thomson (Lord Kelvin) in a paper "On the Dynamical Theory of Heat" (*Trans. Roy. Soc. Edin.*, 1851, first published in the *Phil. Mag.*, 1852) gave a very clear statement of the position of the theory at that time. He showed that the value $F't = J/T$, assumed for Carnot's function by Clausius without any experimental justification, rested solely on the evidence of Joule's experiment, and might possibly not be true at all temperatures. Assuming the value J/T with this reservation, he gave as the expression for the efficiency over a finite range t_1 to t_2 C., or T_1 to T_2 Abs., the result,

$$W/H = (t_1 - t_2)/(t_1 + 273) = (T_1 - T_2)/T_1 \quad (4)$$

which, he observed, agrees in form with that found by Rankine.

21. *The Absolute Scale of Temperature.*—Since Carnot's function is the same for all substances at the same temperature, and is a function of the temperature only, it supplies a means of measuring temperature independently of the properties of any particular substance. This proposal was first made by Lord Kelvin (*Phil. Mag.*, 1848), who suggested that the degree of temperature should be chosen so that the efficiency of a perfect engine at any point of the scale should be the same, or that Carnot's function $F't$ should be constant. This would give the simplest expression for the efficiency on the calorific theory, but the scale so obtained, when the values of Carnot's function were calculated from Regnault's observations on steam, was found to differ considerably from the scale of the mercury or air-thermometer. At a later date, when it became clear that the value of Carnot's function was very nearly proportional to the reciprocal of the temperature T measured from the absolute zero of the gas thermometer, he proposed a simpler method (*Phil. Trans.*, 1854), namely, to define absolute temperature θ as proportional to the reciprocal of Carnot's function. On this definition of absolute temperature, the expression $(\theta_1 - \theta_2)/\theta_1$ for the efficiency of a Carnot cycle with limits θ_1 and θ_2 would be exact, and it became a most important problem to determine how far the temperature T by gas thermometer differed from the absolute temperature θ . With this object he devised a very delicate method, known as the "porous plug experiment" (see THERMODYNAMICS) of testing the deviation of the gas thermometer from the absolute scale. The experiments were carried out in conjunction with Joule, and finally resulted in showing (*Phil. Trans.*, 1862, "On the Thermal Effects of Fluids in Motion") that the deviations of the air thermometer from the absolute scale as above defined are almost negligible, and that in the case of the gas hydrogen the deviations are so small that a thermometer containing this gas may be taken for all practical purposes as agreeing exactly with the absolute scale at all ordinary temperatures. For this reason the hydrogen thermometer has since been generally adopted as the standard.

22. *Availability of Heat of Combustion.*—Taking the value 1.13 kilogrammetres per kilo-calorie for 1° C. fall of temperature at 100° C., Carnot attempted to estimate the possible performance of a steam-engine receiving heat at 160° C. and rejecting it at 40° C. Assuming the performance to be simply proportional to the temperature fall, the work done for 120° fall would be 134 kilogrammetres per kilo-calorie. To make an accurate calculation required a knowledge of the variation of the function $F't$ with temperature. Taking the accurate formula of § 20, the work obtainable is 118 kilogrammetres per kilo-calorie, which is

28% of 426, the mechanical equivalent of the kilo-calorie in kilogrammetres. Carnot pointed out that the fall of 120° C. utilized in the steam-engine was only a small fraction of the whole temperature fall obtainable by combustion, and made an estimate of the total power available if the whole fall could be utilized, allowing for the probable diminution of the function F' with rise of temperature. His estimate was 3.9 million kilogrammetres per kilogramme of coal. This was certainly an over-estimate, but was surprisingly close, considering the scanty data at his disposal.

In reality the fraction of the heat of combustion available, even in an ideal engine and apart from practical limitations, is much less than might be inferred from the efficiency formula of the Carnot cycle. In applying this formula to estimate the availability of the heat it is usual to take the temperature obtainable by the combustion of the fuel as the upper limit of temperature in the formula. For carbon burnt *in air* at constant pressure without any loss of heat, the products of combustion might be raised 2300° C. in temperature, assuming that the specific heats of the products were constant and that there was no dissociation. If all the heat could be supplied to the working fluid at this temperature, that of the condenser being 40° C., the possible efficiency by the formula of § 20 would be 89%. But the combustion obviously cannot maintain so high a temperature if heat is being continuously abstracted by a boiler. Suppose that θ' is the maximum temperature of combustion as above estimated, θ'' the temperature of the boiler, and θ that of the condenser. Of the whole heat supplied by combustion represented by the rise of temperature $\theta' - \theta''$, the fraction $(\theta' - \theta'') / (\theta' - \theta'')$ is the maximum that could be supplied to the boiler, the fraction $(\theta'' - \theta) / (\theta' - \theta'')$ being carried away with the waste gases. Of the heat supplied to the boiler, the fraction $(\theta'' - \theta) / \theta''$ might theoretically be converted into work. The problem in the case of an engine using a separate working fluid, like a steam-engine, is to find what must be the temperature θ'' of the boiler in order to obtain the largest possible fraction of the heat of combustion in the form of work. It is easy to show that θ'' must be the geometric mean of θ' and θ , or $\theta'' = \sqrt{\theta'\theta}$. Taking $\theta' - \theta'' = 2300^\circ \text{ C.}$, and $\theta'' = 313^\circ \text{ Abs.}$ as before, we find $\theta'' = 903^\circ \text{ Abs.}$ or 630° C. The heat supplied to the boiler is then 74.4% of the heat of combustion, and of this 65.3% is converted into work, giving a maximum possible efficiency of 49% in place of 89%. With the boiler at 160° C., the possible efficiency, calculated in a similar manner, would be 26.3%, which shows that the possible increase of efficiency by increasing the temperature range is not so great as is usually supposed. If the temperature of the boiler were raised to 300° C., corresponding to a pressure of 1260 lb per sq. in., which is occasionally surpassed in modern flash-boilers, the possible efficiency would be 40%. The waste heat from the boiler, supposed perfectly efficient, would be in this case 11%, of which less than a quarter could be utilized in the form of work. Carnot foresaw that in order to utilize a larger percentage of the heat of combustion it would be necessary to employ a series of working fluids, the waste heat from one boiler and condenser serving to supply the next in the series. This has actually been effected in a few cases, e.g. steam and SO_2 , when special circumstances exist to compensate for the extra complication. Improvements in the steam-engine since Carnot's time have been mainly in the direction of reducing waste due to condensation and leakage by multiple expansion, superheating, &c. The gain by increased temperature range has been comparatively small owing to limitations of pressure, and the best modern steam-engines do not utilize more than 20% of the heat of combustion. This is in reality a very respectable fraction of the ideal limit of 40% above calculated on the assumption of 1260 lb initial pressure, with a perfectly efficient boiler and complete expansion, and with an ideal engine which does not waste available motive power by complete condensation of the steam before it is returned to the boiler.

23. *Advantages of Internal Combustion.*—As Carnot pointed out, the chief advantage of using atmospheric air as a working fluid in a heat-engine lies in the possibility of imparting heat to

it directly by internal combustion. This avoids the limitation imposed by the use of a separate boiler, which as we have seen reduces the possible efficiency at least 50%. Even with internal combustion, however, the full range of temperature is not available, because the heat cannot conveniently in practice be communicated to the working fluid at constant temperature, owing to the large range of expansion at constant temperature required for the absorption of a sufficient quantity of heat. Air-engines of this type, such as Stirling's or Ericsson's, taking in heat at constant temperature, though theoretically the most perfect, are bulky and mechanically inefficient. In practical engines the heat is generated by the combustion of an explosive mixture at constant volume or at constant pressure. The heat is not all communicated at the highest temperature, but over a range of temperature from that of the mixture at the beginning of combustion to the maximum temperature. The earliest instance of this type of engine is the lycopodium engine of M.M. Niepce, discussed by Carnot, in which a combustible mixture of air and lycopodium powder at atmospheric pressure was ignited in a cylinder, and did work on a piston. The early gas-engines of E. Lenoir (1860) and N. Otto and E. Langen (1866), operated in a similar manner with illuminating gas in place of lycopodium. Combustion in this case is effected practically at constant volume, and the maximum efficiency theoretically obtainable is $1 - \log_e r / (r - 1)$, where r is the ratio of the maximum temperature θ' to the initial temperature θ'' . In order to obtain this efficiency it would be necessary to follow Carnot's rule, and expand the gas after ignition without loss or gain of heat from θ' down to θ'' , and then to compress it at θ'' to its initial volume. If the rise of temperature in combustion were 2300° C., and the initial temperature were $\theta'' \text{ C.}$ or 273° Abs., the theoretical efficiency would be 73.3%, which is much greater than that obtainable with a boiler. But in order to reach this value, it would be necessary to expand the mixture to about 270 times its initial volume, which is obviously impracticable. Owing to incomplete expansion and rapid cooling of the heated gases by the large surface exposed, the actual efficiency of the Lenoir engine was less than 5%, and of the Otto and Langen, with more rapid expansion, about 10%. Carnot foresaw that in order to render an engine of this type practically efficient, it would be necessary to compress the mixture before ignition. Compression is beneficial in three ways: (1) it permits a greater range of expansion after ignition; (2) it raises the mean effective pressure, and thus improves the mechanical efficiency and the power in proportion to size and weight; (3) it reduces the loss of heat during ignition by reducing the surface exposed to the hot gases. In the modern gas or petrol motor, compression is employed as in Carnot's cycle, but the efficiency attainable is limited not so much by considerations of temperature as by limitations of volume. It is impracticable before combustion at constant volume to compress a rich mixture to much less than $\frac{1}{4}$ th of its initial volume, and, for mechanical simplicity, the range of expansion is made equal to that of compression. The cycle employed was patented in 1862 by Beau de Rochas (d. 1892), but was first successfully carried out by Otto (1876). It differs from the Carnot cycle in employing reception and rejection of heat at constant volume instead of at constant temperature. This cycle is not so efficient as the Carnot cycle for given limits of temperature, but, for the given limits of volume imposed, it gives a much higher efficiency than the Carnot cycle. The efficiency depends only on the range of temperature in expansion and compression, and is given by the formula $(\theta' - \theta'') / \theta''$, where θ' is the maximum temperature, and θ'' the temperature at the end of expansion. The formula is the same as that for the Carnot cycle with the same range of temperature in expansion. The ratio θ' / θ'' is $r^{\gamma-1}$, where r is the given ratio of expansion or compression, and γ is the ratio of the specific heats of the working fluid. Assuming the working fluid to be a perfect gas with the same properties as air, we should have $\gamma = 1.41$. Taking $r = 5$, the formula gives 48% for the maximum possible efficiency. The actual products of combustion vary with the nature of the fuel

employed, and have different properties from air, but the efficiency is found to vary with compression in the same manner as for air. For this reason a committee of the Institution of Civil Engineers in 1905 recommended the adoption of the air-standard for estimating the effects of varying the compression ratio, and defined the relative efficiency of an internal combustion engine as the ratio of its observed efficiency to that of a perfect air-engine with the same compression.

24. *Effect of Dissociation, and Increase of Specific Heat.*—One of the most important effects of heat is the decomposition or dissociation of compound molecules. Just as the molecules of a vapour combine with evolution of heat to form the more complicated molecules of the liquid, and as the liquid molecules require the addition of heat to effect their separation into molecules of vapour; so in the case of molecules of different kinds which combine with evolution of heat, the reversal of the process can be effected either by the agency of heat, or indirectly by supplying the requisite amount of energy by electrical or other methods. Just as the latent heat of vaporization diminishes with rise of temperature, and the pressure of the dissociated vapour molecules increases, so in the case of compound molecules in general the heat of combination diminishes with rise of temperature, and the pressure of the products of dissociation increases. There is evidence that the compound carbon dioxide, CO_2 , is partly dissociated into carbon monoxide and oxygen at high temperatures, and that the proportion dissociated increases with rise of temperature. There is a very close analogy between these phenomena and the vaporization of a liquid. The laws which govern dissociation are the same fundamental laws of thermodynamics, but the relations involved are necessarily more complex on account of the presence of different kinds of molecules, and present special difficulties for accurate investigation in the case where dissociation does not begin to be appreciable until a high temperature is reached. It is easy, however, to see that the general effect of dissociation must be to diminish the available temperature of combustion, and all experiments go to show that in ordinary combustible mixtures the rise of temperature actually attained is much less than that calculated as in § 22, on the assumption that the whole heat of combustion is developed and communicated to products of constant specific heat. The defect of temperature observed can be represented by supposing that the specific heat of the products of combustion increases with rise of temperature. This is the case for CO_2 even at ordinary temperatures, according to Regnault, and probably also for air and steam at higher temperatures. Increase of specific heat is a necessary accompaniment of dissociation, and from some points of view may be regarded as merely another way of stating the facts. It is the most convenient method to adopt in the case of products of combustion consisting of a mixture of CO_2 and steam with a large excess of inert gases, because the relations of equilibrium of dissociated molecules of so many different kinds would be too complex to permit of any other method of expression. It appears from the researches of Dugald Clerk, H. le Chatelier and others that the apparent specific heat of the products of combustion in a gas-engine may be taken as approximately .34 to .33 in place of .24 at working temperatures between 1000°C. and 1700°C. , and that the ratio of the specific heats is about 1.29 in place of 1.41. This limits the availability of the heat of combustion by reducing the rise of temperature actually obtainable in combustion at constant volume by 30 or 40%, and also by reducing the range of temperature $\theta' : \theta''$ for a given ratio of expansion r from $r^{.41}$ to $r^{.29}$. The formula given in § 21 is no longer quite exact, because the ratio of the specific heats of the mixture during compression is not the same as that of the products of combustion during expansion. But since the work done depends principally on the expansion curve, the ratio of the range of temperature in expansion $(\theta' - \theta'')$ to the maximum temperature θ' will still give a very good approximation to the possible efficiency. Taking $r = 5$, as before, for the compression ratio, the possible efficiency is reduced from 48% to 38%, if $\gamma = 1.29$ instead of 1.41. A large gas-engine of the present day with $r = 5$ may actually

realize as much as 34% indicated efficiency, which is 90% of the maximum possible, showing how perfectly all avoidable heat losses have been minimized.

It is often urged that the gas-engine is relatively less efficient than the steam-engine, because, although it has a much higher absolute efficiency, it does not utilize so large a fraction of its temperature range, reckoning that of the steam-engine from the temperature of the boiler to that of the condenser, and that of the gas-engine from the maximum temperature of combustion to that of the air. This is not quite fair, and has given rise to the mistaken notion that "there is an immense margin for improvement in the gas-engine," which is not the case if the practical limitations of volume are rightly considered. If expansion could be carried out in accordance with Carnot's principle of maximum efficiency, down to the lower limit of temperature θ_0 , with rejection of heat at θ_0 during compression to the original volume v_0 , it would no doubt be possible to obtain an ideal efficiency of nearly 80%. But this would be quite impracticable, as it would require expansion to about 100 times v_0 , or 500 times the compression volume. Some advantage no doubt might be obtained by carrying the expansion beyond the original volume. This has been done, but is not found to be worth the extra complication. A more practical method, which has been applied by Diesel for liquid fuel, is to introduce the fuel at the end of compression, and adjust the supply in such a manner as to give combustion at nearly constant pressure. This makes it possible to employ higher compression, with a corresponding increase in the ratio of expansion and the theoretical efficiency. With a compression ratio of 14, an indicated efficiency of 40% has been obtained in this way, but owing to additional complications the brake efficiency was only 31%, which is hardly any improvement on the brake efficiency of 30% obtained with the ordinary type of gas-engine. Although Carnot's principle makes it possible to calculate in every case what the limiting possible efficiency would be for any kind of cycle if all heat losses were abolished, it is very necessary, in applying the principle to practical cases, to take account of the possibility of avoiding the heat losses which are supposed to be absent, and of other practical limitations in the working of the actual engine. An immense amount of time and ingenuity has been wasted in striving to realize impossible margins of ideal efficiency, which a close study of the practical conditions would have shown to be illusory. As Carnot remarks at the conclusion of his essay: "Economy of fuel is only one of the conditions a heat-engine must satisfy; in many cases it is only secondary, and must often give way to considerations of safety, strength and wearing qualities of the machine, of smallness of space occupied, or of expense in erecting. To know how to appreciate justly in each case the considerations of convenience and economy, to be able to distinguish the essential from the accessory, to balance all fairly, and finally to arrive at the best result by the simplest means, such must be the principal talent of the man called on to direct and co-ordinate the work of his fellows for the attainment of a useful object of any kind."

TRANSFERENCE OF HEAT

25. *Modes of Transference.*—There are three principal modes of transference of heat, namely (1) convection, (2) conduction, and (3) radiation.

(1) In convection, heat is carried or conveyed by the motion of heated masses of matter. The most familiar illustrations of this method of transference are the heating of buildings by the circulation of steam or hot water, or the equalization of temperature of a mass of unequally heated liquid or gas by convection currents, produced by natural changes of density or by artificial stirring. (2) In conduction, heat is transferred by contact between contiguous particles of matter and is passed on from one particle to the next without visible relative motion of the parts of the body. A familiar illustration of conduction is the passage of heat through the metal plates of a boiler from the fire to the water inside, or the transference of heat from a soldering bolt to the solder and the metal with which it is placed in contact.

(3) In radiation, the heated body gives rise to a motion of vibration in the aether, which is propagated equally in all directions, and is reconverted into heat when it encounters any obstacle capable of absorbing it. Thus radiation differs from conduction and convection in taking place most perfectly in the absence of matter, whereas conduction and convection require material communication between the bodies concerned.

In the majority of cases of transference of heat all three modes of transference are simultaneously operative in a greater or less degree, and the combined effect is generally of great complexity. The different modes of transference are subject to widely different laws, and the difficulty of disentangling their effects and subjecting them to calculation is often one of the most serious obstacles in the experimental investigation of heat. In space void of matter, we should have pure radiation, but it is difficult to obtain so perfect a vacuum that the effects of the residual gas in transferring heat by conduction or convection are inappreciable. In the interior of an opaque solid we should have pure conduction, but if the solid is sensibly transparent in thin layers there must also be an internal radiation, while in a liquid or a gas it is very difficult to eliminate the effects of convection. These difficulties are well illustrated in the historical development of the subject by the experimental investigations which have been made to determine the laws of heat-transference, such as the laws of cooling, of radiation and of conduction.

26. *Newton's Law of Cooling.*—There is one essential condition common to all three modes of heat-transference, namely, that they depend on difference of temperature, that the direction of the transfer of heat is always from hot to cold, and that the rate of transference is, for small differences, directly proportional to the difference of temperature. Without difference of temperature there is no transfer of heat. When two bodies have been brought to the same temperature by conduction, they are also in equilibrium as regards radiation, and vice versa. If this were not the case, there could be no equilibrium of heat defined by equality of temperature. A hot body placed in an enclosure of lower temperature, e.g. a calorimeter in its containing vessel, generally loses heat by all three modes simultaneously in different degrees. The loss by each mode will depend in different ways on the form, extent and nature of its surface and on that of the enclosure, on the manner in which it is supported, on its relative position and distance from the enclosure, and on the nature of the intervening medium. But provided that the difference of temperature is small, the rate of loss of heat by all modes will be approximately proportional to the difference of temperature; the other conditions remaining constant. The rate of cooling or the rate of fall of temperature will also be nearly proportional to the rate of loss of heat, if the specific heat of the cooling body is constant, or the rate of cooling at any moment will be proportional to the difference of temperature. This simple relation is commonly known as Newton's law of cooling, but is limited in its application to comparatively simple cases such as the foregoing. Newton himself applied it to estimate the temperature of a red-hot iron ball, by observing the time which it took to cool from a red heat to a known temperature, and comparing this with the time taken to cool through a known range at ordinary temperatures. According to this law if the excess of temperature of the body above its surroundings is observed at equal intervals of time, the observed values will form a geometrical progression with a common ratio. Supposing, for instance, that the surrounding temperature were 0° C., that the red-hot ball took 25 minutes to cool from its original temperature to 20° C., and 5 minutes to cool from 20° C. to 10° C., the original temperature is easily calculated on the assumption that the excess of temperature above 0° C. falls to half its value in each interval of 5 minutes. Doubling the value 20° at 25 minutes five times, we arrive at 640° C. as the original temperature. No other method of estimation of such temperatures was available in the time of Newton, but, as we now know, the simple law of proportionality to the temperature difference is inapplicable over such large ranges of temperature. The rate of loss of heat by radiation,

and also by convection and conduction to the surrounding air, increases much more rapidly than in simple proportion to the temperature difference, and the rate of increase of each follows a different law. At a later date Sir John Herschel measured the intensity of the solar radiation at the surface of the earth, and endeavoured to form an estimate of the temperature of the sun by comparison with terrestrial sources on the assumption that the intensity of radiation was simply proportional to the temperature difference. He thus arrived at an estimate of several million degrees, which we now know would be about a thousand times too great. The application of Newton's law necessarily leads to absurd results when the difference of temperature is very large, but the error will not in general exceed 2 to 3% if the temperature difference does not exceed 10° C., and the percentage error is proportionately much smaller for smaller differences.

27. *Dulong and Petit's Empirical Laws of Cooling.*—One of the most elaborate experimental investigations of the law of cooling was that of Dulong and Petit (*Ann. Chim. Phys.*, 1817, 7, pp. 225 and 337), who observed the rate of cooling of a mercury thermometer from 300° C. in a water-jacketed enclosure at various temperatures from 0° C. to 80° C. In order to obtain the rate of cooling by radiation alone, they exhausted the enclosure as perfectly as possible after the introduction of the thermometer, but with the imperfect appliances available at that time they were not able to obtain a vacuum better than about 3 or 4 mm. of mercury. They found that the velocity of cooling V in a vacuum could be represented by a formula of the type

$$V = A(a' - a^2) \dots \dots (5)$$

in which t is the temperature of the thermometer, and t_0 that of the enclosure, a is a constant having the value 1.0075, and the coefficient A depends on the form of the bulb and the nature of its surface. For the ranges of temperature they employed, this formula gives much better results than Newton's, but it must be remembered that the temperatures were expressed on the arbitrary scale of the mercury thermometer, and were not corrected for the large and uncertain errors of stem-exposure (see THERMOMETRY). Moreover, although the effects of cooling by convection currents are practically eliminated by exhausting to 3 or 4 mm. (since the density of the gas is reduced to 1/200th while its viscosity is not appreciably affected), the rate of cooling by conduction is not materially diminished, since the conductivity, like the viscosity, is nearly independent of pressure. It has since been shown by Sir William Crookes (*Proc. Roy. Soc.*, 1881, 21, p. 239) that the rate of cooling of a mercury thermometer in a vacuum suffers a very great diminution when the pressure is reduced from 1 mm. to .001 mm., at which pressure the effect of conduction by the residual gas has practically disappeared.

Dulong and Petit also observed the rate of cooling under the same conditions with the enclosure filled with various gases. They found that the cooling effect of the gas could be represented by adding to the term already given as representing radiation, an expression of the form

$$V' = B\psi(t - t_0)^{1-2m} \dots \dots (6)$$

They found that the cooling effect of convection, unlike that of radiation, was independent of the nature of the surface of the thermometer, whether silvered or blackened, that it varied as some power c of the pressure ψ , and that it was independent of the absolute temperature of the enclosure, but varied as the excess temperature $(t - t_0)$ raised to the power $1-2m$. This highly artificial result undoubtedly contains some elements of truth, but could only be applied to experiments similar to those from which it was derived. F. Hervé de la Provostaye and P. Q. Desains (*Ann. Chim. Phys.*, 1846, 16, p. 337), in repeating these experiments under various conditions, found that the coefficients A and B were to some extent dependent on the temperature, and that the manner in which the cooling effect varied with the pressure depended on the form and size of the enclosure. It is evident that this should be the case, since the cooling effect of the gas depends partly on convective currents,

which are necessarily greatly modified by the form of the enclosure in a manner which it would appear hopeless to attempt to represent by any general formula.

28. *Surface Emissivity*.—The same remark applies to many attempts which have since been made to determine the general value of the constant termed by Fourier and early writers the "exterior conductivity," but now called the surface emissivity. This coefficient represents the rate of loss of heat from a body per unit area of surface per degree excess of temperature, and includes the effects of radiation, convection and conduction. As already pointed out, the combined effect will be nearly proportional to the excess of temperature in any given case provided that the excess is small, but it is not necessarily proportional to the extent of surface exposed except in the case of pure radiation. The rate of loss by convection and conduction varies greatly with the form of the surface, and, unless the enclosure is very large compared with the cooling body, the effect depends also on the size and form of the enclosure. Heat is necessarily communicated from the cooling body to the layer of gas in contact with it by conduction. If the linear dimensions of the body are small, as in the case of a fine wire, or if it is separated from the enclosure by a thin layer of gas, the rate of loss depends chiefly on conduction. For very fine metallic wires heated by an electric current, W. E. Ayrton and H. Kilgour (*Phil. Trans.*, 1892) showed that the rate of loss is nearly independent of the surface, instead of being directly proportional to it. This should be the case, as Porter has shown (*Phil. Mag.*, March 1895), since the effect depends mainly on conduction. The effects of conduction and radiation may be approximately estimated if the conductivity of the gas and the nature and forms of the surfaces of the body and enclosure are known, but the effect of convection in any case can be determined only by experiment. It has been found that the rate of cooling by a current of air is approximately proportional to the velocity of the current, other things being equal. It is obvious that this should be the case, but the result cannot generally be applied to convection currents. Values which are commonly given for the surface emissivity must therefore be accepted with great reserve. They can be regarded only as approximate, and as applicable only to cases precisely similar to those for which they were experimentally obtained. There cannot be said to be any general law of convection. The loss of heat is not necessarily proportional to the area of the surface, and no general value of the coefficient can be given to suit all cases. The laws of conduction and radiation admit of being more precisely formulated, and their effects predicted, except in so far as they are complicated by convection.

29. *Conduction of Heat*.—The laws of transference of heat in the interior of a solid body formed one of the earliest subjects of mathematical and experimental treatment in the theory of heat. The law assumed by Fourier was of the simplest possible type, but the mathematical application, except in the simplest cases, was so difficult as to require the development of a new mathematical method. Fourier succeeded in showing how, by his method of analysis, the solution of any given problem with regard to the flow of heat by conduction in any material could be obtained in terms of a physical constant, the thermal conductivity of the material, and that the results obtained by experiment agreed in a qualitative manner with those predicted by his theory. But the experimental determination of the actual values of these constants presented formidable difficulties which were not surmounted till a later date. The experimental methods and difficulties are discussed in a special article on CONDUCTION OF HEAT. It will suffice here to give a brief historical sketch, including a few of the more important results by way of illustration.

30. *Comparison of Conducting Powers*.—That the power of transmitting heat by conduction varied widely in different materials was probably known in a general way from prehistoric times. Empirical knowledge of this kind is shown in the construction of many articles for heating, cooking, &c., such as the copper soldering bolt, or the Norwegian cooking-stove. One

of the earliest experiments for making an actual comparison of conducting powers was that suggested by Franklin, but carried out by Jan Ingenhous (*Journ. de phys.*, 1789, 34, pp. 68 and 380). Exactly similar bars of different materials, glass, wood, metal, &c., thinly coated with wax, were fixed in the side of a trough of boiling water so as to project for equal distances through the side of the trough into the external air. The wax coating was observed to melt as the heat travelled along the bars, the distance from the trough to which the wax was melted along each affording an approximate indication of the distribution of temperature. When the temperature of each bar had become stationary the heat which it gained by conduction from the trough must be equal to the heat lost to the surrounding air, and must therefore be approximately proportional to the distance to which the wax had melted along the bar. But the temperature fall per unit length, or the temperature-gradient, in each bar at the point where it emerged from the trough would be inversely proportional to the same distance. For equal temperature-gradients the quantities of heat conducted (or the relative conducting powers of the bars) would therefore be proportional to the squares of the distances to which the wax finally melted on each bar. This was shown by Fourier and Despretz (*Ann. chim. phys.*, 1822, 19, p. 97).

31. *Diffusion of Temperature*.—It was shown in connexion with this experiment by Sir H. Davy, and the experiment was later popularized by John Tyndall, that the rate at which wax melted along the bar, or the rate of propagation of a given temperature, during the first moments of heating, as distinguished from the melting-distance finally attained, depended on the specific heat as well as the conductivity. Short prisms of iron and bismuth coated with wax were placed on a hot metal plate. The wax was observed to melt first on the bismuth, although its conductivity is less than that of iron. The reason is that its specific heat is less than that of iron in the proportion of 3 to 11. The densities of iron and bismuth being 7.8 and 9.8, the thermal capacities of equal prisms will be in the ratio .86 for iron to .29 for bismuth. If the prisms receive heat at equal rates, the bismuth will reach the temperature of melting wax nearly three times as quickly as the iron. It is often stated on the strength of this experiment that the rate of propagation of a temperature wave, which depends on the ratio of the conductivity to the specific heat per unit volume, is greater in bismuth than in iron (*e.g.* Preston, *Heat*, p. 628). This is quite incorrect, because the conductivity of iron is about six times that of bismuth, and the rate of propagation of a temperature wave is therefore twice as great in iron as in bismuth. The experiment in reality is misleading because the rates of reception of heat by the prisms are limited by the very imperfect contact with the hot metal plate, and are not proportional to the respective conductivities. If the iron and bismuth bars are properly faced and soldered to the top of a copper box (in order to ensure good metallic contact, and exclude a non-conducting film of air), and the box is then heated by steam, the rates of reception of heat will be nearly proportional to the conductivities, and the wax will melt nearly twice as fast along the iron as along the bismuth. A bar of lead similarly treated will show a faster rate of propagation than iron, because, although its conductivity is only half that of iron, its specific heat per unit volume is 2.5 times smaller.

32. *Bad Conductors. Liquids and Gases*.—Count Rumford (1792) compared the conducting powers of substances used in clothing, such as wool and cotton, fur and down, by observing the time which a thermometer took to cool when embedded in a globe filled successively with the different materials. The times of cooling observed for a given range varied from 1300 to 900 seconds for different materials. The low conducting power of these materials is principally due to the presence of air in the interstices, which is prevented from forming convection currents by the presence of the fibrous material. Finely powdered silica is a very bad conductor, but in the compact form of rock crystal it is as good a conductor as some of the metals. According to the kinetic theory of gases, the conductivity of a gas depends on molecular diffusion. Maxwell estimated the conductivity of

air at ordinary temperatures at about 20,000 times less than that of copper. This has been verified experimentally by Kundt and Warburg, Stefan and Winkelmann, by taking special precautions to eliminate the effects of convection currents and radiation. It was for some time doubted whether a gas possessed any true conductivity for heat. The experiment of T. Andrews, repeated by Grove, and Magnus, showing that a wire heated by an electric current was raised to a higher temperature in air than in hydrogen, was explained by Tyndall as being due to the greater mobility of hydrogen which gave rise to stronger convection currents. In reality the effect is due chiefly to the greater velocity of motion of the ultimate molecules of hydrogen, and is most marked if molar (as opposed to molecular) convection is eliminated. Molecular convection or diffusion, which cannot be distinguished experimentally from conduction, as it follows the same law, is also the main cause of conduction of heat in liquids. Both in liquids and gases the effects of convection currents are so much greater than those of diffusion or conduction that the latter are very difficult to measure, and, except in special cases, comparatively unimportant as affecting the transference of heat. Owing to the difficulty of eliminating the effects of radiation and convection, the results obtained for the conductivities of liquids are somewhat discordant, and there is in most cases great uncertainty whether the conductivity increases or diminishes with rise of temperature. It would appear, however, that liquids, such as water and glycerin, differ remarkably little in conductivity in spite of enormous differences of viscosity. The viscosity of a liquid diminishes very rapidly with rise of temperature, without any marked change in the conductivity, whereas the viscosity of a gas increases with rise of temperature, and is always nearly proportional to the conductivity.

33. *Difficulty of Quantitative Estimation of Heat Transmitted.*—The conducting powers of different metals were compared by C. M. Despretz, and later by G. H. Wiedemann and R. Franz, employing an extension of the method of Jan Ingenhousz, in which the temperatures at different points along a bar heated at one end were measured by thermometers or thermocouples ket into small holes in the bars, instead of being measured at one point only by means of melting wax. These experiments undoubtedly gave fairly accurate relative values, but did not permit the calculation of the absolute amounts of heat transmitted. This was first obtained by J. D. Forbes (*Brit. Assoc. Rep.*, 1852; *Trans. Roy. Soc. Ed.*, 1862, 23, p. 133) by deducing the amount of heat lost to the surrounding air from a separate experiment in which the rate of cooling of the bar was observed (see CONDUCTION OF HEAT). Clément (*Ann. chim. phys.*, 1841) had previously attempted to determine the conductivities of metals by observing the amount of heat transmitted by a plate with one side exposed to steam at 100° C., and the other side cooled by water at 28° C. Employing a copper plate 3 mm. thick, and assuming that the two surfaces of the plate were at the same temperatures as the water and the steam to which they were exposed, or that the temperature-gradient in the metal was 72° in 3 mm., he had thus obtained a value which we now know to be nearly 200 times too small. The actual temperature difference in the metal itself was really about 0.36° C. The remainder of the 72° drop was in the badly conducting films of water and steam close to the metal surface. Similarly in a boiler plate in contact with flame at 1500° C. on one side and water at, say, 150° C. on the other, the actual difference of temperature in the metal, even if it is an inch thick, is only a few degrees. The metal, unless badly furred with incrustation, is but little hotter than the water. It is immaterial so far as the transmission of heat is concerned, whether the plates are iron or copper. The greater part of the resistance to the passage of heat resides in a comparatively quiescent film of gas close to the surface, through which film the heat has to pass mainly by conduction. If a Bunsen flame, preferably coloured with sodium, is observed impinging on a cold metal plate, it will be seen to be separated from the plate by a dark space of a millimetre or less, throughout which the temperature of the gas is lowered by its own conductivity below the temperature of incandescence.

There is no abrupt change of temperature in passing from the gas to the metal, but a continuous temperature-gradient from the temperature of the metal to that of the flame. It is true that this gradient may be upwards of 1000° C. per mm., but there is no discontinuity.

34. *Resistance of a Gas Film to the Passage of Heat.*—It is possible to make a rough estimate of the resistance of such a film to the passage of heat through it. Taking the average conductivity of the gas in the film as 10,000 times less than that of copper (about double the conductivity of air at ordinary temperatures) a millimetre film would be equivalent to a thickness of 10 metres of copper, or about 1.2 metres of iron. Taking the temperature-gradient as 1000° C. per mm. such a film would transmit 1 gramme-calorie per sq. cm. per sec., or 36,000 kilo-calories per sq. metre per hour. With an area of 100 sq. cms. the heat transmitted at this rate would raise a litre of water from 20° C. to 100° C. in 800 secs. By experiment with a strong Bunsen flame it takes from 8 to 10 minutes to do this, which would indicate that on the above assumptions the equivalent thickness of quiescent film should be rather less than 1 mm. in this case. The thickness of the film diminishes with the velocity of the burning gases impinging on the surface. This accounts for the rapidity of heating by a blowpipe flame, which is not due to any great increase in temperature of the flame as compared with a Bunsen. Similarly the efficiency of a boiler is but slightly reduced if half the tubes are stopped up, because the increase of draught through the remainder compensates partly for the diminished heating surface. Some resistance to the passage of heat into a boiler is also due to the water film on the inside. But this is of less account, because the conductivity of water is much greater than that of air, and because the film is continually broken up by the formation of steam, which abstracts heat very rapidly.

35. *Heating by Condensation of Steam.*—It is often stated that the rate at which steam will condense on a metal surface at a temperature below that corresponding to the saturation pressure of the steam is practically infinite (e.g. Osborne Reynolds, *Proc. Roy. Soc. Ed.*, 1873, p. 275), and conversely that the rate at which water will abstract heat from a metal surface by the formation of steam (if the metal is above the temperature of saturation of the steam) is limited only by the rate at which the metal can supply heat by conduction to its surface layer. The rate at which heat can be supplied by condensation of steam appears to be much greater than that at which heat can be supplied by a flame under ordinary conditions, but there is no reason to suppose that it is infinite, or that any discontinuity exists. Experiments by H. L. Callendar and J. T. Nicolson by three independent methods (*Proc. Inst. Civ. Eng.*, 1898, 131, p. 147; *Brit. Assoc. Rep.* p. 418) appear to show that the rate of abstraction of heat by evaporation, or that of communication of heat by condensation, depends chiefly on the difference of temperature between the metal surface and the saturated steam, and is nearly proportional to the temperature difference (not to the pressure difference, as suggested by Reynolds) for such ranges of pressure as are common in practice. The rate of heat transmission they observed was equivalent to about 8 calories per sq. cm. per sec., for a difference of 20° C. between the temperature of the metal surface and the saturation temperature of the steam. This would correspond to a condensation of 530 kilogrammes of steam at 100° C. per sq. metre per hour, or 109 lb per sq. ft. per hour for the same difference of temperature, values which are many times greater than those actually obtained in ordinary surface condensers. The reason for this is that there is generally some air mixed with the steam in a surface condenser, which greatly retards the condensation. It is also difficult to keep the temperature of the metal as much as 20° C. below the temperature of the steam unless a very free and copious circulation of cold water is available. For the same difference of temperature, steam can supply heat by condensation about a thousand times faster than hot air. This rate is not often approached in practice, but the facility of generation and transmission of steam, combined with its high latent heat

and the accuracy of control and regulation of temperature afforded, render it one of the most convenient agents for the distribution of large quantities of heat in all kinds of manufacturing processes.

36. *Spheroidal State*.—An interesting contrast to the extreme rapidity with which heat is abstracted by the evaporation of a liquid in contact with a metal plate, is the so-called spheroidal state. A small drop of liquid thrown on a red-hot metal plate assumes a spheroidal form, and continues swimming about for some time, while it slowly evaporates at a temperature somewhat below its boiling-point. The explanation is simply that the liquid itself cannot come in actual contact with the metal plate (especially if the latter is above the critical temperature), but is separated from it by a badly conducting film of vapour, through which, as we have seen, the heat is comparatively slowly transmitted even if the difference of temperature is several hundred degrees. If the metal plate is allowed to cool gradually, the drop remains suspended on its cushion of vapour, until, in the case of water, a temperature of about 200° C. is reached, at which the liquid comes in contact with the plate and boils explosively, reducing the temperature of the plate, if thin, almost instantaneously to 100° C. The temperature of the metal is readily observed by a thermo-electric method, employing a platinum dish with a platinum-rhodium wire soldered with gold to its under side. The absence of contact between the liquid and the dish in the spheroidal state may also be shown by connecting one terminal of a galvanometer to the drop and the other through a battery to the dish, and observing that no current passes until the drop boils.

37. *Early Theories of Radiation*.—It was at one time supposed that there were three distinct kinds of radiation—thermal, luminous and actinic, combined in the radiation from a luminous source such as the sun or a flame. The first gave rise to heat, the second to light and the third to chemical action. The three kinds were partially separated by a prism, the actinic rays being generally more refracted, and the thermal rays less refracted than the luminous. This conception arose very naturally from the observation that the feebly luminous blue and violet rays produced the greatest photographic effects, which also showed the existence of dark rays beyond the violet, whereas the brilliant yellow and red were practically without action on the photographic plate. A thermometer placed in the blue or violet showed no appreciable rise of temperature, and even in the yellow the effect was hardly discernible. The effect increased rapidly as the light faded towards the extreme red, and reached a maximum beyond the extreme limits of the spectrum (Herschel), showing that the greater part of the thermal radiation was altogether non-luminous. It is now a commonplace that chemical action, colour sensation and heat are merely different effects of one and the same kind of radiation, the particular effect produced in each case depending on the frequency and intensity of the vibration, and on the nature of the substance on which it falls. When radiation is completely absorbed by a black substance, it is converted into heat, the quantity of heat produced being equivalent to the total energy of the radiation absorbed, irrespective of the colour or frequency of the different rays. The actinic or chemical effects, on the other hand, depend essentially on some relation between the period of the vibration and the properties of the substance acted on. The rays producing such effects are generally those which are most strongly absorbed. The spectrum of chlorophyll, the green colouring matter of plants, shows two very strong absorption bands in the red. The red rays of corresponding period are found to be the most active in promoting the growth of the plant. The chemically active rays are not necessarily the shortest. Even photographic plates may be made to respond to the red rays by staining them with pinachrome or some other suitable dye.

The action of light rays on the retina is closely analogous to the action on a photographic plate. The retina, like the plate, is sensitive only to rays within certain restricted limits of frequency. The limits of sensitiveness of each colour sensation are not exactly defined, but vary slightly from one individual

to another, especially in cases of partial colour-blindness, and are modified by conditions of fatigue. We are not here concerned with these important physiological and chemical effects of radiation, but rather with the question of the conversion of energy of radiation into heat, and with the laws of emission and absorption of radiation in relation to temperature. We may here also assume the identity of visible and invisible radiations from a heated body in all their physical properties. It has been abundantly proved that the invisible rays, like the visible, (1) are propagated in straight lines in homogeneous media; (2) are reflected and diffused from the surface of bodies according to the same law; (3) travel with the same velocity in free space, but with slightly different velocities in denser media, being subject to the same law of refraction; (4) exhibit all the phenomena of diffraction and interference which are characteristic of wave-motion in general; (5) are capable of polarization and double refraction; (6) exhibit similar effects of selective absorption. These properties are more easily demonstrated in the case of visible rays on account of the great sensitiveness of the eye. But with the aid of the thermopile or other sensitive radiometer, they may be shown to belong equally to all the radiations from a heated body, even such as are thirty to fifty times slower in frequency than the longest visible rays. The same physical properties have also been shown to belong to electromagnetic waves excited by an electric discharge, whatever the frequency, thus including all kinds of aetherial radiation in the same category as light.

38. *Theory of Exchanges*.—The apparent concentration of cold by a concave mirror, observed by G. B. Porta and rediscovered by M. A. Pictet, led to the enunciation of the theory of exchanges by Pierre Prevost in 1791. Prevost's leading idea was that all bodies, whether cold or hot, are constantly radiating heat. Heat equilibrium, he says, consists in an equality of exchange. When equilibrium is interfered with, it is re-established by inequalities of exchange. If into a locality at uniform temperature a refracting or reflecting body is introduced, it has no effect in the way of changing the temperature at any point of that locality. A reflecting body, heated or cooled in the interior of such an enclosure, will acquire the surrounding temperature more slowly than would a non-reflector, and will less affect another body placed at a little distance, but will not affect the final equality of temperature. Apparent radiation of cold, as from a block of ice to a thermometer placed near it, is due to the fact that the thermometer being at a higher temperature sends more heat to the ice than it received back from it. Although Prevost does not make the statement in so many words, it is clear that he regards the radiation from a body as depending only on its own nature and temperature, and as independent of the nature and presence of any adjacent body. Heat equilibrium in an enclosure of constant temperature such as is here postulated by Prevost, has often been regarded as a consequence of Carnot's principle. Since difference of temperature is required for transforming heat into work, no work could be obtained from heat in such a system, and no spontaneous changes of temperature can take place, as any such changes might be utilized for the production of work. This line of reasoning does not appear quite satisfactory, because it is tacitly assumed, in the reasoning by which Carnot's principle was established, as a result of universal experience, that a number of bodies within the same impervious enclosure, which contains no source of heat, will ultimately acquire the same temperature, and that difference of temperature is required to produce flow of heat. Thus although we may regard the equilibrium in such an enclosure as being due to equal exchanges of heat in all directions, the equal and opposite streams of radiation annul and neutralize each other in such a way that no actual transfer of energy in any direction takes place. The state of the medium is everywhere the same in such an enclosure, but its energy of agitation per unit volume is a function of the temperature, and is such that it would not be in equilibrium with any body at a different temperature.

39. *"Full" and Selective Radiation. Correspondence of Emission and Absorption*.—The most obvious difficulties in the

way of this theory arise from the fact that nearly all radiation is more or less selective in character, as regards the quality and frequency of the rays emitted and absorbed. It was shown by J. Leslie, M. Melloni and other experimentalists that many substances such as glass and water, which are very transparent to visible rays, are extremely opaque to much of the invisible radiation of lower frequency; and that polished metals, which are perfect reflectors, are very feeble radiators as compared with dull or black bodies at the same temperature. If two bodies emit rays of different periods in different proportions, it is not at first sight easy to see how their radiations can balance each other at the same temperature. The key to all such difficulties lies in the fundamental conception, so strongly insisted on by Balfour Stewart, of the absolute uniformity (qualitative as well as quantitative) of the full or complete radiation stream inside an impervious enclosure of uniform temperature. It follows from this conception that the proportion of the full radiation stream absorbed by any body in such an enclosure must be exactly compensated in quality as well as quantity by the proportion emitted, or that the emissive and absorptive powers of any body at a given temperature must be precisely equal. A good reflector, like a polished metal, must also be a feeble radiator and absorber. Of the incident radiation it absorbs a small fraction and reflects the remainder, which together with the radiation emitted (being precisely equal to that absorbed) makes up the full radiation stream. A partly transparent material, like glass, absorbs part of the full radiation and transmits part. But it emits rays precisely equal in quality and intensity to those which it absorbs, which together with the transmitted portion make up the full stream. The ideal black body or perfect radiator is a body which absorbs all the radiation incident on it. The rays emitted from such a body at any temperature must be equal to the full radiation stream in an isothermal enclosure at the same temperature. Lampblack, which may absorb between 98 to 99% of the incident radiation, is generally taken as the type of a black body. But a closer approximation to full radiation may be obtained by employing a hollow vessel the internal walls of which are blackened and maintained at a uniform temperature by a steam jacket or other suitable means. If a relatively small hole is made in the side of such a vessel, the radiation proceeding through the aperture will be the full radiation corresponding to the temperature. Such a vessel is also a perfect absorber. Of radiation entering through the aperture an infinitesimal fraction only could possibly emerge by successive reflection even if the sides were of polished metal internally. A thin platinum tube heated by an electric current appears feebly luminous as compared with a blackened tube at the same temperature. But if a small hole is made in the side of the polished tube, the light proceeding through the hole appears brighter than the blackened tube, as though the inside of the tube were much hotter than the outside, which is not the case to any appreciable extent if the tube is thin. The radiation proceeding through the hole is nearly that of a perfectly black body if the hole is small. If there were no hole the internal stream of radiation would be exactly that of a black body at the same temperature however perfect the reflecting power, or however low the emissive power of the walls, because the defect in emissive power would be exactly compensated by the internal reflection.

Balfour Stewart gave a number of striking illustrations of the qualitative identity of emission and absorption of a substance. Pieces of coloured glass placed in a fire appear to lose their colour when at the same temperature as the coals behind them, because they compensate exactly for their selective absorption by radiating chiefly those colours which they absorb. Rocksalt is remarkably transparent to thermal radiation of nearly all kinds, but it is extremely opaque to radiation from a heated plate of rocksalt, because it emits when heated precisely those rays which it absorbs. A plate of tourmaline cut parallel to the axis absorbs almost completely light polarized in a plane parallel to the axis, but transmits freely light polarized in a perpendicular plane. When heated its radiation is polarized in the same plane as the radiation which it absorbs. In the case

of incandescent vapours, the exact correspondence of emission and absorption as regards wave-length or frequency of the light emitted and absorbed forms the foundation of the science of spectrum analysis. Fraunhofer had noticed the coincidence of a pair of bright yellow lines seen in the spectrum of a candle flame with the dark D lines in the solar spectrum, a coincidence which was afterwards more exactly verified by W. A. Miller. Foucault found that the flame of the electric arc showed the same lines bright in its spectrum, and proved that they appeared as dark lines in the otherwise continuous spectrum when the light from the carbon poles was transmitted through the arc. Stokes gave a dynamical explanation of the phenomenon and illustrated it by the analogous case of resonance in sound. Kirchhoff completed the explanation (*Phil. Mag.*, 1869) of the dark lines in the solar spectrum by showing that the reversal of the spectral lines depended on the fact that the body of the sun giving the continuous spectrum was at a higher temperature than the absorbing layer of gases surrounding it. Whatever be the nature of the selective radiation from a body, the radiation of light of any particular wave-length cannot be greater than a certain fraction E of the radiation R of the same wave-length from a black body at the same temperature. The fraction E measures the emissive power of the body for that particular wave-length, and cannot be greater than unity. The same fraction, by the principle of equality of emissive and absorptive powers, will measure the proportion absorbed of incident radiation R' . If the black body emitting the radiation R' is at the same temperature as the absorbing layer, $R = R'$, the emission balances the absorption, and the line will appear neither bright nor dark. If the source and the absorbing layer are at different temperatures, the radiation absorbed will be ER' , and that transmitted will be $R' - ER'$. To this must be added the radiation emitted by the absorbing layer, namely ER , giving $R' - E(R' - R)$. The lines will appear darker than the background R' if R' is greater than R , but bright if the reverse is the case. The D lines are dark in the sun because the photosphere is much hotter than the reversing layer. They appear bright in the candle-flame because the outside mantle of the flame, in which the sodium burns and combustion is complete, is hotter than the inner reducing flame containing the incandescent particles of carbon which give rise to the continuous spectrum. This qualitative identity of emission and absorption as regards wave-length can be most exactly and easily verified for luminous rays, and we are justified in assuming that the relation holds with the same exactitude for non-luminous rays, although in many cases the experimental proof is less complete and exact.

40. *Diathermancy*.—A great array of data with regard to the transmissive power or diathermancy of transparent substances for the heat radiated from various sources at different temperatures were collected by Melloni, Tyndall, Magnus and other experimentalists. The measurements were chiefly of a qualitative character, and were made by interposing between the source and a thermopile a layer or plate of the substance to be examined. This method lacked quantitative precision, but led to a number of striking and interesting results, which are admirably set forth in Tyndall's *Heat*. It also gave rise to many curious discrepancies, some of which were recognized as being due to selective absorption, while others are probably to be explained by imperfections in the methods of experiment adopted. The general result of such researches was to show that substances, like water, alum and glass, which are practically opaque to radiation from a source at low temperature, such as a vessel filled with boiling water, transmit an increasing percentage of the radiation when the temperature of the source is increased. This is what would be expected, as these substances are very transparent to visible rays. That the proportion transmitted is not merely a question of the temperature of the source, but also of the quality of the radiation, was shown by a number of experiments. For instance, K. H. Knoblauch (*Pogg. Ann.*, 1847) found that a plate of glass interposed between a spirit lamp and a thermopile intercepts a larger proportion of the radiation from the flame itself than of the radiation from a platinum spiral heated in the flame,

although the spiral is undoubtedly at a lower temperature than the flame. The explanation is that the spiral is a fairly good radiator of the visible rays to which the glass is transparent, but a bad radiator of the invisible rays absorbed by the glass which constitute the greater portion of the heat-radiation from the feebly luminous flame.

Assuming that the radiation from the source under investigation is qualitatively determinate, like that of a black body at a given temperature, the proportion transmitted by plates of various substances may easily be measured and tabulated for given plates and sources. But owing to the highly selective character of the radiation and absorption, it is impossible to give any general relation between the thickness of the absorbing plate or layer and the proportion of the total energy absorbed. For these reasons the relative diathermancies of different materials do not admit of any simple numerical statement as physical constants, though many of the qualitative results obtained are very striking. Among the most interesting experiments were those of Tyndall, on the absorptive powers of gases and vapours, which led to a good deal of controversy at the time, owing to the difficulty of the experiments, and the contradictory results obtained by other observers. The arrangement employed by Tyndall for these measurements is shown in Fig. 6. A brass

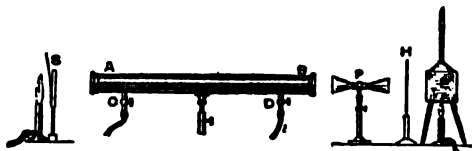

FIG. 6.—Tyndall's Apparatus for observing absorption of heat by gas and vapours.

tube AB, polished inside, and closed with plates of highly diathermanous rocksalt at either end, was fitted with stopcocks C and D for exhausting and admitting air or other gases or vapours. The source of heat S was usually a plate of copper heated by a Bunsen burner, or a Leslie cube containing boiling water as shown at E. To obtain greater sensitiveness for differential measurements, the radiation through the tube AB incident on one face of the pile P was balanced against the radiation from a Leslie cube on the other face of the pile by means of an adjustable screen H. The radiation on the two faces of the pile being thus balanced with the tube exhausted, Tyndall found that the admission of dry air into the tube produced practically no absorption of the radiation, whereas compound gases such as carbonic acid, ethylene or ammonia absorbed 20 to 90%, and a trace of aqueous vapour in the air increased its absorption 50 to 100 times. H. G. Magnus, on the other hand, employing a thermopile and a source of heat, both of which were enclosed in the same exhausted receiver, in order to avoid interposing any rocksalt or other plates between the source and the pile, found an absorption of 11% on admitting dry air, but could not detect any difference whether the air were dry or moist. Tyndall suggested that the apparent absorption observed by Magnus may have been due to the cooling of his radiating surface by convection, which is a very probable source of error in this method of experiment. Magnus considered that the remarkable effect of aqueous vapour observed by Tyndall might have been caused by condensation on the polished internal walls of his experimental tube, or on the rocksalt plates at either end.¹ The question of

¹ In reference to this objection, Tyndall remarks (*Phil. Mag.*, 1862, p. 422; *Heat*, p. 385): "In the first place the plate of salt nearest the source of heat is never moistened, unless the experiments are of the roughest character. Its proximity to the source enables the heat to chase away every trace of humidity from its surface." He therefore took precautions to dry only the circumferential portions of the plate nearest the pile, assuming that the flux of heat through the central portions would suffice to keep them dry. This reasoning is not at all satisfactory, because rocksalt is very hygroscopic and becomes wet, even in unsaturated air, if the vapour pressure is greater than that of a saturated solution of salt at the

relative diathermancy of air and aqueous vapour for radiation from the sun to the earth and from the earth into space is one of great interest and importance in meteorology. Assuming with Magnus that at least 10% of the heat from a source at 100° C. is absorbed in passing through a single foot of air, a very moderate thickness of atmosphere should suffice to absorb practically all the heat radiated from the earth into space. This could not be reconciled with well-known facts in regard to terrestrial radiation, and it was generally recognized that the result found by Magnus must be erroneous. Tyndall's experiment on the great diathermancy of dry air agreed much better with meteorological phenomena, but he appears to have exaggerated the effect of aqueous vapour. He concluded from his experiments that the water vapour present in the air absorbs at least 10% of the heat radiated from the earth within 10 ft. of its surface, and that the absorptive power of the vapour is about 17,000 times that of air at the same pressure. If the absorption of aqueous vapour were really of this order of magnitude, it would exert a far greater effect in modifying climate than is actually observed to be the case. Radiation is observed to take place freely through the atmosphere at times when the proportion of aqueous vapour is such as would practically stop all radiation if Tyndall's results were correct. The very careful experiments of E. Lecher and J. Pernter (*Phil. Mag.*, Jan. 1881) confirmed Tyndall's observations on the absorptive powers of gases and vapours satisfactorily in nearly all cases with the single exception of aqueous vapour. They found that there was no appreciable absorption of heat from a source at 100° C. in passing through 1 ft. of air (whether dry or moist), but that CO and CO₂ at atmospheric pressure absorbed about 8%, and ethylene (olefiant gas) about 50% in the same distance; the vapours of alcohol and ether showed absorptive powers of the same order as that of ethylene. They confirmed Tyndall's important result that the absorption does not diminish in proportion to the pressure, being much greater in proportion for smaller pressures in consequence of the selective character of the effect. They also supported his conclusion that absorptive power increases with the complexity of the molecule. But they could not detect any absorption by water vapour at a pressure of 7 mm., though alcohol at the same pressure absorbed 3% and acetic acid 10%. Later researches, especially those of S. P. Langley with the spectro-bolometer on the infra-red spectrum of sunlight, demonstrated the existence of marked absorption bands, some of which are due to water vapour. From the character of these bands and the manner in which they vary with the state of the air and the thickness traversed, it may be inferred that absorption by water vapour plays an important part in meteorology, but that it is too small to be temperature of the plate. Assuming that the vapour pressure of the saturated salt solution is only half that of pure water, it would require an elevation of temperature of 10° C. to dry the rocksalt plates in saturated air at 13° C. It is only fair to say that the laws of the vapour pressures of solutions were unknown in Tyndall's time, and that it was usual to assume that the plates would not become wetted until the dew-point was reached. The writer has repeated Tyndall's experiments with a facsimile of one of Tyndall's tubes in the possession of the Royal College of Science, fitted with plates of rocksalt cut from the same block as Tyndall's, and therefore of the same hygroscopic quality. Employing a reflecting galvanometer in conjunction with a differential bolometer, which is quicker in its action than Tyndall's pile, there appears to be hardly any difference between dry and moist air, provided that the latter is not more than half saturated. Using saturated air with a Leslie cube as source of heat, both rocksalt plates invariably become wet in a minute or two and the absorption rises to 10 or 20% according to the thickness of the film of deposited moisture. Employing the open tube method as described by Tyndall, without the rocksalt plates, the absorption is certainly less than 1% in 3 ft. of air saturated at 20° C., unless condensation is induced on the walls of the tube. It is possible that the walls of Tyndall's tube may have become covered with a very hygroscopic film from the powder of the calcium chloride which he was in the habit of introducing near one end. Such a film would be exceedingly difficult to remove, and would account for the excessive precautions which he found necessary in drying the air in order to obtain the same transmitting power as a vacuum. It is probable that Tyndall's experiments on aqueous vapour were effected by experimental errors of this character.

readily detected by laboratory experiments in a 4 ft. tube, without the aid of spectrum analysis.

41. *Relation between Radiation and Temperature.*—Assuming, in accordance with the reasoning of Balfour Stewart and Kirchhoff, that the radiation stream inside an impervious enclosure at a uniform temperature is independent of the nature of the walls of the enclosure, and is the same for all substances at the same temperature, it follows that the full stream of radiation in such an enclosure, or the radiation emitted by an ideal black body or full radiator, is a function of the temperature only. The form of this function may be determined experimentally by observing the radiation between two black bodies at different temperatures, which will be proportional to the difference of the full radiation streams corresponding to their several temperatures. The law now generally accepted was first proposed by Stefan as an empirical relation. Tyndall had found that the radiation from a white hot platinum wire at 1200° C. was 11.7 times its radiation when dull red at 525° C. Stefan (*Wien. Akad. Ber.*, 1879, 79, p. 421) noticed that the ratio 11.7 is nearly that of the fourth power of the absolute temperatures as estimated by Tyndall. On making the somewhat different assumption that the radiation between two bodies varied as the difference of the fourth powers of their absolute temperatures, he found that it satisfied approximately the experiments of Dulong and Petit and other observers. According to this law the radiation between a black body at a temperature θ and a black enclosure or a black radiometer at a temperature θ_0 should be proportional to $(\theta^4 - \theta_0^4)$. The law was very simple and convenient in form, but it rested so far on very insecure foundations. The temperatures given by Tyndall were merely estimated from the colour of the light emitted, and might have been some hundred degrees in error. We now know that the radiation from polished platinum is of a highly selective character, and varies more nearly as the fifth power of the absolute temperature. The agreement of the fourth power law with Tyndall's experiment appears therefore to be due to a purely accidental error in estimating the temperatures of the wire. Stefan also found a very fair agreement with Draper's observations of the intensity of radiation from a platinum wire, in which the temperature of the wire was deduced from the expansion. Here again the apparent agreement was largely due to errors in estimating the temperature, arising from the fact that the coefficient of expansion of platinum increases considerably with rise of temperature. So far as the experimental results available at that time were concerned, Stefan's law could be regarded only as an empirical expression of doubtful significance. But it received a much greater importance from theoretical investigations which were even then in progress. James Clerk Maxwell (*Electricity and Magnetism*, 1873) had shown that a directed beam of electromagnetic radiation or light incident normally on an absorbing surface should produce a mechanical pressure equal to the energy of the radiation per unit volume. A. G. Bartoli (1875) took up this idea and made it the basis of a thermodynamic treatment of radiation. P. N. Lebedew in 1900, and E. F. Nichols and G. F. Hull in 1901, proved the existence of this pressure by direct experiments. L. Boltzmann (1884) employing radiation as the working substance in a Carnot cycle, showed that the energy of full radiation at any temperature per unit volume should be proportional to the fourth power of the absolute temperature. This law was first verified in a satisfactory manner by Heinrich Schneebeli (*Wied. Ann.*, 1884, 22, p. 30). He observed the radiation from the bulb of an air thermometer heated to known temperatures through a small aperture in the walls of the furnace. With this arrangement the radiation was very nearly that of a black body. Measurements by J. T. Bottomley, August Schlieiermacher, L. C. H. F. Paschen and others of the radiation from electrically heated platinum, failed to give concordant results on account of differences in the quality of the radiation, the importance of which was not fully realized at first. Later researches by Paschen with improved methods verified the law, and greatly extended our knowledge of radiation in other directions. One of the most complete series of experiments on

the relation between full radiation and temperature is that of O. R. Lummer and Ernst Pringsheim (*Ann. Phys.*, 1897, 63, p. 395). They employed an aperture in the side of an enclosure at uniform temperature as the source of radiation, and compared the intensities at different temperatures by means of a bolometer. The fourth power law was well satisfied throughout the whole range of their experiments from -190° C. to 2300° C. According to this law, the rate of loss of heat by radiation R from a body of emissive power E and surface S at a temperature θ in an enclosure at θ_0 is given by the formula

$$R = \sigma ES(\theta^4 - \theta_0^4),$$

where σ is the radiation constant. The absolute value of σ was determined by F. Kurlbaum using an electric compensation method (*Wied. Ann.*, 1898, 65, p. 746), in which the radiation received by a bolometer from a black body at a known temperature was measured by finding the electric current required to produce the same rise of temperature in the bolometer. K. Ångström employed a similar method for solar radiation. Kurlbaum gives the value $\sigma = 5.32 \times 10^{-8}$ ergs per sq. cm. per sec. C. Christiansen (*Wied. Ann.*, 1883, 19, p. 267) had previously found a value about 5% smaller, by observing the rate of cooling of a copper plate of known thermal capacity, which is probably a less accurate method.

42. *Theoretical Proof of the Fourth Power Law.*—The proof given by Boltzmann may be somewhat simplified if we observe that full radiation in an enclosure at constant temperature behaves exactly like a saturated vapour, and must therefore obey Carnot's or Clapeyron's equation given in section 17. The energy of radiation per unit volume, and the radiation-pressure at any temperature, are functions of the temperature only, like the pressure of a saturated vapour. If the volume of the enclosure is increased by any finite amount, the temperature remaining the same, radiation is given off from the walls so as to fill the space to the same pressure as before. The heat absorbed when the volume is increased corresponds with the latent heat of vaporization. In the case of radiation, as in the case of a vapour, the latent heat consists partly of internal energy of formation and partly of external work of expansion at constant pressure. Since in the case of full or undirected radiation the pressure is one-third of the energy per unit volume, the external work for any expansion is one-third of the internal energy added. The latent heat absorbed is, therefore, four times the external work of expansion. Since the external work is the product of the pressure P and the increase of volume V , the latent heat per unit increase of volume is four times the pressure. But by Carnot's equation the latent heat of a saturated vapour per unit increase of volume is equal to the rate of increase of saturation-pressure per degree divided by Carnot's function or multiplied by the absolute temperature. Expressed in symbols we have,

$$\theta(dP/d\theta) = LV = 4P,$$

where $(dP/d\theta)$ represents the rate of increase of pressure. This equation shows that the percentage rate of increase of pressure is four times the percentage rate of increase of temperature, or that if the temperature is increased by 1%, the pressure is increased by 4%. This is equivalent to the statement that the pressure varies as the fourth power of the temperature, a result which is mathematically deduced by integrating the equation.

43. *Wien's Displacement Law.*—Assuming that the fourth power law gives the quantity of full radiation at any temperature, it remains to determine how the quality of the radiation varies with the temperature, since as we have seen both quantity and quality are determinate. This question may be regarded as consisting of two parts. (1) How is the wave-length or frequency of any given kind of radiation changed when its temperature is altered? (2) What is the form of the curve expressing the distribution of energy between the various wave-lengths in the spectrum of full radiation, or what is the distribution of heat in the spectrum? The researches of Tyndall, Draper, Langley and other investigators had shown that while the energy of radiation of each frequency increased with rise of temperature, the maximum of intensity was shifted or displaced along the spectrum in the direction of shorter wave-lengths or higher frequencies. W. Wien (*Ann. Phys.*, 1898, 58, p. 662), applying Doppler's principle to the adiabatic compression of radiation in a perfectly reflecting enclosure, deduced that the wave-length of each constituent of the radiation should be shortened in proportion to the rise of temperature produced

by the compression, in such a manner that the product $\lambda\theta$ of wave-length and the absolute temperature should remain constant. According to this relation, which is known as Wien's Displacement Law, the frequency corresponding to the maximum ordinate of the energy curve of the normal spectrum of full radiation should vary directly (or the wave-length inversely) as the absolute temperature, a result previously obtained by H. F. Weber (1888). Paschen, and Lummer and Pringsheim verified this relation by observing with a bolometer the intensity at different points in the spectrum produced by a fluorite prism. The intensities were corrected and reduced to a wave-length scale with the aid of Paschen's results on the dispersion formula of fluorite (*Wied Ann.*, 1894, 53, p. 301). The curves in fig. 7 illustrate results obtained by Lummer and Pringsheim (*Ber. deut. phys. Ges.*, 1899, 1, p. 34) at three different temperatures, namely 1377°, 1087° and 836° absolute, plotted on a wave-length base with a scale of microns (μ) or millionths of a metre. The wave-lengths Oa , Ob , Oc , corresponding to the maximum ordinates of each curve, vary inversely as the absolute temperatures given. The constant value of the product $\lambda\theta$ at the maximum point is found to be 2920. Thus for a temperature of 1000° Abs. the maximum is at wave-length 2.92 μ ; at 2000° the maximum is at 1.46 μ .

44. *Form of the Curve representing the Distribution of Energy in the Spectrum.*—Assuming Wien's displacement law, it follows that the form of the curve representing the distribution of energy in the spectrum of full radiation should be the same for different temperatures with the maximum displaced in proportion to the absolute temperature, and with the total area increased in proportion to the fourth power of the absolute temperature. Observations taken with a bolometer along the length of a normal or wave-length spectrum, would give the form of the curve plotted on a wave-length base. The height of the ordinate at each point would represent the energy included between given limits of wave-length, depending on the width of the bolometer strip and the slit. Supposing that the bolometer strip had a width corresponding to .01 μ , and were placed at 1.0 μ in the spectrum of radiation at 2000° Abs., it would receive the energy corresponding to wave-lengths between 1.00 and 1.01 μ . At a temperature of 1000° Abs. the corresponding part of the energy, by Wien's displacement law, would lie between the limits 2.00 and 2.02 μ , and the total energy between these limits would be 16 times smaller. But the bolometer strip placed at 2.0 μ would now receive only half of the energy, or the energy in a band .01 μ wide, and the deflection would be 32 times less. Corresponding ordinates of the curves at different temperatures will therefore vary as the fifth power of the temperature, when the curves are plotted on a wave-length base. The maximum ordinates in the curves already given are found to vary as the fifth powers of the corresponding temperatures. The equation representing the distribution of energy on a wave-length base must be of the form

$$E = C\lambda^{-5} F(\lambda\theta) = C\theta^5 (\lambda\theta)^{-5} F(\lambda\theta)$$

where $F(\lambda\theta)$ represents some function of the product of the wave-length and temperature, which remains constant for corresponding wave-lengths when θ is changed. If the curves were plotted on a frequency base, owing to the change of scale, the maximum ordinates would vary as the cube of the temperature instead of the fifth power, but the form of the function F would remain unaltered. Reasoning on the analogy of the distribution of velocities among the particles of a gas on the kinetic theory, which is a very similar problem, Wien was led to assume that the function F should be of the form $e^{-\epsilon/\lambda\theta}$, where e is the base of Napierian logarithms, and ϵ is a constant having the value 14,600 if the wave-length is measured in microns μ . This expression was found by Paschen to give a very good approximation to the form of the curve obtained experimentally for those portions of the visible and infra-red spectrum where observations could be most accurately made. The formula was tested in two ways: (1) by plotting the curves of distribution of energy in the spectrum for constant temperatures as illustrated in

fig. 7; (2) by plotting the energy corresponding to a given wave-length as a function of the temperature. Both methods gave very good agreement with Wien's formula for values of the product $\lambda\theta$ not much exceeding 3000. A method of isolating rays of great wave-length by successive reflection was devised by H. Rubens and E. F. Nichols (*Wied. Ann.*, 1897, 60, p. 418). They found that quartz and fluorite possessed the property of selective reflection for rays of wave-length 8.8 μ and 24 μ to 32 μ respectively, so that after four to six reflections these rays could be isolated from a source at any temperature in a state of considerable purity. The residual impurity at any stage could be estimated

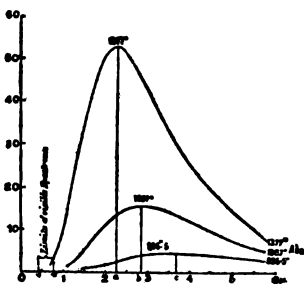

FIG. 7.—Distribution of energy in the spectrum of a black body.

by interposing a thin plate of quartz or fluorite which completely reflected or absorbed the residual rays, but allowed the impurity to pass. H. Beckmann, under the direction of Rubens, investigated the variation with temperature of the residual rays reflected from fluorite employing sources from -80° to 600° C., and found the results could not be represented by Wien's formula unless the constant c were taken as 26,000 in place of 14,600. In their first series of observations extending to 6 μ O.R. Lummer and E. Pringsheim (*Deut. phys. Ges.*, 1899, 1, p. 34) found systematic deviations indicating an increase in the value of the constant c for long waves and high temperatures. In a theoretical discussion of the subject, Lord Rayleigh (*Phil. Mag.*, 1900, 49, p. 539) pointed out that Wien's law would lead to a limiting value $C\lambda^{-5}$, of the radiation corresponding to any particular wave-length when the temperature increased to infinity, whereas according to his view the radiation of great wave-length should ultimately increase in direct proportion to the temperature. Lummer and Pringsheim (*Deut. phys. Ges.*, 1900, 2, p. 163) extended the range of their observations to 18 μ by employing a prism of sylvine in place of fluorite. They found deviations from Wien's formula increasing to nearly 50% at 18 μ , where, however, the observations were very difficult on account of the smallness of the energy to be measured. Rubens and F. Kurlbaum (*Ann. Phys.*, 1901, 4, p. 649) extended the residual reflection method to a temperature range from -190° to 1500° C., and employed the rays reflected

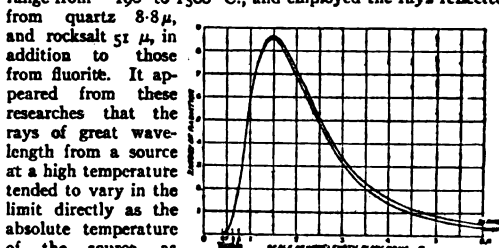

FIG. 8.—Distribution of energy in the spectrum of full radiation at 2000° Abs. according to formulae of Planck & Wien.

from quartz 8.8 μ , and rocksalt 51 μ , in addition to those from fluorite. It appeared from these researches that the rays of great wave-length from a source at a high temperature tended to vary in the limit directly as the absolute temperature of the source, as suggested by Lord Rayleigh, and could not be represented by Wien's formula with any value of the constant c . The simplest type of formula satisfying the required conditions is that proposed by Max Planck (*Ann. Phys.*, 1901, 4, p. 553) namely,

$$E = C\lambda^{-5} (\epsilon/\lambda\theta - 1)^{-1}$$

which agrees with Wien's formula when θ is small, where Wien's formula is known to be satisfactory, but approaches the limiting

form $E = C\lambda^{-5}/c$, when θ is large, thus satisfying the condition proposed by Lord Rayleigh. The theoretical interpretation of this formula remains to some extent a matter of future investigation, but it appears to satisfy experiment within the limits of observational error. In order to compare Planck's formula graphically with Wien's, the distribution curves corresponding to both formulæ are plotted in fig. 8 for a temperature of 2000° abs., taking the value of the constant $c = 14,600$ with a scale of wave-length in microns μ .

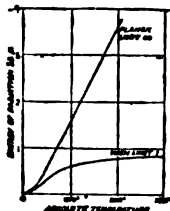

FIG. 9.—Variation of energy of radiation corresponding to wave-length 30μ , with temperature of source.

fig. 8 by 2; or to find the variation curve for wave-length 60μ , the numbers on the temperature scale of fig. 9 should be divided by 2. The ordinate scales must be increased in proportion to the fifth power of the temperature, or inversely as the fifth power of the wave-length respectively in figs. 8 and 9 if comparative results are required for different temperatures or wave-lengths. The results hitherto obtained for cases other than full radiation are not sufficiently simple and definite to admit of profitable discussion in the present article.

BIBLIOGRAPHY.—It would not be possible, within the limits of an article like the present, to give tables of the specific thermal properties of different substances so far as they have been ascertained by experiment. To be of any use, such tables require to be extremely detailed, with very full references and explanations with regard to the value of the experimental evidence, and the limits within which the results may be relied on. The quantity of material available is so enormous and its value so varied, that the most elaborate tables still require reference to the original authorities. Much information will be found collected in Landolt and Bornstein's *Physical and Chemical Tables* (Berlin, 1905). Shorter tables, such as Everett's *Units and Physical Constants*, are useful as illustrations of a system, but are not sufficiently complete for use in scientific investigations. Some of the larger works of reference, such as A. A. Winkelmann's *Handbuch der Physik*, contain fairly complete tables of specific properties, but these tables occupy so much space, and are so misleading if incomplete, that they are generally omitted in theoretical textbooks.

Among older textbooks on heat, Tyndall's *Heat* may be recommended for its vivid popular interest, and Balfour Stewart's *Heat* for early theories of radiation. Maxwell's *Theory of Heat* and Tait's *Heat* give a broad and philosophical survey of the subject. Among modern textbooks, Preston's *Theory of Heat* and Poynting and Thomson's *Heat* are the best known, and have been brought well up to date. Sections on heat are included in all the general textbooks of Physics, such as those of Deschanel (translated by Everett), Ganot (translated by Atkinson), Daniell, Watson, &c. Of the original investigations on the subject, the most important have already been cited. Others will be found in the collected papers of Joule, Kelvin and Maxwell. Treatises on special branches of the subject, such as Fourier's *Conduction of Heat*, are referred to in the separate articles in this encyclopædia dealing with recent progress, of which the following is a list: CALORIMETRY, CONDENSATION OF GASES, CONDUCTION OF HEAT, DIFFUSION, ENERGETICS, FUSION, LIQUID GASES, RADIATION, RADIOMETER, SOLUTION, THERMODYNAMICS, THERMOELECTRICITY, THERMOMETRY, VAPORIZATION. For the practical aspects of heating see HEATING. (H. L. C.)

HEATH, BENJAMIN (1704–1766), English classical scholar and bibliophile, was born at Exeter on the 20th of April 1704. He was the son of a wealthy merchant, and was thus able to devote himself mainly to travel and book-collecting. He became town clerk of his native city in 1752, and held the office till his death on the 13th of September 1766. In 1763 he had published a pamphlet advocating the repeal of the cider tax in Devonshire, and his endeavours led to success three years later. As a classical scholar he made his reputation by his critical and metrical notes on the Greek tragedians, which procured him an honorary

D.C.L. from Oxford (31st of March 1752). He also left MS. notes on Burmann's and Martyn's editions of Virgil, on Euripides, Catullus, Tibullus, and the greater part of Hesiod. In some of these he adopts the whimsical name *Deixades Erius*. His *Revisal of Shakespear's Text* (1765) was an answer to the "insolent dogmatism" of Bishop Warburton. The *Essay towards a Demonstrative Proof of the Divine Existence, Unity and Attributes* (1740) was intended to combat the opinions of Voltaire, Rousseau and Hume. Two of his sons (among a family of thirteen) were Benjamin, headmaster of Harrow (1771–1785), and George, headmaster of Eton (1796). His collection of rare classical works formed the nucleus of his son Benjamin's famous library (Bibliotheca Heathiana).

An account of the Heath family will be found in Sir W. R. Drake's *Heathiana* (1882).

HEATH, NICHOLAS (c. 1501–1578), archbishop of York and lord chancellor, was born in London about 1501 and graduated B.A. at Oxford in 1519. He then migrated to Christ's College, Cambridge, where he graduated B.A. in 1520, M.A. in 1522, and was elected fellow in 1524. After holding minor preferments he was appointed archdeacon of Stafford in 1534 and graduated D.D. in 1535. He then accompanied Edward Fox (q.v.), bishop of Hereford, on his mission to promote a theological and political understanding with the Lutheran princes of Germany. His selection for this duty implies a readiness on Heath's part to proceed some distance along the path of reform; but his dealings with the Lutherans did not confirm this tendency, and Heath's subsequent career was closely associated with the cause of reaction. In 1539, the year of the Six Articles, he was made bishop of Rochester, and in 1543 he succeeded Latimer at Worcester. His Catholicism, however, was of a less rigid type than Gardiner's and Bonner's; he felt something of the force of the national antipathy to foreign influence, whether ecclesiastical or secular, and was always impressed by the necessity of national unity, so far as was possible, in matters of faith. Apparently he made no difficulty about carrying out the earlier reforms of Edward VI., and he accepted the first book of common prayer after it had been modified by the House of Lords in a Catholic direction.

His definite breach with the Reformation occurred on the grounds, on which four centuries later Leo XIII. denied the Catholicity of the reformed English Church, namely, on the question of the Ordinal drawn up in February 1550. Heath refused to accept it, was imprisoned, and in 1551 deprived of his bishopric. On Mary's accession he was released and restored, and made president of the council of the Marches and Wales. In 1555 he was promoted to the archbishopric of York, which he did much to enrich after the Protestant spoliation; he built York House in the Strand. After Gardiner's death he was appointed lord chancellor, probably on Pole's recommendation; for Heath, like Pole himself, disliked the Spanish party in England. Unlike Pole, however, he seems to have been averse from the excessive persecution of Mary's reign, and no Protestants were burnt in his diocese. He exercised, however, little influence on Mary's secular or ecclesiastical policy.

On Mary's death Heath as chancellor at once proclaimed Elizabeth. Like Sir Thomas More he held that it was entirely within the competence of the national state, represented by parliament, to determine questions of the succession to the throne; and although Elizabeth did not renew his commission as lord chancellor, he continued to sit in the privy council for two months until the government had determined to complete the breach with the Roman Catholic Church; and as late as April 1559 he assisted the government by helping to arrange the Westminster Conference, and reproving his more truculent co-religionists. He refused to crown Elizabeth because she would not have the coronation service accompanied with the elevation of the Host; and ecclesiastical ceremonies and doctrine could not, in Heath's view, be altered or abrogated by any mere national authority. Hence he steadily resisted Elizabeth's acts of supremacy and uniformity, although he had acquiesced in the acts of 1534 and 1540. Like others of Henry's bishops, he had been convinced by the events of Edward VI.'s reign that Sir

Thomas More was right and Henry VIII. was wrong in their attitude towards the claims of the papacy and the Catholic Church. He was therefore necessarily deprived of his archbishopric in 1539, but he remained loyal to Elizabeth; and after a temporary confinement he was suffered to pass the remaining nineteen years of his life in peace and quiet, never attending public worship and sometimes hearing mass in private. The queen visited him more than once at his house at Chobham, Surrey; he died and was buried there at the end of 1578.

AUTHORITIES.—Letters and Papers of Henry VIII.; Acts of the Privy Council; Cal. State Papers. Domestic, Addenda, Spanish and Venetian; Kemp's Loseley MSS.; Froude's *History*; Burnet, Collier, Dixon and Frere's *Church Histories*; Strype's *Works* (General Index); Parker Soc. Publications (Gough's Index); Birt's *Elizabethan Settlement*. (A. F. P.)

HEATH, WILLIAM (1737-1814), American soldier, was born in Roxbury, Massachusetts, on the 2nd of March 1737 (old style). He was brought up as a farmer and had a passion for military exercises. In 1765 he entered the Ancient and Honourable Artillery Company of Boston, of which he became commander in 1770. In the same year he wrote to the *Boston Gazette* letters signed "A Military Countryman," urging the necessity of military training. He was a member of the Massachusetts General Court from 1770 to 1774, of the provincial committee of safety, and in 1774-1775 of the provincial congress. He was commissioned a provincial brig-general in December 1774, directed the pursuit of the British from Concord (April 19, 1775), was promoted to be provincial major-general on the 20th of June 1775, and two days later was commissioned fourth brig-general in the Continental Army. He became major-general on the 9th of August 1776, and was in active service around New York until early the next year. In January 1777 he attempted to take Fort Independence, near Spuyten Duyvil, then garrisoned by about 2000 Hessians, but at the first sally of the garrison his troops became panic-stricken and a few days later he withdrew. Washington reprimanded him and never again entrusted to him any important operation in the field. Throughout the war, however, Heath was very efficient in muster service and in the barracks. From March 1777 to October 1778 he was in command of the Eastern Department with headquarters at Boston, and had charge (Nov. 1777-Oct. 1778) of the prisoners of war from Burgoyne's army held at Cambridge, Massachusetts. In May 1779 he was appointed a commissioner of the Board of War. He was placed in command of the troops on the E. side of the Hudson in June 1779, and of other troops and posts on the Hudson in November of the same year. In July 1780 he met the French allies under Rochambeau on their arrival in Rhode Island; in October of the same year he succeeded Arnold in command of West Point and its dependencies; and in August 1781, when Washington went south to meet Cornwallis, Heath was left in command of the Army of the Hudson to watch Clinton. After the war he retired to his farm at Roxbury, was a member of the state House of Representatives in 1788, of the Massachusetts convention which ratified the Federal Constitution in the same year, and of the governor's council in 1789-1790, was a state senator (1791-1793), and in 1806 was elected lieutenant-governor of Massachusetts but declined to serve. He died at Roxbury on the 24th of January 1814, the last of the major-generals of the War of American Independence.

See *Memoirs of Major-General Heath, containing Anecdotes, Details of Skirmishes, Battles and other Military Events during the American War, written by Himself* (Boston, 1798; frequently reprinted, perhaps the best edition being that published in New York in 1901 by William Abbott), particularly valuable for the descriptions of Lexington and Bunker Hill, of the fighting around New York, of the controversies with Burgoyne and his officers during their stay in Boston, and of relations with Rochambeau; and his correspondence, *The Heath Papers*, vols. iv.-v., seventh series, *Massachusetts Historical Society Collections* (Boston, 1904-1905).

HEATH, the English form of a name given in most Teutonic dialects to the common ling or heather (*Calluna vulgaris*), but now applied to all species of *Erica*, an extensive genus of monoptetalous plants, belonging to the order Ericaceae. The heaths are evergreen shrubs, with small narrow leaves, in whorls usually

set rather thickly on the shoots; the persistent flowers have 4 sepals, and a 4-cleft campanulate or tubular corolla, in many species more or less ventricose or inflated; the dry capsule is 4-celled, and opens, in the true *Ericaceae*, in 4 segments, to the middle of which the partitions adhere, though in the ling the valves separate at the dissepiments. The plants are mostly of low growth, but several African kinds reach the size of large bushes, and a common South European species, *E. arborea*, occasionally attains almost the aspect and dimensions of a tree.

One of the best known and most interesting of the family is the common heath, heather or ling, *Calluna vulgaris* (fig. 1),

placed by most botanists in a separate genus on account of the peculiar dehiscence of the fruit, and from the coloured calyx, which extends beyond the corolla, having a whorl of sepal-like bracts beneath. This shrub derives some economic importance from its forming the chief vegetation on many of those extensive wastes that occupy so large a portion of the more sterile lands of northern and western Europe, the usually desolate appearance of which is enlivened in the latter part of summer by its abundant pink blossoms. When growing erect to the height of 3 ft. or more, as it often does in sheltered places, its purple stems, clove-leaved green shoots and feathery spikes of bell-shaped flowers render it one of the handsomest of the heaths; but on the bleaker elevations and more arid slopes it frequently rises only a few inches above the ground. In all moorland countries the ling is applied to many rural purposes; the larger stems are made into brooms, the shorter tied up into bundles that serve as brushes, while the long trailing shoots are woven into baskets. Pared up with the peat about its roots it forms a good fuel, often the only one obtainable on the drier moors. The shielings of the Scottish Highlanders were formerly constructed of heath stems, cemented together with peat-mud, worked into a kind of mortar with dry grass or straw; hovels and sheds for temporary purposes are still sometimes built in a similar way, and roofed in with ling. Laid on the ground, with the flowers above, it forms a soft springy bed, the luxurious couch of the ancient Gael, still gladly resorted to at times by the hill shepherd or hardy deer-stalker. The young shoots were in former days employed as a substitute for hops in brewing, while their astringency rendered them valuable as a tanning material in Ireland and the Western Isles. They are said also to have been used by the Highlanders for dyeing woollen yarn yellow, and other colours are asserted to have been obtained from them, but some writers appear to confuse the dyer's-weed, *Genista tinctoria*, with the heather. The young juicy shoots and the seeds, which remain long in the capsules, furnish the red grouse of Scotland with the larger portion of its sustenance; the ripe seeds are eaten by many birds. The tops of the ling afford a considerable part of the winter fodder of the hill flocks, and are popularly supposed to communicate the fine flavour to Welsh and Highland mutton, but sheep seldom crop heather while the mountain grasses and rushes are sweet and accessible. Ling has been suggested as a material for paper, but the stems are hardly sufficiently fibrous for that purpose. The purple or fine-leaved heath, *E. cinerea* (fig. 2), one of the most beautiful of the genus, abounds on the lower moors and commons of Great Britain and western Europe, in such situations being sometimes more prevalent than the ling. The flowers of both these species yield much honey, furnishing a plentiful supply to the bees in moorland districts; from this heath honey the Picts probably brewed the mead said by Boetius to have been made from the flowers themselves.

The genus contains about 420 known species, by far the greater part being indigenous to the western districts of South Africa,



FIG. 1.
Calluna vulgaris.

but it is also a characteristic genus of the Mediterranean region, while several species extend into northern Europe. No species is native in America, but ling occurs as an introduced plant on the Atlantic side from Newfoundland to New Jersey. Five species occur in Britain: *E. cinerea*, *E. tetralix* (cross-leaved heath),



FIG. 2.
Erica cinerea.

both abundant on heaths and commons, *E. vagans*, Cornish heath, found only in West Cornwall, *E. ciliaris* in the west of England and Ireland and *E. mediterranea* in Ireland. The three last are south-west European species which reach the northern limit of their distribution in the west of England and Ireland. *E. scoparia* is a common heath in the centre of France and elsewhere in the Mediterranean region, forming a spreading bush several feet high. It is known as *bruyère*, and its stout underground rootstocks yield the briar-wood used for pipes.

The Cape heaths have long been favourite objects of horticulture. In the warmer parts of Britain several will bear exposure to the cold of ordinary winters in a sheltered border, but most need the protection of the conservatory. They are sometimes raised from seed, but are chiefly multiplied by cuttings "struck" in sand, and afterwards transferred to pots filled

with a mixture of black peat and sand; the peat should be dry and free from sourness. Much attention is requisite in watering heaths, as they seldom recover if once allowed to droop, while they will not bear much water about their roots: the heath-house should be light and well ventilated, the plants requiring sun, and soon perishing in a close or permanently damp atmosphere; in England little or no heat is needed in ordinary seasons. The European heaths succeed well in English gardens, only requiring a peaty soil and sunny situation to thrive as well as in their native localities: *E. carnea*, *mediterranea*, *ciliaris*, *vagans*, and the pretty cross-leaved heath of boggy moors, *E. tetralix*, are among those most worthy of cultivation. The beautiful large-flowered St Dabeoc's heath, belonging to the closely allied genus *Dabeocia*, is likewise often seen in gardens. It is found in boggy heaths in Connemara and Mayo, and is also native in West France, Spain and the Azores.

A beautiful work on heaths is that by H. C. Andrews, containing coloured engravings of nearly 300 species and varieties, with descriptions in English and Latin (4 vols., 1802-1805).

HEATHCOAT, JOHN (1783-1861), English inventor, was born at Duffield near Derby on the 7th of August 1783. During his apprenticeship to a framesmith near Loughborough, he made an improvement in the construction of the warp-loom, so as to produce mitts of a lace-like appearance by means of it. He began business on his own account at Nottingham, but finding himself subjected to the intrusion of competing inventors he removed to Hathers. There in 1808 he constructed a machine capable of producing an exact imitation of real pillow-lace. This was by far the most expensive and complex textile apparatus till then existing; and in describing the process of his invention Heathcoat said in 1836, "The single difficulty of getting the diagonal threads to twist in the allotted space was so great that, if now to be done, I should probably not attempt its accomplishment." Some time before perfecting his invention, which he patented in 1800, he removed to Loughborough, where he entered into partnership with Charles Lacy, a Nottingham manufacturer; but in 1816 their factory was attacked by the Luddites and their 55 lace frames destroyed. The damages were assessed in the King's Bench at £10,000; but as Heathcoat declined to expend the money in the county of Leicester he never received any part of it. Undaunted by his loss, he began at once to construct new and greatly improved machines in an unoccupied factory at Tiverton, Devon, propelling them by water-power and afterwards by steam. His claim to the inven-

tion of the twisting and traversing lace machine was disputed, and a patent was taken out by a clever workman for a similar machine, which was decided at a trial in 1816 to be an infringement of Heathcoat's patent. He followed his great invention by others of much ability, as, for instance, contrivances for ornamenting net while in course of manufacture and for making ribbons and platted and twisted net upon his machines, improved yarn spinning-frames, and methods for winding raw silk from cocoons. He also patented an improved process for extracting and purifying salt. An offer of £10,000 was made to him in 1833 for the use of his processes in dressing and finishing silk nets, but he allowed the highly profitable secret to remain undivulged. In 1832 he patented a steam plough. Heathcoat was elected member of parliament for Tiverton in 1832. Though he seldom spoke in the House he was constantly engaged on committees, where his thorough knowledge of business and sound judgment were highly valued. He retained his seat until 1859, and after two years of declining health he died on the 18th of January 1861 at Bolham House, near Tiverton.

HEATHCOTE, SIR GILBERT (c. 1651-1733), lord mayor of London, belonged to an old Derbyshire family and was educated at Christ's College, Cambridge, afterwards becoming a merchant in London. His trading ventures were very successful; he was one of the promoters of the new East India company and he emerged victorious from a contest between himself and the old East India company in 1693; he was also one of the founders and first directors of the bank of England. In 1702 he became an alderman of the city of London and was knighted; he served as lord mayor in 1711, being the last lord mayor to ride on horseback in his procession. In 1700 Heathcote was sent to parliament as member for the city of London, but he was soon expelled for his share in the circulation of some exchequer bills; however, he was again elected for the city later in the same year, and he retained his seat until 1710. In 1714 he was member for Helston, in 1722 for New Lymington, and in 1727 for St Germans. He was a consistent Whig, and was made a baronet eight days before his death. Although extremely rich, Heathcote's meanness is referred to by Pope; and it was this trait that accounts largely for his unpopularity with the lower classes. He died in London on the 25th of January 1733 and was buried at Normanton, Rutland, a residence which he had purchased from the Mackworths.

A descendant, Sir Gilbert John Heathcote, Bart. (1795-1867), was created Baron Aveland in 1856; and his son Gilbert Henry, who in 1888 inherited from his mother the barony of Willoughby de Eresby, became 1st earl of Ancaster in 1892.

HEATHEN, a term originally applied to all persons or races who did not hold the Jewish or Christian belief, thus including Mahomedans. It is now more usually given to polytheistic races, thus excluding Mahomedans. The derivation of the word has been much debated. It is common to all Germanic languages; cf. German *Heide*, Dutch *heiden*. It is usually ascribed to a Gothic *haiþi*, heath. In Ulfilas' Gothic version of the Bible, the earliest extant literary monument of the Germanic languages, the Syrophenician woman (Mark vii. 26) is called *haiþno*, where the Vulgate has *gentilis*. "Heathen," i.e. the people of the heath or open country, would thus be a translation of the Latin *paganus*, pagan, i.e. the people of the *pagus* or village, applied to the dwellers in the country where the worship of the old gods still lingered, when the people of the towns were Christians (but see PAGAN for a more tenable explanation of that term). On the other hand it has been suggested (Prof. S. Bugge, *Indo-German. Forschungen*, v. 178, quoted in the *New English Dictionary*) that Ulfilas may have adopted the word from the Armenian *ketanos*, i.e. Greek *ἑθνη*, tribes, races, the word used for the "Gentiles" in the New Testament. *Gentilis* in Latin, properly meaning "tribesman," came to be used of foreigners and non-Roman peoples, and was adopted in ecclesiastical usage for the non-Christian nations and in the Old Testament for non-Jewish races.

HEATHFIELD, GEORGE AUGUSTUS ELLIOTT, BARON (1717-1790), British general, a younger son of Sir Gilbert Elliott, Bart.,

of Stobs, Roxburghshire, was born on the 25th of December 1717, and educated abroad for the military profession. As a volunteer he fought with the Prussian army in 1735 and 1736, and then entered the Grenadier Guards. He went through the war of the Austrian Succession, and was wounded at Dettingen, rising to be lieutenant-colonel in 1754. In 1759 he became colonel of a new regiment of light horse (afterwards the 15th Hussars) and became well known for the efficiency which it displayed in the subsequent campaigns. He became lieutenant-general in 1765. In 1775 he was selected to be governor of Gibraltar (*q.v.*), and it is in connexion with his magnificent defence in the great siege of 1779 that his name is famous. His portrait by Sir Joshua Reynolds is in the National Gallery. In 1787 he was created Baron Heathfield of Gibraltar, but died on the 6th of July 1790. He had married in 1748 the heiress of the Drake family, to which Sir Francis Drake belonged. His son, the 2nd baron, died in 1813 and the peerage became extinct, but the estates went to the family of Elliott-Drake (baronetcy of 1821) through his sister.

HEATING. In temperate latitudes the climate is generally such as to necessitate in dwellings during a great portion of the year a temperature warmer than that out of doors. The object of the art of heating is to secure this required warmth with the greatest economy and efficiency. For reasons of health it may be assumed that no system of heating is advisable which does not provide for a constant renewal of the air in the locality warmed, and on this account there is a difficulty in treating as separate matters the subjects of heating and ventilation, which in practical schemes should be considered conjointly. (See **VENTILATION**).

The object of all heating apparatus is the transference of heat from the fire to the various parts of the building it is intended to warm, and this transfer may be effected by radiation, by conduction or by convection. An open fire acts by radiation; it warms the air in a room by first warming the walls, floor, ceiling and articles in the room, and these in turn warm the air. Therefore in a room with an open fire the air is, as a rule, less heated than the walls. In many forms of fireplaces fresh air is brought in and passed around the back and sides of the stove before being admitted into the room. A closed stove acts mainly by convection; though when heated to a high temperature it gives out radiant heat. Windows have a chilling effect on a room, and in calculations extra allowance should be made for window areas.

There are a number of methods available for adoption in the heating of buildings, but it is a matter of considerable difficulty to suit the method of warming to the class of building to be warmed. Heating may be effected by one of the following systems, or installations may be so arranged as to combine the advantages of more than one method: open fires, closed stoves, hot-air apparatus, hot water circulating in pipes at low or at high pressure, or steam at high or low pressure.

The open grate still holds favour in England, though in America and on the continent of Europe it has been superseded by the closed stove. The old form of open fire is certainly wasteful of fuel, and the loss of heat up the chimney and by conduction into the brickwork backing of the stove is considerable. Great improvements, however, have been effected in the design of open fireplaces, and many ingenious contrivances of this nature are now in the market which combine efficiency of heating with economy of fuel. Unless suitable fresh air inlets are provided, this form of stove will cause the room to be draughty, the strong current of warm air up the flue drawing cold air in through the crevices in the doors and windows. The best form of open fireplace is the ventilating stove, in which fresh air is passed around the back and sides of the stove before being admitted through convenient openings into the room. This has immense advantages over the ordinary type of fireplace. The illustrations show two forms of ventilating fireplace, one (fig. 1) similar in appearance to the ordinary domestic grate, the other (fig. 2) with descending smoke flue suitable for hospitals and public rooms, where it

might be fixed in the middle of the apartment. The fixing of stoves of this kind entails the laying of pipes or ducts from the open to convey fresh air to the back of the stove.

With closed stoves much less heat is wasted, and consequently less fuel is burned, than with open grates, but they often cause an unpleasant sensation of dryness in the air, and the products of combustion also escape to some extent, rendering this method of heating not only unpleasant but sometimes even dangerous. The method in Great Britain is almost entirely confined to places of public assembly, but in

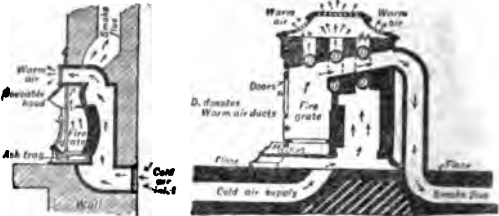

FIG. 1.

FIG. 2.

America and on the continent of Europe it is much used for domestic heating. If the flue pipe be carried up a considerable distance inside the apartment to be warmed before being turned into the external air, practically the whole of the heat generated will be utilized. Charcoal, coke or anthracite coal are the fuels generally used in slow combustion heating stoves.

Gas fires, as a substitute for the open coal fire, have many points in their favour, for they are conducive to cleanliness, they need but little attention, and the heat is easily controlled.

On the other hand, they may give off unhealthy fumes and produce unpleasant odours. They usually take the form of cast iron open stoves fitted with a number of Bunsen burners which heat perforated lumps of asbestos. The best form of stove is that with which perfect combustion is most nearly attained, and to which a pan of water is affixed to supply a desirable humidity to the air, the gas having the effect of drying the atmosphere. With another form of gas stove coke is used in place of the perforated asbestos; the fire is started with the gas, which, when the coke is well alight, may be dispensed with, and the fire kept up with coke in the usual way.

Electrical heating appliances have only recently passed the experimental stage; there is, however, undoubtedly a great future for electric heating, and the perfecting of the stove, together with the cheapening of the electric current, may be expected to result in many of the other stoves and convectors being superseded. Hitherto the large bill for electric energy has debarred the general use of electrical heating, in spite of its numerous advantages.

Oils are powerful fuels, but the high price of refined petroleum, the oil generally preferred, precludes its widespread use for many purposes for which it is suitable. In small stoves for warming and for cooking, petroleum presents some advantages over other fuels, in that there is no chimney to sweep, and if well managed no unpleasant fumes, and the stoves are easily portable. On the other hand, these stoves need a considerable amount of attention in filling, trimming and cleaning, and there is some risk of explosion and damage by accidental leaking and smoking. Crude or unrefined petroleum needs a special air-spray pressure burner for its use, and this suffers from the disadvantage of being noisy. Gas and oil radiators would be more properly termed "convectors," since they warm mainly by convected currents. They are similar in appearance to a hot-water or steam radiator, and, indeed, some are designed to be filled with water and used as such. They should always be fitted with a pan of water to supply the necessary humidity to the warmed air, and a flue to carry off any disagreeable fumes.

Heating by warmed air, one of the oldest methods in use, has been much improved by attention to the construction of the apparatus, and if properly installed will give as good effects as it is possible to obtain. The system is especially suitable for churches, assembly halls and large rooms. A stove of special design is placed in a chamber in the basement or cellar, and cold fresh air is passed through it, and led by means of flues to the various apartments for distribution by means of easily regulated inlet valves. To prevent the atmosphere from becoming unduly dry a pan of water is fitted to the stove; this serves to moisten the air before it passes into the distributing flues. If each distributing flue is connected by means of a mixing valve with a cold-air flue, the warmth of the incoming air can be regulated to a nicety (see VENTILATION).

There are many different systems of heating by hot water circulating in pipes. The oldest and best known is the "two pipe" system, others being the "one pipe" or "simple circuit," and the "drop" or "overhead." The high pressure system is of later invention, having been first put to practical use by A. M. Perkins in 1845. All these methods warm chiefly by means of convected heat, the amount of true radiation from the pipes being small. The manner in which the circulation of hot water takes place in the tubes is as follows. Fire heats the water in a boiler from the top of which a "flow" pipe communicates with the rooms to be warmed (fig. 3). As the water is heated it becomes lighter,

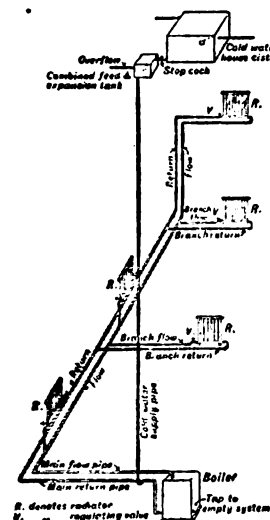

FIG. 3.

a pipe affords, radiators are connected with the pipes where desired, and the water passing through them warms the surrounding air.

The "one pipe" system (fig. 4) acts on precisely the same principle, but in place of two pipes being placed in adjacent positions one large main makes a complete circuit of the area to be warmed, starting from and returning to the boiler, and from this main flow and return branches are taken and connected with radiators and other heating appliances.

In the "drop" or "overhead" system (fig. 5) a rising main is taken directly from the boiler to the topmost floor of the building, and from this branches are dropped to the lower floors, and connected by means of smaller branches to radiators or coils. The vertical branches descend to the basement and

generally merge in a single return pipe which is connected to the lower part of the boiler.

The rate of circulation in the ordinary low pressure hot-water system may be considerably accelerated by means of steam injections. The water after being heated passes into a circulating

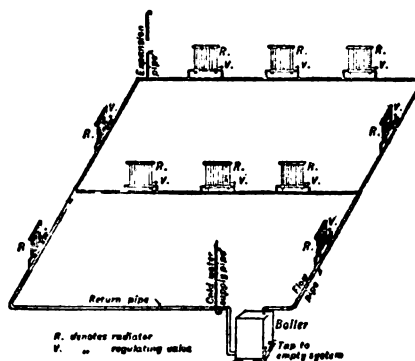

FIG. 4.

tank into which steam is introduced; this, mixing with the hot water, gives it additional motive power, resulting in a faster circulation. This steam condensing adds to the water in the pipe and naturally causes an overflow, which is led back to the boiler and re-used. In districts where the water is hard, this arrangement considerably lengthens the life of the boiler, as

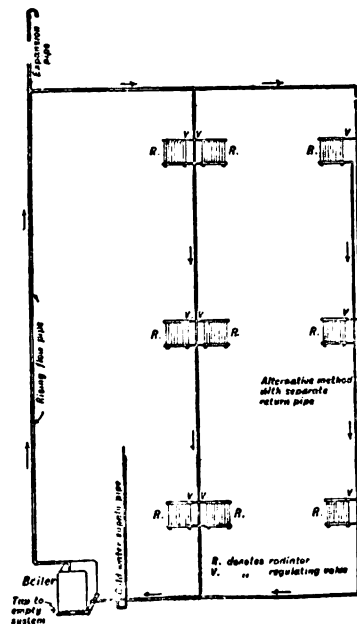

FIG. 5.

the same water is used over and over again, and no fresh deposit of fur occurs. Owing to the very rapid movement and the consequent increased rate of transmission of heat, the pipes and radiators may be reduced in size, in many circumstances a very desirable thing to achieve. With this system the temperature

can be quickly raised and easily controlled. If the weather is mild, a moderate heat may be obtained by using the apparatus as an ordinary hot water system, and shutting off the steam injectors.

The cold-water supply and expansion tank (fig. 3) are often combined in one tank placed at a point above the level of circulation. The tank should be of a size to hold not less than a twentieth part of the total amount of water held in the system. The automatic inlet of cold water to the hot water system from the main house tank or other source is controlled by a ball valve, which is so fixed as to allow the water to rise no more than an inch above the bottom of the tank, thus leaving the remainder of the space clear for expansion. An overflow is provided, discharging into the open air to allow the water to escape should the ball valve become defective.

The "Perkins" or "small bore high pressure" system (fig. 6) has many advantages, for it is safe, the boiler is small and is easily managed, the temperature is well under control and may be regulated to suit the changing weather, and the small pipes present a neat appearance in a room. The whole system is constructed of wrought iron pipe of small diameter, strong enough to resist a testing pressure of 2000 to 2500 lb per sq. in. The boiler consists of

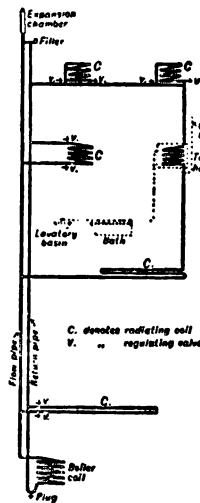

FIG. 6.

manner, is screwed on, and causes the conical edge to impress itself tightly on the flat end, giving a sound and lasting joint. The system is hermetically sealed after being pumped full of water, an expansion chamber in the shape of a pipe of larger dimensions being provided at the top of the system above the highest point of circulation. Upon the application of heat to the fire-box coil the water naturally expands and forces its way up into the expansion chamber; but there it encounters the pressure of the confined air, and ebullition is consequently prevented. Thus at no time can steam form in the system.

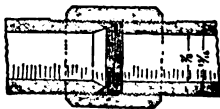

FIG. 7.

This system is trustworthy and safe in working. The smallness of the pipes renders it liable to damage by frost, but this accident may be prevented by always keeping in frosty weather a small fire in the furnace. If this course is inconvenient, some liquid of low freezing-point, such as glycerine, may be mixed with the water.

For large public buildings, factories, &c., heating by steam is generally adopted on account of the rapidity with which heat is available, and the great distance from the boiler at which warming is effected. In the case of factories ^{Steam heating.} the exhaust steam from the engines used for driving the working machinery is made use of and forms the most economical method of heating possible. There are several different systems of heating by steam—low pressure, high pressure and minus pressure.

In the low pressure two pipe system the flow pipe is carried to a sufficient height directly above the boiler to allow of its gradual fall to a little beyond the most distant point at which connexion is to be made with the return pipe, which thence slopes towards the boiler. Branches are taken off the flow pipe, and after circulating through coils or radiators are connected with the return pipe. In a well-proportioned system the pressure need not exceed 2 or 3 lb per sq. in. for excellent results to be obtained. The one-pipe system is similar in principle, the pipe rising to its greatest height above the boiler and being then carried around as a single pipe falling all the while. It resembles in many points the one-pipe low pressure hot-water system. Radiators are fed directly from the main. Where, as in factories or workshops, there are already installed engines working at a high steam pressure, say 120 to 180 lb per sq. in., a portion of the steam generated in the boilers may be utilized for heating by the aid of a reducing valve. The steam is passed through the valve and emerges at the pressure required generally from 3 lb upwards. It is then used for one of the systems described above.

High-pressure steam-heating, compared with the heating by low pressure, is little used. The principles are the same as those applied to low-pressure work, but all fittings and appliances must, of course, be made to stand the higher strain to which they are subjected.

The "minus pressure" steam system, sometimes termed "atmospheric" or "vacuum," is of more recent introduction than those just described. It is certainly the most scientific method of steam-heating, and heat can be made to travel a greater distance by its aid than by any other means. The heat of the pipes is great, but can be easily regulated. The system is economical in fuel, but needs skilled attendance to keep the appliances and fittings in order. The steam is introduced into the pipes at about the pressure of the atmosphere, and is sucked through the system by means of a vacuum pump, which at the same operation frees the pipes from air and from condensation water. This pumping action results in an extremely rapid circulation of the heating agent, enabling long distances to be traversed without much loss of heat.

Compared with heating by hot water, steam-heating requires less piping, which, further, may be of much smaller diameter to attain a similar result, because of the higher temperature of the heat yielding surface. A drawback to the use of steam is the fact that the high temperature of the pipes and radiators attracts and spreads a great deal of dust. There is also a risk that woodwork near the pipes may warp and split. The apparatus needs constant attention, since neglect in stoking would result in stopping the generation of steam, and the whole system would almost immediately cool. To regulate the heat it is necessary either to install a number of small radiators or to divide the radiators into sections, each section controlled by distinct valves; steam may then be admitted to all the sections of the radiator or to any less number of sections as desired. In a hot-water system the heat is given off at a lower temperature and is consequently more agreeable than that yielded by a steam-heating apparatus. The joint most commonly used for hot-water pipes is termed the "rust" joint, which is cheap to make, but unfortunately is inefficient. The materials required are iron borings, sal-ammoniac and sulphur; these are mixed together, moistened with water, and rammed into the socket, which is previously half filled with yarn, well caulked. The materials mixed with the iron borings cause them to rust into a solid mass, and in doing so a slight expansion takes place. On

this account it is necessary to exercise some skill in forming the joint, or the socket of the pipe will be split; numbers of pipes are undoubtedly spoilt in this way. Suitable proportions of materials to form a rust joint are 90 parts by weight of iron borings well mixed with 2 parts of flowers of sulphur, and 1 part of powdered sal-ammoniac. Another joint, less rigid but sound and durable, is made with yarn and white and red lead. The white and red lead are mixed together to form a putty, and are filled into the socket alternately with layers of well-caulked yarn, starting with yarn and finishing off with the lead mixture.

Iron expands when heated to the temperature of boiling water (212° F.) about 1 part in 900, that is to say, a pipe 100 ft. long would expand or increase in length when heated to this temperature about 1 1/4 in., an amount which seems small but which would be quite sufficient to destroy one or more of the joints if provision were not made to prevent damage. The amount of expansion increases as the temperature is raised; at 340° F. it is 2 1/4 in. in 100 ft. With wrought iron pipes bends may be arranged, as shown in fig. 8, to take up this expansion. With cast iron pipe this cannot be done, and no length of piping over 40 ft. should be without a proper expansion joint. The pipes are best supported on rollers which allow of movement without straining the joints.

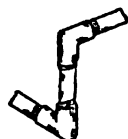

FIG. 8.

There are several joints in general use for the best class of work which are formed with the aid of india-rubber rings or collars, any expansion being divided amongst the whole number of joints. In the rubber ring joint an india-rubber ring is used; slightly less in diameter than the pipe. The rubber is circular in section, and about 1/4 in. thick, and is stretched on the extreme end of a pipe which is then forced into the next socket. This joint is durable, secure and easily made; it allows for expansion and by its use the risk of pipe sockets being cracked is avoided. It is much used for greenhouse heating works. Richardson's

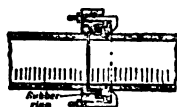

FIG. 9.

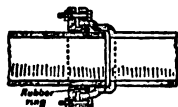

FIG. 10.

patent joint (fig. 9) is a good form of this class of joint. The pipes have specially shaped ends between which a rubber collar is placed, the joint being held together by clips. The result is very satisfactory and will stand heavy water pressure. Messenger's joint (fig. 10) is designed to allow more freedom of expansion and at the same time to withstand considerable pressure; one loose cast iron collar is used, and another is formed as a socket on the end of the pipe itself. One end of each pipe is plain, so that it may be cut to any desired length; pipes with shaped ends obviously must be obtained in the exact lengths required. Jones's expansion joint (fig. 11) is somewhat similar to Messenger's but it is not capable of withstanding so great a pressure. In this case both collars of cast iron are loose.

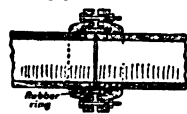

FIG. 11.

Radiators (really convectors) were in their primitive design coils of pipe, used to give a larger heating area than the single pipe would afford. They are now usually of special design, and may be divided into three classes—indirect radiators, direct radiators and direct ventilating radiators. Indirect radiators are placed beneath the floor of the apartment to be heated and give off heat through a grating. This method is frequently adopted in combined schemes of heating and ventilating; the fresh air is warmed by being passed over their surfaces previously to being admitted through the gratings into the room. Direct radiators are a development of the early coil

of pipe; they are made in various types and designs and are usually of cast iron. Ventilating radiators are similar, but have an inlet arrangement at the base to allow external air to pass over the heating surface before passing out through the perforations. Radiators should not be fixed directly on to the main heating pipe, but always on branches of smaller diameter leading from the flow pipe to one end of the radiator and back to the main return pipe from the other end; they may then be easily controlled by a valve placed on the branch from the flow pipe. To each radiator should be fitted an air tap, which when opened will permit the escape of any air that has accumulated in the coil; otherwise free circulation is impossible, and the full benefit of the heat is not obtained.

A plentiful supply of hot water is a necessity in every house for domestic and hygienic purposes. In small houses all requirements may be satisfied with a boiler heated by the kitchen fire. For large buildings where large quantities of hot water are used an independent boiler of suitable size should be installed. Every installation is made up of a boiler or other water-heater, a tank or cylinder to contain the water when heated, and a cistern of cold water, the supply from which to the system is regulated automatically by a ball valve. These containers, proportioned to the required supply of hot water, are connected with each other by means of pipes, a "flow" and a "return" connecting the boiler with the cylinder or tank (fig. 12). The flow pipe starts from the top of the boiler and is connected near the top of the cylinder, the

Hot-water supply.

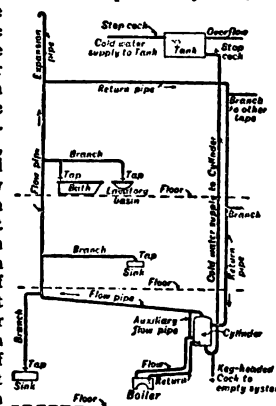

FIG. 12.

return pipe joining the lower portions of the cylinder and boiler. The supply from the cold water cistern enters the bottom of the cylinder, and thence travels by way of the return pipe to the boiler, where it is heated, and back through the flow pipe to the cylinder, which is thus soon filled with hot water. A flow pipe which serves also for expansion is taken from the top of the cylinder to a point above the cold-water supply and turned down to prevent the ingress of dirt. From this pipe at various points are taken the supply pipes to baths, lavatories, sinks and other appliances. It will be observed that in fig. 12 the cylinder is placed in proximity to the boiler; this is the usual and most effective method, but it may be placed some distance away if desired. The tank system is of much earlier date than this cylinder system, and although the two resemble each other in many respects, the tank system is in practice the less effective. The tank is placed above the level of the topmost draw off, and often in a cupboard which it will warm sufficiently to permit of its being used as a linen airing closet. An expansion pipe is taken from the top of the tank to a point above the roof. All draw off services are taken off from the flow pipe which connects the boiler with the tank. This method differs from that adopted in the cylinder system, where all services are led from the top of the cylinder. A suitable proportion between the size of the tank or cylinder and that of the boiler is 8 or 10 to 11. Water may also be heated by placing a coil of steam or high-pressure hot-water pipes in a water tank (fig. 6), the water heated in this way circulating in the manner already described. An alternative plan is to pass the water through pipes placed in a steam chest. Cylinders, tanks and independent boilers should be encased in a non-conducting material such as silicate cotton, thick felt or asbestos composition. The two first mentioned are affixed

by means of bands or straps or stitched on; the asbestos is laid on in the form of a plaster from 2 to 6 in. thick.

Taps to baths and lavatories should be connected to the main services by a flow and return pipe so that hot water is constantly flowing past the tap, thus enabling hot water to be obtained immediately. Frequently a single pipe is led to the tap, but the water in this branch cools and must therefore be drawn off before hot water can be obtained.

Two classes of boilers are chiefly used in hot-water heating installations, viz. those heated by the fire of the kitchen range, and those heated separately or independently. Of

the first class there are two varieties in common use—the form of “saddle” boiler (fig. 13) and the “boot” boiler (fig. 14). Independent boilers are made in every conceivable

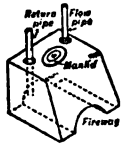

FIG. 13.

size and form of construction, and many of them are capable of doing excellent work. In the choice of a boiler of this description it should be remembered that rapid heating, economical combustion of fuel, and facilities for cleaning, are requisites, the absence of any of which considerably lowers the efficiency of the apparatus. Boilers set in brickwork are sometimes used in domestic work, although they are more favoured for horticultural

heating. The shape mostly used is the “saddle” boiler, or some variation upon this very old pattern. The coiled pipe fire-box of the high-pressure hot-water system previously described may be also classed with boilers.

A notable feature of modern boiler construction is the mode of building the apparatus of cast iron in either horizontal or vertical sections. Both the types intended to be set in brickwork and those working independently are formed on the sectional principle, which has many good points. The parts are easy of transport and can be handled without difficulty through narrow doorways and in confined situations. The size of the boiler may be increased or diminished by the addition or subtraction of one or more sections; these, being simple in design, are easily fitted together, and should a section become defective it is a simple matter to insert a new one in its place. Should a defect occur with a wrought iron boiler it is usually necessary for the purpose

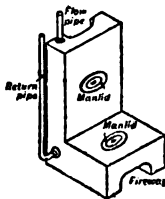

FIG. 14.

of repair to disconnect and remove the whole apparatus, the heating system of which it forms a part being in the meantime useless. In a type built with vertical sections each division is complete in itself, and is not directly connected with the next section, but communicates with flow and return drums. A defective section may thus be left in position and stopped off by means of plugs from the drums until it is convenient to fit a new one in its place. A boiler with horizontal sections is shown in fig. 15; it will be

seen that each of the upper sections has a number of cross waterways which form a series of gratings over the fire-box and intercept most of the heat generated, effecting great economy of fuel.

In the ordinary working of a hot-water apparatus the expansion pipe already referred to will prevent any overdue pressure occurring in the boiler; should, however, the pipes become blocked in any way while the apparatus is in use, or the water in them become frozen, the lighting

of the fire would cause the water to expand, and having no outlet it would in all probability burst the boiler. To prevent this a safety valve should be fitted on the top of the boiler, or be connected thereto with a large pipe so as to be visible. The valve may be of the dead weight (fig. 16), lever weight, spring (fig. 17) or diaphragm variety. The three first named are largely used. In the diaphragm valve a thin piece of metal is fixed to an outlet from the fire, and when a moderate pressure is exceeded this gives way, allowing the water and steam to escape.

Fusible plugs are little used; they consist of pieces of softer metal inserted on the side of the boiler, which melt should the heat of the water rise above a certain temperature.

metal inserted on the side of the boiler, which melt should the heat of the water rise above a certain temperature.

A “Geyser” is a very convenient form of apparatus for heating a quantity of water in a short time. A water pipe of copper or wrought iron is passed through a cylinder in which gas or oil heating burners are placed. The piping takes a winding or zigzag course, and by the time the outlet is reached, the water it contains has reached a high temperature.

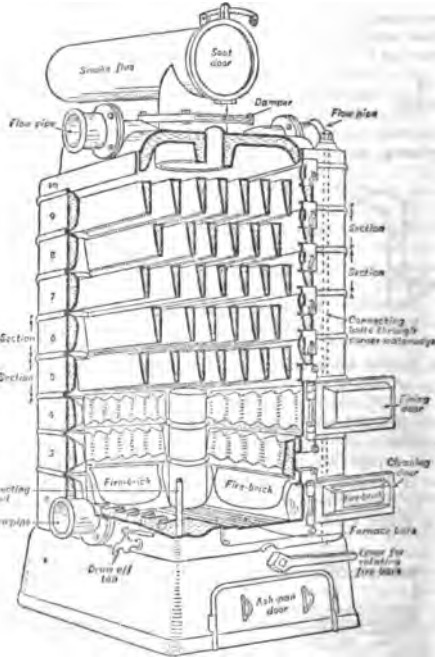

FIG. 15.

By this means a continuous stream of hot water is obtained, greater or smaller in proportion to the size and power of the apparatus. The improved types of gas geysers are provided with a single control to both gas and water supplies, with a small “pilot” burner to ignite the gas. A flue should in all cases be provided to carry off the fumes of the fuel.

In districts where the water is of a “hard nature,” that is, contains bicarbonate of lime in solution, the interior of the boiler, cylinders, tanks and pipes of a hot water system will become incrustated with a deposit of lime which is gradually precipitated as the water is heated to boiling point. With “very hard” water this deposit may require removal every three months; in London it is usual to clean out the boiler every six months and the cylinders and tanks at longer intervals. For this purpose manlids must be provided (figs. 13 and 14), and pipes should be fitted with removable caps at the bends to allow for periodical cleaning. The lime deposit or “fur” is a poor conductor of heat, and it is therefore most detrimental to the efficiency of the system to allow the interior of the boiler or any other portion to become furred up. Further, if not removed, the fur will in a short time bring about a fracture in the boiler. The use of soft water entails a disadvantage of another character—that of corroding iron and lead work, soft water exercising a very vigorous chemical action

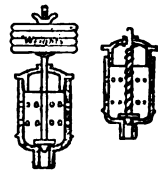

FIG. 16. FIG. 17.

upon these metals. In districts supplied with soft water, copper should be employed to as large an extent as possible.

The table given below will be useful in calculating the size of the radiating surface necessary to raise the temperature to the extent required when the external air is at freezing point (32° Fahr.):—

Description of Building to be heated.	Temperature required.	Cubic Feet of Air heated by 1 sq. ft. of Radiator or Pipe Surface.	
		Low Pressure Water.	Low Pressure Steam.
Dwelling rooms	55°-60°	85-90	115-125
Schools	60°	90-100	120-130
Churches and chapels	55°-60°	100-120	135-160
Offices and shops	55°-60°	120-125	160-170
Public halls, workshops, waiting-rooms	55°	130-150	175-200
Warehouses, stores	50°-55°	140-160	190-220

In closing this account of heating and the practical methods of application of heat, an example may be mentioned to show the great capabilities of a carefully planned system.

Steam supply at Lockport. At the city of Lockport in New York state, America, an interesting example of the direct application of steam-heating on a large scale has been carried out under the direction of Mr Birdsill Holly of that city. Houses within a radius of 3 m. from the boiler house are supplied with superheated steam at a pressure of 35 lb to the in. The mains, the largest of which are 4 in. in diameter, and the smallest 2 in., are wrapped in asbestos, felt and other non-conducting materials, and are placed in wooden tubes laid under ground like water and gas pipes. The house branches pipes are 1½ in. in diameter, and ½-in. pipes are used inside the houses. The steam is employed for warming apartments by means of pipe radiators, for heating water by steam injections, and for all cooking purposes. The steam mains to the houses are laid by the supply company; the internal pipes and fittings are paid for or rented by the occupier, costing for an installation from £30 for an ordinary eight-roomed house to £100 or more for larger buildings. With the success of this undertaking in view it is a matter of wonder that the example set in this instance has not been adopted to a much greater extent elsewhere.

The principal publications on heating are: Hood, *Practical Treatise on Warming Buildings by Hot Water*; Baldwin, *Hot Water Heating and Fittings*; Baldwin, *Steam Heating for Buildings*; Billings, *Ventilation and Heating*; Carpenter, *Heating and Ventilating Buildings*; Jones, *Heating by Hot Water, Ventilation and Hot Water Supply*; Dye, *Hot Water Supply*. (J. Br.)

HEAVEN (O. Eng. *hefen*, *heofon*, *heofone*; this word appears in O.S. *hean*; the High. Ger. word appears in Ger. *Himmel*, Dutch *hemel*; there does not seem to be any connexion between the two words, and the ultimate derivation of the word is unknown; the suggestion that it is connected with "to heave," in the sense of something "lifted up," is erroneous), properly the expanse, taking the appearance of a domed vault above the earth, in which the sun, moon, planets and stars seem to be placed, the firmament; hence also used, generally in the plural, of the space immediately above the earth, the atmospheric region of winds, rain, clouds, and of the birds of the air. The heaven and the earth together, therefore, to the ancient cosmographers, and still in poetical language, make up the universe. In the cosmogonies of many ancient peoples there was a plurality of heavens, probably among the earlier Hebrews, the idea being elaborated in rabbinical literature, among the Babylonians and in Zoroastrianism. The number of these heavens, the higher transcending the lower in glory, varied from three to seven. Heaven, as in the Hebrew *shamayim*, the Greek *οὐρανός*, the Latin *caelum*, is the abode of God, and as such in Christian eschatology is the place of the blessed in the next world (see **ESCHATOLOGY** and **PARADISE**).

HEBBEL, CHRISTIAN FRIEDRICH (1813-1863), German poet and dramatist, was born at Wesselsburen in Ditmarschen, Holstein, on the 18th of March 1813. Though only the son of a poor bricklayer, he early showed a talent for poetry, which was

first displayed to the world by the publication, in the Hamburg *Modercitium*, of verses which he had sent to Amalie Schoppe (1791-1858), a then popular journalist and author of nursery tales. Through the kindness of this lady, who interested several of her friends on his behalf, he was enabled to go to Hamburg

and there prepare himself for the university. A year later he went to Heidelberg to study law, but finding this uncongenial he passed on to the university of Munich, where he devoted himself to philosophy, history and literature. In 1839 Hebbel left Munich and wandered back to Hamburg on foot, where he resumed his relations with Elsie Lensing, whose self-sacrificing assistance had helped him over the darkest days in Munich. In the same year he wrote his first tragedy *Judith* (published 1841), which in the following year was performed in Hamburg

and Berlin and made his name known throughout Germany. In 1840 he wrote the tragedy *Genevieve*, and the following year finished a comedy, *Der Diamant*, which he had begun at Munich. In 1842 he visited Copenhagen, where he obtained from the king of Denmark a small travelling studentship, which enabled him to spend some time in Paris and two years (1844-1846) in Italy. In Paris he wrote his fine "tragedy of common life," *Maria Magdalene* (1844). On his return from Italy Hebbel met at Vienna two Polish noblemen, the brothers Zerbini di Sposetti, who in their enthusiasm for his genius urged him to remain, and supplied him with the means to mingle in the best intellectual society of the Austrian capital. The unwonted life of ease had its effect. The old precarious existence became a horror to him, he made a deliberate breach with it by marrying (in 1846) the beautiful and wealthy actress Christine Enghaus, ruthlessly sacrificing the girl who had given up all for him and who remained faithful till her death, on the ground that "a man's first duty is to the most powerful force within him, that which alone can give him happiness and be of service to the world"; in his case the poetical faculty, which would have perished "in the miserable struggle for existence." This "deadly sin," which, "if peace of conscience be the test of action," was, he considered, the best act of his life, established his fortunes. Elsie, however, still provided useful inspiration for his art. As late as 1855, shortly after her death, he wrote the little epic *Mutter und Kind*, intended to show that the relation of parent and child is the essential factor which makes the quality of happiness among all classes and under all conditions equal. Long before this Hebbel had become famous. German sovereigns bestowed decorations upon him; and in foreign capitals he was feted as the greatest of living German dramatists. From the grand-duke of Saxe-Weimar he received a flattering invitation to take up his residence at Weimar, where several of his plays were first performed. He remained, however, at Vienna until his death on the 13th of December 1863.

Besides the works already mentioned, Hebbel's principal tragedies are *Herodes und Mariamne* (1850); *Julia* (1851); *Michel Angelo* (1851); *Agnes Bernauer* (1855); *Gyges und sein Ring* (1856), and the magnificently conceived trilogy *Die Nibelungen* (1862), his last work (consisting of a prologue, *Der gehörnte Siegfried*, and the tragedies, *Siegfrieds Tod* and *Kriemhilds Rache*), which won for the author the Schiller prize. Of his comedies *Der Diamant* (1847), *Der Rubin* (1850), and the tragi-comedy *Ein Trauerspiel in Stalien* (1845), are the more important, but they are heavy and hardly rise above mediocrity. All his dramatic productions, however, exhibit skill in characterization, great glow of passion, and a true feeling for dramatic situation; but their poetic effect is frequently marred by extravagances which border on the grotesque, and by the introduction of incidents the unpleasant character of which is not sufficiently relieved. In many of his lyric poems, and especially in *Mutter und Kind*, published in 1859, Hebbel showed that his poetic gifts were not restricted to the drama.

His collected works were first published by E. Kuh (12 vols.,

Hamburg, 1866-1868); revised by H. Krumm (12 vols., Hamburg, 1892). The best critical edition is that by R. M. Werner (12 vols., 1901-1903), to which have been added Hebbel's Diaries (4 vols.) and Correspondence (6 vols.). Hebbel's *Briefwechsel mit Freunden und berühmten Zeitgenossen* was issued by F. Bamberg (1890-1892). The chief biographies of Hebbel are those by E. Kuh (1877) and R. M. Werner (1905). See also L. A. Frankel, *Zur Biographie F. Hebbels* (1884); T. Poppe, *F. Hebbel und sein Drama* (1900); A. Scheunert, *Der Pantragsmus als System der Weltanschauung und Ästhetik Hebbels* (1903); E. A. Georgy, *Die Tragödie F. Hebbels nach ihrem Ideengehalt* (1904).

HEBBURN, an urban district in the Jarrow parliamentary division of Durham, England, on the right bank of the Tyne, $4\frac{1}{2}$ m. below Newcastle, and on a branch of the North-Eastern railway. Pop. (1881), 11,802; (1901), 20,901. It has extensive shipbuilding and engineering works, rope and sail factories, chemical, colour and cement works, and collieries.

HEBDEN BRIDGE, an urban district in the Sowerby parliamentary division of the West Riding of Yorkshire, England, on the Calder and Hebdens rivers, 7 m. W. by N. of Halifax by the Lancashire and Yorkshire railway. Pop. (1901), 7,536. The town has cotton factories, dye-works, foundries and manufacturing of shuttles. The upper Calder valley, between Halifax and Todmorden, is walled with bold hills, the summits of which consist of wild moorland. The vale itself is densely populated, but its beauty is not destroyed, and the contrast with its desolate surroundings is remarkable.

HEBE, in Greek mythology, daughter of Zeus and Hera, the goddess of youth. In the Homeric poems she is the female counterpart of Ganymede, and acts as cupbearer to the gods (*Iliad*, iv. 2). She was the special attendant of her mother, whose horses she harnessed (*Iliad*, v. 722). When Heracles was received amongst the gods, Hebe was bestowed upon him in marriage (*Odyssey*, xi. 603). When the custom of the heroic age, which permitted female cupbearers, fell into disuse, Hebe was replaced by Ganymede in the popular mythology. To account for her retirement from her office, it was said that she fell down in the presence of the gods while handing the wine, and was so ashamed that she refused to appear before them again. Hebe exhibits many striking points of resemblance with the pure Greek goddess Aphrodite. She is the daughter of Zeus and Hera, Aphrodite of Zeus and Dione; but Dione and Hera are often identified. Hebe is called *Dia*, a regular epithet of Aphrodite; at Phlius, a festival called *Κισσοκόμοι* (the days of ivy-cutting) was annually celebrated in her honour (Pausanias, ii. 13); and ivy was sacred also to Aphrodite. The apotheosis of Heracles and his marriage with Hebe became a favourite subject with poets and painters, and many instances occur on vases. In later art she is often represented, like Ganymede, carressing the eagle.

See R. Kekulé, *Hebe* (1867), mainly dealing with the representations of Hebe in art; and P. Décharme in Daremberg and Saglio's *Dictionnaire des antiquités*.

The meaning of the word Hebe tended to transform the goddess into a mere personification of the eternal youth that belongs to the gods, and this conception is frequently met with. Then she becomes identical with the Roman *Juventas*, who is simply an abstraction of an attribute of Jupiter *Juventus*, the god of increase and blessing and youth. To *Juventas*, as personifying the eternal youth of the Roman state, a chapel was dedicated in very early times in the *cella* of Minerva in the temple of Jupiter Capitolinus. With this temple is connected the legend of *Juventas* and *Terminus*, who alone of all the gods refused to give way when it was being built—an indication of the eternal solidity and youth of Rome. The cult of *Juventas* did not, however, become firmly established until the time of the second Punic war. In 218 the Sibylline books ordered a lectisternium in honour of *Juventas* and a supplicatio in honour of Hercules, and in 191 a temple was dedicated in her honour in the *Circus Maximus*. In later times *Juventas* became the personification, not of the Roman youth, but of the emperor, who assumed the attributes of a god (*Livy* v. 54, xxi. 62, xxxvi. 36; *Dion. Halic.* iii. 69; G. Wissowa in Roscher's *Lexikon der Mythologie*).

HEBEL, JOHANN PETER (1760-1826), German poet and popular writer, was born at Basel on the 10th of May 1760. The father dying when the child was little over a year old, he was brought up amidst poverty-stricken conditions in the village of Hausen in the Wiesental, where he received his earliest education. Being of brilliant promise, he found friends who enabled him to complete his school education and to study theology (1778-1780) at Erlangen. At the end of his university course he was for a time a private tutor, then became teacher at the Gymnasium in Karlsruhe, and in 1808 was appointed director of the school. He was subsequently appointed member of the Consistory and "evangelical prelate." He died at Schwetzingen, near Heidelberg, on the 22nd of September 1826. Hebel is one of the most widely read of all German popular poets and writers. His poetical narratives and lyric poems, written in the "Alemannic" dialect, are "popular" in the best sense. His *Allemannische Gedichte* (1803) "bucolicize" in the words of Goethe, "the whole world in the most attractive manner" (*verbauert das ganze Universum auf die anmutigste Weise*). Indeed, few modern German poets surpass him in fidelity, *naïveté*, humour, and in the freshness and vigour of his descriptions. His poem, *Die Wiese*, has been described by Johannes Scherr as the "pearl of German idyllic poetry"; while his prose writings, especially the narratives and essays contained in the *Schatkistslein des rheinischen Hausfreundes* (Tübingen, 1811; new edition, Stuttg. 1869, 1888), belong to the best class of German stories, and according to August Friedrich Christian Vilmar (1800-1868) in his *Geschichte der deutschen Literatur* are "worth more than a cartload of novels" (*wiegen ein ganzes Fuder Romane auf*). Memorials have been erected to him at Karlsruhe, Basel and Schwetzingen.

A complete edition of Hebel's works—*Sämliche Werke*—was first published at Stuttgart in 8 vols. (1832-1834); subsequent editions appeared in 1847 (3 vols.), 1868 (2 vols.), 1873 (edited by G. Wendt, 2 vols.), 1883-1885 (edited by O. Behaghel, 2 vols.) and 1905 (edited by E. Keller, 5 vols.), as well as innumerable reprints. Hebel's correspondence has been edited by O. Behaghel (1863). See G. Langin, *J. P. Hebel, ein Lebensbild* (1894), and the introduction to Behaghel's edition.

HEBER, REGINALD (1783-1826), English bishop and hymn-writer, was born at Malpas in Cheshire on the 21st of April 1783. His father, who belonged to an old Yorkshire family, held a moiety of the living of Malpas. Reginald Heber early showed remarkable promise, and was entered in November 1800 at Brasenose College, Oxford, where he proved a distinguished student, carrying off prizes for a Latin poem entitled *Carmen seculare*, an English poem on *Paestine*, and a prose essay on *The Sense of Honour*. In November 1804 he was elected a fellow of All Souls College; and, after finishing his distinguished university career, he made a long tour in Europe. He was admitted to holy orders in 1807, and was then presented to the family living of Hodnet in Shropshire. In 1809 Heber married Amelia, daughter of Dr Shipley, dean of St Asaph. He was made prebendary of St Asaph in 1812, appointed Bampton lecturer for 1815, preacher at Lincoln's Inn in 1822, and bishop of Calcutta in January 1823. Before sailing for India he received the degree of D.D. from the university of Oxford. In India Bishop Heber laboured indefatigably, not only for the good of his own diocese, but for the spread of Christianity throughout the East. He undertook numerous tours in India, consecrating churches, founding schools and discharging other Christian duties. His devotion to his work in a trying climate told severely on his health. At Trichinopoly he was seized with an apoplectic fit when in his bath, and died on the 3rd of April 1826. A statue of him, by Chantrey, was erected at Calcutta.

Heber was a pious man of profound learning, literary taste and great practical energy. His fame rests mainly on his hymns, which rank among the best in the English language. The following may be instanced: "Lord of mercy and of might"; "Brightest and best of the sons of the morning"; "By cool Siloam's shady rill"; "God, that madest earth and heaven"; "The Lord of might from Sinai's brow"; "Holy, holy, holy, Lord God Almighty"; "From Greenland's icy mountains"; "The Lord will come, the earth shall quake";

"The Son of God goes forth to war." Heber's hymns and other poems are distinguished by finish of style, pathos and soaring aspiration; but they lack originality, and are rather rhetorical than poetical in the strict sense.

Among Heber's works are: *Palentine: a Poem, to which is added the Passage of the Red Sea* (1809); *Europe: Lines on the Present War* (1809); a volume of poems in 1812; *The Personality and Office of the Christian Comforter asserted and explained* (being the Bampton Lectures for 1815); *The Whole Works of Bishop Jeremy Taylor, with a Life of the Author, and a Critical Examination of his Writings* (1822); *Hymns written and adapted to the Weekly Church Service of the Year, principally by Bishop Heber* (1827); *A Journey through India* (1828); *Sermons preached in England, and Sermons preached in India* (1829); *Sermons on the Lessons, the Gospel, or the Epistle for every Sunday in the Year* (1837). *The Poetical Works of Reginald Heber* were collected in 1841.

See the *Life of Reginald Heber, D.D.* . . . by his widow, Amelia Heber (1830), which also contains a number of Heber's miscellaneous writings; *The Last Days of Bishop Heber*, by Thomas Robinson, A.M., archdeacon of Madras (1830); T. S. Smyth, *The Character and Religious Doctrine of Bishop Heber* (1831), and *Memorials of a Quief Life*, by Augustus J. C. Hare (1874).

HEBER, RICHARD (1773-1833), English book-collector, the half-brother of Reginald Heber, was born in London on the 3th of January 1773. As an undergraduate at Brasenose College, Oxford, he began to collect a purely classical library, but his taste broadening, he became interested in early English drama and literature, and began his wonderful collection of rare books in these departments. He attended continental book-sales, purchasing sometimes single volumes, sometimes whole libraries. Sir Walter Scott, whose intimate friend he was, and who dedicated to him the sixth canto of *Marmion*, classed Heber's library as "superior to all others in the world"; Campbell described him as "the fiercest and strongest of all the bibliomaniacs." He did not confine himself to the purchase of a single copy of a work which took his fancy. "No gentleman," he remarked, "can be without three copies of a book, one for show, one for use, and one for borrowers." To such a size did his library grow that it over-ran eight houses, some in England, some on the Continent. It is estimated to have cost over £100,000, and after his death the sale of that part of his collection stored in England realized more than £56,000. He is known to have owned 150,000 volumes, and probably many more. He possessed extensive landed property in Shropshire and Yorkshire, and was sheriff of the former county in 1821, was member of Parliament for Oxford University from 1821-1826, and in 1822 was made a D.C.L. of that University. He was one of the founders of the Athenaeum Club, London. He died in London on the 4th of October 1833.

HEBERDEN, WILLIAM (1710-1801), English physician, was born in London in 1710. In the end of 1724 he was sent to St John's College, Cambridge, where he obtained a fellowship about 1730, became master of arts in 1732, and took the degree of M.D. in 1739. He remained at Cambridge nearly ten years longer practising medicine, and gave an annual course of lectures on *materia medica*. In 1746 he became a fellow of the Royal College of Physicians in London; and two years later he settled in London, where he was elected a fellow of the Royal Society in 1749, and enjoyed an extensive medical practice for more than thirty years. At the age of seventy-two he partially retired, spending his summers at a house which he had taken at Windsor, but he continued to practise in London during the winter for some years longer. In 1778 he was made an honorary member of the Paris Royal Society of Medicine. He died in London on the 17th of May 1801. Heberden, who was a good classical scholar, published several papers in the *Phil. Trans.* of the Royal Society, and among his noteworthy contributions to the *Medical Transactions* (issued, largely at his suggestion, by the College of Physicians) were papers on chicken-pox (1767) and angina pectoris (1768). His *Commentarii de morborum historia et curatione*, the result of careful notes made in his pocket-book at the bedside of his patients, were published in 1802; in the following year an English translation appeared, believed to be from the pen of his son, William Heberden (1767-

1845), also a distinguished scholar and physician, who attended King George III. in his last illness.

HÉBERT, EDMOND (1812-1890), French geologist, was born at Villefargau, Yonne, on the 12th of June 1812. He was educated at the Collège de Meaux, Auxerre, and at the École Normale in Paris. In 1836 he became professor at Meaux, in 1838 demonstrator in chemistry and physics at the École Normale, and in 1841 sub-director of studies at that school and lecturer on geology. In 1857 the degree of D. ès Sc. was conferred upon him, and he was appointed professor of geology at the Sorbonne. There he was eminently successful as a teacher, and worked with great zeal in the field, adding much to the knowledge of the Jurassic and older strata. He devoted, however, special attention to the subdivisions of the Cretaceous and Tertiary formations in France, and to their correlation with the strata in England and in southern Europe. To him we owe the first definite arrangement of the Chalk into palaeontological zones (see Table in *Geol. Mag.*, 1869, p. 200). During his later years he was regarded as the leading geologist in France. He was elected a member of the Institute in 1877, Commander of the Legion of Honour in 1885, and he was three times president of the Geological Society of France. He died in Paris on the 4th of April 1890.

HÉBERT, JACQUES RENÉ (1757-1794), French Revolutionist, called "Père Duchesne," from the newspaper he edited, was born at Alençon, on the 15th of November 1757, where his father, who kept a goldsmith's shop, had held some municipal office. His family was ruined, however, by a lawsuit while he was still young, and Hébert came to Paris, where in his struggle against poverty he endured great hardships; the accusations of theft directed against him later by Camille Desmoulins were, however, without foundation. In 1790 he attracted attention by some pamphlets, and became a prominent member of the club of the Cordeliers in 1791. On the 10th of August 1792 he was a member of the revolutionary Commune of Paris, and became second substitute of the *procureur* of the Commune on the 2nd of December 1792. His violent attacks on the Girondists led to his arrest on the 24th of May 1793, but he was released owing to the threatening attitude of the mob. Henceforth very popular, Hébert organized with P. G. Chaumette (*q.v.*) the "worship of Reason," in opposition to the theistic cult inaugurated by Robespierre, against whom he tried to excite a popular movement. The failure of this brought about the arrest of the Hébertists, or *enragés*, as his partisans were called. Hébert was guillotined on the 24th of March 1794. His wife, who had been a nun, was executed twenty days later. Hébert's influence was mainly due to his articles in his journal *Le Père Duchesne*, which appeared from 1790 to 1794. These articles, while not lacking in a certain cleverness, were violent and abusive, and purposely couched in foul language in order to appeal to the mob.

See Louis Duval, "Hébert chez lui," in *La Révolution Française, revue d'histoire moderne et contemporaine*, t. xii. and t. xiii.; D. Mater, *J. R. Hébert, l'auteur du Père Duchesne avant la journée du 10 août 1792* (Bourges, Comm. Hist. du Cher, 1888); F. A. Aulard, *La Culte de la raison et de l'être suprême* (Paris, 1892).

HEBREW LANGUAGE. The name "Hebrew" is derived, through the Greek Ἑβραῖος, from *ibhray*, the Aramaic equivalent of the Old Testament word *ibhri*, denoting the people who commonly spoke of themselves as Israel or Children of Israel from the name of their common ancestor (see **JEW**). The later derivative *Yisra'elî*, Israelite, from *Yisra'el*, is not found in the Old Testament.¹ Other names used for the language of Israel are *speech of Canaan* (Isa. xix. 18) and *Yehûdîth*, Jewish, (2 Kings xviii. 26). In later times it was called the *holy tongue*. The real meaning of the word *ibhri* must ultimately be sought in the root *'abhar*, to pass across, to go beyond, from which is derived the noun *'ebher*, meaning the "farther bank" of a river. The usual explanation of the term is that of Jewish tradition

¹ There were several journals of this name, the best known of the others being that edited by Lemaire.

² In 2 Sam. xvii. 25 *Ysraélite* should be *Ishmaélite*, as in the parallel passage 1 Chron. ii. 17.

that *'ibhri* means the man "from the other side," i.e. either of the Euphrates or the Jordan. Hence the Septuagint in Gen. xiv. 13 render Abram *ka-'ibhri* by $\delta \pi \epsilon \rho \alpha \tau \rho \eta \varsigma$, the "crosser," and Aquila, following the same tradition, has $\delta \pi \epsilon \rho \alpha \tau \rho \eta \varsigma$, the man "from beyond." This view of course implies that the term was originally applied to Abram or his descendants by a people living on the west of the Euphrates or of the Jordan. It has been suggested that the root *'abhar* is to be taken in the sense of "travelling," and that Abram the wandering Aramaean (Deut. xxvi. 5) was called *ka-'ibhri* because he travelled about for trading purposes, his language, *'ibhri*, being the *lingua franca* of Eastern trade. The use of the term $\alpha \rho \alpha \iota \omega \tau \iota$ for biblical Hebrew is first found in the Greek prologue to Ecclesiasticus (c. 130 B.C.). In the New Testament it denotes the native language of Palestine (Aramaic and Hebrew being popularly confused) as opposed to Greek. In modern usage the name Hebrew is applied to that branch of the northern part of the Semitic family of languages which was used by the Israelites during most of the time of their national existence in Palestine, and in which nearly all their sacred writings are composed. As to its characteristics and relation to other languages of the same stock, see SEMITIC LANGUAGES. It also includes the later forms of the same language as used by Jewish writers after the close of the Canon throughout the middle ages (Rabbinical Hebrew) and to the present day (New Hebrew).

Before the rise of comparative philology it was a popular opinion that Hebrew was the original speech of mankind, from which all others were descended. This belief, derived from the Jews (cf. Pal. Targ. Gen. xi. 1), was supported by the etymologies and other data supplied by the early chapters of Genesis. But though Hebrew possesses a very old literature, it is not, as we know it, structurally as early as, e.g. Arabic, or, in other words, it does not come so near to that primitive Semitic speech which may be pre-supposed as the common parent of all the Semitic languages. Owing to the imperfection of the Hebrew alphabet, which, like that of most Semitic languages, has no means of expressing vowel-sounds, it is only partly possible to trace the development of the language. In its earliest form it was no doubt most closely allied to the Canaanite or Phoenician stock, to the language of Moab, as revealed by the stele of Mesha (c. 850 B.C.), and to Edomite. The vocalization of Canaanite, as far as it is known to us, e.g. from glosses in the Tell-el-Amarna tablets (15th century B.C.)¹ and much later from the Punic passages in the *Poenulus* of Plautus, differs in many respects from that of the Hebrew of the Old Testament, as also does the Septuagint transcription of proper names. The uniformity, however, of the Old Testament text is due to the labours of successive schools of grammarians who elaborated the Massorah (see HEBREW LITERATURE), thereby obliterating local or dialectic differences, which undoubtedly existed, and establishing the pronunciation current in the synagogues about the 7th century A.D. The only mention of such differences in the Old Testament is in Judges xii. 6, where it is stated that the Ephraimites pronounced ϑ (sh) as β or ν (s). In Neh. xiii. 24, the "speech of Ashdod" is more probably a distinct (Philistine) language. Certain peculiarities in the language of the Pentateuch ($\alpha \nu$ for $\alpha \nu \nu$, ω for $\omega \omega$), which used to be regarded as archaisms, are to be explained as purely orthographical.² In a series of writings, however, extending over so long a period as those of the Old Testament, some variation or development in language is to be expected apart from the natural differences between the poetic (or prophetic) and prose styles. The consonantal text sometimes betrays these in spite of the Massorah. In general, the later books of the Old Testament show, roughly speaking, a greater simplicity and uniformity of style, as well as a tendency to Aramaisms. For some centuries after the Exile, the people of Palestine must have been bilingual, speaking Aramaic for ordinary purposes, but still at least understanding Hebrew. Not that they forgot their own tongue in the Captivity and learnt Aramaic in Babylon, as used to be supposed. In the western

provinces of the Persian empire Aramaic was the official language, spoken not only in Palestine but in all the surrounding countries, even in Egypt and among Arab tribes such as the Nabateans. It is natural, therefore, that it should influence and finally supplant Hebrew in popular use, so that translations even of the Old Testament eventually appear in it (TARGUMS). Meanwhile Hebrew did not become a dead language—indeed it can hardly be said ever to have died, since it has continued in use till the present day for the purposes of ordinary life among educated Jews in all parts of the world. It gradually became a literary rather than a popular tongue, as appears from the style of the later books of the Old Testament (Chron., Dan., Eccles.), and from the Hebrew text of Ecclesiasticus (c. 170 B.C.). During the 1st century B.C. and the 1st century A.D. we have no direct evidence of its characteristics. After that period there is a great development in the language of the Mishna. It was still living Hebrew, although mainly confined to the schools, with very clear differences from the biblical language. In the Old Testament the range of subjects was limited. In the Mishna it was very much extended. Matters relating to daily life had to be discussed, and words and phrases were adopted from what was no doubt the popular language of an earlier period. A great many foreign words were also introduced. The language being no longer familiar in the same sense as formerly, greater definiteness of expression became necessary in the written style. In order to avoid the uncertainty arising from the lack of vowels to distinguish forms consisting of the same consonants (for the vowel-points were not yet invented), the aramaizing use of the reflexive conjugations (Hitpa'el, Nithpa'el) for the internal passives (Pa'al, Hoph'al) became common; particles were used to express the genitive and other relations, and in general there was an endeavour to avoid the obscurities of a purely consonantal writing. What is practically Mishmic Hebrew continued to be used in Midrash for some centuries. The language of both Talmuds, which, roughly speaking, were growing contemporaneously with Midrash, is a mixture of Hebrew and Aramaic (Eastern Aram. in the Babylonian, Western in the Jerusalem Talmud), as was also that of the earlier commentators. As the popular use of Aramaic was gradually restricted by the spread of Arabic as the vernacular (from the 7th century onwards), while the dispersion of the Jews became wider, biblical Hebrew again came to be the natural standard both of East and West. The cultivation of it is shown and was no doubt promoted by the many philological works (grammars, lexicons and masorah) which are extant from the 10th century onward. In Spain, under Moorish dominion, most of the important works of that period were composed in Arabic, and the influence of Arabic writers both on language and method may be seen in contemporaneous Hebrew compositions. No other vernacular (except, of course, Aramaic) ever had the same influence upon Hebrew, largely because no other bears so close a relation to it. At the present day in the East, and among learned Jews elsewhere, Hebrew is still cultivated conversationally, and it is widely used for literary purposes. Numerous works on all kinds of subjects are produced in various countries, periodicals flourish, and Hebrew is the vehicle of correspondence between Jews in all parts of the world. Naturally its quality varies with the ability and education of the writer. In the modern *pronunciations* the principal differences are between the Ashkenazim (German and Polish Jews) and the Sephardim (Spanish and Portuguese Jews), and concern not only the vowels but also certain consonants, and in some cases probably go back to early times. As regards *writing*, it is most likely that the oldest Hebrew records were preserved in some form of cuneiform script. The alphabet (see WRITING) subsequently adopted is seen in its earliest form on the stele of Mesha, and has been retained, with modifications, by the Samaritans. According to Jewish tradition Ezra introduced the Assyrian character ($\aleph \text{ } \aleph \text{ } \aleph$), a much-debated statement which no doubt means that the Aramaic hand in use in Babylonia was adopted by the Jews about the 5th century B.C. Another form of the same hand, allowing for differences of material, is found in Egyptian Aramaic papyri of the 5th and 4th

¹ See Zimmern, in *Ztsch. für Assyriol.* (1891), p. 154.

² See Gesenius-Kautzsch, *Hebr. Gram.* § 17 c.

centuries B.C. From this were developed (a) the square character used in MSS. of the Bible or important texts, and in most printed books, (b) the *Rabbinic* (or Rashi) character, used in commentaries and treatises of all kinds, both in MS. and in printed books, (c) the *Cursive* character, used in letters and for informal purposes, not as a rule printed. In the present state of Hebrew palaeography it is not possible to determine accurately the date of a MS., but it is easy to recognize the country in which it was written. The most clearly marked distinctions are between Spanish, French, German, Italian, Maghrebi, Greek, Syrian (including Egyptian), Yemenite, Persian and Qaraite hands. It is in the Rabbinic and Cursive characters that the differences are most noticeable. The Hebrew alphabet is also used, generally with the addition of some diacritical marks, by Jews to write other languages, chiefly Arabic, Spanish, Persian, Greek, Tatar (by Qaraïtes) and in later times German.

The philological study of Hebrew among the Jews is described below, under Hebrew Literature, of which it formed an integral part. Among Christian scholars there was no independent school of Hebraists before the revival of learning. In the Greek and Latin Church the few fathers who, like Origen and Jerome, knew something of the language, were wholly dependent on their Jewish teachers, and their chief value for us is as depositaries of Jewish tradition. Similarly in the East, the Syriac version of the Old Testament is largely under the influence of the synagogue, and the homilies of Aphraates are a mine of Rabbinic lore. In the middle ages some knowledge of Hebrew was preserved in the Church by converted Jews and even by non-Jewish scholars, of whom the most notable were the Dominican controversialist Raymondus Martini (in his *Pugio fidei*) and the Franciscan Nicolus of Lyra, on whom Luther drew largely in his interpretation of Scripture. But there was no tradition of Hebrew study apart from the Jews, and in the 15th century when an interest in the subject was awakened, only the most ardent zeal could conquer the obstacles that lay in the way. Orthodox Jews refused to teach those who were not of their faith, and on the other hand many churchmen conscientiously believed in the duty of entirely suppressing Jewish learning. Even books were to be had only with the greatest difficulty, at least north of the Alps. In Italy things were somewhat better. Jews expelled from Spain received favour from the popes. Study was facilitated by the use of the printing-press, and some of the earliest books printed were in Hebrew. The father of Hebrew study among Christians was the humanist Johann Reuchlin (1455-1522), the author of the *Rudimenta Hebraïca* (Pforzheim, 1506), whose contest with the converted Jew Pfefferkorn and the Cologne obscurantists, established the claim of the new study to recognition by the Church. Interest in the subject spread rapidly. Among Reuchlin's own pupils were Melancthon, Oecolampadius and Cellarius, while Sebastian Münster in Heidelberg (afterwards professor at Basel), and Büchlein (Fagius) at Isny, Strasburg and Cambridge, were pupils of the liberal Jewish scholar Elias Levita. France drew teachers from Italy. Santes Pagninus of Lucca was at Lyons; and the trilingual college of Francis I. at Paris, with Vatablus and le Mercier, attracted, among other foreigners, Giustiniani, bishop of Nebbio, the editor of the Genoa psalter of 1516. In Rome the converted Jew Felix Pratensis taught under the patronage of Leo X., and did useful work in connexion with the great Bomberg Bibles. In Spain Hebrew learning was promoted by Cardinal Ximenes, the patron of the Complutensian Polyglot. The printers, as J. Froben at Basel and Étienne at Paris, also produced Hebrew books. For a time Christian scholars still leaned mainly on the Rabbis. But a more independent spirit soon arose, of which le Mercier in the 16th, and Drusius early in the 17th century, may be taken as representatives. In the 17th century too the cognate languages were studied by J. Selden, E. Castell (Heptaglott lexicon) and E. Pococke (Arabic) in England, Ludovicus de Dieu in Holland, S. Bochart in France, J. Ludolf (Ethiopic) and J. H. Hottinger (Syriac) in Germany, with advantage to the Hebrew grammar and lexicon. Rabbinic learning moreover was cultivated at

Basel by the elder Buxtorf who was the author of grammatical works and a lexicon. With the rise of criticism Hebrew philology soon became a necessary department of theology. Cappellus (d. 1658) followed Levita in maintaining, against Buxtorf, the late introduction of the vowel-points, a controversy in which the authority of the massoretic text was concerned. He was supported by J. Morin and R. Simon in France. In the 18th century in Holland A. Schultens and N. W. Schroeder used the comparative method, with great success, relying mainly on Arabic. In Germany there was the meritorious J. D. Michaelis and in France the brilliant S. de Sacy. In the 19th century the greatest name among Hebraists is that of Gesenius, at Halle, whose shorter grammar (of Biblical Hebrew) first published in 1813, is still the standard work, thanks to the ability with which his pupil E. Rödiger and recently E. Kautzsch have revised and enlarged it. Important work was also done by G. H. A. Ewald, J. Olshausen and P. A. de Lagarde, not to mention later scholars who have utilized the valuable results of Assyriological research.

BIBLIOGRAPHY.—Among the numerous works dealing with the study of Hebrew, the following are some of the most practically useful.

Grammars, Introductory.—Davidson, *Introductory Hebrew Grammar* (9th ed., Edinburgh, 1888); and *Syntax* (Edinburgh, 1894). Advanced: Gesenius's *Hebräische Grammatik*, ed. Kautzsch (28th ed., Leipzig, 1909; Eng. trans., Oxford, 1910); also Driver, *Treatise on the Use of the Tenses in Hebrew* (3rd ed., Oxford, 1892). For post-biblical Hebrew, Strack and Siegfried, *Lehrbuch d. neuhebräischen Sprache* (Leipzig, 1884).

Comparative Grammar.—Wright, *Lectures on the Comp. Grammar of the Sem. Lang.* (Cambridge, 1890); Brockelmann, *Grundriss der vergleichenden Grammatik* (Berlin, 1907, &c.).

Lexicons.—Gesenius's *Thesaurus philologicus* (Leipzig, 1829-1858), and his *Hebräisches Handwörterbuch* (15th ed. by Zimmern and Buhl, Leipzig, 1910); Brown, Briggs and Driver, *Hebrew and Eng. Lexicon* (Oxford, 1892-1906). For later Hebrew: Levy, *Neuhebräisches Wörterbuch* (Leipzig, 1876-1899); Jastrow, *Dictionary of the Targumi, &c.* (New York, 1886, &c.); Dalman, *Aramaisches neuhebräisches Wörterbuch* (Frankfurt a. M., 1897); Kohut, *Aruch completum* (Vienna, 1878-1890) (in Hebrew) is valuable for the language of the Talmud. (A. Cy.)

HEBREW LITERATURE. Properly speaking, "Hebrew Literature" denotes all works written in the Hebrew language. In catalogues and bibliographies, however, the expression is now generally used, conveniently if incorrectly, as synonymous with Jewish literature, including all works written by Jews in Hebrew characters, whether the language be Aramaic, Arabic or even some vernacular not related to Hebrew.

The literature begins with, as it is almost entirely based upon, the Old Testament. There were no doubt in the earliest times popular songs orally transmitted and perhaps books of annals and laws, but except in so far as remnants of them are embedded in the biblical books, they have entirely disappeared. Thus the Book of the Wars of the Lord is mentioned in Num. xxi. 14; the Book of Jasher in Josh. x. 13, 2. Sam. i. 18; the Song of the Well is quoted in Num. xxi. 17, 18, and the song of Sihon and Moab, *ib.* 27-30; of Lamech, Gen. iv. 23, 24; of Moses, Exod. xv. As in other literatures, these popular elements form the foundation on which greater works are gradually built, and it is one function of literary criticism to show the way in which the component parts were welded into a uniform whole. The traditional view that Moses was the author of the Pentateuch in its present form, would make this the earliest monument of Hebrew literature. Modern inquiry, however, has arrived at other conclusions (see BIBLE, *Old Testament*), which may be briefly summarized as follows: the Pentateuch is compiled from various documents, the earliest of which is denoted by J (beginning at Gen. ii. 4) from the fact that its author regularly uses the divine name Jehovah (Yahweh). Its date is now usually given as about 800 B.C.¹ In the next century the document E was composed, so called from its using

¹ The dating of these documents is extremely difficult, since it is based entirely on internal evidence. Various scholars, while agreeing on the actual divisions of the text, differ on the question of priority. The dates here given are those which seem to be most generally accepted at the present time. They are not put forward as the result of an independent review of the evidence.

Elohim (God) instead of Yahweh. Both these documents are considered to have originated in the Northern kingdom, Israel, where also in the 8th century appeared the prophets Amos and Hosea. To the same period belong the book of Micah, the earlier parts of the books of Samuel, of Isaiah and of Proverbs, and perhaps some Psalms. In 722 B.C. Samaria was taken and the Northern kingdom ceased to exist. Judah suffered also, and it is not until a century later that any important literary activity is again manifested. The main part of the book of Deuteronomy was "found" shortly before 621 B.C. and about the same time appeared the prophets Jeremiah and Zephaniah, and perhaps the book of Ruth. A few years later (about 600) the two Pentateuchal documents J and E were woven together, the books of Kings were compiled, the book of Habakkuk and parts of the Proverbs were written. Early in the next century Jerusalem was taken by Nebuchadrezzar, and the prophet Ezekiel was among the exiles with Jehoiachin. Somewhat later (c. 550) the combined document JE was edited by a writer under the influence of Deuteronomy, the later parts of the books of Samuel were written, parts of Isaiah, the books of Obadiah, Haggai, Zechariah and perhaps the later Proverbs. In the exile, but probably after 500 B.C., an important section of the Hexateuch, usually called the Priest's Code (P), was drawn up. At various times in the same century are to be placed the book of Job, the post-exilic parts of Isaiah, the books of Joel, Jonah, Malachi and the Song of Songs. The Pentateuch (or Hexateuch) was finally completed in its present form at some time before 400 B.C. The latest parts of the Old Testament are the books of Chronicles, Ezra and Nehemiah (c. 330 B.C.), Ecclesiastes and Esther (3rd century) and Daniel, composed either in the 3rd century or according to some views as late as the time of Antiochus Epiphanes (c. 168 B.C.). With regard to the date of the Psalms, internal evidence, from the nature of the case, leads to few results which are convincing. The most reasonable view seems to be that the collection was formed gradually and that the process was going on during most of the period sketched above.

It is not to be supposed that all the contents of the Old Testament were immediately accepted as sacred, or that they were ever all regarded as being on the same level. The Torah, the Law delivered to Moses, held among the Jews of the 4th century B.C. as it holds now, a pre-eminent position. The inclusion of other books in the Canon was gradual, and was effected only after centuries of debate. The Jews have always been, however, an intensely literary people, and the books ultimately accepted as canonical were only a selection from the literature in existence at the beginning of the Christian era. The rejected books receiving little attention have mostly either been altogether lost or have survived only in translations, as in the case of the Apocrypha. Hence from the composition of the latest canonical books to the redaction of the Mishna (see below) in the 2nd century A.D., the remains of Hebrew literature are very scanty. Of books of this period which are known to have existed in Hebrew or Aramaic up to the time of Jerome (and even later) we now possess most of the original Hebrew text of Ben Sira (Ecclesiasticus) in a somewhat corrupt form, and fragments of an Aramaic text of a recension of the Testaments of the Twelve Patriarchs, both discovered within recent years. Besides definite works of this kind, there was also being formed during this period a large body of exegetical and legal material, for the most part orally transmitted, which only received its literary form much later. As Hebrew became less familiar to the people, a system of translating the text of the Law into the Aramaic vernacular verse by verse, was adopted in the synagogue. The beginnings of it are supposed to be indicated in Neh. viii. 8. The translation was no doubt originally extemporary, and varied with the individual translators, but its form gradually became fixed and was ultimately written down. It was called *Targum*, from the *Targum*. Aramaic *targem*, to translate. The earliest to be thus edited was the Targum of Onkelos (Onqelos), the proselyte, on the Law. It received its final form in Babylonia probably in the 3rd century A.D. The Samaritan Targum, of about the same

date, clearly rests on the same tradition. Parallel to Onkelos was another Targum on the Law, generally called pseudo-Jonathan, which was edited in the 7th century in Palestine, and is based on the same system of interpretation but is fuller and closer to the original tradition. There is also a fragmentary Targum (Palestinian) the relation of which to the others is obscure. It may be only a series of disconnected glosses on Onkelos. For the other books, the recognized Targum on the Prophets is that ascribed to Jonathan ben Uzziel (4th century?), which originated in Palestine, but was edited in Babylonia, so that it has the same history and linguistic character as Onkelos. Just as there is a Palestinian Targum on the Law parallel to the Babylonian Onkelos, so there is a Palestinian Targum (called *Yerushalmi*) on the Prophets parallel to that of Ben Uzziel, but of later date and incomplete. The Law and the Prophets being alone used in the services of the synagogue, there was no authorized version of the rest of the Canon. There are, however, Targumim on the Psalms and Job, composed in the 5th century, on Proverbs, resembling the Peshitta version, on the five Meghilloth, paraphrastic and agadic (see below) in character, and on Chronicles—all Palestinian. There is also a second Targum on Esther. There is none on Daniel, Ezra and Nehemiah.

We must now return to the 2nd century. During the period which followed the later canonical books, not only was translation, and therefore exegesis, cultivated, but even more the amplification of the Law. According to Jewish teaching (e.g. Abhoth i. 1) Moses received on Mount Sinai not only the written Law as set down in the Pentateuch, but also the Oral Law, which he communicated personally to the 70 elders and through them by a "chain of tradition" to succeeding ages. The application of this oral law is called *Halakhah*, the rules by which a man's daily "walk" is regulated. The *halakhah* was by no means inferior in prestige to the written Law. Indeed some teachers even went so far as to ascribe a higher value to it, since it comes into closer relation with the details of everyday life. It was not independent of the written Law, still less could it be in opposition to it. Rather it was implicitly contained in the Torah, and the duty of the teacher was to show this. It was therefore of the first importance that the chain of tradition should be continuous and trustworthy. The line is traced through biblical teachers to Ezra, the first of the Sopherim or scribes, who handed on the charge to the "men of the Great Synagogue," a much-discussed term for a body or succession of teachers inaugurated by Ezra. The last member of it, Simon the Just (either Simon I., who died about 300 B.C., or Simon II., who died about 200 B.C.), was the first of the next series, called Elders, represented in the tradition by *pairs* of teachers, ending with Hillel and Shammai about the beginning of the Christian era. Their pupils form the starting-point of the next series, the *Tannaim* (from Aram. *tenâ* to teach), who occupy the first two centuries A.D.

By this time the collection of halakhic material had become very large and various, and after several attempts had been made to reduce it to uniformity, a code of oral tradition was finally drawn up in the 2nd century by Judah ha-Nasi, called Rabbi *par excellence*. This was the Mishnah. Its name is derived from the Hebrew *shanah*, corresponding to the Aramaic *tenâ*, and therefore a suitable name for a tannaïtic work, meaning the *repetition* or *teaching* of the oral law. It is written in the Hebrew of the schools (*leshon hakhamim*) which differs in many respects from that of the Old Testament (see HEBREW LANGUAGE). It is divided into six "orders," according to subject, and each order is subdivided into chapters. In making his selection of halakhôth, Rabbi used the earlier compilations, which are quoted as "words of Rabbi 'Aqiba" or of R. Me'ir, but rejected much which was afterwards collected under the title of *Tosefta* (*addition*) and *Baraita* (*outside* the Mishnah).

Traditional teaching was, however, not confined to halakhah. As observed above, it was the duty of the teachers to show the connexion of practical rules with the written Law, the more so since the Sadducees rejected the authority of the oral law as such. Hence arises Midrash, *exposition*, from

derash to "investigate" a scriptural passage. Of this halakhic Midrash we possess that on Exodus, called Mekhilta, that on Leviticus, called Sifra, and that on Numbers and Deuteronomy, called Sifre. All of these were drawn up in the period of the Amoraim, the order of teachers who succeeded the Tannaim, from the close of the Mishnah to about A.D. 500. The term Midrash, however, more commonly implies *agada*, i.e. the homiletical exposition of the text, with illustrations designed to make it more attractive to the readers or hearer. Picturesque teaching of this kind was always popular, and specimens of it are familiar in the Gospel discourses. It began, as a method, with the Sopherim (though there are traces in the Old Testament itself), and was most developed among the Tannaim and Amoraim, rivalling even the study of halakha. As the existing halakhôth were collected and edited in the Mishnah, so the much larger agadic material was gathered together and arranged in the Midrashim. Apart from the agadic parts of the earlier Mekhilta, Sifra and Sifre, the most important of these collections (which are anonymous) form a sort of continuous commentary on various books of the Bible. They were called *Rabbôth* (great Midrashim) to distinguish them from preceding smaller collections. *Beresith Rabba*, on Genesis, and *Ekkhah Rabbai*, on Lamentations, were probably edited in the 7th century. Of the same character and of about the same date are the *Pesiqta*, on the lessons for Sabbaths and feast-days, and *Wayyiqra R.* on Leviticus. A century perhaps later is the *Tanpuma*, on the sections of the Pentateuch, and later still the *Pesiqta Rabbati*, *Shemôth R.* (on Exodus), *Bemidbar R.* (on Numbers), *Debharim R.* (on Deuteronomy). There are also Midrashim on the Canticle, Ruth, Ecclesiastes, Esther and the Psalms, belonging to this later period, the *Pirqe R. Eliezer*, of the 8th or 9th century, a sort of history of creation and of the patriarchs, and the *Tanna debi Eiyahô* (an ethical work of the 10th century but containing much that is old), besides a large number of minor compositions. In general, these performed very much the same function as the lives of saints in the early and medieval church. Very important for the study of Midrashic literature are the *Yalqut (gleaning) Shim'on*, on the whole Bible, the *Yalqut Makhiri*, on the Prophets, Psalms, Proverbs and Job, and the *Midrash ha-gadol*,¹ all of which are of uncertain but late date and preserve earlier material. The last, which is preserved in MSS. from Yemen, is especially valuable as representing an independent tradition.

Meanwhile, if agadic exegesis was popular in the centuries following the redaction of the Mishnah, the study of halakha *Talmud* was by no means neglected. As the discussion of the Law led up to the compilation of the Mishnah, so the Mishnah itself became in turn the subject of further discussion. The material thus accumulated, both halakhic and agadic, forming a commentary on and amplification of the Mishnah, was eventually written down under the name of *Gemara* (from *gemar*, to learn completely), the two together forming the *Talmud* (properly "instruction"). The tradition, as in the case of the Targums, was again twofold; that which had grown up in the Palestinian Schools and that of Babylonia. The foundation, however, the Mishnah, was the same in both. Both works were due to the Amoraim and were completed by about A.D. 500, though the date at which they were actually committed to writing is very uncertain. It is probable that notes or selections were from time to time written down to help in teaching and learning the immense mass of material, in spite of the fact that even in Sherira's time (11th century) such aids to memory were not officially recognized. Both Talmuds are arranged according to the six orders of the Mishnah, but the discussion of the Mishnic text often wanders off into widely different topics. Neither is altogether complete. In the Palestinian Talmud (*Yerushalmi*) the gemara of the 5th order (*Qodashim*) and of nearly all the 6th (*Tohorôth*) is missing, besides smaller parts.

¹ See especially A. Jellinek's *Bei-ha-Midrash* (Leipzig, 1853), for these lesser midrashim.

² That on Genesis was edited for the first time by Schechter (Cambridge, 1902).

In the Babylonian Talmud (*Babli*) there is no gemara to the smaller tractates of Order 1, and to parts of ii., iv., v., vi. The language of both gemaras is in the main the Aramaic vernacular (western Aramaic in Yerushalmi, eastern in Babli), but early halakhic traditions (e.g. of Tannaic origin) are given in their original form, and the discussion of them is usually also in Hebrew. Babli is not only greater in bulk than Yerushalmi, but has also received far greater attention, so that the name Talmud alone is often used for it. As being a constant object of study numerous commentaries have been written on the Talmud from the earliest times till the present. The most important of them for the understanding of the gemara (Babli) is that of Rashi³ (Solomon ben Isaac, d. 1104) with the *Tosefôth* (additions, not to be confused with the *Tosefta*) chiefly by the French school of rabbis following Rashi. These are always printed in the editions on the same page as the Mishnah and Gemara, the whole, with various other matter, filling generally about 12 folio volumes. Since the introduction of printing, the Talmud is always cited by the number of the leaf in the first edition (Venice, 1520, &c.), to which all subsequent editions conform. In order to facilitate the practical study of the Talmud, it was natural that abridgements of it should be made. Two of these may be mentioned which are usually found in the larger editions: that by Isaac Alfasi (i.e. of Fez) in the 11th century, often cited in the Jewish manner as *Rif*; and that by Asher ben Yehiel (d. 1328) of Toledo, usually cited as *Rabenu Asher*. The object of both was to collect all halakhôth having a practical importance, omitting all those which owing to circumstances no longer possess more than an academic interest, and excluding the discussions on them and all agada. Both add notes and explanations of their own, and both have in turn formed the text of commentaries.

With the Talmud, the anonymous period of Hebrew literature may be considered to end. Henceforward important works are produced not by schools but by particular teachers, *Masorah* who, however, no doubt often represent the opinions of a school. There are two branches of work which partake of both characters, the *Masorah* and the *Liturgy*. The name *Masorah* (*Masorah*) is usually derived from *masar*, to hand on, and explained as "tradition." According to others⁴ it is the word found in Ezek. xx. 37, meaning a "fetter." Its object was to fix the biblical text unalterably. It is generally divided into the *Great* and the *Small Masorah*, forming together an *apparatus criticus* which grew up gradually in the course of centuries and now accompanies the text in most MSS. and printed editions to a greater or less extent. There are also separate masoretic treatises. Some system of the kind was necessary to guard against corruptions of copyists, while the care bestowed upon it no doubt reacted so as to enhance the sanctity ascribed to the text. Many apparent puerilities, such as the counting of letters and the marking of the middle point of books, had a practical use in enabling copyists of MSS. to determine the amount of work done. The registration of anomalies, such as the suspended letters, inverted *nûns* and larger letters, enabled any one to test the accuracy of a copy. But the work of the Masoretes was much greater than this. Their long lists of the occurrences of words and forms fixed with accuracy the present (Masoretic) text, which they had produced, and were invaluable to subsequent lexicographers, while their system of vowel-points and accents not only gives us the pronunciation and manner of reading traditional about the 7th century A.D., but frequently serves also the purpose of an explanatory commentary. (See further under BIBLE.) Most of the *Masorah* is anonymous, including the *Masseketh Sopherim* (of various dates from perhaps the 6th to the 9th century) and the *Okhlah we-Okhlah*, but when the period of anonymous literature ceases, there appear (in the 10th century) Ben Asher of Tiberias, the greatest authority on the subject, and his opponent Ben Naphthali. Later on, Jacob

³ In Hebrew מֵרַשִׁי, from the initial letters of Rabbi Shelomoh Yizhaqî, a convenient method used by Jewish writers in referring to well-known authors. The name Jarchi, formerly used for Rashi, rests on a misunderstanding.

⁴ So Bacher in *J.Q.R.* iii. 785 sqq.

ben Haiyim arranged the Massorah for the great Bomberg Bible of 1524. Elias Levita's *Massoreth ha-Massoreth* (1538) and Buxtorf's *Tiberias* (1620) are also important.

We must now turn back to a most difficult subject—the growth of the Liturgy. We are not concerned here with indications of the ritual used in the Temple. Of the prayer-

Liturgy. book as it is at present, the earliest parts are the Shema' (Deut. vi. 4, &c.) and the anonymous blessings commonly called Shemoneh 'Eseh (the Eighteen), together with certain Psalms. (Readings from the Law and the Prophets [Haph[ar]ah] also formed part of the service.) To this framework were fitted, from time to time, various prayers, and, for festivals especially, numerous hymns. The earliest existing codification of the prayer-book is the *Siddur* (order) drawn up by Amram Gaon of Sura about 850. Half a century later the famous Gaon Seadiah, also of Sura, issued his *Siddur*, in which the rubrical matter is in Arabic. Besides the *Siddur*, or order for Sabbaths and general use, there is the *Maḥzor* (cycle) for festivals and fasts. In both there are ritual differences according to the Sephardic (Spanish), Ashkenazic (German-Polish), Roman (Greek and South Italian) and some minor uses, in the later additions to the Liturgy. The Maḥzor of each rite is also distinguished by hymns (*piyyuṭim*) composed by authors (*payyefanim*) of the district. The most important writers are Yoseh ben Yoseh, probably in the 6th century, chiefly known for his compositions for the day of Atonement, Elcazar Qalir, the founder of the payyetic style, perhaps in the 7th century, Seadiah, and the Spanish school consisting of Joseph ibn Abitur (died in 970), Ibn Gabirol, Isaac Gayyath, Moses ben Ezra, Abraham ben Ezra and Judah ha-levi, who will be mentioned below; later, Moses ben Naḥman and Isaac Luria the Kabbalist.¹

The order of the Amoraim, which ended with the close of the Talmud (A.D. 500), was succeeded by that of the Sabōraim, who

merely continued and explained the work of their predecessors, and these again were followed by the

The Geōnim. Geōnim, the heads of the schools of Sura and Pumbeditha in Babylonia. The office of Gaon lasted for something over 400 years, beginning about A.D. 600, and varied in importance according to the ability of the holders of it. Individual Geōnim produced valuable works (of which later), but what is perhaps most important from the point of view of the development of Judaism is the literature of their Responsa or answers to questions, chiefly on halakhic matters, addressed to them from various countries. Some of these were actual decisions of particular Geōnim; others were an official summary of the discussion of the subject by the members of the School. They begin with Mar Rab Sheshna (7th century) and continue to Hai Gaon, who died in 1038, and are full of historical and literary interest.² The She'iltōth (questions) of Rab Aḥai (8th century) also belong probably to the school of Pumbeditha, though their author was not Gaon. Besides the Responsa, but closely related to them, we have the lesser Halakhōth of Yehūdai Gaon of Sura (8th century) and the great Halakhōth of Simeon Qayyara of Sura (not Gaon) in the 9th century. In a different department there is the first Talmud lexicon ('*Arākhā*) now lost, by Zemaḥ ben Paltoi, Gaon of Pumbeditha in the 9th century. The *Siddur* of Amram ben Sheshna has been already mentioned. All these writers, however, are entirely eclipsed by the commanding personality of the most famous of the Geōnim, SEADIAH ben Joseph (q.v.) of Sura, often called al-Fayyūmi (of the Fayum in Egypt), one of the greatest representatives of Jewish learning of all times, who died in 942. The last three holders of the office were also distinguished. Sherira of Pumbeditha (d. 998) was the author of the famous "Letter" (in the form of a Responsum to a question addressed to him by residents in Kairawan), an historical document of the highest value and the foundation of our knowledge of the history of tradition. His son Hai, last Gaon of Pumbeditha (d. 1038), a man of wide learning, wrote

(partly in Arabic) not only numerous Responsa, but also treatises on law, commentaries on the Mishnah and the Bible, a lexicon called in Arabic *al-Hawī*, and poems such as the *Māsar Haskel*, but most of them are now lost or known only from translations or quotations. Though his teaching was largely directed against superstition, he seems to have been inclined to mysticism, and perhaps for this reason various kabbalistic works were ascribed to him in later times. His father-in-law Samuel ben Ḥophni, last Gaon of Sura (d. 1034), was a voluminous writer on law, translated the Pentateuch into Arabic, commented on much of the Bible, and composed an Arabic introduction to the Talmud, of which the existing Hebrew introduction (by Samuel the Nagid) is perhaps a translation. Most of his works are now lost.

In the Geonic period there came into prominence the sect of the Karaites (*Benē miqrā*, "followers of the Scripture"), the protestants of Judaism, who rejected rabbinical authority, basing their doctrine and practice exclusively on the Bible. The sect was founded by 'Anan in the 8th

century, and, after many vicissitudes, still exists. Their literature, with which alone we are here concerned, is largely polemical and to a great extent deals with grammar and exegesis. Of their first important authors, Benjamin al-Nehawendi and Daniel al-Qūmist (both in the 9th century), little is preserved. In the 10th century Jacob al-Qirṣāni wrote his *Kitāb al-amūr*, on law, Solomon ben Yeruḥam (against Seadiah) and Yefet ben 'Ali wrote exegetical works; in the 11th century Abū'l-faraj Furqān, exegesis, and Yūsuf al-Baṣīr against Samuel ben Ḥophni. Most of these were in Arabic. In the 12th century and in S. Europe, Judah Hadassi composed his *Eshkol ha-Kōpher*, a great theological compendium in the form of a commentary on the Decalogue. Other writers are Aaron (the elder) ben Joseph, 13th century, who wrote the commentary *Sepher ha-mibḥar*; Aaron (the younger) of Nicomedia (14th century), author of '*Ez Haiyim*, on philosophy, *Gan 'Eden*, on law, and the commentary *Kether Tōrah*; in the 15th century Elijah Bashyaḥ, on law (*Addereth Eliyahū*), and Caleb Efendipoulo, poet and theologian; in the 16th century Moses Bashyaḥ, theologian. From the 12th century onward the sect gradually declined, being ultimately restricted mainly to the Crimea and Lithuania, learning disappeared and their literature became merely popular and of little interest. Much of it in later times was written in a curious Tatar dialect. Mention need only be made further of Isaac of Troki, whose anti-Christian polemic *Ḥizūq Emaniḥ* (1593) was translated into English by Moses Mocatta under the title of *Faith Strengthened* (1851); Solomon of Troki, whose *Appiryān*, an account of Karaism, was written at the request of Pufendorf (about 1700); and Abraham Firkovich, who, in spite of his impostures, did much for the literature of his people about the middle of the 19th century. (See also QARAITEs.)

To return to the period of the Geōnim. While the schools of Babylonia were flourishing as the religious head of Judaism, the West, and especially Spain under Moorish rule,

was becoming the home of Jewish scholarship. On the breaking up of the schools many of the fugitives fled to the West and helped to promote rabbinical learning there. The communities of Fez, Kairawan and N. Africa were in close relation with those of Spain, and as early as the beginning of the 9th century Judah ben Quraish of Tahort had composed his *Risālāh* (letter) to the Jews of Fez on grammatical subjects from a comparative point of view, and a dictionary now lost. His work was used in the 10th century by Menahem ben Sarūq, of Cordova, in his *Maḥbereth* (dictionary). Menahem's system of bi-literal and uni-literal roots was violently attacked by Dūnash ibn Labrāt, and as violently defended by the author's pupils. Among these was Judah Haiyūḥ of Cordova, the father of modern Hebrew grammar, who first established the principle of tri-literal roots. His treatises on the verbs, written in Arabic, were translated into Hebrew by Moses Gikatilla (11th century), himself a considerable grammarian and commentator, and by Ibn Ezra. His system was adopted by Abū'l-walid ibn Jannah, of Saragossa (died early in the 11th century), in his lexicon (*Kitāb al-uṣūl*, in Arabic) and other works.

¹ For the history of the very extensive literature of this class, Zunz, *Literaturgeschichte der synagogalen Poesie* (Berlin, 1865), is indispensable.

² See the edition of them in Harkavy, *Studien*, iv. (Berlin, 1885).

In Italy appeared the invaluable Talmud-lexicon (*'Arakh*) by Nathan b. Yehiel, of Rome (d. 1106), who was indirectly indebted to Babylonian teaching. He does not strictly follow the system of Hayyūj. Other works of a different kind also originated in Italy about this time: the very popular history of the Jews, called *Josippon* (probably of the 10th or even 9th century), ascribed to Joseph ben Görion (Gorionides)¹; the medical treatises of Shabbethai Donnolo (10th century) and his commentary on the *Sepher Yeserah*, the anonymous and earliest Hebrew kabbalistic work ascribed to the patriarch Abraham. In North Africa, probably in the 9th century, appeared the book known under the name of *Eldad ha-Dani*, giving an account of the ten tribes, from which much medieval legend was derived;² and in Kairawan the medical and philosophical treatises of Isaac Israeli, who died in 932.

The aim of the grammatical studies of the Spanish school was ultimately exegesis. This had already been cultivated in the *Exegesis*. East. In the 9th century Hivī of Balkh wrote a rationalistic treatise³ on difficulties in the Bible, which was refuted by Seadiah. The commentaries of the Geonim have been mentioned above. The impulse to similar work in the West came also from Babylonia. In the 10th century Hushiel, one of four prisoners, perhaps from Babylonia, though that is doubtful, was ransomed and settled at Kairawan, where he acquired great reputation as a Talmudist. His son Hananeel (d. 1050) wrote a commentary on (probably all) the Talmud, and one now lost on the Pentateuch. Hananeel's contemporary Nissim ben Jacob, of Kairawan, who corresponded with Hai Gaon of Pumbeditha as well as with Samuel the Nagid in Spain, likewise wrote on the Talmud, and is probably the author of a collection of *Me'asiyyoth* or edifying stories, besides works now lost. The activity in North Africa reacted on Spain. There the most prominent figure was that of Samuel ibn Nagdela (or Nagrela), generally known as Samuel the Nagid or head of the Jewish settlement, who died in 1055. As vizier to the Moorish king at Granada, he was not only a patron of learning, but himself a man of wide knowledge and a considerable author. Some of his poems are extant, and an Introduction to the Talmud mentioned above. In grammar he followed Hayyūj, whose pupil he was. Among others he was the patron of Solomon ibn Gabirol (*g. s.*), the poet and philosopher. To this period belong Haif al-Qūfī (the Goth?) who made a version of the Psalms in Arabic rhyme, and Bahya (more correctly Beḥai) ibn Paḡūda, dayyan at Saragossa, whose Arabic ethical treatise has always had great popularity among the Jews in its Hebrew translation, *Hikkūth ha-Ishabbōth*. He also composed liturgical poems. At the end of the 11th century Judah ibn Bal'am wrote grammatical works and commentaries (on the Pentateuch, Isaiah, &c.) in Arabic; the liturgist Isaac Gayyath (d. in 1080 at Cordova) wrote on ritual. Moses Gikatilla has been already mentioned.

The French school of the 11th century was hardly less important. Gershon ben Judah, the "Light of the Exile" (d. 1040 at Mainz), a famous Talmudist and commentator, his pupil Jacob ben Yaqar, and Moses of Narbonne, called ha-Darshan, the "Exegete," were the forerunners of the greatest of all Jewish commentators, Solomon ben Isaac (Rashi), who died at Troyes in 1105. Rashi was a pupil of Jacob ben Yaqar, and studied at Worms and Mainz. Unlike his contemporaries in Spain, he seems to have confined himself wholly to Jewish learning, and to have known nothing of Arabic or other languages except his native French. Yet no commentator is more valuable or indeed more voluminous, and for the study

of the Talmud he is even now indispensable. He commented on all the Bible and on nearly all the Talmud, has been himself the text of several super-commentaries, and has exercised great influence on Christian exegesis. The biblical commentary was translated into Latin by Breithaupt (Gotha, 1710-1714), that on the Pentateuch rather freely into German by L. Dukes (Prag, 1838, in Hebrew-German characters, with the text), and parts by others. Closely connected with Rashi, or of his school, are Joseph Qara, of Troyes (d. about 1130), the commentator, and his teacher Menahem ben Ḥelbō, Jacob ben Me'ir, called Rabbenu Tam (d. 1171), the most important of the Tosaphists (*v. sup.*), and later in the 12th century the liberal and rationalizing Joseph Bekhōr Shōr, and Samuel ben Me'ir (d. about 1174) of Ramerupt, commentator and Talmudist.

In the 12th and 13th centuries literature maintained a high level in Spain. Abraham bar Hiyya, known to Christian scholars as Abraham Judaeus (d. about 1136), was a mathematician, astronomer and philosopher much studied in the middle ages. Moses ben Ezra, of Granada (d. about 1140), wrote in Arabic a philosophical work based on Greek and Arabic as well as Jewish authorities, known by the name of the Hebrew translation as *'Arugat ha-bosem*, and the *Kiṣṣ al-Mabaqarah*, of great value for literary history. He is even better known as a poet, for his *Diwan* and the *Anaq*, and as a hymn-writer. His relative Abraham ben Ezra, generally called simply Ibn Ezra,⁴ was still more distinguished. He was born at Toledo, spent most of his life in travel, wandering even to England and to the East, and died in 1167. Yet he contrived to write his great commentary on the Pentateuch and other books of the Bible, treatises on philosophy (as the *Yesod mōra*), astronomy, mathematics, grammar (translation of Hayyūj), besides a *Diwan*. The man, however, who shares with Ibn Gabirol the first place in Jewish poetry is Judah Ha-levi, of Toledo, who died in Jerusalem about 1140. His poems, both secular and religious, contained in his *Diwan* and scattered in the liturgy, are all in Hebrew, though he employed Arabic metres. In Arabic he wrote his philosophical work, called in the Hebrew translation *Sepher ha-Kāsar*, a defence of revelation as against non-Jewish philosophy and Qaraitic doctrine. It shows considerable knowledge of Greek and Arabic thought (Avicenna). Joseph ibn Migdash (d. 1141 at Lucena), a friend of Judah Ha-levi and of Moses ben Ezra, wrote *Responsa* and *Hiddūshin* (*annotations*) on parts of the Talmud. In another sphere mention must be made of the travellers Benjamin of Tudela (d. after 1173), whose *Massa'oth* are of great value for the history and geography of his time, and (though not belonging to Spain) Pethahiah of Regensburg (d. about 1190), who wrote short notes of his journeys. Abraham ben David, of Toledo (d. about 1180), in philosophy an Aristotelian (through Avicenna) and the precursor of Maimonides, is chiefly known for his *Sepher ha-qabbalah*, written as a polemic against Karaism, but valuable for the history of tradition.

The greatest of all medieval Jewish scholars was Moses ben Maimōn (Rambam), called *Maimonides* by Christians. He was born at Cordova in 1135, fled with his parents from persecution in 1148, settled at Fez in 1160, passing ^{Maimonides} there for a Moslem, fled again to Jerusalem in 1165, and finally went to Cairo where he died in 1204. He was distinguished in his profession as a physician, and wrote a number of medical works in Arabic (including a commentary on the aphorisms of Hippocrates), all of which were translated into Hebrew, and most of them into Latin, becoming the text-books of Europe in the succeeding centuries. But his fame rests mainly on his theological works. Passing over the less important, these are the *Mōreh Nebhukhim* (so the Hebrew translation of the Arabic original), an endeavour to show philosophically the reasonableness of the faith, parts of which, translated into Latin, were studied by the Christian schoolmen, and the *Mishneh Tōrah*, also called *Yad ha-kosaqah* (τ=14, the number of the parts), a classified compendium of the Law, written in Hebrew

¹ Two different texts of it exist: (1) in the ed. pr. (Mantua, 1476); (2) ed. by Seb. Münster (Basel, 1541). There is also an early Arabic recension, but its relation to the Hebrew and to the Arabic 2 Maccabees is still obscure. See *J. Q. R.*, xi, 355 sqq. The Hebrew text was edited with a Latin translation by Breithaupt (Gotha, 1707).

² On the various recensions of the text see D. H. Müller in the *Denkschriften* of the Vienna Academy (*Phil.-hist. Cl.*, xii, 1, p. 41) and Epstein's ed. (Pressburg, 1891).

³ A fragment of such a work, probably emanating from the school of Hivī, was found by Schechter and published in *J. Q. R.*, xiii, 345 sqq.

⁴ See M. Friedländer in *Publications of the Society of Hebrew Lit.*, 1st ser. vol. i., and 2nd ser. vol. iv.

and early translated into Arabic. The latter of these, though generally accepted in the East, was much opposed in the West, especially at the time by the Talmudist Abraham ben David of Posquières (d. 1198). Maimonides also wrote an Arabic commentary on the Mishnah, soon afterwards translated into Hebrew, commentaries on parts of the Talmud (now lost), and a treatise on Logic. His breadth of view and his Aristotelianism were a stumbling-block to the orthodox, and subsequent teachers may be mostly classified as Maimonists or anti-Maimonists. Even his friend Joseph ibn 'Aqīn (d. 1226), author of a philosophical treatise in Arabic and of a commentary on the Song of Solomon, found so much difficulty in the new views that the *Mōreh Nebhākhim* was written in order to convince him. Maimonides' son Abraham (d. 1234), also a great Talmudist, wrote in Arabic *Ma'aseh Yerūshalmi*, on oaths, and *Kiṭāb al-Kifāyah*, theology. His grandson David was also an author. A very different person was Moses ben Naḥman (Ramban) or Nahmanides, who was born at Gerona in 1194 and died in Palestine about 1270. His whole tendency was as conservative as that of Maimonides was liberal, and like all conservatives he may be said to represent a lost though not necessarily a less desirable cause. Much of his life was spent in controversy, not only with Christians (in 1293 before the king of Aragon), but also with his own people and on the views of the time. His greatest work is the commentary on the Pentateuch in opposition to Maimonides and Ibn Ezra. He had a strong inclination to mysticism, but whether certain kabbalistic works are rightly attributed to him is doubtful. It is, however, not a mere coincidence that the two great kabbalistic text-books, the *Bahir* and the *Zohar* (both meaning "brightness"), appear first in the 13th century. If not due to his teaching they are at least in sympathy with it. The *Bahir*, a sort of outline of the *Zohar*, and traditionally ascribed to Neḥunya (1st century), is believed by some to be the work of Isaac the Blind ben Abraham of Posquières (d. early in the 13th century), the founder of the modern Kabbalah and the author of the names for the 10 Sephiroth. The *Zohar*, supposed to be by Simeon ben Yohai (2nd century), is now generally attributed to Moses of Leon (d. 1305), who, however, drew his material in part from earlier written or traditional sources, such as the Sopher Yeztrah. At any rate the work was immediately accepted by the kabbalists, and has formed the basis of all subsequent study of the subject. Though put into the form of a commentary on the Pentateuch, it is really an exposition of the kabbalistic view of the universe, and incidentally shows considerable acquaintance with the natural science of the time. A pupil, though not a follower of Nahmanides, was Solomon Adreth (not Addereth), of Barcelona (d. 1310), a prolific writer of Talmudic and polemical works (against the Kabbalists and Mahomedans) as well as of responsa. He was opposed by Abraham Abulafia (d. about 1291) and his pupil Joseph Gikatilla (d. about 1305), the author of numerous kabbalistic works. Solomon's pupil Bahya ben Asher, of Saragossa (d. 1340) was the author of a very popular commentary on the Pentateuch and of religious discourses entitled *Kad ha-gemah*, in both of which, unlike his teacher, he made large use of the Kabbalah. Other studies, however, were not neglected. In the first half of the 13th century, Abraham ibn Ḥasdai, a vigorous supporter of Maimonides, translated (or adapted) a large number of philosophical works from Arabic, among them being the *Sepher ha-ṯappūrah*, based on Aristotle's *de Anima*, and the *Mōraṣe Zedeq* of Ghazzali on moral philosophy, of both of which the originals are lost. Another Maimonist was Shem Ṭōbb ben Joseph Falaquera (d. after 1290), philosopher (following Averroes), poet and author of a commentary on the *Mōreh*. A curious mixture of mysticism and Aristotelianism is seen in Isaac Aboab (about 1300), whose *Menorath ha-Ma'or*, a collection of agadōth, attained great popularity and has been frequently printed and translated. Somewhat earlier in the 13th century lived Judah al-Ḥarizi, who belongs in spirit to the time of Ibn Gabirol and Judah ha-levi. He wrote numerous translations, of Galen, Aristotle, Ḥariri, Ḥunain ben Isaac and Maimonides, as well as several original works, a *Sepher 'Anaq*

in imitation of Moses ben Ezra, and treatises on grammar and medicine (*Rephāah geriyah*), but he is best known for his *Taḥkemoni*, a diwan in the style of Ḥariri's *Moqdam*.

Meanwhile the literary activity of the Jews in Spain had its effect on those of France. The fact that many of the most important works were written in Arabic, the vernacular of the Spanish Jews under the Moors, which was not understood in France, gave rise to a number of translations into Hebrew, chiefly by the family of Ibn Tibbōn (or Tabbōn). The first of them, Judah ibn Tibbōn, translated works of Bahya ibn Paquḏah, Judah ha-levi, Seadiab, Abū'lwalid and Ibn Gabirol, besides writing works of his own. He was a native of Granada, but migrated to Lunel, where he probably died about 1190. His son Samuel, who died at Marseilles about 1230, was equally prolific. He translated the *Mōreh Nebhākhim* during the life of the author, and with some help from him, so that this may be regarded as the authorized version; Maimonides' commentary on the Mishnah tractate *Pirḡe Abhōth*, and some minor works; treatises of Averroes and other Arabic authors. His original works are mostly biblical commentaries and some additional matter on the *Mōreh*. His son Moses, who died about the end of the 13th century, translated the rest of Maimonides, much of Averroes, the lesser Canon of Avicenna, Euclid's *Elements* (from the Arabic version), Ibn al-Jazzār's *Vitacium*, medical works of Ḥunain ben Isaac (Johannitius) and Razi (Rhazes), besides works of less-known Arabic authors. His original works are commentaries and perhaps a treatise on immortality. His nephew Jacob ben Makhir, of Montpellier (d. about 1304), translated Arabic scientific works, such as parts of Averroes and Ghazzali, Arabic versions from the Greek, as Euclid's *Data*, Autolycus, Menelaus (ἠὲν) and Theodosius on the Sphere, and Ptolemy's *Almagest*. He also compiled astronomical tables and a treatise on the quadrant. The great importance of these translations is that many of them were afterwards rendered into Latin,¹ thus making Arabic and, through it, Greek learning accessible to medieval Europe. Another important family about this time is that of Qimḥi (or Qamḥi). It also originated in Spain, where Joseph ben Isaac Qimḥi was born, who migrated to S. France, probably for the same reason which caused the flight of Maimonides, and died there about 1170. He wrote on grammar (*Sepher ha-galui* and *Sepher Zikkaron*), commentaries on Proverbs and the Song of Solomon, an apologetic work, *Sepher ha-berith*, and a translation of Bahya's *Hōbhōth ha-lebhābhōth*. His son Moses (d. about 1190) also wrote on grammar and some commentaries, wrongly attributed to Ibn Ezra. A younger son, David (Radaq) of Narbonne (d. 1235) is the most famous of the name. His great work, the *Mikhlah*, consists of a grammar and lexicon; his commentaries on various parts of the Bible are admirably luminous, and, in spite of his anti-Christian remarks, have been widely used by Christian theologians and largely influenced the English authorized version of the Bible. A friend of Joseph Qimḥi, Jacob ben Me'ir, known as Rabbenū Tam of Ramerupt (d. 1171), the grandson of Rashi, wrote the *Sepher ha-yashar* (ḥiddūshin and responsa) and was one of the chief Tosaphists. Of the same school were Menahem ben Simeon of Posquières, a commentator, who died about the end of the 12th century, and Moses ben Jacob of Coucy (13th century), author of the *Senag* (book of precepts, positive and negative) a very popular and valuable halakhic work. A younger contemporary of David Qimḥi was Abraham ben Isaac Bedersi (i.e. of Béziers), the poet, and some time in the 13th century lived Joseph Ezobhi of Perpignan, whose ethical poem, *Qe'arath Yōseph*, was translated by Reuchlin and later by others. Berachiah,² the compiler of the "Fox Fables" (which have much in common with the "Ysopet" of Marie de France), is generally thought to have lived in Provence in the 13th century, but according to others in England in the 12th century. In Germany, Eleazar ben Judah of Worms (d. 1238), besides being

¹ The fullest account of them is to be found in Steinachneider's *Hebräische Übersetzungen des Mittelalters* (Berlin, 1893).

² See H. Gollancz, *The Ethical Treatises of Berachya* (London, 1902).

a Talmudist, was an earnest promoter of kabbalistic studies. Isaac ben Moses (d. about 1270), who had studied in France, wrote the famous *Or Zarba* (from which he is often called), an halakhic work somewhat resembling Maimonides' *Mishneh Torah*, but more diffuse. In the course of his wanderings he settled for a time at Würzburg, where he had as a pupil Me'ir of Rothenburg (d. 1293). The latter was a prolific writer of great influence, chiefly known for his Responsa, but also for his halakhic treatises, *hiddushim* and *tosaphoth*. He also composed a number of piyyuṭim. Me'ir's pupil, Mordecai ben Hillel of Nürnberg (d. 1298), had an even greater influence through his halakhic work, usually known as the *Mordekhai*. This is a codification of halakhōth, based on all the authorities then known, some of them now lost. Owing to the fact that the material collected by Mordecai was left to his pupils to arrange, the work was current in two recensions, an Eastern (in Austria) and a Western (in Germany, France, &c.). In the East, Tanhūm ben Joseph of Jerusalem was the author of commentaries (not to be confounded with the *Midrash Tanhūmā*) on many books of the Bible, and of an extensive lexicon (*Kiṭūb al-Murshid*) to the Mishnah, all in Arabic.

With the 13th century Hebrew literature may be said to have reached the limit of its development. Later writers to a large extent used over again the materials of their predecessors, while secular works tend to be influenced by the surrounding civilization, or even are composed in the vernacular languages. From the 14th century onward only the most notable names can be mentioned. In Italy Immanuel ben Solomon, of Rome (d. about 1330), perhaps the friend and certainly the imitator of Dante, wrote his diwan, of which the last part, "Tophet ve-'Eden," is suggested by the *Divina Commedia*. In Spain Israel Israeli, of Toledo (d. 1326), was a translator and the author of an Arabic work on ritual and a commentary on *Pirqe Abhōth*. About the same time Isaac Israeli wrote his *Yesodh 'Olam* and other astronomical works which were much studied. Asher ben Jehiel, a pupil of Me'ir of Rothenburg, was the author of the popular Talmudic compendium, generally quoted as *Rabbeinu Asher*, on the lines of Alfasi, besides other halakhic works. He migrated from Germany and settled at Toledo, where he died in 1328. His son Jacob, of Toledo (d. 1340), was the author of the *Tār* (or the-four *Türim*), a most important manual of Jewish law, serving as an abridgement of the *Mishneh Torah* brought up to date. His pupil David Abudrahim, of Seville (d. after 1340), wrote a commentary on the liturgy. Both the 14th and 15th centuries in Spain were largely taken up with controversy, as by Isaac ibn Pulgar (about 1350), and Shem Ṭöbh ibn Shaprūt (about 1380), who translated St. Matthew's gospel into Hebrew. In France Jedaiah Bedersi, i.e. of Béziers (d. about 1340), wrote poems (*Beḥinath ha-'Olam*), commentaries on agada and a defence of Maimonides against Solomon Adreth. Levi ben Gershom (d. 1344), called Raḥbag, the great commentator on the Bible and Talmud, in philosophy a follower of Aristotle and Averroes, known to Christians as Leo Hebraeus, wrote also many works on halakhah, mathematics and astronomy. Joseph Kaspi, i.e. of Largentière (d. 1340), wrote a large number of treatises on grammar and philosophy (mystical), besides commentaries and piyyuṭim. In the first half of the 14th century lived the two translators Qalonymos ben David and Qalonymos ben Qalonymos, the latter of whom translated many works of Galen and Averroes, and various scientific treatises, besides writing original works, e.g. one against Kaspi, and an ethical work entitled *Eben Bōhan*. At the end of the century Isaac ben Moses, called Profiat Duran (Efodi), is chiefly known as an anti-Christian controversialist (letter to Me'ir Alguadez), but also wrote on grammar (*M'a-asah Efod*) and a commentary on the *Mōreh*. In philosophy he was an Aristotelian. About the same time in Spain controversy was very active. Ḥasdai Crescas (d. 1410) wrote against Christianity and in his *Or Adōnai* against the Aristotelianism of the Maimonists. His pupil Joseph Albo in his *'Iggarim* had the same two objects. On the side of the Maimonists was Simeon Duran (d. at Algiers 1444) in his *Megon Abhōth* and in his numerous commentaries. Shem Ṭöbh

ibn Shem Ṭöbh, the kabbalist, was a strong anti-Maimonist, as was his son Joseph of Castile (d. 1480), a commentator with kabbalistic tendencies but versed in Aristotle, Averroes and Christian doctrine. Joseph's son Shem Ṭöbh was, on the contrary, a follower of Maimonides and the Aristotelians. In other subjects, Saadyah ibn Danān, of Granada (d. at Oran after 1473), is chiefly important for his grammar and lexicon, in Arabic; Judah ibn Verga, of Seville (d. after 1480), was a mathematician and astronomer; Solomon ibn Verga, somewhat later, wrote *Shebet Yehōdah*, of doubtful value historically; Abraham Zakkuth or Zakkuto, of Salamanca (d. after 1510), astronomer, wrote the *Sepher Yuhasin*, an historical work of importance. In Italy, Obadiah Bertinoro (d. about 1500) compiled his very useful commentary on the Mishnah, based on those of Rashi and Maimonides. His account of his travels and his letters are also of great interest. Isaac Abravanel (d. 1508) wrote commentaries (not of the first rank) on the Pentateuch and Prophets and on the *Mōreh*, philosophical treatises and apologetics, such as the *Yeshev'oth Meshkhā*, all of which had considerable influence. Elijah Delmedigo, of Crete (d. 1497), a strong opponent of Kabbalah, was the author of the philosophical treatise *Beḥinath ha-dath*, but most of his work (on Averroes) was in Latin.

The introduction of printing (first dated Hebrew printed book, Rashi, Reggio, 1475) gave occasion for a number of scholarly compositors and proof-readers, some of whom were also authors, such as Jacob ben Haiyim of Tunis ^{Later} ^{writer.} (d. about 1530), proof-reader to Bomberg, chiefly known for his masoretic work in connexion with the Rabbinic Bible and his introduction to it; Elias Levita, of Venice (d. 1549), also proof-reader to Bomberg, author of the *Massoreth ha-Massoreth* and other works on grammar and lexicography; and Cornelius Adelkind, who however was not an author. In the East, Joseph Karo (Qārō) wrote his *Bēih Yōseph* (Venice, 1550), a commentary on the *Tār*, and his *Shulhan 'Arākh* (Venice, 1564) an halakhic work like the *Tār*, which is still a standard authority. The influence of non-Jewish methods is seen in the more modern tendency of Azariah dei Rossi, who was opposed by Joseph Karo. In his *Me'or 'Enayim* (Mantua, 1573) Dei Rossi endeavoured to investigate Jewish history in a scientific spirit, with the aid of non-Jewish authorities, and even criticizes Talmudic and traditional statements. Another historian living also in Italy was Joseph ben Joshua, whose *Dibhrē ha-yamim* (Venice, 1534) is a sort of history of the world, and his *'Emeq ha-bakkah* an account of Jewish troubles to the year 1575. In Germany David Gans wrote on astronomy, and also the historical work *Zemah David* (Prag, 1592). The study of Kabbalah was promoted and the practical Kabbalah founded by Isaac Luria in Palestine (d. 1572). Numerous works, representing the extreme of mysticism, were published by his pupils as the result of his teaching. Foremost among these was Haiyim Vital, author of the *'Es hayyim*, and his son Samuel, who wrote an introduction to the Kabbalah, called *Shemoneh She'arim*. To the same school belonged Moses Zakkuto, of Mantua (d. 1697), poet and kabbalist. Contemporary with Luria and also living at Safed, was Moses Cordovero (d. 1570), the kabbalist, whose chief work was the *Pardes Rimmōnim* (Cracow, 1591). In the 17th century Leon of Modena (d. 1648) wrote his *Bēih Yehōdah*, and probably *Qōl Sakhal*, against traditionalism, besides many controversial works and commentaries. Joseph Delmedigo, of Prag (d. 1655), wrote almost entirely on scientific subjects. Also connected with Prag was Yōm Ṭöbh Lipmann Heller, a voluminous author, best known for the *Tōsaphōth Yam Ṭöbh* on the Mishna (Prag, 1614; Cracow, 1643). Another important Talmudist, Shabbethai ben Me'ir, of Wilna (d. 1662), commented on the *Shulhan 'Arākh*. In the East, David Conforte (d. about 1685) wrote the historical work *Qvri ha-dōrōth* (Venice, 1746), using Jewish and other sources; Jacob ben Haiyim Zemah, kabbalist and student of Luria, wrote *Qōl be-rahamā*, a commentary on the *Zohar* and on the liturgy; Abraham Hayekini, kabbalist, chiefly remembered as a supporter of the would-be Messiah, Shabbethai Zebbi, wrote *Hōd Makārah* (Constantinople, 1655) and sermons. In the 18th century the study of the

Herod. ii. 109, and Barton, *Semitic Origins*, pp. 98-100. Probably the custom was of African origin, and came from eastern Africa along with the Semitic race. Respecting Arabia, see Doughty, *Arabia Deserta*, i. 340 foll.

It is necessary here to advert to a subject much debated during recent years, viz. the effects of Babylonian culture in western Asia on Israel and Israel's religion in early times even preceding the advent of Moses. The great influence exercised by Babylonian culture over Palestine between 2000 and 1400 B.C. (circa), which has been clearly revealed to us since 1887 by the discovery of the Tell el Amarna tablets, is now universally acknowledged. The subsequent discovery of a document written in Babylonian cuneiform at Lachish (Tell el Hesi), and more recently still of another in the excavations at Ta'annek, have established the fact beyond all dispute. The last discovery had tended to confirm the views of Fried. Delitzsch, Jeremias (*Monothetische Strömungen*) and Baentsch, that monotheistic tendencies are to be found in the midst of Babylonian polytheism. Page Renouf, in his Hibbert lectures, *Origin and Growth of Religion as illustrated by that of Ancient Egypt* (1879), p. 89 foll., pointed out this monotheistic tendency in Egyptian religion, as did de Rougé before him. Baentsch draws attention to this feature in his monograph *Allorientalischer u. israelitischer Monothetismus* (1906). This tendency, however, he, unlike the earlier conservative writers, rightly considers to have emerged out of polytheism. He ventures into a more disputable region when he penetrates into the obscure realm of the Abrahamic migration and finds in the Abrahamic traditions of Genesis the higher Canaanite monotheistic tendencies evolved out of Babylonian astral religion, and reflected in the name El'Elyon (Gen. xiv. 18, 22). Further discoveries like Sellin's find at Ta'annek may elucidate the problem. See Baudissin in *Theolog. lit. Zeitung* (27th October 1906).

3. *The Era of Moses.*—We are now on safer ground though still obscure. Moses was the first historic individuality who can be said to have welded the Israelite clans into a whole. This could never have been accomplished without unity of worship. The object of this worship was Yahweh. As we have already indicated, the document J assumes that Yahweh was worshipped by the Hebrew race from the first. On the other hand, according to P (Ex. vi. 2), God spake to Moses and said to him: "I am Yahweh. But I appeared to Abraham, Isaac and Jacob as El Shaddai and by my name Yahweh I did not make myself known to them." According to this later tradition Yahweh was unknown till the days of Moses, and under the aegis of His power the Hebrew tribes were delivered from Egyptian thraldom. The truth probably lies somewhere between these two sharply contrasted traditions. So much is clear. Yahweh now becomes the supreme deity of the Hebrew people, and an ark analogous to the Egyptian and Babylonian arks portrayed on the monuments¹ was constructed as embodiment of the *numen* of Yahweh and was borne in front of the Hebrew army when it marched to war. It was the signal victory won by Moses at the exodus against the Egyptians and in the subsequent battle at Rephidim against 'Amalék (Ex. xvii.) that consolidated the prestige of Yahweh, Israel's war-god. Indications in the Old Testament itself clearly point to the celestial or atmospheric character of the Yahweh of the Hebrews. The supposition that the name originally contained the notion of permanent or eternal being, and was derived from the verbal root signifying "to be," involves too abstract a conception to be probable, though it is based on Ex. iii. 15 (E) representing a tradition which may have prevailed in the 8th century B.C. Kautzsch, however, supports it (Hastings's *D.B.*, extra vol. "Rel. of Isr." p. 625 foll.) against the other derivations proposed by recent scholars (see JEREMIAS). That the name also prevailed as that of a god among other Semitic races (or even

¹ These sacred arks were carried in procession accompanied by symbolic figures. We note in this connexion the form of a sacred bark represented in Meyer's *Hist. of Egypt* (Oenken series), p. 257, viz. the procession carrying the sacred ark and the bark of the god Amón belonging to the reign of Rameses II. (Lepsius, *Denkmäler*, iii. 189b). See also Birch, *Egypt* (S.P.C.K.), p. 151 (ark of Khonsu); cf. Jeremias, *Das A.T. im Lichte des alten Orients* (2nd ed.), pp. 436-441.

non-Semitic) is rendered certain by the proper names Jan-bi-di (= Iku-bi'di) of Hamath in Sargon's inscriptions, Ahi-jawi (mi) in Sellin's discovered tablet at Ta'annek, to say nothing of those which have been found in the documents of Khammurabi's reign. It has generally been held that Stade's supposition has much to recommend it, that it was derived by Moses from the Kenites, and should be connected with the Sinai-Horeb region. The name Sinai suggests moon-worship and the moon-god Sin; and it also suggests Babylonian influence (cf. also Mount Nebo, which was a place-name both in Moab and in Judah, and naturally connects itself with the name of the Babylonian deity). Several indications favour the view of the connexion in the age of Moses between the Yahweh-cult at Sinai and the moon-worship of Babylonian origin to which the name Sinai points (Sin being the Babylonian moon-god). We note (a) that in the worship of Yahweh the sacred seasons of new moon and Sabbath are obviously *lunar*. Recent investigations have even been held to disclose the fact that the Sabbath coincided originally, i.e. in early pre-exilian days, with the full moon.² (b) It also accords with the name bestowed on Yahweh as "Lord of Hosts" (*sbā'āth*) or stars, which were regarded as personified beings (Job xxviii. 7) and attendants on the celestial Yahweh, constituting His retinue (1 Kings xxii. 19) which fought on high while the earthly armies of Israel, His people, contended below (Judges v. 20).

The atmospheric and celestial character which belonged from the first to the Hebrew conception of Yahweh explains to us the ease with which the idea of His universal sovereignty arose, which the Yahwistic creation account (belonging to the earlier stratum of J, Gen. ii. 4b foll.) presupposes. How this came to be overlaid by narrow local limitations of His power and province will be shown later. It is probable that Moses held the larger rather than the narrower conception of Yahweh's sphere of influence. While the ark carried with Israel's host symbolized His presence in their midst, He was also known to be present in the cloud which hovered before the host and in the lightning (*'ēsh Yahweh* or "fire of Yahweh") and the thunder (*kōl Yahweh* or "voice of Yahweh") which played around Mount Sinai. Moreover, it is hardly probable that a great leader like Moses remained unaffected by the higher conceptions tending towards monotheism which prevailed in the great empires on the Nile and on the Euphrates. In Egypt we know that Amenophis IV. came under this monotheistic movement, and attempted to suppress all other cults except that of the sun-deity, of which he

² Cf. Zimmern in *Z.D.M.G.* (1904), pp. 199 foll., 458 foll. This view is based on Dr Pinches's discovered list in which *Sapatti* is called the 15th day (*Proc. of the Soc. of Biblical Arch.*, p. 51 foll.). See A. Jeremias, *Das A.T. im Lichte des alten Orients* (2nd ed.), pp. 482-187. Marti, in his stimulating work *Religion des A.T.*, pp. 5, 72, advocates the exclusive reference of the word Sabbath to the full moon until the time of Ezekiel on the basis of Meinhold's arguments in *Sabbat u. Woche im A.T.* The latter regards Ezekiel as the organizer of the Jewish community and the originator of the sanctity of the Sabbath as a seventh day (Ezek. xlvi. 1; cf. Ezek. xx. 12, 13, 16, 20, 24, xxii. 8, 26, xxiii. 38, in which the reproaches for the profanation or neglect of the Sabbath in no way sustain Meinhold's view). In opposition to Meinhold, see Lotz in *P.R.E.* (3rd ed., art. "Sabbath," vol. xvii. pp. 286-289). To this Meinhold replies in *Z.A.T.W.* (1909), p. 81 l. Cf. also Hehn, *Siebentzahl und Sabbat*. While admitting that a special significance may have been attached in pre-exilian times to the full-moon Sabbath, and that the latter may have been specially intended in the combination "new moon and Sabbath" in the 8th-century prophets (Hos. ii. 13; Amos viii. 5; Isa. i. 13), we are not prepared to deny that the institution of a seventh-day Sabbath was an ancient pre-exilian tradition. The sacredness of the number seven is based on the seven planetary deities to whom each day of the week was respectively dedicated, i.e. was astral in origin. Cf. *C.O.T.*, i. 18 foll., and Winkler, *Religionsgeschichtlicher u. geschichtlicher Orient*, p. 39. See also K.A.T. (3rd ed.), pp. 620-626. In the Old Testament the sanctity of the number seven is clearly fundamental (e.g. in the Nil'at form *šaba'*, "to swear," in the derivative subst. for "oath," in Beer-sheba, &c.). The seventh day of rest was parallel to the seventh year of release and of the fallow field. It is, therefore, impossible to detach Ex. xxiii. 12 from Ex. xxxi. 2, xxiii. 10 foll.; cf. Ex. xxxiv. 21. We therefore hold that the law of the seventh-day Sabbath goes back to the Mosaic age. The general coincidence of the Sabbath or seventh day with the easily recognized first quarter and full moon established its sacred character as *lunar* as well as planetary.

was a devoted worshipper. We also know that between 2000 and 1400 B.C. the Babylonian language as well as Babylonian civilization and ideas spread over Palestine (as the Tell el Amarna tablets clearly testify). The ancient Babylonian psalms clearly reveal that the highest minds were moving out of polytheism to a monotheistic identification of various deities as diverse phases of one underlying essence. A remarkable Babylonian tablet discovered by Dr Pinches represents Marduk, the god of light, as identified in his person with all the chief deities of Babylonia, who are evidently regarded as his varying manifestations.¹

Through the influence of Mosaic teaching and law a definitely ethical character was ascribed to Yahweh. It was His "finger" that wrote the brief code which has come down to us in the decalogue. At first, as Erdmanns suggests, it may have consisted of only seven commands. So also Kautzsch, *ibid.* p. 634. The most strongly distinguishing feature of the code is the rigid exclusion of the worship of other gods than Yahweh. Moreover, the definitely ethical character of the religion of Yahweh established by Moses is exhibited in the strict exclusion of all sexual impurity in His worship. Unlike the Canaanite Baal, Yahweh has no female consort, and this remained throughout a distinguishing trait of the original and unadulterated Hebrew religion (see Bähring, *Beiträge*, p. 265). Indeed, Hebrew, unlike Assyrian or Phœnician, has no distinctive form for "goddess." From first to last the true religion of Yahweh was pure of sexual taint. The *kedëshim* and *kedëshôth*, the male and female priest attendants in the Baal and 'Ashtoreth shrines (cf. the *kadishim* of the temples of the Babylonian Ishtar) were foreign Canaanite elements which became imported into Hebrew worship during the period of the Hebrew settlement in Canaan.

Lastly, the earliest codes of Hebrew legislation (Ex. xxi.-xxiii.) bear the distinct impress of the high ethical character of Yahweh's requirements originally set forth by Moses. Of this tradition the Naboth incident in the time of Ahab furnishes a clear example which brings to light the contrast between the Tyrian Baal-cult, which was scarcely ethical, and of which Jezebel and Ahab were devotees, and the moral requirements of the religion of Yahweh of which Elijah was the prophet and impassioned exponent. It was this definite basis of ethical Mosaic religion to which the prophets of the 8th century appealed, and apart from which their denunciations become meaningless. To this early standard of life and practice Ephraim was faithless in the days of the prophet Hosea (see his oracles *passim*—especially chaps. i.-iv. and xiv.), and Judah in the time of Isaiah turned a deaf ear (Isa. i. 2-4, 21).

4. *Influence of Canaan.*—The entrance of Israel into Canaan marks the beginning of a new epoch in the development of Israel's religious life. For it involved a transition from the simple nomadic relations to those of the agricultural and more highly civilized Canaanite life. This subject has been recently treated with admirable clearness by Marti in his useful treatise *Die Religion des A.T.* (1906), pp. 25-41.

It is in the festivals of the annual calendar that this agricultural impress is most fully manifested. To the original nomadic *Pesah* (Passover)—sacrifice of a lamb—there was attached a distinct and agricultural festival of unleavened cakes (*masôth*) which marks the beginning of the corn harvest in the middle of the month *Abib* (the name of which points to its Canaanite and

¹ The tablet is neo-Babylonian and published by Dr Pinches in the *Transactions of the Victoria Institute*, and is cited by Professor Fried. Delitzsch in the notes appended to his first lecture *Babel u. Bibel* (5th German ed., p. 81 *ad fin.* and p. 82). On this subject of Babylonian influence over Israel see Jeremias, *Monothetische Strömungen innerhalb der babylonischen Religion*, and E. Baentsch, *Allorientalischer u. israelitischer Monothetismus*. The text and rendering of the passage are doubtful in the cuneiform letter discovered by Sellin in Ta'annek (biblical Ta'anach, near Megiddo) addressed by Abi-jawi (? Abijah) to Iahtra-wasur, in which the following remarkable phrases are read: "May the Lord of the gods protect thy life. . . . Above thy head is one who is above the towns. See now whether he will show thee good. When he reveals his face, then will they be put to shame and the victory will be complete." The letter appears to belong to about 1400 B.C. See A. Jeremias, *Das A.T. im Lichte des alten Orients* (2nd ed.), pp. 315, 316, 323. Sellin, *Ertrag der Ausgrabungen im Orient*.

agricultural origin). The close of the corn-harvest was marked by the festival *Shabbath* (weeks) or *Kôshir* (harvest) held seven weeks after *masôth*. The last and most characteristic festival of Canaanite life was that of *Asôth* or "ingathering" which after the Deuteronomic reformation (621 B.C.) had made a single sanctuary and therefore a considerable journey with a longer stay necessary, came to be called *Succoth* or booths. This was the autumn festival held at the close of September or beginning of October. It marked the close of the year's agricultural operations when the olives and grapes had been gathered [Ex. xxiii. 14-17 (E), xxxiv. 18, 22, 23 (J)]; see FEASTS, PASSOVER, PENTECOST and TABERNACLES. Another special characteristic of Israel's religion in Canaan was the considerable increase of sacrificial offerings. Animal sacrifices became much more frequent, and included not only the bloody sacrifice (*Zebah*) but also burnt offerings (*kôlil*, 'shah) whereby the whole animal was consumed (see SACRIFICE). But we have in addition to the animal sacrifices, vegetable offerings of meal, oil and cakes (*masôth*, *ashishah* and *karwan*, which last is specially connected with the 'Ashtoreth cult: Jer. vii. 18, xlv. 19), as well as the "bread of the Presence" (*lechem hâppânim*), 1 Sam. xxi. 6. Whether the primitive rite of *water-offerings* (1 Sam. vii. 6; 2 Sam. xxiii. 16) belonged to early nomadic Israel (as seems probable) it is not possible to determine with any certainty.

Again, the conception of Yahweh suffered modification. In the desert he was worshipped as an atmospheric deity, who manifested himself in thunder and lightning, whose abode was in the sky, whose sanctuary was on the mountain summit of Horeb-Sinai, and whose movable palladium was the ark of the covenant. But when the nomadic clans of Israel came to occupy the settled abodes of the agricultural Canaanites who had a stake in the soil which they cultivated, these conditions evidently reacted on their religion. Now the local Baal was the divine owner of the fertile spot where his sanctuary (*qôdash*) was marked by the upright stone pillar, the symbol of his presence, on which the blood of the slaughtered victim was smeared. To this Baal the productiveness of the soil was due. Consequently it was needful to secure his favour, and in order to gain this, gifts were made to him by the local resident population who depended on the produce of the land (see BAAL, especially *ad init.*). Now when the Hebrews succeeded to these agricultural conditions and acquired possession of the Canaanite abodes, they naturally fell into the same cycle of religious ideas and tradition. Yahweh ceased to be exclusively regarded as god of the atmosphere, worshipped in a distant mountain, Horeb-Sinai, situated in the south country (*negôb*), and moving in the clouds of heaven before the Israelites in the desert, but he came to be associated with Israel's life in Canaan. He manifested His presence either by a signal victory over Israel's foes (Josh. x. 10, 11; 1 Sam. vii. 10-12) or by a thunderstorm (1 Sam. xii. 18) or through a dream (Gen. xviii. 16 foll.; cf. 1 Kings iii. 5 foll.) at a sacred spot like Bethel. Accordingly, whenever His presence and power were displayed in places where the Canaanite Baal had been worshipped, they came to be attached to these spots. He had "put his name," i.e. power and presence (*numen*) there, and the same festivals and sacrifices which had previously been devoted to the cult of the Canaanite Baal were now annexed to the service of Yahweh, the war-god of the conquering race. The process of transference was facilitated by two potent causes: (a) Both Canaanite and Hebrew spoke a common language; (b) the name Baal is not in reality an individual proper name like Kemôsh (Chemosh), Ramman or Hadad, but is, like El (Ilu) "god," an appellative meaning "lord," "owner" or "husband." The name Baal might therefore be used for any deity such as Milk (Milcom) or Shemesh ("sun") who was the divine owner of the spot. It was simply a covering epithet, and like the word "god" could be transferred from one deity to another. In this way Yahweh came to be called the Baal or "lord" of any sacred place where the armies of Israel by their victories attained "his mighty hand and outstretched arm." (See Kautzsch in Hastings's *D.B.*, extra vol., p. 645 foll.)

Such was the path of syncretism, and it was fraught with

Such was the path of syncretism, and it was fraught with

peril to the older and purer faith. For when Yahweh gradually became Israel's local Baal he became worshipped like the old Canaanite deity, and all the sensuous accompaniments of *Kedšhōth*,¹ as well as the presence of the *ashērah* or sacred pole, became attached to his cult. But the symbol carried with it the *numen* of the goddess symbolized, and there can be little doubt that *Ashērah* came to be regarded as Yahweh's consort. In the days of Manasseh syncretism went on unchecked even in the Jerusalem temple and its precincts, and it was not till the year of Josiah's reformation (621 B.C.) that the *Kedšhīm* and *Kedšhōth* as well as the *Ashērah* were banished for ever from Yahweh's sanctuary (2 Kings xxi. 7, xxiii. 7), which their presence had profaned.

Now local worship means the differentiation of the personality worshipped in the varied local shrines, in other words *Ba'ālim* or Baals. Just as we have in Assyria an *Ishtar* of Arbela and an *Ishtar* of Nineveh (treated in *Assur-bani-pal's* (Rassam) cylinder² like two distinct deities), as we have local *Madonnas* in Roman Catholic countries, so must it have been with the cults of Yahweh in the regal period carried on in the numerous high places, Bethel, Shechem, Shiloh (till its destruction in the days of Eli) and Jerusalem. Each in turn claimed that Yahweh had placed his name (i.e. personal presence and power or *numen*) there. Each had a Yahweh of its own.

On the other hand, old deities still lurked in old spots which had been for centuries their abode. It was no easy task to establish Yahweh in permanent possession of the new lands conquered by the Hebrew settlers. The old gods were not to be at once discredited of might. Of this we have a vivid example in the episode 2 Kings xviii. 24-28. The inhabitants of Babylonla and other regions whom the Assyrian kings had settled in Ephraim after 721 B.C. (cf. Ezra iv. 10) are described as suffering from the depredations of lions, and a priest from the deported Ephraimites is sent to them to teach them the worship of Yahweh, the god of the land. Similarly in the earlier pre-exilian period of Israel's occupation of Canaanite territory the Hebrews were always subject to this tendency to worship the *old* Baal or 'Ash'toreth (the goddess who made the cattle and flocks prolific).³ A few years of drought or of bad seasons would make a Hebrew settler betake himself to the old Canaanite gods. Even in the days of Hosea the rivalry between Yahweh and the old Canaanite Baal still continued. The prophet reproaches his Ephraimite countrymen for going after their "lovers," the old local Baals who were supposed to have bestowed on them the bread, water, wool, flax and oil, and for not knowing that "it is I (Yahweh) who have bestowed on her (i.e. Israel) the corn, the new wine and the oil, and have bestowed on her silver and gold in abundance which they have wrought into a Baal image" (Hos. ii. 10).

External danger from a foreign foe, such as Midian or the Philistines, at once brought into prominence the claim and power of Yahweh, Israel's national war-god since the great days of the exodus. The religion of Yahweh (as Wellhausen said) meant patriotism, and in war-time tended to weld the participating tribes into a national unity. The book of Judges with its "monotonous tempo—religious declension, oppression, repentance, peace," to which Wellhausen⁴ refers as its ever-recurring cycle, makes us familiar with these alternating phases of action and reaction. Times of peace meant national disintegration and the lapse of Israel into the Canaanite local cults, which is interpreted by the redactor as the prophets of the 8th century would have interpreted it, viz. as defection from Yahweh. On the other hand, times of war against a foreign foe meant on the religious side the unification, partial or complete, of the

¹ The allusion in Amos ii. 7; Hos. iv. 13, 14 is sufficiently explicit; cf. Jer. ii. 20-23, iii. 6-11, v. 7, 8. The practice is prohibited in Deut. xxiii. 17.

² Column I. 15, 16, 42, 43, ii. 128, iii. 30, 31, iv. 47, 48, &c. Probably we should regard them as differentiated *hypostases*.

³ Hence the 'Ash'tārōth or offspring of flocks in Deut. vi. 13, xxviii. 18. A like function belonged to the Babylonian *Ishtar*. See "Descent of *Ishtar* to Hades," Rev. lines 6-10, where universal non-intercourse of sexes follows *Ishtar's* departure from earth to Hades.

⁴ *Proleg. Gesch. Israels* (2nd ed.), p. 240 foll., cf. p. 258.

Israelite tribes by the rallying cry "the sword of Yahweh" (Judges vii. 20). In this way 'Ophrah became the centre of the coalition under Gideon in the tribe of Manasseh. Its importance is attested by Judges viii. 22-28, and we may disregard the "snare" which the Deuteronomic writer condemns in accordance with the later canons of orthodoxy. What 'Ophrah became on a small scale in the days of Gideon, Jerusalem became on a larger scale in the days of David and his successors. It was the religious expression of the unity of Israel which the life and death struggle with the Philistines had gradually wrought out.

Despite the capture of the ark after the disastrous battle of Shiloh, Yahweh had in the end shown himself through a destructive plague superior in might to the Philistine Dagon. There are indeed abundant indications that prove that in the prevalent popular religion of the regal period monotheistic conceptions had no place. Yahweh was god only of Israel and of Israel's land. An invasion of foreign territory would bring Israel under the power of its patron-deity. The wrath with which the Israelite armies believed themselves to be visited (probably an outbreak of pestilence) when the king of Moab was reduced to his last extremity, was obviously the wrath of Chemosh the god of Moab, which the king's sacrifice of his only son had awakened against the invading army (2 Kings iii. 27). In other words, the ordinary Israelite worshipper of Yahweh was at this time far removed from monotheism, and still remained in the preliminary stage of henotheism, which regarded Yahweh as sole god of Israel and Israel's land, but at the same time recognized the existence and power of the deities of other lands and peoples. Of this we have recurring examples in pre-exilian Hebrew history. See 1 Sam. xxvi. 19; Judges xi. 23, 24; Ruth i. 16.

5. *Characteristics and Constituent Elements*.—It is only possible here to refer in briefest enumeration to the material and external objects and forms of popular Hebrew religion. These were of the simplest character. The upright stone Material object. (or *massēbah*) was the material symbol of deity on which the blood of sacrifice was smeared, and in which the *numen* of the god resided. It is probable that in some primitive sanctuaries no real distinction was made between this stone-pillar and the altar or place where the animal was slaughtered. In ordinary pre-exilian high places the custom described in the primitive compend of laws (Ex. xx: 24) would be observed. A mound of earth was raised which would serve as a platform on which the victim would be slaughtered in the presence of the concourse of spectators. In the more important shrines, as at Jerusalem or Samaria, there would be an altar of stone or of bronze. Another accompaniment of the sanctuary would be the sacred tree—most frequently a terebinth (cf. Judges ix. 37 "terebinth of soothsayers"), or it might be a palm tree (cf. "palm tree of Deborah" in Judges iv. 5), or a tamarisk ('*ēshel*), or pomegranate (*rimmōn*), as at the high place in Gibeah where Saul abode. Moreover, we have frequent references to sacred springs, as that of *Be'er-sheba*, 'Enharōd ('*ēyn-harōd*) (Judges vii. 1; cf. also Judges 19, 'En-hakkōrē ('*ēyn-hakkōrē*)). (On this subject of holy trees, holy waters and holy stones, consult article TREE-WORSHIP, and Robertson Smith's *Religion of the Semites*, 2nd ed., pp. 165-197.)

The wide prevalence of magic and soothsaying may be illustrated from the historical books of the Old Testament as well as from the pre-exilian prophets. The latter indeed tolerated the *qōsēm* (soothsayer) as they did the seer (*rō'eh*). The rhabdomancy denounced by Hosea (iv. 12) was associated with idolatry at the high places. But the arts of the necromancer were always and without exception treated as foreign to the religion of Yahweh. The necromancer of *ba'al 'ōbb'* was held to be possessed of the spirit who spoke through him with a hollow voice. Indeed both necromancer and the spirit that possessed him were sometimes identified, and the former was simply called *ōbb'*. It is probable that necromancy, like the worship of *Ashērah* and 'Ash'toreth, as well as the cult of graven images, was a Canaanite importation into Israel's religious practices. (See Marti, *Religion des A.T.*, p. 32.)

The history of the rise of the priesthood in Israel is exceedingly obscure. In the nomadic period and during the earlier years of the settlement of Israel in Canaan the head of every family could offer sacrifices. In the primitive codes, Ex. xx. 22-xxiii. 19 (E), xxxiv. 20-28 (J), we have no allusion to any separate order of men who were qualified to offer sacrifices. In Ex. xxiv. 5 (E) we read that Moses simply commissioned young men to offer sacrifices. On the other hand the *addendum* to the book of Judges, chaps. xvii., xviii. (which Budde, Moore and other critics consider to belong to the two sources of the narratives in Judges, viz. J¹ as well as E), makes reference to a Levite of Bethlehem-Judah, expressly stated in xvii. 7 as belonging to a clan of Judah. This man Micah took into his household as priest. This narrative has all the marks of primitive simplicity. There can be no reasonable doubt that the Levite here was member of a priestly tribe or order, and this view is confirmed by the discovery of what is really the same word in south Arabian inscriptions.¹ The narrative is of some value as it shows that while it was possible to appoint any one as a priest, since Micah, like David, appointed one of his own sons (xvii. 5), yet a special priest-tribe or order also existed, and Micah considered that the acquisition of one of its members was for his household a very exceptional advantage: "Now I know that Yahweh will befriend me because I have the Levite as priest."² In other words a priest who was a Levite possessed a superior professional qualification. He is paid ten shekels per annum, together with his food and clothing, and is dignified by the appellation "father" (cf. the like epithet of "mother" applied to the prophetess Deborah, Judges v. 7; see also 2 Kings ii. 12, vi. 21, xii. 14). This same narrative dwells upon the graven images, ephod and teraphim, as forming the apparatus of religious ceremonial in Micah's household. Now the ephod and teraphim are constantly mentioned together (cf. Hos. iii. 4) and were used in divination. The former was the plated image of Yahweh (cf. Judges viii. 26, 27) and the latter were ancestral images (see Marti, *op. cit.* pp. 27, 29; Harper, *Int. Comm.* "Amos and Hosea," p. 222). In other words the function of the priest was not merely sacrificial (a duty which Kautzsch unnecessarily detaches from the services which he originally rendered), nor did he merely bear the ark of the covenant and take charge of God's house; but he was also and mainly (as the Arabic name *kāhin* shows) the *soothsayer* who consulted the ephod and gave the answers required on the field of battle (see 1 Sam. and 2 Sam. *passim*) and on other occasions. This is clearly shown in the "blessing of Moses" (Deut. xxxiii. 8), where the Levite is specially associated with another apparatus of inquiry, viz. the sacred lots, *Urim* and *Thummim*. The true character of *Urim* (as expressing "aye") and *Thummim* (as expressing "nay") is shown by the reconstructed text of 1 Sam. xiv. 41 on the basis of the Septuagint. See Driver *ad loc.*

The chief and most salient characteristic of the worship of the high places was geniality. The sacrifice was a feast of social communion between the deity and his worshippers, and knit both deity and clan-members together in the bonds of a close fellowship. This genial aspect of Hebrew worship is nowhere depicted more graphically than in the old narrative (a J section—Budde's G) 1 Sam. ix. 19-24, where a day of sacrifice in the high place is described. Saul and his attendant are invited by the seer-priest Samuel into the banquetting chamber (*ishkah*) where thirty persons partake of the sacrificial meal. It was the *ḥsiph* or festival of ingathering, when the agricultural operations were brought to a close, which exhibited these genial features of Canaanite-Hebrew life most vividly. References to them abound in pre-exilic literature: Judges xxi. 21 (cf. ix. 27); Amos viii. 1 foll.; Hos. ix. 1 foll., Jer. xxxi. 4; Isa. xvi. 10 (Jer. xlvi. 33). These festivals formed the veins and arteries of ancient Hebrew

¹ *Internat. Crit. Commentary, Judges*, Introd. p. xxx., also p. 367 foll.

² *nt* "priest," *ntb* "priestess"; see Hommel, *Süd-arabische Christomathie*, p. 127; *Ancient Hebrew Tradition*, p. 278 foll.

³ Moore regards this verse as belonging to the J or older document, *op. cit.* p. 367.

clan and tribal life.⁴ Wellhausen's characterization of the Arabian *kajj*⁵ applies with equal force to the Hebrew *hgg* (festival): "They formed the rendezvous of ancient life. Here came under the protection of the peace of God the tribes and clans which otherwise lived apart from one another and only knew peace and security within their own frontiers." 1 Sam. xx. 28 foll. indicates the strong claims on personal attendance exercised on each individual member by the local clan festival at Bethlehem-Judah.

It is easy to discern from varied allusions in the Old Testament that the Canaanite impress of sensuous life clung to the autumnal vintage festivals. They became orgiastic in character and scenes of drunkenness, cf. Judges ix. 27; 1 Sam. 14-16; Isa. xxviii. 7, 8. Against this tendency the *Nasirite* order and tradition was a protest. Cf. Amos ii. 11 foll.; Judges xiii. 7, 14. As certain sanctuaries, Shiloh, Shechem, Bethel, &c., grew in importance, the priesthoods that officiated at them would acquire special prestige. Eli, the head priest at Shiloh in the early youth of Samuel, held an important position in what was then the chief religious and political centre of Ephraim; and the office passed by inheritance to the sons in ordinary cases. In the regal period the royal residence gave the priesthood of that place an exceptional position. Thus Zadok, who obtained the priestly office at Jerusalem in the reign of Solomon and was succeeded by his sons, was regarded in later days as the founder of the true and legitimate succession of the priesthood descended from Levi (Ezek. xl. 46, xliii. 19, xlv. 15; cf. 1 Kings ii. 27, 35). His descent, however, from Eleazar, the elder brother of Aaron, can only be regarded as the later artificial construction of the post-exilic chronicler (1 Chron. vi. 4-15, 50-53, xxiv. 1 foll.), who was controlled by the traditions which prevailed in the 4th century B.C. and after.

6. *The Prophets*.—The rise of the order of prophets, who gradually emerged out of and became distinct from the old Hebrew "seer" or augur (1 Sam. ix. 9),⁶ marks a new epoch in the religious development of the Hebrews. Over the successive stages of this growth we pass lightly (see ΠΡΟΦΗΤΑΙ). The life-and-death struggle between Israel and the Philistines in the reign of Saul called forth under Samuel's leadership a new order of "men of God," who were called "prophets" or divinely inspired speakers.⁷ These men were distributed in various settlements, and their exercises were usually of an ecstatic character. The closest modern analogy would be the orders of dervishes in Islām. Probably there was little externally to distinguish the prophet of Yahweh in the days of Samuel from the Canaanite-Phoenician prophets of Baal and Asherah (1 Kings xviii. 19, 26, 28), for the practices of both were ecstatic and orgiastic (cf. 1 Sam. x. 5 foll., xviii. 10, xix. 23 foll.). The special quality which distinguished these prophetic guilds or companies was an intense patriotism combined with enthusiastic devotion to the cause of Yahweh. This necessarily involved in that primitive age an extreme jealousy of foreign importations or innovations in ritual. It is obvious from numerous passages that these prophetic guilds recognized the superior position and leadership of Samuel, or of any other distinguished prophet such as Elijah or Elisha. Thus 1 Sam. xix. 20, 23 et seq. show that Samuel was regarded as head of the prophetic settlement at Naioth. With reference to Elijah and Elisha, see 2 Kings ii. 3, 5, 15, iv. 1, 38 et seq., vi. 1 et seq. There cannot be any doubt that

⁴ Similarly in ancient Greece. See the instructive passage in Aristotle, *Nic. Eth.* viii. 9 (4, 5), on the relation of Greek sacrifices and festivals to *κωμωδία* and politics: *αὐτὰ γὰρ ἀρχαῖαι θύσια καὶ στυβόλι φαινομένη γέγονεθαι μετὰ τὰς εἰς τὸν κατὰ τὸν ἀρχαίου οἶον ἀναρχίας*; cf. Grote on Pan-Hellenic festivals, *History of Greece*, vol. iii. ch. 28.

⁵ Wellhausen, *Reste arabischen Heidentums* (2nd ed.), p. 89.

⁶ Though this be an interpolated gloss (Thenius, Budde), it states a significant truth as Kautzsch clearly shows, *op. cit.* p. 672. In Micah iii. 7 the *hōzek* is mentioned in a sense analogous to the *hōzek* or "seer," and coupled with the *gōssim* or "soothsayer," viz. as spurious; cf. Deut. xviii. 10.

⁷ No better derivation is forthcoming of the word *nabhi*, "prophet," than that it is a Kātil form of the root *nabā* = *Assyr. nabā*, "speak."

such enthusiastic devotees of Yahweh, in days when religion meant patriotism, did much to keep alive the flame of Israel's hope and courage in the dark period of national disaster. It is significant that Saul in his last unavailing struggle against the overwhelming forces of the Philistines sought through the medium of a sorceress for an interview with the deceased prophet Samuel. It was the advice of Elisha that rescued the armies of Jehoram and Jehoshaphat in their war against Moab when they were involved in the waterless wastes that surrounded them (2 Kings iii. 14 foll.). We again find Elisha intervening with effect on behalf of Israel in the wars against Syria, so that his fame spread to Syria itself (2 Kings v.-viii. 7 foll.). Lastly it was the fiery counsels of the dying prophet, accompanied by the acted magic of the arrow shot through the open window, and also of the thrice smitten floor, that gave nerve and courage to Joash, king of Israel, when the armies of Syria pressed heavily on the northern kingdom (2 Kings xiii. 14-19).

We see that the prophet had now definitely emerged from the old position of "seer." Prophetic personality now moved in a larger sphere than that of divination, important though that function be in the social life of the ancient state¹ as instrumental in declaring the will of the deity when any enterprise was on foot. For the prophet's function became in an increasing degree a function of *mind*, and not merely of traditional routine or mechanical technique, like that of the diviner with his arrows or his lots which he cast in the presence of the ephod or plated Yahweh image. The new name *nabhi'* became necessary to express this function of more exalted significance, in which human personality played its larger rôle. Even as early as the time of David it would seem that Nathan assumed this more developed function as interpreter of Yahweh's righteous will to David. But both in 2 Sam. xii. 1-15 as well as in 2 Sam. vii. we have sections which are evidently coloured by the conceptions of a later time. We stand on safer ground when we come to Elijah's bold intervention on behalf of righteousness when he declared in the name of Yahweh the divine judgment on Ahab and his house for the judicial murder of Naboth. We here observe a great advance in the vocation of the prophet. He becomes the interpreter and vindicator of divine justice, the vocal exponent of a nation's conscience. For Elijah was in this case obviously no originator or innovator. He represents the old ethical Mosaicism, which had not disappeared from the national consciousness, but still remained as the moral pre-supposition on which the prophets of the following century based their appeals and denunciations. It is highly significant that Elijah, when driven from the northern kingdom by the threats of the Tyrian Jezebel, retreats to the old sanctuary at Horeb, whence Moses derived his inspiration and his Tôrah.

We have hitherto dealt with isolated examples of propheticism and its rare and distinguished personalities. The ordinary Hebrew *nabhi'* still remained not the reflective visionary, stirred at times by music into strange raptures (2 Kings iii. 15), but the ecstatic and orgiastic dervish who was *meshuggah* or "frenzied," a term which was constantly applied to him from the days of Elisha to those of Jeremiah (2 Kings ix. 11; in Hos. ix. 7 and Jer. xxix. 26 it is regarded as a term of reproach). It is only in rare instances that some exalted personality is raised to a higher level. Of this we have an interesting example in the vivid episode that preceded the battle of Ramoth-Gilead described in 1 Kings xxii., when Micaiah appears as the true prophet of Yahweh, who in his rare independence stands in sharp contrast with the conventional court prophets, who prophesied then, as their descendants prophesied more than two centuries later, smooth things.

It is not, however, till the 8th century that prophecy attained its highest level as the interpreter of God's ways to men. This is due to the fact that it for the first time unfolded the true character of Yahweh, implicit in the old Mosaic religion and submerged in the subsequent centuries of Israel's life in Canaan, but now at length made clear and explicit to the mind of the

¹ In Isa. iii. 2 the soothsayer is placed on a level with the judge, prophet and elder.

nation. It became now detached from the limitations of nationalism and local association with which it had been hitherto circumscribed.

Even Elisha, the greatest prophet of the 9th century, had remained within these national limitations which characterized the popular conceptions of Yahweh. Yahweh was Israel's war-god. His power was asserted in and from Canaanite soil. If Naaman was to be healed, it could only be in a Palestinian river, and two mules' load of earth would be the only permanent guarantee of Yahweh's effective blessing on the Syrian general in his Syrian home.

That larger conceptions prevailed in some of the loftier minds of Israel, and may be held to have existed even as far back as the age of Moses, is a fact which the Yahwistic cosmogony in Gen. ii. 4b-g (which may have been composed in the 9th century B.C.) clearly suggests, and it is strongly sustained by the overwhelming evidence of the powerful influence of Babylonian culture in the Palestinian region during the centuries 2000-1400 B.C.² Probably in our modern construction of ancient Hebrew history sufficient consideration has not been given to the inevitable coexistence of different types and planes of thought, each evolved from earlier and more primordial forms. In other words we have to deal not with *one* evolution but with *evolutions*.

The existence of the purer and larger conception of Yahweh's character and power before the advent of Amos indicates that the transition from the past was not so sudden as Wellhausen's graphic portrayal in the 9th edition of this *Encyclopaedia* (art. ISRAEL) would have led us to suppose. There were pre-existent ideas upon which that prophet's epoch-making message was based. Yet this consideration should in no way obscure the fact that the prophet lived and worked in the all-pervading atmosphere of the popular syncretic Yahweh religion, intensely national and local in its character. In Wellhausen's words, each petty state "revolved on its own axis" of social-religious life till the armies of Tiglath-Pileser III. broke up the security within the Canaanite borders. According to the dominating popular conception, the destruction of the national power by a foreign army meant the overthrow of the prestige of the national deity by the foreign nation's god. If Assyria finally overthrew Israel and carried off Yahweh's shrine, Assur (Asûr), the tutelary deity of Assyria, was mightier than Yahweh. This was precisely what was happening among the northern states, and Amos foresaw that this might eventually be Israel's doom. Rabahakch's appeal to the besieged inhabitants of Jerusalem was based on these same considerations. He argued from past history that

² Kautzsch, in his profoundly learned article on the "Religion of Israel," to which frequent reference has been made, exhibits (pp. 669-671) an excess of scepticism, in our opinion, towards the views propounded by Gunkel in 1895 (*Schöpfung und Chaos*) respecting the intimate connexion between the early Hebrew cosmogonic ideas and those of Babylonia. Stade indeed (*Z.A.T.W.*, 1902, pp. 176-178) maintained that the conception of Yahweh as creator of the world could not have arisen till after the middle of the 8th century as the result of prophetic teaching, and that it was not till the time of Ezekiel that Babylonian conceptions entered the world of Hebrew thought in any fulness. Such a theory appears to ignore the remarkable results of archaeology since 1887. At that time Stade's position might have appeared reasonable. It was the conclusion to which Wellhausen's brilliant literary analysis, when not supplemented by the discoveries at Tell el-Amarna and Tell el-Hesi, appeared to many scholars (by no means all) inevitably to conduct us. But the years 1887 to 1891 opened many eyes to the fact that the Hebrews lived their life on the great highways of intercourse between Egypt on the one hand, and Babylonia, Assyria and the N. Palestinian states on the other, and that they could scarcely have escaped the all-pervading Babylonian influences of 2000-1400 B.C. It is now becoming clearer every day, especially since the discovery of the laws of Hammurabi, that, if we are to think sanely about Hebrew history before as well as after the exile, we can only think of Israel as part of the great complex of Semitic and especially Canaanite humanity that lived its life in western Asia between 2000 and 600 B.C.; and that while the Hebrew race maintained by the aid of propheticism its own individual and exalted place, it was not less susceptible *then*, than it has been since, to the moulding influences of great adjacent civilizations and ideas. Cf. C. H. W. Johns in *Interpreter*, pp. 300-304 (in April 1906), on propheticism in Babylonia.

Yahweh would be powerless in the presence of Ashur (2 Kings xviii. 33-35).

This problem of religion was solved by Amos and by the prophets who succeeded him through a more exalted conception of Yahweh and His sphere of working, which tended to detach Him from His limited realm as a national deity. Amos exhibited Him to his countrymen as lord of the universe, who made the seven stars and Orion and turns the deep midnight darkness into morning. He calls to the waters of the sea and pours them on the earth's surface (chap. v. 8). Such a universal God of the world would hardly make Israel His exclusive concern. Thus He not only brought the Israelites out of Egypt, but also the Philistines from Caphtor and the Syrians from Kir (ix. 7). But Amos went beyond this. Yahweh was not only the lord of the universe and possessor of sovereign power. The prophet also emphasized with passionate earnestness that Yahweh was a God whose character was righteous, and God's demand upon His people Israel was not for sacrifices but for *righteous conduct*. Sacrifice, as this prophet, like his successor Jeremiah, insisted (Amos v. 25; cf. Jer. vii. 22) played no part in Mosaic religion. In words which evidently impressed his younger contemporary Isaiah (cf. esp. Is. chap. i. 11-17), Amos denounced the non-ethical ceremonial formalism of his countrymen which then prevailed (chap. v. 21 foll.)—

"I hate, I condemn your festivals and in your feasts I delight not; for when you offer me your burnt-offerings and gifts, I do not regard them with favour and your fatted peace-offerings I will not look at. Take away from me the clamour of your songs; and the music of your viols I will not hear. But let judgment roll down like waters and justice like a perennial brook."

In the younger contemporary prophet of Ephraim, Hosea, the stress is laid on the relation of love (*hesed*) between Yahweh, the divine husband, and Israel, the faithless spouse. Israel's faithlessness is shown in idolatry and the prevailing corruption of the high places in which the old Canaanite Baal was worshipped instead of Yahweh. It is shown, moreover, in foreign alliances. Compacts with a powerful foreign state, under whose aegis Israel was glad to shelter, involved covenants sealed by sacrificial rites in which the deity or deities of the foreign state were involved as well as Yahweh, the god of the weaker vassal-state. And so Yahweh's honour was compromised. While these aspects of Israel's relation to Yahweh are emphasized by the Ephraimite prophet, the larger conceptions of Yahweh's character as universal Lord and the God of righteousness, whose government of the world is ethical, emphasized by the prophet of Tekoah, are scarcely presented.

In Isaiah both aspects—divine universal sovereignty and justice, taught by Amos, and divine loving-kindness to Israel and God's claims on His people's allegiance, taught by Hosea—are fully expressed. Yahweh's relation of love to Israel is exhibited under the purer symbol of fatherhood (Isa. i. 2-4), a conception which was as ancient and familiar as that of husband, though perhaps the latter recurs more frequently in prophecy (Isa. i. 21; Ezek. xvi. &c.). Even more insistently does Isaiah present the great truth of God's universal sovereignty. As with his elder contemporary, the foreign peoples—(but in Isaiah's oracles Assyria and Egypt as well as the Palestinian races)—come within his survey. The "fullness of the earth" is Yahweh's glory (vi. 3) and the nations of the earth are the instruments of His irresistible and righteous will. Assyria is the "bee" and Egypt the "fly" for which Yahweh hisses. Assyria is the "hired razor" (Isa. vii. 18, 19), or the "rod of His wrath," for the chastisement of Israel (x. 5). But the instrument unduly exalts itself, and Assyria itself shall suffer humiliation at the hands of the world's divine sovereign (x. 7-15).

And so the old limitations of Israel's popular religion,—the same limitations that encumbered also the religions of all the neighbouring races that succumbed in turn to Assyria's invincible progress,—now began to disappear. Therefore, while every other religion which was purely national was extinguished in the nation's overthrow, the religion of Israel survived even amid exile and dispersion. For Amos and Isaiah were able to

single out those loftier spiritual and ethical elements which lay implicit in Mosaism and to lift them into their due place of prominence. National *sacra* and the ceremonial requirements were made to assume a secondary rôle or were even ignored.¹ The centre of gravity in Hebrew religion was shifted from ceremonial observance and local *sacra* to righteous conduct. Religion and righteousness were henceforth welded into an indissoluble whole. The religion of Yahweh was no longer to rest upon the narrow perishable basis of locality and national *sacra*, but on the broad adamant foundations of a universal divine sovereignty over all mankind and of righteousness as the essential element in the character of Yahweh and in his claims on man. This was the "corner-stone of precious solid foundation": "I will make judgment the measuring-line and righteousness the plummet" (Isa. xlviii. 16, 17). The religion of the Hebrew race—properly the Jews—now enters on a new stage, for it should be observed that it was Amos, Isaiah and Micah—prophets of Judah—who laid the actual foundations. The latter half of the 8th century, which witnessed a rapid succession of reigns in the northern kingdom accompanied by dismemberment of its territory and final overthrow, witnessed also the humiliating vassalage and religious decline of the kingdom of Judah. Unlike Amos and Micah, Isaiah was not only the prophet of denunciation but also the prophet of hope. Though Yahweh's chastisements on Ephraim and Judah would continue to fall till scarcely a remnant was left (Isa. vi. 13, LXX.), yet all was not to be lost. A remnant of the people was to return, i.e. be converted to Yahweh. The name given to an infant child—Immanuel—was to become the mystic symbol of a growing hope. God's presence was to abide in Jerusalem, and, as the century drew near its close, "Immanuel" became the watchword and talisman of a strong faith that God would never permit Jerusalem to be captured by the Assyrians. In fact it is not improbable that the words of consolation uttered by the prophet (Isa. viii. 9-10) in the dark days of Ahas (735-734 B.C.) were among the oracles which God commanded Isaiah "to seal up among his disciples" (verse 16), and that they were quoted once more with effect as the armies of Sennacherib closed around Jerusalem. The talismanic name Immanuel became the nucleus out of which the later Messianic prophecies of Isaiah grew. To this age alone can we probably assign Isa. ix. 1-7, xi. 1-9, xxxiii. 1-3. The hopes expressed in the word Immanuel, "God with us," were to become embodied in a personality of the royal seed of David, an ideal righteous ruler who was to bring peace to the war-distraught realm. Thus Isaiah became in that troubled age the true founder of *Messianic* prophecy. The strange contrast between the succession of dynasties and kings cut off by assassination in the northern kingdom, ending in the tragic overthrow of 721 B.C., and the persistent succession through three centuries of the seed of David on the throne of Jerusalem, as well as the marvellous escape of Jerusalem in 701 B.C. from the fate of Samaria, must have invested the seed of David in the eyes of all thoughtful observers with a mysterious and divine significance. The Messianic prophecies of Isaiah, the prophet of faith and deliverance, were destined to reverberate through all subsequent centuries. We hear the echoes in Jeremiah and Ezekiel and lastly in Haggai in ever feebler tones, and they were destined to reawaken in the Psalter (Pss. ii. and lxxii.), in the psalms of Solomon and in the days of Christ. See *Messiah* (and also the article "Messian" in Hastings's *Dict. of Christ and the Gospels*).

The next notable contribution to the permanent growth of Hebrew prophetic religion was made about a century after the lifetime of Isaiah by Jeremiah and Ezekiel. The reaction into idolatry and Babylonian star worship in the long reign of Manasseh synchronized and was connected with vassalage

¹ There is some danger in too strictly construing the language of the prophets and also the psalmists. It is not to be supposed that either Amos or Isaiah would have countenanced the total suppression of all sacrificial observance. It was the existing ceremonial observance divorced from the ethical piety that they denounced. The speech of prophecy is poetical and rhetorical, not strictly defined and logical like that of a modern essayist. See Moore in *Encyc. Bibl.*, "Sacrifice," col. 4222.

to Assyria, while the reformation in the reign of Josiah (621 B.C.) is conversely associated with the decay of Assyrian power after the death of Assur-bani-pal. That reformation failed to effect its purifying mission. The hurt of the daughter of God's people was but lightly healed (Jer. vi. 14, 15; cf. viii. 11, 12). No possibility of recovery now remained to the diseased Hebrew state. The outlook appeared indeed far darker to Jeremiah than it seemed more than a century before to Isaiah in the evil days of Jotham and Ahas, "when the whole head was sick and the whole heart faint" (Isa. i. 5). Jeremiah foresaw that there was now no possibility of recovery. The Hebrew state was doomed and even its temple was to be destroyed. This involved an entire reconstruction of theological ideas which went beyond even the reconstructions of Amos and Isaiah. In the old religion the race or clan was the unit of religion as well as of social life. Properly speaking, the individual was related to God only through the externalities of the clan or tribal life, its common temple and its common *sacra*. But now that these external bases of the old religion were to be swept away, a reconstruction of religious ideas became necessary. For the external supports which had vanished Jeremiah substituted a basis which was *internal, personal and spiritual* (i.e. *ethical*). In place of the old covenant based on external observance, which had been violated, there was to be a *new covenant* which was to consist not in outward prescription, but in the law which God would place *in the heart* (Jer. xxxi. 30-33). This was to take place by an act of divine grace (Jer. xxiv. 5 foll.): "I will give them an heart to know me that I am the Lord" (verse 7). Ezekiel, who borrowed both Jeremiah's language and ideas, expresses the same thought in the well-known words that Yahweh would give the people instead of a heart of stone a heart of flesh (Ezek. xi. 19, 20, xx. 40 foll., xxvii. 25-27), and would shame them by his loving-kindness into repentance, and there "shall ye remember your ways and all your doings wherein ye have been defiled and ye shall loathe yourselves in your own sight" (xx. 43).

Personal religion now became an important element in Hebrew piety and upon this there logically followed the idea of *personal responsibility*. The solidarity of race or family was expressed in the old tradition reflected in Deut. v. 9, 10, that God would visit the sins of the fathers upon the children, and it lived on in later Judaism under exaggerated forms. The hopes of the individual Jew were based on the piety of holy ancestors. "We have Abraham as our father." But *Ezekiel* expressed the strong reaction which had set in against this belief in its older forms. He denies that the individual ever dies for the sins of the father. "The soul that sinneth, it (the pronoun emphasized in the original) shall die" (Ezek. xviii. 4). Neither Noah, Daniel nor Job could have rescued by his righteousness any but his own soul (xiv. 14). And as a further consequence *individual freedom* is strongly asserted. It is possible for every sinner to turn to God and escape punishment, and conversely for a righteous man to backslide and fall. In the presence of these awful truths which Ezekiel preached of individual freedom and of impending judgment, the prophet is weighted with a heavy responsibility. It is his duty to warn every individual, for no sinner is to be punished without warning (Ezek. iii. 16 foll. xxxiii.).

The closing years of the Judaean kingdom and the final destruction of the temple (586 B.C.) shattered the Messianic ideals cherished in the evening of Isaiah's lifetime and again in the opening years of the reign of Josiah. The untimely death of that monarch upon the battlefield of Megiddo (608 B.C.), followed by the inglorious reigns of the kings who succeeded him, who became puppets in turn of Egypt or of Babylonia, silenced for a while the Messianic hopes for a future king or line of kings of Davidic lineage who would rule a renovated kingdom in righteousness and peace. Even in the darkness of the exile period hopes did not die. Yet they no longer remained the same. In the Deutero-Isaiah (chaps. xl.-lv.) we have no longer a Jewish but a *foreign* messiah. The onward progress of the Persian Cyrus and his anticipated conquest of Babylonia marked

him out as Yahweh's anointed instrument for effecting the deliverance of exiled Israel and their restoration to their old home and city (Isa. xli. 2, xlv. 24, xlv.). This was, however, but a subsidiary issue and possesses no permanent spiritual significance. Of far more vital importance is the conception of Israel as God's *suffering servant*. This is not the place to enter into the prolonged controversy as to the real significance of this term, whether it signifies the nation Israel or the righteous community only, or finally an idealized prophetic individual who, like the prophet Jeremiah, was destined to suffer for the well-being of his people. Duhm, in his epoch-making commentary, distinguishes on the grounds of metre and contents the *few servant-passages*, in the last of which (lii. 13-14, 12) the ideal suffering servant of Yahweh is portrayed most definitely as an individual. In the "servant-passages" he is innocent, while in the rest of the Deutero-Isaiah he appears as by no means faultless, and the personal traits are not prominent. These views of Duhm, in which a severe distinction is thus drawn between the representation of Yahweh's servant in the servant-passages, and that which meets us in the rest of the Deutero-Isaiah, have been challenged by a succession of critics.¹ It is only necessary for us to take note of the ideal in its general features. It probably arose from the fact that the calamities from which Israel had suffered both before and during the exile had drawn the reflective minds of the race to the contemplation of the problem of suffering. The "servant of Yahweh" presents one aspect of the problem, and its attempted solution, the book of Job another, while in the Psalms, e.g. Psa. xxii., xlii.-xliii., lxxiii., lxxvii., other phases of the problem are presented. In the Deutero-Isaiah the meaning of Israel's sufferings is exhibited as vicarious. Israel is suffering for a great end. He suffers, is despised, rejected, chastened and afflicted that others may be blessed and be at peace through his chastisement. This noble conception of Israel's great destiny is conveyed in Isa. xlix. 6, in words which may be regarded as perhaps the noblest utterance in Hebrew prophecy: "To establish the tribes of Jacob and bring back the preserved of Israel is less important than being my servant. Yea, I will make you a light to the *Gentiles* that my salvation may be unto the end of the earth." This passage, which belongs to the second of the brief "servant-songs," sets the mission of Israel in its true relation to the world. It is the necessary corollary to the teaching of Amos, that God is the righteous lord of all the world. If Jerusalem has been chosen as His sanctuary and Israel as His own people, it is only that Israel may diffuse God's blessings in the world even at the cost of Israel's own humiliation, exile and dispersion.

The Deutero-Isaiah closes a great prophetic succession, which begins with Amos, continues in Isaiah in even greater splendour with the added elements of hope and Messianic expectation, and receives further accession in Jeremiah with his special teaching on inward spiritual and personal religion which constituted the new covenant of divine grace. Finally the Deutero-Isaiah conveyed to captive Israel the message of Yahweh's unceasing love and care, and the certainty of their return to Judaea and the restoration of the national prosperity which Ezekiel had already announced in the earlier period of the exile. To this is united the noble ideal of the suffering servant, which serves both as a contribution to the great problem of suffering as purifying and vicarious and as the interpretation to the mind of the nation itself of that nation's true function in the future, a lesson which the actual future showed that Israel was slow to receive. Nowhere in the Old Testament does the doctrine taught by Amos of Yahweh's universal power and sovereignty

¹ Viz. Budde in *Die sogenannten Ebed-Jahweh Lieder u. die Bedeutung des Knechtes Jahwehs in Jes. xl.-lv.* (Giessen, 1900); Karl Martj in his well-known commentary on Isaiah, and F. Giesebrecht, *Der Knecht Jahwehs des Deuterisajahs*. The special servant-songs which Duhm asserts can be readily detached from the texture of the Deutero-Isaiah without disturbance to its integrity are Isa. xlii. 1-4, xlix. 1-6, i. 4-9, liii. 13-14, 12.

² We have here followed Dillmann's construction of a difficult passage which Duhm attempts to simplify by omission of the complicating clause without altering the general sense.

receive ampler and more splendid exposition than in the great lyrical passages of chap. xl. It marks the highest point to which the Hebrew race attained in its progress from henotheism to monotheism. Here again we see the wholesome influences of the exile. The Jew had passed from the narrow confines of his homeland into a wider world, and this larger vision of human life reacted on the prophet's theology. This closes the evolution of Hebrew propheticism. What immediately follows is on a descending slope with some striking exceptions, e.g. the book of Job and the book of Jonah.

7. Deuteronomic Legalism.—The book of Deuteronomy was the product of prophetic teaching operating on traditional custom, which was represented in its essential features by the two codes of legislation contained in Ex. xx. 24-xxiii. 19 (E) and Ex. xxxiv. 10-26 (J), but had also become tainted and corrupted by centuries of Canaanite influence and practice which especially infected the cult of the *high places*. The existence of "high places" is presupposed in those two ancient codes and is also presumed in the narratives of the documents E and J which contain them. But the prevalence of the worship of "other gods" and of graven images in these "high places," and the moral debasement of life which accompanied these cults, made it clear that the "high places" were sources of grave injury to Israel's social life. In all probability the reformation instituted in the reign of Hezekiah, to which 2 Kings xviii. 4 (cf. verse 23) refers, was only partial. It is hardly possible that all the high places were suppressed. The idolatrous reaction in the reign of Manasseh appears to have restored all the evils of the past and added to them. Another and more drastic reform than that which had been previously initiated (probably at the instigation of Isaiah and Micah) now became necessary to save the state. It is universally held by critics that our present book of Deuteronomy (certainly chaps. xii.-xxvi.) is closely connected with the reformation in the reign of Josiah. It is quite clear that many provisions in the old codes of J and E expanded lie at the basis of the book of Deuteronomy. But new features were added. We note for the first time definite regulations respecting Passover and the close union of that celebration with *Mazzoth* or "unleavened bread." We note the laws respecting the clean and unclean animals (certainly based on ancient custom). Moreover, the prohibitions are strengthened and multiplied. In addition to the bare interdict of the sorceress (Ex. xxii. 18), of stone pillars to the Canaanite Baal, of the Asherah-pole, molten images and the worship of other gods than Yahweh (Ex. xxxiv. 13-17), we now have the strict prohibition of *any employment whatever* of the stone-symbol (*Mazzebah*), and of all forms of sorcery, soothsaying and necromancy (Deut. xviii. 10, 11. Respecting the stone-pillar see xvi. 22). But of much more far-reaching importance was the *law of the central sanctuary* which constantly meets us in Deuteronomy in the reference to "the place (i.e. Jerusalem) which Yahweh your God shall choose out of all your tribes to put His name there" (xii. 5, xvi. 5, 11, 16, xxvi. 2). There alone all offerings of any kind were to be presented (xii. 6, 7, xvi. 7). By this positive enactment all the high places outside the one sanctuary in Jerusalem became illegitimate. A further consequence directly followed from the limitation as to sanctuary, viz. limitation as to the officiating ministers of the sanctuary. In the "book of the covenant" (Ex. xx. 22-xxiii. 19), as we have already seen, and in the general practice of the regal period, there was no limitation as to the priesthood, but a definite order of priesthood, viz. Levites, existed, to whom a higher professional prestige belonged. As it was impossible to find a place for the officiating priests of the high places, non-levitical as well as levitical, in the single sanctuary, it became necessary to restrict the functions of sacrifice to the Levites only as well as to the existing official priesthood of the Jerusalem temple (see PRIEST). Doubtless such a reform met with strong resistance from the disestablished and vested interests, but it was firmly supported by royal influence and by the Jerusalem priesthood as well as by the true prophets of Yahweh who had protested against the idolatrous usages and corruptions of the high places.

The strong impress of Hebrew prophecy is to be found in the deeply marked ethical spirit of the Deuteronomic legislation. Love to God and love to man is stamped on a large number of its provisions. Love to God is emphasized in Deut. vi. 5, while love to man meets us in the constant reference to the fatherless and the widow (cf. especially Deut. xvi.). This note of philanthropy is frequently found as a mitigating element (e.g. in the laws respecting slavery and war) that subdues or even removes the harshness of earlier laws or usages. It should be noted, however, that the spirit of brotherly love was confined within national barriers. It did not operate as a rule beyond the limits of race.

The book of Deuteronomy, in conjunction with the reformation of Josiah's reign (which synchronizes with the rapid decline of Assyria and the reviving prestige of Yahweh), appeared to mark the triumph of the great prophetic movement. It became at once a codified standard of purer religious life and ultimately served as a beacon of light for the future. But there was shadow as well as light. We note (a) that though the book of Deuteronomy bears the prophetic impress, the priestly impress is perhaps more marked. The writer "evinces a warm regard for the priestly tribe; he guards its privileges (xviii. 1-8), demands obedience for its decisions (xxiv. 8; cf. xvii. 10-12) and earnestly commends its members to the Israelites' benevolence (xii. 18-19, xiv. 27-29, &c.)."¹ (b) In many passages Jewish particularism is painfully manifest. Yahweh's care for other peoples does not appear. The flesh of a dead (unslaughtered) beast is not to be eaten, but it may be given to the "stranger within the gates" (Deut. xiv. 21).² (c) Prophetic religion was a religion of the spirit which came to the messenger (Isa. lxi. 1) and expressed itself as a word of instruction of Yahweh (*divrah*); see Isa. i. 10. Now when the Hebrew religion was reduced to written form it began to be a book-religion, and since the book consisted of fixed rules and enactments, religion began to acquire a stereotyped character. It will be seen in the sequel that this was destined to be the growing tendency of Jewish religious life—to conform itself to prescribed rules. In other words, it became *legalism*. (d) Lastly, the old genial life of the high places, in which the "new moon" or Sabbath or the annual festival was a sacrificial feast of communion, in which the members of the local community or clan enjoyed fellowship with one another—all this picturesque life ceased to be. And though there was positive gain in the removal of idolatrous and corrupt modes of worship, there was also positive loss in the disappearance of this old genial phase of Hebrew social life and worship. It involved a vast difference to many a Judaean village when the festival pilgrimage was no longer made to the familiar local sanctuary with its hoary associations of ancient heroic or patriarchal story, but to a distant and comparatively unfamiliar city with its stately shrine and priesthood.

8. Ezekiel's System.—Ezekiel was the successor of Jeremiah and inherited his conceptions. But though the younger prophet adopted the ideas respecting personal religion and individual responsibility from the elder, the characters of the two men were very different. Jeremiah, when he foretold the destruction of the external state and temple ritual, found no resource save in a reconstruction that was interreal and spiritual. In this he was true to his prophetic impulse and genius. But Ezekiel was, as Wellhausen well describes him, "a priest in prophet's mantle." While Jeremiah's tendency was spiritual and ideal, Ezekiel's was constructive and practical. He was the first to foretell with clearness the return of his people from captivity foreshadowed by Jeremiah, and he set himself the task even in

¹ Thus in comparison with the "book of the covenant," Deuteronomy adds the stipulation in reference to the release of the slave; that his master was to provide him liberally from his flocks, his corn and his wine (Deut. xv. 13, 14). See Hastings's *D.B.*, arts. "Servant," "Slave," p. 464, where other examples may be found. In war fruit-trees are to be spared (Deut. xx. 19 foll.), whereas the old universal practice is the barbarous custom Elisha commended (2 Kings iii. 19) of ruthlessly destroying them.

² Driver, *Internat. Commentary on Deuteronomy*, Introd. p. xxx. It should be noted that in P (Code of Holiness) Lev. xvii. 13 foll. the resident alien (*ger*) is placed on an equality with the Jew.

the midnight darkness of Israel's exile to prepare for the nation's renewed life. The external bases of Israel's religion had been swept away, and in exchange for these Jeremiah had led his countrymen to the more permanent internal grounds of a spiritual renewal. But a religion could not permanently subsist in this world of space and time without some external concrete embodiment. It was the task of Ezekiel to take up once more the broken threads of Israel's religious traditions, and weave them anew into statelier forms of ritual and national polity. The priest-prophet's keen eye for detail, manifested in the elaborate vision of the wheels and living creatures (Ezek. i.) and in his lamentation on Tyre (chap. xxvii.), is also exhibited in the visions contained in chaps. xl.-xlviii., which describe the ideal reconstructed temple and theocracy of the restored Israel. The foreground is filled by the temple and its precincts. The officiating priests are now the descendants of the line of Zadok belonging to the tribe of Levi. Thus the priesthood is still further restricted as compared with the restriction already noted in the Deuteronomical legislation. It is the sons of Zadok only that have any right to offer sacrifice at the altar of burnt offering (xliii. 19, xlv. 15 foll.). The Levites, who formerly ministered in the high places, now discharge the subordinate offices of gate-keepers and slaughterers of the sacrificial victims.

Another element in this ideal scheme which comes into prominence is the sharp distinction between *holy* and *profane*. The word *holiness* (*qodesh*) in primitive Hebrew usage partook of the nature of taboo, and came to be applied to whatever, whether thing or person, stood in close relation to deity and belonged to him, and could not, therefore, be used or treated like other objects not so related, and so was separated or stood apart. The idea underlying the word, which to us is invested with deep ethical meaning, had only this non-ethical, ritual significance in Ezekiel. Unlike the old temple and city, the ideal temple of Ezekiel is entirely separate from the city of Jerusalem. In the immediate surroundings of the temple there is an open space. Then come two concentric forecourts of the temple. The temple stands in the midst of what is called the *gizrah* or space severed off. The outer court lies higher than the open space, the inner court higher still, and the temple-building in the centre highest of all. No heathen may tread the outer court, no layman the inner court, while the holiest of all may not be trodden even by the priest Ezekiel but only by the angel who accompanies him. "The temple-house has a graduated series of compartments increasing in sanctity inwards" (Davidson). In the innermost the presence of Yahweh abides.

We are here moving in a realm of ideas prevailing in ancient Israel respecting *holiness, uncleanness, and sin*, which are ceremonial and not ethical; see especially Robertson Smith's *Religion of the Semites*, 2nd ed., p. 446 foll. (additional note B.) on holiness, uncleanness and taboo. It is, of course, true that the ethical conception of sin as violation of righteousness and an act of rebellion against the divine righteous will had been developed since the days of Amos and Isaiah; but, as we have already observed, cultus and prophetic teaching were separated by an immense gulf, and in spite of the reformation of 621 B.C. still remain separated. In the sacrificial system of sin-offerings (*hattath* and *asham*) we have to do with sin as ceremonial violation and neglect (frequently involuntary), or violation of holiness in the old sense of the term or as personal uncleanness (touching a corpse, eating unclean food, sexual impurity, &c.). In the historical evolution of Hebrew sacrifice it is remarkable how long this non-ethical and primitive survival of old custom still survived, even far into post-exilic times. (See SACRIFICE; also Moore's art. "Sacrifice" in *Ency. Bibl.*)

One conspicuous feature of Ezekiel's system is the predominance of piacular sacrifice. It undoubtedly existed in pre-exilic Israel, especially in times of crisis or calamity, for the appeasement of an offended deity (2 Sam. xxiv. 18 foll.), and in Deut. xxi. 1-9, we have details of the purificatory rite which was necessary when human blood was shed; but now and in the future propitiatory sacrifice and ideas of propitiation began to

overshadow all the other forms of sacrifice and their ideas. Ezekiel prescribes a half-yearly ritual of sin-offering whereby atonement was to be made (xlv. 18-20). We shall see subsequently to what great institution this led the way.

Ezekiel's system constituted an *ecclesiastical* in place of a political organization, a *church-state* in place of a nation. We clearly discern how this reacted on his Messianic conceptions. In his earlier oracles (xxxiv. 23 foll.) we find one shepherd ruling over united Israel, viz. Yahweh's servant David, whereas in the ideal scheme detailed in chap. xl. et seq. the rôle of the prince as a ruler is a very shadowy one. The prince, it is true, has a central domain, but his functions are ecclesiastical and subordinate and his powers strictly limited (xlv. 5-8, 12, 16-18).

Thus the exile period marks the parting of the ways in the development of Hebrew religion. In the Deutero-Isaiah we reach the highest point in the evolution of propheticism. It is true that we have some noble resounding echoes in the lyrical passages ix.-lxiii. in the Trito-Isaiah during the post-exilic period, and in such psalm literature as Pss. xxiii., xxxvii., l., lxii., cvii., cxlv. 9-12 and others; and also in Isa. xxxv., which is obviously a lyrical reproduction of earlier literature. But it cannot be said that we possess in later literature any fresh contribution to the conception of God or any presentation of a higher ideal of human life or national destiny than that which meets us in chap. xl. or in the servant-passages of the Deutero-Isaiah. It may with truth be said that *after Jeremiah we discern the parting of the ways*. The first is represented by the Deutero-Isaiah, who constitutes the climax and close of Hebrew propheticism, which is henceforth (with the possible exception of the Trito-Isaiah, Malachi and Jonah, who reproduce some features of the earlier prophecy) a virtually arrested development. The second path is that which is traced out by the priest-prophet Ezekiel, and is that of *legalism*, which was destined to secure a permanent place in the life and literature of the Jewish people. It is essentially the path which may be summed up in the word *Judaism*, though, as will be shown in the sequel, Judaism came to include many other factors. The statement, however, remains virtually true, since Judaism is mainly constituted by the body of legal precepts called the *Tôrâh*, and, moreover, by the post-exilic *Tôrâh*.

9. *Post-exilic Law—The Priestercodex.*—The oracles of Malachi clearly reveal the continued influence of the book of Deuteronomy in his day. But the new conditions created by the return of the exiles and the germinating influence of Ezekiel's ideas developed a process of new legislative construction. The code of holiness (Lev. xvii.-xxvi.) is the most obvious product of that influence. The ideas of expiation and atonement so prevalent in Ezekiel's scheme, which there find expression in the half-yearly sacrificial celebrations, are expressed in Lev. xvi. in the single *annual great fast of atonement*. It is impossible to enter here into the numerous details of that impressive ceremonial. Two special features, however, which characterize the celebration should here be noted: (a) The person of the *high priest*, who is throughout the entire drama the chief and indeed the sole actor. This supreme official, who was destined ultimately to take the place of the king in the church-nation of post-exilic Judaism, is mentioned for the first time in Zech. iii. 1² (in the person of Joshua). In the Priestercodex he stands at the head of the priests, who are, in the post-exilic system, the *sons of Aaron* and possessed the sole right to offer the temple sacrifices. On the great day of atonement the high priest appears in a vicarious and representative capacity, and offers on behalf of the whole nation which he was considered to embody in his sacred person.

(b) The rite of the *god devoted to Asazel*. There can be little doubt that we shall have to note the emergence of the doctrine of the *resurrection of the righteous* in later Judaism, which is obviously a fresh contribution of permanent value to Hebrew doctrine. On the other hand, the doctrine of *pre-existence* is speculative rather than religious, and applies to institutions rather than persons.

² The legislative portions are mainly comprised in Ex. xxxv.-end, Leviticus entire and Num. i.-x.

³ But this term (literally the *chief priest*) was already in use during the regal period to designate the head priest of an important sanctuary such as Jerusalem (2 Kings xii, 11).

doubt that *Asazel* was an evil demon (like an Arabic Jinn) of the desert. The goat set apart for *Asazel* was in the concluding part of the ceremonial brought before the high priest, who laid both his hands upon it and confessed over it the sins of the people. It was then carried off by an appointed person to a lonely spot and there set free.

In later post-exilian times this great day of atonement became to an increasing degree a day of humiliation for sin and penitent sorrow, accompanied by confession; and the sins confessed were not only of a purely ceremonial character, whether voluntary or inadvertent, but also sins against righteousness and the duties which we owe to God and man. This element of public confession for sin became more prominent in the days when synagogal worship developed, and prayer took the place of the sacrificial offerings which could only be offered in the Jerusalem temple. The development of the priestly code of legislation (Priestercodes) was a gradual process, and probably occupied a considerable part of the 5th century B.C. The Hebrew race now definitely entered upon the new path of organized Jewish legalism which had been originally marked out for it by Ezekiel in the preceding century. It became a holy people on holy ground. Circumcision and Sabbath, separation from marriage with a foreigner, which rendered a Jew unclean, as well as strict conformity to the precepts of the Torah, constituted henceforth an adamant bond which was to preserve the Jewish communities from disintegration.

10. *The later Post-exilian Developments in Jewish Religion.*—These may be briefly referred to under the following aspects:

(a) *Codified law* and the written record of the patriarchal history, as well as the life and work of the lawgiver Moses (to whom the entire body of law came to be ascribed), assumed an ever greater importance. The reverence felt for the canonized *Tōrah* or law (the Pentateuch or so-called five books of Moses) grew even into worship. Of this spirit we find clear expression in some of the later psalms, e.g. the elaborate alphabetic Ps. cxix. and the latter portion of Ps. xix. There were various causes which combined to enhance the importance of the written *Tōrah* (the "instruction" *par excellence* communicated by God through Moses). Chief among these were (1) *The conception of God as transcendent*. We have taken due note of Amos, who unfolded the character of Yahweh as universal righteous sovereign; and also the sublime portrayal of His exalted nature in Isa. xl. (verse 15; cf. 22-26, and Job xxxvi. 22-23, 6). The intellectual influence of Greece, manifested in Alexandrian philosophy, tended to remove God still further from the human world of phenomena into that of an inaccessible transcendental abstraction. Little, therefore, was possible for the Jew save strict performance of the requirements of the *Tōrah*, once for all given to Moses on Sinai, and, in his approach to the awful and unknown mystery, to rely on ceremonial and ascetic performances (see Wendt's *Teaching of Jesus*, i. 55 foll.). The same tendency led the pious worshippers to avoid His awful name and to substitute *Adonai* in their scriptures or to use in the Mishna the term "name" (*shēm*) or "heaven." (2) *The Maccabean conflict* (165 B.C.) tended to accentuate the national sentiment of antagonism to Hellenic influence. The Māsidim or pious devotees, who arose at that time, were the originators of the Pharisaic movement which was conservative as well as national, and laid stress on the strict performance of the law.

(b) *Eschatology* in the Judaism of the Greek period began to assume a new form. The pre-exilian prophets (especially Isaiah) spoke of the forthcoming crisis in the world's history as a "day of the Lord." These were usually regarded as visitations of chastisement for national sins and vindications of divine righteousness or judgments, i.e. assertions of God's power as judge (*shōphet*). By the older prophets this judgment of God or "day of Yahweh" was never held to be far removed from the horizon of the present or the world in which they lived. But now as we enter the Greek period (330 B.C. and onwards) there is a gradual change from prophecy to *apocalyptic*. "It may be asserted in general terms that whereas prophecy foretells a definite future which has its foundation in the present, apoca-

lyptic directs its anticipations solely and simply to the future, to a new world-period which stands sharply contrasted with the present. The classical model for all apocalyptic is to be found in Dan. vii. It is only after a great war of destruction, a day of Yahweh's great judgment, that the dominion of God will begin" (Bousset). Ezek. xxxviii. and xxxix. clearly bear the apocalyptic character; so also Isa. xxxiv. and notably Isa. xxiv.-xxvii. Apocalyptic, as Baldensperger has shown, formed a counterpoise to the normal current of conformity to law. It arose from a spiritual movement in answer to the yearning of the heart: "O that Thou mightest rend the heavens and come down and the mountains quake at Thy presence!" (Isa. lxiv. 1 [Heb. lxiii. 19]); and it was intended to meet the craving of souls sick with waiting and disappointment. The present outlook was hopeless, but in the enlarged horizon of time as well as space the thoughts of some of the most spiritual minds in Judaism were directed to the transcendent and ultimate. The present world was corrupt and subject to Satan and the powers of darkness. This they called "the present *aeon*" (age). Their hopes were therefore directed to "the coming *aeon*." Between the two *aeons* there would take place the *advent of the Messiah*, who would lead the struggle with evil powers which was called "the agonies of the Messiah." This terrible intermezzo was no longer terrestrial, but was a cosmic and universal crisis in which the Messiah would emerge victorious from the final conflict with the heathen and demonic powers. This victory inaugurates the entrance of the "aeon to come," in which the faithful Jews would enter their inheritance. In this way we perceive the transformation of the old Messianic doctrine through apocalyptic. Of apocalyptic literature we have numerous examples extending from the 2nd century B.C. to the 2nd century A.D. (See especially Charles's *Book of Enoch*.)

The doctrine of the *resurrection of the righteous* to life in the heavenly world became engrafted on to the old doctrine of *Sheol*, or the dark shadowy underworld (Hades), where life was joyless and feeble, and from which the soul might be for a brief space summoned forth by the arts of the necromancer. The most vivid portrayal of *Sheol* is to be found in the exilian passage Isa. xiv. 9-20 (cf. Job x. 21-22). With this also compare the *Babylonian Descent of Ishtar to Hades*. The added conception of the resurrection of the righteous does not appear in the world of Jewish thought till the early Greek period in Isa. xxvi. 19. R. H. Charles thinks that in this passage the idea of resurrection is of purely Jewish and not of Mādaean (or Zoroastrian) origin, but it is otherwise with Dan. xii. 2; see his *Eschatology, Hebrew, Jewish and Christian*. Corresponding to heaven, the abode of the righteous, we have *Gē-Hinnom* (originally *Gē-Hinnom*, the scene of the Moloch rites of human sacrifice), the place of punishment after death for apostate Jews.

(c) *Doctrine of Angels and of Hypostases.*—In the writings of the pre-exilian period we have frequent references to supernatural personalities good and bad. It is only necessary to refer to them by name. *Sedāthā*, or "hosts," attached to the name of Yahweh, denoted the heavenly retinue of stars. The *seraphim* were burning serpentine forms who hovered above the enthroned Yahweh and chanted the Trisagion in Isaiah's consecration vision (Isa. vi.). We have also constant references to "angels" (*malāchim*) of God, divine messengers who represent Him and may be regarded as the manifestation of His power and presence. This especially applies to the "angel of Yahweh" or angel of His Presence (Ex. xxiii. 20, 23 (E)). Note in Ex. xxxiii. 14 (J) he is called "my face" or "presence" (cf. Isa. lxiii. 9). We also know that from earliest times Israel believed in the evil as well as good spirits. Like the Arabs they held that demons became incorporate in serpents, as in Gen. iii. The *nephthim* were a monstrous brood begotten of the intercourse of the supernatural beings called "sons of God" with the women of earth. We also read of the "evil spirit" that came upon Saul. Contact with Babylonia tended to stimulate the

¹ Cf. the Phoenician parallel of "Face of Baal," worshipped as Tanit, "queen of Heaven" (Batlggen, *Beiträge zur Semit. Religionsgeschichte*, p. 55 foll.); also the place Peniel (face of God).

angelology and demonology of Israel. The Hebrew word *shdd* or "demon" is no more than a Babylonian loan word, and came to designate the deities of foreign peoples degraded into the position of demons.¹ *Lilith*, the blood-sucking night-hag of the post-exilic Isa. xxxiv. 14, is the Babylonian *Lilithu*. Whether the *se'irim* or shaggy satyrs (Isa. xiii. 31; Lev. xvii. 7) and *Azazel* were of Babylonian origin it is difficult to determine. The emergence of *Satan* as a definite supernatural personality, the head or prince of the world of evil spirits, is entirely a phenomenon of post-exilic Judaism. He is portrayed as the arch-adversary and accuser of man. It is impossible to deny Persian influence in the development of this conception, and that the Persian *Ahriman* (*Angromainyu*), the evil personality opposed to the good, *Ahura Mazda*, moulded the Jewish counterpart, *Satan*. But in Judaism monotheistic conceptions reigned supreme, and the *Satan* of Jewish belief as opposed to God stops short of the dualism of Persian religion. Of this we see evidence in the multiplication of *Satans* in the Book of Enoch. In the Book of Jubilees he is called *masitmd*. In later Judaism *Sammael* is the equivalent of *Satan*. Persian influence is also responsible for the vast multiplication of good spirits or angels, Gabriel, Raphael, Michael, &c., who play their part in apocalyptic works, such as the Book of Daniel and the Book of Enoch.

Probably the transcendent nature of the deity in the Judaism of this later period made the interposition of mediating spirits an intellectual necessity (cf. Ps. civ. 4). It also stimulated the creation of *divine hypostases*. First among these may be mentioned *Wisdom*. The roots of this conception belong to pre-exilic times, in which the "word" of divine denunciation was regarded as a quasi-material thing. (It is hurled against offending Israel, Isa. ix. 8.) In the post-exilic cosmogony it is the divine word or fiat that creates the world (Gen. i.; cf. Ps. xxxiii. 6, 9). Out of these earlier conceptions the idea of the divine wisdom (Heb. *hokhmah*) gradually arose during the Persian period. The expression "wisdom," as it is employed in the *locus classicus*, Prov. viii., connotes the contents of the Divine reason—His conscious life, out of which created things emerge. This wisdom is personified. It dwelt with God (Prov. viii. 22 foll.) before the world was made. It is the companion of His throne, and by it He made the world (Prov. iii. 19, viii. 27; cf. Ps. civ. 24). It, moreover, enters into the life of the world and especially man (Prov. viii. 31). This conception of wisdom became still further hypostatized. It becomes redemptive of man. In the Wisdom of Solomon it is the sharer of God's throne (*σάραβρος*), the effulgence of the eternal light and the outflow of His glory (Wisd. vii. 25, viii. 3 foll., ix. 4, 9); "Them that love her the Lord doth love" (Ecclesiasticus iv. 14). This group of ideas culminated in the *Logos* of Philo, expressing the world of divine ideas which God first of all creates and which becomes the mediating and formative power between the absolute and transcendent deity and passive formless matter, transmuted thereby into a rational, ordered universe.

In later Jewish literature we meet with further examples of similar hypostases in the form of *Mémra*, *Metatron*, *Shechinah*, *Holy Spirit* and *Bath kol*.

(d) The doctrine of *pre-existence* is another product of the speculative tendency of the Jewish mind. The Messiah's pre-existent state before the creation of the world is asserted in the Book of Enoch (xlvi. 6, 7). Pre-existence is also asserted of Moses and of sacred institutions such as the New Jerusalem, the Temple, Paradise, the *Tôrâh*, &c. (Apocal. of Baruch iv. 3-lit. 4; Assumptio Mosis i. 14, 17) Edersheim's *Life and Times of the Messiah*, i. 175 and footnote 2.

11. *Christ resumes the Broken Tradition of Prophecy*.—The Psalms of Solomon and the synoptic Gospels (70 B.C.—A.D. 100) clearly reveal the powerful revival of Messianic hopes of a national deliverer of the seed of David. This Messianic expectation had been a fermenting leaven since the great days of Judas Maccabaeus. The conceptions of Jesus of Nazareth, however, were not the Messianic conceptions of his fellow-countrymen, but

¹ Deut. xxxii. 17; Ps. cvl. 37. Baal Zebûb of the Philistine Ekron became the Beelzebub who was equivalent to Satan.

of the spiritual "son of man" destined to found a kingdom of God which was righteousness and peace. The *Tôrâh* of Jesus was essentially prophetic and in no sense priestly or legal. The arrested prophetic movement of Jeremiah and Deutero-Isaiah reappears in John the Baptist and Jesus after an interval of more than five centuries. The new covenant of redeeming grace—the righteousness which is in the heart and not in externalities of legal observance or ceremonial—are once more proclaimed, and the exalted ideals of the suffering servant of Isa. xlix. 6 and Isa. liii. (nearly suppressed in the Targum of Jonathan) are reasserted and vindicated by the words and life of Jesus. Like Jeremiah He foretold the destruction of the temple and suffered the extreme penalties of anti-patriotism. And thus Israel's old prophetic *Tôrâh* was at length to achieve its victory, for after Jesus came St. Paul. "Many shall come from the east and the west and sit down with Abraham, Isaac and Jacob in the kingdom of heaven" (Matt. viii. 11, 12). The fetters of nationalism were to be broken, and the Hebrew religion in its essential spiritual elements was to become the heritage of all humanity.

AUTHORITIES.—1. On Semitic religion generally: Wellhausen's *Reste des arabischen Heidentums* (2nd ed.) and Robertson Smith's *Religion of the Semites* (2nd ed.) are chiefly to be recommended. Barton's *Semitic Origins* is extremely able, but his doctrine of the derivation of male from original female deities is pushed to an extreme. Bâthgen's *Beiträge zur semitischen Religionsgeschichte* (1888) is most useful, and contains valuable epigraphic material. Baudissin's *Studien zur semitischen Religionsgeschichte* (1876) is still valuable. See also Kuenen's *National Religions and Universal Religions* (Hibbert lectures) and Lagrange's *Études sur les religions sémitiques* (2nd ed.).

2. On Hebrew religion in particular: specially full and helpful is Kautzsch's article "Religion of Israel" in Hastings's *D.B.*, extra vol.; Marti's recent *Religion des A.T.* (1906) and his *Geschichte der israelitischen Religion*, are clear, compact and most serviceable, and the former work presents the subject in fresh and suggestive aspects. Wellhausen's *Prolegomena und Jüdische Geschichte* should be read both for criticism and Hebrew history generally. Duhm's *Theologie der Propheten* and Robertson Smith's *Prophecy of Israel* should also be consulted. Strongly to be recommended are Smend, *Lehrbuch der alttestamentlichen Religionsgeschichte*; Bennett, *Theology of the Old Testament and Religion of the Post-Exilic Prophets*; A. B. Davidson, *The Theology of the Old Testament*, as well as the sections devoted to "Sacralaltertümern" in the *Hebräische Archäologie* both of Benzinger and also of Nowack. Budde's *Die Religion des Volkes Israel bis zur Verbannung*, as well as Addis's recent *Hebrew Religion* (1906), is a most careful and scholarly compendium. Harper's *Introd. to his Commentary on Amos and Hosea* (L. and T. Clark) contains a useful survey of the history of Hebrew religion before the 8th century. Buchanan Gray's *Divine Discipline of Israel*, and A. S. Peake's *Problem of Suffering in the O.T.*, are suggestive. See also S. A. Cook, *Religion of Ancient Palestine*.

3. On the history of Judaism till the time of Christ, Schröter's *Geschichte des jüdischen Volkes im Zeitalter Christi* (3rd ed.), vol. ii. and in part vol. iii., are indispensable. Bousset's *Religion des Judentums* (2nd ed.), and Voltz, *Die jüdische Eschatologie von Daniel bis Ahab*, are highly to be commended. Weber's *Jüdische Theologie* is a useful compendium of the theology of later Judaism.

4. On the special department of eschatology the standard works are R. H. Charles, *Eschatology, Hebrew, Jewish and Christian*, and Schwally, *Das Leben nach dem Tode*, as well as Gressmann's suggestive work *Der Ursprung der israelitisch-jüdischen Eschatologie*, which contains, however, much that is speculative. On apocalyptic generally the introductions to Charles's Book of Enoch, Apocalypse of Baruch, Ascension of Isaiah and Book of Jubilees, should be carefully noted. See also **ESCHATOLOGY**.

5. On the religion of Babylonia, Jastrow's work is the standard one. Zimmern's *Heft ii. in K.A.T.* (3rd ed.) is specially important to the Old Testament student. See also W. Schrank, *Babylonische Sührten*. (O. C. W.)

HEBREWS, EPISTLE TO THE, one of the books of the New Testament. In the oldest MSS. it bears no other title than "To Hebrews." This brief heading embraces all that on which Christian tradition from the end of the 2nd century was unanimous; and it says no more than that the readers addressed were Christians of Jewish extraction. This would be no sufficient address for an epistolary writing (xiii. 22) directed to a definite circle of readers, to whose history repeated reference is made, and with whom the author had personal relations (xiii. 19, 23). Probably, then, the original and limited address, or rather salutation, was never copied when this treatise in letter form, like the epistle to the Romans, passed into the wider circulation which

its contents merited. In any case the Roman Church, where the first traces of the epistle occur, about A.D. 96 († Clement), had nothing to contribute to the question of authorship except the negative opinion that it was not by Paul (Euseb. *Ecd. Hist.* iii. 3); yet this central church was in constant connexion with provincial churches.

The earliest positive traditions belong to Alexandria and N. Africa. The Alexandrine tradition can be traced back as far as a teacher of Clement, presumably Pantænus (Euseb. *Ecd. Hist.* vi. 14), who sought to explain why Paul did not name himself as usual at the head of the epistle. Clement himself, taking it for granted that an epistle to Hebrews must have been written in Hebrew, supposes that Luke translated it for the Greeks. Origen implies that "the men of old" regarded it as Paul's, and that some churches at least in his own day shared this opinion. But he feels that the language is un-Pauline, though the "admirable" thoughts are not second to those of Paul's unquestioned writings. Thus he is led to the view that the ideas were orally set forth by Paul, but that the language and composition were due to some one giving from memory a sort of free interpretation of his teacher's mind. According to some this disciple was Clement of Rome; others name Luke; but the truth, says Origen, is known to God alone (Euseb. vi. 25, cf. iii. 38). Still from the time of Origen the opinion that Paul wrote the epistle became prevalent in the East. The earliest African tradition, on the other hand, preserved by Tertullian (*De pudicitia*, c. 20), but certainly not invented by him, ascribed the epistle to Barnabas. Yet it was perhaps, like those named by Origen, only an inference from the epistle itself, as if a "word of exhortation" (xiii. 22) by the Son of Exhortation (Acts iv. 36; see BARNABAS). On the whole, then, the earliest traditions in East and West alike agree in effect, viz. that our epistle was not by Paul, but by one of his associates.

This is also the twofold result reached by modern scholarship with growing clearness. The vacillation of tradition and the dissimilarity of the epistle from those of Paul were brought out with great force by Erasmus. Luther (who suggests Apollon) and Calvin (who thinks of Luke or Clement) followed with the decisive argument that Paul, who lays such stress on the fact that his gospel was not taught him by man (Gal. i.), could not have written Heb. ii. 3. Yet the wave of reaction which soon overwhelmed the freer tendencies of the first reformers, brought back the old view until the revival of biblical criticism more than a century ago. Since then the current of opinion has set irrevocably against any form of Pauline authorship. Its type of thought is quite unique. The Jewish Law is viewed not as a code of ethics or "works of righteousness," as by Paul, but as a system of religious rites (vii. 11) shadowing forth the way of access to God in worship, of which the Gospel reveals the archetypal realities (ix. 1, 11, 15, 23 f., x. 1 ff., 19 ff.). The Old and the New Covenants are related to one another as imperfect (earthly) and perfect (heavenly) forms of the same method of salvation, each with its own type of sacrifice and priesthood. Thus the conception of Christ as High Priest emerges, for the first time, as a central point in the author's conception of Christianity. The Old Testament is cited after the Alexandrian version more exclusively than by Paul, even where the Hebrew is divergent. Nor is this accidental. There is every appearance that the author was a Hellenist who lacked knowledge of the Hebrew text, and derived his metaphysic and his allegorical method from the Alexandrian rather than the Palestinian schools. Yet the epistle has manifest Pauline affinities, and can hardly have originated beyond the Pauline circle, to which it is referred not only by the author's friendship with Timothy (xiii. 23), but by many echoes of the Pauline theology and even, it seems, of passages in Paul's epistles (see Holtzmann, *Einkleitung in das N. T.*, 1892, p. 298). These features early suggested Paul as the author of a book which stood in MSS. immediately after the epistles of that apostle, and contained nothing in its title to

distinguish it from the preceding books with like headings, "To the Romans," "To the Corinthians," and the like. A similar history attaches to the so-called Second Epistle of Clement (see CLEMENTINE LITERATURE).

Everything turns, then, on internal criticism of the epistle, working on the distinctive features already noticed, together with such personal allusions as it affords. As to its first readers, with whom the author stood in close relations (xiii. 10, 23, cf. vi. 10, x. 32-34), it used generally to be agreed that they were "Hebrews" or Christians of Jewish birth. But, for a generation or so, it has been denied that this can be inferred simply from the fact that the epistle approaches all Christian truth through Old Testament forms. This, it is said, was the common method of proof, since the Jewish scriptures were the Word of God to all Christians alike. Still it remains true that the exclusive use of the argument from Mosaism, as itself implying the Gospel of Jesus the Christ as final cause (τέλος), does favour the view that the readers were of Jewish origin. Further there is no allusion to the incorporation of "strangers and foreigners" (Eph. ii. 19) with the people of God. Yet the readers are not to be sought in Jerusalem (see e.g. ii. 3), nor anywhere in Judæa proper. The whole Hellenistic culture of the epistle (let alone its language), and the personal references in it, notably that to Timothy in xiii. 23, are against any such view: while the doubly emphatic "all" in xiii. 24 suggests that those addressed were but part of a community composed of both Jews and Gentiles. Caesarea, indeed, as a city of mixed population and lying just outside Judæa proper—a place, moreover, where Timothy might have become known during Paul's two years' detention there—would satisfy many conditions of the problem. Yet these very conditions are no more than might exist among intensely Jewish members of the Dispersion, like "the Jews of Asia" (cf. Sir W. M. Ramsay, *The Letters to the Seven Churches*, 155 f.), whose zeal for the Temple and the Mosaic ritual customs led to Paul's arrest in Jerusalem (Acts xix. 27 f., cf. 20 f.), in keeping both with his former experiences at their hands and with his forebodings resulting therefrom (xx. 19, 22-24). Our "Hebrews" had obviously high regard for the ordinances of Temple worship. But this was the case with the dispersed Jews generally, who kept in touch with the Temple, and its intercessory worship for all Israel, in every possible way; in token of this they sent with great care their annual contribution to its services, the Temple tribute. This bond was doubtless preserved by Christian Hellenists, and must have tended to continue their reliance on the Temple services for the forgiveness of their recurring "sins of ignorance"—subsequent to the great initial Messianic forgiveness coming with faith in Jesus. Accordingly many of them, while placing their hope for the future upon Messiah and His eagerly expected return in power, might seek assurance of present forgiveness of daily offences and cleansing of conscience in the old mediatorial system. In particular the annual Day of Atonement would be relied on, and that in proportion as the expected Parousia tarried, and the first enthusiasm of a faith that was largely eschatological died away, while ever-present temptation pressed the harder as disappointment and perplexity increased.

Such was the general situation of the readers of this epistle, men who rested partly on the Gospel and partly on Judaism. For lack of a true theory as to the relation between the two, they were now drifting away (ii. 1) from effective faith in the Gospel, as being mainly future in its application, while Judaism was a very present, concrete, and impressive system of religious aids—to which also their sacred scriptures gave constant witness. The points at which it chiefly touched them may be inferred from the author's counter-argument, with its emphasis in the spiritual ineffectiveness of the whole Temple-system, its high-priesthood and its supreme sacrifice on the Day of Atonement. With passionate earnestness he sets over against these his constructive theory as to the efficacy, the heavenly yet unseen reality, of the definitive "purification of sins" (i. 3) and perfected access to God's inmost presence, secured for Christians as such by Jesus the Son of God (x. 9-22), and traces their moral feebleness and slackened zeal to want of progressive insight

¹ Also in Codex Claromontanus, the *Tractatus de libris* (x.), Pliastrius of Brescia (c. A.D. 380), and a prologue to the Catholic Epistles (*Revisio benedictine*, xxiii. 82 ff.). It is defended in a monograph by H. H. B. Ayles (Cambridge, 1899).

into the essential nature of the Gospel as a "new covenant," moving on a totally different plane of religious reality from the now antiquated covenant given by Moses (viii. 13).

The following plan of the epistle may help to make apparent the writer's theory of Christianity as distinct from Judaism, which is related to it as "shadow" to reality:

Themes: The finality of the form of religion mediated in God's Son, i. 1-4.

i. The supreme excellence of the Son's Person (i. 5-iii. 6), as compared with (a) angels, (b) Moses.

Practical exhortation, iii. 7-iv. 13, leading up to:

ii. The corresponding efficacy of the Son's High-priesthood (iv. 14-ix.).

(1) The Son has the qualifications of all priesthood, especially sympathy.

Exhortation, raising the reader's thought to the height of the topic reached (v. 11-vi. 20).

(2) The Son as absolute high priest, in an order transcending the Aaronic (vii.) and relative to a Tabernacle of ministry and a Covenant higher than the Mosaic in point of reality and finality (viii., ix.).

(3) His Sacrifice, then, is definitive in its effects (*veredolore*), and supersedes all others (x. 1-18).

iii. Appropriation of the benefits of the Son's high-priesthood, by steadfast faith, the paramount duty (x. 19-xii.). More personal epilogue (xiii.).

As lack of insight lay at the root of their troubles, it was not enough simply to enjoin the moral fidelity to conviction which is three parts of faith to the writer, who has but little sense of the mystical side of faith, so marked in Paul. There was need of a positive theory based on real insight, in order to inspire faith for more strenuous conflict with the influences tending to produce the apostasy from Christ, and so from "the living God," which already threatened some of them (iii. 12). Such "apostasy" was not a formal abjuring of Jesus as Messiah, but the subtler lapse involved in ceasing to rely on relation to Him for daily moral and religious needs, summed up in purity of conscience and peace before God (x. 19-23, xiii. 20 f.). This "falling aside" (vi. 5, cf. xii. 12 f.), rather than conscious "turning back" is what is implied in the repeated exhortations which show the intensely practical spirit of the whole argument. These exhortations are directed chiefly against the dullness of spirit which hinders progressive moral insight into the genius of the New Covenant (v. 11-vi. 8), and which, in its blindness to the full work of Jesus, amounts to counting His blood as devoid of divine efficacy to consecrate the life (x. 26, 29), and so to a personal "crucifying anew" of the Son of God (vi. 6). The antidote to such "profane" negligence (ii. 1, 3, xii. 12 f., 15-17) is an earnestness animated by a fully-assured hope, and sustained by a "faith" marked by patient waiting (*μακροθυμία*) for the inheritance guaranteed by divine promise (x. 11 f.). The outward expression of such a spirit is "bold confession," a glorying in that Hope, and mutual encouragement therein (iii. 6, 12 f.); while the sign of its decay is neglect to assemble together for mutual stimulus, as if it were not worth the odium and opposition from fellow Jews called forth by a marked Christian confession (x. 23-25, xii. 3)—a very different estimate of the new bond from that shown by readiness in days gone by to suffer for it (x. 32 f.). Their special danger, then, the sin which deceived (iii. 13) the more easily that it represented the line of least resistance (perhaps the best paraphrase of *εὐπειλατος ἀμαρτία* in xii. 1), was the exact opposite of "faith" as the author uses it, especially in the chapter devoted to its illustration by Old Testament examples. His readers needed most the moral heroism of fidelity to the Unseen, which made men "despise shame" due to aught that sinners in their unbelief might do to them (xii. 9-11, xiii. 5 f.)—and of which Jesus Himself was at once the example and the inspiration. To quicken this by awakening deeper insight into the real objects of "faith," as these bore on their actual life, he develops his high argument on the lines already indicated.

Their situation was so dangerous just because it combined inward debility and outward pressure, both tending to the same result, viz. practical disuse of the distinctively Christian means of grace, as compared with those recognized by Judaism, and

such conformity to the latter as would make the reproach of the Cross to cease (xiii. 13, cf. xi. 26). This might, indeed, relieve the external strain of the contest (*ἀγών* xii. 1), which had become well-nigh intolerable to them. But the practical surrender of what was distinctive in their new faith meant a theoretic surrender of the value once placed on that element, when it was matter of a living religious experience far in advance of what Judaism had given them (vi. 4 f., x. 26-29). This twofold infidelity, in thought and deed, God, the "living" God of progress from the "shadow" to the substance, would require at their heads (x. 30 f., xii. 22-29). For it meant turning away from an appeal that had been known as "heavenly," for something inferior and earthly (xii. 25); from a call sanctioned by the incomparable authority of Him in whom it had reached men, a greater than Moses and all media of the Old Covenant, even the Son of God. Thus the key of the whole exhortation is struck in the opening words, which contrast the piecemeal revelation "to the fathers" in the past, with the complete and final revelation to themselves in the last stage of the existing order of the world's history, in a Son of transcendent dignity (i. 1 f., cf. ii. 1 f., x. 28 f., xii. 18 f.). This goes to the root of their difficulty, ambiguity as to the relation of the old and the new elements in Judaeo-Christian piety, so that there was constant danger of the old overshadowing the new, since national Judaism remained hostile. At a stroke the author separates the new from the old, as belonging to a new "covenant" or order of God's revealed will. It is a confusion, resulting in loss, not in gain, as regards spiritual power, to try to combine the two types of piety, as his readers were more and more apt to do. There is *no use*, religiously, in falling back upon the old forms, in order to avoid the social penalties of a sectarian position within Judaism, when the secret of religious "perfection" or maturity (vi. 1, cf. the frequent use of the kindred verb) lies elsewhere. Hence the moral of his whole argument as to the two covenants, though it is formulated only incidentally amid final detailed counsels (xiii. 13 f.) is to leave Judaism, and adopt a frankly Christian standing, on the same footing with their non-Jewish brethren in the local church. For this the time was now ripe; and in it lay the true path of safety—eternal safety as before God, whatever man might say or do (xiii. 5 f.).

The obscure section, xiii. 9 f., is to be taken as "only a symptom of the general retrogression of religious energy" (Jülicher), and not as bearing directly on the main danger of these "Hebrews." The "foods" in question probably refer neither to temple sacrifices nor to the Levitical laws of clean and unclean foods, nor yet to ascetic scruples (as in Rom. xiv., Col. ii. 20 f.), but rather to some form of the idea, found also among the Essenes, that food might so be partaken of as to have the value of a sacrifice (see verse 15 f.) and thus ensure divine favour. Over against this view, which might well grow up among the Jews of the Dispersion as a sort of substitute for the possibility of offering sacrifices in the Temple—but which would be a lame addition to the Christianity of their own former leaders (xiii. 7 f.)—the author first points his readers to its refutation from experience, and then to the fact that the Christian's "altar" or sacrifice (*i.e.* the supreme sin-offering) is of the kind which the Law itself forbids to be associated with "eating." If Christians wish to offer any special sacrifice to God, let it be that of grateful praise or deeds of beneficence (15 f.).

In trying further to define the readers addressed in the epistle, one must note the stress laid on suffering as part of the divinely appointed discipline of sonship (ii. 10, v. 8, xii. 7 f.), and the way in which the analogy in this respect between Jesus, as Messianic Son, and those united to Him by faith, is set in relief. He is not only the inspiring example for heroic faith in the face of opposition due to unbelievers (xii. 3 f.), but also the mediator qualified by his very experience of suffering to sympathize with His tried followers, and so to afford them moral aid (ii. 17 f., v. 8 f., cf. iv. 15). This means that suffering for Christianity, at least in respect of possessions (xiii. 5 f., cf. x. 34) and social standing, was imminent for those addressed; and it seems as if they were mostly men of wealth and position (xiii. 1-6

vi. 10 f., x. 34), who would feel this sort of trial acutely (cf. Jas. i. 10). Such men would also possess a superior mental culture (cf. v. 11 f.), capable of appreciating the form of an epistle "far too learned for the average Christian" (Jülicher), yet for which its author apologizes to them as inadequate (xiii. 22). It was now long since they themselves had suffered seriously for their faith (x. 32 f.); but others had recently been harassed even to the point of imprisonment (xiii. 3); and the writer's very impatience to hurry to their side implies that the crisis was both sudden and urgent. The finished form of the epistle's argument is sometimes urged to prove that it was not originally an epistle at all, written more or less on the spur of the moment, but a literary composition, half treatise and half homily, to which its author—as an afterthought—gave the suggestion of being a Pauline epistle by adding the personal matter in ch. xiii. (so W. Wrede, *Das literarische Rätsel des Hebräerbriefs*, 1906, pp. 70-73). The latter part of this theory fails to explain why the Pauline origin was not made more obvious, e.g. in an opening address. But even the first part of it overlooks the probability that our author was here only fusing into a fresh form materials often used before in his oral ministry of Christian instruction.

Many attempts have been made to identify the home of the Hellenistic Christians addressed in this epistle. For Alexandria little can be urged save a certain strain of "Alexandrine" idealism and allegorism, mingling with the more Palestinian realism which marks the references to Christ's sufferings, as well as the eschatology, and recalling many a passage in Philo. But Alexandrinism was a mode of thought diffused throughout the Eastern Mediterranean, and the divergences from Philo's spirit are as notable as the affinities (cf. Milligan, *ut supra*, 203 ff.). For Rome there is more to be said, in view of the references to Timothy and to "them of Italy" (xiii. 23 f.); and the theory has found many supporters. It usually contemplates a special Jewish-Christian house-church (so Zahn), like those which Paul salutes at the end of Romans, e.g. that meeting in the house of Prisca and Aquila (xvi. 5); and Harnack has gone so far as to suggest that they, and especially Prisca, actually wrote our epistle. There is, however, really little that points to Rome in particular, and a good deal that points away from it. The words in xii. 4, "Not yet unto blood have ye resisted," would ill suit Rome after the Neronian "bath of blood" in A.D. 64 (as is usually held), save at a date too late to suit the reference to Timothy. Nor does early currency in Rome prove that the epistle was written to Rome, any more than do the words "they of Italy salute you." This clause must in fact be read in the light of the reference to Timothy, which suggests that he had been in prison in Rome and was about to return, possibly in the writer's company, to the region which was apparently the headquarters of both. Now this in Timothy's case, as far as we can trace his steps, was Ephesus; and it is natural to ask whether it will not suit all the conditions of the problem. It suits those of the readers,¹ as analysed above; and it has the merit of suggesting to us as author the very person of all those described in the New Testament who seems most capable of the task, Apollos, the learned Alexandrian (Acts xviii. 24 ff.), connected with Ephesus and with Paul and his circle (cf. 1 Cor. xvi. 12), yet having his own distinctive manner of presenting the Gospel (1 Cor. iv. 6). That Apollos visited Italy at any rate once during Paul's imprisonment in Rome is a reasonable inference from Titus iii. 13 (see PAUL); and if so, it is quite natural that he should be there again about the time of Paul's martyrdom. With that event it is again natural to connect Timothy's imprisonment, his release from which our author records in closing; while the news of Jewish success in Paul's case would enhance any tendency among Asian Jewish Christians to shirk "boldness" of confession (x. 23, 35, 38 f.), in fear of

¹ i.e. a house-church of upper-class Jewish Christians, not fully in touch with the attitude even of their own past and present "leaders" (xiii. 7, 17), as distinct from the local church generally (xiii. 24). The Gospel had reached them, as also the writer himself (cf. Acts xviii. 25), through certain bearers of the Lord (ii. 3), not necessarily apostles.

further aggression from their compatriots. On the chronology adopted in the article PAUL, this would yield as probable date for the epistle A.D. 61-62. The place of writing would be some spot in Italy ("they of Italy salute you") outside Rome, probably a port of embarkation for Asia, such as Brundisium.

Be this as it may, the epistle is of great historical importance, as reflecting a crisis inevitable in the development of the Jewish-Christian consciousness, when a definite choice between the old and the new form of Israel's religion had to be made, both for internal and external reasons. It seems to follow directly on the situation implied by the appeal of James to Israel in dispersion, in view of Messiah's winnowing-fan in their midst (l. 1-4, ii. 1-7, v. 1-6, and especially v. 7-11). It may well be the immediate antecedent of that revealed in 1 Peter, an epistle which perhaps shows traces of its influence (e.g. in i. 2, "sprinkling of the blood of Jesus Christ," cf. Heb. ix. 13 f., x. 22, xii. 24). It is also of high interest theologically, as exhibiting, along with affinities to several types of New Testament teaching (see СТАРХИН), a type all its own, and one which has had much influence on later Christian thought (cf. Milligan, *ut supra*, ch. ix.). Indeed, it shares with Romans the right to be styled "the first treatise of Christian theology."

Literature.—The older literature may be seen in the great work of F. Bleek, *Der Brief an die Hebräer* (1828-1840), still a valuable storehouse of material, while Bleek's later views are to be found in a posthumous work (Elberfeld, 1868); also in Franz Delitzsch's *Commentary* (Edinburgh, 1868). The more recent literature is given in G. Milligan, *The Theology of the Epistle of the Hebrews* (1899), a useful summary of all bearing on the epistle, and in the large New Testament Introductions and Biblical Theologies. See also Hastings's *Dict. of the Bible*, the *Encycl. Biblica* and T. Zahn's article in *Hauck's Realencyklopädie*. (J. V. B.)

HEBRIDES, THE, or WESTERN ISLES, a group of islands off the west coast of Scotland. They are situated between 55° 35' and 58° 30' N. and 5° 26' and 8° 40' W. Formerly the term was held to embrace not only all the islands off the Scottish western coast, including the islands in the Firth of Clyde, but also the peninsula of Kintyre, the Isle of Man and the Isle of Rathlin, off the coast of Antrim. They have been broadly classified into the Outer Hebrides and the Inner Hebrides, the Minch and Little Minch dividing the one group from the other. Geologically, they have also been differentiated as the Gneiss Islands and the Trap Islands. The Outer Hebrides being almost entirely composed of gneiss the epithet suitably serves them, but, strictly speaking, only the more northerly of the Inner Hebrides may be distinguished as Trap Islands. The chief islands of the Outer Hebrides are Lewis-with-Harris (or Long Island), North Uist, Benbecula, South Uist, Barra, the Shianta, St Kilda and the Flannan Isles, or Seven Hunters, an uninhabited group, about 30 m. N.W. of Gallon Head in Lewis. Of these the Lewis portion of Long Island, the Shianta and the Flannan belong to the county of Ross and Cromarty, and the remainder to Inverness-shire. The total length of this group, from Barra Head to the Butt of Lewis, is 130 m., the breadth varying from less than 1 m. to 30 m. The Inner Hebrides are much more scattered and principally include Skye, Small Isles (Canna, Sanday, Rum, Egg and Muck), Coll, Tyree, Lismore, Mull, Ulva, Staffa, Iona, Kerrera, the Slate Islands (Seil, Easdale, Luing, Shuna, Torsay), Colonsay, Oronsay, Scarba, Jura, Islay and Gigha. Of these Skye and Small Isles belong to Inverness-shire, and the rest to Argyllshire. The Hebridean islands exceed 500 in number, of which one-fifth are inhabited. Of the inhabited islands 11 belong to Ross and Cromarty, 47 to Inverness-shire, and 44 to Argyllshire, but of this total of 102 islands, one-third have a population of only 10 souls, or fewer, each. The population of the Hebrides in 1901 numbered 78,947 (or 28 to the sq. m.), of whom 41,031 were females, who thus exceeded the males by 10%, and 22,733 spoke Gaelic only and 47,666 Gaelic and English. The most populous island is Lewis-with-Harris (32,160), and next to it are Skye (13,883), Islay (6857) and Mull (4334).

Of the total area of 1,800,000 acres, or 2812 sq. m., only one-ninth is cultivated, most of the surface being moorland and mountain. The annual rainfall, particularly in the Inner

Hebrides, is heavy (4-6 in. at Stornoway) but the temperature is high, averaging for the year 47° F. Potatoes and turnips are the only root crops that succeed, and barley and oats are grown in some of the islands. Sheep-farming and cattle-raising are carried on very generally, and, with the fisheries, provide the main occupation of the inhabitants, though they profit not a little from the tourists who flock to many of the islands throughout the summer. The principal industries include distilling, slate-quarrying and the manufacture of tweeds, tartans and other woollens. There are extensive deer forests in Lewis-with-Harris, Skye, Mull and Jura. On many of the islands there are prehistoric remains and antiquities within the Christian period. The more populous islands are in regular communication with certain points of the mainland by means of steamers from Glasgow, Oban and Mallaig. The United Free Church has a strong hold on the people, but in a few of the islands the Roman Catholics have a great following. In the larger inhabited islands board schools have been established. The islands unite with the counties to which they belong in returning members to parliament (one for each shire).

History.—The Hebrides are mentioned by Ptolemy under the name of *Ἑβριδαί* and by Pliny under that of *Hebudes*, the modern spelling having, it is said, originated in a misprint. By the Norwegians they were called *Sudreyjar* or Southern Islands. The Latinized form was *Sodorense*, preserved to modern times in the title of the bishop of Sodor and Man. The original inhabitants seem to have been of the same Celtic race as those settled on the mainland. In the 6th century Scandinavian hordes poured in with their northern idolatry and lust of plunder, but in time they adopted the language and faith of the islanders. Mention is made of incursions of the vikings as early as 793, but the principal immigration took place towards the end of the 9th century in the early part of the reign of Harald Fairhair, king of Norway, and consisted of persons driven to the Hebrides, as well as to Orkney and Shetland, to escape from his tyrannous rule. Soon afterwards they began to make incursions against their mother-country, and on this account Harald fitted out an expedition against them, and placed Orkney, Shetland, the Hebrides and the Isle of Man under Norwegian government. The chief seat of the Norwegian sovereignty was Colonsay. About the year 1095 Godred Crovan, king of Dublin, Man and the Hebrides, died in Islay. His third son, Olaf, succeeded to the government about 1203, and the daughter of Olaf was married to Somerled, who became the founder of the dynasty known as Lords of the Isles. Many efforts were made by the Scottish monarchs to displace the Norwegians. Alexander II. led a fleet and army to the shores of Argyllshire in 1249, but he died on the island of Kerrera. On the other hand, Haakon IV., king of Norway, at once to restrain the independence of his jarls and to keep in check the ambition of the Scottish kings, set sail in 1263 on a great expedition, which, however, ended disastrously at Largs. Magnus, son of Haakon, concluded in 1266 a peace with the Scots, renouncing all claim to the Hebrides and other islands except Orkney and Shetland, and Alexander III. agreed to give him a sum of 4000 merks in four yearly payments. It was also stipulated that Margaret, daughter of Alexander, should be betrothed to Eric, the son of Magnus, whom she married in 1281. She died two years later, leaving an only daughter afterwards known as the Maid of Norway.

The race of Somerled continued to rule the islands, and from a younger son of the same potentate sprang the lords of Lorne, who took the patronymic of Macdougall. John Macdonald of Islay, who died about 1386, was the first to adopt the title of Lord of the Isles. He was one of the most potent of the island princes, and was married to a daughter of the earl of Strathearn, afterwards Robert II. His son, Donald of the Isles, was memorable for his rebellion in support of his claim to the earldom of Ross, in which, however, he was unsuccessful. Alexander, son of Donald, resumed the hereditary warfare against the Scottish crown; and in 1462 a treaty was concluded between Alexander's son and successor John and Edward IV. of England, by which John, his son John, and his cousin Donald Balloch, became

bound to assist King Edward and James, earl of Douglas, in subduing the kingdom of Scotland. The alliance seems to have led to no active operations. In the reign of James V. another John of Islay resumed the title of Lord of the Isles, but was compelled to surrender the dignity. The glory of the lordship of the Isles—the insular sovereignty—had departed. From the time of Bruce the Campbells had been gaining the ascendancy in Argyll. The Macleans, Macnaughtons, Macclachlans, Lamonts, and other ancient races had sunk before this favoured family. The lordship of Lorne was wrested from the Macdougalls by Robert Bruce, and their extensive possessions, with Dunstaffnage Castle, bestowed on the king's relative, Stewart, and his descendants, afterwards lords of Lorne. The Macdonalds of Sleat, the direct representatives of Somerled, though driven from Islay and deprived of supreme power by James V., still kept a sort of insular state in Skye. There were also the Macdonalds of Clanranald and Glengarry (descendants of Somerled), with the powerful houses of Macleod of Dunvegan and Macleod of Harris, M'Neill of Barra and Maclean of Mull. Sanguinary feuds continued throughout the 16th and 17th centuries among these rival clans and their dependent tribes, and the turbulent spirit was not subdued till a comparatively recent period. James VI. made an abortive endeavour to colonize Lewis. William III. and Queen Anne attempted to subsidize the chiefs in order to preserve tranquillity, but the wars of Montrose and Dundee, and the Jacobite insurrections of 1715 and 1745, showed how futile were all such efforts. It was not till 1748, when a decisive blow was struck at the power of the chiefs by the abolition of heritable jurisdictions, and the appointment of sheriffs in the different districts, that the arts of peace and social improvement made way in these remote regions. The change was great, and at first not unmixed with evil. A new system of management and high rents were imposed, in consequence of which numbers of the tacksmen, or large tenants, emigrated to North America. The exodus continued for many years. Sheep-farming on a large scale was next introduced, and the crofters were thrust into villages or barren corners of the land. The result was that, despite the numbers who entered the army or emigrated to Canada, the standard of civilization sank lower, and the population multiplied in the islands. The people came to subsist almost entirely on potatoes and herrings; and in 1846, when the potato blight began its ravages, nearly universal destitution ensued—embracing, over the islands generally, 70% of the inhabitants. Temporary relief was administered in the shape of employment on roads and other works; and an emigration fund being raised, from 4000 to 5000 of the people in the most crowded districts were removed to Australia. Matters, however, were not really mended, and in 1884 a royal commission reported upon the condition of the crofters of the islands and mainland. As a result of their inquiry the Crofters' Holdings Act was passed in 1886, and in the course of a few years some improvement was evident and has since been sustained.

Authorities.—Martin Martin's *Description of the Western Islands of Scotland* (1703); T. Pennant's *Tour in Scotland and Voyage to the Hebrides* (1774); James Boswell's *Tour to the Hebrides with Samuel Johnson, LL.D.* (1898); John Macculloch's *Geological Account of the Hebrides* (1819); Hugh Miller's *Cruise of the "Betsy"* (1858); W. A. Smith's *Lewisiana, or Life in the Outer Hebrides* (1874); Alexander Smith, *A Summer in Skye* (1865); Robert Buchanan, *The Hebridean Isles* (1883); C. F. Gordon-Cumming, *In the Hebrides* (1883); *Report of the Crofters' Commission* (1884); A. Goodrich-Freer, *Outer Isles* (1902); and W. C. Mackenzie, *History of the Outer Hebrides* (1903). Their history under Norwegian rule is given in the *Chronica regum Mannie et insularum*, edited, with learned notes, from the MS. in the British Museum by Professor P. A. Münch of Christiania (1860).

HEBRON (mod. *Khulū er-Rahmān*, i.e. "the friend of the Merciful One"—an allusion to Abraham), a city of Palestine some 20 m. S. by S.W. of Jerusalem. The city, which lies 3040 ft. above the sea, is of extreme antiquity (see Num. xiii. 22, and Josephus, *War*, iv. 9, 7) and until taken by the Calabites (Josh. xv. 13) bore the name Kirjath-Arba. Biblical traditions connect it closely with the patriarch Abraham and make it a "city of refuge." The town figures prominently under David as the headquarters of his early rule, the scene of Abner's murder

and the centre of Abraham's rebellion. In later days the Edomites held it for a time, but Judas Maccabaeus recovered it. It was destroyed in the great war under Vespasian. In A.D. 1167 Hebron became the see of a Latin bishop, and it was taken in 1187 by Saladin. In 1834 it joined the rebellion against Ibrahim Pasha, who took the town and pillaged it. Modern Hebron rises on the east slope of a shallow valley—a long narrow town of stone houses, the flat roofs having small stone domes. The main quarter is about 700 yds. long, and two smaller groups of houses exist north and south of this. The hill behind is terraced, and luxuriant vineyards and fruit plantations surround the place, which is well watered on the north by three principal springs, including the Well Sirah, now 'Ain Sara (2 Sam. iii. 26). Three conspicuous minarets rise, two from the *Haram*, the other in the north quarter. The population (10,000) includes Moslems and about 500 Jews. The Bedouins bring wool and camel's hair to the market; and glass bracelets, lamps and leather water-skins are manufactured in the town. The most conspicuous building is the *Haram* built over the supposed site of the cave of Machpelah. It is an enclosure measuring 112 ft. east and west by 198 north and south, surrounded with high rampart walls of masonry similar in size and dressing to that of the Jerusalem *Haram* walls. These ramparts are ascribed by architectural authorities to the Herodian period. The interior area is partly occupied by a 12th-century Gothic church, and contains six modern cenotaphs of Abraham, Isaac, Jacob, Sarah, Rebecca and Leah. The cave beneath the platform has probably not been entered for at least 600 years. The numerous traditional sites now shown round Hebron are traceable generally to medieval legendary topography; they include the Oak of Mamre (Gen. xiii. 18 R.V.) which has at various times been shown in different positions from $\frac{1}{2}$ to 2 m. from the town.

There are a British medical mission, a German Protestant mission with church and schools, and, near Abraham's Oak, a Russian mission. Since 1880 several notices of the *Haram*, within which are the tombs of the Patriarchs, have appeared.

See C. R. Conder, *Pal. Exp. Fund. Memoirs*, iii. 333, &c.; Riant, *Archives de l'Orient latin*, ii. 411, &c.; Dalton and Chaplin, *P.E.F. Quarterly Statement* (1897); Goldziher, "Das Patriarchengrab in Hebron," in *Zeitschrift d. Dm. Pal. Vereins*, xvii. (R. A. S. M.)

HECATAEUS OF ABDERA (or of Teos), Greek historian and sceptic philosopher, flourished in the 4th century B.C. He accompanied Ptolemy I. Soter in an expedition to Syria, and sailed up the Nile with him as far as Thebes (Diogenes Laërtius ix. 61). The result of his travels was set down by him in two works—*Αἰγυπτιακά* and *Ἰεραὶ Τετραβόητος*, which were used by Diodorus Siculus. According to Suidas, he also wrote a treatise on the poetry of Hesiod and Homer. Regarding his authorship of a work on the Jews (utilized by Josephus in *Contra Apionem*), it is conjectured that portions of the *Αἰγυπτιακά* were revised by a Hellenistic Jew from his point of view and published as a special work.

Fragments in C. W. Müller's *Fragmenta historicorum Graecorum*.

HECATAEUS OF MILETUS (6th-5th century B.C.), Greek historian, son of Hegesander, flourished during the time of the Persian invasion. After having travelled extensively, he settled in his native city, where he occupied a high position, and devoted his time to the composition of geographical and historical works. When Aristagoras held a council of the leading Ionians at Miletus, to organize a revolt against the Persian rule, Hecataeus in vain tried to dissuade his countrymen from the undertaking (Herodotus v. 36, 125). In 494, when the defeated Ionians were obliged to sue for terms, he was one of the ambassadors to the Persian satrap Artaphernes, whom he persuaded to restore the constitution of the Ionic cities (Diod. Sic. x. 25). He is by some credited with a work entitled *Ἰῆς περίηλος* ("Travels round the Earth"), in two books, one on Europe, the other on Asia, in which were described the countries and inhabitants of the known world, the account of Egypt being especially comprehensive; the descriptive matter was accompanied by a map, based upon Anaximander's map of the earth, which he corrected and enlarged. The authenticity of the work is, however,

strongly attacked by J. Wells in the *Journal of Hellenic Studies*, xix. pt. i. 1909. The only certainly genuine work of Hecataeus was the *Γεωγραφία* or *Ἱστορία*, a systematic account of the traditions and mythology of the Greeks. He was probably the first to attempt a serious prose history and to employ critical method to distinguish myth from historical fact, though he accepts Homer and the other poets as trustworthy authority. Herodotus, though he once at least controverts his statements, is indebted to Hecataeus not only for facts, but also in regard of method and general scheme, but the extent of the debt depends on the genuineness of the *Ἰῆς περίηλος*.

See fragments in C. W. Müller, *Fragmenta historicorum Graecorum*, l.; H. Berger, *Geschichte der wissenschaftlichen Erdkunde der Griechen* (1903); E. H. Bunbury, *History of Ancient Geography*, i.; W. Mure, *History of Greek Literature*, iv.; especially J. V. Pfaelsch, *Hekataios als Herodots Quelle zur Geschichte Vorderasiens*. Beiträge zur alten Geschichte (Klio), iv. 193 seq. (1904), and J. Wells in *Journ. Hell. Stud.*, as above.

HECATE (Gr. 'Ἑκάτη, "she who works from afar"), a goddess in Greek mythology. According to the generally accepted view, she is of Hellenic origin, but Farnell regards her as a foreign importation from Thrace, the home of Bendis, with whom Hecate has many points in common. She is not mentioned in the *Iliad* or the *Odyssey*, but in Hesiod (*Theogony*, 409) she is the daughter of the Titan Perses and Asterie, in a passage which may be a later interpolation by the Orphists (for other genealogies see Steuding in Roscher's *Lexikon*). She is there represented as a mighty goddess, having power over heaven, earth and sea; hence she is the bestower of wealth and all the blessings of daily life. The range of her influence is most varied, extending to war, athletic games, the tending of cattle, hunting, the assembly of the people and the law-courts. Hecate is frequently identified with Artemis, an identification usually justified by the assumption that both were moon-goddesses. Farnell, who regards Artemis as originally an earth-goddess, while recognizing a "genuine lunar element" in Hecate from the 5th century, considers her a chthonian rather than a lunar divinity (see also Warr in *Classical Review*, ix. 390). He is of opinion that neither borrowed much from, nor exercised much influence on, the cult and character of the other.

Hecate is the chief goddess who presides over magic arts and spells, and in this connexion she is the mother of the sorceresses Circe and Medea. She is constantly invoked, in the well-known idyll (ii.) of Theocritus, in the incantation to bring back a woman's faithless lover. As a chthonian power, she is worshipped at the Samothracian mysteries, and is closely connected with Demeter. Alone of the gods besides Helios, she witnessed the abduction of Persephone, and, torch in hand (a natural symbol for the moon's light, but see Farnell), assisted Demeter in her search for her daughter. On moonlight nights she is seen at the cross-roads (hence her name *τριάδις*, Lat. *Trivia*) accompanied by the dogs of the Styx and crowds of the dead. Here, on the last day of the month, eggs and fish were offered to her. Black puppies and she-lambs (black victims being offered to chthonian deities) were also sacrificed (Schol. on Theocritus ii. 12). Pillars like the *Hermæ*, called *Hecataea*, stood, especially in Athens, at cross-roads and doorways, perhaps to keep away the spirits of evil. Like Artemis, Hecate is also a goddess of fertility, presiding especially over the birth and the youth of wild animals, and over human birth and marriage. She also attends when the soul leaves the body at death, and is found near graves, and on the hearth, where the master of the house was formerly buried. It is to be noted that Hecate plays little or no part in mythological legend. Her worship seems to have flourished especially in the wilder parts of Greece, such as Samothrace and Thessaly, in Caria and on the coasts of Asia Minor. In Greece proper it prevailed on the east coast and especially in Aegina, where her aid was invoked against madness.

In older times Hecate is represented as single-formed, clad in
 1 J. B. Bury, in *Classical Review*, iii. p. 416, suggests that the name means "dog," against which see J. H. Vince, *ib.* iv. p. 47. G. C. Warr, *ib.* ix. 390, takes the Hesiodic Hecate to be a moon-goddess, daughter of the sun-god Peneus.

a long robe, holding burning torches; later she becomes *triformis*, "triple-formed," with three bodies standing back to back—corresponding, according to those who regard her as a moon-goddess, to the new, the full and the waning moon. In her six hands are torches, sometimes a snake, a key (as wardress of the lower world), a whip or a dagger; her favourite animal was the dog, which was sacrificed to her—an indication of her non-Hellenic origin, since this animal very rarely fills this part in genuine Greek ritual.

See H. Steuding in Roscher's *Lexikon*, where the functions of Hecate are systematically derived from the conception of her as a moon-goddess; L. R. Farnell, *Cults of the Greek States*, ii., where this view is examined; P. Paris in Daremberg and Saglio's *Dictionnaire des antiquités*; O. Gruppe, *Griechische Mythologie*, ii. (1906) p. 1288.

HECATOMB (Gr. *ἑκατόβη* from *ἑκατόν*, a hundred, and *βόη*, an ox), originally the sacrifice of a hundred oxen in the religious ceremonies of the Greeks and Romans; later a large number of any kind of animals devoted for sacrifice. Figuratively, "hecatomb" is used to describe the sacrifice or destruction by fire, pest, disease or the sword of any large number of persons or animals; and also of the wholesale destruction of inanimate objects, and even of mental and moral attributes.

HECATO OF RHODES, Greek Stoic philosopher and disciple of Panaetius (Cicero, *De officiis*, iii. 15). Nothing else is known of his life, but it is clear that he was eminent amongst the Stoics of the period. He was a voluminous writer, but nothing remains. A list is preserved by Diogenes, who mentions works on *Duty*, *Good*, *Virtues*, *Ends*. The first, dedicated to Tubero, is eulogized by Cicero in the *De officiis*, and Seneca refers to him frequently in the *De beneficiis*. According to Diogenes Laërtius, he divided the virtues into two kinds, those founded on scientific intellectual principles (i.e. wisdom and justice), and those which have no such basis (e.g. temperance and the resultant health and vigour). Cicero shows that he was much interested in casuistical questions, as, for example, whether a good man who had received a coin which he knew to be bad was justified in passing it on to another. On the whole, his moral attitude is cynical, and he is inclined to regard self-interest as the best criterion. This he modifies by explaining that self-interest is based on the relationships of life; a man needs money for the sake of his children, his friends and the state whose general prosperity depends on the wealth of its citizens. Like the earlier Stoics, Cleanthes and Chrysippus, he held that virtue may be taught. (See STOICS and PANAETIUS.)

HECKER, FRIEDRICH FRANZ KARL (1811–1881), German revolutionist, was born at Eichersheim in the Palatinate on the 28th of September 1811, his father being a revenue official. He studied law with the intention of becoming an advocate, but soon became absorbed in politics. On entering the Second Chamber of Baden in 1842, he at once began to take part in the opposition against the government, which assumed a more and more openly Radical character, and in the course of which his talents as an agitator and his personal charm won him wide popularity and influence. A speech, denouncing the projected incorporation of Schleswig and Holstein with Denmark, delivered in the Chamber of Baden on the 6th of February 1845, spread his fame beyond the limits of his own state, and his popularity was increased by his expulsion from Prussia on the occasion of a journey to Stettin. After the death of his more moderate-minded friend Adolf Sander (March 9th, 1845), Hecker's tone towards the government became more and more bitter. In spite of the shallowness and his culture and his extremely weak character, he enjoyed an ever-increasing popularity. Even before the outbreak of the revolution he included Socialistic claims in his programme. In 1847 he was temporarily occupied with ideas of emigration, and with this object made a journey to Algiers, but returned to Baden and resumed his former position as the Radical champion of popular rights, later becoming president of the *Volksverein*, where he was destined to fall still further under the influence of the agitator Gustav von Struve. In conjunction with Struve he drew up the Radical programme carried at the great Liberal meeting held at Offenburg on the 12th of September 1847 (entitled "Thirteen Claims put forward

by the People of Baden"). In addition to the Offenburg programme, the *Sturmpetition* of the 1st of March 1848 attempted to extort from the government the most far-reaching concessions. But it was in vain that on becoming a deputy Hecker endeavoured to carry out its impracticable provisions. He had to yield to the more moderate majority, but on this account was driven still further towards the Left. The proof lies in the new Offenburg demands of the 19th of March, and in the resolution moved by Hecker in the preliminary parliament of Frankfurt that Germany should be declared a republic. But neither in Baden nor Frankfurt did he at any time gain his point.

This double failure, combined with various energetic measures of the government, which were indirectly aimed at him (e.g. the arrest of the editor of the *Constanzeer Seebatt*, a friend of Hecker's, in Karlsruhe station on the 8th of April), inspired Hecker with the idea of an armed rising under pretext of the foundation of the German republic. The 9th to the 11th of April was secretly spent in preliminaries. On the 12th of April Hecker and Struve sent a proclamation to the inhabitants of the *Seckreis* and of the Black Forest "to summon the people who can bear arms to Donaueschingen at mid-day on the 14th, with arms, ammunition and provisions for six days." They expected 70,000 men, but only a few thousand appeared. The grand-ducal government of the *Seckreis* was dissolved, and Hecker gradually gained reinforcements. But friendly advisers also joined him, pointing out the risks of his undertaking. Hecker, however, was not at all ready to listen to them; on the contrary, he added to violence an absurd defiance, and offered an amnesty to the German princes on condition of their retiring within fourteen days into private life. The troops of Baden and Hesse marched against him, under the command of General Friedrich von Gagern, and on the 20th of April they met near Kandern, where Gagern was killed, it is true, but Hecker was completely defeated.

Like many of the revolutionaries of that period, Hecker retired to Switzerland. He was, it is true, again elected to the Chamber of Baden by the circle of Thiengen, but the government, no longer willing to respect his immunity as a deputy, refused its ratification. On this account Hecker resolved in September 1848 to emigrate to North America, and obtained possession of a farm near Belleville in the state of Illinois.

During the second rising in Baden in the spring of 1849 he again made efforts to obtain a footing in his own state, but without success. He only came as far as Strassburg, but had to retreat before the victories of the Prussian troops over the Baden insurgents.

On his return to America he won some distinction during the Civil War as colonel of a regiment which he had himself got together on the Federal side in 1861 and 1864. It was with great joy that he heard of the union of Germany brought about by the victory over France in 1870–71. It was then that he made his famous festival speech at St Louis, in which he gave an animated expression to the enthusiasm of the German Americans for their newly-united fatherland. He received a less favourable impression during a journey he made in Germany in 1873. He died at St Louis on the 24th of March 1881.

Hecker was always very much beloved of all the German democrats. The song and the hat named after him (the latter a broad slouch hat with a feather) became famous as the symbols of the middle-classes in revolt. In America, too, he had won great esteem, not only on political grounds but also for his personal qualities.

See F. Hecker, *Die Erhebung des Volkes in Baden für die deutsche Republik* (Baden, 1848); F. Hecker, *Reden und Vorträge* (Neustadt a. d. H., 1872); F. v. Weech, *Badische Biographien*, iv. (1891); L. Mathy, *Aus dem Nachlasse von K. Maty, Briefe aus den Jahren 1846–1848* (Leipzig, 1898).

HECKER, ISAAC THOMAS (1819–1888), American Roman Catholic priest, the founder of the "Paulist Fathers," was born in New York City, of German immigrant parents, on the 18th of December 1819. When barely twelve years of age, he had to go to work, and pushed a baker's cart for his elder brothers, who had a bakery in Rutgers Street. But he studied

at every possible opportunity, becoming immersed in Kant's *Critique of Pure Reason*, and while still a lad took part in certain politico-social movements which aimed at the elevation of the working man. It was at this juncture that he met Orestes Brownson, who exercised a marked influence over him. Isaac was deeply religious, a characteristic for which he gave much credit to his prayerful mother, and remained so amid all the reading and agitating in which he engaged. Having grown into young manhood, he joined the Brook Farm movement, and in that colony he tarried some six months. Shortly after leaving it (in 1844) he was baptized into the Roman Catholic Church by Bishop McCloskey of New York. One year later he was entered in the novitiate of the Redemptorists in Belgium, and there he cultivated to a high degree the spirit of lofty mystical piety which marked him through life.

Ordained a priest in London by Wiseman in 1849, he returned to America, and worked until 1857 as a Redemptorist missionary. With all his mysticism, Isaac Hecker had the wide-awake mind of the typical American, and he perceived that the missionary activity of the Catholic Church in the United States must remain to a large extent ineffective unless it adopted methods suited to the country and the age. In this he had the sympathy of four fellow Redemptorists, who like himself were of American birth and converts from Protestantism. Acting as their agent, and with the consent of his local superiors, Hecker went to Rome to beg of the Rector Major of his Order that a Redemptorist novitiate might be opened in the United States, in order thus to attract American youths to the missionary life. In furtherance of this request, he took with him the strong approval of some members of the American hierarchy. The Rector Major, instead of listening to Father Hecker, expelled him from the Order for having made the journey to Rome without sufficient authorization. The outcome of the trouble was that Hecker and the other four American Redemptorists were permitted by Pius IX. in 1858 to form the separate religious community of the Paulists. Hecker trained and governed this community in spiritual exercises and mission-preaching until his death in New York City, after seventeen years of suffering, on the 22nd of December 1888. He founded and was the director of the Catholic Publication Society, was the founder, and from 1865 until his death the editor, of the *Catholic World*, and wrote *Questions of the Soul* (1855), *Aspirations of Nature* (1857), *Catholicity in the United States* (1879) and *The Church and the Age* (1888).

The name of Hecker is closely associated with that of "Americanism." To understand this movement it is necessary to comprehend the tendency of events in Catholic Europe rather than in America itself. The steady decline in the power and influence of French Catholicism since shortly after 1870 is the most remarkable feature of the history of the Third Republic. Not only did the French State pass laws bearing more and more stringently on the Church, under each succeeding ministry, but the bulk of the people acquiesced in the policy of its legislators. The clergy, if not Catholicism, was rapidly losing its hold over the once Catholic nation. Observing this fact, and encouraged by the action of Leo XIII., who, in 1892 called on French Catholics loyally to accept the Republic, a body of vigorous young French priests set themselves to check the disaster. They studied the causes which produced it. These causes, they considered to be, first, the clergy's predominant sympathy with the monarchists, and in its undisguised hostility to the Republic; secondly, the Church's aloofness from modern men, methods and thought. The progressive party believed that there was too little cultivation of individual, independent character, while too much stress was laid upon what might be called the mechanical or routine side of religion. The party perceived, too, that Catholicism was making scarcely any use of modern aggressive modes of propaganda; that, for example, the Church took but an insignificant part in social movements, in the organization of clubs for social study, in the establishing of settlements and similar philanthropic endeavour. Lack of adaptability to modern needs expresses in short the deficiencies in Catholicism which these men endeavoured to correct. They began a domestic apostolate which had for one of its rallying cries: "*Allons au peuple*."—"Let us go to the people." They agitated for the inauguration of social works, for a more intimate mingling of priests with the people, and for general cultivation of personal initiative, both in clergy and in laity.

Not unnaturally, they looked for inspiration to America. There they saw a vigorous Church among a free people, with priests publicly respected, and with a note of aggressive zeal in every

project of Catholic enterprise. From the American priesthood, Father Hecker stood out conspicuous for sturdy courage, deep interior piety, an assertive self-initiative and immense love of modern times and modern liberty. So they took Father Hecker for a kind of patron saint. His biography (New York, 1891), written in English by the Paulist Father Elliott, was translated into French (1897), and speedily became the book of the hour. Under the inspiration of Father Hecker's life and character, the more spirited section of the French clergy undertook the task of persuading their fellow-priests loyally to accept the actual political establishment, and then, breaking out of their isolation, to put themselves in touch with the intellectual life of the country, and take an active part in the work of social amelioration.

In 1897 the movement received an impetus—and a warning—when Mgr O'Connell, former Rector of the American College in Rome, spoke on behalf of Father Hecker's ideas at the Catholic Congress in Friburg. The conservatives took alarm at what they considered to be symptoms of pernicious modernism or "Liberalism." Did not the watchword "*Allons au peuple*" savour of heresy? Did it not tend toward breaking down the divinely established distinction between the priest and the layman, and conceding something to the laity in the management of the Church? The insistence upon individual initiative was judged to be incompatible with the fundamental principle of Catholicism, obedience to authority. Moreover, the conservatives were, almost to a man, anti-republicans who distrusted and disliked the democratic abbés. Complaints were sent to Rome. A violent polemic against the new movement was launched in Abbé Maignan's *Le père Hecker, est-il un saint?* (1898). Repugnance to American tendencies and influences had a strong representation in the Curia and in powerful circles in Rome. Leo XIII. was extremely reluctant to pronounce any strictures upon American Catholics, of whose loyalty to the Roman See, and to their faith, he had often spoken in terms of high approbation. But he yielded, in a measure, to the pressure brought to bear upon him, and, early in February 1899, addressed to Cardinal Gibbons the Brief *Testem Benevolentia*. This document contained a condemnation of the following doctrines or tendencies: (a) undue insistence on interior initiative in the spiritual life, as leading to disobedience; (b) attacks on religious vows, and disparagement of the value in the present age, of religious orders; (c) minimizing Catholic doctrine; (d) minimizing the importance of spiritual direction. The brief did not assert that any unsound doctrine on the above points had been held by Hecker or existed among Americans. Its tenour was, that if such opinions did exist, the Pope called upon the hierarchy to eradicate the evil. Cardinal Gibbons and many other prelates replied to Rome. With all but unanimity, they declared that the incriminated opinions had no existence among American Catholics. It was well known that Hecker never had countenanced the slightest departure from Catholic principles in their fullest and most strict application. The disturbance caused by the condemnation was slight; almost the entire laity, and a considerable part of the clergy, never understood what the noise was about. The affair was soon forgotten, but the result was to strengthen the hands of the conservatives in France. (J. J. F.)

HECKMONDWIKE, an urban district in the Spen Valley parliamentary division of the West Riding of Yorkshire, England, 8 m. S.S.E. of Bradford, on the Lancashire & Yorkshire, Great Northern, and London & North-Western railways. Pop. (1901), 9459. Like the town of Dewsbury, on the south-east, it is an important centre of the blanket and carpet manufactures, and there are also machine works, dye works and iron foundries. Coal is extensively wrought in the vicinity.

HECTOR, in Greek mythology, son of Priam and Hecuba, the husband of Andromache. Like Paris and other Trojans, he had an Oriental name, Darius. In Homer he is represented as an ideal warrior, the champion of the Trojans and the mainstay of the city. His character is drawn in most favourable colours as a good son, a loving husband and father, and a trusty friend. His leave-taking of Andromache in the sixth book of the *Iliad*, and his departure to meet Achilles for the last time, are most touchingly described. He is an especial favourite of Apollo; and later poets even describe him as son of that god. His chief exploits during the war were his defence of the wounded Sarpedon, his fight with Ajax, son of Telamon (his particular enemy), and the storming of the Greek ramparts. When Achilles, enraged with Agamemnon, deserted the Greeks, Hector drove them back to their ships, which he almost succeeded in burning. Patroclus, the friend of Achilles, who came to the help of the Greeks, was slain by Hector with the help of Apollo. Then Achilles, to revenge his friend's death, returned to the war, slew Hector, dragged his body behind his chariot to the camp, and afterwards round the tomb of Patroclus. Aphrodite and Apollo preserved

it from corruption and mutilation. Priam, guarded by Hermes, went to Achilles and prevailed on him to give back the body, which was buried with great honour. Hector was afterwards worshipped in the Troad by the Boeotian tribe Gephyraei, who offered sacrifices at his grave.

HECUBA (Gr. Ἑκάβη), wife of Priam, daughter of the Phrygian king Dymas (or of Cisseus, or of the river-god Sangarius). According to Homer she was the mother of nineteen of Priam's fifty sons. When Troy was captured and Priam slain, she was made prisoner by the Greeks. Her fate is told in various ways, most of which connect her with the promontory Cynossema, on the Thracian shore of the Hellespont. According to Euripides (in the *Hecuba*), her youngest son Polydorus had been placed during the siege of Troy under the care of Polymestor, king of Thrace. When the Greeks reached the Thracian Chersonese on their way home Hecuba discovered that her son had been murdered, and in revenge put out the eyes of Polymestor and murdered his two sons. She was acquitted by Agamemnon; but, as Polymestor foretold, she was turned into a dog, and her grave became a mark for ships (Ovid, *Métam.* xiii. 399-575; Juvenal x. 271 and Mayor's note). According to another story, she fell to the lot of Odysseus, as a slave, and in despair threw herself into the Hellespont; or, she used such insulting language towards her captors that they put her to death (Dictys Cretensis v. 13. 16). It is obvious from the tales of Hecuba's transformation and death that she is a form of some goddess to whom dogs were sacred; and the analogy with Scylla is striking.

HEDA, WILLEM CLAAZS (c. 1594-c. 1670), Dutch painter, born at Haarlem, was one of the earliest Dutchmen who devoted himself exclusively to the painting of still life. He was the contemporary and comrade of Dirk Hals, with whom he had in common pictorial touch and technical execution. But Heda was more careful and finished than Hals, and showed considerable skill and not a little taste in arranging and colouring chased cups and beakers and tankards of precious and inferior metals. Nothing is so appetizing as his "luncheon," with rare comestibles set out upon rich plate, oysters—seldom without the cut lemon—bread, champagne, olives and pastry. Even the commoner "refection" is also not without charm, as it comprises a cut ham, bread, walnuts and beer. One of Heda's early masterpieces, dated 1623, in the Munich Pihakothek is as homely as a later one of 1651 in the Liechtenstein Gallery at Vienna. A more luxurious repast is a "Luncheon in the Augsburg Gallery," dated 1644. Most of Heda's pictures are on the European continent, notably in the galleries of Paris, Parma, Ghent, Darmstadt, Gotha, Munich and Vienna. He was a man of repute in his native city, and filled all the offices of dignity and trust in the gild of Haarlem. He seems to have had considerable influence in forming the younger Franz Hals.

HEDDLE, MATTHEW FORSTER (1828-1897), Scottish mineralogist, was born at Hoy in Orkney on the 28th of April 1828. After receiving his early education at the Edinburgh academy, he entered as a medical student at the university in that city, and subsequently studied chemistry and mineralogy at Klausthal and Freiburg. In 1851 he took his degree of M.D. at Edinburgh, and for about five years practised there. Medical work, however, possessed for him little attraction; he became assistant to Prof. Connell, who held the chair of chemistry at St Andrews, and in 1862 succeeded him as professor. This post he held until in 1880 he was invited to report on some gold mines in South Africa. On his return he devoted himself with great assiduity to mineralogy, and formed one of the finest collections by means of personal exploration in almost every part of Scotland. His specimens are now in the Royal Scottish Museum at Edinburgh. It had been his intention to publish a comprehensive work on the mineralogy of Scotland. This he did not live to complete, but the MSS. fell into able hands, and *The Mineralogy of Scotland*, in 2 vols., edited by J. G. Goodchild, was issued in 1901. Heddle was one of the founders of the Mineralogical Society, and he contributed many articles on Scottish minerals, and on the geology of the northern parts of Scotland, to the

Mineralogical Magazine, as well as to the *Transactions of the Royal Society of Edinburgh*. He died on the 19th of November 1897.

See *Dr Heddle and his Geological Work* (with portrait), by J. G. Goodchild, *Trans. Edin. Geol. Soc.* (1898) vii. 317.

HEDGEHOG, or **URCHIN**, a member of the mammalian order Insectivora, remarkable for its dentition, its armature of spines and its short tail. The upper jaw is longer than the lower, the snout is long and flexible, with the nostrils narrow, and the claws are long but weak. The animal is about 10 in. long, its eyes are small, and the lower surface covered with hairs of the ordinary character. The brain is remarkable for its low development, the cerebral hemispheres being small, and marked with but one groove, and that a shallow one, on each side. The hedgehog has the power of rolling itself up into a ball, from which the spines stand out in every direction. The spines are sharp, hard and elastic, and form so efficient a defence that there are few animals able to effect a successful attack on this creature. The moment it is touched, or even hears the report of a gun, it rolls itself up by the action of the muscles beneath the skin, while this contraction effects the erection of the spines. The most important muscle is the *orbicularis panniculi*, which extends over the anterior region of the skull, as far down the body

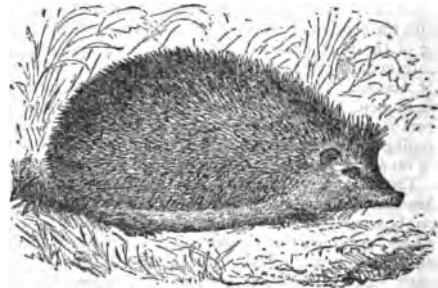

The Hedgehog (*Erinaceus europæus*).

as the ventral hairy region, and on to the tail, but three other muscles aid in the contraction.

Though insectivorous, the hedgehog is reported to have a liking for mice, while frogs and toads, as well as plants and fruits, all seem to be acceptable. It will also eat snakes, and its fondness for eggs has caused it to meet with the enmity of game-preservers; and there is no doubt it occasionally attacks leverets and game-chicks. In a state of nature it does not emerge from its retreat during daylight, unless urged by hunger or by the necessities of its young. During winter it passes into a state of hibernation, when its temperature falls considerably; having provided itself with a nest of dry leaves, it is well protected from the influences of the rain, and rolling itself up, remains undisturbed till warmer weather returns. In July or August the female brings forth four to eight young, or, according to others, two to four at a somewhat earlier period; at birth the spines, which in the adult are black in the middle, are white and soft, but soon harden, though they do not attain their full size until the succeeding spring.

The hedgehog, which is known scientifically as *Erinaceus europæus*, and is the type of the family *Erinacidae*, is found in woods and gardens, and extends over nearly the whole of Europe; and has been found at 6000 to 8000 ft. above the level of the sea. The adult is provided with thirty-six teeth; in the upper jaw are 6 incisors, 2 canines and 12 cheek-teeth, and in the lower jaw 4 incisors, 2 canines and 10 cheek-teeth. The genus is represented by about a score of species, ranging over Europe, Asia, except the Malay countries, and Africa. (R. L. *)

HEDGES AND FENCES. The object of the hedge¹ or fence (abbreviation of "defence") is to mark a boundary or to enclose

¹ Hedge is a Teutonic word, cf. Dutch *heg*, Ger. *Hecke*; the root appears in other English words, e.g. "haw," as in "hawthorn."

an area of land on which stock is kept. The hedge, *i.e.* a row of bushes or small trees, forms a characteristic feature of the scenery of England, especially in the midlands and south; it is more rarely found in other countries. Its disadvantages as a fence are that it is not portable, that it requires cutting and training while young, that it harbours weeds and vermin and that it occupies together with the ditch which usually borders it a considerable space of ground, the margins of which cannot be cultivated. For these reasons it is to some extent superseded by the fence proper, especially where shelter for cattle is not required. In Great Britain the hawthorn (*q.v.*) is by far the most important of hedge plants. Holly resembles the hawthorn in its amenability to pruning and in its prickly nature and closeness of growth, which make it an effective barrier to, and shelter for, stock, but it is less hardy and more slow-growing than the hawthorn. Hornbeam, beech, myrobalan or cherry plum and blackthorn also have their advantages, hornbeam being proof against great exposure, blackthorn thriving on poor land and possessing great impenetrability and so on. Box, yew, privet and many other plants are used for ornamental hedging; in the United States the osage orange and honey locust are favourite hedge plants. As fences, wooden posts and rails and stone walls may be conveniently used in districts where the requisite materials are plentiful. But the most modern form of fence is formed of wire strands either smooth or barbed (see BARBED WIRE), strained between iron standards or wooden or concrete posts. The wire may be interwoven with vertical strands or, if necessary, may be kept apart by iron droppers between the standards. Fences of a lighter description are machine-made with pickets of split chestnut or other wood closely set, woven with a few strands of wire; they are braced by posts at intervals.

From the fact that tramps and vagabonds frequently sleep under hedges the word has come to be used as a term of contempt, as in "hedge-priest," an inferior and illiterate kind of parson at one time existing in England and Ireland, and in "hedge-school," a low class school held in the open air, formerly very common in Ireland. From the sense of "hedge" as an enclosure or barrier the verb "to hedge" means to enclose, to form a barrier or defence, to bound or limit. As a sporting term the word is used in betting to mean protection from loss, by betting on both sides, by "laying off" on one side, after laying odds on another or vice versa. The word was early used figuratively in the sense of to avoid committing oneself.

See articles in the *Cyclopaedia of American Agriculture*, vol. i, ed. by L. H. Bailey (New York, 1907); in the *Standard Cyclopaedia of Modern Agriculture*, ed. by E. P. Wright (London, 1908-1909); and in the *Encyclopaedia of Agriculture*, vol. ii, ed. by C. E. Green and D. Young (Edinburgh, 1908).

HEDON, a municipal borough in the Holderness parliamentary division of the East Riding of Yorkshire, England, 8 m. E. of Hull by a branch of the North-Eastern railway. Pop. (1901), 2020. It stands in a low-lying, flat district bordering the Humber. It is 2 m. from the river, but was formerly reached by a navigable inlet, now dry, and was a considerable port. There is a small harbour, but the prosperity of the port has passed to Hull. The church of St Augustine is a splendid cruciform building with central tower. It is Early English, Decorated and Perpendicular, the tower being of the last period. The west front is particularly fine, and the church, with its noble proportions and lofty clerestories, resembles a cathedral in miniature. There are a manufacture of bricks and an agricultural trade. The corporation consists of a mayor, 3 aldermen and 9 councillors; and possesses a remarkable ancient mace, of 15th-century workmanship. Area, 322 acres.

According to tradition the men of Hedon received a charter of liberties from King Æthelstan, but there is no evidence to prove this or indeed to prove any settlement in the town until after the Conquest. The manor is not mentioned in the Domesday Survey, but formed part of the lordship of Holderness which William the Conqueror granted to Odo, count of Albemarle. A charter of Henry II., which is undated, contains the first certain evidence of settlement. By it the king granted to William,

count of Albemarle, free borough rights in Hedon so that his burgesses there might hold of him as freely and quietly as the burgesses of York or Lincoln held of the king. An earlier charter granted to the inhabitants of York shows that these rights included a trade gild and freedom from many dues not only in England but also in France. King John in 1200 granted a confirmation of these liberties to Baldwin, count of Albemarle, and Hawisia his wife and for this second charter the burgesses themselves paid 70 marks. In 1272 Henry III. granted to Edmund, earl of Lancaster, and Avelina his wife, then lord and lady of the manor, the right of holding a fair at Hedon on the eve, day, and morrow of the feast of St Augustine and for five following days. After the countess's death the manor came to the hands of Edward I. In 1280 it was found by an inquisition that the men of Hedon "were few and poor" and that if the town were demised at a fee-farm rent the town might improve. The grant, however, does not appear to have been made until 1346. Besides this charter Edward III. also granted the burgesses the privilege of electing a mayor and bailiffs every year. At that time Hedon was one of the chief ports in the Humber, but its place was gradually taken by Hull after that town came into the hands of the king. Hedon was incorporated by Charles II. in 1661, and James II. in 1680 gave the burgesses another charter granting among other privileges that of holding two extra fairs, but of this they never appear to have taken advantage. The burgesses returned two members to parliament in 1295, and from 1547 to 1832 when the borough was disfranchised.

See *Victoria County History, Yorkshire*; J. R. Boyle, *The Early History of the Town and Port of Hedon* (Hull and York, 1895); G. H. Park, *History of the Ancient Borough of Hedon* (Hull, 1895).

HEDONISM (Gr. ἡδονή, pleasure, from ἡδίσ, sweet, pleasant), in ethics, a general term for all theories of conduct in which the criterion is pleasure of one kind or another. Hedonistic theories of conduct have been held from the earliest times, though they have been by no means of the same character. Moreover, hedonism has, especially by its critics, been very much misrepresented owing mainly to two simple misconceptions. In the first place hedonism may confine itself to the view that, as a matter of observed fact, all men do in practice make pleasure the criterion of action, or it may go further and assert that men ought to seek pleasure as the sole human good. The former statement takes no view as to whether or not there is any absolute good: it merely denies that men aim at anything more than pleasure. The latter statement admits an ideal, *summum bonum*—namely, pleasure. The second confusion is the tacit assumption that the pleasure of the hedonist is necessarily or characteristically of a purely physical kind; this assumption is in the case of some hedonistic theories a pure perversion of the facts. Practically all hedonists have argued that what are known as the "lower" pleasures are not only ephemeral in themselves but also productive of so great an amount of consequent pain that the wise man cannot regard them as truly pleasurable; the sane hedonist will, therefore, seek those so-called "higher" pleasures which are at once more lasting and less likely to be discounted by consequent pain. It should be observed, however, that this choice of pleasures by a hedonist is conditioned not by "moral" (absolute) but by prudential (relative) considerations.

The earliest and the most extreme type of hedonism is that of the Cyrenaic School as stated by Aristippus, who argued that the only good for man is the sentient pleasure of the moment. Since (following Protagoras) knowledge is solely of momentary sensations, it is useless to try, as Socrates recommended, to make calculations as to future pleasures, and to balance present enjoyment with disagreeable consequences. The true art of life is to crowd as much enjoyment as possible into every moment. This extreme or "pure" hedonism regarded as a definite philosophic theory practically died with the Cyrenaics, though the same spirit has frequently found expression in ancient and modern, especially poetical, literature.

The confusion already alluded to between "pure" and "rational" hedonism is nowhere more clearly exemplified than in the misconceptions which have arisen as to the doctrine of

the Epicureans. To identify Epicureanism with Cyrenaicism is a complete misunderstanding. It is true that pleasure is the *summum bonum* of Epicurus, but his conception of that pleasure is profoundly modified by the Socratic doctrine of prudence and the eudaemonism of Aristotle. The true hedonist will aim at a life of enduring rational happiness; pleasure is the end of life, but true pleasure can be obtained only under the guidance of reason. Self-control in the choice of pleasures with a view to reducing pain to a minimum is indispensable. "Of all this, the beginning, and the greatest good, is prudence." The negative side of Epicurean hedonism was developed to such an extent by some members of the school (see HECÆTIAS) that the ideal life is held to be rather indifference to pain than positive enjoyment. This pessimistic attitude is far removed from the positive hedonism of Aristippus.

Between the hedonism of the ancients and that of modern philosophers there lies a great gulf. Practically speaking ancient hedonism advocated the happiness of the individual; the modern hedonism of Hume, Bentham and Mill is based on a wider conception of life. The only real happiness is the happiness of the community, or at least of the majority: the criterion is society, not the individual. Thus we pass from Egoistic to Universalistic hedonism, Utilitarianism, Social Ethics, more especially in relation to the still broader theories of evolution. These theories are confronted by the problem of reconciling and adjusting the claims of the individual with those of society. One of the most important contributions to the discussion is that of Sir Leslie Stephen (*Science of Ethics*), who elaborated a theory of the "social organism" in relation to the individual. The end of the evolution process is the production of a "social tissue" which will be "vitaly efficient." Instead, therefore, of the criterion of "the greatest happiness of the greatest number," Stephen has that of the "health of the organism." Life is not "a series of detached acts, in each of which a man can calculate the sum of happiness or misery attainable by different courses." Each action must be regarded as directly bearing upon the structure of society.

A criticism of the various hedonistic theories will be found in the article ETHICS (*ad fin.*). See also, beside works quoted under CYRENAICS, EPICURUS, &c., and the general histories of philosophy, J. S. Mackenzie, *Manual of Ethics* (3rd ed., 1897); J. H. Muirhead, *Elements of Ethics* (1892); J. Watson, *Hedonistic Theories* (1895); J. Martineau, *Types of Ethical Theory* (2nd ed., 1886); F. H. Bradley, *Ethical Studies* (1876); H. Sidgwick, *Methods of Ethics* (6th ed., 1901); Jas. Seth, *Ethical Principles* (3rd ed., 1898); other works quoted under ETHICS.

HEEL (1) (O. Eng. *hēla*, cf. Dutch *hied*; a derivative of O. Eng. *hoh*, hough, hock), that part of the foot in man which is situated below and behind the ankle; by analogy, the calcaneal part of the tarsus in other vertebrates. The heel proper in digitigrades and ungulates is raised off the ground and is commonly known as the "knee" or "hock," while the term "heel" is applied to the hind hoofs. (2) (A variant of the earlier *hield*; cf. Dutch *hellen*, for *helden*), to turn over to one side, especially of a ship. It is this word probably, in the sense of "tip-up," used particularly of the tilting or tipping of a cask or barrel of liquor, that explains the origin of the expression "no heel-taps," a direction to the drinkers of a toast to drain their glasses and leave no dregs remaining. "Tap" is a common word for liquor, and a cask is said to be "heeled" when it is tipped and only dregs or muddy liquor are left. This suits the actual sense of the phrase better than the explanations which connect it with tapping the "heel" or bottom of the glass (see *Notes and Queries*, 4th series, vols. xi.-xii., and 5th series, vol. i.).

HEEM, JAN DAVIDSZVAN (or JOHANNES DE), (c. 1600—c. 1683), Dutch painter. He was, if not the first, certainly the greatest painter of still life in Holland; no artist of his class combined more successfully perfect reality of form and colour with brilliancy and harmony of tints. No object of stone or silver, no flower humble or gorgeous, no fruit of Europe or the tropics, no twig or leaf, with which he was not familiar. Sometimes he merely represented a festoon or a nosegay. More frequently he worked with a purpose to point a moral or illustrate a motto. Here

the snake lies coiled under the grass, there a skull rests on blooming plants. Gold and silver tankards or cups suggest the vanity of earthly possessions; salvation is allegorized in a chalice amidst blossoms, death as a crucifix inside a wreath. Sometimes de Heem painted alone, sometimes in company with men of his school, Madonnas or portraits surrounded by festoons of fruit or flowers. At one time he signed with initials, at others with Johannes, at others again with the name of his father joined to his own. At rare intervals he condescended to a date, and when he did the work was certainly of the best. De Heem entered the guild of Antwerp in 1635–1636, and became a burgher of that city in 1637. He steadily maintained his residence till 1667, when he moved to Utrecht, where traces of his presence are preserved in records of 1668, 1669 and 1670. It is not known when he finally returned to Antwerp, but his death is recorded in the guild books of that place. A very early picture, dated 1628, in the gallery of Gotha, bearing the signature of Johannes in full, shows that de Heem at that time was familiar with the technical habits of execution peculiar to the youth of Albert Cuyp. In later years he completely shook off dependence, and appears in all the vigour of his own originality.

Out of 100 pictures or more to be met with in European galleries scarcely eighteen are dated. The earliest after that of Gotha is a chased tankard, with a bottle, a silver cup, and a lemon on a marble table, dated 1640, in the museum of Amsterdam. A similar work of 1645, with the addition of fruit and flowers and a distant landscape, is in Lord Radnor's collection at Longford. A chalice in a wreath, with the radiant host amidst wheatsheaves grapes and flowers, is a masterpiece of 1648 in the Belvedere of Vienna. A wreath round a Madonna of life size, dated 1650, in the museum of Berlin, shows that de Heem could paint brightly and harmoniously on a large scale. In the Pinakothek at Munich is the celebrated composition of 1653, in which creepers, beautifully commingled with gourds and blackberries, twigs of orange, myrtle and peach, are enlivened by butterflies, moths and beetles. A landscape with a blooming rose tree, a jug of strawberries, a selection of fruit, and a marble bust of Pan, dated 1655, is in the Hermitage at St Petersburg; an allegory of abundance in a medallion wreathed with fruit and flowers, in the gallery of Brussels, is inscribed with de Heem's monogram, the date of 1668, and the name of an obscure artist called Lambrechts. All these pieces exhibit the master in full possession of his artistic faculties.

CORNELIUS DE HEEM, the son of Johanna, was in practice as a flower painter at Utrecht in 1658, and was still active in his profession in 1671 at the Hague. His pictures are not equal to those of his father, but they are all well authenticated, and most of them in the galleries of the Hague, Dresden, Cassel, Vienna and Berlin. In the Stuedel at Frankfurt is a fruit piece, with pot-herbs and a porcelain jug, dated 1658; another, dated 1671, is in the museum of Brussels. DAVID DE HEEM, another member of the family, entered the guild of Utrecht in 1668 and that of Antwerp in 1693. The best piece assigned to him is a table with a lobster, fruit and glasses, in the gallery of Amsterdam; others bear his signature in the museums of Florence, St Petersburg and Brunswick. It is well to guard against the fallacy that David de Heem above mentioned is the father of Jan de Heem. We should also be careful not to make two persons of the first artist, who sometimes signs Johannes, sometimes Jan Davidsz or J. D. Heem.

HEEMSKERK, JOHAN VAN (1597–1656), Dutch poet, was born at Amsterdam in 1597. He was educated as a child at Bayonne, and entered the university of Leiden in 1617. In 1621 he went abroad on the grand tour, leaving behind him his first volume of poems, *Minnekunst* (The Art of Love), which appeared in 1622. He was absent from Holland four years. He was made master of arts at Bourges in 1623, and in 1624 visited Hugo Grotius in Paris. On his return in 1625 he published *Minnepligt* (The Duty of Love), and began to practise as an advocate in the Hague. In 1628 he was sent to England in his legal capacity by the Dutch East India Company, to settle the dispute respecting Amboyna. In the same year he published

the poem entitled *Minneskunde*, or the Science of Love. He proceeded to Amsterdam in 1640, where he married Alida, sister of the statesman Van Beuningen. In 1641 he published a Dutch version of Corneille's *The Cid*, a tragi-comedy, and in 1647 his most famous work, the pastoral romance of *Balavische Arcadie*, which he had written ten years before. During the last twelve years of his life Heemskerk sat in the upper chamber of the states-general. He died at Amsterdam on the 17th of February 1656.

The poetry of Heemskerk, which fell into oblivion during the 18th century, is once more read and valued. His famous pastoral, the *Balavische Arcadie*, which was founded on the *Astrée* of Honoré d'Urfé, enjoyed a great popularity for more than a century, and passed through twelve editions. It provoked a host of more or less able imitations, of which the most distinguished were the *Dor-drechtische Arcadie* (1663) of Lambert van den Bos (1610-1698), the *Saanlandsche Arcadie* (1658) of Hendrik Sootboom (1616-1678) and the *Rotterdamse Arcadie* (1703) of Willem den Elger (d. 1703). But the original work of Heemskerk, in which a party of nymphs and shepherds go out from the Hague to Katwijk, and there indulge in poetic and pastoral discourse, surpasses all these in brightness and versatility.

HEEMSKERK, MARTIN JACOBZ (1498-1574), Dutch painter, sometimes called Van Veen, was born at Heemskerk in Holland in 1498, and apprenticed by his father, a small farmer, to Corneliss Willems, a painter at Haarlem. Recalled after a time to the paternal homestead and put to the plough or the milking of cows, young Heemskerk took the first opportunity that offered to run away, and demonstrated his wish to leave home for ever by walking in a single day the 50 miles which separate his native hamlet from the town of Delft. There he studied under a local master whom he soon deserted for John Schoreel of Haarlem. At Haarlem he formed what is known as his first manner, which is but a quaint and *ganche* imitation of the florid style brought from Italy by Mabuse and others. He then started on a wandering tour, during which he visited the whole of northern and central Italy, stopping at Rome, where he had letters for a cardinal. It is evidence of the facility with which he executed the rapid execution of a scene-painter that he was selected to co-operate with Antonio da San Gallo, Battista Franco and Francesco Salviati to decorate the triumphal arches erected at Rome in April 1536 in honour of Charles V. Vasari, who saw the battle-pieces which Heemskerk then produced, says they were well composed and boldly executed. On his return to the Netherlands he settled at Haarlem, where he soon (1540) became president of his guild, married twice, and secured a large and lucrative practice. In 1572 he left Haarlem for Amsterdam, to avoid the siege which the Spaniards laid to the place, and there he made a will which has been preserved, and shows that he had lived long enough and prosperously enough to make a fortune. At his death, which took place on the 1st of October 1574, he left money and land in trust to the orphanage of Haarlem, with interest to be paid yearly to any couple who should be willing to perform the marriage ceremony on the slab of his tomb in the cathedral of Haarlem. It was a superstition which still exists in Catholic Holland that a marriage so celebrated would secure the peace of the dead within the tomb.

The works of Heemskerk are still very numerous. "Adam and Eve," and "St Luke painting the Likeness of the Virgin and Child" in presence of a poet crowned with ivy leaves, and a parrot in a cage—an altar-piece in the gallery of Haarlem, and the "Ecce Homo" in the museum of Ghent, are characteristic works of the period preceding Heemskerk's visit to Italy. An altar-piece executed for St Lawrence of Alkmaar in 1538-1541, and composed of at least a dozen large panels, would, if preserved, have given us a clue to his style after his return from the south. In its absence we have a "Crucifixion" executed for the Riches Claires at Ghent (now in the Ghent Museum) in 1543, and the altar-piece of the Drapers Company at Haarlem, now in the gallery of the Hague, and finished in 1546. In these we observe that Heemskerk studied and repeated the forms which he had seen at Rome in the works of Michelangelo and Raphael, and in Lombardy in the frescoes of Mantegna and Giulio Romano. But he never forgot the whole his Dutch origin or the models first presented to him by

Schoreel and Mabuse. As late as 1551 his memory still served him to produce a copy from Raphael's "Madonna di Loreto" (gallery of Haarlem). A "Judgment of Momus," dated 1561, in the Berlin Museum, proves him to have been well acquainted with anatomy, but incapable of selection and insensible of grace, bold of hand and prone to daring though tawdry contrasts of colour, and fond of florid architecture. Two altar-pieces which he finished for churches at Delft in 1551 and 1559, one complete, the other a fragment, in the museum of Haarlem, a third of 1551 in the Brussels Museum, representing "Golgotha," the "Crucifixion," the "Flight into Egypt," "Christ on the Mount," and scenes from the lives of St Bernard and St Benedict, are all fairly representative of his style. Besides these we have the "Crucifixion" in the Hermitage of St Petersburg, and two "Triumphs of Silenus" in the gallery of Vienna, in which the same relation to Giulio Romano may be noted as we mark in the canvases of Rinaldo Mantua. Other pieces of varying importance are in the galleries of Rotterdam, Munich, Cassel, Brunswick, Karlsruhe, Mainz and Copenhagen. In England the master is best known by his drawings. A comparatively feeble picture by him is the "Last Judgment" in the palace of Hampton Court.

HEER, OSWALD (1809-1883), Swiss geologist and naturalist, was born at Nieder-Utzwil in Canton St Gallen on the 31st of August 1809. He was educated as a clergyman and took holy orders, and he also graduated as doctor of philosophy and medicine. Early in life his interest was aroused in entomology, on which subject he acquired special knowledge, and later he took up the study of plants and became one of the pioneers in palaeobotany, distinguished for his researches on the Miocene flora. In 1851 he became professor of botany in the university of Zurich, and he directed his attention to the Tertiary plants and insects of Switzerland. For some time he was director of the botanic garden at Zurich. In 1863 (with W. Pengelly, *Phil. Trans.*, 1862) he investigated the plant-remains from the lignite-deposits of Bovey Tracey in Devonshire, regarding them as of Miocene age; but they are now classed as Eocene. Heer also reported on the Miocene flora of Arctic regions, on the plants of the Pleistocene lignites of Dürnten on lake Zurich, and on the cereals of some of the lake-dwellings (*Die Pflanzen der Pfahlbauten*, 1866). During a great part of his career he was hampered by slender means and ill-health, but his services to science were acknowledged in 1873 when the Geological Society of London awarded to him the Wollaston medal. Dr Heer died at Lausanne on the 27th of September 1883. He published *Flora Tertiaria Helvetiae* (3 vols., 1855-1859); *Die Urwelt der Schweiz* (1865), and *Flora fossilis Arctica* (1868-1883).

HEEREN, ARNOLD HERMANN LUDWIG (1760-1842), German historian, was born on the 25th of October 1760 at Arbergen, near Bremen. He studied philosophy, theology and history at Göttingen, and thereafter travelled in France, Italy and the Netherlands. In 1787 he was appointed one of the professors of philosophy, and then of history at Göttingen, and he afterwards was chosen aulic councillor, privy councillor, &c., the usual rewards of successful German scholars. He died at Göttingen on the 6th of March 1842. Heeren's great merit as an historian was that he regarded the states of antiquity from an altogether fresh point of view. Instead of limiting himself to a narration of their political events, he examined their economic relations, their constitutions, their financial systems, and thus was enabled to throw a new light on the development of the old world. He possessed vast and varied learning, perfect calmness and impartiality, and great power of historical insight, and is now looked back to as the pioneer in the movement for the economic interpretation of history.

Heeren's chief works are: *Ideen über Politik, den Verkehr, und den Handel der vornehmsten Völker der alten Welt* (2 vols., Göttingen, 1793-1796; 4th ed., 6 vols., 1824-1826; Eng. trans., Oxford, 1833); *Geschichte des Studiums der klassischen Literatur seit dem Wiederaufleben der Wissenschaften* (2 vols., Göttingen, 1797-1802; new ed., 1822); *Geschichte der Staaten des Alterthums* (Göttingen, 1799; Eng. trans., Oxford, 1840); *Geschichte des europäischen Staatensystems* (Göttingen, 1800; 5th ed., 1830; Eng. trans., 1834); *Versuch einer Entwicklung der Folgen der Kreuzzüge* (Göttingen, 1808; French trans., Paris, 1808), a prize essay of the

Institute of France. Besides these, Heeren wrote brief biographical sketches of Johann von Müller (Leipzig, 1809); Ludwig Spittler (Berlin, 1812); and Christian Heyne (Göttingen, 1813). With Friedrich August Ukert (1780-1851) he founded the famous historical collection, *Geschichte der europäischen Staaten* (Gotha, 1819 seq.), and contributed many papers to learned periodicals.

A collection of his historical works, with autobiographical notice, was published in 15 volumes (Göttingen, 1821-1830).

HEFELÉ, KARL JOSEF VON (1809-1893), German theologian, was born at Unterkochen in Württemberg on the 15th of March 1809, and was educated at Tübingen, where in 1839 he became professor-ordinary of Church history and patristics in the Roman Catholic faculty of theology. From 1842 to 1845 he sat in the National Assembly of Württemberg. In December 1869 he was enthroned bishop of Rottenburg. His literary activity, which had been considerable, was in no way diminished by his elevation to the episcopate. Among his numerous theological works may be mentioned his well-known edition of the *Apostolic Fathers*, issued in 1830; his *Life of Cardinal Ximenes*, published in 1844 (Eng. trans., 1860); and his still more celebrated *History of the Councils of the Church*, in seven volumes, which appeared between 1855 and 1874 (Eng. trans., 1871, 1882). Hefele's theological opinions inclined towards the more liberal school in the Roman Catholic Church, but he nevertheless received considerable signs of favour from its authorities, and was a member of the commission that made preparations for the Vatican Council of 1870. On the eve of that council he published at Naples his *Causa Honoris Papae*, which aimed at demonstrating the moral and historical impossibility of papal infallibility. About the same time he brought out a work in German on the same subject. He took rather a prominent part in the discussions at the council, associating himself with Félix Dupanloup and with Georges Darboy, archbishop of Paris, in his opposition to the doctrine of infallibility, and supporting their arguments from his vast knowledge of ecclesiastical history. In the preliminary discussions he voted against the promulgation of the dogma. He was absent from the important sitting of the 18th of June 1870, and did not send in his submission to the decrees until 1871, when he explained in a pastoral letter that the dogma "referred only to doctrine given forth *ex cathedra*, and therein to the definitions proper only, but not to its proofs or explanations." In 1872 he took part in the congress summoned by the Ultramontanes at Fulda, and by his judicious use of minimizing tactics he kept his diocese free from any participation in the Old Catholic schism. The last four volumes of the second edition of his *History of the Councils* have been described as skillfully adapted to the new situation created by the Vatican decrees. During the later years of his life he undertook no further literary efforts on behalf of his church, but retired into comparative privacy. He died on the 6th of June 1893.

See Herzog-Hauck's *Realencyclopädie*, vii. 525.

HEGEL, GEORG WILHELM FRIEDRICH (1770-1831), German philosopher, was born at Stuttgart on the 27th of August 1770. His father, an official in the fiscal service of Württemberg, is not otherwise known to fame; and of his mother we hear only that she had scholarship enough to teach him the elements of Latin. He had one sister, Christiana, who died unmarried, and a brother Ludwig, who served in the campaigns of Napoleon. At the grammar school of Stuttgart, where Hegel was educated between the ages of seven and eighteen, he was not remarkable. His main productions were a diary kept at intervals during eighteen months (1785-1787), and translations of the *Antigone*, the *Manual of Epictetus*, &c. But the characteristic feature of his studies was the copious extracts which from this time onward he unremittingly made and preserved. This collection, alphabetically arranged, comprised annotations on classical authors, passages from newspapers, treatises on morals and mathematics from the standard works of the period. In this way he absorbed in their integrity the raw materials for elaboration. Yet as evidence that he was not merely receptive we have essays already breathing that admiration of the classical world which he never lost. His chief amusement was cards, and he began the habit of taking snuff.

In the autumn of 1788 he entered at Tübingen as a student of theology; but he showed no interest in theology: his sermons were a failure, and he found more congenial reading in the classics, on the advantages of studying which his first essay was written. After two years he took the degree of Ph.D., and in the autumn of 1793 received his theological certificate, stating him to be of good abilities, but of middling industry and knowledge, and especially deficient in philosophy.

As a student, his elderly appearance gained him the title "Old man," but he took part in the walks, beer-drinking and love-making of his fellows. He gained most from intellectual intercourse with his contemporaries, the two best known of whom were J. C. F. Hölderlin and Schelling. With Hölderlin Hegel learned to feel for the old Greeks a love which grew stronger as the semi-Kantianized theology of his teachers more and more failed to interest him. With Schelling like sympathies bound him. They both protested against the political and ecclesiastical inertia of their native state, and adopted the doctrines of freedom and reason. The story which tells how the two went out one morning to dance round a tree of liberty in a meadow is an anachronism, though in keeping with their opinions.

On leaving college, he became a private tutor at Bern and lived in intellectual isolation. He was, however, far from inactive. He compiled a systematic account of the fiscal system of the canton Bern, but the main factor in his mental growth came from his study of Christianity. Under the impulse given by Lessing and Kant he turned to the original records of Christianity, and attempted to construe for himself the real significance of Christ. He wrote a life of Jesus, in which Jesus was simply the son of Joseph and Mary. He did not stop to criticize as a philologist, and ignored the miraculous. He asked for the secret contained in the conduct and sayings of this man which made him the hope of the human race. Jesus appeared as revealing the unity with God in which the Greeks in their best days unwittingly rejoiced, and as lifting the eyes of the Jews from a lawgiver who metes out punishment on the transgressor, to the destiny which in the Greek conception falls on the just no less than on the unjust.

The interest of these ideas is twofold. In Jesus Hegel finds the expression for something higher than mere morality: he finds a noble spirit which rises above the contrasts of virtue and vice into the concrete life, seeing the infinite always embracing our finitude, and proclaiming the divine which is in man and cannot be overcome by error and evil, unless the man close his eyes and ears to the godlike presence within him. In religious life, in short, he finds the principle which reconciles the opposition of the temporal-mind. But, secondly, the general source of the doctrine that life is higher than all its incidents is of interest. He does not free himself from the current theology either by rational moralizing like Kant, or by bold speculative synthesis like Fichte and Schelling. He finds his panacea in the concrete life of humanity. But although he goes to the Scriptures, and tastes the mystical spirit of the medieval saints, the Christ of his conception has traits that seem borrowed from Socrates and from the heroes of Attic tragedy, who suffer much and yet smile gently on a destiny to which they were reconciled. Instead of the Hebraic doctrine of a Jesus punished for our sins, we have the Hellenic idea of a man who is calmly tranquil in the consciousness of his unity with God.

During these years Hegel kept up a slack correspondence with Schelling and Hölderlin. Schelling, already on the way to fame, kept Hegel abreast with German speculation. Both of them were intent on forcing the theologians into the daylight, and grudged them any aid they might expect from Kant's postulation of God and immortality to crown the edifice of ethics. Meanwhile, Hölderlin in Jena had been following Fichte's career with an enthusiasm with which he infected Hegel.

It is pleasing to turn from these vehement struggles of thought to a tour which Hegel in company with three other tutors made through the Bernese Oberland in July and August 1796. Of this tour he left a minute diary. He was delighted with the varied play of the waterfalls, but no glamour blinded him to the squalor of Swiss peasant life. The glaciers and the rocks called forth no

ruptures. "The spectacle of these eternally dead masses gave me nothing but the monotonous and at last tedious idea," Es ist so."

Towards the close of his engagement at Bern, Hegel had received hopes from Schelling of a post at Jena. Fortunately his friend Hölderlin, now tutor in Frankfort, secured a similar situation there for Hegel in the family of Herr Gogol, a merchant (January 1797). The new post gave him more leisure and the society he needed.

About this time he turned to questions of economics and government. He had studied Gibbon, Hume and Montesquieu in Switzerland. We now find him making extracts from the English newspapers on the Poor-Law Bill of 1796; criticising the Prussian land laws, promulgated about the same time; and writing a commentary on Sir James Steuart's *Inquiry into the Principles of Political Economy*. Here, as in contemporaneous criticisms of Kant's ethical writings, Hegel aims at correcting the abstract discussion of a topic by treating it in its systematic interconnexions. Church and state, law and morality, commerce and art are reduced to factors in the totality of human life, from which the specialists had isolated them.

But the best evidence of Hegel's attention to contemporary politics is two unpublished essays—one of them written in 1798, "On the Internal Condition of Württemberg in Recent Times, particularly on the Defects in the Magistracy," the other a criticism on the constitution of Germany, written, probably, not long after the peace of Lunéville (1801). Both essays are critical rather than constructive. In the first Hegel showed how the supineness of the committee of estates in Württemberg had favoured the usurpations of the superior officials in whom the court had found compliant servants. And though he perceived the advantages of change in the constitution of the estates, he still doubted if an improved system could work in the actual conditions of his native province. The main feature in the pamphlet is the recognition that a spirit of reform is abroad. If Württemberg suffered from a bureaucracy tempered by despotism, the Fatherland in general suffered no less. "Germany," so begins the second of these unpublished papers, "is no longer a state." Referring the collapse of the empire to the retention of feudal forms and to the action of religious animosities, Hegel looked forward to reorganization by a central power (Austria) wielding the imperial army, and by a representative body elected by the geographical districts of the empire. But such an issue, he saw well, could only be the outcome of violence—"blood and iron." The philosopher did not pose as a practical statesman. He described the German empire in its nullity as a conception without existence in fact. In such a state of things it was the business of the philosopher to set forth the outlines of the coming epoch, as they were already moulding themselves into shape, amidst what the ordinary eye saw only as the disintegration of the old forms of social life.

His old interest in the religious question reappears, but in a more philosophical form. Starting with the contrast between a natural and a positive religion, he regards a positive religion as one imposed upon the mind from without, not a natural growth crowning the round of human life. A natural religion, on the other hand, was not, he thought, the one universal religion of every clime and age, but rather the spontaneous development of the national conscience varying in varying circumstances. A people's religion completes and consecrates their whole activity: in it the people rises above its finite life in limited spheres to an infinite life where it feels itself all at one. Even philosophy with Hegel at this epoch was subordinate to religion; for philosophy must never abandon the finite in the search for the infinite. Soon, however, Hegel adopted a view according to which philosophy is a higher mode of apprehending the infinite than even religion.

At Frankfort, meanwhile, the philosophic ideas of Hegel first assumed the proper philosophic form. In a MS. of 102 quarto sheets, of which the first three and the seventh are wanting, there is preserved the original sketch of the Hegelian system, so far as the logic and metaphysics and part of the

philosophy of nature are concerned. The third part of the system—the ethical theory—seems to have been composed afterwards; it is contained in its first draft in another MS. of 30 sheets. Even these had been preceded by earlier Pythagorean constructions envisaging the divine life in divine triangles.

Circumstances soon put Hegel in the way to complete these outlines. His father died in January 1799; and the slender sum which Hegel received as his inheritance, 3154 gulden (about £260), enabled him to think once more of a studious life. At the close of 1800 we find him asking Schelling for letters of introduction to Bamberg, where with cheap living and good beer he hoped to prepare himself for the intellectual excitement of Jena. The upshot was that Hegel arrived at Jena in January 1801. An end had already come to the brilliant epoch at Jena, when the romantic poets, Tieck, Novalis and the Schlegels made it the headquarters of their fantastic mysticism, and Fichte turned the results of Kant into the banner of revolutionary ideas. Schelling was the main philosophical lion of the time; and in some quarters Hegel was spoken of as a new champion summoned to help him in his struggle with the more prosaic continuators of Kant. Hegel's first performance seemed to justify the rumour. It was an essay on the difference between the philosophic systems of Fichte and Schelling, tending in the main to support the latter. Still more striking was the agreement shown in the *Critical Journal of Philosophy*, which Schelling and Hegel wrote conjointly during the years 1802-1803. So latent was the difference between them at this epoch that in one or two cases it is not possible to determine by whom the essay was written. Even at a later period foreign critics like Cousin saw much that was alike in the two doctrines, and did not hesitate to regard Hegel as a disciple of Schelling. The dissertation by which Hegel qualified for the position of *Privatdozent* (*De orbibus planetarum*) was probably chosen under the influence of Schelling's philosophy of nature. It was an unfortunate subject. For while Hegel, depending on a numerical proportion suggested by Plato, hinted in a single sentence that it might be a mistake to look for a planet between Mars and Jupiter, Giusseppe Piazzi (*q.v.*) had already discovered the first of the asteroids (Ceres) on the 1st of January 1801. Apparently in August, when Hegel qualified, the news of the discovery had not yet reached him, but critics have made this luckless suggestion the ground of attack on a priori philosophy.

Hegel's lectures, in the winter of 1801-1802, on logic and metaphysics were attended by about eleven students. Later, in 1804, we find him with a class of about thirty, lecturing on his whole system; but his average attendance was rather less. Besides philosophy, he once at least lectured on mathematics. As he taught, he was led to modify his original system, and notice after notice of his lectures promised a text-book of philosophy—which, however, failed to appear. Meanwhile, after the departure of Schelling from Jena in the middle of 1803, Hegel was left to work out his own views. Besides philosophical studies, where he now added Aristotle to Plato, he read Homer and the Greek tragedians, made extracts from books, attended lectures on physiology, and dabbled in other sciences. On his own representation at Weimar, he was in February 1805 made a professor extraordinary, and in July 1806 drew his first and only stipend—100 thalers. At Jena, though some of his hearers became attached to him, Hegel was not a popular lecturer any more than K. C. F. Krause (*q.v.*). The ordinary student found J. F. Fries (*q.v.*) more intelligible.

Of the lectures of that period there still remain considerable notes. The language often had a theological tinge (never entirely absent), as when the "idea" was spoken of, or "the night of the divine mystery," or the dialectic of the absolute called the "course of the divine life." Still his view was growing clearer, and his difference from Schelling more palpable. Both Schelling and Hegel stand in a relation to art, but while the aesthetic model of Schelling was found in the contemporary world, where art was a special sphere and the artist a separate profession in no intimate connexion with the age and nation, the model of Hegel was found rather in those works of national

art in which art is not a part but an aspect of the common life, and the artist is not a mere individual but a concentration of the passion and power of beauty in the whole community. "Such art," says Hegel, "is the common good and the work of all. Each generation hands it on beautified to the next; each has done something to give utterance to the universal thought. Those who are said to have genius have acquired some special aptitude by which they render the general shapes of the nation their own work, one in one point, another in another. What they produce is not their invention, but the invention of the whole nation; or rather, what they find is that the whole nation has found its true nature. Each, as it were, piles up his stone. So too does the artist. Somehow he has the good fortune to come last, and when he places his stone the arch stands self-supported." Hegel, as we have already seen, was fully aware of the change that was coming over the world. "A new epoch," he says, "has arisen. It seems as if the world-spirit had now succeeded in freeing itself from all foreign objective existence, and finally apprehending itself as absolute mind." These words come from lectures on the history of philosophy, which laid the foundation for his *Phänomenologie des Geistes* (Bamberg, 1807).

On the 14th of October 1806 Napoleon was at Jena. Hegel, like Goethe, felt no patriotic shudder at the national disaster, and in Prussia he saw only a corrupt and conceited bureaucracy. Writing to his friend F. J. Niethammer (1766-1848) on the day before the battle, he speaks with admiration of the "world-soul," the emperor, and with satisfaction of the probable overthrow of the Prussians. The scholar's wish was to see the clouds of war pass away, and leave thinkers to their peaceful work. His manuscripts were his main care; and doubtful of the safety of his last despatch to Bamberg, and disturbed by the French soldiers in his lodgings, he hurried off, with the last pages of the *Phänomenologie*, to take refuge in the pro-rector's house. Hegel's fortunes were now at the lowest ebb. Without means, and obliged to borrow from Niethammer, he had no further hopes from the impoverished university. He had already tried to get away from Jena. In 1805, when several lecturers left in consequence of diminished classes, he had written to Johann Heinrich Voas (s.v.), suggesting that his philosophy might find more congenial soil in Heidelberg; but the application bore no fruit. He was, therefore, glad to become editor of the *Bamberger Zeitung* (1807-1808). Of his editorial work there is little to tell; no leading articles appeared in his columns. It was not a suitable vocation, and he gladly accepted the rectorship of the Aegidien-gymnasium in Nuremberg, a post which he held from December 1808 to August 1816. Bavaria at this time was modernizing her institutions. The school system was reorganized by new regulations, in accordance with which Hegel wrote a series of lessons in the outlines of philosophy—ethical, logical and psychological. They were published in 1840 by Rosenkranz from Hegel's papers.

As a teacher and master Hegel inspired confidence in his pupils, and maintained discipline without pedantic interference in their associations and sports. On prize-days his addresses summing up the history of the school year discussed some topic of general interest. Five of these addresses are preserved. The first is an exposition of the advantages of a classical training, when it is not confined to mere grammar. "The perfection and grandeur of the master-works of Greek and Roman literature must be the intellectual bath, the secular baptism, which gives the first and unfading tone and tincture of taste and science." In another address, speaking of the introduction of military exercises at school, he says: "These exercises, while not intended to withdraw the students from their more immediate duty, so far as they have any calling to it, still remind them of the possibility that every one, whatever rank in society he may belong to, may one day have to defend his country and his king, or help to that end. This duty, which is natural to all, was formerly recognized by every citizen, though whole ranks in the state have become strangers to the very idea of it."

On the 16th of September 1811 Hegel married Marie von

Tucher (twenty-two years his junior) of Nuremberg: She brought her husband no fortune, but the marriage was entirely happy. The husband kept a careful record of income and expenditure. His income amounted at Nuremberg to 1500 gulden (£130) and a house; at Heidelberg, as professor, he received about the same sum; at Berlin about 3000 thalers (£300). Two sons were born to them; the elder, Karl, became eminent as a historian. The younger, Immanuel, was born on the 24th of September 1816. Hegel's letters to his wife, written during his solitary holiday tours to Vienna, the Netherlands and Paris, breathe of kindly and happy affection. Hegel the tourist—recalling happy days spent together; confessing that, were it not because of his sense of duty as a traveller, he would rather be at home, dividing his time between his books and his wife; commenting on the shop windows at Vienna; describing the straw hats of the Parisian ladies—is a contrast to the professor of a profound philosophical system. But it shows that the enthusiasm which in his days of courtship moved him to verse had blossomed into a later age of domestic bliss.

In 1812 appeared the first two volumes of his *Wissenschaft der Logik*, and the work was completed by a third in 1816. This work, in which his system was for the first time presented in what, with a few minor alterations, was its ultimate shape, found some audience in the world. Towards the close of his eighth session three professorships were almost simultaneously put within his reach—at Erlangen, Berlin and Heidelberg. The Prussian offer expressed a doubt that his long absence from university teaching might have made him rusty, so he accepted the post at Heidelberg, whence Fries had just gone to Jena (October 1816). Only four hearers turned up for one of his courses. Others, however, on the encyclopaedia of philosophy and the history of philosophy drew classes of twenty to thirty. While he was there Cousin first made his acquaintance, but a more intimate relation dates from Berlin. Among his pupils was Hermann F. W. Hinrichs (s.v.), to whose *Religion in its inward Relation to Science* (1822) Hegel contributed an important preface. The strangest of his hearers was an Estonian baron, Boris d'Yrkull, who after serving in the Russian army came to Heidelberg to hear the wisdom of Hegel. But his books and his lectures were alike obscure to the baron, who betook himself by Hegel's advice to simpler studies before he returned to the Hegelian system.

At Heidelberg Hegel was active in a literary way also. In 1817 he brought out the *Encyclopädie d. philos. Wissenschaften im Grundrisse* (4th ed., Berlin, 1817; new ed., 1870) for use at his lectures. It is the only exposition of the Hegelian system as a whole which we have direct from Hegel's own hand. Besides this work he wrote two reviews for the Heidelberg *Jahrbücher*—the first on F. H. Jacobi, the other a political pamphlet which called forth violent criticism. It was entitled a *Criticism on the Transactions of the Estates of Württemberg in 1815-1816*. On the 15th of March 1815 King Frederick of Württemberg, at a meeting of the estates of his kingdom, laid before them the draft of a new constitution, in accordance with the resolutions of the congress of Vienna. Though an improvement on the old constitution, it was unacceptable to the estates, jealous of their old privileges and suspicious of the king's intentions. A decided majority demanded the restitution of their old laws, though the kingdom now included a large population to which the old rights were strange. Hegel in his essay, which was republished at Stuttgart, supported the royal proposals, and animadverted on the backwardness of the bureaucracy and the landed interests. In the main he was right; but he forgot too much the provocation they had received, the usurpations and selfishness of the governing family, and the unpatriotic character of the king.

In 1818 Hegel accepted the renewed offer of the chair of philosophy at Berlin, vacant since the death of Fichte. The hopes which this offer raised of a position less precarious than that of a university teacher of philosophy were in one sense disappointed; for more than a professor Hegel never became. But his influence upon his pupils, and his solidarity with the

Prussian government, gave him a position such as few professors have held.

In 1821 Hegel published the *Grundlinien der Philosophie des Rechts* (2nd ed., 1840; ed. G. J. B. Bolland, 1901; Eng. trans., *Philosophy of Right*, by S. W. Dyde, 1896). It is a combined system of moral and political philosophy, or a sociology dominated by the idea of the state. It turns away contemptuously and fiercely from the sentimental aspirations of reformers possessed by the democratic doctrine of the rights of the omnipotent nation. Fries is stigmatized as one of the "ringleaders of shallowness" who were bent on substituting a fancied tie of enthusiasm and friendship for the established order of the state. The disciplined philosopher, who had devoted himself to the task of comprehending the organism of the state, had no patience with feebler or more mercurial minds who recklessly laid hands on established ordinances, and set them aside where they contravened humanitarian sentiments. With the principle that whatever is real is rational, and whatever is rational is real, Hegel fancied that he had stopped the mouths of political critics and constitution-mongers. His theory was not a mere formulation of the Prussian state. Much that he construed as necessary to a state was wanting in Prussia; and some of the reforms already introduced did not find their place in his system. Yet, on the whole, he had taken his side with the government. Altenstein even expressed his satisfaction with the book. In his disgust at the crude conceptions of the enthusiasts, who had hoped that the war of liberation might end in a realm of internal liberty, Hegel had forgotten his own youthful vows recorded in verse to Hölderlin, "never, never to live in peace with the ordinance which regulates feeling and opinion." And yet if we look deeper we see that this is no worship of existing powers. It is rather due to an overpowering sense of the value of organization—a sense that liberty can never be discovered from order, that a vital interconnection between all the parts of the body politic is the source of all good, so that while he can find nothing but brute weight in an organized public, he can compare the royal person in his ideal form of constitutional monarchy to the dot upon the letter *i*. A keen sense of how much is at stake in any alteration breeds suspicion of every reform.

During his thirteen years at Berlin Hegel's whole soul seems to have been in his lectures. Between 1823 and 1827 his activity reached its maximum. His notes were subjected to perpetual revisions and additions. We can form an idea of them from the shape in which they appear in his published writings. Those on *Aesthetics*, on the *Philosophy of Religion*, on the *Philosophy of History* and on the *History of Philosophy*, have been published by his editors, mainly from the notes of his students, under their separate heads; while those on logic, psychology and the philosophy of nature are appended in the form of illustrative and explanatory notes to the sections of his *Encyclopædie*. During these years hundreds of hearers from all parts of Germany, and beyond, came under his influence. His fame was carried abroad by eager or intelligent disciples. At Berlin Henning served to prepare the intending disciple for fuller initiation by the master himself. Edward Gans (*q.v.*) and Heinrich Gustav Hotho (*q.v.*) carried the method into special spheres of inquiry. At Halle Hinrichs maintained the standard of Hegelianism amid the opposition or indifference of his colleagues.

Three courses of lectures are especially the product of his Berlin period: those on aesthetics, the philosophy of religion and the philosophy of history. In the years preceding the revolution of 1830, public interest, excluded from political life, turned to theatres, concert-rooms and picture-galleries. At these Hegel became a frequent and appreciative visitor and made extracts from the art-notes in the newspapers. In his holiday excursions, the interest in the fine arts more than once took him out of his way to see some old painting. At Vienna in 1824 he spent every moment at the Italian opera, the ballet and the picture-galleries. In Paris, in 1827, he saw Charles Kemble and an English company play Shakespeare. This familiarity with the facts of art, though neither deep nor historical, gave a freshness to his lectures on aesthetics, which, as

put together from the notes of 1820; 1823, 1826, are in many ways the most successful of his efforts.

The lectures on the philosophy of religion are another application of his method. Shortly before his death he had prepared for the press a course of lectures on the proofs for the existence of God. In his lectures on religion he dealt with Christianity, as in his philosophy of morals he had regarded the state. On the one hand he turned his weapons against the rationalistic school, who reduced religion to the modicum compatible with an ordinary worldly mind. On the other hand he criticized the school of Schleiermacher, who elevated feeling to a place in religion above systematic theology. His middle way attempts to show that the dogmatic creed is the rational development of what was implicit in religious feeling. To do so, of course, philosophy becomes the interpreter and the superior. To the new school of E. W. Hengstenberg, which regarded Revelation itself as supreme, such interpretation was an abomination.

A Hegelian school began to gather. The flock included intelligent pupils, empty-headed imitators, and romantic natures who turned philosophy into lyric measures. Opposition and criticism only served to define more precisely the adherents of the new doctrine. Hegel himself grew more and more into a belief in his own doctrine as the one truth for the world. He was in harmony with the government, and his followers were on the winning side. Though he had soon resigned all direct official connexion with the schools of Brandenburg, his real influence in Prussia was considerable, and as usual was largely exaggerated in popular estimate. In the narrower circle of his friends his birthdays were the signal for congratulatory verses. In 1826 a formal festival was got up by some of his admirers, one of whom, Herder, spoke of his categories as new gods; and he was presented with much poetry and a silver mug. In 1830 the students struck a medal in his honour, and in 1831 he was decorated by an order from Frederick William III. In 1830 he was rector of the university; and in his speech at the tricentenary of the Augsburg Confession in that year he charged the Catholic Church with regarding the virtues of the pagan world as brilliant vices, and giving the crown of perfection to poverty, continence and obedience.

One of the last literary undertakings in which he took part was the establishment of the Berlin *Jahrbücher für wissenschaftliche Kritik*, in which he assisted Edward Gans and Varnhagen von Ense. The aim of this review was to give a critical account, certified by the names of the contributors, of the literary and philosophical productions of the time, in relation to the general progress of knowledge. The journal was not solely in the Hegelian interest; and more than once, when Hegel attempted to domineer over the other editors, he was met by vehement and vigorous opposition.

The revolution of 1830 was a great blow to him, and the prospect of democratic advances almost made him ill. His last literary work, the first part of which appeared in the *Preussische Staatszeitung*, was an essay on the English Reform Bill of 1831. It contains primarily a consideration of its probable effects on the character of the new members of parliament, and the measures which they may introduce. In the latter connexion he enlarged on several points in which England had done less than many continental states for the abolition of monopolies and abuses. Surveying the questions connected with landed property, with the game laws, the poor, the Established Church, especially in Ireland, he expressed grave doubt on the legislative capacity of the English parliament as compared with the power of renovation manifested in other states of western Europe.

In 1831 cholera first entered Europe. Hegel and his family retired for the summer to the suburbs, and there he finished the revision of the first part of his *Science of Logic*. On the beginning of the winter session, however, he returned to his house in the Kupfergraben. On this occasion an altercation occurred between him and his friend Gans, who in his notice of lectures on jurisprudence had recommended Hegel's *Philosophy of Right*. Hegel, indignant at what he deemed patronage, demanded that the note should be withdrawn. On the 14th of November, after one

day's illness, he died of cholera and was buried, as he had wished, between Fichte and Solger.

Hegel in his class-room was neither imposing nor fascinating. You saw a plain, old-fashioned face, without life or lustre—a figure which had never looked young, and was now prematurely aged; the furrowed face bore witness to concentrated thought. Sitting with his snuff-box before him, and his head bent down, he looked ill at ease, and kept turning the folios of his notes. His utterance was interrupted by frequent coughing; every sentence came out with a struggle. The style was no less irregular. Sometimes in plain narrative the lecturer would be specially awkward, while in abstruse passages he seemed specially at home, rose into a natural eloquence, and carried away the hearer by the grandeur of his diction.

Philosophy.—Hegelianism is confessedly one of the most difficult of all philosophies. Every one has heard the legend which makes Hegel say, "One man has understood me, and even he has not." He abruptly hurls us into a world where old habits of thought fail us. In three places, indeed, he has attempted to exhibit the transition to his own system from other levels of thought; but in none with much success. In the introductory lectures on the philosophy of religion he gives a rationale of the difference between the modes of consciousness in religion and philosophy (between *Vorstellung* and *Begriff*). In the beginning of the *Encyclopædie* he discusses the defects of dogmatism, empiricism, the philosophies of Kant and Jacobi. In the first case he treats the formal or psychological aspect of the difference; in the latter he presents his doctrine less in its essential character than in special relations to the prominent systems of his time. The *Phenomenology of Spirit*, regarded as an introduction, suffers from a different fault. It is not an introduction—for the philosophy which it was to introduce was not then fully elaborated. Even to the last Hegel had not so externalized his system as to treat it as something to be led up to by gradual steps. His philosophy was not one aspect of his intellectual life, to be contemplated from others; it was the ripe fruit of concentrated reflection, and had become the one all-embracing form and principle of his thinking. More than most thinkers he had quietly laid himself open to the influences of his time and the lessons of history.

The *Phenomenology* is the picture of the Hegelian philosophy in the making—at the stage before the scaffolding has been removed from the building. For this reason the book is at once the most brilliant and the most difficult of Hegel's works—the most brilliant because it is to some degree an autobiography of Hegel's mind—not the abstract record of a logical evolution, but the real history of an intellectual growth; the most difficult because, instead of treating the rise of intelligence (from its first appearance in contrast with the real world to its final recognition of its presence in, and rule over, all things) as a purely subjective process, it exhibits this rise as wrought out in historical epochs, national characteristics, forms of culture and faith, and philosophical systems. The theme is identical with the introduction to the *Encyclopædie*; but it is treated in a very different style. From all periods of the world—from medieval piety and stoical pride, Kant and Sophocles, science and art, religion and philosophy—with disdain of mere chronology, Hegel gathers in the vineyards of the human spirit the grapes from which he crushes the wine of thought. The mind coming through a thousand phases of mistake and disappointment to a sense and realization of its true position in the universe—such is the drama which is consciously Hegel's own history, but is represented objectively as the process of spiritual history which the philosopher reproduces in himself. The *Phenomenology* stands to the *Encyclopædie* somewhat as the dialogues of Plato stand to the Aristotelian treatises. It contains almost all his philosophy—but irregularly and without due proportion. The personal element gives an undue prominence to recent phenomena of the philosophic atmosphere. It is the account given by an inventor of his own discovery, not the explanation of an outsider. It therefore to some extent assumes from the first the position which it proposes ultimately to reach, and gives not a proof of that position, but an account of the experience (*Erfahrung*) in which consciousness is forced from one position to another till it finds rest in *Absolute Wissen*.

The *Phenomenology* is neither mere psychology, nor logic, nor moral philosophy, nor history, but is all of these and a great deal more. It needs not distillation, but expansion and illustration from contemporary and antecedent thought and literature. It treats of the attitudes of consciousness towards reality under the six heads of consciousness, self-consciousness, reason (*Vernunft*), spirit (*Geist*), religion and absolute knowledge. The native attitude of consciousness towards existence is reliance on the evidence of the senses; but a little reflection is sufficient to show that the reality attributed to the external world is as much due to intellectual conceptions as to the senses, and that these conceptions elude us when we try to fix them. If consciousness cannot detect a permanent object outside it, so self-consciousness cannot find a permanent subject in itself. It may, like the Stoic, assert freedom by holding

also from the entanglements of real life, or like the sceptic regard the world as a delusion, or finally, as the "unhappy consciousness" (*Unglückliches Bewusstsein*), may be a recurrent falling short of a perfection which it has placed above it in the heavens. But in this isolation from the world, self-consciousness has closed its gates against the stream of life. The perception of this is reason. Reason convinced that the world and the soul are alike rational observes the external world, mental phenomena, and specially the nervous organism, as the meeting ground of body and mind. But reason finds much in the world recognizing no kindred with her, and so turning to practical activity seeks in the world the realization of her own aims. Either in a crude way she pursues her own pleasure, and finds that necessity counteracts her cravings; or she endeavours to find the world in harmony with the heart, and yet is unwilling to see fine aspirations crystallized by the act of realizing them. Finally, unable to impose upon the world either selfish or humanitarian ends, she folds her arms in pharisaic virtue, with the hope that some hidden power will give the victory to righteousness. But the world goes on in its life, heedless of the demands of virtue. The principle of nature is to live and let live. Reason abandons her efforts to mould the world, and is content to let the aims of individuals work out their results independently, only stepping in to lay down precepts for the cases where individual actions conflict, and to test these precepts by the rules of formal logic.

So far we have seen consciousness on one hand and the real world on the other. The stage of *Geist* reveals the consciousness no longer as critical and antagonistic but as the indwelling spirit of a community, as no longer isolated from its surroundings but the union of the single and real consciousness with the vital feeling that animates the community. This is the lowest stage of concrete consciousness—life, and not knowledge; the spirit inspires, but does not reflect. It is the age of unconscious morality, when the individual's life is lost in the society of which he is an organic member. But increasing culture presents new ideals, and the mind, absorbing the ethical spirit of its environment, gradually emancipates itself from conventions and superstitions. This *Aufklärung* prepares the way for the rule of conscience, for the moral view of the world as subject of a moral law. From the moral world the next step is religion; the moral law gives place to God; but the idea of God-head, too, as it first appears, is imperfect, and has to pass through the forms of nature-worship and of art before it reaches a full utterance in Christianity. Religion in this shape is the nearest step to the stage of absolute knowledge; and this absolute knowledge—"the spirit knowing itself as spirit"—is not something which leaves these other forms behind but the full comprehension of them as the organic constituents of its empire; "they are the memory and the sepulchre of its history, and at the same time the actuality, truth and certainty of its throne." Here, according to Hegel, is the field of philosophy.

The preface to the *Phenomenology* signalled the separation from Schelling—the adieu to romantic. It declared that a genuine philosophy has no kindred with the mere aspirations of artistic minds, but must earn its bread by the sweat of its brow. It sets its face against the idealism which either thundered against the world for its deficiencies, or sought something finer than reality. Philosophy is to be the science of the actual world—it is the spirit comprehending itself in its own externalizations and manifestations. The philosophy of Hegel is idealism, but it is an idealism in which every idealistic unification has its other face in the multiplicity of existence. It is realism as well as idealism, and never quits its hold on facts. Compared with Fichte and Schelling, Hegel has a sober, hard, realistic character. At a later date, with the call of Schelling to Berlin in 1841, it became fashionable to speak of Hegelianism as a negative philosophy requiring to be complemented by a "positive" philosophy which would give reality and not mere ideas. The cry was the same as that of Krug (*q.v.*), asking the philosophers who expounded the absolute to construe his pen. It was the cry of the Evangelical school for a personal Christ and not a dialectical Logos. The claims of the individual, the real, material and historical fact, it was said, had been sacrificed by Hegel to the universal, the ideal, the spiritual and the logical.

There was a truth in these criticisms. It was the very aim of Hegelianism to render fluid the fixed phases of reality—to show existence not to be an immovable rock limiting the efforts of thought, but to have thought implicit in it, waiting for release from its petrification. Nature was no longer, as with Fichte, to be a mere spring-board to evoke the latent powers of the spirit. Nor was it, as in Schelling's earlier system, to be a collateral progeny with mind from the same womb of indifference and identity. Nature and mind in the Hegelian system—the external and the spiritual world—have the same origin, but are not co-equal branches. The natural world proceeds from the "idea," the spiritual from the idea and nature. It is impossible, beginning with the natural world, to explain the mind by any process of distillation or development, unless consciousness or its potentiality has been there from the first. Reality, independent of the individual consciousness, there must be; reality, independent of all mind, is an impossibility. At the basis of all reality, whether material or mental, there is thought. But the thought thus regarded as the basis of all existence is not

consciousness with its distinction of ego and non-ego. It is rather the stuff of which both mind and nature are made, neither extended as in the natural world, nor self-centred as in mind. Thought in its primary form is, as it were, thoroughly transparent and absolutely fluid, free and mutually interpenetrable in every part—the spirit in its metaphoric scientific life, before creation had produced a natural world, and thought had risen to independent existence in the social organism. Thought in this primary form, when in all its parts completed, is what Hegel calls the "idea." But the idea, though fundamental, is in another sense final, in the process of the world. It only appears in consciousness as the crowning development of the mind. Only with philosophy does thought become fully conscious of itself in its origin and development. Accordingly the history of philosophy is the presupposition of logic, or the three branches of philosophy form a circle.

The exposition or constitution of the "idea" is the work of the Logic. As the total system falls into three parts, so every part of the system follows the triadic law. Every truth, every logical reality, has three aspects or stages; it is the unification of two contradictory elements, of two partial aspects of truth which are not merely contrary, like black and white, but contradictory, like same and different. The first step is a preliminary affirmation and unification, the second a negation and differentiation, the third a final synthesis. For example, the seed of the plant is an initial unity of life, which when placed in its proper soil suffers disintegration into its constituents, and yet in virtue of its vital unity keeps these divergent elements together, and reappears as the plant with its members in organic union. Or again, in the process of scientific induction is a threefold chain; the original hypothesis (the first unification of the fact) seems to melt away when confronted with opposite facts, and yet no scientific progress is possible unless the stimulus of the original unification is strong enough to clasp the discordant facts and establish a reunification. Thesis, antithesis and synthesis, a Fichtean formula, is generalized by Hegel into the perpetual law of thought.

In what we may call their psychological aspect these three stages are known as the abstract stage, or that of understanding (*Verstand*), the dialectical stage, or that of negative reason, and the speculative stage, or that of positive reason (*Vernunft*). The first of these attitudes taken alone is dogmatism; the second, when similarly isolated, is scepticism; the third, when unexplained by its elements, is mysticism. Thus Hegelianism reduces dogmatism, scepticism and mysticism to factors in philosophy. The abstract or dogmatic thinker believes his object to be one, simple and stationary, and intelligible apart from its surrounding. He speaks, e.g., as if species and genera were fixed and unchangeable; and fixing his eye on the ideal forms in their purity and self-sameness, he scorns the phenomenal world, whence this identity and persistence are absent. The dialectic of negative reason rudely dispels these theories. Appealing to reality it shows that the identity and permanence of forms are contradicted by history; instead of unity it exhibits multiplicity, instead of identity difference; instead of a whole, only parts. Dialectic is, therefore, a dislocating power; it shakes the solid structures of material thought, and exhibits the instability latent in such conceptions of convention and conservatism; it is absolute and universal unrest. In the realm of abstract thought these transitions take place lightly. In the worlds of nature and mind they are more palpable and violent. So far as this Hegel seems on the side of revolution. But reason is not negative only; while it disintegrates the mass or unconscious unity, it builds up a new unity with higher organization. But this third stage is the place of effort, requiring neither the surrender of the original unity nor the ignoring of the diversity afterwards suggested. The stimulus of contradiction is no doubt a strong one; but the easiest way of escaping it is to shut our eyes to one side of the antithesis. What is required, therefore, is to readjust our original thesis in such a way as to include and give expression to both the elements in the process.

The universe, then, is a process or development, to the eye of philosophy. It is the process of the absolute—in religious language, the manifestation of God. In the background of all the absolute is eternally present; the rhythmic movement of thought is the self-unfolding of the absolute. God reveals Himself in the logical idea, in nature and in mind; but mind is not alike conscious of its absoluteness in every stage of development. Philosophy alone sees God revealing Himself in the ideal organism of thought as it were a possible deity prior to and to any relation between God and actuality; in the natural world, as a series of materialized forces and forms of life; and in the spiritual world as the human soul, the legal and moral order of society, and the creations of art, religion and philosophy.

This introduction of the absolute became a stumbling-block to Feuerbach and other members of the "Left." They rejected as an illegitimate interpolation the eternal subject of development, and, instead of one continuing God as the subject of all the predicates by which in the logic of ideas, products of philosophic activity. They denied the theological value of the logical forms—the development of these forms being in their opinion due to the human thinker, not to a self-revealing absolute. Thus they made man the creator of the absolute.

But with this modification on the system another necessarily followed; a mere logical series could not create nature. And thus the material universe became the real starting-point. Thought became only the result of organic conditions—subjective and human; and the system of Hegel was no longer an idealization of religion, but a naturalistic theory with a prominent and peculiar logic.

The logic of Hegel is the only rival to the logic of Aristotle. What Aristotle did for the theory of demonstrative reasoning, Hegel attempted to do for the theory of human knowledge. His logic is an enumeration of the forms or categories by which our experience exists. It carried out Kant's doctrine of the categories as a priori synthetic principles, but removed the limitation by which Kant denied them any constitutive value except in alliance with experience. According to Hegel the terms in which thought exhibits itself are a system of their own, with laws and relations which reappear in a less obvious shape in the theories of nature and mind. Nor are they restricted to the small number which Kant obtained by manipulating the current subdivision of judgments. But all forms by which thought holds sensations in unity (the formative or synthetic elements of language) had their place assigned in a system where one leads up to and passes over into another.

The fact which ordinary thought ignores, and of which ordinary logic therefore provides no account, is the presence of gradation and continuity in the world. The general terms of language simplify the universe by reducing its variety of individuals to a few forms, none of which exists simply and perfectly. The method of the understanding is to divide and then to give a separate reality to what it has thus distinguished. It is part of Hegel's plan to remedy this one-sided character of thought, by laying bare the gradations of ideas. He lays special stress on the point that abstract ideas when held in their abstraction are almost interchangeable with their opposites—that extremes meet, and that in every true and concrete idea there is a coincidence of opposites.

The beginning of the logic is an illustration of this. The logical idea is treated under the three heads of being (*Seyn*), essence (*Wesen*) and notion (*Begriff*). The simplest term of thought is being; we cannot think less about anything than when we merely say that it is. Being—the abstract "is"—is nothing definite, and nothing at least is. Being and not-being are thus declared identical—a proposition which in the very door of the system. Instead of the mere "is" which is as yet nothing, we should rather say "becomes," and as "becomes" always implies "something," we have determinate being—a being "which in the next stage of definiteness becomes" one. And in this way we pass on to the quantitative aspects of being.

The terms treated under the first head, in addition to those already mentioned, are the abstract principles of quantity and number, and their application in measure to determine the limits of being. Under the title of essence are discussed those pairs of correlative terms which are habitually employed in the explanation of the world—such as law and phenomenon, cause and effect, reason and consequence, substance and attribute. Under the head of notion are considered, firstly, the subjective forms of conception, judgment and syllogism; secondly, their realization in objects as mechanically, chemically or teleologically constituted; and thirdly, the idea first of life, and next of science, as the complete interpenetration of thought and objectivity. The third part of logic evidently is what contains the topics usually treated in logic-books, though even here the province of logic in the ordinary sense is exceeded. The first two divisions—the "objective logic"—are what is usually called metaphysics.

The characteristic of the system is the gradual way in which idea is linked to idea so as to make the division into chapters only an arrangement of convenience. The judgment is completed in the syllogism; the syllogistic form as the perfection of subjective thought passes into objectivity, where it first appears embodied in a mechanical system; and the teleological object, in which the members are as means and end, leads up to the idea of life, where the end is means and means end indissolubly till death. In some cases these transitions may be unsatisfactory and forced; it is apparent that the linear development from "being" to the "idea" is got by transforming into a logical order the sequence that has roughly prevailed in philosophy from the Eleatics; cases might be quoted where the reasoning seems a play upon words; and it may often be doubted whether certain ideas do not involve extra-logical considerations. The order of the categories is in the main outlines fixed; but in the minor details much depends upon the philosopher, who has to fill in the gaps between ideas, with little guidance from the data of experience, and to assign to the stages of development names which occasionally deal hardly with language. The merit of Hegel is to have indicated and to a large extent displayed the filiation and mutual limitation of our forms of thought; to have arranged them in the order of their comparative capacity to give a satisfactory expression to truth in the totality of its relations; and to have broken down the partition which in Kant separated the formal logic from the transcendental analysis, as well as the general disruption between logic and metaphysics. It must at the same time be admitted that much of the work of weaving the terms of thought, the categories, into a system has a hypothetical and tentative character, and that Hegel has rather pointed out the path which logic must follow, viz. a criticism of the terms of scientific and ordinary thought in their filiation

and interdependence, than himself in every case kept to the right way. The day for a fuller investigation of this problem will partly depend upon the progress of the study of language in the direction marked out by W. von Humboldt.

The Philosophy of Nature starts with the result of the logical development, with the full scientific "idea." But the relations of pure thought, losing their inwardness, appear as relations of space and time; the abstract development of thought appears as matter and movement. Instead of thought, we have perception; instead of dialectic, gravitation; instead of causation, sequence in time. The whole falls under the three heads of mechanics, physics and "organic"—the content under each varying somewhat in the three editions of the *Encyclopaedia*. The first treats of space, time, matter, movement; and in the solar system we have the representation of the idea in its general and abstract material form. Under the head of physics we have the theory of the elements, of sound, heat and cohesion, and finally of chemical affinity—presenting the phenomena of material change and interchange in a series of special forces which generate the variety of the life of nature. Lastly, under the head of "organic," come geology, botany and animal physiology—presenting the concrete results of these processes in the three kingdoms of nature.

The charges of superficial analogies, so freely urged against the "Natur-philosophie" by critics who forget the impulse it gave to physical research by the identification of forces then believed to be radically distinct, do not particularly affect Hegel. But in general it may be said that he looked down upon the mere natural world. The meanness of the fancies of the mind and the most casual of its whims he regarded as a better warrant for the being of God than any single object of nature. Those who supposed astronomy to inspire religious awe were horrified to hear the stars compared to eruptive spots on the face of the sky. Even in the animal world, the highest stage of nature, he saw a failure to reach an independent and rational system of organization; and its feelings under the continuous violence and menaces of the environment he described as insecure, anxious and unhappy.

His point of view was essentially opposed to the current views of science. To metamorphosis he only allowed a logical value, as explaining the natural classification; the only real, existent metamorphosis he saw in the development of the individual from its embryonic stage. Still more distinctly did he contravene the general tendency of scientific explanation. "It is held the triumph of science to recognize in the general process of the earth the same categories as are exhibited in the processes of isolated bodies. This is, however, an application of categories from a field where the conditions are finite to a sphere in which the circumstances are infinite." In astronomy he depreciates the merits of Newton and elevates Kepler, accusing Newton particularly, à propos of the distinction of centrifugal and centripetal forces, of leading to a confusion between what is mathematically to be distinguished and what is physically separate. The principles which explain the fall of an apple will not do for the planets. As to colour, he follows Goethe, and uses strong language against Newton's theory, for the barbarism of the conception that light is a compound, the incorrectness of his observations, &c. In chemistry, again, he objects to the way in which all the chemical elements are treated as on the same level.

The third part of the system is the Philosophy of Mind. Its three divisions are the "subjective mind" (psychology), the "objective mind" (philosophic jurisprudence, moral and political philosophy) and the "absolute mind" (the philosophy of art, religion and philosophy). The subjects of the second and third divisions have been treated by Hegel with great detail. The "objective mind" is the topic of the *Rechts-Philosophie*, and of the lectures on the Philosophy of History; while on the "absolute mind" we have the lectures on Aesthetic, on the Philosophy of Religion and on the History of Philosophy—in short, more than one-third of his works.

The purely psychological branch of the subject takes up half of the space allotted to *Geist* in the *Encyclopaedia*. It falls under the three heads of anthropology, phenomenology and psychology proper. Anthropology treats of the mind in union with the body—of the natural soul—and discusses the relations of the soul with the planets, the races of mankind, the differences of age, dreams, animal magnetism, insanity and phrenology. In this obscure region it is rich in suggestions and rapprochements; but the ingenuity of these speculations attracts curiosity more than it satisfies scientific inquiry. In the Phenomenology consciousness, self-consciousness and reason are dealt with. The title of the section and the contents recall, though with some important variations, the earlier half of his first work; only that here the historical background on which the stages in the development of the ego were represented has disappeared. Psychology, in the stricter sense, deals with the various forms of theoretical and practical intellect, such as attention, memory, desire and will. In this account of the development of an independent, active and intelligent being from the stage where man like the Dreyer is a portion of the natural life around him, Hegel has combined what may be termed a physiology and pathology of the mind—a subject far wider than that of ordinary psychologists, and one of vast intrinsic importance. It is, of course, easy to set aside these questions as unanswerable, and to find artificiality in the

arrangement. Still it remains a great point to have even attempted some system in the dark anomalies which lie under the normal consciousness, and to have traced the genesis of the intellectual faculties from animal sensitivity.

The theory of the mind as objectified in the institutions of law, the family and the state is discussed in the "Philosophy of Right." Beginning with the synthesis of a legal system and morality, Hegel, carrying out the work of Kant, presents the synthesis of these elements in the ethical life (*Sittlich-keit*) of the family and the state. Treating the family as an instinctive realization of the moral life, and not as the result of contract, he shows how by the means of wider associations due to private interests the state issues as the full home of the moral spirit, where intimacy of interdependence is combined with freedom of independent growth. The state is the consummation of man as finite; it is the necessary starting-point whence the spirit rises to an absolute existence in the spheres of art, religion and philosophy. In the finite world or temporal state, religion, as the finite organization of a church, is, like other societies, subordinate to the state. But on another side, as absolute spirit, religion, like art and philosophy, is not subject to the state, but belongs to a higher region.

The political state is always an individual, and the relations of these states with each other and the "world-spirit" of which they are the manifestations constitute the material of history. The *Lectures on the Philosophy of History*, edited by Gans and subsequently by Karl Hegel, is the most popular of Hegel's works. The history of the world is a scene of judgment where one people and one alone holds for a while the sceptre, as the unconscious instrument of the universal spirit, till another rises in its place, with a fuller measure of liberty—a larger superiority to the bonds of natural and artificial circumstance. Three main periods—the Oriental, the Classical and the Germanic—in which respectively the single despot, the dominant order, and the man as man possess freedom—constitute the history of the world. Inaccuracy in detail and artifice in the arrangement of isolated peoples are inevitable in such a schema. A graver mistake, according to some critics, is that Hegel, far from giving a law of progress, seems to suggest that the history of the world is nearing an end, and has merely reduced the past to a logical formula. The answer to this charge is partly that such a law seems unattainable, and partly that the idealistic content of the present which philosophy extracts is always an advance upon actual fact, and so does throw a light into the future. And at any rate the method is greater than Hegel's employment of it.

But as with Aristotle so with Hegel—beyond the ethical and political sphere rises the world of absolute spirit in art, religion and philosophy. The psychological distinction between the three forms is that sensuous perception (*Anschauung*) is the organon of the first, presentative conception (*Vorstellung*) of the second and free thought of the third. The work of art, the first embodiment of absolute mind, shows a sensuous conformity between the idea and the reality in which it is expressed. The so-called beauty of nature is for Hegel an adventitious beauty. The beauty of art is a beauty born in the spirit of the artist and born again in the spectator; it is not like the beauty of natural things, an incident of their existence, but is "essentially a question, an address to a responding breast, a call to the heart and spirit." The perfection of art depends on the degree of intimacy in which idea and form appear worked into each other. From the different proportion between the idea and the shape in which it is realized arise three different forms of art. When the idea, itself indefinite, gets no further than a struggle and endeavour for its appropriate expression, we have the symbolic, which is the Oriental, form of art, which seeks to compensate its imperfect expression by colossal and enigmatic structures. In the second or classical form of art the idea of humanity finds an adequate sensuous representation. But this form disappears with the decrease of Greek national life, and on its collapse follows the romantic, the third form of art; where the harmony of form and content again grows defective, because the object of Christian art—the infinite spirit—is a theme too high for art. Corresponding to this division is the classification of the single arts. First comes architecture—in the main, symbolic art; then sculpture, the classical art *par excellence*; they are found, however, in all three forms. Painting and music are the specially romantic arts. Lastly, as a union of painting and music comes poetry, where the sensuous element is more than ever subordinate to the spirit.

The lectures on the Philosophy of Art stray largely into the next sphere and dwell with zest on the close connexion of art and religion; and the discussion of the decadence and rise of religions, of the aesthetic qualities of Christian legend, of the age of chivalry, &c., make the *Asthetik* a book of varied interest.

The lectures on the Philosophy of Religion, though unequal in their composition and belonging to different dates, serve to exhibit the vital connexion of the system with Christianity. Religion, like art, is inferior to philosophy as an exponent of the harmony between man and the absolute. In it the absolute exists as the poetry and music of the heart, in the inwardness of feeling. Hegel after expounding the nature of religion passes on to discuss its historical phases, but in the immature state of religious science falls into several mistakes. At the bottom of the scale of nature-worships he

Philosophy of nature.

J. Law and History.

J. Art, Religion and Philosophy.

places the religion of sorcery. The gradations which follow are apportioned with some uncertainty amongst the religions of the East. With the Persian religion of light and the Egyptian of enigmas we pass to those faiths where Godhead takes the form of a spiritual individuality, i.e. to the Hebrew religion (of sublimity), the Greek (of beauty) and the Roman (of adaptation). Last comes absolute religion, in which the mystery of the reconciliation between God and man is an open doctrine. This is Christianity, in which God is a Trinity, because He is a spirit. The revelation of this truth is the subject of the Christian Scriptures. For the Son of God, in the immediate aspect, is the finite world of nature and man, which far from being at one with its Father is originally in an attitude of estrangement. The history of Christ is the visible reconciliation between man and the eternal. With the death of Christ this union, ceasing to be a mere fact, becomes a vital idea—the Spirit of God which dwells in the Christian community.

The lectures on the History of Philosophy deal disproportionately with the various epochs, and in some parts date from the beginning of Hegel's career. In trying to subject history to the order of logic they sometimes misconceive the filiation of ideas. But they created the history of philosophy as a scientific study. They showed that a philosophical theory is not an accident or whim, but an exponent of its age determined by its antecedents and environments, and handing on its results to the future. (W. W.; X.)

Hegelianism in England.—On the continent of Europe the direct influence of Hegelianism was comparatively short-lived. This was due among other causes to the direction of attention to the rising science of psychology, partly to the reaction against the speculative method. In England and Scotland it had another fate. Both in theory and practice it here seemed to supply precisely the counteractive to prevailing tendencies towards empiricism and individualism that was required. In this respect it stood to philosophy in somewhat the same relation that the influence of Goethe stood to literature. This explains the hold which it had obtained upon both English and Scottish thought soon after the middle of the 19th century. The first impulse came from J. F. Ferrier and J. H. Stirling in Edinburgh, and B. Jowett in Oxford. Already in the seventies there was a powerful school of English thinkers under the lead of Edward Caird and T. H. Green devoted to the study and exposition of the Hegelian system. With the general acceptance of its main principle that the real is the rational, there came in the eighties a more critical examination of the precise meaning to be attached to it and its bearing on the problems of religion. The earlier Hegelians had interpreted it in the sense that the world in its ultimate essence was not only spiritual but self-conscious intelligence whose nature was reflected inadequately but truly in the finite mind. They thus seemed to come forward in the character of exponents rather than critics of the Western belief in God, freedom and immortality. As time went on it became obvious that without departure from the spirit of idealism Hegel's principle was susceptible of a different interpretation. Granted that rationality taken in the sense of inner coherence and self-consistency is the ultimate standard of truth and reality, does self-consciousness itself answer to the demands of this criterion? If not, are we not forced to deny ultimate reality to personality whether human or divine? The question was definitely raised in F. H. Bradley's *Appearance and Reality* (1893; 2nd ed., 1897) and answered in the negative. The completeness and self-consistency which our ideal requires can be realized only in a form of being in which subject and object, will and desire, no longer stand as exclusive opposites, from which it seemed at once to follow that the finite self could not be a reality nor the infinite reality a self. On this basis Bradley developed a theory of the Absolute which, while not denying that it must be conceived of spiritually, insisted that its spirituality is of a kind that finds no analogy in our self-conscious experience. More recently J. M. E. McTaggart's *Studies in Hegelian Dialectic* (1896), *Studies in Hegelian Cosmology* (1901) and *Some Dogmas of Religion* (1906) have opened a new chapter in the interpretation of Hegelianism. Truly perceiving that the ultimate metaphysical problem is, here as ever, the relation of the One and the Many, McTaggart starts with a definition of the ideal in which our thought upon it can come to rest. He finds it where (a) the unity is for each individual, (b) the whole nature of the individual is to be for the unity. It follows from such a conception of the relation that the whole cannot itself be an individual apart from the individuals in whom it is realized, in other words, the Absolute cannot be a Person. But for the same reason—viz. that in it first and in it alone this condition is realized—the individual soul must be held to be an ultimate reality reflecting in its inmost nature, like the monad of Leibniz, the complete fullness and harmony of the whole. In reply to Bradley's argument for the unreality of the self, Hegel is interpreted as meaning that the opposition between self and not-self on which it is founded is one that is self-made and in being made is transcended. The fuller our knowledge of reality the more does the object stand out as an invulnerable system of ordered parts, but the process by which it is thus set in opposition to the subject is also the process by which we understand and transform it into the substance of our own thought. From this position further consequences followed. Seeing that the individual soul must thus be taken to stand in respect to its inmost essence in complete harmony with the whole, it must eternally be at one with itself: all

change must be appearance. Seeing, moreover, that it is, and is maintained in being, by a fixed relation to the Absolute, it cannot fall of immortality. No pantheistic theory of an eternal substance continuously expressing itself in different individuals who fall back into its being like drops into the ocean will here be sufficient. The ocean is the drops. "The Absolute requires each self not to make up a sum or to maintain an average but in respect of the self's special and unique nature." Finally as it cannot cease, neither can the individual soul have a beginning. Pre-existence is as necessary and certain as a future life. If memory is lacking as a link between the different lives, this only shows that memory is not of the substance of the soul.

In view of these differences (amounting almost to an antinomy of paradoxes) in interpretation, it is not surprising to find that recent years have witnessed a violent reaction in some quarters against Hegelian influence. This has taken the direction on the one hand of a revival of realism (see METAPHYSICS), on the other of a new form of subjective idealism (see PRAGMATISM). As yet neither of these movements has shown sufficient coherence or stability to establish itself as a rival to the main current of philosophy in England. But they have both been urged with sufficient ability to arrest its progress and to call for a reconsideration and restatement of the fundamental principle of idealist philosophy and its relation to the fundamental problems of religion. This will probably be the main work of the next generation of thinkers in England (see IDEALISM).

Among Italian Hegelians are A. Vera, Raffaele Mariano and B. Spaventa (1817-1883); see V. de Lucia, *L'Hegel in Italia* (1891). In Sweden, J. J. Borelius of Lund; in Norway, G. V. Lyng (d. 1884), M. J. Monrad (1816-1897) and G. Kent (d. 1892) have adopted Hegelianism; in France, P. Leroux and P. Prévost.

BIBLIOGRAPHY.—Shortly after Hegel's death his collected works were published by a number of his friends, who combined for the purpose. They appeared in eighteen volumes in 1832, and a second edition came out about twelve years later. Volumes I-viii. contain the works published by himself; the remainder is made up of his lectures on the Philosophy of History, Aesthetics, the Philosophy of Religion and the History of Philosophy, besides some essays and reviews, with a few of his letters, and the Philosophical Prolegomena.

For his life see K. Rosenkranz, *Leben Hegels* (Berlin, 1844); R. R. Haym, *Hegel und seine Zeit* (Berlin, 1857); K. Köstlin, *Hegel in philosophischer, politischer und nationaler Beziehung* (Tübingen, 1870); Rosenkranz, *Hegel als deutscher National-Philosoph* (Berlin, 1870), and his *Neue Studien*, vol. iv. (Berlin, 1878); Kuno Fischer, *Hegels Leben und Werke*.

For the philosophy see A. Ruge's *Aus früherer Zeit*, vol. iv. (Berlin, 1867); Haym (as above); F. A. Trendelenburg (in *Logische Untersuchungen*); A. L. Kym (*Metaphysische Untersuchungen*) and C. Hermann (*Hegel und die logische Frage* and other works) are noticeable as modern critics. Georges Noel, *La Logique de Hegel* (Paris, 1897); Aloys Schmid, *Die Entwicklungsgeschichte der Hegelschen Logik* (Regensburg, 1858). Vera has translated the *Encyclopædie* into French, with notes; C. Bénard, the *Aesthetics*. In English J. Hutchesson Stirling's *Secret of Hegel* (2 vols., London, 1865) contains a translation of the beginning of the *Wissenschaft der Logik*; the "Logic" from the *Encyclopædie* has been translated, with Prolegomena, by W. Wallace (Oxford, 1874). W. Wallace also translated the third part of the *Encyclopædie* in *Hegel's Philosophy of Mind* (1894); R. B. Haldane the *History of Philosophy* (1896); E. B. Speirs, lectures on the *Philosophy of Religion* (1895); J. Sibree, lectures on *The Philosophy of History* (1852); B. Bosanquet, *Philosophy of Fine Art*, Introduction (1886); W. Hastie, *The Philosophy of Art* (1886); S. W. Dyde, *The Philosophy of Right* (1896). Other recent expositions and criticisms in addition to those mentioned above are W. T. Harris, *Hegel's Logic* (1890); J. B. Baillie, *Origin and Significance of Hegel's Logic* (1901), and *Outline of the Idealistic Construction of Experience* (1906); P. Barth, *Die Geschichtsphilosophie Hegels* (1890); J. A. Mairrast, *La Philosophie du droit de Hegel* (1869); L. Miraglia, *I Principii fondamentali e la dottrina etico-giuridica di Hegel* (1873); *Hegel's Philosophy of the State and History* (Germ. Phil. Classics, 1887); G. Bolland, *Philosophie des Rechts* (1902), and *Hegels Philosophie der Religion* (1901); E. Ott, *Die Religionsphilosophie Hegels* (1904); J. M. Sterrett, *Studies in Hegel's Philosophy of Religion* (1891); M. Ehrenhauss, *Hegels Gottesbegriff* (1880); E. Caird, *Hegel* (1880); A. Seth Pringle-Pattison, *Hegelianism and Personality* (1893); Millicent Mackenzie, *Hegel's Educational Theory and Practice* (1906), with biographical sketches; J. M. E. McTaggart, *Commentary on Hegel's Logic* (1910). (J. H. Mu.)

HEGEMON OF THASOS, Greek writer of the old comedy, nicknamed Φακί from his fondness for lentils. Hardly anything is known of him, except that he flourished during the Peloponnesian War. According to Aristotle (*Poetics*, ii. 5) he was the inventor of a kind of parody; by slightly altering the wording in well-known poems he transformed the sublime into the ridiculous. When the news of the disaster in Sicily reached Athens, his parody of the *Gigantomachia* was being performed; it is said that the audience were so amused by it that, instead of leaving to show their grief, they remained in their seats. He

was also the author of a comedy called *Philinae* (*Philinae*), written in the manner of Eupolis and Cratinus, in which he attacked a well-known courtesan. Athenaeus (p. 698), who preserves some parodic hexameters of him, relates other anecdotes concerning him (pp. 5, 108, 407).

Fragments in T. Kock, *Comicorum Atticorum fragmenta*, i. (1880); B. J. Peltzer, *De parodiae Græcorum poeti* (1855).

HEGEMONY (Gr. ἡγεμονία, leadership, from ἡγεῖσθαι, to lead, the leadership especially of one particular state in a group of federated or loosely united states. The term was first applied in Greek history to the position claimed by different individual city-states, e.g. by Athens and Sparta, at different times to a position of predominance (*primus inter pares*) among other equal states, coupled with individual autonomy. The reversion of this position was claimed by Macedon (see GREECE: *Ancient History*, and DELIAN LEAGUE).

HEGESIAS OF MAGNESIA (in Lydia), Greek rhetorician and historian, flourished about 300 B.C. Strabo (xiv. 648), speaks of him as the founder of the florid style of composition known as "Asiatic" (cf. TIMAEUS). Agatharchides, Dionysius of Halicarnassus and Cicero all speak of him in disparaging terms, although Varro seems to have approved of his work. He professed to imitate the simple style of Lysias, avoiding long periods, and expressing himself in short, jerky sentences, without modulation or finish. His vulgar affectation and bombast made his writings a mere caricature of the old Attic. Dionysius describes his composition as tinselled, ignoble and effeminate. It is generally supposed, from the fragment quoted as a specimen by Dionysius, that Hegesias is to be classed among the writers of lives of Alexander the Great. This fragment describes the treatment of Gaza and its inhabitants by Alexander after its conquest, but it is possible that it is only part of an epideictic or show-speech, not of an historical work. This view is supported by a remark of Agatharchides in Photius (*cod.* 250) that the only aim of Hegesias was to exhibit his skill in describing sensational events.

See Cicero, *Brutus* 83, *Orator* 67, 69, with J. E. Sandys's note, *ad Att.* xii. 6; Dion. Halic. *De verbis et comp.* iv.; Aulus Gellius ix. 4; Plutarch, *Alexander*, 3; C. W. Müller, *Scriptores rerum Alexandri Magni*, p. 138 (appendix to Didot ed. of Arrian, 1846); Norden, *Die antike Kunstprosa* (1898); J. B. Bury, *Ancient Greek Historians* (1909), pp. 169-172, on origin and development of "Asiatic" style, with example from Hegesias.

HEGESIPPUS, Athenian orator and statesman, nicknamed Κρόμβυλος ("knot"), probably from the way in which he wore his hair. He lived in the time of Demosthenes, of whose anti-Macedonian policy he was an enthusiastic supporter. In 343 B.C. he was one of the ambassadors sent to Macedonia to discuss, amongst other matters, the restoration of the island of Halonnesus, which had been seized by Philip. The mission was unsuccessful, but soon afterwards Philip wrote to Athens, offering to resign possession of the island or to submit to arbitration the question of ownership. In reply to this letter the oration *De Halonneso* was delivered, which, although included among the speeches of Demosthenes, is generally considered to be by Hegesippus. Dionysius of Halicarnassus and Plutarch, however, favour the authorship of Demosthenes.

See Demosthenes, *De falsa legatione* 364, 447, *De corona* 250, *Philippica* iii. 129; Plutarch, *Demosthenes* 17, *Apophthegmata*, 1870; Dionysius Halic. *ad Anaximam*, i.; Grote, *History of Greece*, ch. 90.

HEGESIPPUS (fl. A.D. 150-180), early Christian writer, was of Palestinian origin, and lived under the Emperors Antoninus Pius, Marcus Aurelius and Commodus. Like Aristob of Pella he belonged to that group of Judaistic Christians which, while keeping the law themselves, did not attempt to impose on others the requirements of circumcision and Sabbath observance. He was the author of a treatise (*ὑπομνήματα*) in five books dealing with such subjects as Christian literature, the unity of church doctrine, paganism, heresy and Jewish Christianity, fragments of which are found in Eusebius, who obtained much of his information concerning early Palestinian church history and chronology from this source. Hegesippus was also a great traveller, and like many other leaders

of his time came to Rome (having visited Corinth on the way) about the middle of the 2nd century. His journeyings impressed him with the idea that the continuity of the church in the cities he visited was a guarantee of its fidelity to apostolic orthodoxy: "In each succession and in every city, the doctrine is in accordance with that which the Law and the Prophets and the Lord [*i.e.* the Old Testament and the evangelical tradition] proclaim." To illustrate this opinion he drew up a list of the Roman bishops. Hegesippus is thus a significant figure both for the type of Christianity taught in the circle to which he belonged, and as accentuating the point of view which the church began to assume in the presence of a developing gnosticism.

HEGESIPPUS, the supposed author of a free Latin adaptation of the *Jewish War* of Josephus under the title *De bello Judaico et excidio urbis Hierosolymitanæ*. The seven books of Josephus are compressed into five, but much has been added from the *Antiquities* and from the works of Roman historians, while several entirely new speeches are introduced to suit the occasion. Internal evidence shows that the work could not have been written before the 4th century A.D. The author, who is undoubtedly a Christian, describes it in his preface as a kind of revised edition of Josephus. Some authorities attribute it to Ambrose, bishop of Milan (340-397), but there is nothing to settle the authorship definitely. The name Hegesippus itself appears to be a corruption of Josephus, through the stages Ἰόσηπος, Ιοσιππος, Egesippus, Hegesippus, unless it was purposely adopted as reminiscent of Hegesippus, the father of ecclesiastical history (2nd century).

Best edition by C. F. Weber and J. Caesar (1864); authorities in E. Schürer, *History of the Jewish People* (Eng. trans.), i. 99 seq.; F. Vogel, *De Hegesippo, qui dicitur, Josephi interpretis* (Erlangen, 1881).

HEGIUS [VON HECK], ALEXANDER (c. 1433-1498), German humanist, so called from his birthplace Heek in Westphalia. In his youth he was a pupil of Thomas à Kempis, at that time canon of the convent of St Agnes at Zwolle. In 1474 he settled down at Deventer in Holland, where he either founded or succeeded to the headship of a school, which became famous for the number of its distinguished alumni. First and foremost of these was Erasmus; others were Hermann von dem Busche, the missionary of humanism, Conrad Goclenius (Gockelen), Conrad Mutianus (Muth von Mudt) and pope Adrian VI. Hegius died at Deventer on the 7th of December 1498. His writings, consisting of short poems, philosophical essays, grammatical notes and letters, were published after his death by his pupil Jacob Faber. They display considerable knowledge of Latin, but less of Greek, on the value of which he strongly insisted. Hegius's chief claim to be remembered rests not upon his published works, but upon his services in the cause of humanism. He succeeded in abolishing the old-fashioned medieval textbooks and methods of instruction, and led his pupils to the study of the classical authors themselves. His generosity in assisting poor students exhausted a considerable fortune, and at his death he left nothing but his books and clothes.

See D. Reichling, "Beiträge zur Charakteristik des Alex. Hegius," in the *Monatsschrift für Westdeutschland* (1877); H. Hamelmann, *Opera genealogico-historica* (1711); H. A. Erhard, *Geschichte des Wiederaufblühens wissenschaftlicher Bildung* (1826); C. Kraft and W. Crecellius, "Alexander Hegius und seine Schüler," from the works of Johannes Butzbach, one of Hegius's pupils, in *Zeitschrift des bergischen Geschichtsvereins*, vii. (Bonn, 1871).

HEIBERG, JOHAN LUDVIG (1791-1860), Danish poet and critic, son of the political writer Peter Andreas Heiberg (1758-1841), and of the famous novelist, afterwards the Baroness Gyllembourg-Ehrensvärd, was born at Copenhagen on the 14th of December 1791. In 1800 his father was exiled and settled in Paris, where he was employed in the French foreign office, retiring in 1817 with a pension. His political and satirical writings continued to exercise great influence over his fellow-countrymen. Johan Ludvig Heiberg was taken by K. L. Rahbek and his wife into their house at Bakkehuset. He was educated at the university of Copenhagen, and his first publication, entitled *The Theatre for Marionettes* (1814), included two romantic dramas. This was followed by *Christmas Jokes and New Year's Tricks*

(1826), *The Initiation of Psyche* (1817), and *The Prophecy of Tycho Brahe*, a satire on the eccentricities of the Romantic writers, especially on the sentimentality of Ingemann. These works attracted attention at a time when Baggesen, Ohlenschläger and Ingemann possessed the popular ear, and were understood at once to be the opening of a great career. In 1817 Heiberg took his degree, and in 1819 went abroad with a grant from government. He proceeded to Paris, and spent the next three years there with his father. In 1822 he published his drama of *Nina*, and was made professor of the Danish language at the university of Kiel, where he delivered a course of lectures, comparing the Scandinavian mythology as found in the *Edda* with the poems of Ohlenschläger. These lectures were published in German in 1827.

In 1825 Heiberg came back to Copenhagen for the purpose of introducing the vaudeville on the Danish stage. He composed a great number of these vaudevilles, of which the best known are *King Solomon and George the Halmaker* (1825); *April Fools* (1826); *A Story in Rosenberg Garden* (1827); *Kjæge Huskors* (1831); *The Danes in Paris* (1833); *No* (1836); and *Yes* (1839). He took his models from the French theatre, but showed extraordinary skill in blending the words and the music; but the subjects and the humour were essentially Danish and even topical. Meanwhile he was producing dramatic work of a more serious kind; in 1828 he brought out the national drama of *Elverhøi*; in 1830 *The Inseparables*; in 1835 the fairy comedy of *The Elves*, a dramatic version of Tieck's *Elfen*; and in 1838 *Fala Morgana*. In 1841 Heiberg published a volume of *New Poems* containing "A Soul after Death," a comedy which is perhaps his masterpiece, "The Newly Wedded Pair," and other pieces. He edited from 1827 to 1830 the famous weekly, the *Flyvende Post* (The Flying Post), and subsequently the *Interimsblade* (1834-1837) and the *Intelligensblade* (1842-1843). In his journalism he carried on his warfare against the excessive pretensions of the Romantics, and produced much valuable and penetrating criticism of art and literature. In 1831 he married the actress Johanne Louise Pæetges (1812-1890), herself the author of some popular vaudevilles. Heiberg's scathing satires, however, made him very unpopular; and this antagonism reached its height when, in 1845, he published his malicious little drama of *The Nut Crackers*. Nevertheless he became in 1847 director of the national theatre. He filled the post for seven years, working with great zeal and conscientiousness, but was forced by intrigues from without to resign it in 1854. Heiberg died at Bonderup, near Ringsted, on the 25th of August 1860. His influence upon taste and critical opinion was greater than that of any writer of his time, and can only be compared with that of Holberg in the 18th century. Most of the poets of the Romantic movement in Denmark were very grave and serious; Heiberg added the element of humour, elegance and irony. He had the genius of good taste, and his witty and delicate productions stand almost unique in the literature of his country.

The poetical works of Heiberg were collected, in 11 vols., in 1861-1862, and his prose writings (11 vols.) in the same year. The last volume of his prose works contains some fragments of autobiography. See also G. Brandes, *Essays* (1889). For the elder Heiberg see monographs by Thaarup (1883) and by Schwanenflugel (1891).

HEIDE, a town of Germany, in the Prussian province of Schleswig-Holstein, on a small plateau which stands between the marshes and moors bordering the North Sea, 35 m. N.N.W. of Glückstadt, at the junction of the railways Elmshorn-Hvidding and Neumünster-Tönning. Pop. (1905), 8758. It has an Evangelical and a Roman Catholic church, a high-grade school, and tobacco and cigar manufactories and breweries. Heide in 1447 became the capital of the Ditmarsh peasant republic, but on the 13th of June 1559 it was the scene of the complete defeat of the peasant forces by the Danes.

HEIDEGGER, JOHANN HEINRICH (1633-1698), Swiss theologian, was born at Bärenschwiel, in the canton of Zürich, Switzerland, on the 1st of July 1633. He studied at Marburg and at Heidelberg, where he became the friend of J. L. Fabricius (1632-1696), and was appointed *professor extraordinarius* of

Hebrew and later of philosophy. In 1659 he was called to Steinfurt to fill the chair of dogmatics and ecclesiastical history, and in the same year he became doctor of theology of Heidelberg. In 1660 he revisited Switzerland; and, after marrying, he travelled in the following year to Holland, where he made the acquaintance of Johannes Cocceius. He returned in 1665 to Zürich, where he was elected professor of moral philosophy. Two years later he succeeded J. H. Hottinger (1620-1667) in the chair of theology, which he occupied till his death on the 18th of January 1698, having declined an invitation in 1669 to succeed J. Cocceius at Leiden, as well as a call to Groningen. Heidegger was the principal author of the *Formula Consensus Helvetica* in 1675, which was designed to unite the Swiss Reformed churches, but had an opposite effect. W. Gass describes him as the most notable of the Swiss theologians of the time.

His writings are largely controversial, though without being bitter, and are in great part levelled against the Roman Catholic Church. The chief are *De historia sacra patriarcharum exercitationes selectae* (1667-1671); *Dissertatio de Pergrinationibus religiosis* (1670); *De ratione studiorum, opuscula aurea, &c.* (1670); *Historia papatus* (1684); under the name Nicander von Hohenegg; *Manuductio in viam concordiae Protestantium ecclesiasticæ* (1686); *Tumulus concilii Tridentini* (1690); *Exercitationes biblicæ* (1700), with a life of the author prefixed; *Corpus theologiæ Christianæ* (1700, edited by J. H. Schweizer); *Ethicæ Christianæ elementa* (1711); and lives of J. H. Hottinger (1667) and J. L. Fabricius (1698). His autobiography appeared in 1698, under the title *Historia vitæ J. H. Heideggeri*.

See the articles in Herzog-Hauck's *Realencyclopædie* and the *Allgemeine deutsche Biographie*; and cf. W. Gass, *Geschichte der protestantischen Dogmatik*, ii. 353 ff.

HEIDELBERG, a town of Germany, on the south bank of the Neckar, 12 m. above its confluence with the Rhine, 13 m. S.E. from Mannheim and 54 m. from Frankfort-on-Main by rail. The situation of the town, lying between lofty hills covered with vineyards and forests, at the spot where the rapid Neckar leaves the gorge and enters the plain of the Rhine, is one of great natural beauty. The town itself consists practically of one long, narrow street—the Hauptstrasse—running parallel to the river, from the railway station on the west to the Karlstor on the east (where there is also a local station) for a distance of 2 m. To the south of this is the Anlage, a pleasant promenade flanked by handsome villas and gardens, leading directly to the centre of the place. A number of smaller streets intersect the Hauptstrasse at right angles and run down to the river, which is crossed by two fine bridges. Of these, the old bridge on the east, built in 1788, has a fine gateway and is adorned with statues of Minerva and the elector Charles Theodore of the Palatinate; the other, the lower bridge, on the west, built in 1877, connects Heidelberg with the important suburbs of Neuenheim and Handschuchsheim. Of recent years the town has grown largely towards the west on both sides of the river; but the additions have been almost entirely of the better class of residences. Heidelberg is an important railway centre, and is connected by trunk lines with Frankfort, Mannheim, Karlsruhe, Spirens and Würzburg. Electric trams provide for local traffic, and there are also several light railways joining it with the neighbouring villages. Of the churches the chief are the Protestant Peterskirche dating from the 15th century and restored in 1873, to the door of which Jerome of Prague in 1460 nailed his theses; the Heilige Geist Kirche (Church of the Holy Ghost), an imposing Gothic edifice of the 15th century; the Jesuitenkirche (Roman Catholic), with a sumptuously decorated interior, and the new Evangelical Christuskirche. The town hall and the university buildings, dating from 1712 and restored in 1886, are commonplace erections; but to the south of the Ludwigsplatz, upon which most of the academical buildings lie, stands the new university library, a handsome structure of pink sandstone in German Renaissance style. In addition to the Ludwigsplatz with its equestrian statue of the emperor William I. there are other squares in the town, among them being the Bismarckplatz with a statue of Bismarck, and the Jubiläumplatz.

The chief attraction of Heidelberg is the castle, which overhangs the east part of the town. It stands on the Jettenbühl, a spur of the Königstuhl (1800 ft.), at a height of 330 ft. above the Neckar. Though now a ruin, yet its extent, its magnificence, its beautiful situation and its interesting history render it by far the most noteworthy, as it certainly is the grandest and largest, of the old castles of Germany. The building was begun early in the 13th century. The elector palatine and German king Rupert III. (d. 1410) greatly improved it, and built the wing, Ruprechtsbau or Rupert's building, that bears his name. Succeeding electors further extended and embellished it (see ARCHITECTURE, Plate VII., figs. 78-80); notably Otto Henry "the Magnanimous" (d. 1559), who built the beautiful early Renaissance wing known as the Otto-Heinrichsbau (1556-1559); Frederick IV., for whom the fine late Renaissance wing called the Friedrichsbau was built (1601-1607); and Frederick V., the unfortunate "winter king" of Bohemia, who on the west side added the Elisabethenbau or Engelschebau (1618), named after his wife, the daughter of James I. of Great Britain and ancestress



of the present English reigning family. In 1648, at the peace of Westphalia, Heidelberg was given back to Frederick V.'s son, Charles Louis, who restored the castle to its former splendour. In 1688, during Louis XIV.'s invasion of the Palatinate, the castle was taken, after a long siege, by the French, who blew part of it up when they found they could not hope to hold it (March 2, 1689). In 1693 it was again captured by them and still further wrecked. Finally, in 1764, it was struck by lightning and reduced to its present ruinous condition.

Apart from the outworks, the castle forms an irregular square with round towers at the angles, the principal buildings being grouped round a central courtyard, the entrance to which is from the south through a series of gateways. In this courtyard, besides the buildings already mentioned, are the oldest parts of the castle, the so-called Alte Bau (old building) and the Bandhaus. The Friedrichsbau, which is decorated with statues of the rulers of the Palatinate, was elaborately restored and rendered habitable between 1897 and 1903. Other noteworthy objects in the castle are the fountain in the courtyard, decorated with four granite columns from Charlemagne's palace at Ingelheim; the Elisabethenthor, a beautiful gateway named after the English princess; the beautiful octagonal bell-tower at the N.E. angle; the ruins of the Krauturm, now known as the Gesprenge Turm, or blown-up tower, and the castle chapel and the museum of antiquities in the Friedrichsbau. In a cellar entered from the courtyard is the famous Great Tun of Heidelberg. This

vast vat was built in 1751, but has only been used on one or two occasions. Its capacity is 49,000 gallons, and it is 80 ft. high and 31 ft. long. Behind the Friedrichsbau is the Altan (1610), or castle balcony, from which is obtained a view of great beauty, extending from the town beneath to the heights across the Neckar and over the broad luxuriant plain of the Rhine to Mannheim and the dim contours of the Hardt Mountains behind. On the terrace of the beautiful grounds is a statue of Victor von Scheffel, the poet of Heidelberg.

The university of Heidelberg was founded by the elector Rupert I., in 1385, the bull of foundation being issued by Pope Urban VI. in that year. It was constructed after the type of Paris, had four faculties, and possessed numerous privileges. Marselius von Inghen was its first rector. The electors Frederick I., the Victorious, Philip the Upright and Louis V. respectively cherished it. Otto Henry gave it a new organization, further endowed it and founded the library. At the Reformation it became a stronghold of Protestant learning, the Heidelberg catechism being drawn up by its theologians. Then the tide turned. Damaged by the Thirty Years' War, it led a struggling existence for a century and a half. A large portion of its remaining endowments was cut off by the peace of Lunéville (1801). In 1803, however, Charles Frederick, grand-duke of Baden, raised it anew and reconstituted it under the name of "Ruperto-Carola." The number of professors and teachers is at present about 150 and of students 1700. The library was first kept in the choir of the Heilige Geist Kirche, and then consisted of 3500 MSS. In 1623 it was sent to Rome by Maximilian I., duke of Bavaria, and stored as the Bibliotheca Palatina in the Vatican. It was afterwards taken to Paris, and in 1815 was restored to Heidelberg. It has more than 500,000 volumes, besides 4000 MSS. Among the other university institutions are the academic hospital, the maternity hospital, the physiological institution, the chemical laboratory, the zoological museum, the botanical garden and the observatory on the Königstuhl.

The other educational foundations are a gymnasium, a modern and a technical school. There is a small theatre, an art and several other scientific societies. The manufactures of Heidelberg include cigars, leather, cement, surgical instruments and beer, but the inhabitants chiefly support themselves by supplying the wants of a large and increasing body of foreign permanent residents, of the considerable number of tourists who during the summer pass through the town, and of the university students. A funicular railway runs from the Korn-Markt up to the level of the castle and thence to the Molkenkur (700 ft. above the town). The town is well lighted and is supplied with excellent water from the Wolfsbrunnen. Pop. (1885), 29,304; (1905), 49,527.

At an early period Heidelberg was a fief of the bishop of Worms, who entrusted it about 1225 to the count palatine of the Rhine, Louis I. It soon became a town and the chief residence of the counts palatine. Heidelberg was one of the great centres of the reformed teaching and was the headquarters of the Calvinists. On this account it suffered much during the Thirty Years' War, being captured and plundered by Count Tilly in 1622, by the Swedes in 1633 and again by the imperialists in 1635. By the peace of Westphalia it was restored to the elector Charles Louis. In 1688 and again in 1693 Heidelberg was sacked by the French. On the latter occasion the work of destruction was carried out so thoroughly that only one house escaped; this being a quaintly decorated erection in the Markt-platz, which is now the Hôtel zum Ritter. In 1720 the elector Charles II. removed his court to Mannheim, and in 1803 the town became part of the grand-duchy of Baden. On the 5th of March 1848 the Heidelberg assembly was held here, and at this meeting the steps were taken which led to the revolution in Germany in that year.

See Oncken, *Stadt, Schloss und Hochschule Heidelberg; Bilder aus ihrer Vergangenheit* (Heidelberg, 1884); Oechelhäuser, *Das Heidelberger Schloss, bau- und kunstgeschichtlicher Führer* (Heidelberg, 1902); Pfaff, *Heidelberg und Umgebung* (Heidelberg, 1902);

Lorenzen, *Heidelberg und Umgebung* (Stuttgart, 1902); Durn, *Das Heidelberger Schloss, eine Studie* (Berlin, 1884); Koch and Seitz, *Das Heidelberger Schloss* (Darmstadt, 1887-1891); J. F. Hautz, *Geschichte der Universität Heidelberg* (1863-1864); A. Thorbecke, *Geschichte der Universität Heidelberg* (Stuttgart, 1886); the *Urkundenbuch der Universität Heidelberg*, edited by Winkelmann (Heidelberg, 1886); Bähr, *Die Entführung der Heidelberger Bibliothek nach Rom* (Leipzig, 1845); and G. Weber, *Heidelberger Erinnerungen* (Stuttgart, 1886).

HEIDELBERG, a town and district of the Transvaal. The district is bounded S. by the Vaal river and includes the south-eastern part of the Witwatersrand gold-fields. The town of Heidelberg is 42 m. S.E. of Johannesburg and 441 m. N.W. of Durban by rail. Pop. (1904), 3220, of whom 1837 were white. It was founded in 1865, is built on the slopes of the Rand at an elevation of 5029 ft., and is reputed the best sanatorium in the colony. It is the centre of the eastern Rand gold-mines.

HEIDELBERG CATECHISM, THE, the most attractive of all the catechisms of the Reformation, was drawn up at the bidding of Frederick III., elector of the Palatinate, and published on Tuesday the 10th of January 1563. The new religion in the Palatinate had been largely under the guidance of Philip Melancthon, who had revived the old university of Heidelberg and staffed it with sympathetic teachers. One of these, Tillemann, Heshusius, who became general superintendent in 1558, held extreme Lutheran views on the Real Presence, and in his desire to force the community into his own position excommunicated his colleague Klebitz, who held Zwinglian views. When the breach was widening Frederick, "der fromme Kurfürst," came to the succession, dismissed the two chief combatants and referred the trouble to Melancthon, whose guarded verdict was distinctly Swiss rather than Lutheran. In a decree of August 1560 the elector declared for Calvin and Zwingli, and soon after he resolved to issue a new and unambiguous catechism of the evangelical faith. He entrusted the task to two young men who have won deserved remembrance by their learning and their character alike. Zacharias Ursinus was born at Breslau in July 1534 and attained high honour in the university of Wittenberg. In 1558 he was made rector of the gymnasium in his native town, but the incessant strife with the extreme Lutherans drove him to Zürich, whence Frederick, on the advice of Peter Martyr, summoned him to be professor of theology at Heidelberg and superintendent of the *Sapientiae Collegium*. He was a man of modest and gentle spirit, not endowed with great preaching gifts, but unwearied in study and consummately able to impart his learning to others. Deposed from his chair by the elector Louis in 1576, he lived with John Casimir at Neustadt and found a congenial sphere in the new seminary there, dying in his 49th year, in March 1583.

Caspar Olevianus was born at Treves in 1536. He gave up law for theology, studied under Calvin in Geneva, Peter Martyr in Zürich, and Beza in Lausanne. Urged by William Farel he preached the new faith in his native city, and when banished therefrom found a home with Frederick of Heidelberg, where he gained high renown as preacher and administrator. His ardour and enthusiasm made him the happy complement of Ursinus. When the reaction came under Louis he was befriended by Ludwig von Sain, prince of Wittgenstein, and John, count of Nassau, in whose city of Herborn he did notable work at the high school until his death on the 15th of March 1587. The elector could have chosen no better men, young as they were, for the task in hand. As a first step each drew up a catechism of his own composition, that of Ursinus being naturally of a more grave and academic turn than the freer production of Olevianus, while each made full use of the earlier catechisms already in use. But when the union was effected it was found that the spirits of the two authors were most happily and harmoniously wedded, the exactness and erudition of the one being blended with the fervency and grace of the other. Thus the Heidelberg Catechism, which was completed within a year of its inception, has an individuality that marks it out from all its predecessors and successors. The Heidelberg synod unanimously approved of it,

and it was published in January 1563, and in the same year officially turned into Latin by Jos. Lagus and Lambert Pitheopoeus.

The ultra-Lutherans attacked the catechism with great bitterness, the assault being led by Heshusius and Flacius Illyricus. Maximilian II. remonstrated against it as an infringement of the peace of Augsburg. A conference was held at Maulbronn in April 1564, and a personal attack was made on the elector at the diet of Augsburg in 1566, but the defence was well sustained, and the Heidelberg book rapidly passed beyond the bounds of the Palatinate (where indeed it suffered eclipse from 1576 to 1583, during the electorate of Louis), and gained an abundant success not only in Germany (Hesse, Anhalt, Brandenburg and Bremen) but also in the Netherlands (1588), and in the Reformed churches of Hungary, Transylvania and Poland. It was officially recognized by the synod of Dort in 1619, passed into France, Britain and America, and probably shares with the *De imitatione Christi* and *The Pilgrim's Progress* the honour of coming next to the Bible in the number of tongues into which it has been translated.

This wide acceptance and high esteem are due largely to an avoidance of polemical and controversial subjects, and even more to an absence of the controversial spirit. There is no mistake about its Protestantism, even when we omit the unhappy addition made to answer so by Frederick himself (in indignant reply to the ban pronounced by the Council of Trent), in which the Mass is described as "nothing else than a denial of the one sacrifice and passion of Jesus Christ, and an accused idolatry"—an addition which is the one blot on the *truth* of the catechism. The work is the product of the best qualities of head and heart, and its prose is frequently marked by all the beauty of a lyric. It follows the plan of the epistle to the Romans (excepting chapters ix.-xi.) and falls into three parts: Sin, Redemption and the New Life. This arrangement alone would mark it out from the normal reformation catechism, which runs along the stereotyped lines of Decalogue, Creed, Lord's Prayer, Church and Sacraments. These themes are included, but are shown as organically related. The Commandments, e.g. "belong to the first part so far as they are a mirror of our sin and misery; but also to the third part, as being the rule of our new obedience and Christian life." The Creed—a panorama of the sublime facts of redemption—and the sacraments find their place in the second part; the Lord's Prayer (with the Decalogue) in the third.

See *The Heidelberg Catechism, the German Text, with a Revised Translation and Introduction*, edited by A. Smellie (London, 1900).

HEIDELOFF, KARL ALEXANDER VON (1788-1865), German architect, the son of Victor Peter Heideloff, a painter, was born at Stuttgart. He studied at the art academy of his native town, and after following the profession of an architect for some time at Coburg was in 1818 appointed city architect at Nuremberg. In 1827 he became professor at the polytechnic school, holding his post until 1854, and some years later he was chosen conservator of the monuments of art. Heideloff devoted his chief attention to the Gothic style of architecture, and the buildings restored and erected by him at Nuremberg and in its neighbourhood attest both his original skill and his purity of taste. He also achieved some success as a painter in water-colour. He died at Hassfurt on the 28th of September 1865. Among his architectural works should be mentioned the castle of Reinhardsbrunn, the Hall of the Knights in the fortress at Coburg, the castle of Landsberg, the mortuary chapel in Meiningen, the little castle of Rosenberg near Bonn, the chapel of the castle of Rheinstein near Bingen, and the Catholic church in Leipzig. His powers in restoration are shown in the castle of Lichtenstein, the cathedral of Bamberg, and the Knights' Chapel (*Ritter Kapelle*) at Hassfurt.

Among his writings on architecture are *Die Lehre von den Säulenordnungen* (1827); *Der Kleine Vignola* (1832); *Nürnberg's Baudenkmäler der Vorzeit* (1838-1843, complete edition 1854); and *Die Ornamentik des Mittelalters* (1838-1842).

HEIDENHEIM, a town of Germany, in the kingdom of Württemberg, 31 m. by rail north by east of Ulm. Pop. (1905), 12,175. It has an Evangelical and a Roman Catholic church,

Heine was also fortunate in having access to the chief literary circles of the capital; he was on terms of intimacy with Varnhagen von Ense and his wife, the celebrated Rabel, at whose house he frequently met such men as the Humboldts, Hegel himself and Schleiermacher; he made the acquaintance of leading men of letters like Fouqué and Chamisso, and was on a still more familiar footing with the most distinguished of his co-religionists in Berlin. Under such favourable circumstances his own gifts were soon displayed. He contributed poems to the *Berliner Gesellschafter*, many of which were subsequently incorporated in the *Buch der Lieder*, and in December 1821 a little volume came from the press entitled *Gedichte*, his first avowed act of authorship. He was also employed at this time as correspondent of a Rhenish newspaper, as well as in completing his tragedies *Almansor* and *William Ratcliff*, which were published in 1823 with small success. In that same year Heine, not in the most hopeful spirits, returned to his family, who had meanwhile moved to Lüneburg. He had plans of settling in Paris, but as he was still dependent on his uncle, the latter's consent had to be obtained. As was to be expected, Solomon Heine did not favour the new plan, but promised to continue his support on the condition that Harry completed his course of legal study. He sent the young student for a six weeks' holiday at Cuxhaven, which opened the poet's eyes to the wonders of the sea; and three weeks spent subsequently at his uncle's county seat near Hamburg were sufficient to awaken a new passion in Heine's breast—this time for Amalie's sister, Therese. In January 1824 Heine returned to Göttingen, where, with the exception of a visit to Berlin and the excursion to the Harz mountains in the autumn of 1824, which is immortalized in the first volume of the *Reisebilder*, he remained until his graduation in the summer of the following year. It was on the latter of these journeys that he had the interview with Goethe which was so amusingly described by him in later years. A few weeks before obtaining his degree, he took a step which he had long meditated; he formally embraced Christianity. This "act of apostasy," which has been dwelt upon at unnecessary length both by Heine's enemies and admirers, was actuated wholly by practical considerations, and did not arise from any wish on the poet's part to deny his race. The summer months which followed his examination Heine spent by his beloved sea in the island of Norderney, his uncle having again generously supplied the means for this purpose. The question of his future now became pressing, and for a time he seriously considered the plan of settling as a solicitor in Hamburg, a plan which was associated in his mind with the hope of marrying his cousin Therese. Meanwhile he had made arrangements for the publication of the *Reisebilder*, the first volume of which, *Die Harzreise*, appeared in May 1826. The success of the book was instantaneous. Its lyric outbursts and flashes of wit; its rapid changes from grave to gay; its flexibility of thought and style, came as a revelation to a generation which had grown weary of the lumbering literary methods of the later Romanticists.

In the spring of the following year Heine paid a long planned visit to England, where he was deeply impressed by the free and vigorous public life, by the size and bustle of London; above all, he was filled with admiration for Canning, whose policy had realized many a dream of the young German idealists of that age. But the picture had also its reverse; the sordidly commercial spirit of English life, and brutal egotism of the ordinary Englishman, grated on Heine's sensitive nature; he missed the finer literary and artistic tastes of the continent and was repelled by the austerity of English religious sentiment and observance. Unfortunately the latter aspects of English life left a deeper mark on his memory than the bright side. In October Baron Cotta, the well-known publisher, offered Heine—the second volume of whose *Reisebilder* and the *Buch der Lieder* had meanwhile appeared and won him fresh laurels—the joint-editorship of the *Neue allgemeine politische Annalen*. He gladly accepted the offer and betook himself to Munich. Heine did his best to adapt himself and his political opinions to the new surroundings, in the hope of coming in for a share of

the good things which Ludwig I. of Bavaria was so generously distributing among artists and men of letters. But the stings of the *Reisebilder* were not so easily forgotten; the clerical party in particular did not leave him long in peace. In July 1828, the professorship on which he had set his hopes being still not forthcoming, he left Munich for Italy, where he remained until the following November, a holiday which provided material for the third and part of the fourth volumes of the *Reisebilder*. A blow more serious than the Bavarian king's refusal to establish him in Munich awaited him on his return to Germany—the death of his father. In the beginning of 1829 Heine took up his abode in Berlin, where he resumed old acquaintanceships; in summer he was again at the sea, and in autumn he returned to the city he now loathed above all others, Hamburg, where he virtually remained until May 1831. These years were not a happy period of the poet's life; his efforts to obtain a position, apart from that which he owed to his literary work, met with rebuffs on every side; his relations with his uncle were unsatisfactory and disturbed by constant friction, and for a time he was even seriously ill. His only consolation in these months of discontent was the completion and publication of the *Reisebilder*. When in 1830 the news of the July Revolution in the streets of Paris reached him, Heine hailed it as the beginning of a new era of freedom, and his thoughts reverted once more to his early plan of settling in Paris. All through the following winter the plan ripened, and in May 1831 he finally said farewell to his native land.

Heine's first impressions of the "New Jerusalem of Liberalism" were jubilantly favourable; Paris, he proclaimed, was the capital of the civilized world, to be a citizen of Paris the highest of honours. He was soon on friendly terms with many of the notabilities of the capital, and there was every prospect of a congenial and lucrative journalistic activity as correspondent for German newspapers. Two series of his articles were subsequently collected and published under the titles *Französische Zustände* (1832) and *Luise* (written 1840-1843, published in the *Vermischte Schriften*, 1854). In December 1835, however, the German Bund, incited by W. Menzel's attacks on "Young Germany," issued its notorious decree, forbidding the publication of any writings by the members of that coterie; the name of Heine, who had been stigmatized as the leader of the movement headed the list. This was the beginning of a series of literary feuds in which Heine was, from now on, involved; but a more serious and immediate effect of the decree was to curtail considerably his sources of income. His uncle, it is true, had allowed him 4000 francs a year when he settled in Paris, but at this moment he was not on the best of terms with his Hamburg relatives. Under these circumstances he was induced to take a step which his fellow-countrymen have found it hard to forgive; he applied to the French government for support from a secret fund formed for the benefit of "political refugees" who were willing to place themselves at the service of France. From 1836 or 1837 until the Revolution of 1848 Heine was in receipt of 4800 francs annually from this source.

In October 1834 Heine made the acquaintance of a young Frenchwoman, Eugénie Mirat, a saleswoman in a boot-shop in Paris, and before long had fallen passionately in love with her. Although ill-educated, vain and extravagant, she inspired the poet with a deep and lasting affection, and in 1841, on the eve of a duel in which he had become involved, he made her his wife. "Mathilde," as Heine called her, was not the comrade to help the poet in days of adversity, or to raise him to better things, but, in spite of passing storms, he seems to have been happy with her, and she nursed him faithfully in his last illness. Her death occurred in 1883. His relations with Mathilde undoubtedly helped to weaken his ties with Germany; and notwithstanding the affection he professed to cherish for his native land, he only revisited it twice, in the autumn of 1843 and the summer of 1847. In 1845 appeared the first unmistakable signs of the terrible spinal disease, which, for eight years, from the spring of 1848 till his death, condemned him to a "mattress grave." These years of suffering—suffering which left his

intellect as clear and vivacious as ever—seem to have effected what might be called a spiritual purification in Heine's nature, and to have brought out all the good sides of his character, whereas adversity in earlier years only intensified his cynicism. The lyrics of the *Romanero* (1851) and the collection of *Neueste Gedichte* (1853-1854) surpass in imaginative depth and sincerity of purpose the poetry of the *Buch der Lieder*. Most wonderful of all are the poems inspired by Heine's strange mystic passion for the lady he called *Die Mouche*, a countrywoman of his own—her real name was Elise von Krienitz, but she had written in French under the *nom de plume* of Camille Selden—who helped to brighten the last months of the poet's life. He died on the 17th of February 1856, and lies buried in the cemetery of Montmartre.

Besides the purely journalistic work of Heine's Paris years, to which reference has already been made, he published a collection of more serious prose writings under the title *Der Salon* (1833-1839). In this collection will be found, besides papers on French art and the French stage, the essays "Zur Geschichte der Religion und Philosophie in Deutschland," which he had written for the *Revue des deux mondes*. Here, too, are the more characteristic productions of Heine's genius, *Aus den Memoiren des Herrn von Schnabelwopaki*, *Der Rabbi von Bacherach* and *Florentinische Nächte*. *Die romantische Schule* (1836), with its unparadonable personal attack on the elder Schlegel, is a less creditable essay in literary criticism. In 1839 appeared *Shakespeares Mädchen und Frauen*, which, however, was merely the text to a series of illustrations; and in 1840, the witty and trenchant satire on a writer, who, in spite of many personal disagreements, had been Heine's fellow-fighter in the liberal cause, Ludwig Börne. Of Heine's poetical work in these years, his most important publications were, besides the *Romanero*, the two admirable satires, *Deutschland, ein Wintermärchen* (1844), the result of his visit to Germany, and *Atta Troll, ein Sommernachtsstraum* (1876), an attack on the political *Tendenzliteratur* of the 'forties.

In the case of no other of the greater German poets is it so hard to arrive at a final judgment as in that of Heinrich Heine. In his *Buch der Lieder* he unquestionably struck a new lyric note, not merely for Germany but for Europe. No singer before him had been so daring in the use of nature-symbolism as he, none had given such concrete and plastic expression to the spiritual forces of heart and soul; in this respect Heine was clearly the descendant of the Hebrew poets of the Old Testament. At times, it is true, his imagery is exaggerated to the degree of absurdity, but it exercised, none the less, a fascination over his generation. Heine combined with a spiritual delicacy, a fineness of perception, that firm hold on reality which is so essential to the satirist. His lyric appealed with particular force to foreign peoples, who had little understanding for the intangible, undefinable spirituality which the German people regard as an indispensable element in their national lyric poetry. Thus his fame has always stood higher in England and France than in Germany itself, where his lyric method, his self-consciousness, his cynicism in season and out of season, were little in harmony with the literary traditions. As far, indeed, as the development of the German lyric is concerned, Heine's influence has been of questionable value. But he introduced at least one new and refreshing element into German poetry with his lyrics of the North Sea; no other German poet has felt and expressed so well as Heine the charm of sea and coast.

As a prose writer, Heine's merits were very great. His work was, in the main, journalism, but it was journalism of a high order, and, after all, the best literature of the "Young German" school to which he belonged was of this character. Heine's light fancy, his agile intellect, his straightforward, clear style stood him here in excellent stead. The prose writings of his French period mark, together with Börne's *Briefe aus Paris*, the beginning of a new era in German journalism and a healthy revolt against the unwieldy prose of the Romantic period. Above all things, Heine was great as a wit and a satirist. His

lyric may not be able to assert itself beside that of the very greatest German singers, but as a satirist he had powers of the highest order. He combined the holy zeal and passionate earnestness of the "soldier of humanity" with the withering scorn and ineradicable sense of justice common to the leaders of the Jewish race. It was Heine's real mission to be a reformer, to restore with instruments of war rather than of peace "the interrupted order of the world." The more's the pity that his magnificent Aristophanic genius should have had so little room for its exercise, and have been frittered away in the petty squabbles of an exiled journalist.

The first collected edition of Heine's works was edited by A. Strödtmann in 21 vols. (1861-1866), the best critical edition is the *Sämmtliche Werke*, edited by E. Elster (7 vols., 1887-1890). Heine has been more translated into other tongues than any other German writer of his time. Mention may here be made of the French translation of his *Œuvres complètes* (14 vols., 1852-1868), and the English translation (by C. G. Leland and others) recently completed, *The Works of Heinrich Heine* (13 vols., 1892-1905). For biography and criticism see the following works: A. Strödtmann, *Heines Leben und Werke* (3rd ed., 1884); H. Hueffer, *Aus dem Leben H. Heines* (1878); and by the same author, *H. Heine: Gesammelte Aufsätze* (1906); G. Karpelès, *H. Heine und seine Zeitgenossen* (1888), and by the same author, *H. Heine: aus seinem Leben und aus seiner Zeit* (1900); W. Bölsche, *H. Heine: Versuch einer ästhetisch-kritischen Analyse seiner Werke und seiner Weltanschauung* (1888); G. Brandes, *Det unge Tyskland* (1890; Eng. trans., 1905). An English biography by W. Stegand, *Life, Works and Opinions of Heinrich Heine*, appeared in 1875, but it has little value; there is also a short life by W. Sharp (1888). The essays on Heine by George Eliot and Matthew Arnold are well known. The best French contributions to Heine criticism are J. Legras, *H. Heine, poète* (1897), and H. Lichtenberger, *H. Heine, penseur* (1905). See also L. F. Betz, *Heine in Frankreich* (1895). (J. W. F.; J. G. R.)

HEINECCIUS, JOHANN GOTTLIEB (1681-1741), German jurist, was born on the 11th of September 1681 at Eisenberg, Altenburg. He studied theology at Leipzig, and law at Halle; and at the latter university he was appointed in 1713 professor of philosophy, and in 1718 professor of jurisprudence. He subsequently filled legal chairs at Franeker in Holland and at Frankfurt, but finally returned to Halle in 1733 as professor of philosophy and jurisprudence. He died there on the 31st of August 1741. Heineccius belonged to the school of philosophical jurists. He endeavoured to treat law as a rational science, and not merely as an empirical art whose rules had no deeper source than expediency. Thus he continually refers to first principles, and he develops his legal doctrines as a system of philosophy.

His chief works were *Antiquitatum Romanarum jurisprudentiam illustrantium syntagma* (1718), *Historia juris civilis Romani ac Germanici* (1733), *Elementa juris Germanici* (1735), *Elementa juris naturae et gentium* (1737; Eng. trans. by Turnbull, 2 vols., London, 1763). Besides these works he wrote on purely philosophical subjects, and edited the works of several of the classical jurists. His *Opera omnia* (9 vols., Geneva, 1771, &c.) were edited by his son Johann Christian Gottlieb Heineccius (1718-1791).

Heineccius's brother, JOHANN MICHAEL HEINECCIUS (1674-1722), was a well-known preacher and theologian, but is remembered more from the fact that he was the first to make a systematic study of seals, concerning which he left a book, *De veteribus Germanorum aliarumque nationum sigillis* (Leipzig, 1710; 2nd ed., 1719).

HEINECKEN, CHRISTIAN HEINRICH (1721-1725), a child remarkable for precocity of intellect, was born on the 6th of February 1721 at Lübeck, where his father was a painter. Able to speak at the age of ten months, by the time he was one year old he knew by heart the principal incidents in the Pentateuch. At two years of age he had mastered sacred history; at three he was intimately acquainted with history and geography, ancient and modern, sacred and profane, besides being able to speak French and Latin; and in his fourth year he devoted himself to the study of religion and church history. This wonderful precocity was no mere feat of memory, for the youthful savant could reason on and discuss the knowledge he had acquired. Crowds of people flocked to Lübeck to see the wonderful child; and in 1724 he was taken to Copenhagen at the desire of the king of Denmark. On his return to Lübeck

and several schools. Its industrial establishments include cotton, woollen, tobacco, machinery and chemical factories, bleach-works, dye-works and breweries, and corn and cattle markets. The town, which received municipal privileges in 1356, is overlooked by the ruins of the castle of Hellenstein, standing on a hill 1985 ft. high. Heidenheim is also the name of a small place in Bavaria famous on account of the Benedictine abbey which formerly stood therein. Founded in 748 by Wilibald, bishop of Eichstätt, this was plundered by the peasantry in 1525 and was closed in 1537.

HEIFER, a young cow that has not calved. The O. Eng. *heaf-fere* or *heafra*, from which the word is derived, is of obscure origin. It is found in Bede's *History* (A.D. 900) as *heaf-fere*, and has passed through many forms. It is possibly derived from *heak*, high, and *fares* (fare), to go, meaning "high-stepper." It has also been suggested that the derivation is from *heo*, a stall, and *fere*, a cow.

HEIGEL, KARL AUGUST VON (1835-1905), German novelist, was born, the son of a *régisseur* or stage-manager of the court theatre, on the 25th of March 1835 at Munich. In this city he received his early schooling and studied (1854-1858) philosophy at the university. He was then appointed librarian to Prince Heinrich zu Carolath-Beuthen in Lower Silesia, and accompanied the nephew of the prince on travels. In 1863 he settled in Berlin, where from 1865 to 1875 he was engaged in journalism. He next resided at Munich, employed in literary work for the king, Ludwig II., who in 1881 conferred upon him a title of nobility. On the death of the king in 1886 he removed to Riva on the Lago di Garda, where he died on the 6th of September 1905. Karl von Heigel attained some popularity with his novels: *Wohin?* (1873), *Die Dame ohne Herrn* (1873), *Das Geheimnis des Königs* (1891), *Der Roman einer Stadt* (1898), *Der Maharradschah* (1900), *Die servise Frau* (1900), *Die neuen Heiligen* (1901), and *Brünnels Glück und Ende* (1902). He also wrote some plays, notably *Josephine Bonaparte* (1892) and *Die Zarin* (1883); and several collections of short stories, *Neue Erzählungen* (1876), *Neueste Novellen* (1878), and *Weitere Erzählungen* (1893).

HEIJERMANS, HERMANN (1864-), Dutch writer, of Jewish origin, was born on the 3rd of December 1864 at Rotterdam. In the Amsterdam *Handelsblad* he published a series of sketches of Jewish family life under the pseudonym of "Samuel Falkland," which were collected in volume form. His novels and tales include *Trinette* (1892), *Fles* (1893), *Kamerjensonde* (2 vols., 1896), *Intérieurs* (1897), *Diamantstadt* (2 vols., 1903). He created great interest by his play *Op Hoop van Zegen* (1900), represented at the Théâtre Antoine in Paris, and in English by the Stage Society as *The Good Hope*. His other plays are: *Dora Kremer* (1893), *Ghetto* (1898), *Het zevende Gebot* (1899), *Het Pantser* (1901), *Ora et labora* (1901), and numerous one-act pieces. A *Case of Arson*, an English version of the one-act play *Brand in de Jonge Jan*, was notable for the impersonation (1904 and 1905) by Henri de Vries of all the seven witnesses who appear as characters.

HEILBRONN, a town of Germany, in the kingdom of Württemberg, situated in a pleasant and fruitful valley on the Neckar, 33 m. by rail N. of Stuttgart, and at the junction of lines to Jagdsfeld, Crailsheim and Eppingen. Pop. (1905), 40,026. In the older part of the town the streets are narrow, and contain a number of high turreted houses with quaintly adorned gables. The old fortifications have now been demolished, and their site is occupied by promenades, outside of which are the more modern parts of the town with wide streets and many handsome buildings. The principal public buildings are the church of St Kilian (restored 1886-1895) in the Gothic and Renaissance styles, begun about 1010 and completed in 1529, with an elegant tower 210 ft. high, a beautiful choir, and a finely carved altar; the town hall (Rathaus), founded in 1540, and possessing a curious clock made in 1580, and a collection of interesting letters and other documents; the house of the Teutonic knights (Deutsches Haus), now used as a court of law; the Roman Catholic church of St Joseph, formerly the church of the Teutonic Order; the tower

(Diebaturm or Götzens Turm) on the Neckar, in which Götz von Berlichingen was confined in 1510; a fine synagogue; an historical museum and several monuments, among them those to the emperors William I. and Frederick I., to Bismarck, to Schiller and to Robert von Mayer (1814-1878), a native of the town, famous for his discoveries concerning heat. The educational establishments include a gymnasium, a commercial school and an agricultural academy. The town in a commercial point of view is the most important in Württemberg, and possesses an immense variety of manufactures, of which the principal are gold, silver, steel and iron wares, machines, sugar of lead, white lead, vinegar, beer, sugar, tobacco, soap, oil, cement, chemicals, artificial manure, glue, soda, tapestry, paper and cloth. Grapes, fruit, vegetables and flowering shrubs are largely grown in the neighbourhood, and there are large quarries for sandstone and gypsum and extensive salt-works. By means of the Neckar a considerable trade is carried on in wood, bark, leather, agricultural produce, fruit and cattle.

Heilbronn occupies the site of an old Roman settlement; it is first mentioned in 747, and the Carolingian princes had a palace here. It owes its name—originally Heiligbronn, or holy spring—to a spring of water which until 1857 was to be seen issuing from under the high altar of the church of St Kilian. Heilbronn obtained privileges from Henry IV. and from Rudolph I. and became a free imperial city in 1360. It was frequently besieged during the middle ages, and it suffered greatly during the Peasants' War, the Thirty Years' War, and the various wars with France. In April 1633 a convention was entered into here between Oxenstierna, the Swabian and Frankish estates and the French, English and Dutch ambassadors, as a result of which the Heilbronn treaty, for the prosecution of the Thirty Years' War, was concluded. In 1802 Heilbronn was annexed by Württemberg.

See Jäger, *Geschichte von Heilbronn* (Heilbronn, 1828); Kuttler, *Heilbronn, seine Umgebungen und seine Geschichte* (Heilbronn, 1859); Dürr, *Heilbronner Chronik* (Halle, 1896); Schirz, *Die Entstehung der Stadtgemeinde Heilbronn* (Leipzig, 1903); and A. Käsel, *Der Heilbronner Konvent* (Halle, 1878).

HEILIGENSTADT, a town of Germany, in Prussian Saxony, on the Leine, 32 m. E.N.E. of Cassel, on the railway to Halle. Pop. (1905), 7955. It possesses an old castle, formerly belonging to the electors of Mainz, one Evangelical and two Roman Catholic churches, several educational establishments, and an infirmary. The principal manufactures are cotton goods, cigars, paper, cement and needles. Heiligenstadt is said to have been built by the Frankish king Dagobert and was formerly the capital of the principality of Eichsfeld. In 1022 it was acquired by the archbishop of Mainz, and in 1103 it came into the possession of Henry the Proud, duke of Saxony, but when his son Henry the Lion was placed under the ban of the Empire, it again came to Mainz. It was destroyed by fire in 1333, and was captured in 1525 by Duke Henry of Brunswick. In 1803 it came into possession of Prussia. The Jesuits had a celebrated college here from 1581 to 1773.

HEILSBERG, a town of Germany, in the province of East Prussia, at the junction of the Simser and Alle, 38 m. S. of Königsberg. Pop. (1905), 6042. It has an Evangelical and a Roman Catholic church, and an old castle formerly the seat of the prince-bishops of Ermeland, but now used as an infirmary. The principal industries are tanning, dyeing and brewing, and there is considerable trade in grain. The castle founded at Heilsberg by the Teutonic order in 1240 became in 1306 the seat of the bishops of Ermeland, an honour which it retained for 500 years. On the 10th of June 1807 a battle took place at Heilsberg between the French under Soult and Murat, and the Russians and Prussians under Bennigsen.

HEILSBRONN (or KLOSTER-HEILSBRONN), a village of Germany, in the Bavarian province of Middle Franconia, with a station on the railway between Nuremberg and Ansbach, has 1200 inhabitants. In the middle ages it was the seat of one of the great monasteries of Germany. This foundation, which belonged to the Cistercian order, owed its origin to Bishop Otto

of Bamberg in 1192, and continued to exist till 1555. Its sepulchral monuments, many of which are figured by Hocker, *Heilsbronnischer Antiquitätenkatalog* (Ansbach, 1731-1740), are of exceptionally high artistic interest. It was the hereditary burial-place of the Hohenzollern family and ten burgraves of Nuremberg, five margraves and three electors of Brandenburg, and many other persons of note are buried within its walls. The buildings of the monastery have mostly disappeared, with the exception of the fine church, a Romanesque basilica, restored between 1851 and 1866, and possessing paintings by Albert Dürer. The "Monk of Heilsbronn" is the ordinary appellation of a didactic poet of the 14th century, whose *Sieben Graden, Tochter Syon* and *Leben des heiligen Alexius* were published by J. F. L. T. Merzdorf at Berlin in 1870.

See Rehm, *Ein Gang durch und um die Münster-Kirche zu Kloster-Heilsbronn* (Ansbach, 1875); Stillfried, *Kloster-Heilsbronn, ein Beitrag zu den Hohenzollernschen Forschungen* (Berlin, 1877); Muck, *Geschichte von Kloster-Heilsbronn* (Nördlingen, 1879-1880); J. Meyer, *Die Hohenzollerndenkmale in Heilsbronn* (Ansbach, 1891); and A. Wagner, *Über den Mönch von Heilsbronn* (Straßburg, 1876).

HEIM, ALBERT VON ST GALLEN (1849-), Swiss geologist, was born at Zürich on the 12th of April 1849. He was educated at Zürich and Berlin universities. Very early in life he became interested in the physical features of the Alps, and at the age of sixteen he made a model of the Tödi group. This came under the notice of Arnold Escher von der Linth, to whom Heim was indebted for much encouragement and geological instruction in the field. In 1873 he became professor of geology in the polytechnic school at Zürich, and in 1875 professor of geology in the university. In 1882 he was appointed director of the Geological Survey of Switzerland, and in 1884 the hon. degree of Ph.D. was conferred upon him at Berne. He is especially distinguished for his researches on the structure of the Alps and for the light thereby thrown on the structure of mountain masses in general. He traced the plications from minor to major stages, and illustrated the remarkable foldings and overthrust faultings in numerous sections and with the aid of pictorial drawings. His magnificent work, *Mechanismus der Gebirgsbildung* (1878), is now regarded as a classic, and it served to inspire Professor C. Lapworth in his brilliant researches on the Scottish Highlands (see *Geol. Mag.* 1883). Heim also devoted considerable attention to the glacial phenomena of the Alpine regions. The Wollaston medal was awarded to him in 1904 by the Geological Society of London.

HEIM, FRANÇOIS JOSEPH (1787-1865), French painter, was born at Bellort on the 16th of December 1787. He early distinguished himself at the École Centrale of Strassburg, and in 1803 entered the studio of Vincent at Paris. In 1807 he obtained the first prize, and in 1812 his picture of "The Return of Jacob" (*Musée de Bordeaux*) won for him a gold medal of the first class, which he again obtained in 1817, when he exhibited, together with other works, a St John—bought by Vivant Denon. In 1819 the "Resurrection of Lazarus" (*Cathédral Autun*), the "Martyrdom of St Cyr" (St Gervais), and two scenes from the life of Vespasian (ordered by the king) attracted attention. In 1823 the "Re-erection of the Royal Tombs at St Denis," the "Martyrdom of St Laurence" (*Notre Dame*) and several full-length portraits increased the painter's popularity; and in 1824, when he exhibited his great canvas, the "Massacre of the Jews" (*Louvre*), Heim was rewarded with the legion of honour. In 1827 appeared the "King giving away Prizes at the Salon of 1824" (*Louvre*—engraved by Jazet)—the picture by which Heim is best known—and "Saint Hyacinthe." Heim was now commissioned to decorate the Gallery Charles X. (*Louvre*). Though ridiculed by the romantists, Heim succeeded Regnault at the Institute in 1834, shortly after which he commenced a series of drawings of the celebrities of his day, which are of much interest. His decorations of the Conference room of the Chamber of Deputies were completed in 1844; and in 1847 his works at the Salon—"Champ de Mai" and "Reading a Play at the Théâtre Français"—were the signal for violent criticisms. Yet something like a turn of opinion in his favour took place at the exhibition of 1851; his powers as a

draughtsman and the occasional merits of his composition were recognized, and toleration extended even to his colour. Heim was awarded the great gold medal, and in 1855—having sent to the Salon no less than sixteen portraits, amongst which may be cited those of "Cuvier," "Geoffroy de St Hilaire," and "Madame Hersent"—he was made officer of the legion of honour. In 1859 he again exhibited a curious collection of portraits, sixty-four members of the Institute arranged in groups of four. He died on the 20th of September 1865. Besides the paintings already mentioned, there is to be seen in Notre Dame de Lorette (Paris) a work executed on the spot; and the museum of Strassburg contains an excellent example of his easel pictures, the subject of which is a "Shepherd Drinking from a Spring."

HEIMDAL, or **HEIMDALL**, in Scandinavian mythology, the keeper of the gates of Heaven and the guardian of the rainbow bridge Bifrost. He is the son of Odin by nine virgins, all sisters. He is called "the god with the golden teeth." He lives in the stronghold of Himinsborg at the end of Bifrost. His chief attribute is a vigilance which nothing can escape. He sleeps less than a bird; sees at night and even in his sleep; can hear the grass, and even the wool on a lamb's back grow. He is armed with Gjallar, the magic horn, with which he will summon the gods on the day of judgment.

HEINE, HEINRICH, (1797-1856), German poet and journalist, was born at Düsseldorf, of Jewish parents, on the 13th of December 1797. His father, after various vicissitudes in business, had finally settled in Düsseldorf, and his mother, who possessed much energy of character, was the daughter of a physician of the same place. Heinrich (or, more exactly, Harry) was the eldest of four children, and received his education, first in private schools, then in the Lyceum of his native town; although not an especially apt or diligent pupil, he acquired a knowledge of French and English, as well as some tincture of the classics and Hebrew. His early years coincided with the most brilliant period of Napoleon's career, and the boundless veneration which he is never tired of expressing for the emperor throughout his writings shows that his true schoolmasters were rather the drummers and troopers of a victorious army than the masters of the Lyceum. By freeing the Jews from many of the political disabilities under which they had hitherto suffered, Napoleon became, it may be noted, the object of particular enthusiasm in the circles amidst which Heine grew up. When he left school in 1815, an attempt was made to engage him in business in Frankfort, but without success. In the following year his uncle, Solomon Heine, a wealthy banker in Hamburg, took him into his office. A passion for his cousin Amalie Heine seems to have made the young man more contented with his lot in Hamburg, and his success was such that his uncle decided to set him up in business for himself. This, however, proved too bold a step; in a very few months the firm of "Harry Heine & Co." was insolvent. His uncle now generously provided him with money to enable him to study at a university, with the view of entering the legal profession, and in the spring of 1819 Heine became a student of the university of Bonn. During his stay there he devoted himself rather to the study of literature and history than to that of law; amongst his teachers A. W. von Schlegel, who took a kindly interest in Heine's poetic essays, exerted the most lasting influence on him. In the autumn of 1820 Heine left Bonn for Göttingen, where he proposed to devote himself more assiduously to professional studies, but in February of the following year he challenged to a pistol duel a fellow-student who had insulted him, and was, in consequence, rusticated for six months. The pedantic atmosphere of the university of Göttingen was, however, little to his taste; the news of his cousin's marriage unsettled him still more; and he was glad of the opportunity to seek distraction in Berlin.

In the Prussian capital a new world opened up to him; a very different life from that of Göttingen was stirring in the new university there, and Heine, like all his contemporaries, sat at the feet of Hegel and imbibed from him, doubtless, those views which in later years made the poet the apostle of an outlook upon life more modern than that of his romantic predecessors.

and their capital Deraia in Nejd taken by Ibrahim Pasha in 1817. Hejaz remained in Egyptian occupation until 1845, when its administration was taken over directly by Constantinople, and it was constituted a vilayet under a vali or governor-general. The population is estimated at 300,000, about half of which are inhabitants of the towns and the remainder Bedouin, leading a nomad or pastoral life. The principal tribes are the Sherarat, Beni Atiya and Huwetat in the north; the Juhena between Yambu' and Medina, and the various sections of the Harb throughout the centre and south; the Ateba also touch the Mecca border on the south-east. All these tribes receive *surra* or money payments of large amount from the Turkish government to ensure the safe conduct of the annual pilgrimage, otherwise they are practically independent of the Turkish administration, which is limited to the large towns and garrisons. The troops occupying these latter belong to the 16th (Hejaz) division of the Turkish army.

The difficulties of communication with his Arabian provinces, and of relieving or reinforcing the garrisons there, induced the sultan Abdul Hamid in 1900 to undertake the construction of a railway directly connecting the Hejaz cities with Damascus without the necessity of leaving Turkish territory at any point, as hitherto required by the Suez Canal. Actual construction was begun in May 1901 and on the 1st of September 1904 the section Damascus-Ma'an (285 m.) was officially opened. The line has a narrow gauge of 1.05 metre = 41 in., the same gauge as that of the Damascus-Beirut line; it has a ruling gradient of 1 in 50 and follows generally the pilgrim track, through a desert country presenting no serious engineering difficulties. The graver difficulties due to the scarcity of water, and the lack of fuel, supplies and labour were successfully overcome; in 1906 the line was completed to El Akhdar, 470 m. from Damascus and 350 from Medina, in time to be used by the pilgrim caravan of that year; and the section to Medina was opened in 1908. Its military value was shown in the previous year, when it conveyed 28 battalions from Damascus to Ma'an, from which station the troops marched to Akaba for embarkation en route to Hodeda. The length of the line from Damascus to Medina is approximately 820 m., and from Medina to Mecca 280 m.; the highest level attained is about 4000 ft. at Dar el Hamra in the section Ma'an-Medina.

AUTHORITIES.—J. L. Burckhardt, *Travels in Arabia* (London, 1829); Ali Bey, *Travels* (London, 1816); R. F. Burton, *Pilgrimage to Medina and Mecca* (1893); *Land of Midian* (London, 1879); J. S. Hurgonje, *Mecca* (Hague, 1888); C. M. Doughty, *Arabia Deserta* (Cambridge, 1888); Auler Pasha, *Die Hedschasbahn* (Gotha, 1906). (R. A. W.)

HEJIRA, or **HEGIRA** (Arab. *hijra*, flight, departure from one's country, from *hajara*, to go away), the name of the Mahomedan era. It dates from 622, the year in which Mahomet "fled" from Mecca to Medina to escape the persecution of his kinsmen of the Koreish tribe. The years of this era are distinguished by the initials "A.H." (*anno hegirae*). The Mahomedan year is a lunar one, about 11 days shorter than the Christian; allowance must be made for this in translating *Hegira* dates into Christian dates; thus A.H. 1321 corresponds roughly to A.D. 1903. The actual date of the "flight" is fixed as 8 Rabi'a I., i.e. 20th of September 622, by the tradition that Mahomet arrived at Kufa on the Hebrew Day of Atonement. Although Mahomet himself appears to have dated events by his flight, it was not till seventeen years later that the actual era was systematized by Omar, the second caliph (see CALIPHATE), as beginning from the 1st day of Muharram (the first lunar month of the year) which in that year (639) corresponded to July 16. The term *hejira* is also applied in its more general sense to other "emigrations" of the faithful, e.g. to that to Abyssinia (see MAHOMET), and to that of Mahomet's followers to Medina before the capture of Mecca. These latter are known as *Muhajirun*.

For the problems of Moslem chronology and comparative tables of dates see (beside the articles CALENDAR, CHRONOLOGY and

MAHOMET), Wattenfeld, *Vergleichungstabellen der mohammedanischen und christlichen Zeitrechnung* (2nd ed., Leipzig, 1903); Mas Latrie, *Treasure de chronologie* (Paris, 1889); Durbaneh, *Universal Calendar* (Cairo, 1896); Winckler, *Afforientalische Forschungen*, ii. 326-330; D. Nielson, *Die altharabische Mondreligion* (Strasburg, 1904); Hughes, *Dictionary of Islam*, s.v. "Hijrah."

HEL, or **HELA,** in Scandinavian mythology, the goddess of the dead. She was a child of Loki and the giantess Angurboda, and dwelt beneath the roots of the sacred ash, Yggdrasil. She was given dominion over the nine worlds of Helheim. In early myth all the dead went to her: in later legend only those who died of old age or sickness, and she then became synonymous with suffering and horror. Her dwelling was *Elvidnir* (dark clouds), her dish *Huagr* (hunger), her knife *Sullr* (starvation), her servants *Ganglar* (lardy feet), her bed *Kö* (sickness), and her bed-curtains *Blikiandabol* (splendid misery).

HELDENBUCH, **DAS,** the title under which a large body of German epic poetry of the 13th century has come down to us. The subjects of the individual poems are taken from national German sagas which originated in the epoch of the Migrations (*Völkerwanderung*), although doubtless here, as in all purely popular sagas, motives borrowed from the forces and phenomena of nature were, in course of time, woven into events originally historical. While the saga of the Nibelungen crystallized in the 13th century into the *Nibelungenlied* (q.v.), and the Low German Hilde-saga into the epic of *Gudrun* (q.v.) the poems of the *Heldenbuch*, in the more restricted use of that term, belong almost exclusively to two cycles, (1) the Ostrogothic saga of Ermanrich, Dietrich von Bern (i.e. Dietrich of Verona, Theodoric the Great) and Etzel (Attila), and (2) the cycle of Hugi-dietrich, Wolf-dietrich and Ornit, which like the *Nibelungen* saga, was probably of Franconian origin. The romances of the *Heldenbuch* are of varying poetic value; only occasionally do they rise to the height of the two chief epics, the *Nibelungenlied* and *Gudrun*. Dietrich von Bern, the central figure of the first and more important group, was the ideal type of German medieval hero, and, under more favourable literary conditions, he might have become the centre of an epic more nationally German than even the *Nibelungenlied* itself. Of the romances of this group, the chief are *Biterolf und Dietlieb*, evidently the work of an Austrian poet, who introduced many elements from the court epic of chivalry into a milieu and amongst characters familiar to us from the *Nibelungenlied*. *Der Rosenkranz* tells of the conflicts which took place round Kriemhild's "rose garden" in Worms—conflicts from which Dietrich always emerges victor, even when he is confronted by Siegfried himself. In *Lowin und der kleine Rosenkranz*, the Helden-saga is mingled with elements of popular fairy-lore; it deals with the adventures of Dietrich and his henchman Witege with the wily dwarf Laurin, who watches over another rose garden, that of the Tyrol. Similar in character are the adventures of Dietrich with the giants Ecke (*Eckenlied*) and Sigent, with the dwarf Goldemar, and the deeds of chivalry he performs for queen Virginal (*Dietrichs erste Ausfahrt*)—all of these romances being written in the fresh and popular tone characteristic of the wandering singers or *Spilleute*. Other elements of the Dietrich saga are represented by the poems *Alpharts Tod*, *Dietrichs Flucht* and *Die Rabenschlacht* ("Battle of Ravenaa"). Of these, the first is much the finest poem of the entire cycle and worthy of a place beside the best popular poetry of the Middle High German epoch. Alphart, a young hero in Dietrich's army, goes out to fight single-handed with Witege and Heime, who had deserted to Ermanrich, and he falls, not in fair battle, but by the treachery of Witege whose life he had spared. The other two Dietrich epics belong to a later period, the end of the 13th century—the author being an Austrian, Heinrich der Vogler—and show only too plainly the decay that had by this time set in in Middle High German poetry.

The second cycle of sagas is represented by several long romances, all of them unmistakably "popular" in tone—conflicts with dragons, supernatural adventures, the wonderland of the East providing the chief features of interest. The epics of this group are *Ornit*, *Hugi-dietrich*, *Wolf-dietrich*, the latter with its

¹ The *i* in the second syllable is short:

pathetic episode of the unwerving loyalty of Wolfdietrich's vassal Duke Berchtung and his ten sons. Although many of the incidents and motives of this cycle are drawn from the best traditions of the *Heldenage*, its literary value is not very high.

This collection of popular romances was one of the first German books to be printed. The date of the first edition is unknown, but the second edition appeared in the year 1491 and was followed by later reprints in 1509, 1545, 1560 and 1590. The last of these forms the basis of the text edited by A. von Keller for the Stuttgart *Literarische Verein* in 1867. In 1472 the *Heldenbuch* was adapted to the popular tastes of the time by being remodelled in rough *Knittelvers* or doggerel; the author, or at least copyist, of the MSS. was a certain Kaspar von der Roen, of Mûnnerstadt in Franconia. This version was printed by F. von der Hagen and S. Prümmer in their *Heldenbuch* (1820-1825). *Das Heldenbuch*, which F. von der Hagen published in 2 vols. in 1855, was the first attempt to reproduce the original text by collating the MSS. A critical edition, based not merely on the oldest printed text—the only one which has any value for this purpose, as the others are all copies of it—but also on the MSS., was published in 5 vols. by O. Jänicke, E. Martin, A. Ameling and J. Zupitza at Berlin (1866-1873). A selection, edited by E. Henrich, will be found in Kürschner's *Deutsche National-Literatur*, vol. 7 (1887). Recent editions have appeared of *Der Rosenkranz* and *Laurin*, by G. Holz (1893 and 1897). All the poems have been translated into modern German by K. Simrock and others. See F. E. Sandbach, *The Heroic Saga-Cycle of Dietrich of Bern* (1906). The literature of the *Heldenage* is very extensive. See especially W. Grimm, *Die deutsche Heldenage*, 3rd ed., 1880; L. Uhland, "Geschichte der deutschen Poesie im Mittelalter," *Schriften*, vol. i. (1866); O. L. Jiriczek, *Deutsche Heldenage*, vol. i. (1898); and especially B. Symons, "Germanische Heldenage," in Paul's *Grundriss der germanischen Philologie* (2nd ed., 1898).

HELDER, a seaport town at the northern extremity of the province of North Holland, in the kingdom of Holland, 51 m. by rail N.N.W. of Amsterdam. Pop. (1900) 25,842. It is situated on the Marsdiep, the channel separating the island of Texel from the mainland, and the main entrance to the Zuider Zee, and besides being the terminus of the North Holland canal from Amsterdam, it is an important naval and military station. On the east side of the town, called the Nieuwe Diep, is situated the fine harbour, which formerly served, as Ymuiden now does, as the outer port of Amsterdam. In this neighbourhood are the naval wharves and magazines, wet and dry docks, and the naval cadet school of Holland, the name Willemsoord being given to the whole naval establishment. From Nieuwe Diep to Fort Eriprins on the west side of the town, a distance of about 5 m., stretches the great sea-dike which here takes the place of the dunes. This dike descends at an angle of 40° for a distance of 200 ft. into the sea, and is composed of Norwegian granite and Belgian limestone, strengthened at intervals by projecting jetties of piles and fascines. A circle of forts and batteries defends the town and coast, and there is a permanent garrison of 7000 to 9000 men, while 39,000 men can be accommodated within the lines, and the province flooded from this point. Besides several churches and a synagogue, there are a town hall (1836), a hospital, an orphan asylum, the "palace" of the board of marine, a meteorological observatory, a zoological station and a lighthouse. The industries of the town are sustained by the garrison and marine establishments.

HELEN, or **HELENA** (Gr. Ἑλένη), in Greek mythology, daughter of Zeus by Leda (wife of Tyndareus, king of Sparta), sister of Castor, Pollux and Clytemnestra, and wife of Menelaus. Other accounts make her the daughter of Zeus and Nemesis, or of Oceanus and Tethys. She was the most beautiful woman in Greece, and indirectly the cause of the Trojan war. When a child she was carried off from Sparta by Theseus to Attica, but was recovered and taken back by her brothers. When she grew up, the most famous of the princes of Greece sought her hand in marriage, and her father's choice fell upon Menelaus. During her husband's absence she was induced by Paris, son of Priam, with the connivance of Aphrodite, to flee with him to Troy. After the death of Paris she married his brother Deiphobus, whom she is said to have betrayed into the hands of Menelaus at the capture of the city (*Aeneid*, vi. 517 ff.). Menelaus thereupon took her back, and they returned together to Sparta, where they lived happily till their death, and were buried at Therapnae in Laconia. According to another story, Helen survived her

husband, and was driven out by her stepsons. She fled to Rhodes, where she was hanged on a tree by her former friend Polyxo, to avenge the loss of her husband Tlepolemus in the Trojan War (Pausanias iii. 19). After death, Helen was said to have married Achilles in his home in the island of Leuke. In another version, Paris, on his voyage to Troy with Helen, was driven ashore on the coast of Egypt, where King Proteus, upon learning the facts of the case, detained the real Helen in Egypt, while a phantom Helen was carried off to Troy. Menelaus on his way home was also driven by stress of winds to Egypt, where he found his wife and took her home (Herodotus ii. 112-120; Euripides, *Helena*). Helen was worshipped as the goddess of beauty at Therapnae in Laconia, where a festival was held in her honour. At Rhodes she was worshipped under the name of Dendritis (the tree goddess), where the inhabitants built a temple in her honour to expiate the crime of Polyxo. The Rhodian story probably contains a reference to the worship connected with her name (cf. Theocritus xviii. 48 ἄθρον μ', Ἑλένας φέρων εἰμί). She was the subject of a tragedy by Euripides and an epic by Colluthus. Originally, Helen was perhaps a goddess of light, a moon-goddess, who was gradually transformed into the beautiful heroine round whom the action of the *Iliad* revolves. Like her brothers, the Dioscuri, she was a patron deity of sailors.

See E. Oswald, *The Legend of Fair Helen* (1905); J. A. Symonds, *Studies of the Greek Poets*, i. (1893); F. Decker, *Die griechische Helena in Mythos und Epos* (1894); Andrew Lang, *Helen of Troy* (1883); P. Paris in Daremberg and Saglio's *Dictionnaire des antiquités*; the exhaustive article by R. Engelmann in Roscher's *Lexikon der Mythologie*; and O. Gruppe, *Griechische Mythologie*, i. 163, according to whom Helen originally represented, in the Helenophoria (a mystic festival of Artemis, Iphigenia or Tauro-polos), the sacred basket (ἀσπὴν) in which the holy objects were carried; and hence, as the personification of the initiation ceremony, she was connected with or identified with the moon, the first appearance of which probably marked the beginning of the festivity.

HELENA, ST (c. 247-c. 327) the wife of the emperor Constantine I. Chlorus, and mother of Constantine the Great. She was a woman of humble origin, born probably at Drepanum, a town on the Gulf of Nicomedia, which Constantine named Helenopolis in her honour. Very little is known of her history. It is certain that, at an advanced age, she undertook a pilgrimage to Palestine, visited the holy places, and founded several churches. She was still living at the time of the murder of Crispus (326). Constantine had coins struck with the effigy of his mother. The name of Helena is intimately connected with the commonly received story of the discovery of the Cross. But the accounts which connect her with the discovery are much later than the date of the event. The Pilgrim of Bordeaux (333), Eusebius and Cyril of Jerusalem were unaware of this important episode in the life of the empress. It was only at the end of the 4th century and in the West that the legend appeared. The principal centre of the cult of St Helena in the West seems to be the abbey of Hautvilliers, near Reims, where since the 9th century they have claimed to be in possession of her body. In England legends arose representing her as the daughter of a prince of Britain. Following these Geoffrey of Monmouth makes her the daughter of Coel, the king who is supposed to have given his name to the town of Colchester. These legends have doubtless not been without influence on the cult of the saint in England, where a great number of churches are dedicated either to St Helena alone, or to St Cross and St Helena. Her festival is celebrated in the Latin Church on the 18th of August. The Greeks make no distinction between her festival and that of Constantine, the 21st of May.

See *Acta sanctorum*, Augusti iii. 548-580; Tixeront, *Les Origines de l'église d'Édesse* (Paris, 1888); F. Arnold-Forster, *Studies in Church Dedications or England's Patron Saints*, i. 181-189, iii. 16, 365-366 (1899). (H. DE.)

HELENA, a city and the county-seat of Phillips county, Arkansas, U.S.A., situated on and at the foot of Crowley's Ridge, about 150 ft. above sea-level, in the alluvial bottoms of the Mississippi river, about 65 m. by rail S.W. of Memphis, Tennessee. Pop. (1890) 5180, (1900) 5550, of whom 3400

interpolations by this second author. The date of these additions, and of the *Versus*, is of no importance, as their statements are incredible. That the author of the *Heliand* was, so to speak, another Caedmon—an unlearned man who turned into poetry what was read to him from the sacred writings—is impossible, because in many passages the text of the sources is so closely followed that it is clear that the poet wrote with the Latin books before him. On the other hand, there is no reason for rejecting the almost contemporary testimony of the first part of the *Prefatio* that the author of the *Heliand* had won renown as a poet before he undertook his great task at the emperor's command. It is certainly not impossible that a Christian Saxon, sufficiently educated to read Latin easily, may have chosen to follow the calling of a scop or minstrel¹ instead of entering the priesthood or the cloister; and if such a person existed, it would be natural that he should be selected by the emperor to execute his design. As has been said above, the tone of many portions of the *Heliand* is that of a man who was no mere imitator of the ancient epic, but who had himself been accustomed to sing of heroic themes.

The commentary on the gospel of Matthew by Hrabanus Maurus was finished about 821, which is therefore the superior limit of date for the composition of the *Heliand*. It is usually maintained that this work was written before the Old Testament poems. The arguments for this view are that the *Heliand* contains no allusion to any foregoing poetical treatment of the antecedent history, and that the Genesis fragments exhibit a higher degree of poetic skill. This reasoning does not appear conclusive, and if it be set aside, the limit of date for the beginning of the work is carried back to A.D. 814, the year of the accession of Ludwig.

BIBLIOGRAPHY.—The first complete edition of the *Heliand* was published by J. A. Schmeller in 1830; the second volume, containing the glossary and grammar, appeared in 1840. The standard edition is that of E. Sievers (1877), in which the texts of the Cotton and Munich MSS. are printed side by side. It is not provided with a glossary, but contains an elaborate and most valuable analysis of the diction, synonymy and syntactical features of the poem. Other useful editions are those of M. Heyne (3rd ed., 1903), O. Behaghel (1882) and P. Piper (1897, containing also the Genesis fragments). The fragments of the *Heliand* and the *Genesis* contained in the Vatican MS. were edited in 1894 by K. Zangemeister and W. Brauns under the title *Zerstücke der altäussischen Ebedichtung*. Among the works treating of the authorship, sources and place of origin of the poems, the most important are the following: E. Windisch, *Der Heliand und seine Quellen* (1868); E. Sievers, *Der Heliand und die angelsächsische Genesis* (1875); R. Kögel, *Deutsche Literaturgeschichte*, Bd. i. (1894) and *Die altäussische Genesis* (1895); R. Kögel and W. Bruckner, "Althoch- und altniederdeutsche Literatur," in Paul's *Grundriss der germanischen Philologie*, Bd. ii. (2nd ed., 1901), which contains references to many other works; Hermann Collitz, *Zum Dialekte des Heliand* (1901). (H. BR.)

HELICON, a mountain range, of Boeotia in ancient Greece, celebrated in classical literature as the favourite haunt of the Muses, is situated between Lake Copais and the Gulf of Corinth. On the fertile eastern slopes stood a temple and grove sacred to the Muses, and adorned with beautiful statues, which, taken by Constantine the Great to beautify his new city, were consumed there by a fire in A.D. 404. Hard by were the famous fountains, Aganippe and Hippocrene, the latter fabled to have gushed from the earth at the tread of the winged horse Pegasus, whose favourite browsing place was there. At the neighbouring Ascræ dwelt the poet Hesiod, a fact which probably enhanced the poetic fame of the region. Pausanias, who describes Helicon in his ninth book, asserts that it was the most fertile mountain in Greece, and that neither poisonous plant nor serpent was to be found on it, while many of its herbs possessed a miraculous healing virtue. The highest summit, the present Palæovouni (old hill), rises to the height of about 5000 ft. Modern travellers, aided by ancient remains and inscriptions, and guided by the local descriptions of Pausanias, have succeeded in identifying many of the ancient classical spots, and the French excavators have discovered the temple of the Muses and a theatre.

¹ The term *Volkssänger*, commonly used in German discussions of this question, is misleading; the audience for heroic poetry was not "the people" in the modern sense, but the nobles.

See also Clarke, *Travels in Various Countries* (vol. vii., 1818); Dodwell, *Classical and Topographical Tour through Greece* (1818); W. M. Leake, *Travels in Northern Greece* (vol. ii., 1835); J. G. Frazer's edition of Pausanias, v. 150.

HELICON (Fr. *hélicon*, *bombardon circulaire*; Ger. *Helikon*), the circular form of the B♭ contrabass tuba used in military bands, worn round the body, with the enormous bell resting on the left shoulder and towering above the head of the performer. The pitch of the helicon is an octave below that of the euphonium. The idea of winding the long tube of the contrabass tuba and of wearing it round the shoulders was suggested by the ancient Roman buccina and cornu, represented in mosaics and on the sculptured reliefs surrounding Trajan's Column. The buccina and cornu² differed in the diameter of their respective bores, the former having the narrow, almost cylindrical bore and harmonic series of the trumpet and trombone, whereas the cornu, having a bore in the form of a wide cone, was the prototype of the bugle and tubas.

HELIGOLAND (Ger. *Helgoland*), an island of Germany, in the North Sea, lying off the mouths of the Elbe and the Weser, 28 m. from the nearest point in the mainland. Pop. (1900) 2307. From 1807 to 1890 a British possession, it was ceded in 1890 to Germany, and since 1892 has formed part of the Prussian province of Schleswig-Holstein. It consists of two islets, the smaller, the *Dünen-Insel*, a quarter of a mile E. of the main, or *Rock Island*, connected until 1720, when it was severed by a violent irruption of the sea, with the other by a neck of land, and the main, or *Rock Island*. The latter is nearly triangular in shape and is surrounded by steep red cliffs, the only beach being the sandy spit near the south-east point, where the landing-stage is situated. The rocks composing the cliffs are worn into caves, and around the island are many fantastic arches and columns. The impression made by the red cliffs, fringed by a white beach and supporting the green Oberland, is commonly believed to have suggested the national colours, red, white and green, or, as the old Frisian rhyme goes:—

"Grün is dat Land,
Rood is de Kant,
Witt is de Sand,
Dat is de Flagg vun't hillige Land."

The lower town of Unterland, on the spit, and the upper town, or Oberland, situated on the cliff above, are connected by a wooden stair and a lift. There is a powerful light-house, and since its cession by Great Britain to Germany, the main island has been strongly fortified, the old English batteries being replaced by armoured turrets mounting guns of heavy calibre. Inside the *Dünen-Insel* the largest ships can ride safely at anchor, and take in coal and other supplies. The greatest length of the main island, which slopes somewhat from west to east, is just a mile, and the greatest breadth less than a third of a mile, its average height 198 ft., and the highest point, crowned by the church, with a conspicuous spire, 216 ft. The *Dünen-Insel* is a sand-bank protected by groines. It is only about 200 ft. above the sea at its highest point, but the drifting sands make the height rather variable. The sea-bathing establishment is situated here; a shelving beach of white sand presenting excellent facilities for bathing. Most of the houses are built of brick, but some are of wood. There are a theatre, a Kurhaus, and a number of hotels and restaurants. In 1892 a biological institute, with a marine museum and aquarium (1900) attached, was opened.

During the summer some 20,000 people visit the island for sea-bathing. German is the official language, though among themselves the natives speak a dialect of Frisian, barely intelligible to the other islands of the group. There is regular communication with Bremen and Hamburg.

The winters are stormy. May and the early part of June are wet and foggy, so that few visitors arrive before the middle of the latter month.

² For illustrations of the cornu see the altar of Julius Victor in the Collegio, reproduced in Bartoli, *Pict. Ant.* p. 76; Bellori, *Pict. antiq. crypt. rom.* p. 76, pl. viii.; in Daremberg and Saglio, *Dict. des antiq. grecques et romaines*, under "Cornu," the buccina and cornu have not been distinguished.

The generally accepted derivation of Heligoland (or Helgoland) from *Heiligeland*, i.e. "Holy Land," seems doubtful. According to northern mythology, Forseti, a son of Balder and Nanna, the god of justice, had a temple on the island, which was subsequently destroyed by St. Ludger. This legend may have given rise to the derivation "Holy Land." The more probable etymology, however, is that of Hallaglan, or Halligland, i.e. "land of banks, which cover and uncover." Here Hertha, according to tradition, had her great temple, and thither came from the mainland the Angles to worship at her shrine. Here also lived King Radbod, a pagan, and on this isle St. Willibrord in the 7th century first preached Christianity; and for its ownership, before and after that date, many sea-rovers have fought. Finally it became a fief of the dukes of Schleswig-Holstein, though often hypothecated for loans advanced to these princes by the free city of Hamburg. The island was a Danish possession in 1807, when the English seized and held it until it was formally ceded to them in 1814. In the picturesque old church there are still traces of a painted Dannebrog.

In 1890 the island was ceded to Germany, and in 1892 it was incorporated with Prussia, when it was provided that natives born before the year 1880 should be allowed to elect either for British or German nationality, and until 1901 no additional import duties were imposed.

BIBLIOGRAPHY.—Von der Decken, *Philosophisch-historisch-geographische Untersuchungen über die Insel Helgoland, oder Heiligeland, und ihre Bewohner* (Hanover, 1826); Wiebel, *Die Insel Helgoland, Untersuchungen über deren Grösse in Vorzeit und Gegenwart vom Standpunkte der Geschichte und Geologie* (Hamburg, 1843); J. M. Lappenberg, *Über den ehemaligen Umfang und die alte Geschichte Helgolands* (Hamburg, 1851); F. Otker, *Helgoland, Schilderungen und Erörterungen* (Berlin, 1855); E. Hallier, *Helgoland, Nordseestudien* (Hamburg, 1893); A. W. F. Möller, *Rechtsgeschichte der Insel Helgoland* (Weimar, 1904); W. G. Black, *Helgoland and the Islands of the North Sea* (Glasgow, 1888); E. Lindermann, *Die Nordseeinsel Helgoland in topographischer, geschichtlicher, sanitärer Beziehung* (Berlin, 1889); and Tittel, *Die natürlichen Veränderungen Helgolands* (Leipzig, 1894).

HELIOCENTRIC, i.e. referred to the centre of the sun (ἥλιος) as an origin, a term designating especially co-ordinates or heavenly bodies referred to that origin.

HELIODORUS, of Emesa in Syria, Greek writer of romance. According to his own statement his father's name was Theodosius, and he belonged to a family of priests of the sun. He was the author of the *Aethiopia*, the oldest and best of the Greek romances that have come down to us. It was first brought to light in modern times in a MS. from the library of Matthias Corvinus, found at the sack of Buda (Ofen) in 1526, and printed at Basel in 1534. Other codices have since been discovered. The title is taken from the fact that the action of the beginning and end of the story takes place in Aethiopia. The daughter of Persine, wife of Hydaspes, king of Aethiopia, was born white through the effect of the sight of a marble statue upon the queen during pregnancy. Fearing an accusation of adultery, the mother gives the babe to the care of Sisimithras, a gymnosophist, who carries her to Egypt and places her in charge of Charicles, a Pythian priest. The child is taken to Delphi, and made a priestess of Apollo under the name of Charicles. Theages, a noble Thessalian, comes to Delphi and the two fall in love with each other. He carries off the priestess with the help of Calasiris, an Egyptian, employed by Persine to seek for her daughter. Then follow many perils from sea-rovers and others, but the chief personages ultimately meet at Meroë at the very moment when Charicles is about to be sacrificed to the gods by her own father. Her birth is made known, and the lovers are happily married. The rapid succession of events, the variety of the characters, the graphic descriptions of manners and of natural scenery, the simplicity and elegance of the style, give the *Aethiopia* great charm. As a whole it offends less against good taste and morality than others of the same class. Homer and Euripides were the favourite authors of Heliodorus, who in his turn was imitated by French, Italian and Spanish writers. The early life of Clorinda in Tasso's *Jerusalem Delivered* (canto xii. 21 sqq.) is almost identical with that of Charicles; Racine meditated a drama on the same

subject; and it formed the model of the *Persles y Sigismunda* of Cervantes. According to the ecclesiastical historian Sozomenus (*Hist. eccles.* v. 22), the author of the *Aethiopia* was a certain Heliodorus, bishop of Tricca in Thessaly. It is supposed that the work was written in his early years before he became a Christian, and that, when confronted with the alternative of disowning it or resigning his bishopric, he preferred resignation. But it is now generally agreed that the real author was a sophist of the 3rd century A.D.

The best editions are: A. Coraës (1804), G. A. Hirschig (1856); see also M. Oeffering, *H. und seine Bedeutung für die Literatur*, with full bibliographies (1901); J. C. Dunlop, *History of Prose Fiction* (1888); and especially E. Rohde, *Der griechische Roman* (1900). There are translations in almost all European languages: in English, in Bohn's *Classical Library* and the "Tudor" series (v., 1895, containing the old translation by T. Underdowne, 1587, with introduction by C. Whibley); in French by Amyot and Zevort.

HELIOGABALUS (ELAGABÁLUS), Roman emperor (A.D. 218–222), was born at Emesa about 205. His real name was Varius Avitus. On the murder of Caracalla (217), Julia Maesa, Varius's grandmother and Caracalla's aunt, left Rome and retired to Emesa, accompanied by her grandsons (Varius and Alexander Severus). Varius, though still only a boy, was appointed high priest of the Syrian sun-god Elagabalus, one of the chief seats of whose worship was Emesa (Homs). His beauty, and the splendid ceremonials at which he presided, made him a great favourite with the troops stationed in that part of Syria, and Maesa increased his popularity by spreading reports that he was in reality the illegitimate son of Caracalla. Macrinus, the successor and instigator of the murder of Caracalla, was very unpopular with the army; an insurrection was easily set on foot, and on the 16th of May 218 Varius was proclaimed emperor as Marcus Aurelius Antoninus. The troops sent to quell the revolt went over to him, and Macrinus was defeated near Antioch on the 8th of June. Helioqabalus was at once recognized by the senate as emperor. After spending the winter in Nicomedia, he proceeded in 219 to Rome, where he made it his business to exalt the deity whose priest he was and whose name he assumed. The Syrian god was proclaimed the chief deity in Rome, and all other gods his servants; splendid ceremonies in his honour were celebrated, at which Helioqabalus danced in public, and it was believed that secret rites accompanied by human sacrifice were performed in his honour. In addition to these affronts upon the state religion, he insulted the intelligence of the community by horseplay of the wildest description and by childish practical joking. The shameless profligacy of the emperor's life was such as to shock even a Roman public. His popularity with the army declined, and Maesa, perceiving that the soldiers were in favour of Alexander Severus, persuaded Helioqabalus to raise his cousin to the dignity of Caesar (221), a step of which he soon repented. An attempt to murder Alexander was frustrated by the watchful Maesa. Another attempt in 222 produced a mutiny among the praetorians, in which Helioqabalus and his mother Soemias (Soaemias) were slain (probably in the first half of March).

AUTHORITIES.—Life by Aelius Lampridius in *Scriptores historiae Augustae*; Herodian v. 3–8; Dio Cassius lxxviii. 30 sqq., lxxix. 1–21; monograph by G. Durviquet, *Elagabale* (1903), containing a translation of the various accounts of Helioqabalus in Greek and Latin authors, notes, bibliography and illustrations; O. F. Butler, *Studies in the Life of Helioqabalus* (New York, 1908); Gibbon, *Decline and Fall*, ch. 6; H. Schiller, *Geschichte der römischen Kaiserzeit*, i. pt. ii. (1883), p. 759 ff. On the Syrian god see F. Cumont in Pauly-Wissowa's *Realencyclopädie*, v. pt. ii. (1905).

HELIOGRAPH (from Gr. ἥλιος, sun, and γράφω to write), an instrument for reflecting the rays of the sun (or the light obtained from any other source) over a considerable distance. Its main application is in military signalling (see SIGNAL). A similar instrument is the heliotope, used principally for defining distant points in geodetic surveys, such as in the triangulation of India, and in the verification of the African arc of the meridian. It is necessary to distinguish the method of signalling termed heliography from the photographic process of the same name (see PHOTOGRAPHY).

by Metz in 1839 on the model of Bessel's heliometer, submits the following suggestions for its improvement:¹ (1) to give automatically to the two segments simultaneous equal and opposite movement; and (2) to make the tube of metal instead of wood; to attach the heliometer head firmly to this tube; to place the eye-piece permanently in the axis of the telescope; and to fix a strong cradle on the end of the declination axis, in which the tube, with the attached head and eye-piece, could rotate on its axis.

Both suggestions are important. The first is originally the idea of Dollond; its advantages were overlooked by his son, and it seems to have been quite forgotten till suggested by Struve. But the method is not available if the separation is to be measured by screws; it is found, in that case, that the direction of the final motion of turning of the screw must always be such as to produce motion of the segment against gravity, otherwise the "loss of time" is apt to be variable. Thus the simple connexion of the two screws by cog-wheels to give them automatic opposite motion is not an available method unless the separation of the segments is independently measured by scales.

Struve's second suggestion has been adopted in nearly all succeeding heliometers. It permits complete rotation of the tube and measurement of all angles in reversed positions of the circle; the handles that move the slides can be brought down to the eye-end, inside the tube, and consequently made to rotate with it; and the position circle may be placed at the end of the cradle next the eye-end where it is convenient of access. Struve also points out that by attaching a fine scale to the focusing side of the eye-piece, and knowing the coefficient of expansion of the metal tube, the means would be provided for determining the absolute change of the focal length of the object-glass at any time by the simple process of focusing on a double star. This, with a knowledge of the temperature of the screw or scale and its coefficient of expansion, would enable the change of screw-value to be determined at any instant.

It is probable that the Bonn heliometer was in course of construction before these suggestions of Struve were published or discussed, since its construction resembles that of the Königsberg and Pulkowa instruments. Its dimensions are similar to those of the former instrument. Bessel, having been consulted by the celebrated statesman, Sir Robert Peel, on behalf of the Radcliffe trustees, as to what instrument, added to the Radcliffe Observatory, would probably most promote the advancement of astronomy, strongly advised the selection of a heliometer. The order for the instrument was given to the Repsold in 1840, but "various circumstances, for which the makers are not responsible, contributed to delay the completion of the instrument, which was not delivered before the winter of 1848."² The building to receive it was commenced in March 1849 and completed in the end of the same year. This instrument has a superb object-glass of 7½ in. aperture and 126 in. focal length. The makers availed themselves of Bessel's suggestion to make the segments move in cylindrical slides, and of Struve's to have the head attached to a brass tube; the eye-piece is set permanently in the axis, and the whole rotates in a cradle attached to the declination axis. They provided a splendid, rigidly mounted, equatorial stand, fitted with every luxury in the way of slow motion, and scales for measuring the displacement of the segments were read by powerful micrometers from the eye-end.³ It is somewhat curious that, though Struve's second suggestion was adopted, his first was overlooked by the makers. But it is still more curious that it was not afterwards carried out, for the communication of automatic symmetrical motion to both segments only involves a simple alteration previously described. But, as it came from the hands of the makers in 1849, the Oxford heliometer was incomparably the most powerful and perfect instrument in the world for the highest order of micrometric research. It so remained, unrivalled in every respect, till 1873.

As the transit of Venus of 1874 approached, preparations were set on foot by the German Government in good time; a commission of the most celebrated astronomers was appointed, and it was resolved that the heliometer should be the instrument chiefly relied on. The four long-neglected small heliometers made by Fraunhofer were brought into requisition. Fundamental alterations were made upon them: their wooden tubes were replaced by tubes of metal;

¹ *Description de l'Observatoire central de Pulkowa*, p. 208.

² Steinheil applied such motion to a double-image micrometer made for Struve. This instrument suggested to Struve the above-mentioned idea of employing a similar motion for the heliometer.

³ Manuel Johnson, M.A., Radcliffe observer. *Astronomical Observations made at the Radcliffe Observatory, Oxford, in the Year 1850*, Introduction, p. iii.

⁴ The illumination of these scales is interesting as being the first application of electricity to the illumination of astronomical instruments. Thin platinum wire was rendered incandescent by a voltaic current; a small incandescent electric lamp would now be found more satisfactory.

means of measuring the focal point were provided; symmetrical motion was given to the slides; scales on each slide were provided instead of screws for measuring the separation of the segments, and both scales were read by the same micrometer microscope; a metallic thermometer was added to determine the temperature of the scales. These small instruments have since done admirable work in the hands of Schur, Hartwig, Kütstner, Elkin, Auwers and others.

The Russian Government ordered three new heliometers (each of 4 in. aperture and 5 ft. focal length) from the Repsold, and the design for their construction was superintended by Struve, Auwers

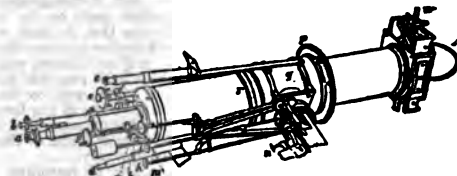

FIG. 9.

and Winnecke, the last-named making the necessary experiments at Carlsruhe. Fig. 9 represents the resulting type of instrument which was finally designed and constructed by Repsold. The brass tube, strengthened at the bearing points by strong truly turned collars, rotates in the cast iron cradle *g* attached to the declination axis. *a* is the eye-piece fixed in the optical axis, *b* the micrometer for reading both scales, *c* and *d* are telescopes for reading the position circle *p*, *e* the handle for quick motion in position angle, *f* the slow motion in position angle, *g* the handle for changing the separation of the segments by acting on the bevel-wheel *g'* (fig. 10). *h* is a milled head connected by a rod with *h'* (fig. 10), for the purpose of interposing at pleasure the prism *w* in the axis of the reading micrometer; this enables the observer to view the graduations on the face of the metallic thermometer *rr* (composed of a rod of brass and a rod of zinc). *s* is a milled head connected with the wheel *s'* (fig. 10), and affords the means of placing the screen *s* (fig. 9), counterpoised by *w* over either half of the object-glass. *k* clamps the telescope in declination, *m* clamps it in right ascension, and the handles *u* and *v* provide slow motion in declination and right ascension respectively.

The details of the interior mechanism of the "head" will be almost

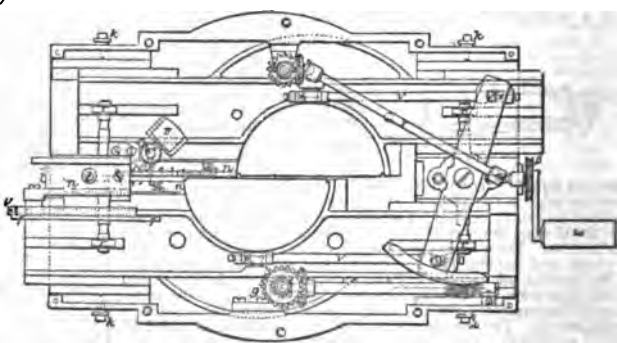

FIG. 10.

evident from fig. 10 without description. The screw, turned by the wheels at *g'*, acts in a toothed arc, whence, as shown in the figure, equal and opposite motion is communicated to the slides by the jointed rods *v, v*. The slides are kept firmly down to their bearings by the rollers *r, r, r*, attached to axes which are, in the middle, very strong springs. Side-shake is prevented by the screws and pieces *k, k, k*. The scales are at *u, u*; they are fastened only at the middle, and are kept down by the brass pieces *t, t*.

A similar heliometer was made by the Repsold to the order of Lord Lindsay for his Mauritius expedition in 1874. It differed only from the three Russian instruments in having a mounting by the Cooke in which the declination circle reads from the eye-end. This instrument was afterwards most generously lent by Lord Lindsay to Gill for his expedition to Ascension in 1877.⁴

These four Repsold heliometers proved to be excellent instruments.

⁴ For a detailed description of this instrument see *Duncker's Publications*, vol. ii.

⁵ *Mem. Royal Astronomical Society*, xlv. 1-178.

easy and convenient in use, and yielding results of very high accuracy in measuring distances. Their slow motion in position angle, however, was not all that could be desired. When small movements

the observer. This alteration and the new equatorial mounting have been admirably made by Grubb; the result is completely successful. The instrument so altered was in use at the Cape

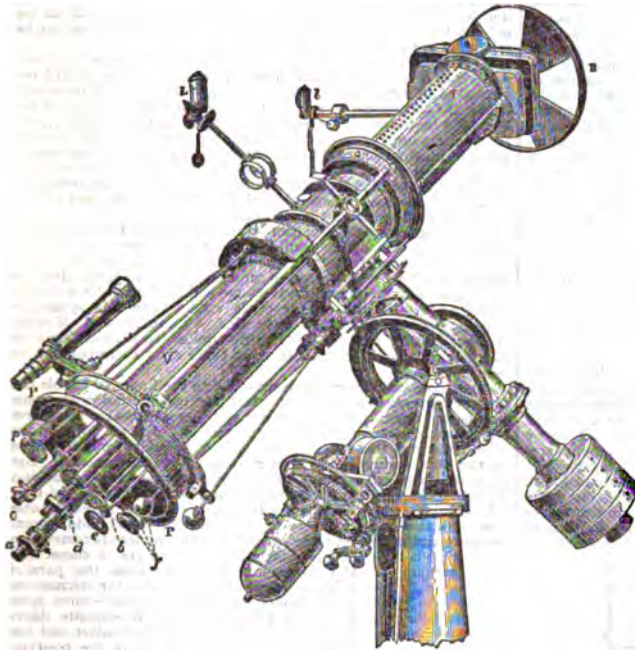

FIG. 11.

Observatory from March 1881 till 1887 in determining the parallax of some of the more interesting southern stars. The instrument then passed, by purchase from Gill, to Lord McLaren, by whom it was presented to the Royal Observatory, Edinburgh.

Still more recently the Repolds have completed a new heliometer for Yale College, New Haven, United States. The object-glass is of 6 in. aperture and 98 in. focal length. The mounting, the tube, objective-cell, slides, &c., are all of steel.¹ The instrument is shown in fig. 11. The circles for position angle and declination are read by micrometer-microscopes illuminated by the lamp L; the scales are illuminated by the lamp L. T is part of the tube proper, and turns with the head. The tube V, on the contrary, is attached to the cradle, and merely forms a support for the finder Q, the handles at f and p, and the moving ring P. The latter gives quick motion in position angle; the handles at p clamp and give slow motion in position angle, those at f clamp and give slow motion in right ascension and declination. a is the eye-piece, b the handle for moving the segments, c the micrometer microscope for reading the scales and scale micrometer, d the micrometer readers of the position and declination circles, e the handle for rotating the large wheel E which carries the screens. The hour circle is also read by microscopes, and the instrument can be used in both positions (tube preceding and following) for elimination of the effect of flexure on the position angles. Elkin found that the chief drawbacks to speed and convenience in working this heliometer were: (1) The loss of time involved in entering the corresponding readings of the micrometer pointings on two scales. (2) That an additional motion intermediate between the quick and slow motion in position angle was necessary, because, whilst the slow motion provided by Repolds was admirably adapted for adjusting the pointings in position angle, it was too slow for causing the images to "cross through" each other in the process of measuring distances. To remedy drawback (1) Repolds

were communicated to the handle e (fig. 9) by the tangent screw f, acting on a small toothed wheel clamped to the rod connected with the driving pinion, there was apt to be a torsion of the rod rather than an immediate action. Thus the slow motion would take place

devised the form of printing micrometer which is shown in figs. 12 and 13. This micrometer is provided with two pairs of parallel webs. One fixed pair of webs is attached to the micrometer-box, the other pair is moved by the

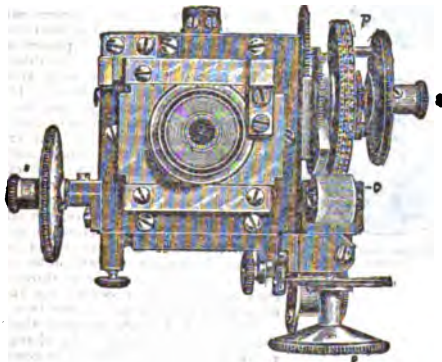

FIG. 12.

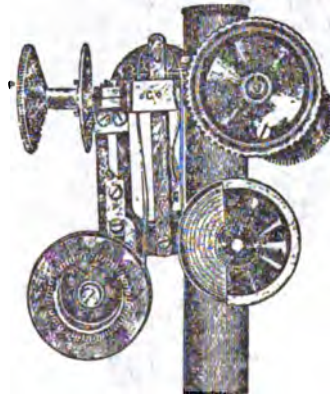

FIG. 13.

by jerks instead of with the necessary smoothness and certainty. When the heliometer-part of Lord Lindsay's heliometer was acquired by Gill in 1879, he changed the manner of imparting the motion in question. A square toothed racked wheel was applied to the tube at r (fig. 9). This wheel is acted on by a tangent screw whose bearings are attached to the cradle; the screw is turned by means of a handle supported by bearings attached to the cradle, and coming within convenient reach of the observer's hand. The tube turns smoothly in the racked wheel, or can be clamped to it at the will of

the screw attached to the heads. Accordingly, in reading the scales A and B (attached to the slides which carry the two halves of the object-glass), it is only necessary to turn the screws until the fixed

¹ The primary object was to have the object-glass mounted in steel cells, which more nearly correspond in expansion with glass. It became then desirable to make the head of steel for sake of uniformity of material, and the advantages of steel in lightness and rigidity for the tube then became evident.

Steinhell (*Journal savant de Munich*, Feb. 28, 1843) describes a "héliomètre-oculaire" which he made for the great Pulkova refractor, the result of consultations between himself and the elder Struve. It is essentially the same in principle as Amici's micrometer, except that the divided lens is an achromatic positive instead of a negative lens. Struve (*Description de l'Observatoire Central de Pulkova*, pp. 196, 197) adds a few remarks to Steinhell's description, in which he states that the images have not all desirable precision—a fault perhaps inevitable in all micrometers with divided lenses, and which is probably in this case aggravated by the fact that the rays falling upon the divided lens have considerable convergence. He, however, successfully employed the instrument in measuring double stars, so close as $1''$ or $2''$, and using a power of 300 diameters, with results that agreed satisfactorily amongst themselves and with those obtained with the filar micrometer. If Struve had employed a properly proportioned double circular diaphragm, fixed symmetrically with the axis of the telescope in front of the divided lens and turning with the micrometer, it is probable that his report on the instrument would have been still more favourable. This particular instrument has historical interest, having led Struve to some of those criticisms of the Pulkova heliometer which ultimately bore such valuable fruit (see ante).

Ramsden (*Phil. Trans.* vol. xix. p. 419) suggested the division of the small speculum of a Cassegrain telescope and the production of double image by micrometric rotation of the semispecula in the plane passing through their axis. Brewster (*Ency. Brit.* 8th ed. vol. xiv. p. 749) proposed a plan on a like principle, by dividing the plane mirror of a Newtonian telescope. Again, in an ocular heliometer by Steinhell double image is similarly produced by a divided prism of total reflection placed in parallel rays. But practically these last three methods are failures. In the last the field is full of false light, and it is not possible to give sufficiently minute and steady separation to the images; and there are of necessity a collimator, two prisms of total reflection, and a small telescope through which the rays must pass; consequently there is great loss of light.

Micrometers Depending on Double Refraction.—To the Abbé Rochon (*Jour. de phys.* liii., 1801, pp. 169-198) is due the happy idea of applying the two images formed by double refraction to the construction of a micrometer. He fell upon a most ingenious plan of doubling the amount of double refraction of a prism by using two prisms of rock-crystal, so cut out of the solid as to give each the same quantity of double refraction, and yet to double the quantity in the effect produced. The combination so formed is known as Rochon's prism. Such a prism he placed between the object-glass and eye-piece of a telescope. The separation of the images increases as the prism is approached to the object-glass, and diminishes as it is approached towards the eye-piece.

D. F. J. Arago (*Comptes rendus*, xxiv., 1847, pp. 400-402) found that in Rochon's micrometer, when the prism was approached close to the eye-piece for the measurement of very small angles, the smallest imperfections in the crystal or its surfaces were inconveniently magnified. He therefore selected for any particular measurement such a Rochon prism as when fixed between the eye and the eye-piece (i.e. where a sunshade is usually placed) would, combined with the normal eye-piece employed, bring the images about to be measured nearly in contact. He then altered the magnifying power by sliding the field lens of the eye-piece (which was fitted with a slipping tube for the purpose) along the eye-tube, till the images were brought into contact. By a scale attached to the sliding tube the magnifying power of the eye-piece was deduced, and this combined with the angle of the prism employed gave the angle measured.

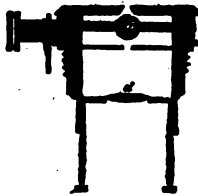

FIG. 18.

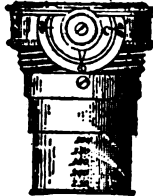

FIG. 19.

If β' is the refracting angle of the prism, and n the magnifying power of the eye-piece, then $\beta'n$ will be the distance observed. Arago made many measures of the diameters of the planets with such a micrometer.

Dollond (*Phil. Trans.*, 1821, pp. 101-103) describes a double-image micrometer of his own invention, in which a sphere of rock-crystal is substituted for the eye-lens of an ordinary eye-piece. In this instrument (figs. 18, 19) a is the sphere, placed in half-holes on the axis bb , so that when its principal axis is parallel to the axis of the telescope it gives only one image of the object. In a direction perpendicular to that axis it must be so placed that when it is moved by rotation of the axis bb the separation of the images shall be parallel to that motion. The angle of rotation is measured on

the graduated circle C . The angle between the objects measured is $= r \sin 2\theta$, where r is a constant to be determined for each magnifying power employed, and θ the angle through which the sphere has been turned from zero (i.e. from coincidence of its principal axis with that of the telescope). The maximum separation is consequently at 45° from zero. The measures can be made on both sides of zero for eliminating index error. There are considerable difficulties of construction, but these have been successfully overcome by Dollond; and in the hands of Dawes (*Mem. R.A.S.* xxiv. p. 144 seq.) such instruments have done valuable service. They are liable to the objection that their employment is limited to the measurement of very small angles, viz. $13''$ or $14''$ when the magnifying power is 100, and varying inversely as the power. Yet the beautiful images which these micrometers give permit the measurement of very difficult objects as a check on measures with the parallel-wire micrometer.

On the theory of the heliometer and its use consult Bessel, *Astronomische Untersuchungen*, vol. i.; Hansen, *Ausführliche Methode mit dem Fraunhoferischen Heliometer anzustellen* (Gotha, 1827); Chauvenet, *Spherical and Practical Astronomy*, vol. ii. (Philadelphia and London, 1876); Seeliger, *Theorie der Heliometer* (Leipzig, 1877); Linday and Gill, *Dunach's Publications*, vol. ii. (Dunach, for private circulation, 1877); Gill, *Mem. R.A.S.* vol. xvi. pp. 1-172, and references mentioned in the text. (D. G.)

HELIOPOLIS, one of the most ancient cities of Egypt, met with in the Bible under its native name On. It stood 5 m. E. of the Nile at the apex of the Delta. It was the principal seat of sun-worship, and in historic times its importance was entirely religious. There appear to have been two forms of the sun-god at Heliopolis in the New Kingdom—namely, Ra-Harakht, or Rē-Harmakhis, falcon-headed, and Etōm, human-headed; the former was the sun in his mid-day strength, the latter the evening sun. A sacred bull was worshipped here under the name Mnevis (Eg. *Mnef*), and was especially connected with Etōm. The sun-god Rē (see EGYPT: Religion) was especially the royal god, the ancestor of all the Pharaohs, who therefore held the temple of Heliopolis in great honour. Each dynasty might give the first place to the god of its residence—Ptah of Memphis, Ammon of Thebes, Neith of Saïs, Bubastis of Bubastia, but all alike honoured Rē. His temple became in a special degree a depository for royal records, and Herodotus states that the priests of Heliopolis were the best informed in matters of history of all the Egyptians. The schools of philosophy and astronomy are said to have been frequented by Plato and other Greek philosophers; Strabo, however, found them deserted, and the town itself almost uninhabited, although priests were still there, and cicrones for the curious traveller. The Ptolemies probably took little interest in their "father" Rē, and Alexandria had eclipsed the learning of Heliopolis; thus with the withdrawal of royal favour Heliopolis quickly dwindled, and the students of native lore deserted it for other temples supported by a wealthy population of pious citizens. In Roman times obelisks were taken from its temples to adorn the northern cities of the Delta, and even across the Mediterranean to Rome. Finally the growth of Fostat and Cairo, only 6 m. to the S.W., caused the ruins to be ransacked for building materials. The site was known to the Arabs as 'Ayn ash sheims, "the fountain of the sun," more recently as Tel Hism. It has now been brought for the most part under cultivation, but the ancient city walls of crude brick are to be seen in the fields on all sides, and the position of the great temple is marked by an obelisk still standing (the earliest known, being one of a pair set up by Senwosri I., the second king of the Twelfth Dynasty) and a few granite blocks bearing the name of Rameses II.

See Strabo xvii. cap. 1. 27-28; Baedeker's *Egypt*. (F. L. G.)

HELIOSTAT (from Gr. $\eta\lambda\iota\sigma$, the sun, $\sigma\tau\alpha\tau\acute{\iota}\varsigma$, fixed, set up), an instrument which will reflect the rays of the sun in a fixed direction notwithstanding the motion of the sun. The optical apparatus generally consists of a mirror mounted on an axis parallel to the axis of the earth, and rotated with the same angular velocity as the sun. This construction assumes that the sun describes daily a small circle about the pole of the celestial sphere, and ignores any diurnal variation in the declination. This variation is, however, so small that it can be neglected for most purposes.

¹ Dollond provides for changing the power by sliding the lens d nearer to or farther from a .

Many forms of heliostats have been devised, the earliest having been described by Wilhelm Jacob s'Gravesande in the 3rd edition of his *Physices elementa* (1742). One of the simplest consists of a plane mirror rigidly connected with a revolving axis so that the angle between the normal to the mirror and the axis of the instrument equals half the sun's polar distance, the mirror being adjusted so that the normal has the same right ascension as the sun. It is easily seen that if the mirror be rotated at the same angular velocity as the sun the right ascensions will remain equal throughout the day, and therefore this device reflects the rays in the direction of the earth's axis; a second fixed mirror reflects them in any other fixed direction. Foucault's heliostat reflects the rays horizontally in any required direction. The principle of the apparatus may be explained by reference to fig. 1. The axis of rotation AB bears a rigidly attached rod DBC inclined to it at an angle equal to the sun's polar distance. By adjusting the right ascension of the plane ABC and rotating the axis with the angular velocity of the sun, it follows that BC will be the direction of the solar rays throughout the day. X is the mirror rotating about the point E, and placed so that (if EB is the horizontal direction in which the rays are to be reflected) (1) the normal CE to the mirror is joined to BC at C and is equal in length to BE, (2) the rod DBC passes through a slot in a rod ED fixed to, and in the plane of, the mirror. Since CE equals BE these directions are equally inclined to, and coplanar with, the normal to the mirror. Hence light incident along the direction BC will be reflected along CE. Silbermann's heliostat reflects the rays in any direction. The principle may be explained by means of fig. 2. AB is the axis of rotation, BC an adjustable rod as in Foucault's construction, and BD is another rod which can be set to the direction in which the rays are to be reflected. The rods BC and DB carry two small rods EF, GF joined at F; at this joint there is a pin which slides in a slot on the rod BH, which is normal to the mirror X. The

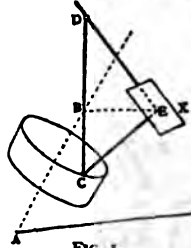

FIG. 1.

by reference to fig. 1. The axis of rotation AB bears a rigidly attached rod DBC inclined to it at an angle equal to the sun's polar distance. By adjusting the right ascension of the plane ABC and rotating the axis with the angular velocity of the sun, it follows that BC will be the direction of the solar rays throughout the day. X is the mirror rotating about the point E, and placed so that (if EB is the horizontal direction in which the rays are to be reflected) (1) the normal CE to the mirror is joined to BC at C and is equal in length to BE, (2) the rod DBC passes through a slot in a rod ED fixed to, and in the plane of, the mirror. Since CE equals BE these directions are equally inclined to, and coplanar with, the normal to the mirror. Hence light incident along the direction BC will be reflected along CE. Silbermann's heliostat reflects the rays in any direction. The principle may be explained by means of fig. 2. AB is the axis of rotation, BC an adjustable rod as in Foucault's construction, and

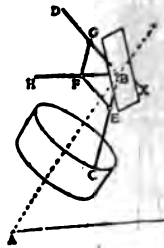

FIG. 2.

BD is another rod which can be set to the direction in which the rays are to be reflected. The rods BC and DB carry two small rods EF, GF joined at F; at this joint there is a pin which slides in a slot on the rod BH, which is normal to the mirror X. The



From Jamin and Bouty, *Cours de physique*, Gauthier-Villars.
FIG. 3.—Silbermann's Heliostat.

rods EF, GF are such that BEFG is a rhombus. It is easy to show that rays falling on the mirror in the direction BC will be reflected along BD. One construction of the instrument, described in Jamin's *Cours de physique*, is shown in fig. 3. The mirror mm is attached

to the framework pafe, the members of which are parallel to the incident and reflected rays SO, OR, and the diagonal pf is perpendicular to the mirror. The framework is attached to two independent circular arcs Cs and r' having their centres at O and provided with clamps D and A on the axis F of the instrument. The arc Cs is graduated, and is set so that the angle COD equals the complement of the sun's declination. This can be effected (after setting the axis) by rotating Cs until a needle indicates true time on the hour dial B. The arc r' is set so as to reflect the rays in the required direction. The axis F of the instrument is set at an angle equal to the latitude of the place of observation and in the meridian by means of the screw K, and rotated by clockwork contained in the barrel H. The setting in the meridian is effected by turning the instrument after setting for latitude until a pin-hole aperture s and a small screen P, placed so that Pz is parallel to CO, are in a line with the sun.

Many other forms of heliostats have been designed, the chief difference consisting in the mechanical devices for maintaining the constant direction of the reflecting ray. One of the most important applications of the heliostat is as an adjunct to the newer forms of horizontal telescopes (q.v.) and in conjunction with spectroscopic telescopes in observations of eclipses.

HELIOTROPE, or **TURNSOLE**, *Heliotropium* (Gr. ἡλιότροπον, i.e. a plant which follows the sun with its flowers or leaves, or, according to Theophrastus (*Hist. plant.* vii. 15), which flowers at the summer solstice), a genus of usually more or less hairy herbs or undershrubs of the tribe *Heliotropiaceae* of the natural order Boraginaceae, having alternate, rarely almost opposite leaves; small white, lilac or blue flowers, in terminal or lateral one-sided simple or once or twice forked spikes, with a calyx of five deeply divided segments, a salver-shaped, hypogynous, 5-lobed corolla, and entire 4-celled ovary; fruit 2- to 4-sulcate or lobed, at length separable into four 1-seeded nutlets or into two hard 2-celled carpels. The genus contains 220 species indigenous in the temperate and warmer parts of both hemispheres. A few species are natives of Europe, as *H. europaeum*, which is also a naturalized species in the southern parts of North America.

The common heliotrope of English hothouses, *H. peruvianum*, popularly known as "cherry-pie," is on account of the delicious odour of its flowers a great favourite with florists. It was introduced into Europe by the younger Jussieu, who sent seed of it from Peru to the royal garden at Paris. About the year 1757 it was grown in England by Philip Miller from seed obtained from St Germain. *H. corymbosum* (also a native of Peru), which was grown in Hammersmith nurseries as early as 1812, has larger but less fragrant flowers than *H. peruvianum*. The species commonly grown in Russian gardens is *H. suaveolens*, which has white, highly fragrant flowers.

Heliotropes may be propagated either from seed, or, as commonly, by means of cuttings of young growths taken an inch or two in length. Cuttings when sufficiently ripened, are struck in spring or during the summer months; when rooted they should be potted singly into small pots, using as a compost fibry loam, sandy peat and well-decomposed stable manure from an old hotbed. The plants soon require to be shifted into a pot a size larger. To secure early-flowering plants, cuttings should be struck in August, potted off before winter sets in, and kept in a warm greenhouse. In the spring larger pots should be given, and the plants shortened back to make them bushy. They require frequent shiftings during the summer, to induce them to bloom freely.

The heliotrope makes an elegant standard. The plants must in this case be allowed to send up a central shoot, and all the side growths must be pinched off until the necessary height is reached, when the shoot must be stopped and lateral growths will be produced to form the head. During winter they should



Heliotropium suaveolens.

to oxidize when sparked with oxygen, and on examining it spectroscopically he saw that the spectrum was not that of argon, but was characterized by a bright yellow line near to, but not identical with, the D line of sodium. This was afterwards identified with the D₂ line of the solar chromosphere, observed in 1868 by Sir J. Norman Lockyer, and ascribed by him to a hypothetical element *helium*. This name was adopted for the new gas.

Helium is relatively abundant in many minerals, all of which are radioactive, and contain uranium or thorium as important constituents. (For the significance of this fact see RADIO-ACTIVITY.) The richest known source is thorianite, which consists mainly of thorium oxide, and contains 0.5 cc. of helium per gram. Monazite, a phosphate of thorium and other rare earths, contains on the average about 1 cc. per gram. Cleveite, samarskite and fergusonite contain a little more than monazite. The gas also occurs in minute quantities in the common minerals of the earth's crust. In this case too it is associated with radioactive matter, which is almost ubiquitous. In two cases, however, it has been found in the absence of appreciable quantities of uranium and thorium compounds, namely in beryl, and in sylvine (potassium chloride). Helium is contained almost universally in the gases which bubble up with the water of thermal springs. The proportion varies greatly. In the hot springs of Bath it amounts to about one-thousandth part of the gas evolved. Much larger percentages have been recorded in some French springs (*Compt. rend.*, 1906, 143, p. 795, and 146, p. 435), and considerable quantities occur in some natural gas (*Journ. Amer. Chem. Soc.* 29, p. 1524). R. J. Strutt has suggested that helium in hot springs may be derived from the disintegration of common rocks at great depths.

Helium is present in the atmosphere, of which it constitutes four parts in a million. It is conspicuous by its absorption spectrum in many of the white stars. Certain stars and nebulae show a bright line helium spectrum.

Much the best practical source of helium is thorianite, a mineral imported from Ceylon for the manufacture of thorium. It dissolves readily in strong nitric acid, and the helium contained is thus liberated. The gas contains a certain amount of hydrogen and oxides of carbon, also traces of nitrogen. In order to get rid of hydrogen, some oxygen is added to the helium, and the mixture exploded by an electric spark. All remaining impurities, including the excess of oxygen, can then be taken out of the gas by Sir James Dewar's ingenious method of absorption with charcoal cooled in liquid air. Helium alone refuses to be absorbed, and it can be pumped off from the charcoal in a state of absolute purity. In the absence of liquid air the helium must be purified by the methods employed for argon (*q.v.*). If thorianite cannot be obtained, monazite, which is more abundant, may be utilized. A part of the helium contained in minerals can be extracted by heat or by grinding (J. A. Gray, *Proc. Roy. Soc.*, 1909, 82A, p. 301).

Properties.—All attempts to make helium enter into stable chemical union have hitherto proved unsuccessful. The gas is in all probability only mechanically retained in the minerals in which it is found. Jaquerod and Perrot have found that quartz-glass is freely permeable to helium below a red-heat (*Compt. rend.*, 1904, 139, p. 789). The effect is even perceptible at a temperature as low as 220° C. Hydrogen, and, in a much less degree, oxygen and nitrogen, will also permeate silica, but only at higher temperatures. They have made this observation the basis of a practical method of separating helium from the other inert gases. M. Travers has suggested that it may explain the liberation of helium from minerals by heat, the gas being enabled to permeate the siliceous materials in which it is enclosed. Thorianite, however, contains no silica, and until it is shown that metallic oxides behave in the same way this explanation must be accepted with reserve.

The density of helium has been determined by Ramsay and Travers as 1.98. Its ratio of specific heats has very nearly the ideal value 1.666, appropriate to a monatomic molecule. The accepted atomic weight is accordingly double the density, *i.e.*

approximately four times that of hydrogen. The refractivity of helium is 0.1238 (air=1). The solubility in water is the lowest known, being, at 18° 2', only .0073 vols. per unit volume of water. The viscosity is .96 (air=1).

The spectrum of helium as observed in a discharge tube is distinguished by a moderate number of brilliant lines, distributed over the whole visual spectrum. The following are the approximate wave-lengths of the most brilliant lines:

Red	7066
Red	6678
Yellow	5876
Green	4922
Blue	4472
Violet	4026

When the discharge passes through helium at a pressure of several millimetres, the yellow line 5876 is prominent. At lower pressures the green line 4922 becomes more conspicuous. At atmospheric pressure the discharge is able to pass through a far greater distance in helium than in the common gases.

M. Travers, G. Senter and A. Jaquerod (*Phil. Trans. A.* 1903, 200, p. 105) carefully examined the behaviour of a constant volume gas thermometer filled with helium. For the pressure coefficient per degree, between 0° and 100° C., they give the value .00366255, when the initial pressure is 700 mm. This value is indistinguishable from that which they find for hydrogen. Thus at high temperatures a helium thermometer is of no special advantage. At low temperatures, on the other hand, they find, using an initial pressure of 1000 mm., that the temperatures on the helium scale are measurably higher than on the hydrogen scale, owing to the more perfectly gaseous condition of helium. This difference amounts to about $\frac{1}{100}$ ° at the temperature of liquid oxygen, and about $\frac{1}{4}$ ° at that of liquid hydrogen.

The liquefaction of helium was achieved by H. Kamerlingh Onnes at Leiden in 1908. According to him its boiling point is 4.3° abs. (−268.7° C.), the density of the liquid 0.154, the critical temperature 5° abs., and the critical pressure 2.3 atmospheres (*Communications from the Physical Laboratory at Leiden*, No. 108; see also LIQUID GASES).

REFERENCES.—A bibliography and summary of the earlier work on helium will be found in a paper by Ramsay, *Amer. chem. phys.* (1898) [7], 13, p. 433. See also M. Travers, *The Study of Gases* (1901). (R. J. S.)

HELIX (Gr. *ἑλῆξ*, a spiral or twist), an architectural term for the spiral tendrils which is carried up to support the angles of the abacus of the Corinthian capital; from the same stalk springs a second helix rising to the centre of the capital, its junction with one on the opposite side being sometimes marked by a flower. Sometimes the term "volute" is given to the angle helix, which is incorrect, as it is of a different design and rises from the same stalk as the central helices. Its origin is probably metallic, that is to say, it was copied from the conventional treatment in Corinthian bronze of the tendrils of a plant.

HELL (O. Eng. *hel*, a Teutonic word from a root meaning "to cover," cf. Ger. *Hülle*, Dutch *hel*), the word used in English both of the place of departed spirits and of the place of torment of the wicked after death. It is used in the Old Testament to translate the Hebrew *Sheol*, and in the New Testament the Greek *ᾗδης*, Hades, and *γεέννα*, Hebrew *Gehenna* (see ESCATOLOGY).

HELLANICUS or **LESBOS**, Greek logographer, flourished during the latter half of the 5th century B.C. According to Suidas, he lived for some time at the court of one of the kings of Macedon, and died at Perperene, a town on the gulf of Adramyttium opposite Lesbos. Some thirty works are attributed to him—chronological, historical and epical. Mention may be made of: *The Priestesses of Hera at Argos*, a chronological compilation, arranged according to the order of succession of these functionaries; the *Carnaeisihæ*, a list of the victors in the Carnean games (the chief Spartan musical festival), including notices of literary events; an *Attis*, giving the history of Attica from 683 to the end of the Peloponnesian War (404), which is referred to by Thucydides (i. 97), who says that he treated the events of the years 480–431 briefly and superficially, and with

little regard to chronological sequence: *Phoronis*, chiefly genealogical, with short notices of events from the times of Phoronis the Argive "first man" to the return of the Heraclidae; *Troica* and *Persica*, histories of Troy and Persia.

Hellanicus marks a real step in the development of historiography. He transcended the narrow local limits of the older logographers, and was not content to repeat the traditions that had gained general acceptance through the poets. He tried to give the traditions as they were locally current, and availed himself of the few national or priestly registers that presented something like contemporary registration. He endeavoured to lay the foundations of a scientific chronology, based primarily on the list of the Argive priestesses of Hera, and secondarily on genealogies, lists of magistrates (e.g. the archons at Athens), and Oriental dates, in place of the old reckoning by generations. But his materials were insufficient and he often had recourse to the older methods. On account of his deviations from common tradition, Hellanicus is often called an untrustworthy writer by the ancients themselves, and it is a curious fact that he appears to have made no systematic use of the many inscriptions which were ready to hand. Dionysius of Halicarnassus censures him for arranging his history, not according to the natural connexion of events, but according to the locality or the nation he was describing; and undoubtedly he never, like his contemporary Herodotus, rose to the conception of a single current of events wider than the local distinction of race. His style, like that of the older logographers, was dry and bald.

Fragments in Müller, *Fragmenta historicorum Græcorum*, i. and iv.; see among older works L. Preller, *De Hellenico Lesbio historico* (1849); Mure, *History of Greek Literature*, iv.; late criticism in H. Kullmer, "Hellenikos" in *Jahrbücher für klass. Philologie* (Supplementband, xxvii. 455 sqq.) (1902), which contains new edition and arrangement of fragments; C. F. Lehmann-Haupt, "Hellenikos, Herodot., Thukydidēs," in *Klio* vi. 127 sqq. (1906); J. B. Bury, *Ancient Greek Historians* (1909)—pp. 27 sqq.

MELLEBORE (Gr. Ἑλλέβορος: mod. Gr. also *εὐκάλυπτος*: Ger. *Nieswurz*, *Christwurz*; Fr. *hellébore*, and in the district of Avranche, *herbe enragée*), a genus (*Helieborus*) of plants of the natural order Ranunculaceae, natives of Europe and western Asia. They are coarse perennial herbs with palmately or pedately lobed leaves. The flowers have five persistent petaloid sepals, within the circle of which are placed the minute honey-containing tubular petals of the form of a horn with an irregular opening. The stamens are very numerous, and are spirally arranged; and the carpels are variable in number, sessile or stipitate and slightly united at the base and dehiscence by ventral suture.

Helieborus niger, black hellebore, or, as from blooming in mid-winter it is termed the Christmas rose (Ger. *Schwarze Nieswurz*; Fr., *rose de Noël* or *rose d'hiver*), is found in southern and central Europe, and with other species was cultivated in the time of Gerard (see *Herball*, p. 977, ed. Johnson, 1633) in English gardens. Its knotty root-stock is blackish-brown externally, and, as with other species, gives origin to numerous straight roots. The leaves spring from the top of the root-stock, and are smooth, distinctly pedate, dark-green above, and lighter below, with 7 to 9 segments and long petioles. The scapes, which end the branches of the rhizome, have a loose entire bract at the base, and terminate in a single flower, with two bracts, from the axis of one of which a second flower may be developed. The flowers have 5 white or pale-rose, eventually greenish sepals, 15 to 18 lines in breadth; 8 to 13 tubular green petals containing honey; and 5 to 10 free carpels. There are several forms, the best being *maximus*. The Christmas rose is extensively grown in many market gardens to provide white flowers forced in gentle heat about Christmas time for decorations, emblems, &c.

H. orientalis, the Lenten rose, has given rise to several fine hybrids with *H. niger*, some of the best forms being clear in colour and distinctly spotted. *H. foetidus*, stinking hellebore, is a native of England, where like *H. viridis*, it is confined chiefly to limestone districts; it is common in France and the south of Europe. Its leaves have 7- to 11-toothed divisions, and the flowers are in panicles, numerous, cup-shaped and drooping,

with many bracts, and green sepals tinged with purple, alternating with the five petals.

H. viridis, or green hellebore proper, is probably indigenous in some of the southern and eastern counties of England, and occurs also in central and southern Europe. It has bright yellowish-green flowers, 2 to 4 on a stem, with large leaf-like bracts. O. Brunfels and H. Bock (16th century) regarded the plant as the black hellebore of the Greeks.

H. lividus, holly-leaved hellebore, found in the Balearic Islands, and in Corsica and Sardinia, is remarkable for the handsomeness of its foliage. White hellebore is *Veratrum album* (see *VERATRUM*), a liliaceous plant.

Hellebores may be grown in any ordinary light garden mould, but thrive best in a soil of about equal parts of turfy loam and



Helieborus niger. 1, Vertical section of flower; 2, Nectary, side and front view

well-rotted manure, with half a part each of fibrous peat and coarse sand, and in moist but thoroughly-drained situations, more especially where, as at the margins of shrubberies, the plants can receive partial shade in summer. For propagation cuttings of the rhizome may be taken in August, and placed in pans of light soil, with a bottom heat of 60° to 70° Fahr.; hellebores can also be grown from seed, which must be sown as soon as ripe, since it quickly loses its vitality. The seedlings usually blossom in their third year. The exclusion of frost favours the production of flowers; but the plants, if forced, must be gradually inured to a warm atmosphere, and a free supply of air must be afforded, without which they are apt to become much affected by greenfly. For potting, *H. niger* and its varieties, and *H. orientalis*, *atrorubens* and *olympicus* have been found well suited. After lifting, preferably in September, the plants should receive plenty of light, with abundance of water, and once a week liquid manure, not over-strong. The flowers are improved in delicacy of hue, and are brought well up among the leaves, by preventing access of light except to the upper part of the plants. Of the numerous species of hellebore now grown, the deep-purple-flowered *H. colchicus* is one of the handsomest; by crossing with *H. guttatus* and other species several valuable garden forms have been produced, having variously coloured spreading or bell-shaped flowers, spotted with crimson, red or purple.

The rhizome of *H. niger* occurs in commerce in irregular and nodular pieces, from about 1 to 3 in. in length, white and of a horny texture within. Cut transversely it presents internally a circle of 8 to 12 cuneiform ligneous bundles, surrounded by a thick bark. It emits a faint odour when cut or broken, and has a bitter and slightly acrid taste. The drug is sometimes adulterated with the rhizome of baneberry, *Actaea spicata*, which, however, may be recognized by the distinctly cruciate appearance of the central portion of the attached roots when

cut across, and by its decoction giving the chemical reactions for tannin.¹ The rhizome is darker in colour in proportion to its degree of dryness, age and richness in oil. A specimen dried by Schroff lost in eleven days 65% of water.

H. niger, orientalis, viridis, foetidus, and several other species of hellebore contain the glucosides *helleborin*, $C_{21}H_{33}O_{11}$, and *helleborein*, $C_{21}H_{33}O_{11}$, the former yielding glucose and *helleboresin*, $C_{20}H_{29}O_{10}$, and the latter glucose and a violet-coloured substance *helleboretin*, $C_{11}H_{15}O_5$. Helleborin is most abundant in *H. viridis*. A third and volatile principle is probably present in *H. foetidus*. Both helleborin and helleborein act poisonously on animals, but their decomposition-products helleboresin and helleboretin seem to be devoid of any injurious qualities. Helleborin produces excitement and restlessness, followed by paralysis of the lower extremities or whole body, quickened respiration, swelling and injection of the mucous membranes, dilatation of the pupil, and, as with helleborein, salivation, vomiting and diarrhoea. Helleborein exercises on the heart an action similar to that of digitalis, but more powerful, accompanied by at first quickened and then slow and laboured respiration; it irritates the conjunctiva, and acts as a sternutatory, but less violently than veratrine. Pliny states that horses, oxen and swine are killed by eating "black hellebore"; and Christison (*On Poisons*, p. 876, 11th ed., 1845) writes: "I have known severe griping produced by merely tasting the fresh root in January." Poisonous doses of hellebore occasion in man singing in the ears, vertigo, stupor, thirst, with a feeling of suffocation, swelling of the tongue and fauces, emesis and catharsis, slowing of the pulse, and finally collapse and death from cardiac paralysis. Inspection after death reveals much inflammation of the stomach and intestines, more especially the rectum. The drug has been observed to exercise a cumulative action. Its extract was an ingredient in Bacher's pills, an empirical remedy once in great repute in France. In British medicine the rhizome was formerly official. *H. foetidus* was in past times much extolled as an anthelmintic, and is recommended by Bisset (*Med. Ess.*, pp. 109 and 105, 1766) as the best vermifuge for children; J. Cook, however, remarks of it (*Oxford Mag.*, March 1769, p. 99):

"Where it killed not the patient, it would certainly kill the worms; but the worst of it is, it will sometimes kill both." This plant, of old termed by farmers ox-heel, setter-wort and setter-grass, as well as *H. viridis* (Fr. *Herbe à ânon*), is employed in veterinary surgery, to which also the use of *H. niger* is now chiefly confined in Britain.

In the early days of medicine two kinds of hellebore were recognized, the white or *Veratrum album* (see *VERATRUM*), and the black, including the various species of *Hellebore*. The former, according to Codronchius (*Cosmos... de alleb.*, 1610), Castelleus (*De helleb. epist.*, 1622), and others, is the drug usually signified in the writings of Hippocrates. Among the hellebores indigenous to Greece and Asia Minor, *H. orientalis*, the rhizome of which differs from that of *H. niger* and of *H. viridis* in the bark being readily separable from the woody axis, is the species found by Schroff to answer best to the descriptions given by the ancients of black hellebore, the $\alpha\lambda\lambda\iota\beta\omicron\rho\omicron\varsigma \mu\lambda\alpha\varsigma$ of Dioscorides. The rhizome of this plant, if identical, as may appear, with that obtained by Tournefort at Prusa in Asia Minor (*Rat. d'un voy. du Levant*, ii. 189, 1718), must be a remedy of no small toxic properties. According to an early tradition, black hellebore administered by the soothsayer and physician Melampus (whence its name *Melampodium*), was the means of curing the madness of the daughters of Proetus, king of Argos. The drug was used by the ancients in paralysis, gout and other diseases, more particularly in insanity, a fact frequently alluded to by classical writers, e.g. Horace (*Sat.* ii. 3. 80-83, *Ep. ad Pis.* 300). Various superstitions were in olden times connected with the cutting of black hellebore. The best is said by Pliny (*Nat. hist.* xxv. 21) to grow on Mt Helicon. Of the three *Anticyras* that in Phocis was the most famed for its hellebore, which, being there used combined with "sesamoides," was, according to Pliny, taken with more safety than elsewhere.

The British Pharmaceutical Conference has recommended the preparation which it terms the *tinctura veratri viridis*, as the best form in which to administer this drug. It may be given in doses of 5-15 minims. The tincture is prepared from the dried rhizome and rootlets of green hellebore, containing the alkaloids jervine, veratrine and veratrodine. It is recommended as a cardiac and nervous sedative in cerebral hæmorrhage and per cerebral eclampsia. Black hellebore is a purgative and uterine stimulant.

HELLENISM (from Gr. $\epsilon\lambda\lambda\eta\nu\iota\sigma\mu\omicron\varsigma$, to imitate the Greeks, who were known as $\epsilon\lambda\lambda\eta\nu\epsilon\varsigma$, after $\epsilon\lambda\lambda\eta\varsigma$, the son of Deucalion). The term "Hellenism" is ambiguous. It may be used to denote ancient Greek culture in all its phases, and even those elements in modern civilization which are Greek in origin or in spirit, but, while Matthew Arnold made the term popular in the latter connexion as the antithesis of "Hebraism," the German historian

J. G. Droysen introduced the fashion (1836) of using it to describe particularly the latter phases of Greek culture from the conquests of Alexander to the end of the ancient world, when those over whom this culture extended were largely not Greek in blood, i.e. *Hellenes*, but peoples who had adopted the Greek speech and way of life, *Hellenistai*. Greek culture had, however, both in "Hellenic" and "Hellenistic" times, a common essence, just as light is light whether in the original luminous body or in a reflection, and to describe this by the term Hellenism seems most natural. But whilst using the term in the larger sense, this article, in deference to the associations which have come to be specially connected with it, will devote its principal attention to Hellenism as it appeared in the world after the Macedonian conquests. But it will be first necessary to indicate briefly what Hellenism in itself implied.

No verbal formula can really enclose the life of a people or an age, but we can best understand the significance of the old Greek cities and the life they developed, when, looking at the history of mankind as a whole, we see the part played by reason, active and critical, in breaking down the barriers by which custom hinders movement, in guiding movement to definite ends, in dissipating groundless beliefs and leading onwards to fresh scientific conquests—when we see this and then take note that among the ancient Greeks such an activity of reason began in an entirely novel degree and that its activity in Europe ever since is due to their impulsion. When Hellenism came to stand in the world for something concrete and organic, it was, of course, no mere abstract principle, but embodied in a language, a literature, an artistic tradition. In the earliest existing monument of the Hellenic genius, the Homeric poems, one may already observe that regulative sense of form and proportion, which shaped the later achievements of the race in the intellectual and artistic spheres. It was not till the great colonizing epoch of the 8th and 7th centuries B.C., when the name "Hellenic" came into use as the antithesis of "barbarian," that the Greek race came to be conscious of itself as a peculiar people; it was yet some three centuries more before Hellenism stood fully declared in art and literature, in politics and in thought. There was now a new thing in the world, and to see how the world was affected by it is our immediate concern.

I. THE EXPANSION OF HELLENISM BEFORE ALEXANDER.—In the 5th century B.C. Greek cities dotted the coasts of the Mediterranean and the Black Sea from Spain to Egypt and the Caucasus, and already Greek culture was beginning to pass beyond the limits of the Greek race. Already in the 7th century B.C., when Hellenism was still in a rudimentary stage, the citizens of the Greek city-states had been known to the courts of Babylon and Egypt as admirable soldiers, combining hardihood with discipline, and Greek mercenaries came to be in request throughout the Nearer East. But as Hellenism developed, its social and intellectual life began to exercise a power of attraction. The proud old civilizations of the Euphrates and the Nile might ignore it, but the ruder barbarian peoples in East and West, on whose coasts the Greek colonies had been planted, came in various degrees under its spell. In some cases an outlying colony would coalesce with a native population, and a fusion of Hellenism with barbarian customs take place, as at Emporium in Spain (Strabo iii. p. 160) and at Locri in S. Italy (Polyb. xii. 5. 10). Perinthus included a Thracian phyle. The stories of Anacharsis and Scylas (Herod. iv. 76-80) show how the leading men of the tribes in contact with the Greek colonies in the Black Sea might be fascinated by the appeal which the exotic culture made to mind and to eye.

The great developments of the century and a half before Alexander set the Greek people in a very different light before the world. In the sphere of material power the repulse of Xerxes and the extension of Athenian or Spartan supremacy in the eastern Mediterranean were large facts patent to the most obtuse. The kings of the East leant more than ever upon Greek mercenaries, whose superiority to barbarian levies was sensibly brought home to them by the expedition of Cyrus. But the developments within the Hellenic sphere itself were also of great consequence

¹ For the microscopical characters and for figures of transverse sections of the rhizome, see Lanessan, *Hist. des drogues*, i. 6 (1878).

for its expansion outwards. The political disunion of the Greeks was to some extent neutralized by the rise of Athens to a leading position in art, in literature and in philosophy. In Athens the Hellenic genius was focussed, its tendencies drawn together and combined; nor was it a circumstance of small moment that the Attic dialect attained, for prose, a classical authority; for if Hellenism was to be propagated in the world at large, it was obviously convenient that it should have some one definite form of speech to be its medium.

1. *The Persians.*—The ruling race of the East, the Persian, was but little open to the influences of the new culture. The military qualities of the Greeks were appreciated, and so, too, was Greek science, where it touched the immediately useful; a Greek captain was entrusted by Darius with the exploration of the Indus; a Greek architect bridged the Bosphorus for him; Greek physicians (e.g. Democedes, Ctesias) were retained for enormous fees at the Persian court. The brisk diplomatic intercourse between the Great King and the Greek states in the 4th century may have produced effects that were not merely political. We certainly find among those members of the Persian aristocracy, who came by residence in Asia Minor into closer contact with the Greeks, some traces of interest in the more ideal side of Hellenism. A man like the younger Cyrus invited Greek captains to his friendship for something more than their utility in war, and procured Greek hetærae for something more than sensual pleasure. There is the Mithradates who presented the Academy with a statue of Plato by Silanion, not improbably identical (though the supposition implies a correction in the text of Diogenes Laërtius) with that Mithradates who, together with his father Ariobarzanes, received the citizenship of Athens (Dem. xxiii. 141, 202). Exactly how far Greek influence can be traced in the remains of Persian art, such as the royal palaces of Persepolis and Susa may be doubtful (see Gayet, *L'Art persan*; R. Phené Spiers, *Architecture East and West*, p. 245 f.), but it is certain that the engraved gems for which there was a demand in the Persian empire were largely the work of Greek artists (Furtwängler, *Antike Gemmen*, iii. p. 116 f.).

2. *The Phoenicians.*—As early as the first half of the 4th century we find communities of Phoenician traders established in the Peiraeus (C.I.A. ii. 86). In Cyprus, on the frontier between the Greek and Semitic worlds, a struggle for ascendancy went on. The Phoenician element seems to have been dominant in the island when Evagoras made himself king of Salamis in 412, and restored Hellenism with a strong hand. The words of Isocrates (even allowing for their rhetorical colour) give us a vivid insight into what such a process meant. "Before Evagoras established his rule, they were so hostile and exclusive, that those of their rulers were actually held to be the best who were the fiercest adversaries of the Greeks; but now such a change has taken place, that it is a matter of emulation who shall show himself the most ardent phil-hellen, that for the mothers of their children most of them choose wives from amongst us, and that they take pride in having Greek things about rather than native, in following the Greek fashion of life, whilst our masters of the fine arts and other branches of culture now resort to them in greater numbers than were once to be found in those quarters they specially frequented" (Isoc. 199 = *Evag.* §§ 49, 50). Even into the original seats of the Phoenicians Hellenism began to intrude. Evagoras at one time (about 386) made himself master of Tyre (Isoc. *Evag.* § 61; Diod. xv. 2, 4). His grandson Evagoras II. is found as governor of Sidon for the Persian king 349-346. (Babelon, *Perses Achæmenides*, p. cxxii.; cf. Diod. xvi. 46, 3).

Abdashtart, king of Sidon (374-362 B.C.), called Straton by the Greeks, had already entered into close relations with the Greek states, and imitated the Hellenic princes of Cyprus (*Athen.* xii. 531; C.I.A. ii. 86; *Corp. inscr. Semit.* i. 114). The Phoenician colonists in Sardinia purchased or imitated the work of Greek artists (Furtwängler, *Antike Gemmen*, iii. 109).

3. *The Carians and Lycians.*—The seats of the Greeks in the East touched peoples more or less nearly related to the Hellenic stock, with native traditions not so far remote from those of the Greeks in a more primitive age, the Carians and the

Lycians. It came about in the last century preceding Alexander that the first of these peoples was organized as a strong state under native princes, the line founded by Hecatomnus of Mylasa. Hecatomnus made himself master of Caria in the first decade of the 4th century, but it was under his son Mausolus, who succeeded him in 377-376 that the house rose to its zenith. These Carian princes ruled as satraps for the Great King, but they modelled themselves upon the pattern of the Greek tyrant. The capital of Mausolus was a Greek city, Halicarnassus, and all that we can still trace of his great works of construction and adornment shows conformity to the pure Hellenic type. His famous sepulchre, the Mausoleum (the remains of it are now in the British Museum), was a monument upon which the most eminent Greek sculptors of the time worked in rivalry (Plin. *N.H.* xxxvi. 5, § 30; Vitruv. vii. 13). His court gave a welcome to the vagrant Greek philosopher (Diog. Laërt. viii. 8, § 87). Even the Carian town of Mylasa now shows the forms of a Greek city and records its public decrees in Greek (C.I.G. 2691 c, d, e = Michel 471). In Lycia, which in spite of "the son of Harpagus" and King Pericles, had never been brought under one man's rule, the Greek influence is more limited. Here, for the most part in the inscriptions, the native language maintains itself against Greek. The proper names are (if not native) mainly Persian. But the Greek language makes an occasional appearance; Greek names are borne by others beside Pericles. The coins are Greek in type. And above all the monumental remains of Lycia show strong Greek influence, especially the well-known "Nereid Monument" in the British Museum, whose date is held to go back to the 5th century (Gardner, *Handbook of Gk. Sculpt.* p. 344).

4. *South Russia.*—Hellenic influences continued to penetrate the Scythian peoples from the Greek colonies of the Black Sea, at any rate in the matter of artistic fabrication. Our evidence is the actual objects recovered from the soil. (See SCYTHIA.)

5. *Egypt.*—From the time of Psammeticus (d. 610 B.C.) Greek mercenaries had been used to prop Pharaoh's throne. At the same time Greek merchants had begun to find their way up the Nile and even to the Oases. A Greek city Naucratis (q.v.) was allowed to arise at the Bolbitinic mouth of the Nile. But the racial repugnance to the Greek, which forbade an Egyptian even to eat an animal which had been carved with a Greek's knife (Hdt. ii. 41), probably kept the soul of the people more shut against Hellenic influences than was that of the other races of the East.

6. *Macedonia.*—In Macedonia the native chiefs had been attracted by the rich Hellenic life at any rate from the beginning of the 5th century, when Alexander I., surnamed "Phil-hellen," persuaded the judges at Olympia that the Temenid house was of good Argive descent (Hdt. v. 22). And, although their enemies might stigmatize them as barbarians, the Macedonian kings maintained that they were not Macedonians, but Greeks (cf. *ἄνθρωπος Ἑλλήνων βασιλεὺς*, Hdt. v. 20). It was not probably till the reorganization of the kingdom by Archelaus (413-399) that Greek culture found any abundant entrance into Macedonia. Now all that was most brilliant in Greek literature and Greek art was concentrated in the court of Aegae; the palace was decorated by Zeuxis; Euripides spent there the end of his days. From that time, no doubt, a certain degree of literary culture was general among the Macedonian nobility; their names in the days of Philip are largely Greek; the Macedonian service was full of men from the Greek cities within Philip's dominions. The values recognized at the court would naturally be recognized in noble families generally, and Philip chose Aristotle to be the educator of his son. How far the country generally may be regarded as Hellenized is a problem which involves the vexed question what right the Macedonian people itself has to be classed among the Hellenes, and Macedonian to be considered a dialect of Greek.¹ As the literary and official language, Greek alone would seem to have had any status.

¹ See, among recent writers, on one side Kaerst, *Gesch. des hellenist. Zeitalters*, pp. 97 f., and on the other Beloch, *Griech. Gesch.*, iii. [i.] 1-9; Kretschmer, *Einführung in die Gesch. d. griech. Sprache*, p. 283 f.; O. Hoffmann, *Die Makedonen, ihre Sprache u. ihr Volkstum* (1906).

7. *In the West: the Native Races of Sicily.*—Italy and the south of Gaul had not remained unaffected by the neighbourhood of the Greek colonies. Under the rule of the elder and younger Dionysius in the 4th century, the hellenization of the Sicels in the interior of Sicily seems to have become complete (Freeman, *History of Sicily*, ii. 387, 388, 422-424; Beloch, *Griech. Gesch.* iii. [i.] s61).

The alphabets used by the various Italian races from the 5th century were directly or indirectly learnt from the Greeks. The peoples of the south (Lucanians, Bruttians, Mamertines) show a Greek principle of nomenclature (Mommson, *Unterital. Dialekt*, p. 240 f.). The Pythagorean philosophy, whose seat was in southern Italy, won adherents among the native chiefs (Cic. *De senec.* 12, cf. Dio Chrysa. *Orat. Cor.* 37, § 24). From the Greeks of southern Gaul Hellenic influences penetrated the Celtic races so far that imitations of Greek coins were struck even on the coasts of the Atlantic.

II. AFTER ALEXANDER THE GREAT.—When we review generally the extent to which Hellenism had penetrated the outer world in the middle of the 4th century B.C., it must be admitted that it had not seriously affected any but the more primitive races which dwelt upon the borders of the Hellenic lands, and here it would seem, with the doubtful exception of the Macedonians, to have been an affair rather of the courts than of the life of the people. On the other hand it must be taken into account that Hellenism had as yet only been a very short while in the world. What would have happened had it continued to depend upon its spiritual force only for propagation we cannot say. Everything was changed when by the conquests of Alexander (334-323) it suddenly rose to material supremacy in all the East as far as India, and when cities of Greek speech and constitution were planted by the might of kings at all the cardinal points of intercourse within those lands. The values honoured by the rulers of the world must naturally impress themselves upon the subject multitudes. The Macedonian chiefs found their pride in being champions of Hellenism. Of Alexander there is no need to speak. The courts of his successors in Asia Minor, Syria and Egypt were Greek in language and atmosphere. All kings liked to win the good word of the Greeks by munificence bestowed upon Greek cities and Greek institutions. All of them in some degree patronized Greek art and letters, and some sought fame for themselves as authors. Even the barbarian courts, their neighbours or vassals, were swayed by the dominant fashion to imitation. But by the courts alone Hellenism could never have been propagated far. Greek culture had been the product of the city-state, and Hellenism could not be dissevered from the city. It was upon the system of Greek and Macedonian cities, planted by Alexander and his successors, that their work rested, and though their dynasties crumbled, their work remained. Rome, when it stepped into their place, did no more than safeguard its continuance; in the East Rome acted as a Hellenistic power, and if, when the legions had thundered past, the brooding East "plunged in thought again," that thought was largely directed by the Greek schoolmaster who followed in the legions' train. From our present point of view we may therefore regard this work of Hellenism as one continuous process, initiated by the Macedonians and carried on under Roman protection, and ask in the first place what the institution of a Greek city implied.

The Character of the New Greek Cities.—The citizen bodies at the outset were really of Greek or Macedonian blood—soldiers who had served in the royal armies, or men attracted from the older Greek cities to the new lands thrown open to commerce. To fix their European soldiery upon the new soil was an obvious necessity for the Macedonian chiefs who had set up kingdoms among the barbarians, and the lots of the veterans (except in Egypt) were naturally attached to various urban centres. The cities, of course, drew in numbers beside of the people of the land; Alexander is specially said to have incorporated large bodies of natives in some of the new cities of the Eastern provinces (Arr. iv. 4, 1; Diod. xvii. 83, 2; Curtius ix. 10, 7). It may generally be taken for granted that the lower strata of the city-

populations was mainly native; to be included in the city population was not, however, to be included in the citizen body, and it remains a question how far the latter admitted members of other than European origin (Beloch iii. [i.] 414). The statements, for instance, of Josephus that the Jews were given full citizen rights in the new foundations are probably false (Willrich, *Juden und Griechen vor der makkabäischen Erhebung*, 1895, p. 19 f.). The social organization of the citizen-body conformed to the regular Hellenic type with a division into *phylae* and, in Egypt, at any rate, into *demi* (Liban. *Or.* xix. 62; Satyrus, frag. 21 = *P.H.G.* iii. 164; Sir W. M. Ramsay, *Cities and Bishoprics*, i. 60; Kenyon, *Archiv f. Papyr.* ii. 74; Jonguet, *Bull. corr. hell.* xxi., 1897, 184 f.; Liebenam, *Städteverwaltung*, 220 f.). The cities appear equally Hellenic in their political organs and functions with *polis* and *demos* and popularly elected magistrates. Life was filled with the universal Hellenic interests, which centred in the gymnasium and the religious festivals, these last including, of course, not only athletic contests but performances of the classical dramas or later imitations of them. The wandering sophist and rhetoricians would find a hearing no less than the musical artist. The language of the upper classes was Greek; and the material background of building and decoration, of dress and furniture, was of Greek design. A greater regularity in the street-plans seems to have distinguished the new cities from the older slowly grown cities of the Greek lands, just as it distinguishes the cities of the New World to-day from those of Europe. Alexandria and Antioch were both traversed from end to end by one long straight street, crossed by shorter ones at right angles; Nicaea was a square from the centre of which all the four gates could be seen at the ends of the intersecting thoroughfares (Strabo xii. 565); similar characteristics are noted in the rebuilt Smyrna (ib. xiv. 646).

Sometimes the Greek city was not an absolutely new foundation, but an old Oriental city, re-colonized and transformed. And in such cases the old name was often replaced by a Greek one. Thus Caesarea in Phrygia became Apamea; Haleb (Aleppo) in Syria became Beroea; Nisibis in Mesopotamia, Antioch; Rhagae (Rai) in Media, Europus. In some cases the old name was left unchanged, e.g. Thyatira, Damascus and Samaria. Even where there was no new foundation the older cities of Phoenicia and Syria became transformed from the overwhelming prestige of Hellenic culture. In Tyre and Sidon, no less than in Antioch or Alexandria, Greek literature and philosophy were seriously cultivated, as we may see by the great names which they contributed. The process by which Hellenism thus leavened an older city we may trace with peculiar vividness in the case of Jerusalem; we see there the younger generation captivated by its ideals, the appearance of gymnasium and theatre, the eager adoption of Greek political forms (1 Macc. 1. 13 f.; 2 Macc. 4., 10 f.).

A. *Characteristics of Hellenism after Alexander.*—To the number of Greek city-states existing before Alexander were now therefore added those which extended Hellas as far as India. With the enormous extension of Greek territory a great shifting took place in the old centres of gravity. What changes in the character of Greek culture did the new conditions of the world bring about?

Hellenism had been the product of the free life of the Greek city-state, and after Chaeronea the great days of the city-state were past. Not that all liberty was everywhere extinguished. Under Alexander himself the Greek ^{Government} states were restive, and Aetolia unsubdued; and, with the break-up of the empire at Alexander's death, there was once more scope for the action of the individual cities among the rival great powers. In the history of the next two or three centuries the cities are by no means ciphers. Rhodes takes a great part in *Walpolitik*, as a sovereign ally of one or other of the royal courts. In Greece itself the overlordship to which the Macedonian king aspires is imperfect in extent and only maintained to that extent by continual wars. The Greek states on their side show that they are capable even of progressive

political development, the needs of the time being met by the federal system, by larger unions of equal members than the leading cities of the past would have tolerated, with their extreme unwillingness to forego the least shred of sovereign independence. The Achaean and Aetolian Leagues are independent powers, which the Macedonian can indeed check by garrisons in Corinth, Chalcis and elsewhere, but which keep a field clear for Hellenic freedom within their borders. Sparta also is a power which can cross swords with the Macedonian king, and Cleomenes III. aspires to unite the Peloponnesus under his leadership. As to the cities outside Greece, within or around the royal realms, Seleucid, Ptolemaic or Attalid, their degree of freedom probably differed widely according to circumstances. At one end of the scale, cities of old renown, e.g. Lampsacus or Smyrna, could still make good their independence against Antiochus III. at the beginning of the 2nd century B.C. At the other end of the scale the cities which were royal capitals, e.g. Alexandria, Antioch and Pergamum, were normally controlled altogether by royal nominees. At Pergamum indeed and (at any rate after Antiochus IV.) at Antioch, forms of self-government subsisted upon which, of course, the court had its hand, whilst at Alexandria even such forms were wanting. Between the two extremes there was variation not only between city and city, but, no doubt, in one and the same city at different times. In Syria the independent action of the cities greatly increased during the last weakness of the Seleucid monarchy. With the extension of the single strong rule of Rome over this Hellenistic world, the conditions were changed. Just as the Macedonian conquest, whilst increasing the domain of Greek culture, had straitened Greek liberty, so Rome, whilst bringing Hellenism finally into secure possession of the nearer East, extinguished Greek freedom altogether. Even now the old forms were long religiously respected. Formally, the most illustrious Greek states, Athens, for instance, or Marseilles, or Rhodes, were not subjects of Rome, but free allies. Even in the case of *civitates stipendiariae* (tribute-paying states), municipal autonomy, subject indeed to interference on the part of the Roman governor, was allowed to go on. *Bourg* and *demos* long continued to function. The old catchword, "autonomy of the Hellenes," was still heard and indeed was solemnly proclaimed by Nero at the Isthmian games of A.D. 67. But during the first centuries of the Christian era, this municipal autonomy, by a process which can only be imperfectly traced in detail, decayed. The *demos* first sank into political annihilation and the council, no longer popularly elected but an aristocratic order, concentrated the whole administration in its hands. By the end of the 2nd century A.D., claims made by the imperial government upon the municipal senate are more and more changing membership of the order from an honour into an intolerable burden, and financial disorganization is calling on imperial officials in one place after another to undertake the business of government. After Diocletian and under the Eastern Empire the Greek world is organized on the principles of a vast bureaucracy.

With this long process of political decline from Alexander to Diocletian correspond the inner changes in the temper of the Hellenic and Hellenistic peoples. There were, of course, marked differences between one region and another.

Social changes. But certain general characteristics distinguished at once Greek society after the Macedonian conquests from the society of the earlier age. When the vast field of the East was opened to Hellenic enterprise and the bullion of its treasures flung abroad, fortunes were made on a scale before unparalleled. A new standard of sumptuousness and splendour was set up in the richest stratum of society. This material elaboration of life was furthered by the existence of Hellenistic courts, where the great ministers amassed fabulous riches (e.g. Dionysius, the state secretary of Antiochus IV., Polyb. xxxi. 3, 16; Hermias, the chief minister of Seleucus III., and Antiochus III., Polyb. v. 50. 2; cf. Plutarch, *Agis* 9), and of huge cities like Alexandria, Antioch and the enlarged Ephesus. It is significant that whereas the earlier Greeks had used precious stones only as a medium for the engraver's art, engraved gems, valuable for their

mere material, now came to be used in profusion for adornment. Already before Alexander pan-hellenic feeling had in various ways overridden the internal divisions of the Greek race, but now, with the vast mingling of Greeks of all sorts in the newly-conquered lands, a generalized Greek culture in which the old local characteristics were merged, came to overspread the world. The gradual supersession of the old dialects by the *Koine*, the common speech of the Greeks, a modification of the Attic idiom coloured by Ionic, was one obvious sign of the new order of things (see GREEK LANGUAGE).

In its artistic, its literary, its spiritual products the age after Alexander gave evidence of the change. In no department did activity immediately stop; but the old freshness and creative exuberance was gone. Artistic pleasure, grown less delicate, required the stimulus of a more sensational effect or a more striking realism, as we may see by the Pergamene and Rhodian schools of sculpture, by the bas-reliefs with the *genre* subjects drawn from the life of the countryside, or, in literature by the sort of historical writing which became popular with Cleitarchus and Duris, by the studied emotional or rhetorical point of Callimachus, and by the portrayal of country life in Theocritus. At the same time, artists and men of letters were now addressing themselves in most cases, not to their fellow-citizens in a free city, but to kings and courtiers, or the educated class generally of the Greek world. In those departments of intellectual activity which demand no high ideal faculty, in the study of the world of fact, the centuries immediately following Alexander witnessed notable advance. Scientific research might prosper, just as poetry withered, under the patronage of kings, and such research had now a vast amount of new material at its disposal and could profit by the old Babylonian and Egyptian traditions. The medical schools, especially that of Alexandria, really enlarged knowledge of the animal frame. Knowledge of the earth gained immensely by the Macedonian conquests. The literary schools of Alexandria and Pergamum built up grammatical science, and brought literary and artistic criticism to a fine point. If indeed the earlier ages had been those of creative and spontaneous life, the Hellenistic age was that of conscious criticism and book-learning. The classical products were registered, studied, assorted and commented upon. Men travelled and read more. Books were in demand and were multiplied. Libraries became a feature of the age, the kings leading the way as collectors, of books, especially the rival dynasties of Egypt and Pergamum. The library attached to the Museum at Alexandria is said to have contained at the time of its destruction in 47 B.C. as many as 700,000 rolls (Aul. Gell. vi. 17. 3). Even smaller cities, like Aphrodisias in Caria, had public libraries for the instruction of their youth (Le Bas, III. No. 1618).

With the general decay of ancient civilization under the Roman empire, even scientific research ceased, and though there were literary revivals, like that connected with the new Atticism under the Antonine emperors, these were mainly imitative and artificial, and even learning became at last under the Byzantine emperors a jejune and formal tradition (see GREEK LITERATURE).

The diffusion of the Greek race far from the former centres of its life, the mingling of citizens of many cities, the close contact between Greek and barbarian in the conquered lands—all this had made the old sanctions of civic religion and civic morality of less account than ever. New guides of life were needed. The Stoic philosophy, with its cosmopolitan note, its fixed dogmas and plain ethical precepts, came into the world at the time of the Macedonian conquests to meet the needs of the new age. Its ideas became popular among ordinary men as the older philosophies had never been. The Stoic or Cynic preacher, attacking the ways of society, in pungent, often coarse, phrase, became a familiar figure of the Greek market-place (P. Wendland, *Beiträge zur Gesch. d. griech. Philosophie*, 1895).

Although the cults of the old Greek deities in the new cities, with their splendid apparatus of festivals and sacrifice might still hold the multitude, men turned ever in large numbers to alien

Art and literature.

Religion and philosophy.

religions, felt as more potent because strange, and the various gods of Egypt and the East began to find larger entrance in the Greek world. Even in the old Greek religion before Alexander there had been large elements of foreign origin, and that the Greeks should now do honour to the gods of the lands into which they came, as we find the Cilician and Syrian Greeks doing to Baal-tars and Baal-murood and the Egyptian Greeks to the gods of Egypt; was only in accordance with the primitive way of thinking. But it was a sign of the times when Serapis and Isis, Osiris and Anubis began to take place among the popular deities in the old Greek lands. The origin of the cult of Serapis, which Ptolemy I. found, or established, in Egypt is disputed; the familiar type of the god is the invention of a Greek artist, but the name and religion came from somewhere in the East (see discussion under SERAPIS). Before the end of the 2nd century B.C. there were temples of Serapis in Athens, Rhodes, Delos and Orchomenos in Boeotia. Under the Roman empire the cult of Isis, now furnished with an official priesthood and elaborate ritual, became really popular in the Hellenistic world. King Asoka in the 3rd century B.C. sent Buddhist missionaries from India to the Mediterranean lands; their preaching has, it is true, left little or no trace in our Western records. But other religions of Oriental origin penetrated far, the worship of the Phrygian Great Mother, and in the 2nd century A.D. the religion of the Mithras (*Lafaye, Culte des divinités alexandrines*, 1884; Roacher, articles "Anubis," "Isis," &c.; F. Cumont, *Mystères de Mithra*, Eng. trans., 1903; *Les Religions orientales dans le paganisme romain*, 1906).

The Jews, too, by the time of Christ were finding in many quarters an open door. Besides those who were ready to go the whole length and accept circumcision, numbers adopted particular Jewish practices, observing the Sabbath, for instance, or turned from polytheism to the doctrine of the One God. The synagogues in the Gentile cities had generally attached to them, in more or less close connexion a multitude of those "who feared God" and frequented the services (Schürer, *Gesch. d. jüd. Volks*, iii. 102-135).

Among the religions which penetrated the Hellenistic world from an Eastern source, one ultimately overpowered all the rest and made that world its own. The inter-action of Christianity and Hellenism opens large fields of inquiry.

The teaching of Christ Himself contained, as it is given to us, no Hellenic element; so far as He built with older material, that material was exclusively the sacred tradition of Israel. So soon, however, as the Gospel was carried in Greek to Greeks, Hellenic elements began to enter into it, in the writings, for instance, of St Paul, the appeal to what "nature" teaches would be generally admitted to be the adoption of a Greek mode of thought. It was, of course, impossible that speaking in Greek and living among Greeks, Christians should not to some extent use current conceptions for the expression of their faith. There was, at the same time, in the early Church a powerful current of feeling hostile to Greek culture, to the wisdom of the world. What the attitude of the New People should be to it, whether it was all bad, or whether there were good things in it which Christians should appropriate, was a vital question that always confronted them. The great Christian School of Alexandria represented by Clement and Origen effected a durable alliance between Greek education and Christian doctrine. In proportion as the Christian Church had to go deeper into metaphysics in the formulation of its belief as to God, as to Christ, as to the soul, the Greek philosophical terminology, which was the only vehicle then available for precise thought, had to become more and more an essential part of Christianity. At the same time Christian ethics incorporated much of the current popular philosophy, especially large Stoical elements. In this way the Church itself, as we shall see, became a propagator of Hellenism (see Hatch, *Hibbert Lectures*, 1888; Wendland, "Christentum u. Hellenismus" in *Neue Jahrb. f. kl. Alt.* ix. 1902, p. 1 f.; and *Die hellenistisch-römische Kultur in ihren Beziehungen zu Judentum u. Christentum*, 1907).

B. *Effect upon non-Hellenic Peoples.*—Hellenism secured by the Macedonian conquest *points d'appui* from the Mediterranean to

India, and brought the system of commerce and intercourse into Greek hands. What effect did it produce in these various countries? What effect again in the lands of the West which fell under the sway of Rome?

(1) *India.*—In India (including the valleys of the Kabul and its northern tributaries, then inhabited by an Indian, not, as now, by an Iranian, population) Alexander planted a number of Greek towns. Alexandria "under the ^{Greek} Caucasus" commanded the road from Bactria over the Hindu-Kush; it lay somewhere among the hills to the north of Kabul, perhaps at Opian near Charikar (MacCrimmon, *Ancient India*, p. 37, note 4); that it is the city meant by "Alasadda the capital of the Yona (Greek) country" in the Buddhist Mahavanso, as is generally affirmed, seems doubtful (Tarn, *loc. cit.* below, p. 269, note 7). We hear of a Nicaea in the Kabul valley itself (near Jalalabad?), another Nicaea on the Hydaspes (Jhelum) where Alexander crossed it, with Bucephala (see BUCEPHALUS) opposite, a city (unnamed) on the Acesines (Chenab) (Arr. vi. 29, 3), and a series of foundations strung along the Indus to the sea. Soon after 321, Macedonian supremacy beyond the Indus collapsed before the advance of the native Maurya dynasty, and about 303 even large districts west of the Indus were ceded by Seleucus. But the chapter of Greek rule in India was not yet closed. The Maurya dynasty broke up about 180 B.C., and at the same time the Greek rulers of Bactria began to lead expeditions across the Hindu-Kush. Menander in the middle of the 2nd century B.C. extended his rule from the Hindu-Kush to the Ganges. Then "Scythian" peoples from central Asia, Sakas and Yue-chi, having conquered Bactria, gradually squeezed within ever-narrowing limits the Greek power in India. The last Greek prince, Hermaeus, seems to have succumbed about 30 B.C. It was just at this time that the Graeco-Roman world of the West was consolidated as the Roman Empire, and, though Greek rule in India had disappeared, active commercial intercourse went on between India and the Hellenistic lands. How far, through these changes, did the Greek population settled by Alexander or his successors in India maintain their distinctive character? What influence did Hellenism during the centuries in which it was in contact with India exert upon the native mind? Only extremely qualified answers can be given to these questions. Capital data are possibly waiting there under ground—the Kabul valley for instance is almost virgin soil for the archaeologist—and any conclusion we can arrive at is merely provisional. If certain statements of classical authors were true, Hellenism in India flourished exceedingly. But the philhellenic Brahmins in Philostratus' life of Apollonius had no existence outside the world of romance, and the statement of Dio Chrysostom that the Indians were familiar with Homer in their own tongue (*Or.* liii. 6) is a traveller's tale. India, the sceptical observe, has yielded no Greek inscription, except, of course, on the coins of the Greek kings and their Scythian rivals and successors. To what extent can it be inferred from legends on coins that Greek was a living speech in India? Perhaps to no large extent outside the Greek courts. The fact, however, that the Greek character was still used on coins for two centuries after the last Greek dynasty had come to an end shows that the language had a prestige in India which any theory, to be plausible, must account for. If we argue by probability from what we know of the conditions, we have to consider that the Greek rule in India was all through fighting for existence, and can have had "little time or energy left for such things as art, science and literature" (Tarn, *loc. cit.* p. 292), and it is pointed out that a casual reference to the Greeks in an Indian work contemporary with Menander characterizes them as "viciously valiant Yonas." How long is it probable that Greek colonies planted in the midst of alien races would have remained distinct? Mr Tarn builds much upon the fact that the descendants of the Greek Branchidae settled by Xerxes in central Asia had become bilingual in six generations (Curt. vii. 5, 29). But the Greek race before Alexander had not its later prestige, and we must consider such a sentiment as leads the Eurasians to-day to cling to his Western parentage, so that the instance of the Branchidae cannot be

used straight away for the time after Alexander. Certainly, had the Greek colonies in India been active political bodies, we could hardly have failed to find some trace of them, in civic architecture or in inscriptions, by this time. Perhaps we should rather think of them as resembling the Greeks found to-day dispersed over the nearer East with interests mainly commercial, easily assimilating themselves to their environment. A notice derived from Agatharchides (about 140 B.C.) possibly refers to the activity of the Indian Greeks in the sea-borne trade of the Indian Ocean (Müller, *Geog. Graeci min.* i. p. 191; cf. Diod. iii. 47. 9). As to what India derived from Greece there has been a good deal of erudite debate. That the Indian drama took its origin from the Greek is still maintained by some scholars, though hardly proved. There is no doubt that Indian astronomy shows marked Hellenic features, including actual Greek words borrowed. But by far the most signal borrowing is in the sphere of art. The stream of Buddhist art which went out eastwards across Asia had its rise in North-West India, and the remains of architecture and sculpture unearthed in this region enable us to trace its development back to pure Greek types. It remains, of course, a question whether the tradition was transmitted by the Greek dynasties from Bactria or by intercourse with the Roman empire; the latter seems now almost certain; but the fact of the influence is equally striking on either theory. How far to the east the distinctive influences of Greece went is shown by the seal-impressions with Athena and Eros types found by Dr Stein in the buried cities of Khotan (*Sand-buried Ruins of Khotan*, p. 396), and according to Mr E. B. Havell, there exist "paintings treasured as the most precious relics and rarely shown to Europeans, which closely resemble the Graeco-Buddhist art of India" in some of the oldest temples of Japan (*Studio*, vol. xxvii. 1903, p. 26).

See A. A. Macdonell, *History of Sanskrit Literature* (1900) p. 411 f., and the references on p. 452; V. A. Smith, *Early History of India* (1904); Grünwedel, *Buddhist Art in India* (Eng. trans., edited by Dr Burgess, 1901); W. W. Tarn, "Notes on Hellenism in Bactria and India" in *Journal of Hell. Studies*, xii. (1902); Foucher, *L'Art gréco-bouddhique du Gandhâra* (1905).

(ii.) *Iran and Babylonia.*—The colonizing activity of Alexander and his successors found a large field in Iran where, up till this time, hardly any walled towns seem to have existed. Cities now arose in all its provinces, superseding in many cases native market places and villages, and holding the vantage-points of commerce. Media, Polybius says, was defended by a chain of Greek cities from barbarian incursion (x. 27. 3); in the neighbourhood of Teheran seem to have stood Heraclea and Esopus. In Eastern Iran the cities which are its chief places to-day then bore Greek names, and looked upon Alexander or some other Hellenic prince as their founder. Khujend, Herat, Kandahar were Alexandrias, Merv was an Alexandria till it changed that name for Antioch. When the farther provinces broke away under independent Greek kings, a Eucratides and a Demetrius attested their glory. Even in a town definitely barbarian like Syrinca in 209 B.C. there was a resident mercantile community of Greeks (Polyb. x. 31). The bulk of Greek historical literature having perished, and in the absence of both archaeological data from Iran, we can only speculate on the inner life of these Greek cities under a strange sky. One precious document is the decree of Antioch in Persis (about 206 B.C.) cited in a recently discovered inscription (Kern, *Inschr. v. Magnesia*, No. 67; Dittenberger, *Oriental. gr. Inschr.* i. No. 233). This shows us the normal organs of a Greek city, *boule*, *ecclesia*, *prytaneis*, &c., in full working, with the annual election of magistrates, and ordinary forms of public action. But more than this, it throws a remarkable light upon the solidarity of the Hellenic Dispersion. The citizen body had been increased some generations before by colonists from Magnesia-on-Meander sent at the invitation of Antiochus I. The Magnesians are instigated by pan-hellenic enthusiasm. And we see a brisk diplomatic intercourse between the scattered Greek cities going on. It is especially the local religious festivals which bind them together. Antioch in Persis, of course, sends athletes to the great games of Greece, but in this decree it determines to take part in

the new festival being started in honour of Artemis at Magnesia. The loyalty, too, expressed towards the Seleucid king implies a predominant interest in pan-hellenic unity, natural in colonies isolated among barbarians. A list is given (fragmentary) of other Greek cities in Babylonia and beyond from which similar decrees had come.

In the middle of the 3rd century B.C. Bactria and Sogdiana broke away from the Seleucid empire; independent Greek kings reigned there till the country was conquered by nomads from Central Asia (Satae and Yue-chi) a century later. Alexander had settled large masses of Greeks in these regions (Greeks, it would seem, not Macedonians), whose attempts to return home in 325 and 323 had been frustrated, and it may well be that a racial antagonism quickened the revolt against Macedonian rule in 250. The history of these Greek dynasties is for us almost a blank, and for estimating the amount and quality of Hellenism in Bactria during the 180 years or so of Macedonian and Greek rule, we are reduced to building hypotheses upon the scantiest data. Probably nothing important bearing on the subject has been left out of view in W. W. Tarn's learned discussion (*Journ. of Hell. Stud.* xii. 1902, p. 268 f.), and his result is mainly negative, that palpable evidences of an active Hellenism have not been found; he inclines to think that the Greek kingdoms mainly took on the native Iranian colour. The coins, of course, are adduced on the other side; being not only Greek in type and legend, but (in many cases) of a peculiarly fine and vigorous execution; and excellence in one branch of art is thought to imply that other branches flourished in the same milieu. Tarn suggests that they may be a "sport," a spasmodic outbreak of genius (see BACTRIA and works there quoted). In these outlying provinces the national Iranian sentiment seems to have been most intense, and it is interesting to see that under Alexander Hellenism appeared as "belligerent civilization," in the attempt to suppress practices like the exposure of the dying to the dogs (an exaggeration of Zoroastrianism) and, possibly also, abhorrent forms of marriage (Strabo xi. 517; Porphyr. *De abstin.* 4. 21; Plut. *De fort. Al.* 5).

The west of Iran slipped from the Seleucids in the course of the 2nd century B.C. to be joined to the Parthian kingdom, or fall under petty native dynasties. Soon after 130 Babylonia too was conquered by the Parthian, and Mesopotamia before 88. Then the reconquest of the nearer East by Oriental dynasties was checked by the advance of Rome. Asia Minor and Syria remained substantial parts of the Roman Empire till the Mahomedan conquests of the 7th century A.D. began a new process of recoil on the part of the Hellenistic power. In Babylonia, also, in Susiana and Mesopotamia, Hellenism had been established in a system of cities for 200 years before the coming of the Parthian. The greatest of all of them stood here—almost on the site of Bagdad—Seleucia on the Tigris. It superseded Babylon as the industrial focus of Babylonia and counted some 600,000 inhabitants (*plebs urbana*) according to Pliny, *N.H.* vi. § 122 (cf. Joseph. *Arch.* xviii. § 372, 374; for coins, probably of Seleucia, with the type of Tyche issued in the years A.D. 43-44 see Wroth, *Coins of Parthia*, p. xlvi.). The list of other Greek cities known to us in these regions is too long to give here (see Droysen, *loc. cit.*, and E. Schwartz in Kern's *Inschr. v. Magnesia*, p. 171 f.). In Mesopotamia, Pliny especially notes how the character of the country was changed when the old village life was broken in upon by new centres of population in the cities of Macedonian foundation (Pliny, *N.H.* vi. § 117; cf. K. Regling, "Histor. geog. d. mesopot. Parallelograms," in Lehmann's *Beiträge*, i. p. 442 f.).

We do not look in vain for notable names in Hellenistic literature and philosophy produced on an Asiatic soil. Diogenes, the Stoic philosopher (head of the school in 150 B.C.), was a "Babylonian," i.e. a citizen of Seleucia on the Tigris; so too was Seleucus, the mathematician and astronomer, being possibly a native Babylonian; Berossus, who wrote a Babylonian history in Greek (before 261 B.C.) was a Hellenized native. Apollodorus, Strabo's authority

for Parthian history (c. 80 B.C.?), was from the Greek city of Artemita in Assyria. When the Parthians rent away provinces from the Seleucid empire, the Greek cities did not cease to exist by passing under barbarian rule. Gradually no doubt the Greek colonies were absorbed, but the process was a long one. In 140 and 130 B.C. those of Iran were ready to rise in support of the Seleucid invader (Joseph. *Arch.* xiii. § 184, Justin xxxviii. 10.6-8). Just so, Crassus in 53 B.C. found a welcome in the Greek cities of Mesopotamia. Seleucia on the Tigris is spoken of by Tacitus as being in A.D. 36 "proof against barbarian influences and mindful of its founder Seleucus" (*Ann.* vi. 42). How important an element the Greek population of their realm seemed to the Parthian kings we can see by the fact that they claimed to be themselves champions of Hellenism. From the reign of Artabanus I. (128/7-123 B.C.) they bear the epithet of "Philhellen" as a regular part of their title upon the coins. Under the later reigns the Tychē figure (the personification of a Greek city) becomes common as a coin type (Wroth, *Coins of Parthia*, pp. liii, lxxiv.). The coinage may, of course, give a somewhat one-sided representation of the Parthian kingdom, being specially designed for the commercial class, in which the population of the Greek cities was, we may guess, predominant. The state of things which prevails in modern Afghanistan, where trade is in the hands of a class distinct in race and speech (Persian in this case) from the ruling race of fighters is very probably analogous to that which we should have found in Iran under the Parthians. That the Parthian court itself was to some extent Hellenized is shown by the story, often adduced, that a Greek company of actors was performing the *Bacchae* before the king when the head of Crassus was brought in. This single instance need not, it is true, show a Hellenism of any profundity; still it does show that certain parts of Hellenism had become so essential to the lustre of a court that even an Arsacid could not be without them. Artavasdes, king of Armenia (54?-34 B.C.) composed Greek tragedies and histories (Plut. *Crass.* 33). Then the prestige of the Roman Empire, with its prevailing Hellenistic culture, must have told powerfully. The Parthian princes were in many cases the children of Greek mothers who had been taken into the royal harems (Plut. *Crass.* 32). Musa, the queen-mother, whose head appears on the coins of Phraataces (3/2 B.C.-A.D. 4) had been an Italian slave-girl. Many of the Parthian princes resided temporarily, as hostages or refugees, in the Roman Empire; but one notes that the nation at large looked with anything but favour upon too liberal an introduction of foreign manners at the court (Tac. *Ann.* ii. 2).

Such slight notices in Western literature do not give us any penetrating view into the operation of Hellenism among the Iranians. As an expression of the Iranian mind we have the Avesta and the Pehlevi theological literature. Unfortunately in a question of this kind the dating of our documents is the first matter of importance, and it seems that we can only assign dates to the different parts of the Avesta by processes of fine-drawn conjecture. And even if we could date the Avesta securely, we could only prove borrowing by more or less close coincidences of idea, a tempting but uncertain method of inquiry. Taking an opinion based on such data for what it is worth, we may note that Darmesteter believed in the influence of the later Greek philosophy (Philonian and Neo-platonic) as one of those which shaped the Avesta as we have it (*Sacred Books of the East*, iv. 54 f.), but we must also note that such an influence is emphatically denied by Dr L. Mills (*Zarathushtra and the Greeks*, Leipzig, 1906). Outside literature, we have to look to the artistic remains offered by the region to determine Hellenic influence. But here, too, the preliminary classification of the documents is beset with doubt. In the case of small objects like gems the place of manufacture may be far from the place of discovery. The architectural remains are solidly *in situ*, but

"Ce sont les Tadjik de l'Afghanistan qui constituent les treize-cordes corps de métier, qui tiennent boutique, expédient les marchandises, représentent, en un mot, la vie industrielle et commerciale de la nation. Ce sont aussi les Tadjik des villes qui forment la classe lettrée, et qui ont empêché les Afghans de retomber dans la barbarie." (Reclus, *Nouvelle Géographie univ.* ix. p. 71.)

we may have such vast disagreement as to date as that between Dieulafoy and M. de Morgan with respect to domed buildings of Susa, a disagreement of at least five centuries. It is enough then here to observe that Iran and Babylonia do, as a matter of fact, continually yield the explorer objects of workmanship either Greek or influenced by Greek models, belonging to the age after Alexander, and that we may hence infer at any rate such an influence of Hellenism upon the tastes of the richer classes as would create a demand for these things.

For gems see "Cobineau" in the *Rev. archéol.*, vols. xxvii., xxviii. (1874); Méniat, *Recherches sur la géologie orientale*, ii. 189 f.; E. Furtwängler, *Catalogue des caisses de la Bibl. Nat.* (1897), p. 56; A. Furtwängler, *Die antiken Gemmen*, pp. 165, 360 ff.; Figurines: Heuzey, *Fig. ant. du Louvre* (1883) p. 31 f.; P. Peters, *Nippur*, ii. 128; Military standard: Heuzey, *Comptes rendus de l'Acad. d. Inscr.* (1895) p. 16; *Rev. d'Assyriol.*, v. (1903), p. 103 f. Alabaster vase: Sykes, *Ten Thousand Miles in Persia*, p. 445. In the case of the architectural remains, the Greek tradition is obvious at Hatra (Jacquerel, *Rev. archéol.*, 1897 [ii.], 343 f.), and in the relics of the temple at Kingavar (Dieulafoy, *L'Art antique de la Perse*, v. p. 10 f.).

If any vestige of Hellenism still survived under the Sassanian kings, our records do not show it. The spirit of the Sassanian monarchy was more jealously national than that of the Arsacid, and alien grafts could hardly have flourished under it. Of course, if Darmesteter was right in seeing a Greek element in Zoroastrianism, Greek influence must still have operated under the new dynasty, which recognized the national religion. But, as we saw, the Greek influence has been authoritatively denied. At the court a limited recognition might be given, as fashion veered, to the values prevalent in the Hellenistic world. The story of Hormisdas in Zosimus is suggestive in this connexion (Zosim. *Hist. nov.* ii. 27). Chosroes I. interested himself in Greek philosophy and received its professors from the West with open arms (Agath. ii. 28 f.); according to one account, he had his palace at Ctesiphon built by Greeks (Theophylact. *Simocat.* v. 6).

But the account of Chosroes' mode of action makes it plain that the Hellenism once planted in Iran had withered away; representatives of Greek learning and skill have all to be imported from across the frontier.

For Hellenism in Babylonia and Iran, see the useful article of M. Victor Chapot in the *Bull. et mémoires de la Soc. Nat. des Antiquaires de France* for 1902 (published 1904), p. 206 f., which gives a conspectus of the relevant literature.

(iii.) *Asia Minor*.—Very different were the fortunes of Hellenism in those lands which became annexed to the Rhoman Empire. In Asia Minor, we have seen how, even before Alexander, Hellenism had begun to affect the native races and Persian nobility. During Alexander's own reign, we cannot trace any progress in the Hellenization of the interior, nor can we prove here his activity as a builder of cities. But under the dynasties of his successors a

great work of city-building and colonization went on. Antigonos fixed his capital at the old Phrygian town of Celasene, and the famous cities of Nicaea and Alexandria Troas owed to him their first foundation, each as an Antigonian; they were refounded and renamed by Lysimachus (301-281 B.C.). Then we have the great system of Seleucid foundations. Sardis, the Seleucid capital in Asia Minor, had become a Greek city before the end of the 3rd century B.C. The main high road between the Aegean coast and the East was held by a series of new cities. Going west from the Cilician Gates we have Laodicea Catacecaumene, Apamea, the Phrygian capital which absorbed Celaene, Laodicea on the Lycus, Antioch-on-Meander, Antioch-Nysa, Antioch-Tralles. To the south of this high road we have among the Seleucid foundations Antioch in Pisidia (colonized with Magnesians from the Meander) and Stratonicea in Caria; in the region to the north of it the most famous Seleucid colony was Thyatira. Along the southern coast, where the houses of Seleucus and Ptolemy strove for predominance, we find the names of Berenice, Arsinoë and Ptolemais confronting those of Antioch and Seleucia. With the rise of the Attalid dynasty of Pergamum, a system of Pergamene foundation begins to oppose the Seleucid in the interior, bearing such names as Attalia, Philaetria,

Eumonia, Apollonia. Of these, one may note for their later celebrity Philadelphia in Lydia and Attalia on the Pamphylian coast. The native Bithynian dynasty became Hellenized in the course of the 3rd century, and in the matter of city building Prusias (the old Cicus), Apamea (the old Myrlea), probably Prusa, and above all Nicomedia attested its activity. While new Greek cities were rising in the interior, the older Hellenism of the western coast grew in material splendour under the munificence of Hellenistic kings. Its centres of gravity to some extent shifted. There was a tendency towards concentration in large cities of the new type, which caused many of the lesser towns, like Lebedus, Myrus or Colophon, to sink to insignificance, while Ephesus grew in greatness and wealth, and Smyrna rose again after an extinction of four centuries. The great importance of Rhodes belongs to the days after Alexander, when it received the riches of the East from the trade-routes which debouched into the Mediterranean at Alexandria and Antioch. In Aeolis, of course, the centre of gravity moved to the Attalid capital, Pergamum. It was the irruption of the Celts, beginning in 278-277 B.C., which checked the Hellenization of the interior. Not only did the Galatian tribes take large tracts towards the north of the plateau in possession, but they were an element of perpetual unrest, which hampered and distracted the Hellenistic monarchies. The wars, therefore, in which the Pergamene kings in the latter part of the 3rd century stemmed their aggressions, had the glory of a Hellenic crusade.

The minor dynasties of non-Greek origin, the native Bithynian and the two Persian dynasties in Pontus and Cappadocia, were Hellenized before the Romans drove the Seleucid out of the country. In Bithynia the upper classes seem to have followed the fashion of the court (Beloch iii. [i], 278); the dynasty of Pontus was phil-hellenic by ancestral tradition; the dynasty of Cappadocia, the most conservative, dated its conversion to Hellenism from the time when a Seleucid princess came to reign there early in the 2nd century B.C. as the wife of Ariarathes V. (Diod. xxxi. 19. 8). But Hellenism in Cappadocia was for centuries to come still confined to the castles of the king and the barons, and the few towns.

When Rome began to interfere in Asia Minor, its first action was to break the power of the Gauls (189 B.C.). In 133 Rome entered formally upon the heritage of the Attalid kingdom and became the dominant power in the Anatolian peninsula for 1200 years. Under Rome the process of Hellenization, which the divisions and weakness of the Macedonian kingdoms had checked, went forward. The coast regions of the west and south the Romans found already Hellenized. In Lydia "not a trace" of the old language was left in Strabo's time (Strabo xiv. 631); in Lycia, the old language became obsolete in the early days of Macedonian rule (see Kalinka, *Tituli Asiae minoris*, i. 8). But inland, in Phrygia, Hellenism had as yet made little headway outside the Greek cities. Even the Attalids had not effected much here (Körte, *Athen. Mitth.* xxiii., 1898, p. 152), and under the Romans, the penetration of the interior by Hellenism was slow. It was not till the reign of Hadrian that city life on the Phrygian plateau became rich and vigorous, with its material circumstances of temples, theatres and baths. Among the villages of the north and east of Phrygia, Hellenism "was only beginning to make itself felt in the middle of the 3rd century A.D." (Ramsay in Kuhn's *Zeitsch. f. vergleich. Sprachforschung*, xxviii., 1885, p. 382). Gravestones in this region as late as the 4th century cease violators in the old Phrygian speech. The lower classes at Lystra in St Paul's time spoke Lycaonian (Acts xiv. 11). In that part of Phrygia, which by the settlement of the Celtic invaders became Galatia, the larger towns seem to have become Hellenized by the time of the Christian era, whilst the Celtic speech maintained itself in the country villages till the 4th century A.D. (Jerome, Preface to Comment. in *Epist. ad Gal.* book ii.; see J. G. C. Anderson, *Journ. of Hell. Stud.* xix., 1899, p. 312 f.). Cappadocia at the beginning of the Christian era was still comparatively townless (Strabo xii. 537), a country of large estates with a servile peasantry. Even in the 4th century

its Hellenization was still far from complete; but Christianity had assimilated so much of the older Hellenic culture that the Church was now a main propagator of Hellenism in the backward regions. The native languages of Asia Minor all ultimately gave way to Greek (unless Phrygian lingered on in parts till the Turkish invasions; see Mordtmann, *Sitzungsber. d. Bayer. Ak.* 1862, i. p. 30; K. Holl in *Hermes*, xliii., 1908, p. 240 f.). The effective Hellenization of Armenia did not take place till the 5th century, when the school of Mesrop and Sahak gave Armenia a literature translated from, or imitating, Greek books (Geizer in I. v. Müller's *Handbuch*, vol. ix. Abt. i. p. 916.)

(iv.) *Syria*.—In Syria, which with Cilicia and Mesopotamia, formed the central part of the Seleucid empire, the new colonies were especially numerous. Alexander himself had perhaps made a beginning with Alexandria-by-issus ^{Seleucid empire.} (mod. Alexandretta), Samaria, Pelea (the later Apamea), Carrhae, &c. Antigonos founded Antigonias, which was absorbed a few years later by Antioch, and after the fall of Antigonos in 301, the work of planting Syria with Greek cities was pursued effectively north of the Lebanon by the house of Seleucus, and, less energetically, south of the Lebanon by the house of Ptolemy. In the north of Syria four cities stood pre-eminent above the rest, (1) Antioch on the Orontes, the Seleucid capital; (2) Seleucia-in-Peria near the mouth of the Orontes, which guarded the approach to Antioch from the sea; (3) Apamea (mod. Fama), on the middle Orontes, the military headquarters of the kingdom; and (4) Laodicea "on sea" (*ad mare*), which had a commercial importance in connexion with the export of Syrian wine. Of the Ptolemaic foundations in Coele-Syria only one attained an importance comparable with that of the larger Seleucid foundations, Ptolemais on the coast, which was the old Semitic Acco transformed (mod. Acre). The group of Greek cities east of the Jordan also fell within the Ptolemaic realm during the 3rd century B.C., though their greatness belonged to a somewhat later day. The whole of Syria was brought under the Seleucid sceptre, together with Cilicia, by Antiochus III. the Great (223-187 B.C.). Under his son, Antiochus IV. Epiphanes (175-164), a fresh impulse was given to Syrian Hellenism. In 1 Maccabees he is represented as writing an order to all his subjects to forsake the ways of their fathers and conform to a single prescribed pattern, and though in this form the account can hardly be exact, it does no doubt represent the spirit of his action. Other facts there are which point the same way. We now find a sudden issue of bronze money by a large number of the cities of the kingdom in their own name—an indication of liberties extended or confirmed. Many of them exchange their existing name for that of Antioch (Adana, Tarsus, Gadara, Ptolemais), Seleucia (Mopsuestia, Gadara) or Epiphanea (Oeniandus, Hamath): At Antioch itself great public works were carried out, such as were involved in the addition of a new quarter to the city, including, we may suppose, the civic council chamber which is afterwards spoken of as being here. With the ever-growing weakness of the Seleucid dynasty, the independence and activity of the cities increased, although, if, on the one hand, they were less suppressed by a strong central government, they were less protected against military adventurers and barbarian chieftains. Accordingly, when Pompey annexed Syria in 64 B.C. as a Roman province, he found it a chaos of city-states and petty principalities. The Nabataeans and the Jews above all had encroached upon the Hellenistic domain; in the south the Jewish raids had spread desolation and left many cities practically in ruins. Under Roman protection, the cities were soon rebuilt and Hellenism secured from the barbarian peril: Greek city life, with its political forms, its complement of festivities, amusements and intellectual exercise, went on more largely than before. The great majority of the Hellenistic remains in Syria belong to the Roman period. Such local dynasties as were suffered by the Romans to exist had, of course, a Hellenistic complexion. Especially was this the case with that of the Herods. Not only were such marks of Hellenism as a theatre introduced

by Herod the Great (37-34 B.C.) at Jerusalem, but in the work of city-building this dynasty showed itself active. Sebaste (the old Samaria), Caesarea, Antipatris were built by Herod the Great, Tiberias by Herod Antipas (4 B.C.-A.D. 39). The reclaiming of the wild district of Hauran for civilization and Hellenistic life was due in the first instance to the house of Herod (Schürer, *Gesch. d. jüd. Volk.* 3rd ed., ii. p. 12 f.). In Syria, too, Hellenism under the Romans advanced upon new ground. Palmyra, of which we hear nothing before Roman times, is a notable instance.

As to the effect of this network of Greek cities upon the aboriginal population of Syria, we do not find here the same

Greek culture in Syria. disappearance of native languages and racial characteristics as in Asia Minor. Still less was this the case in Mesopotamia, where a strong native element in such a city as Edessa is indicated by its epithet *μυσοβάρβαρος*.

The old cults naturally went on, and at Carrhae (Harran) even survived the establishment of Christianity. The lower classes at Antioch, and no doubt in the cities generally, were in speech Aramaic or bilingual; we find Aramaic popular nicknames of the later Seleucids (K. O. Müller, *Antiq. Ans.* p. 29). The villages, of course, spoke Aramaic. The richer natives, on the other hand, those who made their way into the educated classes of the towns, and attained official position, would become Hellenized in language and manners, and the "Syrian Code" shows how far the social structure was modified by the Hellenic tradition (Mitteis, *Reichsrecht und Volksrecht in den äst. Provinzen des röm. Kaiserreichs*, 1891; Arnold Meyer, *Jesu Mutter-sprache*, 1896). Of the Syrians who made their mark in Greek literature, some were of native blood, e.g. Lucian of Samosata.

One may notice the great part taken by natives of the Phoenician cities in the history of later Greek philosophy, and in the poetic movement of the last century B.C., which led to fresh cultivation of the epigram. Greek, in fact, held the field as the language of literature and polite society. Possibly at places like Edessa, which for some 350 years (till A.D. 216) was under a dynasty of native princes, Aramaic was cultivated as a literary language. There was a Syriac-speaking church here as early as the 2nd century, and with the spread of Christianity Syriac asserted itself against Greek. The Syriac literature which we possess is all Christian.

But where Greek gave place to Syriac, Hellenism was not thereby effaced. It was to some extent the passing over of the Hellenic tradition into a new medium. We must remember the marked Hellenic elements in Christian theology. The earliest Syriac work which we possess, the book "On Fate," produced in the circle of the heretic Bardaisan or Bardesanes (end of the 2nd century), largely follows Greek models. There was an extensive translation of Greek works into Syriac during the next centuries, handbooks of philosophy and science for the most part. The version of Homer into Syriac verses made in the 8th century has perished, all but a few lines (R. Duval, *La Litt. syriaque*, 1900, p. 325).

(v.) The relation of the Jews to Hellenism in the first century and a half of Macedonian rule is very obscure, since the statements made by later writers like Josephus, as to the

The Jews. visit of Alexander to Jerusalem or the privileges conferred upon the Jews in the new Macedonian realms are justly suspected of being fiction. It has been maintained that Greek influence is to be traced in parts of the Old Testament assigned to this period, as, for instance, the Book of Proverbs; but even in the case of Ecclesiastes, the canonical writing whose affinity with Greek thought is closest, the coincidence of idea need not necessarily prove a Greek source. The one solid fact in this connection is the translation of the Jewish Law into Greek in the 3rd century B.C., implying a Jewish Diaspora at Alexandria, so far Hellenized as to have forgotten the speech of Palestine. Early in the 2nd century B.C. we see that the priestly aristocracy of Jerusalem had, like the well-to-do classes everywhere in Syria, been carried away by the Hellenistic current, its strength being evidenced no less by the intensity of the conservative

opposition embodied in the party of the "Pious" (Aasideans, *Hasidim*).

Under Antiochus IV. Epiphanes (176-165) the Hellenistic aristocracy contrived to get Jerusalem converted into a Greek city; the gymnasium appeared, and Greek dress became fashionable with the young men. But when Antiochus, owing to political developments, interfered violently at Jerusalem, the conservative opposition carried the nation with them. The revolt under the Hasmonaean family (Judas Maccabaeus and his brethren) followed, ending in 143-142 in the establishment of an independent Jewish state under a Hasmonaean prince. But whilst the old Hellenistic party had been crushed the Hasmonaean state was of the nature of a compromise. The Mosaic Law was respected, but Hellenism still found an entrance in various forms. The first Hasmonaean "king," Aristobulus I. (104-103), was known to the Greeks as Phil-hellen. He and all later kings of the dynasty bear Greek names as well as Hebrew ones, and after Jannaeus Alexander (103-76) the Greek legends are common on the coins beside the Hebrew. Herod, who supplanted the Hasmonaean dynasty (37-34 B.C.) made, outside Judaea, a display of Phil-hellenism, building new Greek cities and temples, or bestowing gifts upon the older ones of fame. His court, at the same time, welcomed Greek men of letters like Nicolaus of Damascus. Even in the neighbourhood of Jerusalem, he erected a theatre and an amphitheatre. We have already noticed the work done by the Herodian dynasty in furthering Hellenism in Syria (see Schürer, *Gesch. des jüdischen Volkes*, vols. i. and ii.). Meanwhile a great part of the Jewish people was living dispersed among the cities of the Greek world, speaking Greek as their mother-tongue, and absorbing Greek influences in much larger measure than their brethren of Palestine. These are the Jews whom we find contrasted as "Hellenists" with the "Hebrews" in Acts. They still kept in touch with the mother-city, and indeed we hear of special synagogues in Jerusalem in which the Hellenists temporarily resident there gathered (Acts vi. 9). A large Jewish literature in Greek had grown up since the translation of the Law in the 3rd century. Beside the other canonical books of the Old Testament, translated in many cases with modifications or additions, it included translations of other Hebrew books (Ecclesiastical, Judith, &c.), works composed originally in Greek but imitating to some extent the Hebraic style (like Wisdom), works modelled more closely on the Greek literary tradition, either historical, like 2 Maccabees, or philosophical, like the productions of the Alexandrian school, represented for us by Aristobulus and Philo, in which style and thought are almost wholly Greek and the reference to the Old Testament a mere pretext; or Greek poems on Jewish subjects, like the epic of the elder Philo and Ezechiel's tragedy, *Exagoge*. It included also a number of forgeries, circulated under the names of famous Greek authors, verses fathered upon Aeschylus or Sophocles, or books like the false Hecataeus, or above all the pretended prophecies of ancient Sibyls in epic verse. These frauds were all contrived for the heathen public, as a means of propaganda, calculated to inspire them with respect for Jewish antiquity or turn them from idols to God.

For Jewish Hellenism see Schürer, *op. cit.* iii.; Susemihl, *Gesch. der griech. Lit. in der Alexandrinerzeit*, ii. 601 f.; Willrich, *Juden und Griechen* (1895); *Judaica* (1900); Hastings' *Dict. of the Bible*, art. "Greece"; *Encyclop. Biblica*, art. "Hellenism"; Pauly-Wissowa, art. "Aristobulus (15)"; also the work of P. Wendland cited above.

Through the Hellenistic Jews, Greek influences reached Jerusalem itself, though their effect upon the Aramaic-speaking Rabbinical schools was naturally not so pronounced. The large number of Greek words, however, in the language of the Mishnah and the Talmud is a significant phenomenon. The attitude of the Rabbinic doctors to a Greek education does not seem to have been hostile till the time of Hadrian. The sect of the Essenes probably shows an intermingling of the Greek with other lines of tradition among the Jews of Palestine.

See Schürer *ib.* 42-67, 583; S. Krauss, *Griech. u. latin. Lehnwörter im Talmud* (1898); *Jewish Encyclopedia*, art. "Greek Language."

(vi.) In Egypt the Ptolemies were hindered by special considerations from building Greek cities after the manner of the other Macedonian houses. One Greek city they found existing, Naucratis; Alexander had called Alexandria into being; the first Ptolemy added Ptolemais as a Greek centre for Upper Egypt. They seem to have enjoyed no other community in the Nile Valley with the independent life of a Greek city, for the Greek and Macedonian soldier-colonies settled in the Fayum or elsewhere had no political self-existence. And even at Alexandria Hellenism was not allowed full development. Ptolemies, indeed, enjoyed all the ordinary forms of self-government, but Alexandria was governed despotically by royal officials. In its population, too, Alexandria was only semi-Hellenic; for besides the proportion of Egyptian natives in its lower strata, its commercial greatness drew in elements from every quarter; the Jews, for instance, formed a majority of the population in two out of the five divisions of the city. At the same time the prevalent tone of the populace was, no doubt, Hellenistic, as is shown by the fact that the Jews who settled there acquired Greek in place of Aramaic as their mother-tongue, and in its upper circles Alexandrian society under the Ptolemies was not only Hellenistic, but notable among the Hellenes for its literary and artistic brilliance. The state university, the "Museum," was in close connexion with the court, and gave to Alexandria the same pre-eminence in natural science and literary scholarship which Athens had in moral philosophy.

Probably in no other country, except Judaea, did Hellenism encounter as stubborn a national antagonism as in Egypt. The common description of "the Oriental" as indurated in his antagonism to the alien conqueror here perhaps has some truth in it. The assault made upon the Macedonian devoted in the temple of Serapis at Memphis "because he was a Greek" is significant (*Pap. Brit. Mus.* i. No. 44; cf. Grenfell, *Ambrosii Papyr.* p. 48). And yet even here one must observe qualifications. The papyri show us habitual marriage of Greeks and native women and a frequent adoption by natives of Greek names. It has even been thought that some developments of the Egyptian religion are due to Hellenistic influence, such as the deification of Imhotep (*Bissing, Deutsche Literaturzeitung*, 1902, col. 2336) or the practice of forming voluntary religious associations (*Otto, Priester und Tempel*, i. 125). The worship of Serapis was patronized by the court with the very object of affording a mixed cultus in which Greek and native might unite. In Egypt, too, the triumph of Christianity brought into being a native Christian literature, and if this was in one way the assertion of the native against Hellenistic predominance, one must remember that Coptic literature, like Syriac, necessarily incorporated those Greek elements which had become an essential part of Christian theology.

From the Ptolemaic kingdom Hellenism early travelled up the Nile into Ethiopia. Ergamenes, the king of the Ethiopians in the time of the second Ptolemy, "who had received a Greek education and cultivated philosophy," broke with the native priesthood (*Diod.* iii. 6), and from that time traces of Greek influence continue to be found in the monuments of the Upper Nile. When Ethiopia became a Christian country in the 4th century, its connexion with the Hellenistic world became closer.

(vii.) *Hellenism in the West.*—Whilst in the East Hellenism had been sustained by the political supremacy of the Greeks, in Italy *Græcia capta* had only the inherent power and charm of her culture wherewith to win her way. At Carthage in the 3rd century the educated classes seem generally to have been familiar with Greek culture (*Bernhardy, Grundriss d. griech. Lit.* § 77). The philosopher Clitomachus, who presided over the Academy at Athens in the 2nd century, was a Carthaginian. Even before Alexander, as we saw, Hellenism had affected the peoples of Italy, but it was not till the Greeks of south Italy and Sicily were brought under the supremacy of Rome in the 3rd century B.C. that the stream of Greek influence entered Rome in any

volume. It was now that the Greek freedman, L. Livius Andronicus, laid the foundation of a new Latin literature by his translation of the *Odyssey*, and that the Greek dramas were retast in a Latin mould. The first Romans who set about writing history wrote in Greek. At the end of the 3rd century there was a circle of enthusiastic phil-hellenes among the Roman aristocracy, led by Titus Quinctius Flaminius, who in Rome's name proclaimed the autonomy of the Greeks at the Isthmian games of 196. In the middle of the 2nd century Roman Hellenism centred in the circle of Scipio Aemilianus, which included men like Polybius and the philosopher Panaetius. The visit of the three great philosophers, Diogenes the "Babylonian," Critolaus and Carneades in 155, was an epoch-making event in the history of Hellenism at Rome. Opposition there could not fail to be, and in 161 a *senatus consultum* ordered all Greek philosophers and rhetoricians to leave the city. The effect of such measures was, of course, transient. Even though the opposition found so doughty a champion as the elder Cato (censor in 184), it was ultimately of no avail. The Italians did not indeed surrender themselves passively to the Greek tradition. In different departments of culture the degree of their independence was different. The system of government framed by Rome was an original creation. Even in the spheres of art and literature, the Italians, while so largely guided by Greek canons, had something of their own to contribute. The mere fact that they produced a literature in Latin argues a power of creation as well as receptivity. The great Latin poets were imitators indeed, but more imitators they were no more than Petrarch or Milton. On the other hand, even where the creative originality of Rome was most pronounced, as in the sphere of Law, there were elements of Hellenic origin. It has been often pointed out how the Stoic philosophy especially helped to shape Roman jurisprudence (*Schmekel, Philos. d. mitt. Stoa*, p. 454 f.).

Whilst the upper classes in Italy absorbed Greek influences by their education, by the literary and artistic tradition, the lower strata of the population of Rome became largely hellenized by the actual influx on a vast scale of Greeks and hellenized Asiatics, brought in for the most part as slaves, and coalescing as freedmen with the citizen body. Of the Jewish inscriptions found at Rome some two-thirds are in Greek. So too the early Christian church in Rome, to which St Paul addressed his epistle, was Greek-speaking, and continued to be till far into the 3rd century.

III. LATER HISTORY.—It remains only to glance at the ultimate destinies of Hellenism in West and East. In the Latin West knowledge of Greek, first-hand acquaintance with the Greek classics, became rarer and rarer as general culture declined, till in the dark ages (after the 5th century) it existed practically nowhere but in Ireland (*Sandys, History of Classical Scholarship*, i. 438). In Latin literature, however, a great mass of Hellenistic tradition in a derived form was maintained in currency, wherever, that is, culture of any kind continued to exist. It was a small number of monkish communities whose care of those narrow channels prevented their ever drying up altogether. Then the stream began to rise again, first with the influx of the learning of the Spanish Moors, then with the new knowledge of Greek brought from Constantinople in the 14th century. With the Renaissance and the new learning, Hellenism came in again in flood, to form a chief part of that great river on which the modern world is being carried forward into a future, of which one can only say that it must be utterly unlike anything that has gone before. In the East it is popularly thought that Hellenism, as an exotic, withered altogether away. This view is superficial. During the dark ages, in the Byzantine East, as well as in the West, Hellenism had become little more than a dried and shrivelled tradition, although the closer study of Byzantine culture in latter years has seemed to discover more vitality than was once supposed. Ultimately the Greek East was absorbed by Islam; the popular mistake lies in supposing that the Hellenistic tradition thereby came to an end. The Mahomedan conquerors found a considerable part of it ^{Islam.} ~~there~~

Ethiopia.

Greek culture in the Roman world.

The middle ages.

Islam.

over, as we saw, by the Syrian Christians, and Greek philosophical and scientific classics were now translated from Syriac into Arabic. These were the starting-points for the Mahomedan schools in these subjects. Accordingly we find that Arabian philosophy (*q.v.*), mathematics, geography, medicine and philology are all based professedly upon Greek works (Brockelmann, *Gesch. d. arabischen Literatur*, 1898, vol. i.; R. A. Nicholson, *A Literary History of the Arabs*, 1907, pp. 358-361). Aristotle in the East no less than in the West was the "master of them that know"; and Moslem physicians to this day invoke the names of Hippocrates and Galen. The Hellenistic strain in Mahomedan civilization has, it is true, flagged and failed, but only as that civilization as a whole has declined. It was not that the Hellenistic element failed, whilst the native elements in the civilization prospered; the culture of Islam has, as a whole (from whatever causes), sunk ever lower during the centuries that have witnessed the marvellous expansion of Europe.

AUTHORITIES.—For the inner history of Hellenism after Alexander, the general historical literature dealing with later Greece and Rome supplies material in various degrees. See works quoted in articles GREECE, *History*; ROME, *History*; PTOLEMIES; SELUCID DYNASTY; BACTRIA, &c.

Different elements (literature, philosophy, art, &c.) are dealt with in works dealing specially with these subjects, among which those of Susemihl, Wilamowitz-Moellendorf, Erwin Rohde and E. Schwartz are of especial importance for the literature; those of Schreiber and Strzygowski for the later Greek art.

Sketches of Hellenistic civilization generally are found in J. P. Mahaffy's *Greek Life and Thought* (1887), *The Greek World under Roman Sway* (1890), *The Silver Age of the Greek World* (1906); Julius Kaerst, *Gesch. d. hellenist. Zeitalters* (Band ii., publ. 1909); and in Beloch's *Griechische Geschichte*, vol. iii. (for the century immediately succeeding Alexander). R. von Scala's "The Greeks after Alexander," in Helmholtz's *History of the World* (vol. v.), covers the whole period from Alexander to the end of the Byzantine Empire. F. Wendland's *Hellenistisch-römische Kultur in ihren Beziehungen zu Judentum u. Christentum* (1907) is an illuminating monograph, giving a conspectus of the material. For Hellenistic Egypt, Bouché-Leclercq, *Histoire des Lagides*, vol. iii. (1906). (E. R. B.)

HELLER, STEPHEN (1815-1888), Austrian pianist and composer, was born at Pest on the 15th of May 1815. (Fétis's dictionary says 1814, but this is almost certainly wrong.) He was at first intended for a lawyer, but at nine years of age performed so successfully at a concert that he was sent to Vienna to study under Czerny. Halm was his principal master, and from the age of twelve he gave concerts in Vienna, and made a tour through Hungary, Poland and Germany. At Augsburg he had the good fortune to be befriended when ill by a wealthy family, who practically adopted him and gave him the opportunity to complete his musical education. In 1838 he went to Paris, and soon became intimate with Liszt, Chopin, Berlioz and their set, among whom was Hallé, throughout his life an indefatigable performer of Heller's music. In 1849 he came to England and played a few times, and in 1862 he appeared with Hallé at the Crystal Palace. He outlived the great reputation he had enjoyed among cultivated amateurs for so many years, and was almost forgotten when he died at Paris on the 14th of January 1888. His pianoforte pieces, almost all of them published in sets and provided with fancy names, do not show very startling originality, but their grace and refinement could not but make them popular with players and listeners of all classes.

HELLESPONT (*s.e.* "Sea of Helle"); variously named in classical literature Ἑλλησπόντος, ἡ Ἑλλήσποντος, *Helle-spontum Pelagius*, and *Fretum Helleponticum*), the ancient name of the Dardanelles (*q.v.*). It was so-called from Helle, the daughter of Athamas (*q.v.*), who was drowned here. See ARGONAUTS.

HELLEVOETSLOUIS, or **HELVOETSLOUIS**, a fortified seaport in the province of South Holland, the kingdom of Holland, on the south side of the island of Voorne-and-Putten, on the sea-arm known as the Haringvliet, 5½ m. S. of Brielle. It has daily steamboat connexion with Rotterdam by the Voornsche canal. Pop. (1900), 4152. Hellevoetsluis is an important naval station, and possesses a naval arsenal, dry and wet docks, wharves and a naval college for engineers. Among the public buildings are the

communal chambers, a Reformed church (1661), a Roman Catholic church and a synagogue.

HELLÍN, a town of south-eastern Spain, in the province of Albacete, on the Albacete-Murcia railway. Pop. (1900), 12,552. Hellín is built on the outskirts of the low hills which line the left bank of the river Mundo. It possesses the remains of an old Roman castle and a beautiful parish church, the masonry and marble pavement at the entrance of which are worthy of special notice. The surrounding country yields wine, oil and saffron in abundance; within the town there are manufactures of coarse cloth, leather and pottery. Sulphur is obtained from the celebrated mining district of Minas del Mundo, 12 m. S., at the junction between the Mundo and the Segura; and there are warm sulphurous springs in the neighbouring village of Azaraque. Hellín was known to the Romans who first exploited its sulphur as Illunum.

HELLO, ERNEST (1828-1885), French critic, was born at Tréguier. He was the son of a lawyer who held posts of great importance at Rennes and in Paris, and was well educated at both places, but took to no profession and resided much, for a time, in his father's country-house in Brittany. A very strong Roman Catholic, he appears to have been specially excited by his countryman Renan's attitude to religious matters, and coming under the influence of J. A. Barbey d'Aureville and Louis Veuillot, the two most brilliant crusaders of the Church in the press, he started a newspaper of his own, *Le Croisé*, in 1859; but it only lasted two years. He wrote, however, much in other papers. He had very bad health, suffering apparently from spinal or bone disease. But he was fortunate enough to meet with a wife, Zoe Berthier, who, ten years older than himself, and a friend for some years before their marriage, became his devoted nurse, and even brought upon herself abuse from gutter journalists of the time for the care with which she guarded him. He died in 1885. Hello's work is somewhat varied in form but uniform in spirit. His best-known book, *Physionomie de saints* (1875), which has been translated into English (1903) as *Studies in Saintship*, does not display his qualities best. *Contes extraordinaires*, published not long before his death, is better and more original. But the real Hello is to be found in a series of philosophical and critical essays, from *Renan, l'Allemagne et l'athéisme* (1861), through *L'Homme* (1871) and *Les Plateaux de la balance* (1880), perhaps his chief book, to the posthumously published *Le Siècle*. The peculiarity of his standpoint and the originality and vigour of his handling make his studies, of Shakespeare, Hugo and others, of abiding importance as literary "triangulations," results of object, subject and point of view.

HELMERS, JAN FREDERIK (1767-1813), Dutch poet, was born at Amsterdam on the 7th of March 1767. His early poems, *Night* (1788) and *Socrates* (1790), were tame and sentimental, but after 1805 he determined, in company with his brother-in-law, Cornelis Loots (1765-1834), to rouse national feeling by a burst of patriotic poetry. His *Poems* (2 vols., 1809-1810), but especially his great work *The Dutch Nation*, a poem in six cantos (1812), created great enthusiasm and enjoyed immense success. Helmers died at Amsterdam on the 26th of February 1813. He owed his success mainly to the integrity of his patriotism and the opportune moment at which he sounded his counterblast to the French oppression. His posthumous poems were collected in 1815.

HELMERSEN, GREGOR VON (1803-1885), Russian geologist, was born at Laugut-Duckershof, near Dorpat, on the 29th of September (O.S.) 1803. He received an engineering training and became major-general in the corps of Mining Engineers. In 1837 he was appointed professor of geology in the mining institute at St Petersburg. He was author of numerous memoirs on the geology of Russia, especially on the coal and other mineral deposits of the country; and he wrote also some explanations to accompany separate sheets of the geological map of Russia. His geological work was continued to an advanced age, one of the later publications being *Studien über die Wanderblöcke und die Diluvialgebilde Russlands* (1869 and 1882). Most of his memoirs were published by the Imperial Academy of Sciences at St Petersburg. He died at St Petersburg on the 3rd of February (O.S.) 1885.

HELMET (from an obsolete diminutive of O. Fr. *helme*, mod. *heisme*; the English word is "helm," as in O. Eng., Dutch and Ger.; all are from the Teutonic base *hal-*, pre-Teut. *hal-*, to cover; cf. Lat. *celare*, to hide, Eng. "hell," &c.), a defensive covering for the head. The present article deals with the helmet during the middle ages down to the close of the period when body armour was worn. For the helmet worn by the Greeks and Romans see **ARMS AND ARMOUR**.

The head-dress of the warriors of the dark ages and of the earlier feudal period was far from being the elaborate helmet which is associated in the imagination with the knight in armour and the tourney. It was a mere casque, a cap with or without additional safeguards for the ears, the nape of the neck and the nose (fig. 1). By those warriors who possessed the means to equip themselves fully, the casque was worn over a hood of mail, as shown in fig. 2. In manuscripts, &c., armoured men are sometimes portrayed fighting in their hoods, without casques, basinets or other form of helmet. The casque was, of course, normally of plate, but in some instances it was a strong leather cap covered with mail or imbricated plates. The most advanced form of this early helmet is the conical steel or iron cap with nasal (fig. 2), worn in conjunction with the hood of mail. This is the typical helmet of the 11th-century warrior, and is made familiar by the Bayeux Tapestry. From this point however (c. 1100) the evolution of war head-gear follows two different paths for many years. On the one hand the simple casque easily transformed itself into the *basinet*, originally a pointed iron skull-cap without nasal, ear-guards, &c. On the other hand the knight in armour, especially after the fashion of the tournament set in, found the mere cap with nasal insufficient, and the *heisme* (or "helmet") gradually came into vogue. This was in principle a large heavy iron pot covering the head and neck. Often a light basinet was worn underneath it—or rather the knight usually wore his basinet and only put the heaume on over it at the last moment before engaging. The earlier (12th century) war heaumes are intended to be worn with the mail hood and have nasals (fig. 3). Towards the end of the 13th century, however, the basinet grew in size and strength, just as the casque had grown, and began to challenge comparison with the heavy and clumsy heaume. Thereupon the heaume became, by degrees, the special head-dress of the tournament, and grew heavier, larger and more elaborate, while the basinet, reinforced with



FIG. 1.—Casque with Neck-guard.



FIG. 2.—Casque with Nasal and Mail Hood.

camail and vizor, was worn in battle. Types of the later, purely tilting, heaume are shown in figs. 4 and 5. The basinet, then, is the battle head-dress of nobles, knights and sergeants in the 14th century. Its development from the



FIG. 3.—Heaume, early 13th century.

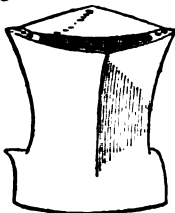

FIG. 4.—Heaume, 15th century.

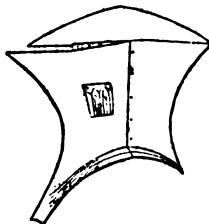

FIG. 5.—Heaume, 15th century.

20th-century cap to the towering helmet of 1350, with its long snouted vizor and ample drooping "camail," is shown in fig. 6, a, b, c and d, the two latter showing the same helmet with vizor down and up. But the tendency set in during the earlier years of the 13th century to make all parts of the armour thicker. Chain "mail" gradually gave way to plate on the body and the limbs, remaining only in those parts, such as neck and elbows, where flexibility was essential, and even there it was in the end replaced by jointed steel bands or small plates. The final step was the discarding of the "camail" and the introduction of the

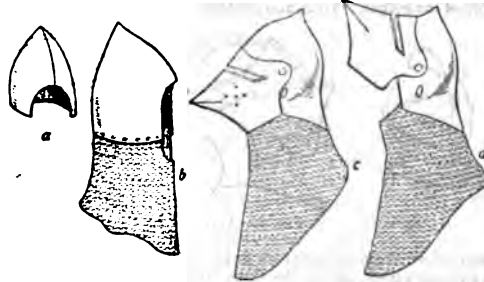

FIG. 6.—Basinets.

"armet." The latter will be described later. Soon after the beginning of the 13th century the high-crowned basinet gave place to the *salade* or *sallet*, a helmet with a low rounded crown and a long brim or neck-guard at the back. This was the typical head-piece of the last half of the Hundred Years' War as the vizored basinet had been of the first. Like the basinet it was worn in a simple form by archers and pikemen and in a more elaborate form by the knights and men-at arms. The larger and heavier *salades* were also often used instead of the heaume in tournaments. Here again, however, there is a great difference between those worn by light armed men, foot-soldiers and archers and those of the heavy cavalry. The former, while possessing as a rule the bowl shape and the lip or brim of the type, and always destitute of the conical point which is the distinguishing mark of the basinet, are cut away in front of the face (fig. 7 a). In some cases this was remedied in part by the addition of a small pivoted vizor, which, however, could not protect the throat. In the larger *salades* of the heavy cavalry the wide brim served to protect the whole head, a slit being made in that part of the brim which came in front of the eyes (in some examples the whole of the front part of the brim was made movable). But the chin and neck, directly opposed to the enemy's blows, were scarcely protected at all, and with these helmets a large volant-piece or beaver (*mentonnière*)—usually a continuation of the body armour up to the chin or even beyond—was worn for this purpose, as shown in fig. 7 b. This arrangement combined, in a rough way, the advantages of freedom of movement for the head with adequate protection for the neck and lower part of the face. The *armet*, which came into use about 1475-1500 and completely superseded the *salade*, realized these requirements far better, and later at the zenith of the declaimer's art (about 1520) and throughout the period of the decline of armour it remained the standard pattern of helmet, whether for war or for tournament. It figures indeed in nearly all portraits of kings, nobles and

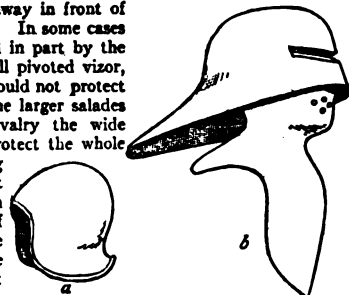

FIG. 7.—Salades or Sallets.

purely tilting, heaume are shown in figs. 4 and 5.

The basinet, then, is the battle head-dress of nobles, knights and sergeants in the 14th century. Its development from the

soldiers up to the time of Frederick the Great, either with the suit of armour or half-armour worn by the subject of the portrait or in allegorical trophies, &c. The armet was a fairly close-fitting rounded shell of iron or steel, with a movable vizor in front and complete plating over chin, ears and neck, the latter replacing the mentonnière or beaver. The armet was connected to the rest of the suit by the gorget, which was usually of thin laminated steel plates. With a good armet and gorget there was no weak point for the enemy's sword to attack, a roped lower edge of the armet generally fitting into a sort of flange round the top of the gorget. Thus, and in other and slightly different ways,



FIG. 8.—Armet.

was solved the problem which in the early days of plate armour had been attempted by the clumsy heaume and the flexible, if tough, camail of the vizored basinet, and still more clumsily in the succeeding period by the salade and its grotesque mentonnière. As far as existing examples show, the wide-brimmed salade itself first gave way to the more rounded armet, the mentonnière being carried up to the level of the eyes. Then the use (growing throughout the 15th century) of laminated armour for the joints of the harness probably suggested the gorget, and once this was applied to the lower edge of the armet by a satisfactory joint, it was an easy step to the elaborate pivoted vizor which completed the new head-dress. Types of armets are shown in fig. 8.

The *burgonet*, often confused with the armet, is the typical helmet of the late 16th and early 17th centuries. In its simple form it was worn by the foot and light cavalry—though the latter must not be held to include the pistol-armed *chevaux-légers* of the wars of religion, these being clad in half-armour and

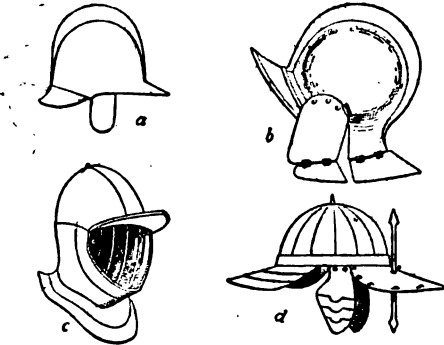

FIG. 9.—Burgonets.

vizored burgonet—and consisted of a (generally rounded) cap with a projecting brim shielding the eyes, a neck-guard and ear-pieces. It had almost invariably a crest or comb, as shown in the illustrations (fig. 9). Other forms of infantry head-gear much in vogue during the 16th century are shown in figs. 10 and 11, which represent the *morion* and *cabasset* respectively. Both these were lighter and smaller than the burgonet; indeed much of their popularity was due to the ease with which they were worn or put on and off, for in the matter of protection they could not compare with the burgonet, which in one form or another was used by cavalry (and often by pikemen) up to the final

disappearance of armour from the field of battle about 1670. Fig. 9 b gives the general outline of richly decorated 16th-century Italian burgonet which is preserved in Vienna. The archetype of the burgonet is perhaps the casque worn by the Swiss infantry (fig. 9 a) at the epoch of Marignan (1515).

This was probably copied by them from their former Burgundian antagonists, whose connexion with this helmet is sufficiently indicated by its name. The lower part of the more elaborate burgonets worn by nobles and cavalymen is often formed into a complete covering for the ears, cheek and chin, and connected closely with the gorget. They therefore resemble the armets and have often been confused with them, but the distinguishing feature of the burgonet is invariably the front peak. Various forms of vizor were fitted to such helmets; these as a rule were either fixed bars (fig. 9 c) or mere upward continuations of the chin piece. Often a nasal was the only face protection (fig. 9 d, a Hungarian type). The latest form of the burgonet used in active service is the familiar Cromwellian

cavalry helmet with its straight brim, from which depends the slight vizor of three bars or stout wires joined together at the bottom.

The above are of course only the main types. Some writers class all remaining examples either as casques or as "war-hats," the latter term conveniently covering all those helmets which resemble in any way the head-gear of civil life. For illustrations of many curiosities of this sort, including the famous iron hat of King Charles I. of England, and also for examples of Russian, Mongolian, Indian and Chinese helmets, the reader is referred to pp. 262-269 and 285-286 of Demmin's *Arms and Armour* (English edition 1894). The helmets in brass, steel or cloth, worn by troops since the general introduction of uniforms and the disuse of armour, depend for their shape and material solely on considerations of comfort and good appearance. From time to time, however, the re-adoption of serviceable helmets is advocated by cavalymen, and there is much to be said in favour of this. The burgonet, which was the final type of war helmet evolved by the old armourers, would certainly appear to be by far the best head-gear to adopt should these views prevail, and indeed it is still worn, in a modified yet perfectly recognizable form, by the German and other cuirassiers.

HELMHOLTZ, HERMANN LUDWIG FERDINAND VON (1821-1894), German philosopher and man of science, was born on the 31st of August 1821 at Potsdam, near Berlin. His father, Ferdinand, was a teacher of philology and philosophy in the gymnasium, while his mother was a Hanoverian lady, a lineal descendant of the great Quaker William Penn. Delicate in early life, Helmholtz became by habit a student, and his father at the same time directed his thoughts to natural phenomena. He soon showed mathematical powers, but these were not fostered by the careful training mathematicians usually receive, and it may be said that in after years his attention was directed to the higher mathematics mainly by force of circumstances. As his parents were poor, and could not afford to allow him to follow a purely scientific career, he became a surgeon of the Prussian army. In 1842 he wrote a thesis in which he announced the discovery of nerve-cells in ganglia. This was his first work, and from 1842 to 1894, the year of his death, scarcely a year passed without several important, and in some cases epoch-making, papers on scientific subjects coming from his pen. He lived in Berlin from 1842 to 1849, when he became professor of physiology in Königsberg. There he remained from 1849 to 1855, when he removed to the chair of physiology in Bonn. In 1858 he became professor of physiology in Heidelberg, and in 1871 he was called to occupy the chair of physics in Berlin. To this professorship was added in 1887 the post of director of the physico-technical institute at Charlottenburg, near Berlin,



FIG. 10.—Morion.

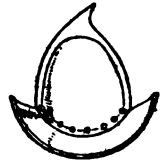

FIG. 11.—Cabasset.

and he held the two positions together until his death on the 8th of September 1894.

His investigations occupied almost the whole field of science, including physiology, physiological optics, physiological acoustics, chemistry, mathematics, electricity and magnetism, meteorology and theoretical mechanics. At an early age he contributed to our knowledge of the causes of putrefaction and fermentation. In physiological science he investigated quantitatively the phenomena of animal heat, and he was one of the earliest in the field of animal electricity. He studied the nature of muscular contraction, causing a muscle to record its movements on a smoked glass plate, and he worked out the problem of the velocity of the nervous impulse both in the motor nerves of the frog and in the sensory nerves of man. In 1847 Helmholtz read to the Physical Society of Berlin a famous paper, *Über die Erhaltung der Kraft* (on the conservation of force), which became one of the epoch-making papers of the century; indeed, along with J. R. Mayer, J. P. Joule and W. Thomson (Lord Kelvin), he may be regarded as one of the founders of the now universally received law of the conservation of energy. The year 1851, while he was lecturing on physiology at Königsberg, saw the brilliant invention of the ophthalmoscope, an instrument which has been of inestimable value to medicine. It arose from an attempt to demonstrate to his class the nature of the glow of reflected light sometimes seen in the eyes of animals such as the cat. When the great ophthalmologist, A. von Gräfe, first saw the fundus of the living human eye, with its optic disc and blood-vessels, his face flushed with excitement, and he cried, "Helmholtz has unfolded to us a new world!" Helmholtz's contributions to physiological optics are of great importance. He investigated the optical constants of the eye, measured by his invention, the ophthalmometer, the radii of curvature of the crystalline lens for near and far vision, explained the mechanism of accommodation by which the eye can focus within certain limits, discussed the phenomena of colour vision, and gave a luminous account of the movements of the eyeballs so as to secure single vision with two eyes. In particular he revived and gave new force to the theory of colour-vision associated with the name of Thomas Young, showing the three primary colours to be red, green and violet, and he applied the theory to the explanation of colour-blindness. His great work on *Physiological Optics* (1856-1866) is by far the most important book that has appeared on the physiology and physics of vision. Equally distinguished were his labours in physiological acoustics. He explained accurately the mechanism of the bones of the ear, and he discussed the physiological action of the cochlea on the principles of sympathetic vibration. Perhaps his greatest contribution, however, was his attempt to account for our perception of quality of tone. He showed, both by analysis and by synthesis, that quality depends on the order, number and intensity of the overtones or harmonics that may, and usually do, enter into the structure of a musical tone. He also developed the theory of differential and of summational tones. His work on *Sensations of Tone* (1862) may well be termed the *principia* of physiological acoustics. He may also be said to be the founder of the fixed-pitch theory of vowel tones, according to which it is asserted that the pitch of a vowel depends on the resonance of the mouth, according to the form of the cavity, while singing it, and this independently of the pitch of the note on which the vowel is sung. For the later years of his life his labours may be summed up under the following heads: (1) On the conservation of energy; (2) on hydro-dynamics; (3) on electro-dynamics and theories of electricity; (4) on meteorological physics; (5) on optics; and (6) on the abstract principles of dynamics. In all these fields of labour he made important contributions to science, and showed himself to be equally great as a mathematician and a physicist. He studied the phenomena of electrical oscillations from 1860 to 1871, and in the latter year he announced that the velocity of the propagation of electromagnetic induction was about 314,000 metres per second. Faraday had shown that the passage of electrical action involved time, and he also asserted that electrical phenomena are brought about by changes

in intervening non-conductors or dielectric substances. This led Clerk Maxwell to frame his theory of electro-dynamics, in which electrical impulses were assumed to be transmitted through the ether by waves. G. F. Fitzgerald was the first to attempt to measure the length of electric waves; Helmholtz put the problem into the hands of his favourite pupil, Heinrich Hertz, and the latter finally gave an experimental demonstration of electromagnetic waves, the "Hertzian waves," on which wireless telegraphy depends, and the velocity of which is the same as that of light. The last investigations of Helmholtz related to problems in theoretical mechanics, more especially as to the relations of matter to the ether, and as to the distribution of energy in mechanical systems. In particular he explained the principle of least action, first advanced by P. L. M. de Maupertuis, and developed by Sir W. R. Hamilton, of quaternion fame. Helmholtz also wrote on philosophical and aesthetic problems. His position was that of an empiricist, denying the doctrine of innate ideas and holding that all knowledge is founded on experience, hereditarily transmitted or acquired.

The life of Helmholtz was uneventful in the usual sense. He was twice married, first, in 1840, to Olga von Velten (by whom he had two children, a son and daughter), and secondly, in 1861, to Anna von Mohl, of a Würtemberg family of high social position. Two children were born of this marriage, a son, Robert, who died in 1880, after showing in experimental physics indications of his father's genius, and a daughter, who married a son of Werner von Siemens. Helmholtz was a man of simple but refined tastes, of noble carriage and somewhat austere manner. His life from first to last was one of devotion to science, and he must be accounted, on intellectual grounds, one of the foremost men of the 19th century.

See L. Königsberger, *Hermann von Helmholtz* (1902; English translation by F. A. Welby, Oxford, 1906); J. G. M'Kendrick, *H. L. F. von Helmholtz* (1899). (J. G. M.)

HELMOLD, an historian of the 12th century, was a priest at Bosau near Plön. He was a friend of the two bishops of Oldenburg, Vicelin (d. 1154) and Gerold (d. 1163), who did much to Christianize the Slavs. At Bishop Gerold's instigation Helmsold wrote his *Chronica Slavorum*, a history of the conquest and conversion of the Slavonic countries from the time of Charlemagne. For the life and times of Henry the Lion, duke of Saxony, Helmsold's chronicle, as that of a contemporary who had exceptional means for gaining information, is of first-rate importance. The history was continued down to 1209 by Abbot Arnold of Lübeck.

The *Chronica* were first edited by Siegmund Soborkel (Frankfurt a. M., 1566). The best edition is by J. M. Lappenberg in *Mon. Germ. hist. scriptores*, xxi. (1869). For critical works on the *Chronica* see A. Potthast, *Bibliotheca hist. med. aevi*, s. "Helmoldus."

HELMOND, a town in the province of North Brabant, Holland, on the small river Aa, and on the canal (Zuid-Willems Vaart) between 's Hertogenbosch and Maastricht, 24½ m. by rail W.N.W. of Venlo. It is connected by steam tramway with 's Hertogenbosch (21 m. N.W.), a branch line northwards to Osch being given off at Veghel. Pop. (1900) 11,465. The castle of Helmond, built in 1402, is a beautiful specimen of architecture, and among the other buildings of note in the town are the spacious church of St Lambert, the Reformed church and the town hall. Helmond is one of the industrial centres of the province, and possesses over a score of factories for cotton and silk weaving, cotton printing, dyeing, iron founding, brewing, soap boiling and tobacco dressing, as well as engine works and a margarine factory. There is an art school in the town.

HELMONT, JEAN BAPTISTE VAN (1577-1644), Belgian chemist, physiologist and physician, a member of a noble family, was born at Brussels in 1577.¹ He was educated at Louvain, and after ranging restlessly from one science to another and finding satisfaction in none, turned to medicine, in which he took his doctor's degree in 1599. The next few years he spent in travelling through Switzerland, Italy, France and England. Returning to his own country he was at Antwerp at the time of

¹ An alternative date for his birth is 1579 and for his death 1635 (see *Bull. Roy. Acad. Belg.*, 1907, 7, p. 732).

the great plague in 1605, and having contracted a rich marriage settled in 1609 at Vilvorde, near Brussels, where he occupied himself with chemical experiments and medical practice until his death on the 30th of December 1644. Van Helmont presents curious contradictions. On the one hand he was a disciple of Paracelsus (though he scornfully repudiates his errors as well as those of most other contemporary authorities); a mystic with strong leanings to the supernatural, an alchemist who believed that with a small piece of the philosopher's stone he had transmuted 2000 times as much mercury into gold; on the other hand he was touched with the new learning that was producing men like Harvey, Galileo and Bacon, a careful observer of nature, and an exact experimenter who in some cases realized that matter can neither be created nor destroyed. As a chemist he deserves to be regarded as the founder of pneumatic chemistry, even though it made no substantial progress for a century after his time, and he was the first to understand that there are gases distinct in kind from atmospheric air. The very word "gas" he claims as his own invention, and he perceived that his "gas sylvestre" (our carbon dioxide) given off by burning charcoal is the same as that produced by fermenting must and that which sometimes renders the air of caves irrespirable. For him air and water are the two primitive elements of things. Fire he explicitly denies to be an element, and earth is not one because it can be reduced to water. That plants, for instance, are composed of water he sought to show by the ingenious quantitative experiment of planting a willow weighing 5 lb in 200 lb of dry soil and allowing it to grow for five years; at the end of that time it had become a tree weighing 169 lb, and since it had received nothing but water and the soil weighed practically the same as at the beginning, he argued that the increased weight of wood, bark and roots had been formed from water alone. It was an old idea that the processes of the living body are fermentative in character, but he applied it more elaborately than any of his predecessors. For him digestion, nutrition and even movement are due to ferments, which convert dead food into living flesh in six stages. But having got so far with the application of chemical principles to physiological problems, he introduces a complicated system of supernatural agencies like the *archei* of Paracelsus, which preside over and direct the affairs of the body. A central *archeus* controls a number of subsidiary *archei* which move through the ferments, and just as diseases are primarily caused by some affection (*exorbitalis*) of the *archeus*, so remedies act by bringing it back to the normal. At the same time chemical principles guided him in the choice of medicines—undue acidity of the digestive juices, for example, was to be corrected by alkalis and *vice versa*; he was thus a forerunner of the iatrochemical school, and did good service to the art of medicine by applying chemical methods to the preparation of drugs. Over and above the *archeus* he taught that there is the sensitive soul which is the husk or shell of the immortal mind. Before the Fall the *archeus* obeyed the immortal mind and was directly controlled by it, but at the Fall men received also the sensitive soul and with it lost immortality, for when it perishes the immortal mind can no longer remain in the body. In addition to the *archeus*, which he described as "aura vitalis geminum, vitae directrix," Van Helmont had other governing agencies resembling the *archeus* and not always clearly distinguished from it. From these he invented the term *blas*, defined as the "vis motus tam alterivi quam localis." Of *blas* there were several kinds, e.g. *blas humanum* and *blas meteorum*; the heavens he said "constare gas materia et blas efficiente." He was a faithful Catholic, but incurred the suspicion of the Church by his tract *De magnetica vulnere curatione* (1621), which was thought to derogate from some of the miracles. His works were collected and published at Amsterdam as *Ortus medicinae, vel opera et opuscula omnia* in 1668 by his son Franz Mercurius (b. 1618 at Vilvorde, d. 1699 at Berlin), in whose own writings, e.g. *Cabbalah Denudata* (1677) and *Opuscula philosophica* (1690), mystical theosophy and alchemy appear in still wilder confusion.

See M. Foster *Lectures on the History of Physiology* (1901); also Chevreaux in *Journ. des savants* (Feb. and March 1850), and Cap

in *Journ. pharm. chim.* (1852). Other authorities are Poubius d'Elmoth, *Mémoire sur J. B. van Helmont* (1817); Rixner and Sieber, *Beiträge zur Geschichte der Physiologie* (1819-1826), vol. ii.; Spiers, *Helmont's System der Medicin* (1840); Melsens, *Leçons sur van Helmont* (1848); Rommelaere, *Études sur J. B. van Helmont* (1860).

HELMSTEDT, or more rarely *Helmsstädt*, a town of Germany, in the duchy of Brunswick, 30 m. N.W. of Magdeburg on the main line of railway to Brunswick. Pop. (1905) 15,415. The principal buildings are the Juleum, the former university, built in the Renaissance style towards the close of the 16th century, and containing a library of 40,000 volumes; the fine Stephanskirche dating from the 12th century; the Walpurgiskirche restored in 1893-1894; the Marienbergkirche, a beautiful church in the Roman style, and the Roman Catholic church. The Augustinian nunnery of Marienberg founded in 1176 is now a Lutheran school. The town contains the ruins of the Benedictine abbey of St Ludger, which was secularized in 1803. The educational institutions include several schools. The principal manufactures are furniture, yarn, soap, tobacco, sugar, vitriol and earthenware. Near the town is Bad Helmstedt, which has an iron mineral spring, and the Lübbensteine, two blocks of granite on which sacrifices to Woden are said to have been offered. Near Bad Helmstedt a monument has been erected to those who fell in the Franco-German War; in the town there is one to those killed at Waterloo. Helmstedt originated, according to legend, in connexion with the monastery founded by Ludger or Lüdger (d. 800), the first bishop of Münster. There appears, however, little doubt that this tradition is mythical and that Helmstedt was not founded until about 900. It obtained civic rights in 1099 and, although destroyed by the archbishop of Magdeburg in 1190, it was soon rebuilt. In 1457 it joined the Hanseatic League, and in 1490 it came into the possession of Brunswick. In 1576 Julius, duke of Brunswick, founded a university here, and throughout the 17th century this was one of the chief seats of Protestant learning. It was closed by Jerome, king of Westphalia, in 1809.

See Ludewig, *Geschichte und Beschreibung der Stadt Helmstedt* (Helmstedt, 1821).

HELMUND, a river of Afghanistan, in length about 600 m. The Helmund, which is identical with the ancient Etymander, is the most important river in Afghanistan, next to the Kabul river, which it exceeds both in volume and length. It rises in the recesses of the Koh-i-Baba to the west of Kabul, its infant stream parting the Unai pass from the Irak, the two chief passes on the well-known road from Kabul to Bamian. For 50 m. from its source its course is ascertained, but beyond that point for the next 50 m. no European has followed it. About the parallel of 33° N. it enters the Zamindawar province which lies to the N.W. of Kandahar, and thenceforward it is a well-mapped river to its termination in the lake of Seistan. Till about 40 m. above Girisikh the character of the Helmund is that of a mountain river, flowing through valleys which in summer are the resort of pastoral tribes. On leaving the hills it enters on a flat country, and extends over a gravelly bed. Here also it begins to be used in irrigation. At Girisikh it is crossed by the principal route from Herat to Kandahar. Forty-five miles below Girisikh the Helmund receives its greatest tributary, the Arghandab, from the high Ghilzai country beyond Kandahar, and becomes a very considerable river, with a width of 300 or 400 yds. and an occasional depth of 9 to 12 ft. Even in the dry season it is never without a plentiful supply of water. The course of the river is more or less south-west from its source till in Seistan it crosses meridian 62°, when it turns nearly north, and so flows for 70 or 80 m. till it falls into the Seistan hamuns, or swamps, by various mouths. In this latter part of its course it forms the boundary between Afghan and Persian Seistan, and owing to constant changes in its bed and the swampy nature of its borders it has been a fertile source of frontiersquabbles. Persian Seistan was once highly cultivated by means of a great system of canal irrigation; but for centuries, since the country was devastated by Timur, it has been a barren, treeless waste of flat alluvial plain. In years of exceptional flood the Seistan lakes spread southwards into an overflow channel called the

Shelag which, running parallel to the northern course of the Helmund in the opposite direction, finally loses its waters in the Gaud-i-Zirreh swamp, which thus becomes the final bourse of the river. Throughout its course from its confluence with the Arghandab to the ford of Chahar Burjak, where it bends northward, the Helmund valley is a narrow green belt of fertility sunk in the midst of a wide alluvial desert, with many thriving villages interspersed amongst the remains of ancient cities, relics of Kaiani rule. The recent political mission to Seistan under Sir Henry M^cMahon (1904-1905) added much information respecting the ancient and modern channels of the lower Helmund, proving that river to have been constantly shifting its bed over a vast area, changing the level of the country by silt deposits, and in conjunction with the terrific action of Seistan winds actually altering its configuration. (T. H. H.)*

HELM WIND, a wind that under certain conditions blows over the escarpment of the Pennines, near Cross Fell from the eastward, when a helm (helmet) cloud covers the summit. The helm bar is a roll of cloud that forms in front of it, to leeward.

See "Report on the Helm Wind Inquiry," by W. Marriott, *Quart. Journ. Roy. Met. Soc.* xv. 103.

HELOTS (Gr. ἑλωτες or ἑλωται), the serfs of the ancient Spartans. The word was derived in antiquity from the town of Helos in Laconia, but is more probably connected with ἑλος, a fen, or with the root of ἑλεῖν, to capture. Some scholars suppose them to have been of Achaean race, but they were more probably the aborigines of Laconia who had been enslaved by the Achaeans before the Dorian conquest. After the second Messenian war (see SPARTA) the conquered Messenians were reduced to the status of helots, from which Epaminondas liberated them three centuries later after the battle of Leuctra (371 B.C.). The helots were state slaves bound to the soil—*ascripti glebae*—and assigned to individual Spartiates to till their holdings (ἀγροί); their masters could neither emancipate them nor sell them off the land, and they were under an oath not to raise the rent payable yearly in kind by the helots. In time of war they served as light-armed troops or as rowers in the fleet; from the Peloponnesian War onwards they were occasionally employed as heavy infantry (βαλίστρα), distinguished bravery being rewarded by emancipation. That the general attitude of the Spartans towards them was one of distrust and cruelty cannot be doubted. Aristotle says that the ephors of each year on entering office declared war on the helots so that they might be put to death at any time without violating religious scruple (Plutarch, *Lycargus* 38), and we have a well-attested record of 3000 helots being freed for service in war and then secretly assassinated (Thuc. iv. 80). But when we remember the value of the helots from a military and agricultural point of view we shall not readily believe that the *crypteia* was really, as some authors represent it, an organized system of massacre; we shall see in it "a good police training, inculcating hardihood and vigour in the young," while at the same time getting rid of any helots who were found to be plotting against the state (see further CRYPTeia).

Intermediate between Helots and Spartiates were the two classes of *Neodamodes* and *Mothones*. The former were emancipated helots, or possibly their descendants, and were much used in war from the end of the 5th century; they served especially on foreign campaigns, as those of Thibron (400-399 B.C.) and Agesilaus (396-394 B.C.) in Asia Minor. The *mothones* or *mothakes* were usually the sons of Spartiates and helot mothers; they were free men sharing the Spartan training, but were not full citizens, though they might become such in recognition of special merit.

See C. O. Müller, *History and Antiquities of the Doric Race* (Eng. trans.), bk. iii. ch. 3; G. Gilbert, *Greek Constitutional Antiquities* (Eng. trans.), pp. 30-35; A. H. J. Greenidge, *Handbook of Greek Constitutional History*, pp. 83-85; G. Busolt, *Die griech. Staats- u. Rechtsaltertümer*, § 84; *Griechische Geschichte*, i. 525-528; G. F. Schömann, *Antiquities of Greece: The State* (Eng. trans.) pp. 194 ff. (M. N. T.)

HELPS, SIR ARTHUR (1813-1875), English writer and clerk of the Privy Council, youngest son of Thomas Helps, a London

merchant, was born near London on the 10th of July 1813. He was educated at Eton and at Trinity College, Cambridge, coming out 31st wrangler in the mathematical tripos in 1835. He was recognised by the ablest of his contemporaries there as a man of superior gifts, and likely to make his mark in after life. As a member of the *Conversazione Society*, better known as the "Apostles," a society established in 1820 for the purposes of discussion on social and literary questions by a few young men attracted to each other by a common taste for literature and speculation, he was associated with Charles Buller, Frederick Maurice, Richard Chenevix Trench, Monckton Milnes, Arthur Hallam and Alfred Tennyson. His first literary effort, *Thoughts in the Cloister and the Crowd* (1835), was a series of aphorisms upon life, character, politics and manners. Soon after leaving the university Arthur Helps became private secretary to Spring Rice (afterwards Lord Montagu), then chancellor of the exchequer. This appointment he filled till 1839, when he went to Ireland as private secretary to Lord Morpeth (afterwards earl of Carlisle), chief secretary for Ireland. In the meanwhile (28th October 1836) Helps had married Bessy, daughter of Captain Edward Fuller. He was one of the commissioners for the settlement of certain Danish claims which dated so far back as the siege of Copenhagen; but with the fall of the Melbourne administration (1841) his official experience closed for a period of nearly twenty years. He was not, however, forgotten by his political friends. He possessed admirable tact and sagacity; his fitness for official life was unmistakable; and in 1860 he was appointed clerk of the Privy Council, on the recommendation of Lord Granville.

His *Essays written in the Intervals of Business* had appeared in 1841, and his *Claims of Labour, an Essay on the Duties of the Employers to the Employed*, in 1844. Two plays, *King Henry the Second, an Historical Drama*, and *Catherina Douglas, a Tragedy*, published in 1843, have no particular merit. Neither in these, nor in his only other dramatic effort, *Outliva the Serf* (1858) did he show any real qualifications as a playwright.

Helps possessed, however, enough dramatic power to give life and individuality to the dialogues with which he enlivened many of his other books. In his *Friends in Council, a Series of Readings and Discourse thereon* (1847-1859), Helps varied his presentment of social and moral problems by dialogues between imaginary personages, who, under the names of Milverton, Ellesmere and Dunsford, grew to be almost as real to Helps's readers as they certainly became to himself. The book was very popular, and the same expedient was resorted to in *Conversations on War and General Culture*, published in 1871. The familiar speakers, with others added, also appeared in his *Realms* (1868) and in the best of its author's later works, *Talk about Animals and their Masters* (1873).

A long essay on slavery in the first series of *Friends in Council* was subsequently elaborated into a work in two volumes published in 1848 and 1852, called *The Conquerors of the New World and their Bondsmen*. Helps went to Spain in 1847 to examine the numerous MSS. bearing upon his subject at Madrid. The fruits of these researches were embodied in an historical work based upon his *Conquerors of the New World*, and called *The Spanish Conquest in America, and its Relation to the History of Slavery and the Government of Colonies* (4 vols., 1855-1861). But in spite of his scrupulous efforts after accuracy, the success of the book was marred by its obtusely moral purpose and its discursive character.

The Life of Las Casas, the Apostle of the Indians (1868), *The Life of Columbus* (1869), *The Life of Pizarro* (1869), and *The Life of Hernando Cortes* (1871), when extracted from the work and published separately, proved successful. Besides the books which have been already mentioned he wrote: *Organisation in Daily Life, an Essay* (1862), *Casimir Mavromma* (1870), *Brevia, Short Essays and Aphorisms* (1871), *Thoughts upon Government* (1872), *Life and Labours of Mr Thomas Brassey* (1872), *Ioan de Biron* (1874), *Social Pressure* (1875).

His appointment as clerk of the Council brought him into personal communication with Queen Victoria and the Prince

Consoit, both of whom came to regard him with confidence and respect. After the Prince's death, the Queen early turned to Helps to prepare an appreciation of her husband's life and character. In his introduction to the collection (1862) of the Prince Consort's speeches and addresses Helps adequately fulfilled his task. Some years afterwards he edited and wrote a preface to the Queen's *Leaves from a Journal of our Life in the Highlands* (1868). In 1864 he received the honorary degree of D.C.L. from the university of Oxford. He was made a C.B. in 1871 and K.C.B. in the following year. His later years were troubled by financial embarrassments, and he died on the 7th of March 1875.

HELSINGBORG, a seaport of Sweden in the district (*län*) of Malmöhus, 35 m. N. by E. of Copenhagen by rail and water. Pop. (1900), 24,670. It is beautifully situated at the narrowest part of Öresund, or the Sound, here only 3 m. wide, opposite Helsingör (Elsinore) in Denmark. Above the town the brick tower of a former castle crowns a hill, commanding a fine view over the Sound. On the outskirts are the Öresund Park, gardens containing iodide and bromide springs, and frequented sea-baths. On the coast to the north is the royal *château* of Sofiero; to the south, the small spa of Ramlösa. A system of electric trams is maintained. North and east of Helsingborg lies the only coal-field in Sweden, extending into the lofty Kullen peninsula, which forms the northern part of the east shore of the Sound. Potter's clay is also found. Helsingborg ranks among the first manufacturing towns of Sweden, having copper works, using ore from Sulitelma in Norway, india-rubber works and breweries. The artificial harbour has a depth of 24 ft., and there are extensive docks. The chief exports are timber, butter and iron. The town is the headquarters of the first army division.

The original site of the town is marked by the tower of the old fortress, which is first mentioned in 1135. In the 14th century it was several times besieged. From 1370 along with other towns in the province of Skåne, it was united for fifteen years with the Hanseatic League. The fortress was destroyed by fire in 1418, and about 1425 Eric XIII. built another near the sea, and caused the town to be transported thither, bestowing upon it important privileges. Until 1658 it belonged to Denmark; and it was again occupied by the Danes in 1676 and 1677. In 1684 its fortifications were dismantled. It was taken by Frederick IV. of Denmark in November 1709, but on the 28th of February 1710 the Danes were defeated in the neighbourhood, and the town came finally into the possession of Sweden, though in 1711 it was again bombarded by the Danes. A tablet on the quay commemorates the landing of Bernadotte after his election as successor to the throne in 1810.

HELSINGFORS (Finnish *Helsinki*), a seaport and the capital of Finland and of the province of Nyland, centre of the administrative, scientific, educational and industrial life of Finland. The fine harbour is divided into two parts by a promontory, and is protected at its entrance by a group of small islands, on one of which stands the fortress of Sveaborg. A third harbour is situated on the west side of the promontory, and all three have granite quays. The city, which in 1810 had only 4065 inhabitants, Åbo then capital having 10,224, has increased with great rapidity, having 22,228 inhabitants in 1860, 61,530 in 1890 and 111,654 in 1904. It is the centre of an active shipping trade with the Baltic ports and with England, and of a railway system connecting it with all parts of the grand duchy and with St Petersburg. Helsingfors is handsome and well laid out with wide streets, parks, gardens and monuments. The principal square contains the cathedral of St Nicholas, the Senate House and the university, all striking buildings of considerable architectural distinction. In the centre is the statue of the Tsar Alexander II., who is looked upon as the protector of the liberties of Finland, the monument being annually decorated with wreaths and garlands. The university has a teaching staff of 141 with (1906) 1921 students, of whom 328 were women. The university is well provided with museums and laboratories and has a library of over 250,000 volumes. Other public institutions are the Athenaeum, with picture gallery, a Swedish theatre

and opera house, a Finnish theatre, the Archives, the Senate House, the Nobles' House (*Riddarhuset*) and the House of the Estates, the German (Lutheran) church and the Russian church. Some of the scientific societies of Helsingfors have a wide repute, such as the academy of sciences, the geographical, historical, Finno-Ugric, biblical, medical, law, arts and forestry societies, as also societies for the spread of popular education and of arts and crafts. There are a polytechnic, ten high schools, navigation and trade schools, institutes for the blind and the mentally deficient, and numerous elementary schools. The general standard of education is high, the publication of books, reviews and newspapers being very active. The language of culture is Swedish, but owing to recent manufacturing developments the majority of the population is Finnish-speaking. Helsingfors displays great manufacturing and commercial activity, the imports being coal, machinery, sugar, grain and clothing. The manufactures of the city consist largely of tobacco, beer and spirits, carpets, machinery and sugar.

HELST, BARTHOLOMAEUS VAN DER, Dutch painter, was born in Holland at the opening of the 17th century, and died at Amsterdam in 1670. The date and place of his birth are uncertain; and it is equally difficult to confirm or to deny the time-honoured statement that he was born in 1613 at Amsterdam. It has been urged indeed by competent authority that Van der Helst was not a native of Amsterdam, because a family of that name lived as early as 1607 at Haarlem, and pictures are shown as works of Van der Helst in the Haarlem Museum which might tend to prove that he was in practice there before he acquired repute at Amsterdam. Unhappily Bartholomew has not been traced amongst the children of Severijn van der Helst, who married at Haarlem in 1607, and there is no proof that the pictures at Haarlem are really his; though if they were so they would show that he learnt his art from Frans Hals and became a skilled master as early as 1631. Scheltema, a very competent judge in matters of Dutch-art chronology, supposes that Van der Helst was a resident at Amsterdam in 1636. His first great picture, representing a gathering of civic guards at a brewery, is variously assigned to 1639 and 1643, and still adorns the town-hall of Amsterdam. His noble portraits of the burgomaster Bicker and Andreas Bicker the younger, in the gallery of Amsterdam, of the same date no doubt as Bicker's wife lately in the Ruhl collection at Cologne, were completed in 1642. From that time till his death there is no difficulty in tracing Van der Helst's career at Amsterdam. He acquired and kept the position of a distinguished portrait-painter, producing indeed little or nothing besides portraits at any time, but founding, in conjunction with Nicolaes de Helt Stokade, the painters' guild at Amsterdam in 1654. At some unknown date he married Constance Reynast, of a good patrician family in the Netherlands, bought himself a house in the Doelenstrasse and ended by earning a competence. His likeness of Paul Potter at the Hague, executed in 1654, and his partnership with Backhuysen, who laid in the backgrounds of some of his pictures in 1668, indicate a constant companionship with the best artists of the time. Wagen has said that his portrait of Admiral Kortenaar, in the gallery of Amsterdam, betrays the teaching of Frans Hals, and the statement need not be gainsaid; yet on the whole Van der Helst's career as a painter was mainly a protest against the systems of Hals and Rembrandt. It is needless to dwell on the pictures which preceded that of 1648, called the Peace of Münster, in the gallery of Amsterdam. The Peace challenges comparison at once with the so-called Night Watch by Rembrandt and the less important but not less characteristic portraits of Hals and his wife in a neighbouring room. Sir Joshua Reynolds was disappointed by Rembrandt, whilst Van der Helst surpassed his expectation. But Bürger asked whether Reynolds had not already been struck with blindness when he ventured on this criticism. The question is still an open one. But certainly Van der Helst attracts by qualities entirely differing from those of Rembrandt and Frans Hals. Nothing can be more striking than the contrast between the strong concentrated light and the deep gloom of Rembrandt and the contempt of chiaroscuro

peculiar to his rival, except the contrast between the rapid sketchy touch of Hals and the careful finish and rounding of van der Helst. "The Peace" is a meeting of guards to celebrate the signature of the treaty of Münster. The members of the Doele of St George meet to feast and congratulate each other not at a formal banquet but in a spot laid out for good cheer, where de Wit, the captain of his company, can shake hands with his lieutenant Waveren, yet hold in solemn state the great drinking-horn of St George. The rest of the company sit, stand or busy themselves around—some eating, others drinking, others carving or serving—an animated scene on a long canvas, with figures large as life. Well has Bürger said, the heads are full of life and the hands admirable. The dresses and subordinate parts are finished to a nicety without sacrifice of detail or loss of breadth in touch or impast. But the eye glides from shape to shape, arrested here by expressive features, there by a bright stretch of colours, nowhere at perfect rest because of the lack of a central thought in light and shade, harmonies or composition. Great as the qualities of van der Helst undoubtedly are, he remains below the line of demarcation which separates the second from the first-rate masters of art.

His pictures are very numerous, and almost uniformly good; but in his later creations he wants power, and though still amazingly careful, he becomes grey and woolly in touch. At Amsterdam the four regents in the Werkhuys (1650), four syndics in the gallery (1656), and four syndics in the town-hall (1657) are masterpieces, to which may be added a number of fine single portraits. Rotterdam, notwithstanding the fire of 1864, still boasts of three of van der Helst's works. The Hague owns but one. St Petersburg, on the other hand, possesses ten or eleven, of various shades of excellence. The Louvre has three, Munich four. Other pieces are in the galleries of Berlin, Brunswick, Brussels, Karlsruhe, Cassel, Darmstadt, Dresden, Frankfurt, Gotha, Stuttgart and Vienna.

HELSTON, a market town and municipal borough in the Truro parliamentary division of Cornwall, England, 11 m. by road W.S.W. of Falmouth, on a branch of the Great Western railway. Pop. (1901) 3088. It is pleasantly situated on rising ground above the small river Cober, which, a little below the town, expands into a picturesque estuary called Looe Pool, the water being banked up by the formation of Looe Bar at the mouth. Formerly, when floods resulted from this obstruction, the townsfolk of Helston acquired the right of clearing a passage through it by presenting leathern purses containing three halfpence to the lord of the manor. The mining industry on which the town formerly depended is extinct, but the district is agricultural and dairy farming is carried on, while the town has flour mills, tanneries and iron foundries. As Helston has the nearest railway station to the Lizard, with its magnificent coast-scenery, there is a considerable tourist traffic in summer. Some trade passes through the small port of Porthleven, 3 m. S.W., where the harbour admits vessels of 500 tons. On the 8th of May a holiday is still observed in Helston and known as Flora or Furry day. It has been regarded as a survival of the Roman *Floralia*, but its origin is believed by some to be Celtic. Flowers and branches were gathered, and dancing took place in the streets and through the houses, all being thrown open, while a pageant was also given and a special ancient folk-song chanted. This ceremony, after being almost forgotten, has been revived in modern times. The borough is under a mayor, 4 aldermen and 12 councillors. Area, 309 acres.

Helston (Heliston, Haliston, Helleston), the capital of the Meneage district of Cornwall, was held by Earl Harold in the time of the Confessor and by King William at the Domesday Survey. At the latter date besides seventy-three villeins, bordars and serfs there were forty *carversarii*, a species of unfree tenants who rendered their custom in the form of beer. King John (1201) constituted Helleston a free borough, established a gild merchant, and granted the burghesses freedom from toll and other similar dues throughout the realm, and the cognizance of all pleas within the borough except crown pleas. Richard, king of the Romans (1260), extended the boundaries of the borough and granted permission for the erection of an additional mill. Edward I. (1304) granted the tenure of the, and Edward III. a

Saturday market and four fairs. Of these the Saturday market and a fair on the feast of SS. Simon and Jude are still held, also five other fairs of uncertain origin. In 1285 Elizabeth granted a charter of incorporation under the name of the mayor and commonalty of Helston. This was confirmed in 1641, when it was also provided that the mayor and recorder should be *ipso facto* justices of the peace. From 1294 to 1831 Helston returned two members to parliament. In 1774 the number of electors (which by usage had been restricted to the mayor, aldermen and freemen elected by them) had dwindled to six, and in 1790 to one person only, whose return of two members, however, was rejected and that of the general body of the freemen accepted. In 1832 Helston lost one of its members, and in 1885 it lost the other and became merged in the county.

HELVETIC CONFESSIONS, the name of two documents expressing the common belief of the reformed churches of Switzerland. The first, known also as the Second Confession of Basel, was drawn up at that city in 1536 by Bullinger and Leo Jud of Zürich, Megander of Bern, Oswald Myconius and Grynaeus of Basel, Bucer and Capito of Strassburg, with other representatives from Schaffhausen, St Gall, Mühlhausen and Biel. The first draft was in Latin and the Zürich delegates objected to its Lutheran phraseology.¹ Leo Jud's German translation was, however, accepted by all, and after Myconius and Grynaeus had modified the Latin form, both versions were agreed to and adopted on the 26th of February 1536.

The Second Helvetic Confession was written by Bullinger in 1562 and revised in 1564 as a private exercise. It came to the notice of the elector palatine Friedrich III., who had it translated into German and published. It gained a favourable hold on the Swiss churches, who had found the First Confession too short and too Lutheran. It was adopted by the Reformed Church not only throughout Switzerland but in Scotland (1566), Hungary (1567), France (1571), Poland (1578), and next to the Heidelberg Catechism is the most generally recognized Confession of the Reformed Church.

See L. Thomas, *La Confession helvétique* (Geneva, 1853); P. Schaff, *Credo of Christendom*, i. 390-420, iii. 234-306; Müller, *Die Bekenntnisschriften der reformierten Kirche* (Leipzig, 1903).

HELVETII ('ΕΛΟΥΨΤΙΟΙ, 'ΕΛΘΨΤΙΟΙ), a Celtic people, whose original home was the country between the Hercynian forest (probably the Raube Alp), the Rhine and the Main (Tacitus, *Germania*, 28). In Caesar's time they appear to have been driven farther west, since, according to him (*Bell. Gall.* i. 2. 3) their boundaries were on the W. the Jura, on the S. the Rhone and the Lake of Geneva, on the N. and E. the Rhine as far as Lake Constance. They thus inhabited the western part of modern Switzerland. They were divided into four cantons (*pagi*), common affairs being managed by the cantonal assemblies. They possessed the elements of a higher civilization (gold coinage, the Greek alphabet), and, according to Caesar, were the bravest people of Gaul. The reports of gold and plunder spread by the Cimbri and Teutones on their way to southern Gaul induced the Helvetii to follow their example. In 107, under Divico, two of their tribes, the Tougeni and Tigurini, crossed the Jura and made their way as far as Aginnum (Agen on the Garonne), where they utterly defeated the Romans under L. Cassius Longinus, and forced them to pass under the yoke (*Livy, Epit.* 65; according to a different reading, the battle took place near the Lake of Geneva). In 102 the Helvetii joined the Cimbri in the invasion of Italy, but after the defeat of the latter by Marius they returned home. In 58, hard pressed by the Germans and incited by one of their princes, Orgetorix, they resolved to found a new home west of the Jura. Orgetorix was thrown into prison, being suspected of a design to make himself king, but the Helvetii themselves persisted in their plan. Joined by the Rauraci, Tulingi, Latobrigi and some of the Boii—according to their own reckoning 368,000 in all—they agreed to meet on the 28th of

¹ Some of the delegates, especially Bucer, were anxious to effect a union of the Reformed and Lutheran Churches. There was also a desire to lay the Confession before the council summoned at Mantua by Pope Paul III.

March at Geneva and to advance through the territory of the Allobroges. They were overtaken, however, by Caesar at Bibracte, defeated and forced to submit. Those who survived were sent back home to defend the frontier of the Rhine against German invaders. During the civil wars and for some time after the death of Caesar little is heard of the Helvetii.

Under Augustus Helvetia (not so called till later times, earlier *ager Helvetiorum*) proper was included under Gallia Belgica. Two Roman colonies had previously been founded at Noviodunum (Colonia Julia Equestris, mod. *Nyon*) and at Colonia Rauracorum (afterwards Augusta Rauracorum, *Augst* near Basel) to keep watch over the inhabitants, who were treated with generosity by their conquerors. Under the name of *foederati* they retained their original constitution and division into four cantons. They were under an obligation to furnish a contingent to the Roman army for foreign service, but were allowed to maintain garrisons of their own, and their magistrates had the right to call out a militia. Their religion was not interfered with; they managed their own local affairs and kept their own language, although Latin was used officially. Their chief towns were Aventicum (*Avenches*) and Vindonissa (*Windisch*). Under Tiberius the Helvetii were separated from Gallia Belgica and made part of Germania Superior. After the death of Galba (A.D. 69), having refused submission to Vitellius, their land was devastated by Alienus Caecina, and only the eloquent appeal of one of their leaders named Claudius Cossus saved them from annihilation. Under Vespasian they attained the height of their prosperity. He greatly increased the importance of Aventicum, where his father had carried on business. Its inhabitants, with those of other towns, probably obtained the *ius Latinum*, had a senate, a council of *decuriones*, a prefect of public works and flammens of Augustus. After the extension of the eastern frontier, the troops were withdrawn from the garrisons and fortresses, and Helvetia, free from warlike disturbances, gradually became completely romanized. Aventicum had an amphitheatre, a public gymnasium and an academy with Roman professors. Roads were made wherever possible, and commerce rapidly developed. The old Celtic religion was also supplanted by the Roman. The west of the country, however, was more susceptible to Roman influence, and hence preserved its independence against barbarian invaders longer than its eastern portion. During the reign of Gallienus (260-268) the Alamanni overran the country; and although Probus, Constantius Chlorus, Julian, Valentinian I. and Gratian to some extent checked the inroads of the barbarians, it never regained its former prosperity. In the subdivision of Gaul in the 4th century, Helvetia, with the territory of the Sequani and Rauraci, formed the Provincia Maxima Sequanorum, the chief town of which was Vesontio (*Besançon*). Under Honorius (395-423) it was probably definitely occupied by the Alamanni, except in the west, where the small portion remaining to the Romans was ceded in 436 by Aëtius to the Burgundians.

See L. von Haller, *Helvetien unter den Römern* (Bern, 1811); T. Mommsen, *Die Schweiz in römischer Zeit* (Zurich, 1854); J. Brosi, *Die Kellen und Althelvetier* (Solothurn, 1851); L. Hug and K. Stead, "Switzerland" in *Story of the Nations*, xxvi.; C. Dändliker, *Geschichte der Schweiz* (1892-1895), and English translation (of a shorter history by the same) by E. Salisbury (1899); *Die Schweiz unter den Römern* (anonymous) published by the Historischer Verein of St Gall (Scheitlin and Zolliker, St Gall, 1862); and G. Wyls, "Über das römische Helvetien" in *Archiv für schweizerische Geschichte*, vii. (1851). For Caesar's campaign against the Helvetii, see T. R. Holmes, *Caesar's Conquest of Gaul* (1899) and Mommsen, *Hist. of Rome* (Eng. trans.), bk. v. ch. 7; ancient authorities in A. Holder, *Alteltischer Sprochschatz* (1896), s.v. *Elvetii*.

HELVÉTIUS, CLAUDE ADRIEN (1715-1771), French philosopher and littérateur, was born in Paris in January 1715. He was descended from a family of physicians, whose original name was Schweitzer (Latinized as Helvetius). His grandfather introduced the use of ipecacuanha; his father was first physician to Queen Marie Lezinska of France. Claude Adrien was trained for a financial career, but he occupied his spare time with writing verses. At the age of twenty-three, at the queen's request, he was appointed farmer-general, a post of great responsibility and dignity worth a 100,000 crowns a year. Thus

provided for, he proceeded to enjoy life to the utmost, with the help of his wealth and liberality, his literary and artistic tastes. As he grew older, however, his social successes ceased, and he began to dream of more lasting distinctions, stimulated by the success of Maupertuis as a mathematician, of Voltaire as a poet, of Montesquieu as a philosopher. The mathematical dream seems to have produced nothing; his poetical ambitions resulted in the poem called *Le Bonheur* (published posthumously, with an account of Helvétius's life and works, by C. F. de Saint-Lambert, 1773), in which he develops the idea that true happiness is only to be found in making the interest of one that of all; his philosophical studies ended in the production of his famous book *De l'esprit*. It was characteristic of the man that, as soon as he thought his fortune sufficient, he gave up his post of farmer-general, and retired to an estate in the country, where he employed his large means in the relief of the poor, the encouragement of agriculture and the development of industries. *De l'esprit* (Eng. trans. by W. Muddford, 1809), intended to be the rival of Montesquieu's *L'Esprit des lois*, appeared in 1758. It attracted immediate attention and aroused the most formidable opposition, especially from the dauphin, son of Louis XV. The Sorbonne condemned the book, the priests persuaded the court that it was full of the most dangerous doctrines, and the author, terrified at the storm he had raised, wrote three separate retractations; yet, in spite of his protestations of orthodoxy, he had to give up his office at the court, and the book was publicly burned by the hangman. The virulence of the attacks upon the work, as much as its intrinsic merit, caused it to be widely read; it was translated into almost all the languages of Europe. Voltaire said that it was full of commonplaces, and that what was original was false or problematical; Rousseau declared that the very benevolence of the author gave the lie to his principles; Grimm thought that all the ideas in the book were borrowed from Diderot; according to Madame du Defand, Helvétius had raised such a storm by saying openly what every one thought in secret; Madame de Graffigny averred that all the good things in the book had been picked up in her own *salon*. In 1764 Helvétius visited England, and the next year, on the invitation of Frederick II., he went to Berlin, where the king paid him marked attention. He then returned to his country estate and passed the remainder of his life in perfect tranquillity. He died on the 26th of December 1771.

His philosophy belongs to the utilitarian school. The four discussions of which his book consists have been thus summed up: (1) All man's faculties may be reduced to physical sensation, even memory, comparison, judgment; our only difference from the lower animals lies in our external organization. (2) Self-interest, founded on the love of pleasure and the fear of pain, is the sole spring of judgment, action, affection; self-sacrifice is prompted by the fact that the sensation of pleasure outweighs the accompanying pain; it is thus the result of deliberate calculation; we have no liberty of choice between good and evil; there is no such thing as absolute right—ideas of justice and injustice change according to customs. (3) All intellects are equal; their apparent inequalities do not depend on a more or less perfect organization, but have their cause in the unequal desire for instruction, and this desire springs from passions, of which all men commonly well organized are susceptible to the same degree; and we can, therefore, all love glory with the same enthusiasm and we owe all to education. (4) In this discourse the author treats of the ideas which are attached to such words as *genius, imagination, talent, taste, good sense, &c.* The only original ideas in his system are those of the natural equality of intelligences and the omnipotence of education, neither of which, however, is generally accepted, though both were prominent in the system of J. S. Mill. There is no doubt that his thinking was unsystematic; but many of his critics have entirely misrepresented him (e.g. Cairns in his *Unbelief in the Eighteenth Century*). As J. M. Robertson (*Short History of Free Thought*) points out, he had great influence upon Bentham, and C. Beccaria states that he himself was largely inspired by Helvétius in his attempt to modify penal laws. The keynote of his thought was

that public ethics has a utilitarian basis, and he insisted strongly on the importance of culture in national development.

A sort of supplement to the *De l'Esprit*, called *De l'homme, de ses facultés intellectuelles et de son éducation* (Eng. trans. by W. Hooper, 1777), found among his manuscripts, was published after his death, but created little interest. There is a complete edition of the works of Helvétius, published at Paris, 1818. For an estimate of his work and his place among the philosophers of the 18th century see Victor Cousin's *Philosophie sensualiste* (1863); P. L. Lezard, *Résumés philosophiques* (1853); F. D. Maurice, in his *Modern Philosophy* (1862), pp. 537 seq.; J. Morley, *Diderot and the Encyclopædists* (London, 1878); D. G. Mostratos, *Die Pädagogik des Helvétius* (Berlin, 1891); A. Guillois, *Le Salon de Madame Helvétius* (1894); A. Piazzì, *Le Idee filosofiche specialmente pedagogiche di C. A. Helvétius* (Milan, 1889); G. Plekhanov, *Beiträge zur Geschichte des Materialismus* (Stuttgart, 1896); L. Limentani, *Le Teorie psicologiche di C. A. Helvétius* (Verona, 1902); A. Keim, *Helvétius, sa vie et son œuvre* (1907).

HELVIDIUS PRISCUS, Stoic philosopher and statesman, lived during the reigns of Nero, Galba, Otho, Vitellius and Vespasian. Like his father-in-law, Thrasea Paetus, he was distinguished for his ardent and courageous republicanism. Although he repeatedly offended his rulers, he held several high offices. During Nero's reign he was quaestor of Achaëa and tribune of the plebs (A.D. 56), he restored peace and order in Armenia, and gained the respect and confidence of the provincials. His declared sympathy with Brutus and Cassius occasioned his banishment in 66. Having been recalled to Rome by Galba in 68, he at once impeached Eprius Marcellus, the accuser of Thrasea Paetus, but dropped the charge, as the condemnation of Marcellus would have involved a number of senators. As praetor elect he ventured to oppose Vitellius in the senate (Tacitus, *Hist.* ii. 91), and as praetor (70) he maintained, in opposition to Vespasian, that the management of the finances ought to be left to the discretion of the senate; he proposed that the capitol, which had been destroyed in the Neronian conflagration, should be restored at the public expense; he saluted Vespasian by his private name, and did not recognize him as emperor in his praetorian edicts. At length he was banished a second time, and shortly afterwards was executed by Vespasian's order. His life, in the form of a warm panegyric, written at his widow's request by Herennius Senecio, caused its author's death in the reign of Domitian.

Tacitus, *Hist.* iv. 5, *Dialogus*, 5; Dio Cassius lxxi. 12, lxxvii. 13; Suetonius, *Vespasian*, 15; Pliny, *Epp.* vii. 19.

HELY-HUTCHINSON, JOHN (1724-1793), Irish lawyer, statesman, and provost of Trinity College, Dublin, son of Francis Hely, a gentleman of County Cork, was educated at Trinity College, Dublin, and was called to the Irish bar in 1748. He took the additional name of Hutchinson on his marriage in 1751 with Christiana Nixon, heiress of her uncle, Richard Hutchinson. He was elected member of the Irish House of Commons for the borough of Lanesborough in 1759, but after 1761 he represented the city of Cork. He at first attached himself to the "patriotic" party in opposition to the government, and although he afterwards joined the administration he never abandoned his advocacy of popular measures. He was a man of brilliant and versatile ability, whom Lord Townshend, the lord lieutenant, described as "by far the most powerful man in parliament." William Gerard Hamilton said of him that "Ireland never bred a more able, nor any country a more honest man." Hely-Hutchinson was, however, an inveterate place-hunter, and there was point in Lord North's witticism that "if you were to give him the whole of Great Britain and Ireland for an estate, he would ask the Isle of Man for a potato garden." After a session or two in parliament he was made a privy councillor and prime serjeant-at-law; and from this time he gave a general, though by no means invariable, support to the government. In 1767 the ministry contemplated an increase of the army establishment in Ireland from 12,000 to 25,000 men, but the Augmentation Bill met with strenuous opposition, not only from Flood, Ponsonby and the habitual opponents of the government, but from the Undertakers, or proprietors of boroughs, on whom the government had hitherto relied to secure them a majority in the House of Commons. It

therefore became necessary for Lord Townshend to turn to other methods for procuring support. Early in 1768 an English act was passed, for the increase of the army, and a message from the king setting forth the necessity for the measure was laid before the House of Commons in Dublin. An address favourable to the government policy was, however, rejected; and Hely-Hutchinson, together with the speaker and the attorney-general, did their utmost both in public and private to obstruct the bill. Parliament was dissolved in May 1768, and the lord lieutenant set about the task of purchasing or otherwise securing a majority in the new parliament. Peerages, pensions and places were bestowed lavishly on those whose support could be thus secured; Hely-Hutchinson was won over by the concession that the Irish army should be established by the authority of an Irish act of parliament instead of an English one. The Augmentation Bill was carried in the session of 1769 by a large majority. Hely-Hutchinson's support had been so valuable that he received as reward an addition of £1,000 a year to the salary of his sinecure of Alnagar, a major's commission in a cavalry regiment, and a promise of the secretaryship of state. He was at this time one of the most brilliant debaters in the Irish parliament, and he was enjoying an exceedingly lucrative practice at the bar. This income, however, together with his well-salaried sinecure, and his place as prime serjeant, he surrendered in 1774, to become provost of Trinity College, although the statute requiring the provost to be in holy orders had to be dispensed with in his favour.

For this great academic position Hely-Hutchinson was in no way qualified, and his appointment to it for purely political service to the government was justly criticized with much asperity. His conduct in using his position as provost to secure the parliamentary representation of the university for his eldest son brought him into conflict with Duigenan, who attacked him in *Lacrymae academicae*, and involved him in a duel with a Mr Doyle; while a similar attempt on behalf of his second son in 1790 led to his being accused before a select committee of the House of Commons of impropriety as returning officer. But although without scholarship Hely-Hutchinson was an efficient provost, during whose rule material benefits were conferred on Trinity College. He continued to occupy a prominent place in parliament, where he advocated free trade, the relief of the Catholics from penal legislation, and the reform of parliament. He was one of the very earliest politicians to recognize the soundness of Adam Smith's views on trade; and he quoted from the *Wealth of Nations*, adopting some of its principles, in his *Commercial Restraints of Ireland*, published in 1779, which Lecky pronounces "one of the best specimens of political literature produced in Ireland in the latter half of the 18th century." In the same year, the economic condition of Ireland being the cause of great anxiety, the government solicited from several leading politicians their opinion on the state of the country with suggestions for a remedy. Hely-Hutchinson's response was a remarkably able state paper (MS. in the Record Office), which also showed clear traces of the influence of Adam Smith. The *Commercial Restraints*, condemned by the authorities as seditious, went far to restore Hely-Hutchinson's popularity which had been damaged by his greed of office. Not less enlightened were his views on the Catholic question. In a speech in parliament on Catholic education in 1782 the provost declared that Catholic students were in fact to be found at Trinity College, but that he desired their presence there to be legalized on the largest scale. "My opinion," he said, "is strongly against sending Roman Catholics abroad for education, nor would I establish Popish colleges at home. The advantage of being admitted into the university of Dublin will be very great to Catholics; they need not be obliged to attend the divinity professor, they may have one of their own; and I would have a part of the public money applied to their use, to the support of a number of poor lads as sizars, and to provide premiums for persons of merit, for I would have them go into examinations and make no distinction between them and the Protestants but such as merit might claim." And after sketching a scheme for increasing the number of diocesan schools where Roman Catholics might receive free education, he went on to

urge that "it is certainly a matter of importance that the education of their priests should be as perfect as possible, and that if they have any prejudices they should be prejudiced in favour of their own country. The Roman Catholics should receive the best education in the established university at the public expense; but by no means should Popish colleges be allowed, for by them we should again have the press groaning with themes of controversy, and subjects of religious disputation that have long slept in oblivion would again awake, and awoken with them all the worst passions of the human mind."¹

In 1777 Hely-Hutchinson became secretary of state. When Grattan in 1782 moved an address to the king containing a declaration of Irish legislative independence, Hely-Hutchinson supported the attorney-general's motion postponing the question; but on the 16th of April, after the Easter recess, he read a message from the lord lieutenant, the duke of Portland, giving the king's permission for the House to take the matter into consideration, and he expressed his personal sympathy with the popular cause which Grattan on the same day brought to a triumphant issue (see GRATIAN, HENRY). Hely-Hutchinson supported the opposition on the regency question in 1788, and one of his last votes in the House was in favour of parliamentary reform. In 1790 he exchanged the constituency of Cork for that of Taghmon in County Wexford, for which borough he remained member till his death, at Buxton on the 4th of September 1794.

In 1785 his wife had been created Baroness Donoughmore and on her death in 1788, his eldest son Richard (1756-1845) succeeded to the title. Lord Donoughmore was an ardent advocate of Catholic emancipation. In 1797 he was created Viscount Donoughmore,² and in 1800 (having voted for the Union, hoping to secure Catholic emancipation from the united parliament) he was further created earl of Donoughmore, of Knockloty, being succeeded first by his brother John Hely-Hutchinson (1757-1832) and then by his nephew John, 3rd earl (1787-1851), from whom the title descended.

¹ See W. E. H. Lecky, *Hist. of Ireland in the Eighteenth Century* (5 vols., London, 1892); J. A. Froude, *The English in Ireland in the Eighteenth Century* (3 vols., London, 1872-1874); H. Grattan, *Memoirs of the Life and Times of Henry Grattan* (8 vols., London, 1839-1846); *Baratariana*, by various writers (Dublin, 1773).

(R. J. M.)

HELYOT, PIERRE (1660-1716), Franciscan friar and historian, was born at Paris in January 1660, of supposed English ancestry. After spending his youth in study, he entered in his twenty-fourth year the convent of the third order of St Francis, founded at Picpus, near Paris, by his uncle Jérôme Helyot, canon of St Sepulchre. There he took the name of Père Hippolyte. Two journeys to Rome on monastic business afforded him the opportunity of travelling over most of Italy; and after his final return he saw much of France, while acting as secretary to various provincials of his order there. Both in Italy and France he was engaged in collecting materials for his great work, which occupied him about twenty-five years, *L'Histoire des ordres monastiques, religieux, et militaires, et des congrégations séculières, de l'un et de l'autre sexe, qui ont été établies jusqu'à présent*, published in 8 volumes in 1714-1721. Helyot died on the 5th of January 1716, before the fifth volume appeared, but his friend Maximilien Bullot completed the edition. Helyot's only other noteworthy work is *Le Chrétien mourant* (1695).

The *Histoire* is a work of first importance, being the great repository of information for the general history of the religious orders up to the end of the 17th century. It is profusely illustrated by large plates

¹ *Irish Parl. Debates*, i. 309, 310.

² It is generally supposed that the title conferred by this patent was that of Viscount Surléale, and such is the courtesy title by which the heir apparent of the earls of Donoughmore is usually styled. This, however, appears to be an error. In all the three creations (barony 1783, viscounty 1797, earldom 1800) the title is "Donoughmore of Knockloty." In 1821 the 1st earl was further created Viscount Hutchinson of Knockloty in the peerage of the United Kingdom. The courtesy title of the earl's eldest son should, therefore, apparently be either "Viscount Hutchinson" or "Viscount Knockloty." See G. E. C. *Complete Peerage* (London, 1890).

exhibiting the dress of the various orders, and in the edition of 1792 the plates are coloured. It was translated into Italian (1737) and into German (1753). The material has been arranged in dictionary form in Migne's *Encyclopédie théologique*, under the title "Dictionnaire des ordres religieux" (4 vols., 1858).

HEMANS, FELICIA DOROTHEA (1793-1835), English poet, was born in Duke Street, Liverpool, on the 25th of September 1793. Her father, George Browne, of Irish extraction, was a merchant in Liverpool, and her mother, whose maiden name was Wagner, was the daughter of the Austrian and Tuscan consul at Liverpool. Felicia, the fifth of seven children, was scarcely seven years old when her father failed in business, and retired with his family to Gwrych, near Abergele, Denbighshire; and there the young poet and her brothers and sisters grew up in a romantic old house by the sea-shore, and in the very midst of the mountains and myths of Wales. Felicia's education was desultory. Books of chronicle and romance, and every kind of poetry, she read with avidity; and she also studied Italian, Spanish, Portuguese and German. She played both harp and piano, and cared especially for the simple national melodies of Wales and Spain. In 1808, when she was only fourteen, a quarto volume of her *Juvenile Poems*, was published by subscription, and was harshly criticized in the *Monthly Review*. Two of her brothers were fighting in Spain under Sir John Moore; and Felicia, fired with military enthusiasm, wrote *England and Spain, or Valour and Patriotism*, a poem afterwards translated into Spanish. Her second volume, *The Domestic Affections and other Poems*, appeared in 1812, on the eve of her marriage to Captain Alfred Hemans. She lived for some time at Daventry; where her husband was adjutant of the Northamptonshire militia. About this time her father went to Quebec on business and died there; and, after the birth of her first son, she and her husband went to live with her mother at Bronwylla, a house near St Asaph. Here during the next six years four more children—all boys—were born; but in spite of domestic cares and failing health she still read and wrote indefatigably. Her poem entitled *The Restoration of Works of Art to Italy* was published in 1816, her *Modern Greece* in 1817, and in 1818 *Translations from Camoens and other Poets*.

In 1818 Captain Hemans went to Rome, leaving his wife, shortly before the birth of their fifth child, with her mother at Bronwylla. There seems to have been a tacit agreement, perhaps on account of their limited means, that they should separate. Letters were interchanged, and Captain Hemans was often consulted about his children; but the husband and wife never met again. Many friends—among them the bishop of St Asaph and Bishop Heber—gathered round Mrs Hemans and her children. In 1810 she published *Tales and Historic Scenarios Verse*, and gained a prize of £50 offered for the best poem on *The Meeting of Wallace and Bruce on the Banks of the Carron*. In 1820 appeared *The Sceptic and Stanzas to the Memory of the late King*. In June 1821 she won the prize awarded by the Royal Society of Literature for the best poem on the subject of *Dartmoor*, and began her play, *The Vespers of Palermo*. She now applied herself to a course of German reading. Körner was her favourite German poet, and her lines on the grave of Körner were one of the first English tributes to the genius of the young soldier-poet. In the summer of 1823 a volume of her poems was published by Murray, containing "The Siege of Valencia," "The Last Constantine" and "Belshazzar's Feast." *The Vespers of Palermo* was acted at Covent Garden, December 12, 1823, and Mes Hemans received £1000 for the copyright; but, though the leading parts were taken by Young and Charles Kemble, the play was a failure, and was withdrawn after the first performance. It was acted again in Edinburgh in the following April with greater success, when an epilogue, written for it by Sir Walter Scott at Joanna Baillie's request, was spoken by Harriet Siddons. This was the beginning of a cordial friendship between Mrs Hemans and Scott. In the same year she wrote *De Chastillon, or the Crusaders*; but the manuscript was lost, and the poem was published after her death from a rough copy. In 1824 she began "The Forest Sanctuary,"

which appeared a year later with the "Leys of Many Lands" and miscellaneous pieces collected from the *New Monthly Magazine* and other periodicals.

In the spring of 1825 Mrs Hemans removed from Bronwyf, which had been purchased by her brother, to Rhyllyn, a house on an opposite height across the river Clwyd. The contrast between the two houses suggested her *Dramatic Scenes between Bronwyf and Rhyllyn*. The house itself was bare and unpicturesque, but the beauty of its surroundings has been celebrated in "The Hour of Romance," "To the River Clwyd in North Wales," "Our Lady's Well" and "To a Distant Scene." This time seems to have been the most tranquil in Mrs Hemans's life. But the death of her mother in January 1827 was a second great breaking-point in her life. Her heart was affected, and she was from this time an acknowledged invalid. In the summer of 1828 the *Records of Woman* was published by Blackwood, and in the same year the home in Wales was finally broken up by the marriage of Mrs Hemans's sister and the departure of her two elder boys to their father in Rome. Mrs Hemans removed to Wavertree, near Liverpool. But, although she had a few intimate friends there—among them her two subsequent biographers, Henry F. Chorley and Mrs Lawrence of Wavertree Hall—she was disappointed in her new home. She thought the people of Liverpool stupid and provincial; and they, on the other hand, found her uncommunicative and eccentric. In the following summer she travelled by sea to Scotland with two of her boys, to visit the Hamiltons of Chiefswood.

Here she enjoyed "constant, almost daily, intercourse" with Sir Walter Scott, with whom she and her boys afterwards stayed some time at Abbotsford. "There are some whom we meet, and should like ever after to claim as kith and kin; and you are one of those," was Scott's compliment to her at parting. One of the results of her Edinburgh visit was an article, full of praise, judiciously tempered with criticism, by Jeffrey himself for the *Edinburgh Review*. Mrs Hemans returned to Wavertree to write her *Songs of the Affections*, which were published early in 1830. In the following June, however, she again left home, this time to visit Wordsworth and the Lake country; and in August she paid a second visit to Scotland. In 1831 she removed to Dublin. Her poetry of this date is chiefly religious. Early in 1834 her *Hymns for Childhood*, which had appeared some years before in America, were published in Dublin. At the same time appeared her collection of *National Lyrics*, and shortly afterwards *Scenes and Hymns of Life*. She was planning also a series of German studies, one of which, on Goethe's *Tasso*, was completed and published in the *New Monthly Magazine* for January 1834. In intervals of acute suffering she wrote the lyric *Despondency and Aspiration*, and dictated a series of sonnets called *Thoughts during Sickness*, the last of which, "Recovery," was written when she fancied she was getting well. After three months spent at Redesdale, Archbishop Whately's country seat, she was again brought into Dublin, where she lingered till spring. Her last poem, the *Sabbath Sonnet*, was dedicated to her brother on Sunday April 26th, and she died in Dublin on the 16th of May 1835 at the age of forty-one.

Mrs Hemans's poetry is the production of a fine imaginative and enthusiastic temperament, but not of a commanding intellect or very complex or subtle nature. It is the outcome of a beautiful but singularly circumscribed life, a life spent in romantic seclusion, without much worldly experience, and warped and saddened by domestic unhappiness and physical suffering. An undue preponderance of the emotional is its prevailing characteristic. Scott complained that it was "too poetical," that it contained "too many flowers" and "too little fruit." Many of her short poems, such as "The Treasures of the Deep," "The Better Land," "The Homes of England," "Casabianca," "The Palm Tree," "The Graves of a Household," "The Wreck," "The Dying Improvisatore," and "The Lost Pleiad" have become standard English lyrics. It is on the strength of these that her reputation must rest.

Mrs Hemans's *Poetical Works* were collected in 1832; her *Memorials* &c., by H. F. Chorley (1836).

HEMEL HEMPSTEAD, a market-town and municipal borough in the Watford parliamentary division of Herefordshire, England, 25 m. N.W. from London, with a station on a branch of the Midland railway from Harpenden, and near Boxmoor station on the London and North Western main line. Pop. (1891) 9678; (1901) 11,264. It is pleasantly situated in the steep-sided valley of the river Gade, immediately above its junction with the Bulbourne, near the Grand Junction canal. The church of St. Mary is a very fine Norman building with Decorated additions. Industries include the manufacture of paper, iron founding, brewing and tanning. Boxmoor, within the parish, is a considerable township of modern growth. Hemel Hempstead is governed by a mayor, 6 aldermen and 18 councillors. Area, 7184 acres.

Settlements in the neighbourhood of Hemel Hempstead (*Hamalemsstede, Hemel Hempsted*) date from pre-Roman times, and a Roman villa has been discovered at Boxmoor. The manor, royal demesne in 1086, was granted by Edmund Plantagenet in 1285 to the house of Ashridge, and the town developed under monastic protection. In 1539 a charter incorporated the bailiff and inhabitants. A mayor, aldermen and councillors received governing power by a charter of 1898. The town has never had parliamentary representation. A market on Thursday and a fair on the feast of Corpus Christi were conferred in 1539. A statute fair, for long a hiring fair, originated in 1803.

HEMEROBAPTISTS, an ancient Jewish sect, so named from their observing a practice of daily ablution as an essential part of religion. Epiphanius (*Panarion*, l. 17), who mentions their doctrine as the fourth heresy among the Jews, classes the Hemerobaptists doctrinally with the Pharisees (q.v.) from whom they differed only in, like the Sadducees, denying the resurrection of the dead. The name has been sometimes given to the Mandaeans on account of their frequent ablutions; and in the *Clementine Homilies* (il. 23) St John the Baptist is spoken of as a Hemerobaptist. Mention of the sect is made by Hegesippus (see Euseb. *Hist. Eccl.* iv. 22) and by Justin Martyr in the *Dialogue with Trypho*, § 80. They were probably a division of the Essenes.

HEMICHORDA, or *HEMACHORDATA*, a zoological term introduced by W. Bateson in 1884, without special definition, as equivalent to Enteropneusta, which then included the single genus *Balanoglossus*, and now generally employed to cover a group of marine worm-like animals believed by many zoologists to be related to the lower vertebrates and so to represent the invertebrate stock from which Vertebrates have been derived. Vertebrates, or as they are sometimes termed Chordates, are distinguished from other animals by several important features. The chief of these is the presence of an elastic rod, the notochord, which forms the longitudinal axis of the body, and which persists throughout life in some of the lowest forms, but which appears only in the embryo of the higher forms, being replaced by the jointed backbone or vertebral column. A second feature is the development of outgrowths of the pharynx which unite with the skin of the neck and form a series of perforations leading to the exterior. These structures are the gill-slits, which in fishes are lined with vascular tufts, but which in terrestrial breathing animals appear only in the embryo. The third feature of importance is the position of structure of the central nervous system, which in all the Chordates lies dorsally to the alimentary canal and is formed by the sinking in of a longitudinal media dorsal groove. Of these structures the Vertebrata or Craniata possess all three in a typical form; the Cephalochordata (see *Αμφιχορδ*) also possess them, but the notochord extends throughout the whole length of the body to the extreme tip of the snout; the Urochordata (see *Τυρκοτάτα*) possess them in a larval condition, but the notochord is present only in the tail, whilst in the adult the notochord disappears and the nervous system becomes profoundly modified; in the Hemichordata, the respiratory organs very closely resemble gill-slits, and structures comparable with the notochord and the tubular dorsal nervous system are present.

The Hemichordata include three orders, the Phoronidea (q.v.), the Pterobranchia (q.v.) and the Enteropneusta (see *BALANO-*

ozosus), but the relationship to the Chordata expressed in the designation Hemichordata cannot be regarded as more than an attractive theory with certain arguments in its favour. (P. C. M.)

HEMICYCLE (Gr. ἡμι-, half, and κύκλος, circle), a semi-circular recess of considerable size which formed one of the most conspicuous features in the Roman Thermae, where it was always covered with a hemispherical vault. A small example exists in Pompeii, in the street of tombs, with a seat round inside, where those who came to pay their respects to the departed could rest. An immense hemicycle was designed by Bramante for the Vatican, where it constitutes a fine architectural effect at the end of the great court.

HEMIMERUS, an Orthopterous or Dermapterous insect, the sole representative of the family *Hemimeridae*, which has affinities with both the *Forficulidae* (earwigs) and the *Blattidae* (cockroaches). Only two species have been discovered, both from West Africa. The better known of these (*H. kanseni*) lives upon a large rat-like rodent (*Cricetomys gambianus*) feeding perhaps upon its external parasites, perhaps upon scurf and other dermal products. Like many epizoic or parasitic insects, *Hemimerus* is wingless, eyeless and has relatively short and strong legs. Correlated also with its mode of life is the curious fact that it is viviparous, the young being born in an advanced stage of growth.

HEMIMORPHITE, a mineral consisting of hydrous zinc silicate, $H_2Zn_3SiO_8$, of importance as an ore of the metal, of which it contains 54.4%. It is interesting crystallographically by reason of the hemimorphic development of its orthorhombic crystals; these are prismatic in habit and are differently terminated at the two ends. In the figure, the faces at the upper end of the crystal are the basal plane *k* and the domes *o*, *p*, *l*, *m*, whilst at the lower end there are only the four faces of the pyramid *P*. Connected with this polarity of the crystals is their pyroelectric character—when a crystal is subjected to changes of temperature it becomes positively electrified at one end and negatively at the opposite end. There are perfect cleavages parallel to the prism faces (*d* in the figure). Crystals are usually colourless, sometimes yellowish or greenish, and transparent; they have vitreous lustre. The hardness is 3, and the specific gravity 3.45. The mineral also occurs as stalactitic or botryoidal masses with a fibrous structure, or in a massive, cellular or granular condition intermixed with calamine and clay. It is decomposed by hydrochloric acid with gelatinization; this property affords a ready means of distinguishing hemimorphite from calamine (zinc carbonate), these two minerals being, when not crystallized, very like each other in appearance. The water contained in hemimorphite is expelled only at a red heat, and the mineral must therefore be considered as a basic metasilicate, $(ZnOH)_2SiO_3$.

The name hemimorphite was given by G. A. Kenngott in 1853 because of the typical hemimorphic development of the crystals. The mineral had long been confused with *calamine* (*q.v.*) and even now this name is often applied to it. On account of its pyroelectric properties, it was called *electric calamine* by J. Smithson in 1803.

Hemimorphite occurs with other ores of zinc (calamine and blende), forming veins and beds in sedimentary limestones. British localities are Matlock, Alston, Mendip Hills and Leadhills; at Roughton Gill, Caldbeck Fells, Cumberland, it occurs as mammillated incrustations of a sky-blue colour. Well-crystallized specimens have been found in the zinc mines at Altenberg near Aachen in Rhenish Prussia, Nerchinsk mining district in Siberia, and Elkhorn in Montana. (L. J. S.)

HEMINGBURGH, WALTER OF, also commonly, but erroneously, called **WALTER HEMINGFORD**, a Latin chronicler of the 14th century, was a canon regular of the Austin priory of Gisburn in Yorkshire. Hence he is sometimes known as *Walter of Gisburn* (*Walterus Gisburnensis*). Wale seems to have been the first to give him the name by which he became more commonly known.

His chronicle embraces the period of English history from the Conquest (1066) to the nineteenth year of Edward III., with the exception of the years 1316-1326. It ends with the title of a chapter in which it was supposed to describe the battle of Crecy (1346); but the chronicler seems to have died before the required information reached him. There is, however, some controversy as to whether the later portions which are lacking in some of the MSS. are by him. In compiling the first part, Hemingburgh apparently used the histories of Eadmer, Hoveden, Henry of Huntingdon, and William of Newburgh; but the reigns of the three Edwards are original, composed from personal observation and information. There are several manuscripts of the history extant—the best perhaps being that presented to the College of Arms by the earl of Arundel. The work is correct and judicious, and written in a pleasing style. One of its special features is the preservation in its pages of copies of the great charters, and Hemingburgh's versions have more than once supplied deficiencies and cleared up obscurities in copies from other sources.

The first three books were published by Thomas Gale in 1687, in his *Historiae Anglicanae scriptores quinque*, and the remainder by Thomas Hearne in 1731. The first portion was again published in 1848 by the English Historical Society, under the title *Chronicon Walteri de Hemingburgh, vulgo Hemingford mensepsii, de gestis regum Angliae*, edited by H. C. Hamilton.

HEMIPTERA (Gr. ἡμι-, half and πτερόν, a wing), the name applied in zoological classification to that order of the class *Hexapoda* (*q.v.*) which includes bugs, cicads, aphids and scale-insects. The name was first used by Linnaeus (1735), who derived it from the half-coarctaceous and half-membranous condition of the forewing in many members of the order. But the wings vary considerably in different families, and the most distinctive feature is the structure of the jaws, which form a beak-like organ with stylets adapted for piercing and sucking. Hence the name *Rhynchota* (or *Rhynchota*), proposed by J. C. Fabricius (1775), is used by many writers in preference to Hemiptera.

Structure.—The head varies greatly in shape, and the feelers have usually but few segments—often only four or five. The arrangement of the jaws is remarkably constant throughout the order, if we exclude from it the lice (*Anoplura*). Taking as our type the head of a cicad, we find a jointed rostrum or beak (figs. 1 and 2, IV, *b*, *c*) with a deep groove on its anterior face; this organ is formed by the second pair of maxillae and corresponds therefore to the labium or "lower lip" of biting insects. Within the groove of the rostrum two pairs of slender piercers—often barbed at the tip—work to and fro. One of these pairs (fig. 2, II, *a*, *b*, *c*) represents the mandibles, the other (fig. 2, III, *a*, *b*, *c*) the first maxillae. The piercing portions of the latter—representing their inner lobes or laciniae—lie median to the mandibular piercers in the natural position of the organs. These homologies III., IV., were determined by J. C. Savigny in 1816, and though disputed by various subsequent writers, they have been lately confirmed by the embryological researches of R. Heymons (1899). Vestigial palps have been described in various species of Hemiptera, but the true nature of these structures is doubtful. In front of the rostrum and the piercers lies the pointed flexible labrum and within its base a small hypopharynx (fig. 2, IV, *d*) consisting of paired conical processes which lie dorsal to the "syringe" of the salivary glands. This latter organ injects a secretion into the plant or

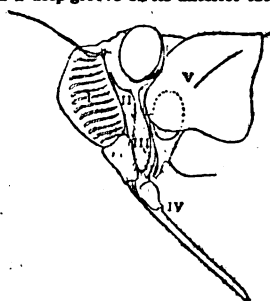
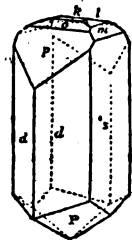

After Marshall, Bull. 14 (N.S.) Div. Ent. U.S. Dept. Agr.

FIG. 1.—Head and Prothorax of Cicad from side.

- I., Frons.
- II., Base of mandible.
- III., Base of first maxillae.
- IV., Second maxillae forming rostrum.
- V., Pronotum.

were determined by J. C. Savigny in 1816, and though disputed by various subsequent writers, they have been lately confirmed by the embryological researches of R. Heymons (1899). Vestigial palps have been described in various species of Hemiptera, but the true nature of these structures is doubtful. In front of the rostrum and the piercers lies the pointed flexible labrum and within its base a small hypopharynx (fig. 2, IV, *d*) consisting of paired conical processes which lie dorsal to the "syringe" of the salivary glands. This latter organ injects a secretion into the plant or

animal tissue from which the insect is sucking. The point of the rostrum is pressed against the surface to be pierced; then the stylets come into play and the fluid food is believed to pass into the mouth by capillary attraction.

The prothorax (figs. 1 and 2, V.) in Hemiptera is large and free, and the mesothoracic scutellum is usually extensive. The number of tarsal segments is reduced; often three, two or only one may be present instead of the typical insectan number five. The wings will be described in connexion with the various

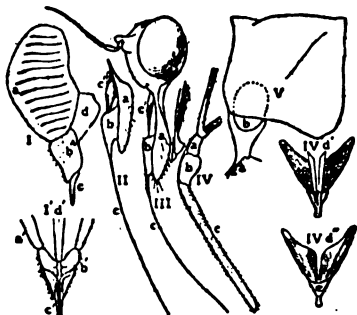

After Marshall, Bull. 14 (N. S.) Div. Ent. U.S. Dept. Agr.

FIG. 2.—Head and Prothorax of Cicada, parts separated.

- I., a, frons; b, clypeus; c, labrum; d, epipharynx.
 I', Same from behind.
 II., Mandible.
 III., 1st maxilla; a, base; b, sheath; c, stylet; c', muscle.
 IV., 2nd maxillae, a, sub-mentum; b, mentum; c, ligula, forming beak; d, hypopharynx (shown also from front d', and behind d'').
 V., Prothorax, b, haunch; a, trochanter.

sub-orders, but an interesting peculiarity of the Hemiptera is the occasional presence of winged and wingless races of the same species. Eleven abdominal segments can be recognized, at least in the early stages; as the adult condition is reached, the hinder segments become reduced or modified in connexion with the external reproductive organs, and show, in some male Hemiptera, a marked asymmetry. The typical insectan ovipositor with its three pairs of processes, one pair belonging to the eighth and two pairs to the ninth abdominal segment, can be distinguished in the female.

In the nervous system the concentration of the trunk ganglia

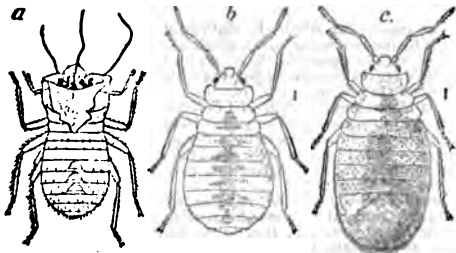

7822—

After Marshall, Bull. 4 (N.S.) Div. Ent. U.S. Dept. Agr.

FIG. 3.—a, Cast-off nymphal skin of Bed-bug (*Cimex lectularius*); b, Second instar after emergence from a; c, The same after a meal.

into a single nerve-centre situated in the thorax is remarkable. The digestive system has a slender gullet, a large crop and no gizzard; in some Hemiptera the hinder region of the mid-gut forms a twisted loop with the gullet. Usually there are four excretory (Malpighian) tubes; but there are only two in the *Coccidae* and none in the *Aphidae*. "Stink glands," which secrete a nauseous fluid with a defensive function, are present

in many Hemiptera. In the adult these is a pair of such glands opening ventrally on the hindmost thoracic segment, or at the base of the abdomen; but in the young insect the glands are situated dorsally and open to the exterior on a variable number of the abdominal terga.

Development.—In most Hemiptera the young insect (fig. 3) resembles its parents except for the absence of wings, and is active through all stages of its growth. In all Hemiptera the wing-rudiments develop externally on the symphal cuticle, but in some families—the cicadas for example—the young insect (fig. 10) is a larva differing markedly in form from its parent, and adapted for a different mode of life, while the nymph before the final moult is sluggish and inactive. In the male *Coccidae* (Scale-insects) the nymph (fig. 4) remains passive and takes no food. The order of the Hemiptera affords, therefore, some interesting transition stages towards the complete metamorphosis of the higher insects.

Distribution and Habits.—Hemiptera are widely distributed, and are plentiful in most quarters of the globe, though they probably have not penetrated as far into remote and inhospitable regions as have the Coleoptera, Diptera and Aptera. They feed entirely by suction, and the majority of the species pierce plant tissues and suck sap. The leaves of plants are for the most part the objects of attack, but many aphids and scale-insects pierce stems, and some go underground and feed on roots. The enormous rate at which aphids multiply under favourable conditions makes them of the greatest economic importance, since the growth of immense numbers of the same kind of plant in close proximity—as in ordinary farm-crops—is especially advantageous to the insects that feed on them. Several families of bugs are predaceous in habit, attacking other insects—often members of their own order—and sucking their juices. Others are scavengers feeding on decaying organic matter, since the growth of immense numbers of the same kind of plant in close proximity—as in ordinary farm-crops—is especially advantageous to the insects that feed on them. Several families of bugs are predaceous in habit, attacking other insects—often members of their own order—and sucking their juices. Others are scavengers feeding on decaying organic matter, since the growth of immense numbers of the same kind of plant in close proximity—as in ordinary farm-crops—is especially advantageous to the insects that feed on them.



After Riley and Howard
 Insect Life, vol. I. (U.S.
 Dept. Agr.)

and sucking their juices. Others are scavengers feeding on decaying organic matter, since the growth of immense numbers of the same kind of plant in close proximity—as in ordinary farm-crops—is especially advantageous to the insects that feed on them. Several families of bugs are predaceous in habit, attacking other insects—often members of their own order—and sucking their juices. Others are scavengers feeding on decaying organic matter, since the growth of immense numbers of the same kind of plant in close proximity—as in ordinary farm-crops—is especially advantageous to the insects that feed on them. Several families of bugs are predaceous in habit, attacking other insects—often members of their own order—and sucking their juices. Others are scavengers feeding on decaying organic matter, since the growth of immense numbers of the same kind of plant in close proximity—as in ordinary farm-crops—is especially advantageous to the insects that feed on them.

FIG. 4.—Passive Nymph or "Pupa" of male scale-insect (*Icerya*).

The Hemiptera are especially interesting as an order from the variety of aquatic insects included therein. Some of these—the *Hydrometridae* or pond-skaters, for example—move over the surface-film, on which they are supported by their elongated, slender legs, the body of the insect being raised clear of the water. They are covered with short hairs which form a velvet-like pile, so dense that water cannot penetrate. Consequently when the insect dives, an air-bubble forms around it, a supply of oxygen is thus secured for breathing and the water is kept away from the spiracles. In many of these insects, while most individuals of the species are wingless, winged specimens are now and then met with. The occasional development of wings is probably of service to the species in enabling the insects to reach new fresh-water breeding-grounds. This family of Hemiptera (the *Hydrometridae*) and the *Saldidae* contain several insects that are marine, haunting the tidal margin. One genus of *Hydrometridae* (*Halobates*) is even oceanic in its habit, the species being met with skimming over the surface of the sea hundreds of miles from land. Probably they dive when the surface becomes ruffled. In these marine genera the abdomen often undergoes excessive reduction (fig. 5).

Other families of Hemiptera—such as the "Boatmen" (*Nolonettidae*) and the "Water-scorpions" (fig. 6) and their allies (*Nepidae*) dive and swim through the water. They obtain their supply of air from the surface. The *Nepidae* breathe by means of a pair of long, grooved tail processes (really out-growths

of the abdominal pleura) which when pressed together form a tube whose point can pierce the surface film and convey air to the hindmost spiracles which are alone functional in the adult. The *Notonectidae* breathe mostly through the thoracic spiracles; the air is conveyed to these from the tail-end, which is brought to the surface, along a kind of tunnel formed by overlapping hairs.

Sound-producing Organs.—The Hemiptera are remarkable for the variety of their stridulating organs. In many genera of

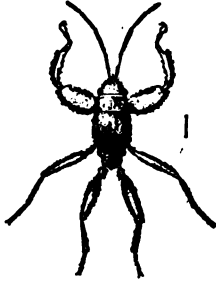

FIG. 5.—A reef-haunting hemipteron (*Hermatobates haddonii*) with excessively reduced abdomen. Magnified.

After Carpenter, Proc. R. Dublin Soc., vol. viii.



FIG. 6.—Water-scorpion (*Nepa cinerea*) with raptorial fore-legs, heteropterous wings, and long siphon for conveying air to spiracles. Somewhat magnified. *sc*, scutellum; *co*, *cl*, *m*, corium, clavus and membrane of forewing.

the *Pentatomidae*, bristle-bearing tubercles on the legs are scraped across a set of fine striations on the abdominal sterna. In *Halobates* a comb-like series of sharp spines on the fore-shin can be drawn across a set of blunt processes on the shin of the opposite leg. Males of the little water-bugs of the genus *Corixa* make a shrill chirping note by drawing a row of teeth on the flattened fore-foot across a group of spines on the haunch of the opposite leg. But the loudest and most remarkable vocal organs of all insects are those of the male cicads, which "sing"

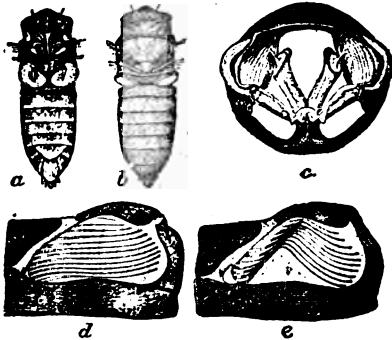

From Marlatt, Bull. 14 (N.S.) Div. Ent. U.S. Dept. Agr. FIG. 7.

a, Body of male Cicada from below, showing cover-plates of musical organs; b, From above showing drums, natural size; c, Section showing muscles which vibrate drum (magnified); d, A drum at rest; e, Thrown into vibration, more highly magnified.

by the rapid vibration of a pair of "drums" or membranes within the metathorax. These drums are worked by special muscles, and the cavities in which they lie are protected by conspicuous plates visible beneath the base of the abdomen (see fig. 7).

Fossil History.—The Heteroptera can be traced back farther than any other winged insects if the fossil *Protocimex silvarica* Moberg, from the Ordovician slates of Sweden is rightly regarded as the wing of a bug. But according to the recent researches of A. Handlirsch it is not insectan at all. Both Heteropterous and Homopterous genera have been described from the Carboniferous, but the true nature of some of these is doubtful. *Eugereon* is a remarkable Permian fossil, with jaws that are typically hemipterous except that the second maxillae are not fused and with cockroach-like wings. In the Jurassic period many of the existing families, such as the *Cicadidae*, *Fulgoridae*, *Aphidae*, *Nepidae*, *Reduviidae*, *Hydrometridae*, *Lygaeidae* and *Coreidae*, had already become differentiated.

Classification.—The number of described species of Hemiptera must now be nearly 20,000. The order is divided into two sub-orders, the Heteroptera and the Homoptera. The Anoplura or lice should not be included among the Hemiptera, but it has been thought convenient to refer briefly to them at the close of this article.

HETEROPTERA

In this sub-order are included the various families of bugs and their aquatic relations. The front of the head is not in contact with the haunches of the fore-legs. There is usually a marked difference between the wings of the two pairs. The fore-wing is generally divided into a firm coriaceous basal region, occupying most of the area, and a membranous terminal portion, while the hind-wing is delicate and entirely membranous (see fig. 6). In the firm portion of the fore-wing two

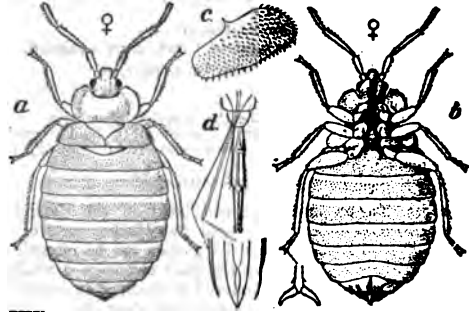

FIG. 8.—Bed-bug (*Cimex lectularius*, Linn.).

a, Female from above; b, From beneath; c, Vestigial wing; d, Jaws, very highly magnified (tips of mandibles and 1st maxillae still more highly magnified).

distinct regions can usually be distinguished: most of the area is formed by the *corium* (fig. 6, *co*), which is separated by a longitudinal suture from the *clavus* (fig. 6, *cl*) on its hinder edge, and in some families there is also a *cuneus* (fig. 9 *cu*) external to and an *embolus* in front of the *corium*.

Most Heteroptera are flattened in form, and the wings lie flat, or nearly so, when closed. The young Heteropteron is hatched from the egg in a form not markedly different from that of its parent; it is active and takes food through all the stages of its growth. It is usual to divide the Heteroptera into two tribes—the *Gymnocerata* and the *Cryptocerata*.

Gymnocerata.—This tribe includes some eighteen families of terrestrial, arboreal and marsh-haunting bugs, as well as some aquatic Heteroptera that live on the surface-film of water. The feelers are elongate and conspicuous. The *Pentatomidae* (shield-bugs), some of which are metallic or otherwise brightly coloured, are easily recognized by the great development of the scutellum, which reaches at least half-way back towards the tip of the abdomen, and in some genera covers the whole of the hind body, and also the wings when these are closed. The *Coreidae* have a smaller scutellum, and the feelers are inserted high on the head, while in the *Lygaeidae* they are inserted lower down. These three families have the foot with three segments. In the curious little *Tingidae*, whose integuments exhibit a pattern of network-like ridges, the feet are two-segmented and the scutellum is hidden by the pronotum. The *Aradidae* have two segmented feet, and a large visible scutellum. The *Hydrometridae* are a large family including the pond-skaters and other dwellers on the surface-film of fresh water, as well as the remarkable oceanic genus *Halobates* already referred to. The *Reduviidae* are

a family of predaceous bugs that attack other insects and suck their juices; the beak is short, and carried under the head in a hook-like curve, not—as in the preceding families—lying close against the breast. The *Cimicidae* have the feet three-segmented and the forewings greatly reduced; most of the species are parasites on birds and bats, but one—*Cimex lectularius* (figs. 3, 8)—is the well-known "bed-bug" which abounds in unclean dwellings and sucks human blood (see BUG). The *Anthracoridae* are nearly related to the *Cimicidae*, but the wings are usually well developed and the forewing possesses cuneus and embolium as well as corium and clavus. The *Capsidae* are a large family of rather soft-skinned bugs mostly



After M. V. Slingerland, Cornell Univ. Ent. Bull. 25.

FIG. 9.—Capsid Leaf-bug (*Poecilognathus lineatus*) N. America. Magnified—, *cu* cuneus.

elongate in form with the two basal segments of the feelers stouter than the two terminal. The forewing in this family has a cuneus (fig. 9 *cu*), but not an embolium. These insects are often found in large numbers on plants whose juices they suck. *Cryptocerata*.—In this tribe are included five or six families of aquatic Heteroptera which spend the greater part of their lives submerged, diving and swimming through the water. The feelers are very small and are often hidden in cavities beneath the head. The *Naucoridae* and *Belostomatidae* are flattened insects, with four-segmented feelers and fore-legs inserted at the front of the prosternum. Two species of the former family inhabit our islands, but the *Belostomatidae* are found only in the warmer regions of the globe; some of them, attaining a length of 4 to 5 in., are giants among insects. The *Nepidae* (fig. 6) or water-scorpions (*g.s.*)—two British species—are distinguished by their three-segmented feelers, their raptorial fore-legs (in which the shin and foot, fused together, work like a sharp knife-blade on the grooved thigh), and their elongate tail-processes formed of the abdominal pleura, and used for respiration. The *Notonectidae*, or "water-boatmen" (*g.s.*) have convex ovoid bodies admirably adapted for aquatic life. By means of the oar-like hind-legs they swim actively through the water with the ventral surface upwards; the fore-legs are inserted at the hinder edge of the prosternum. The *Corixidae* are small flattened water-bugs, with very short unjointed beak, the labrum being enclosed within the second

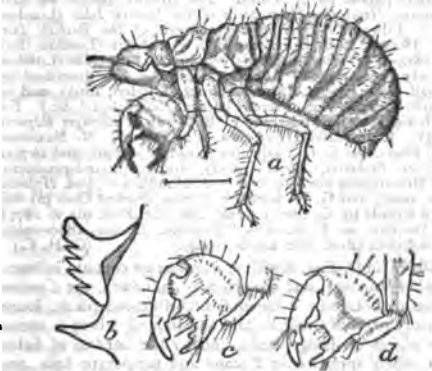

From Marshall, Bull. 14 (N. S.), Div. Ent. U. S. Dept. Agr.

FIG. 10.—*a*, Nymph (4th stage) of Cicad, magnified; *c*, *d* inner and outer faces of front leg, magnified—; *b*, teeth on thigh.

maxillae, and the foot in the fore and intermediate leg having but a single segment. The hinder abdominal segments in the male show a curious asymmetrical arrangement, the sixth segment bearing on its upper side a small stalked plate (*stigid*) of unknown function furnished with rows of teeth. On account of the reduction and modification of the jaws in the *Corixidae*, C. Börner has lately suggested that they should form a special sub-order of Hemiptera—the *Sandaliorrhyncha*.

HOMOPTERA

This sub-order includes the cicadas, lantern-flies, frog-hoppers; aphids and scale-insects. The face has such a marked backward slope (see fig. 1) as to bring the beak into close contact with the haunches of the fore-legs. The feelers have one or more thickened basal segments, while the remaining segments are slender and thread-like. The fore-wings are sometimes membranous like the hind-wings, usually they are firmer in texture, but they never show the distinct areas that characterize the wings of Heteroptera. When at rest the wings of Homoptera slope roofwise across the back of the insect. In their life-history the Homoptera are more specialized than the Heteroptera; the young insect often differs markedly from its

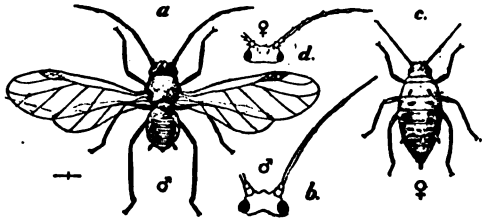

After Wood, Riley and Howard, Insect Life, vol. III.

FIG. 11.—Cabbage Aphid (*Aphis brassicae*). *a*, Male; *c*, female (wingless). Magnified. *b* and *d*, Head and feelers of male and female, more highly magnified.

parent and does not live in the same situations; while in some families there is a passive stage before the last moult.

The *Cicadidae* are for the most part large insects with ample wings; they are distinguished from other Homoptera by the front thighs being thickened and toothed beneath. The broad hegd carries, in addition to the prominent compound eyes, three simple eyes (ocelli) on the crown, while the feeler consists of a stout basal segment, followed by five slender segments. The female, by means of her serrated ovipositor, lays her eggs in slits cut in the twigs of plants. The young have simple feelers and stout fore-legs (fig. 10) adapted for digging; they live underground and feed on the roots of plants.

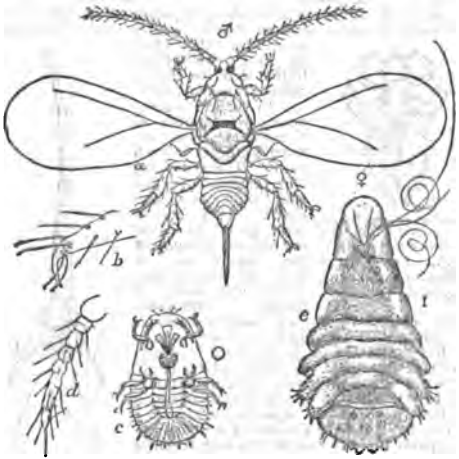

After Howard, Year Book U. S. Dep. Agr., 1864.

FIG. 12.—Apple Scale Insect (*Mytilaspis pomorum*). *a*, Male; *c*, female; *c*, larva, magnified—; *b*, foot of male; *d*, feeler of larva, more highly magnified.

In the case of a North American species it is known that this larval life lasts for seventeen years. The "song" of the male cicada is notorious and the structures by which it is produced have already been described (see also CICADA). There are about 900 known species, but the family is mostly confined to warm countries; only a single cicad is found in England, and that is restricted to the south.

The *Fulgoridae* and *Membracidae* are two allied families most of whose members are also natives of hot regions. The *Fulgoridae*

have the head with two ocelli and three-segmented feelers; frequently as in the tropical "lantern-flies" (*g.*), the head is prolonged into a conspicuous bladder, or trunk-like process. The *Membracidae* are remarkable on account of the backward prolongation of the pronotum

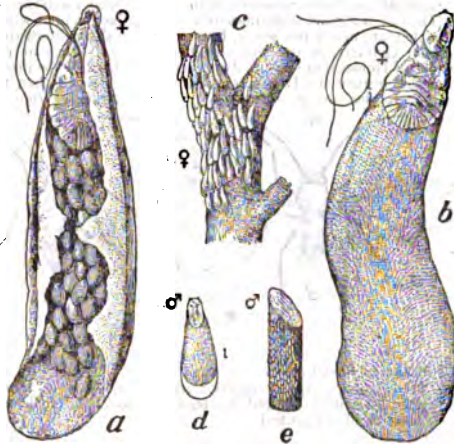

TERZI.—

After Howard, Year Book U.S. Dep. Agr., 1894.

FIG. 13.—Apple Scale Insect (*Mytilaspis pomorum*). a, Scale from beneath showing female and eggs; b, from above, magnified; c and e, female and male scales on twigs, natural size; d, male scale magnified.

into a process or hood-like structure which may extend far behind the tail-end of the abdomen. Two other allied families, the *Cercopidae* and the *Jassidae*, are more numerous represented in our islands. The young of many of these insects are green and soft-skinned,



From Osborn (after Denny), Bull. U.S. Dep. Agr., 1894.

FIG. 14.—Louse (*Pediculus vestimentis*). Magnified.

protecting themselves by the well-known frothy secretion that is called "cuckoo-spit." In all the above-mentioned families of Homoptera there are three segments in each foot. The remaining four families have feet with only two segments. They are of very great zoological interest on account of the peculiarities of their life-history—parthenogenesis being of normal occurrence among most of them. The families *Psyllidae* (or "jumpers") with eight or ten segments in the feeler and the *Aleyrodidae* (or "snow-flies") distinguished by their white mealy wings, are of comparatively slight importance. The two families to which special attention has been paid are the *Aphidae* or plant-lice ("green fly") and the *Coccidae* or scale-insects. The aphids (fig. 11) have feelers with seven or fewer distinct segments, and the fifth abdominal segment usually carries a pair of tubular processes through which a waxy secretion is discharged. The sweet "honey-dew" often serves as a food by ants, is secreted from the intestines of aphids. The peculiar life-cycle in bosca of *Pediculus*, which successive generations are produced through the summer months by virgin females—the egg developing within the body of the mother—is described at length in the articles *APHIDES* and *PHYLLOXERA*. The *Coccidae* have only a single claw to the foot; the males (fig. 12 a) have the fore-wings developed and the hind-wings greatly reduced, while in the female wings are totally absent and the body undergoes marked degradation (figs. 12, e, 13, a, b). In the *Coccidae* the forma-

tion of a protective waxy secretion—present in many genera of Homoptera—reaches its most extreme development. In some coccids—the "mealy-bugs" (*Dactylopius*, &c.) for example—the secretion forms a white thread-like or plate-like covering which the insect carries about. But in most members of the family, the secretion, united with cast cuticles and excrement, forms a firm "scale," closely attached by its edges to the surface of the plant on which the insect lives, and serving as a shield beneath which the female coccid, with her eggs (fig. 13 a) and brood, finds shelter. The male coccid passes through a passive stage (fig. 4) before attaining the perfect condition. Many scale-insects are among the most serious of pests, but various species have been utilized by man for the production of wax (lac) and red dye (cochineal). See *ECONOMIC ENTOMOLOGY, SCALE-INSECT*.

ANOPLURA

The Anoplura or lice (see LOUSE) are wingless parasitic insects (fig. 14) forming an order distinct from the Hemiptera, their sucking and piercing mouth-organs being apparently formed on quite a different plan from those of the Heteroptera and Homoptera. In front of the head is a short tube armed with strong recurved hooks which can be fixed into the skin of the host, and from the tube an elongate more slender sucking-trunk can be protruded (fig. 15). Each foot is provided with a single strong claw which, opposed to a process on the shin, serves to grasp a hair of the host, all the lice being parasites on different mammals. Although G. Enderlein has recently shown that the jaws of the Hemiptera can be recognized in a reduced condition in connexion with the louse's proboscis, the modification is so excessive that the group certainly deserves ordinal separation.

BIBLIOGRAPHY.—A recent standard work on the morphology of the Hemiptera by R. Heymons (*Nova Acta Acad. Leop. Carol.* lxxiv. 3, 1899) contains numerous references to older literature. An excellent survey of the order is given by D. Sharp (*Cambridge Nat. Hist.* vol. vi., 1898). For internal structure of Heteroptera see R. Dufour, *Mem. savans étrangers* (Paris, iv., 1833); of Homoptera, E. Wiltaczil (*Arb. Zool. Inst. Wien*, iv., 1882, *Zeits. f. wiss. Zool.* xliii., 1885). The development of Aphids has been dealt with by T. H. Huxley (*Trans. Linn. Soc.* xxii., 1858) and E. Wiltaczil (*Zeits. f. wiss. Zool.* xl., 1884). Fossil Hemiptera are described by S. H. Scudder in K. Zittel's *Palaentologie* (French translation, vol. ii. Paris, 1887, and English edition, vol. i., London, 1900), and by A. Handlirsch (*Verh. zool. bot. Gesell. Wien*, liii., 1902). Among general systematic works on Heteroptera may be mentioned J. C. Schiödte (*Ann. Mag. Nat. Hist.* (4) vi., 1870); C. Stal's *Enumeratio Hemipterorum* (*K. Svensk. Vet. Akad. Handl.* ix-xiv., 1870-1876); L. Lethierry and G. Severin's *Catalogue générale des hémiptères* (Brussels 1893, &c.); G. C. Champion's volumes in the *Biologia Centrali-Americana*; W. L. Distant's *Oriental Cicadidae* (London, 1889-1892), and many other papers; M. E. Fernald's *Catalogue of the Coccidae* (Amherst, U.S.A., 1903). European Hemiptera have been dealt with in numerous papers by A. Puton. For British species see London, E. Saunders's *Hemiptera-Heteroptera of the British Isles* (London, 1892); J. Edwards's *Hemiptera-Homoptera of the British Isles* (London, 1896); J. B. Buckton's *British Aphidae* (London, Ray Society, 1875-1882); and R. Newstead's *British Coccidae* (London, Ray Society, 1901-1903). Aquatic Hemiptera are described by L. C. Miall (*Nat. History Aquatic Insects*; London, 1895), and by G. W. Kirkaldy in numerous recent papers (*Entomologist*, &c.). For marine Hemiptera (*Halobates*) see F. B. White (*Challenger Reports*, vii., 1883); J. J. Walker (*Ent. Mo. Mag.*, 1893); N. Nasonov (Warsaw, 1893), and G. H. Carpenter (*Knowledge*, 1901, and *Report, Pearl Oyster Fisheries, Royal Society*, 1906). Sound-producing organs of Heteroptera are described by A. Handlirsch (*Ann. Hofmus. Wien*, xv, 1900), and G. W. Kirkaldy (*Journ. Quekett Club* (2) viii, 1901); of Cicads by G. Carlet (*Ann. Sci. Nat. Zool.* (6) v, 1877). For the Anoplura see E. Piaget's *Pediculines* (Leiden, 1880-1905), and G. Enderlein (*Zool. Anz.* xxviii., 1904). (G. H. C.)



From Osborn (after Schiödte), Bull. U.S. Dep. Agr., 1894.

FIG. 15.—Proboscis of a louse. Highly magnified.

HEMLOCK (in O. Eng. *hemlic* or *lymlic*; no cognate is found in any other language, and the origin is unknown), the *Conium maculatum* of botanists, a biennial umbelliferous plant, found wild in many parts of Great Britain and Ireland, where it occurs in waste places on hedge-banks, and by the borders of fields, and also widely spread over Europe and temperate Asia, and naturalized in the cultivated districts of North and South America. It is an erect branching plant, growing from 3 to 6 ft. high, and emitting a disagreeable smell, like that of mice. The stems are hollow, smooth, somewhat glaucous green, spotted with dull dark purple, as alluded to in the specific name, *maculatum*. The root-leaves have long furrowed footstalks, sheathing the stem at the base, and are large, triangular in outline, and repeatedly divided or compound, the ultimate and very numerous segments being small, ovate, and deeply incised at the edge. These leaves generally perish after the growth of the flowering stem, which takes place in the second year, while the leaves

produced on the stem became gradually smaller upwards. The branches are all terminated by compound many-rayed umbels of small white flowers, the general involucre consisting of several, the partial ones of about three short lanceolate bracts, the latter being usually turned towards the outside of the umbel. The flowers are succeeded by broadly ovate fruits, the mericarps (half-fruits) having five ribs which, when mature, are waved or crenated; and when cut across the albumen is seen to be deeply furrowed on the inner face, so as to exhibit in section a semiform outline. The fruits when triturated with a solution of caustic potash evolve a most unpleasant odour.

Hemlock is a virulent poison, but it varies much in potency according to the conditions under which it has grown, and the season or stage of growth at which it is gathered. In the first year the leaves have little power, nor in the second are their properties developed until the flowering period, at which time, or later on when the fruits are fully grown, the plant should be gathered. The wild plant growing in exposed situations is to be preferred to garden-grown samples, and is more potent in dry warm summers than in those which are dull and moist.

The poisonous property of hemlock resides chiefly in the alkaloid *coniine* or *conia* which is found in both the fruits and the leaves, though in exceedingly small proportions in the latter. *Coniine* resembles nicotine in its deleterious action, but is much less powerful. No chemical antidote for it is known. The plant also yields a second less poisonous crystallizable base called *cannabinine*, which may be converted into *coniine* by the abstraction of the elements of water. When collected for medicinal purposes, for which both leaves and fruits are used, the former should be gathered at the time the plant is in full blossom, while the latter are said to possess the greatest degree of energy just before they ripen. The fruits are the chief source whence *coniine* is prepared. The principal forms in which hemlock is employed are the extract and juice of hemlock, hemlock poultice, and the tincture of hemlock fruits. Large doses produce vertigo, nausea and paralysis; but in smaller quantities, administered by skilful hands, it has a sedative action on the nerves. It has also some reputation as an alterative and resolvent, and as an anodyne.

The acrid narcotic properties of the plant render it of some importance that one should be able to identify it, the more so as some of the compound-leaved umbellifers, which have a general similarity of appearance to it, form wholesome food for man and animals. Not only is this knowledge desirable to prevent the poisonous plant being detrimentally used in place of the wholesome one; it is equally important in the opposite case, namely, to prevent the inert being substituted for the remedial agent. The plant with which hemlock is most likely to be confounded is *Anthriscus sylvestris*, or cow-parsley, the leaves of which are freely eaten by cattle and rabbits; this plant, like the hemlock, has spotted stems but they are hairy, not hairless; it has much-divided leaves of the same general form, but they are downy and aromatic, not smooth and nauseous when bruised; and the fruit of *Anthriscus* is linear-oblong and not ovate.

HEMP (in O. Eng. *henep*, cf. Dutch *hennep*, Ger. *Hanf*, cognate with Gr. *κάρναβις*, Lat. *cannabis*), an annual herb (*Cannabis sativa*) having angular rough stems and alternate deeply lobed leaves. The best fibres of *Cannabis* are the hemp of commerce, but, unfortunately, the products from many totally different plants are often included under the general name of hemp. In some cases the fibre is obtained from the stem, while in others it comes from the leaf. Sunn hemp, Manila hemp, Sisal hemp, and Phormium (New Zealand flax, which is neither flax nor hemp) are treated separately. All these, however, are often classed under the above general name, and so are the following:—Deccan or Ambari hemp, *Hibiscus cannabinus*, an Indian and East Indian malvaceous plant, the fibre from which is often known as brown hemp or Bombay hemp; Pité hemp, which is obtained from the American aloe, *Agave americana*; and Moorva or bowstring-hemp, *Sanscoerita seylanica*, which is obtained from an aloe-like plant, and is a native of India and

Ceylon. Then there are Canada hemp, *Apocynum cannabinum*, Kentucky hemp, *Urtica cannabina*, and others.

The hemp plant, like the hop, which is of the same natural order, Cannabinaceae, is dioecious, i.e. the male and female flowers are borne on separate plants. The female plant grows to a greater height than the male, and its foliage is darker and more luxuriant, but the plant takes from five to six weeks longer to ripen. When the male plants are ripe they are pulled, put up into bundles, and steeped in a similar manner to flax, but the female plants are allowed to remain until the seed is perfectly ripe. They are then pulled, and after the seed has been removed are retted in the ordinary way. The seed is also a valuable product; the finest is kept for sowing, a large quantity is sold for the food of cage birds, while the remainder is sent to the oil mills to be crushed. The extracted oil is used in the manufacture of soap, while the solid remains, known as oil-cake, are valuable as a food for cattle. The leaves of hemp have five to seven leaflets, the form of which is lanceolate-acuminate, with a serrate margin. The loose panicles of male flowers, and the short spikes of female flowers, arise from the axils of the upper leaves. The height of the plant varies greatly with season, soil and manuring; in some districts it varies from 5 to 8 ft., but in the Piedmont province it is not unusual to see them from 8 to 16 ft. in height, whilst a variety (*Cannabis sativa*, variety *gigantea*) has produced specimens over 17 ft. in height.

All cultivated hemp belongs to the same species, *Cannabis sativa*; the special varieties such as *Cannabis indica*, *Cannabis chinensis*, &c., owe their differences to climate and soil, and they lose many of their peculiarities when cultivated in temperate regions. Rumphius (in the 17th century) had noticed these differences between Indian and European hemp.

Wild hemp still grows on the banks of the lower Ural, and the Volga, near the Caspian Sea. It extends to Persia, the Altai range and northern and western China. The authors of the *Pharmacographia* say:—"It is found in Kashmir and in the Himalaya, growing 10 to 12 ft. high, and thriving vigorously at an elevation of 6000 to 10,000 ft." Wild hemp is, however, of very little use as a fibre producer, although a drug is obtained from it.

It would appear that the native country of the hemp plant is in some part of temperate Asia, probably near the Caspian Sea. It spread westward throughout Europe, and southward through the Indian peninsula.

The names given to the plant and to its products in different countries are of interest in connexion with the utilization of the fibre and resin. In Sana it is called *goni*, *sana*, *shanapu*, *bang* and *ganjiko*; in Bengali, *ganga*; Pers. *bang* and *cauna*; Arab. *hinnub* or *cannab*; Gr. *kannabis*; Lat. *cannabis*; Ital. *canappa*; Fr. *chanvre*; Span. *cáñamo*; Portuguese, *cánamo*; Russ. *konópel*; Lettish and Lithuanian, *kannapes*; Slav. *konopi*; Eric. *canab* and *canab*; A. Sax. *hoenep*; Dutch, *hennep*; Ger. *Hanf*; Eng. *hemp*; Danish and Norwegian, *hamp*; Icelandic, *hampr*; and in Swed. *hampa*. The English word *canvas* sufficiently reveals its derivation from *cannabis*.

Very little hemp is now grown in the British Isles, although this variety was considered to be of very good quality, and to possess great strength. The chief continental hemp-producing countries are Italy, Russia and France; it is also grown in several parts of Canada and the United States and India. The Central Provinces, Bengal and Bombay are the chief centres of hemp cultivation in India, where the plant is of most use for narcotics. The satisfactory growth of hemp demands a light, rich and fertile soil, but, unlike most substances, it may be reared for a few years in succession. The time of sowing, the quantity of seed per acre (about three bushels) and the method of gathering and retting are very similar to those of flax; but, as a rule, it is a hardier plant than flax, does not possess the same pliability, is much coarser and more brittle, and does not require the same amount of attention during the first few weeks of its growth.

The very finest hemp, that grown in the province of Piedmont,

Italy, is, however, very similar to flax, and in many cases the two fibres are mixed in the same material. The hemp fibre has always been valuable for the rope industry, and it was at one time very extensively used in the production of yarns for the manufacture of sail cloth, sheeting, covers, bagging, sacking, &c. Much of the finer quality is still made into cloth, but almost all the coarser quality finds its way into ropes and similar material.

A large quantity of hemp cloth is still made for the British navy. The cloth, when finished, is cut up into lengths, made into bags and tarred. They are then used as coal sacks. There is also a quantity made into sacks which are intended to hold very heavy material. Hemp yarns are also used in certain classes of carpets, for special bags for use in cop dyeing and for similar special purposes, but for the ordinary bagging and sacking the employment of hemp yarns has been almost entirely supplanted by yarns made from the jute fibre.

Hemp is grown for three products—(1) the fibre of its stem; (2) the resinous secretion which is developed in hot countries upon its leaves and flowering heads; (3) its oily seeds.

Hemp has been employed for its fibre from ancient times. Herodotus (iv. 74) mentions the wild and cultivated hemp of Scythia, and describes the hempen garments made by the Thracians as equal to linen in fineness. Hensychius says the Thracian women made sheets of hemp. Moschion (about 200 a.c.) records the use of hempen ropes for rigging the ship "Syracusia" built for Hiero II. The hemp plant has been cultivated in northern India from a considerable antiquity, not only as a drug but for its fibre. The Anglo-Saxons were well acquainted with the mode of preparing hemp. Hempen cloth became common in central and southern Europe in the 13th century.

Hemp-resin.—Hemp as a drug or intoxicant for smoking and chewing occurs in the three forms of bhang, ganja and charas.

1. **Bhang**, the Hindustani *siddhi* or *sabai*, consists of the dried leaves and small stalks of the hemp; a few fruits occur in it. It is of a dark brownish-green colour, and has a faint peculiar odour and but a slight taste. It is smoked with or without tobacco; or it is made into a sweetmeat with honey, sugar and aromatic spices; or it is powdered and infused in cold water, yielding a turbid drink, *subdschi*. *Heshish* is one of the Arabic names given to the Syrian and Turkish preparations of the resinous hemp leaves. One of the commonest of these preparations is made by heating the bhang with water and butter, the butter becoming thus charged with the resinous and active substances of the plant.

2. **Ganja**, the guaza of the London brokers, consists of the flowering and fruiting heads of the female plant. It is brownish-green, and otherwise resembles bhang, as in odour and taste. Some of the more esteemed kinds of hashish are prepared from this ganja. Ganja is met with in the Indian bazaars in dense bundles of 24 plants or heads apiece. The hashish in such extensive use in Central Asia is often seen in the bazaars of large cities in the form of cakes, 1 to 3 in. thick, 5 to 10 in. broad and 10 to 15 in. long.

3. **Charas**, or *churrus*, is the resin itself collected, as it exudes naturally from the plant, in different ways. The best sort is gathered by the hand like opium; sometimes the resinous exudation of the plant is made to stick first of all to cloths, or to the leather garments of men, or even to their skin, and is then removed by scraping, and afterwards consolidated by kneading, pressing and rolling. It contains about one-third or one-fourth its weight of the resin. But the *churrus* prepared by different methods and in different countries differs greatly in appearance and purity. Sometimes it takes the form of egg-like masses of greyish-brown colour, having when of high quality a shining resinous fracture. Often it occurs in the form of irregular friable lumps, like pieces of impure linseed oil-cake.

The medicinal and intoxicating properties of hemp have probably been known in Oriental countries from a very early period. An ancient Chinese herbal, part of which was written about the 5th century a.c., while the remainder is of still earlier

date, notices the seed and flower-bearing kinds of hemp. Other early writers refer to hemp as a remedy. The medicinal and dietetic use of hemp spread through India, Persia and Arabia in the early middle ages. The use of hemp (bhang) in India was noticed by Garcia d'Orta in 1563. Herbu in his *Treasury of Drugs* (1690) describes it as of "an infatuating quality and pernicious use." Attention was recalled to this drug, in consequence of Napoleon's Egyptian expedition, by de Sacy (1809) and Rouger (1810). Its modern medicinal use is chiefly due to trials by Dr O'Shaughnessy in Calcutta (1838-1842). The plant is grown partly and often mainly for the sake of its resin in Persia, northern India and Arabia, in many parts of Africa and in Brazil.

Pharmacology and Therapeutics.—The composition of this drug is still extremely obscure; partly, perhaps, because it varies so much in individual specimens. It appears to contain at least two alkaloids—cannabinine and tetano-cannabinine—of which the former is volatile. The chief active principle may possibly be neither of these, but the substance cannabinon. There are also resins, a volatile oil and several other constituents. *Cannabis indica*—as the drug is termed in the pharmacopoeias—may be given as an extract (dose $\frac{1}{4}$ -1 gr.) or tincture (dose 5-15 minims).

The drug has no external action. The effects of its absorption, whether it be swallowed or smoked, vary within wide limits in different individuals and races. So great is this variation as to be inexplicable except on the view that the nature and proportions of the active principles vary greatly in different specimens. But typically the drug in an intoxicant, resembling alcohol in many features of its action, but differing in others. The early symptoms are highly pleasurable, and it is for these, as in the case of other stimulants, that the drug is so largely consumed in the East. There is a subjective sensation of mental brilliance, but, as in other cases, this is not borne out by the objective results. It has been suggested that the incoordination of nervous action under the influence of Indian hemp may be due to independent and non-concerted action on the part of the two halves of the cerebrum. Following on a decided lowering of the pain and touch senses, which may even lead to complete loss of cutaneous sensation, there comes a sleep which is often accompanied by pleasant dreams. There appears to be no evidence in the case of either the lower animals or the human subject that the drug is an aphrodisiac. Excessive indulgence in *cannabis indica* is very rare, but may lead to general ill-health and occasionally to insanity. The apparent impossibility of obtaining pure and trustworthy samples of the drug has led to its entire abandonment in therapeutics. When a good sample is obtained it is a safe and efficient hypnotic, at any rate in the case of a European. The tincture should not be prescribed unless precautions are taken to avoid the precipitation of the resin which follows its dilution with water.

See Watt, *Dictionary of the Economic Products of India*.

HEMSTERHUIS, FRANÇOIS (1721-1790), Dutch writer on aesthetics and moral philosophy, son of Tiberius Hemsterhuis, was born at Franeker in Holland, on the 27th of December 1721. He was educated at the university of Leiden, where he studied Plato. Failing to obtain a professorship, he entered the service of the state, and for many years acted as secretary to the state council of the United Provinces. He died at the Hague on the 7th of July 1790. Through his philosophical writings he became acquainted with many distinguished persons—Goethe, Herder, Princess Amalia of Gallitzin, and especially Jacobi, with whom he had much in common. Both were idealists, and their works suffer from a similar lack of arrangement, although distinguished by elegance of form and refined sentiment. His most valuable contributions are in the department of aesthetics or the general analysis of feeling. His philosophy has been characterized as Socratic in content and Platonic in form. Its foundation was the desire for self-knowledge and truth, untrammelled by the rigid bonds of any particular system.

His most important works, all of which were written in French, are: *Lettre sur la sculpture* (1769), in which occurs the well-known definition of the Beautiful as "that which gives us the greatest number of

ideas in the shortest space of time"; its continuation, *Lettre sur les désirs* (1770); *Lettre sur l'homme et ses rapports* (1772), in which the "moral organ" and the theory of knowledge are discussed; *Sophie* (1778), a dialogue on the relation between the soul and the body, and also an attack on materialism; *Aristote* (1779), the "theodicy" of Hemsterhuis, discussing the existence of God and his relation to man; *Simon* (1787), on the four faculties of the soul, which are the will, the imagination, the moral principle (which is both passive and active); *Alexis* (1787), an attempt to prove that there are three golden ages, the last being the life beyond the grave; *Lettre sur l'athéisme* (1787).

The best collected edition of his works is by P. S. Meijboom (1846-1850); see also S. A. Gronemann, *F. Hemsterhuis, de Norderlandische Weisgeer* (Utrecht, 1867); E. Grucker, *François Hemsterhuis, sa vie et ses œuvres* (Paris, 1866); E. Meyer, *Der Philosoph Frans Hemsterhuis* (Breslau, 1893), with bibliographical notice.

HEMSTERHUIS, TIBERIUS (1685-1766), Dutch philologist and critic, was born on the 9th of January 1685 at Groningen in Holland. His father, a learned physician, gave him so good an early education that, when he entered the university of his native town in his fifteenth year, he speedily proved himself to be the best student of mathematics. After a year or two at Groningen, he was attracted to the university of Leiden by the fame of Perizonius; and while there he was entrusted with the duty of arranging the manuscripts in the library. Though he accepted an appointment as professor of mathematics and philosophy at Amsterdam in his twentieth year, he had already directed his attention to the study of the ancient languages. In 1706 he completed the edition of Pollux's *Onomasticon* begun by Ledertin; but the praise he received from his countrymen was more than counterbalanced by two letters of criticism from Bentley, which mortified him so keenly that for two months he refused to open a Greek book. In 1717 Hemsterhuis was appointed professor of Greek at Franeker, but he did not enter on his duties there till 1720. In 1738 he became professor of national history also. Two years afterwards he was called to teach the same subjects at Leiden, where he died on the 9th of April 1766. Hemsterhuis was the founder of a laborious and useful Dutch school of criticism; had famous disciples in Valkenaer, Lennep and Ruhnkén.

His chief writings are the following: *Luciani colloquia et Timon* (1708); *Aristophanis Plutus* (1744); *Notæ, &c., ad Xenophontum Sphærum in the Miscellanea critica of Amsterdam*, vols. iii. and iv.; *Observationes ad Chrystostomi homilias; Oraciones* (1734); a Latin translation of the *Birds of Aristophanes*, in Kuster's edition; notes to Bernard's *Thomas Magister*, to Alberti's *Herichius*, to Ernesti's *Callimachus* and to Burmann's *Propertius*. See *Elogium T. Hemsterhusii* (with Bentley's letters) by Ruhnkén (1789), and *Supplementa annotationis ad elogium T. Hemsterhusii, &c.* (Leipzig, 1874); also J. E. Sandys' *Hist. Class. Scholarship*, ii. (1908).

HEMY, CHARLES NAPIER (1841-), British painter, born at Newcastle-on-Tyne, was trained in the Newcastle school of art, in the Antwerp academy and in the studio of Baron Leys. He has produced some figure subjects and landscapes, but is best known by his admirable marine paintings. He was elected an associate of the Royal Academy in 1898, associate of the Royal Society of Painters in Water Colours in 1890 and member in 1897. Two of his paintings, "Pilchards" (1897) and "London River" (1904), are in the National Gallery of British Art.

HEN, a female bird, especially the female of the common fowl (*g.*). The O. Eng. *hen* is the feminine form of *hana*, the male bird, a correlation of words which is represented in other Teutonic languages, cf. Ger. *Hahn*, *Henne*, Dutch *haan*, *hen*, Swed. *hane*, *honne*, &c. The O. Eng. name for the male bird has disappeared, its place being taken by "cock," a word probably of onomatopoeic origin, being from a base *kok*- or *kih*-, seen also in "chicken." This word also appears in Fr. *coq*, and medieval Lat. *coccus*.

HÉNAULT, CHARLES JEAN FRANÇOIS (1685-1770), French historian, was born in Paris on the 8th of February 1685. His father, a farmer-general of taxes, was a man of literary tastes, and young Hénault obtained a good education at the Jesuit college. Captivated by the eloquence of Massillon, in his fifteenth year he entered the Oratory with the view of becoming a preacher, but after two years' residence he changed his intention, and, inheriting a position which secured him access to the most select society of Paris, he achieved distinction at an early period by his

gay, witty and graceful manners. His literary talent, manifested in the composition of various light poetical pieces, an opera, a tragedy (*Cornélie restée*, 1710), &c., obtained him entrance to the Academy (1723). *Petit-maitre* as he was, he had also serious capacity, for he became councillor of the *parlement* of Paris (1705), and in 1710 he was chosen president of the court of *enquêtes*. After the death of the count de Rieux (son of the famous financier, Samuel Bernard) he became (1753) superintendent of the household of Queen Marie Leszczyńska, whose intimate friendship he had previously enjoyed. On his recovery in his eightieth year from a dangerous malady (1765) he professed to have undergone religious conversion and retired into private life, devoting the remainder of his days to study and devotion. His religion was, however, according to the marquis d'Argenson, "exempt from fanaticism, persecution, bitterness and intrigue"; and it did not prevent him from continuing his friendship with Voltaire, to whom it is said he had formerly rendered the service of saving the manuscript of *La Henriade*, when its author was about to commit it to the flames. The literary work on which Hénault bestowed his chief attention was the *Abrégé chronologique de l'histoire de France*, first published in 1744 without the author's name. In the compass of two volumes he comprised the whole history of France from the earliest times to the death of Louis XIV. The work has no originality. Hénault had kept his note-books of the history lectures at the Jesuit college, of which the substance was taken from Mézeray and P. Daniel. He revised them first in 1723, and later put them in the form of question and answer on the model of P. le Ragois, and by following Dubos and Boulaingvilliers and with the aid of the abbé Boudot he compiled his *Abrégé*. The research is all on the surface and is only borrowed. But the work had a prodigious success, and was translated into several languages, even into Chinese. This was due partly to Hénault's popularity and position, partly to the agreeable style which made the history readable. He inserted, according to the fashion of the period, moral and political reflections, which are always brief and generally as fresh and pleasing as they are just. A few masterly strokes reproduced the leading features of each age and the characters of its illustrious men; accurate chronological tables set forth the most interesting events in the history of each sovereign and the names of the great men who flourished during his reign; and interspersed throughout the work are occasional chapters on the social and civil state of the country at the close of each era in its history. Continuations of the work have been made at separate periods by Fantin des Odoards, by Anguis with notes by Valkenaer, and by Michaud. He died at Paris on the 24th of November 1770.

BIBLIOGRAPHY.—Hénault's *Mémoires* have come down to us in two different versions, both claiming to be authentic. One was published in 1855 by M. du Vigan; the other was owned by the Comte de Couteaux, who permitted Lucien Perey to give long extracts in his work on President Hénault (Paris, 1893). The memoirs are fragmentary and disconnected, but contain interesting anecdotes and details concerning persons of note. See the *Correspondance* of Grimm, of Madame du Deffand and of Voltaire; the notice by Valkenaer in the edition of the *Abrégé*; Sainte-Beuve, *Causeries du lundi*, vol. xi.; and the *Origines de l'abrégé* (*Ann. Bulletin de la Société de l'histoire de France*, 1901). Also H. Lion, *Le Président Hénault* (Paris, 1903).

HENBANE (Fr. *jusquiammo*, from the Gr. *δοσάμος*, or hog's-bean; Ital. *jusquiamo*; Ger. *Schwarzes Bilsenkraut*, *Elfenörtel*, *Saubohne* and *Zigeuner-Korn* or "gipsies' corn"); the common name of the plant *Hyoscyamus niger*, a member of the natural order Solanaceae, indigenous to Britain, found wild in waste places, on rubbish about villages and old castles, and cultivated for medicinal use in various counties in the south and east of England. It occurs also in central and southern Europe and in western Asia extending to India and Siberia, and has long been naturalised in the United States. There are two forms of the plant, an annual and a biennial, which spring indifferently from the same crop of seed—the one growing on during summer to a height of from 1 to 2 ft., and flowering and perfecting seed; the other producing the first season only a tuft of radical leaves, which disappear in winter, leaving under-

ground a thick fleshy root, from the crown of which arises in spring a branched flowering stem, usually much taller and more vigorous than the flowering stems of the annual plants. The biennial form is that which is considered officinal. The radical leaves of this biennial plant spread out flat on all sides from the crown of the root; they are ovate-oblong, acute, stalked, and more or less incisely-toothed, of a greyish-green colour, and covered with viscid hairs; these leaves perish at the approach of winter. The flowering stem pushes up from the root-crown in spring, ultimately reaching from 3 to 4 ft. in height, and as it grows becoming branched, and furnished with alternate sessile leaves, which are stem-clasping, oblong, unequally-lobed, clothed with glandular clammy hairs, and of a dull grey-green, the whole plant having a powerful nauseous odour. The flowers are shortly-stalked, the lower ones growing in the fork of the branches, the upper ones sessile in one-sided leafy spikes which are rolled back at the top before flowering, the leaves becoming smaller upwards and taking the place of bracts. The flowers have an urn-shaped calyx which persists around the fruit and is strongly veined, with five stiff, broad, almost prickly lobes; these, when the soft matter is removed by maceration, form very elegant specimens when associated with leaves prepared in a similar way. The corollas are obliquely funnel-shaped, of a dirty yellow or buff, marked with a close reticulation of purple veins. The capsule opens transversely by a convex lid and contains numerous seeds. Both the leaves and the seeds are employed in pharmacy. The Mahomedan doctors of India are accustomed to prescribe the seeds. Henbane yields a poisonous alkaloid, *Hyoscyamine*, which is stated to have properties almost identical with those of atropine, from which it differs in being more soluble in water. It is usually obtained in an amorphous, scarcely ever in a crystalline state. Its properties have been investigated in Germany by T. Husemann, Schroff, Höhn, &c. Höhn finds its chemical composition expressed by $C_{17}H_{23}N_2O_2$. (Compare Hellmann, *Beiträge zur Kenntnis der physiolog. Wirkung des Hyoscyamins*, &c., Jena, 1874.) In small and repeated doses henbane has been found to have a tranquillizing effect upon persons affected by severe nervous irritability. In poisonous doses it causes loss of speech, distortion and paralysis. In the form of extract or tincture it is a valuable remedy in the hands of a medical man, either as an anodyne, a hypnotic or a sedative. The extract of henbane is rich in nitrate of potassium and other inorganic salts. The smoking of the seeds and capsules of henbane is noted in books as a somewhat dangerous remedy adopted by country people for toothache. Accidental poisoning from henbane occasionally occurs, owing sometimes to the apparent edibility and wholesomeness of the root.

See Bentley and Trueman, *Medicinal Plants*, 194 (1886).

HENCHMAN, originally, probably, one who attended on a horse, a groom, and hence, like groom (*q.v.*), a title of a subordinate official in royal or noble households. The first part of the word is the O. Eng. *hengest*, a horse, a word which occurs in many Teutonic languages, cf. Ger. and Dutch *hengst*. The word appears in the name, Hengest, of the Saxon chieftain (see *HENGEST AND Horsa*) and still survives in English in place and other names beginning with Hingst- or Hinx-. Henchmen, pages of honour or squires, rode or walked at the side of their master in processions and the like, and appear in the English royal household from the 14th century till Elizabeth abolished the royal henchmen, known also as the "children of honour." The word was obsolete in English from the middle of the 17th century, and seems to have been revived through Sir Walter Scott, who took the word and its derivation, according to the *New English Dictionary*, from Edward Burt's *Letters from a Gentleman in the North of Scotland*, together with its erroneous derivation from "haunch." The word is, in this sense, used as synonymous with "gillie," the faithful personal follower of a Highland chieftain, the man who stands at his master's "haunch," ready for any emergency. It is in this sense that usually survives in modern usage of the word, where it is often used of an out-and-out adherent or partisan, ready to do anything.

HENDERSON, ALEXANDER (1583-1646), Scottish ecclesiastic, was born in 1583 at Criech, Fifeshire. He graduated at the university of St Andrews in 1603, and in 1610 was appointed professor of rhetoric and philosophy and questor of the faculty of arts. Shortly after this he was presented to the living of Leuchars. As Henderson was forced upon his parish by Archbishop George Gladstones, and was known to sympathize with episcopacy, his settlement was at first extremely unpopular; but he subsequently changed his views and became a Presbyterian in doctrine and church government, and one of the most esteemed ministers in Scotland. He early made his mark as a church leader, and took an active part in petitioning against the "five acts" and later against the introduction of a service-book and canons drawn up on the model of the English prayer-book. On the 1st of March 1638 the public signing of the "National Covenant" began in Greyfriars Church, Edinburgh. Henderson was mainly responsible for the final form of this document, which consisted of (1) the "king's confession" drawn up in 1581 by John Craig, (2) a recital of the acts of parliament against "superstitious and papistical rites," and (3) an elaborate oath to maintain the true reformed religion. Owing to the skill shown on this occasion he seems to have been applied to when any manifesto of unusual ability was required. In July of the same year he proceeded to the north to debate on the "Covenant" with the famous Aberdeen doctors; but he was not well received by them. "The voyd church was made fast, and the keys kept by the magistrate," says Baillie. Henderson's next public opportunity was in the famous Assembly which met in Glasgow on the 21st of November 1638. He was chosen moderator by acclamation, being, as Baillie says, "incomparable the ablest man of us all for all things." James Hamilton, 3rd marquis of Hamilton, was the king's commissioner; and when the Assembly insisted on proceeding with the trial of the bishops, he formally dissolved the meeting under pain of treason. Acting on the constitutional principle that the king's right to convene did not interfere with the church's independent right to hold assemblies, they sat till the 30th of December, deposed all the Scottish bishops, excommunicated a number of them, repealed all acts favouring episcopacy, and reconstituted the Scottish Kirk on thorough Presbyterian principles. During the sitting of this Assembly it was carried by a majority of seventy-five votes that Henderson should be transferred to Edinburgh. He had been at Leuchars for about twenty-three years, and was extremely reluctant to leave it.

While Scotland and England were preparing for the "First Bishops' War," Henderson drew up two papers, entitled respectively *The Remonstrance of the Nobility and Instructions for Defensive Arms*. The first of these documents he published himself; the second was published against his wish by John Corbet (1603-1641), a deposed minister. The "First Bishops' War" did not last long. At the Pacification of Birks the king virtually granted all the demands of the Scots. In the negotiations for peace Henderson was one of the Scottish commissioners, and made a very favourable impression on the king. In 1640 Henderson was elected by the town council rector of Edinburgh University—an office to which he was annually re-elected till his death. The Pacification of Birks had been wrung from the king; and the Scots, seeing that he was preparing for the "Second Bishops' War," took the initiative, and pressed into England so vigorously that Charles had again to yield everything. The maturing of the treaty of peace took a considerable time, and Henderson was again active in the negotiations, first at Ripon (October 1st) and afterwards in London. While he was in London he had a personal interview with the king, with the view of obtaining assistance for the Scottish universities from the money formerly applied to the support of the bishops. On Henderson's return to Edinburgh in July 1641 the Assembly was sitting at St Andrews. To suit the convenience of the parliament, however, it removed to Edinburgh; Henderson was elected moderator of the Edinburgh meeting. In this Assembly he proposed that "a confession of faith, a catechism, a directory for all the parts of the public worship, and a platform

of government, wherein possibly England and we might agree," should be drawn up. This was unanimously approved of, and the laborious undertaking was left in Henderson's hands; but the "notable motion" did not lead to any immediate results. During Charles's second state-visit to Scotland, in the autumn of 1641, Henderson acted as his chaplain, and managed to get the funds, formerly belonging to the bishopric of Edinburgh, applied to the metropolitan university. In 1642 Henderson, whose policy was to keep Scotland neutral in the war which had now broken out between the king and the parliament, was engaged in corresponding with England on ecclesiastical topics; and, shortly afterwards, he was sent to Oxford to mediate between the king and his parliament; but his mission proved a failure.

A memorable meeting of the General Assembly was held in August 1643. Henderson was elected moderator for the third time. He presented a draft of the famous "Solemn League and Covenant," which was received with great enthusiasm. Unlike the "National Covenant" of 1638, which applied to Scotland only, this document was common to the two kingdoms. Henderson, Baillie, Rutherford and others were sent up to London to represent Scotland in the Assembly at Westminster. The "Solemn League and Covenant," which pledged both countries to the extirpation of prelacy, leaving further decision as to church government to be decided by the "example of the best reformed churches," after undergoing some slight alterations, passed the two Houses of Parliament and the Westminster Assembly, and thus became law for the two kingdoms. By means of it Henderson has had considerable influence on the history of Great Britain. As Scottish commissioner to the Westminster Assembly, he was in England from August 1643 till August 1646, his principal work was the drafting of the directory for public worship. Early in 1645 Henderson was sent to Uxbridge to aid the commissioners of the two parliaments in negotiating with the king; but nothing came of the conference. In 1646 the king joined the Scottish army; and, after retiring with them to Newcastle, he sent for Henderson, and discussed with him the two systems of church government in a number of papers. Meanwhile Henderson was falling in health. He sailed to Scotland, and eight days after his arrival died, on the 19th of August 1646. He was buried in Greyfriars churchyard, Edinburgh; and his death was the occasion of national mourning in Scotland. On the 7th of August Baillie had written that he had heard that Henderson was dying "most of heartbreak." A document was published in London purporting to be a "Declaration of Mr Alexander Henderson made upon his Death-bed"; and, although this paper was disowned, denounced and shown to be false in the General Assembly of August 1648, the document was used by Clarendon as giving the impression that Henderson had recanted. Its foundation was probably certain expressions lamenting Scottish interference in English affairs.

Henderson is one of the greatest men in the history of Scotland and, next to Knox, is certainly the most famous of Scottish ecclesiastics. He had great political genius; and his statesmanship was so influential that "he was," as Masson well observes, "a cabinet minister without office." He has made a deep mark on the history, not only of Scotland, but of England; and the existing Presbyterian churches in Scotland are largely indebted to him for the forms of their dogmas and their ecclesiastical organization. He is thus justly considered the second founder of the Reformed Church in Scotland.

See *M'Crie's Life of Alexander Henderson* (1846); *Alton's Life and Times of Alexander Henderson* (1836); *The Letters and Journals of Robert Baillie* (1841-1842) (an exceedingly valuable work, from an historical point of view); *J. H. Burton's History of Scotland*; *D. Masson's Life of Drummond of Hawthornden*; and, above all, *Masson's Life of Milton*; *Andrew Lang, Hist. of Scotland* (1907), vol. iii. Henderson's own works are chiefly contributions to current controversies, speeches and sermons. (T. G.; D. M.N.)

HENDERSON, EBENEZER (1784-1858), a Scottish divine, was born at the Linn near Dunfermline on the 17th of November 1784, and died at Mortlake on the 17th of May 1858. He was the youngest son of an agricultural labourer, and after three years'

schooling spent some time at watchmaking and as a shoemaker's apprentice. In 1803 he joined Robert Haldane's theological seminary, and in 1805 was selected to accompany the Rev. John Paterson to India; but as the East India Company would not allow British vessels to convey missionaries to India, Henderson and his colleague went to Denmark to await the chance of a passage to Serampur, then a Danish port. Being unexpectedly delayed, and having begun to preach in Copenhagen, they ultimately decided to settle in Denmark, and in 1806 Henderson became pastor at Elsinore. From this time till about 1817 he was engaged in encouraging the distribution of Bibles in the Scandinavian countries, and in the course of his labours he visited Sweden and Lapland (1807-1808), Iceland (1814-1815) and the mainland of Denmark and part of Germany (1816). During most of this time he was an agent of the British and Foreign Bible Society. On the 6th of October 1811 he formed the first Congregational church in Sweden. In 1818, after a visit to England, he travelled in company with Paterson through Russia as far south as Tiflis, but, instead of settling as was proposed at Astrakhan, he retraced his steps, having resigned his connexion with the Bible Society owing to his disapproval of a translation of the Scriptures which had been made in Turkish. In 1822 he was invited by Prince Alexander (Galitzin) to assist the Russian Bible Society in translating the Scriptures into various languages spoken in the Russian empire. After twenty years of foreign labour Henderson returned to England, and in 1825 was appointed tutor of the Mission College, Gosport. In 1830 he succeeded Dr William Harrison as theological lecturer and professor of Oriental languages in Highbury Congregational College. In 1850, on the amalgamation of the colleges of Homerton, Coward and Highbury, he retired on a pension. In 1852-1853 he was pastor of Sheva Vale chapel at Mortlake. His last work was a translation of the book of Ezekiel. Henderson was a man of great linguistic attainment. He made himself more or less acquainted, not only with the ordinary languages of scholarly accomplishment and the various members of the Scandinavian group, but also with Hebrew, Syriac, Ethiopic, Russian, Arabic, Tatar, Persian, Turkish, Armenian, Manchu, Mongolian and Coptic. He organized the first Bible Society in Denmark (1814), and paved the way for several others. In 1817 he was nominated by the Scandinavian Literary Society a corresponding member; and in 1840 he was made D.D. by the university of Copenhagen. He was honorary secretary for life of the Religious Tract Society, and one of the first promoters of the British Society for the Propagation of the Gospel among the Jews. The records of his travels in Iceland (1818) were valuable contributions to our knowledge of that island. His other principal works are: *Iceland, or the Journal of a Residence in that Island* (2 vols., 1818); *Biblical Researches and Travels in Russia* (1826); *Elements of Biblical Criticism and Interpretation* (1830); *The Vaudets, a Tour of the Valleys of Piedmont* (1845).

See *Memoirs of Ebenezer Henderson*, by Thulia S. Henderson (his daughter) (London, 1859); *Congregational Year Book* (1859).

HENDERSON, GEORGE FRANCIS ROBERT (1854-1903), British soldier and military writer, was born in Jersey in 1854. Educated at Leeds Grammar School, of which his father, afterwards Dean of Carlisle, was headmaster, he was early attracted to the study of history, and obtained a scholarship at St John's College, Oxford. But he soon left the University for Sandhurst, whence he obtained his first commission in 1878. One year later, after a few months' service in India, he was promoted lieutenant and returned to England, and in 1882 he went on active service with his regiment, the York and Lancaster (65th/84th) to Egypt. He was present at Tell-el-Mahuta and Kassassin, and at Tell-el-Kebir was the first man of his regiment to enter the enemy's works. His conduct attracted the notice of Sir Garnet (afterwards Lord) Wolseley, and he received the 5th class of the Medjidieh order. His name was, further, noted for a brevet-majority, which he did not receive till he became captain in 1886. During these years he had been quietly studying military art and history at Gibraltar, in Bermuda and in Nova Scotia, in spite of the difficulties of research, and in 1889 appeared

(anonymously) his first work, *The Campaign of Fredericksburg*. In the same year he became Instructor in Tactics, Military Law and Administration at Sandhurst. From this post he proceeded as Professor of Military Art and History to the Staff College (1892-1899), and there exercised a profound influence on the younger generation of officers. His study on *Spichern* had been begun some years before, and in 1898 appeared, as the result of eight years' work, his masterpiece, *Stonewall Jackson and the American Civil War*. In the South African War Lieutenant-Colonel Henderson served with distinction on the staff of Lord Roberts as Director of Intelligence. But overwork and malaria broke his health, and he had to return home, being eventually selected to write the official history of the war. But failing health obliged him to go to Egypt, where he died at Assuan on the 9th of March 1903. He had completed the portion of the history of the South African War dealing with the events up to the commencement of hostilities, amounting to about a volume, but the War Office decided to suppress this, and the work was begun *de novo* and carried out by Sir F. Maurice.

Various lectures and papers by Henderson were collected and published in 1905 by Captain Malcolm, D.S.O., under the title *The Science of War*; to this collection a memoir was contributed by Lord Roberts. See also *Journal of the Royal United Service Institution*, vol. xiv. No. 302.

HENDERSON, JOHN (1747-1785), English actor, of Scottish descent, was born in London. He made his first appearance on the stage at Bath on the 6th of October 1772 as Hamlet. His success in this and other Shakespearian parts led to his being called the "Bath Roscius." He had great difficulty in getting a London engagement, but finally appeared at the Haymarket in 1777 as Shylock, and his success was a source of considerable profit to Colman, the manager. Sheridan then engaged him to play at Drury Lane, where he remained for two years. When the companies joined-forces he went to Covent Garden, appearing as Richard III. in 1778, and creating original parts in many of the plays of Cumberland, Shirley, Jephson and others. His last appearance was in 1785 as Horatius in *The Roman Father*, and he died on the 25th of November of that year and was buried in Westminster Abbey. Garrick was very jealous of Henderson, and the latter's power of mimicry separated him also from Colman, but he was always gratefully remembered by Mrs. Siddons and others of his profession whom he had encouraged. He was a close friend of Gainsborough, who painted his portrait, as did also Stewart and Romney. He was co-author of Sheridan and Henderson's *Practical Method of Reading and Writing English Poetry*.

HENDERSON, a city and the county-seat of Henderson county, Kentucky, U.S.A., on the S. bank of the Ohio river, about 142 m. W.S.W. of Louisville. Pop. (1890), 8835; (1900), 10,272, of whom 4029 were negroes; (1910 census) 11,452. It is served by the Illinois Central, the Louisville & Nashville, and the Louisville, Henderson & St. Louis railways, and has direct communication by steamboat with Louisville, Evansville, Cairo, Memphis and New Orleans. Henderson is built on the high bank of the river, above the flood level; the river is spanned here by a fine steel bridge, designed by George W. G. Ferris (1859-1896), the designer of the Ferris Wheel. The city has a public park of 80 acres and a Carnegie library. It is situated in the midst of a region whose soil is said to be the best in the world for the raising of dark, heavy-fibred tobacco, and is well adapted also for the growing of fruit, wheat and Indian corn. Bituminous coal is obtained from the surrounding country. Immense quantities of stemmed tobacco are shipped from here, and the city is an important market for Indian corn. The manufactures of the city include cotton and woollen goods, hominy, meal, flour, tobacco and cigars, carriages, baskets, chairs and other furniture, bricks, ice, whisky and beer; the value of the city's factory products in 1905 was \$1,365,120. The municipality owns and operates its water works, gas plant and electric-lighting plant. Henderson, named in honour of Richard Henderson (1734-1785), was settled as early as 1784, was first known as Red Banks, was laid out as a town by Henderson's company in 1797, was incorporated as a town in 1810, and

was first chartered as a city in 1854. The city boundary lines were extended in 1905 by the annexation of Audubon and Edgewood. Henderson was for some time the home of John James Audubon, the ornithologist.

HENDIADYCE, the name adopted from the Gr. ἑνδιὰδυε ("one by means of two") for a rhetorical figure, in which two words connected by a copulative conjunction are used of a single idea; usually the figure takes the form of two substantives instead of a substantive and adjective, as in the classical example *pateris libamus et auro* (Virgil, *Georgics*, ii. 192), "we pour libations in cups and gold" for "cups of gold."

HENDON, an urban district in the Harrow parliamentary division of Middlesex, England, on the river Brent, 8 m. N.W. of St Paul's Cathedral, London, served by the Midland railway. Pop. (1891), 15,843; (1901), 22,450. The nucleus of the township lies on high ground to the east of the Edgware road, which crosses the Welsh Harp reservoir of Regent's Canal, a favourite fishing and skating resort. The church of St Mary is mainly Perpendicular, and contains a Norman font and monuments of the 18th century. To the north of the village, which has extended greatly as a residential suburb of the metropolis, is Mill Hill, with a Roman Catholic Missionary College, opened in 1871, with branches at Rosendaal, Holland and Brixen, Austria, and a preparatory school at Freshfield near Liverpool; and a large grammar school founded by Nonconformists in 1807. The manor belonged to an early date to the abbot of Westminster.

HENDRICKS, THOMAS ANDREWS (1819-1885), American political leader, vice-president of the United States in 1885, was born near Zanererville, Ohio, on the 7th of September 1819. He graduated at Hanover College, Hanover, Indiana, in 1841, and began in 1843 a successful career at the bar. Identifying himself with the Democratic party, he served in the state House of Representatives in 1848, and was a prominent member of the convention for the revision of the state constitution in 1850-1851, a representative in Congress (1851-1855), commissioner of the United States General Land Office (1855-1859), a United States senator (1863-1869), and governor of Indiana (1873-1877). From 1868 until his death he was put forward for nomination for the presidency at every national Democratic Convention save in 1872. Both in 1876 and 1884, after his failure to receive the nomination for the presidency, he was nominated by the Democratic National Convention for vice-president, his nomination in each of these conventions being made partly, it seems, with the hope of gaining "greenback" votes—Hendricks had opposed the immediate resumption of specie payments. In 1876, with S. J. Tilden, he lost the disputed election by the decision of the electoral commission, but he was elected with Grover Cleveland in 1884. He died at Indianapolis on the 25th of November 1885.

HENGELO, or **HENGEOLO**, a town in the province of Overijssel, Holland, and a junction station 5 m. by rail N.W. of Enschede. Pop. (1900), 14,068. The castle belonging to the ancient territorial lords of Hengelo has long since disappeared, and the only interest the town now possesses is as the centre of the flourishing industries of the Twente district. The manufacture of cotton in all its branches is very actively carried on, and there are dye-works and breweries, besides the engineering works of the state railway company.

HENGEST and **HORSA**, the brother chieftains who led the first Saxon bands which settled in England. They were apparently called in by the British king Vortigern (q.v.) to defend him against the Picts. The place of their landing is said to have been Ebbsfleet in Kent. Its date is not certainly known, 450-455 being given by the English authorities, 428 by the Welsh (see **KENT**). The settlers of Kent are described by Bede as Jutes (q.v.), and there are traces in Kentish custom of differences from the other Anglo-Saxon kingdoms. Hengest and Horsa were at first given the island of Thanet as a home, but soon quarrelled with their British allies, and gradually possessed themselves of what became the kingdom of Kent. In 455 the Saxon Chronicle records a battle between Hengest and Horsa and Vortigern at a place called Aegels threp, in which Horsa

was slain. Thenceforward Hengest reigned in Kent, together with his son Aesc (Disc). Both the *Saxon Chronicle* and the *Historia Brittonum* record three subsequent battles, though the two authorities disagree as to their issue. There is no doubt, however, that the net result was the expulsion of the Britons from Kent. According to the *Chronicle*, which probably derived its information from a lost list of Kentish kings, Hengest died in 488, while his son Aesc continued to reign until 512.

Bede, Hist. Eccl. (Plummer, 1896), i. 75, §. 5; *Saxon Chronicle* (Earle and Plummer, 1899), s.a. 449, 455, 457, 465, 473; *Nennius, Historia Brittonum* (San Marte, 1844), §§ 31, 37, 38, 43-46, 58.

HENGSTENBERG, ERNST WILHELM (1802-1860), German Lutheran divine and theologian, was born at Fröndenberg, a Westphalian village, on the 20th of October 1802. He was educated by his father, who was a minister of the Reformed Church, and head of the Fröndenberg convent of canonesses (Fräuleinstift). Entering the university of Bonn in 1819, he attended the lectures of G. G. Freytag for Oriental languages and of F. K. L. Gieseler for church history, but his energies were principally devoted to philosophy and philology, and his earliest publication was an edition of the Arabic *Moallakat* of Amru'l-Qais, which gained for him the prize at his graduation in the philosophical faculty. This was followed in 1824 by a German translation of Aristotle's *Metaphysics*. Finding himself without the means to complete his theological studies under Neander and Tholuck in Berlin, he accepted a post at Basel as tutor in Oriental languages to J. J. Stähelin, who afterwards became professor at the university. Then it was that he began to direct his attention to a study of the Bible, which led him to a conviction, sever afterwards shaken, not only of the divine character of evangelical religion, but also of the unapproachable adequacy of its expression in the Augsburg Confession. In 1824 he joined the philosophical faculty of Berlin as a *Privatdozent*, and in 1825 he became a licentiate in theology, his theses being remarkable for their evangelical fervour and for their emphatic protest against every form of "rationalism," especially in questions of Old Testament criticism. In 1826 he became professor extraordinary in theology; and in July 1827 appeared, under his editorship, the *Evangelische Kirchenzeitung*, a strictly orthodox journal, which in his hands acquired an almost unique reputation as a controversial organ. It did not, however, attain to great notoriety until in 1830 an anonymous article (by E. L. von Gerlach) appeared, which openly charged Wilhelm Gesenius and J. A. L. Wegscheider with infidelity and profanity, and on the ground of these accusations advocated the interposition of the civil power, thus giving rise to the prolonged *Halle'sche Streit*. In 1838 the first volume of Hengstenberg's *Christologie des Alten Testaments* passed through the press; in the autumn of that year he became professor ordinarius in theology, and in 1829 doctor of theology. He died on the 28th of May 1860.

The following is a list of his principal works: *Christologie des Alten Testaments* (1829-1835; 2nd ed., 1854-1857; Eng. trans. by R. Keith, 1835-1839, also in Clark's "Foreign Theological Library," by T. Meyer and J. Martin, 1854-1858), a work of much learning, the estimate of which varies according to the hermeneutical principles of the individual critic; *Beiträge zur Einleitung in das Alte Testament* (1831-1839); Eng. trans., *Dissertations on the Genuineness of Daniel and the Integrity of Zechariah* (Edin., 1848), and *Dissertations on the Genuineness of the Pentateuch* (Edin., 1847), in which the traditional view on each question is strongly upheld, and much capital is made of the absence of harmony among the negative critics; *Die Bücher Moses und Ägypten* (1841); *Die Geschichte Bileam u. seiner Weissagungen* (1842; translated along with the *Dissertations on Daniel and Zechariah*); *Commentar über die Psalmen* (1842-1847; 2nd ed., 1849-1852; Eng. trans. by P. Fairbairn and J. Thomson, Edin., 1844-1848), which shares the merits and defects of the *Christologie*; *Die Offenbarung Johannes erläutert* (1849-1851; 2nd ed., 1861-1862; Eng. trans. by P. Fairbairn, also in Clark's "Foreign Theological Library," 1851-1852); *Das Hohe Lied ausgelegt* (1853); *Der Prediger Salomo ausgelegt* (1859); *Das Evangelium Johannes erläutert* (1861-1863; 2nd ed., 1867-1871; Eng. trans., 1865) and *Die Weissagungen des Propheten Esaias erläutert* (1867-1868). Of minor importance are *De rebus Tyriorum commentatio academica* (1832); *Über den Tag des Herrn* (1852); *Das Passa, ein Vortrag* (1853); and *Die Opfer der heiligen Schrift* (1859). Several series of papers also, as, for example, on "The Retention of the Apocrypha," "Freemasonry" (1854), "Duelling" (1856) and

"The Relation between the Jews and the Christian Church" (1857; 2nd ed., 1859), which originally appeared in the *Kirchenzeitung*, were afterwards printed in a separate form. *Geschichte des Reiches Gottes unter dem Alten Bunde* (1869-1871), *Das Buch Hiob erläutert* (1870-1875) and *Vorlesungen über die Leidensgeschichte* (1875) were published posthumously.

See J. Bachmann's *Ernst Wilhelm Hengstenberg* (1876-1879); and his article in Herzog-Hauck, *Realencyclopädie* (1899), and his article in the *Allgemeine deutsche Biographie*. Also F. Lichtenberger, *History of German Theology in the Nineteenth Century* (1889), pp. 212-217; Philip Schaaf, *Germany; its Universities, Theology and Religion* (1857), pp. 300-319.

HENKE, HEINRICH PHILIPP KONRAD (1752-1809), German theologian, best known as a writer on church history, was born at Hehlen, Brunswick, on the 3rd of July 1752. He was educated at the gymnasium of Brunswick and the university of Helmstädt, and from 1778 to 1809 he was professor, first of philosophy, then of theology, in that university. In 1803 he was appointed principal of the Carolinum in Brunswick as well. He died on the 2nd of May 1809. Henke belonged to the rationalistic school. His principal work (*Allgemeine Geschichte der christl. Kirche*, 6 vols., 1788-1804; 2nd ed., 1795-1806) is commended by F. C. Baur for fullness, accuracy and artistic composition. His other works are *Lineamenta institutionum fidei Christianae historico-criticarum* (1783), *Opuscula academica* (1802) and two volumes of *Predigten*. He was also editor of the *Magazin für die Religionsphilosophie, Exegese und Kirchengeschichte* (1793-1802) and the *Archiv für die neueste Kirchengeschichte* (1794-1799).

His son, ERNST LUDWIG THEODOR HENKE (1804-1872), after studying at the university of Jena, became professor extraordinary there in 1833, and professor ordinarius of Marburg in 1839. He is known as the author of monographs upon *Georg Calist u. seine Zeit* (1853-1860), *Papst Pius VII.* (1860), *Konrad von Marburg* (1861), *Kaspar Peucer u. Nik. Kraß* (1865), *Jak. Friedr. Fries* (1867), *Zur neuern Kirchengeschichte* (1867).

HENLE, FRIEDRICH GUSTAV JAKOB (1809-1885), German pathologist and anatomist, was born on the 9th of July 1809 at Fürth, in Franconia. After studying medicine at Heidelberg and at Bonn, where he took his doctor's degree in 1832, he became professor in anatomy to Johannes Müller at Berlin. During the six years he spent in that position he published a large amount of work, including three anatomical monographs on new species of animals, and papers on the structure of the lacteal system, the distribution of epithelium in the human body, the structure and development of the hair, the formation of mucus and pus, &c. In 1840 he accepted the chair of anatomy at Zürich, and in 1844 he was called to Heidelberg, where he taught not only anatomy, but physiology and pathology. About this period he was engaged on his complete system of general anatomy, which formed the sixth volume of the new edition of S. T. von Sömmerring's treatise, published at Leipzig between 1841 and 1844. While at Heidelberg he published a zoological monograph on the sharks and rays, in conjunction with his master Müller, and in 1846 his famous *Manual of Rational Pathology* began to appear; this marked the beginning of a new era in pathological study, since in it physiology and pathology were treated, in Henle's own words, as "branches of one science," and the facts of disease were systematically considered with reference to their physiological relations. In 1852 he moved to Göttingen, whence he issued three years later the first instalment of his great *Handbook of Systematic Human Anatomy*, the last volume of which was not published till 1873. This work was perhaps the most complete and comprehensive of its kind that had so far appeared, and it was remarkable not only for the fullness and minuteness of the anatomical descriptions, but also for the number and excellence of the illustrations with which they were elucidated. During the latter half of his life Henle's researches were mainly histological in character, his investigations embracing the minute anatomy of the blood vessels, serous membranes, kidney, eye, nails, central nervous system, &c. He died at Göttingen on the 13th of May 1885.

HENLEY, JOHN (1692-1759), English clergyman, commonly known as "Orator Henley," was born on the 3rd of August 1692 at Melton-Mowbray, where his father was vicar. After attending the grammar schools of Melton and Oakham, he entered St John's College, Cambridge, and while still an undergraduate he addressed in February 1712, under the pseudonym of Peter de Quir, a letter to the *Spectator* displaying no small wit and humour. After graduating B.A., he became assistant and then headmaster of the grammar school of his native town, uniting to these duties those of assistant curate. His abundant energy found still further expression in a poem entitled *Esther, Queen of Persia* (1714), and in the compilation of a grammar of ten languages entitled *The Complete Linguist* (2 vols., London, 1719-1721). He then decided to go to London, where he obtained the appointment of assistant preacher in the chapels of Ormond Street and Bloomsbury. In 1723 he was presented to the rectory of Chelmondiston in Suffolk; but residence being insisted on, he resigned both his appointments, and on the 3rd of July 1726 opened what he called an "oratory" in Newport Market, which he licensed under the Toleration Act. In 1729 he transferred the scene of his operations to Lincoln's Inn Fields. Into his services he introduced many peculiar alterations: he drew up a "Primitive Liturgy," in which he substituted for the Nicene and Athanasian creeds two creeds taken from the Apostolical Constitutions; for his "Primitive Eucharist" he made use of unleavened bread and mixed wine; he distributed at the price of one shilling medals of admission to his oratory, with the device of a sun rising to the meridian, with the motto *Ad summa*, and the words *Inveniam viam aut faciam* below. But the most original element in the services was Henley himself, who is described by Pope in the *Dunciad* as

"Preacher at once and zany of his age."

He possessed some oratorical ability and adopted a very theatrical style of elocution, "tuning his voice and balancing his hands"; and his addresses were a strange medley of solemnity and buffoonery, of clever wit and the wildest absurdity, of able and original disquisition and the worst artifices of the oratorical charlatan. His services were much frequented by the "free-thinkers," and he himself expressed his determination "to die a rational." Besides his Sunday sermons, he delivered Wednesday lectures on social and political subjects; and he also projected a scheme for connecting with the "oratory" a university on quite a utopian plan. For some time he edited the *Hyp Doctor*, a weekly paper established in opposition to the *Craftsman*, and for this service he enjoyed a pension of £100 a year from Sir Robert Walpole. At first the orations of Henley drew great crowds, but, although he never discontinued his services, his audience latterly dwindled almost entirely away. He died on the 13th of October 1759.

Henley is the subject of several of Hogarth's prints. His life, professedly written by A. Welsted, but in all probability by himself, was inserted by him in his *Oratory Transactions*. See J. B. Nichols, *History of Leicestershire*; I. Disraeli, *Calamities of Authors*.

HENLEY, WILLIAM ERNEST (1849-1903), British poet, critic and editor, was born on the 23rd of August 1849 at Gloucester, and was educated at the Crypt Grammar School in that city. The school was a sort of Cinderella sister to the Cathedral School, and Henley indicated its shortcomings in his article (*Pall Mall Magazine*, Nov. 1900) on T. E. Brown the poet, who was headmaster there for a brief period. Brown's appointment, uncongenial to himself, was a stroke of luck for Henley, for whom, as he said, it represented a first acquaintance with a man of genius. "He was singularly kind to me at a moment when I needed kindness even more than I needed encouragement." Among other kindnesses Brown did him the essential service of lending him books. To the end Henley was no classical scholar, but his knowledge and love of literature were vital. Afflicted with a physical infirmity, he found himself in 1874, at the age of twenty-five, an inmate of the hospital at Edinburgh. From there he sent to the *Cornhill Magazine* poems in irregular rhythms, describing with poignant force his experiences in hospital. Leslie Stephen, then editor, being in Edinburgh,

visited his contributor in hospital and took Robert Louis Stevenson, another recruit of the *Cornhill*, with him. The meeting between Stevenson and Henley, and the friendship of which it was the beginning, form one of the best-known episodes in recent literature (see especially Stevenson's letter to Mrs Sitwell, Jan. 1875, and Henley's poems "An Apparition" and "Envoy to Charles Baxter"). In 1877 Henley went to London and began his editorial career by editing *London*, a journal of a type more usual in Paris than London, written for the sake of its contributors rather than of the public. Among other distinctions it first gave to the world *The New Arabian Nights* of Stevenson. Henley himself contributed to his journal a series of verses chiefly in old French forms. He had been writing poetry since 1872, but (so he told the world in his "advertisement" to his collected *Poems*, 1898) he "found himself about 1877 so utterly unmarketable that he had to own himself beaten in art and to addict himself to journalism for the next ten years." After the decease of *London*, he edited the *Magazine of Art* from 1882 to 1886. At the end of that period he came before the public as a poet. In 1887 Mr Gleeson White made for the popular series of *Conterbury Poets* (edited by Mr William Sharp) a selection of poems in old French forms. In his selection Mr Gleeson White included a considerable number of pieces from *London*, and only after he had completed the selection did he discover that the verses were all by one hand, that of Henley. In the following year, Mr H. B. Donkin in his volume *Voluntaries*, done for an East End hospital, included Henley's unrhymed rhythms quintessentializing the poet's memories of the old Edinburgh Infirmary. Mr Alfred Nutt read these, and asked for more; and in 1888 his firm published *A Book of Verse*. Henley was by this time well known in a restricted literary circle, and the publication of this volume determined for them his fame as a poet, which rapidly outgrew these limits, two new editions of this volume being called for within three years. In this same year (1888) Mr Fitzroy Bell started the *Scots Observer* in Edinburgh, with Henley as literary editor, and early in 1889 Mr Bell left the conduct of the paper to him. It was a weekly review somewhat on the lines of the old *Saturday Review*, but inspired in every paragraph by the vigorous and combative personality of the editor. It was transferred soon after to London as the *National Observer*, and remained under Henley's editorship until 1893. Though, as Henley confessed, the paper had almost as many writers as readers, and its fame was mainly confined to the literary class, it was a lively and not unimportant feature of the literary life of its time. Henley had the editor's great gift of discerning promise, and the "Men of the *Scots Observer*," as Henley affectionately and characteristically called his band of contributors, in most instances justified his insight. The paper found utterance for the growing imperialism of its day, and among other services to literature gave to the world Mr Kipling's *Barrack-Room Ballads*. In 1890 Henley published *Views and Reviews*, a volume of notable criticisms, described by himself as "less a book than a mosaic of scraps and shreds recovered from the shot rubbish of some fourteen years of journalism." The criticisms, covering a wide range of authors (except Heine and Tolstoy, all English and French), though wilful and often one-sided were terse, trenchant and picturesque, and remarkable for insight and gusto. In 1892 he published a second volume of poetry, named after the first poem, *The Song of the Sword*, but on the issue of the second edition (1893) re-christened *London Voluntaries* after another section. Stevenson wrote that he had not received the same thrill of poetry since Mr Meredith's "Joy of Earth" and "Love in the Valley," and he did not know that that was so intimate and so deep. "I did not guess you were so great a magician. These are new tunes; this is an undertone of the true Apollo. These are not verse; they are poetry." In 1892 Henley published also three plays written with Stevenson—*Beau Austin*, *Deacon Brodie* and *Admiral Guineas*. In 1895 followed *Macaire*, afterwards published in a volume with the other plays. *Deacon Brodie* was produced in Edinburgh in 1884 and later in London. Beerbohm Tree produced *Beau Austin* at the Haymarket on the 3rd of November 1890

and *Macbeth* at His Majesty's on the 2nd of May 1802. *Admiral Guineo* also achieved stage performance. In the meantime Henley was active in the magazines and did notable editorial work for the publishers: the *Lyra Heroica*, 1801; *A Book of English Prose* (with Mr Charles Whibley), 1804; the centenary Burns (with Mr T.F. Henderson) in 1896-1897, in which Henley's Essay (published separately 1898) roused considerable controversy. In 1892 he undertook for Mr Nutt the general editorship of the *Tudor Translations*; and in 1897 began for Mr Heinemann an edition of Byron; which did not proceed beyond one volume of letters. In 1898 he published a collection of his *Poems* in one volume, with the autobiographical "advertisement" above quoted; in 1899 *London Types*, Quotations to accompany Mr William Nicolson's designs; and in 1900 during the Boer War, a patriotic poetical brochure, *For England's Sake*. In 1901 he published a second volume of collected poetry with the title *Havethorn and Lavender*, uniform with the volume of 1898. In 1902 he collected his various articles on painters and artists and published them as a companion volume of *Views and Reviews: Art*. These with "A Song of Speed" printed in May 1903 within two months of his death make up his tale of work. At the close of his life he was engaged upon his edition of the Authorized Version of the Bible for his series of *Tudor Translations*. There remained uncollected some of his scattered articles in periodicals and reviews, especially the series of literary articles contributed to the *Pall Mall Magazine* from 1899 until his death. These contain the most outspoken utterances of a critic never mealy-mouthed, and include the splenetic attack on the memory of his dead friend R. L. Stevenson, which aroused deep regret and resentment. In 1894 Henley lost his little six-year-old daughter Margaret; he had borne the "bludgeonings of chance" with "the unconquerable soul" of which he boasted, not unjustifiably, in a well-known poem; but this blow broke his heart. With the knowledge of this fact, some of these outbursts may be better understood; yet we have the evidence of a clear-eyed critic who knew Henley well, that he found him more generous, more sympathetic at the close of his life than he had been before. He died on the 11th of July 1903. In spite of his too boisterous mannerism and prejudices, he exercised by his originality, independence and fearlessness an inspiring and inspiring influence on the higher class of journalism. This influence he exercised by word of mouth as well as by his pen, for he was a famous talker, and figures as "Burly" in Stevenson's essay on *Talk and Talkers*. As critic he was a good hater and a good fighter. His virtue lay in his vital and vitalizing love of good literature, and the vivid and pictorial phrases he found to give it expression. But his fame must rest on his poetry. He excelled alike in his delicate experiments in complicated metres, and the strong impressionism of *Hospital Sketches* and *London Voluntaries*. The influence of Heine may be discerned in these "unrhymed rhythms"; but he was perhaps a truer and more successful disciple of Heine in his snatches of passionate song, the best of which should retain their place in English literature.

See also references in *Stevenson's Letters: Cornhill Magazine* (1903) (Sidney Low); *Fortnightly Review* (August 1892) (Arthur Symonds); and for bibliography, *English Illustrated Magazine*, vol. xxix. p. 348. (W. F. J.)

HENLEY-ON-THAMES, a market town and municipal borough in the Henley parliamentary division of Oxfordshire, England, on the left bank of the Thames, the terminus of a branch of the Great Western railway, by which it is 35½ m. W. of London, while it is 5½ m. by river. Pop. (1901) 5984. It occupies one of the most beautiful situations on the Thames, at the foot of the finely wooded Chiltern Hills. The river is crossed by an elegant stone bridge of five arches, constructed in 1786. The parish church (Decorated and Perpendicular) possesses a lofty tower of intermingled flint and stone, attributed to Cardinal Wolsey, but more probably erected by Bishop Longland. The grammar school, founded in 1605, is incorporated with a Blue Coat school. Henley is a favourite summer resort, and is celebrated for the annual Henley Royal Regatta, the principal gathering of amateur oarsmen in England, first held

in 1839 and usually taking place in July. Henley is governed by a mayor, 4 aldermen and 12 councillors. Area, 540 acres.

Henley-on-Thames (Hanlegang, Henle, Handley), not mentioned in Domesday, was a manor or ancient demesne of the crown and was granted (1337) to John de Molyms, whose family held it for about 250 years. It is said that members for Henley sat in parliaments of Edward I. and Edward III., but no writs have been found. Henry VIII. having granted the use of the titles "mayor" and "burgess," the town was incorporated in 1570-1571 by the name of the warden, portreeves, burgesses and commonalty. Henley suffered from both parties in the Civil War. William III. on his march to London (1688) rested here and received a deputation from the Lords. The period of prosperity in the 17th and 18th centuries was due to manufactures of glass and mail, and to trade in corn and wool. The existing Thursday market was granted by a charter of John and the existing Corpus Christi fair by a charter of Henry VI.

See J. S. Burn, *History of Henley-on-Thames* (London, 1861).

HENNA, the Persian name for a small shrub found in India, Persia, the Levant and along the African coasts of the Mediterranean, where it is frequently cultivated. It is the *Lawsomia alba* of botanists, and from the fact that young trees are spineless, while older ones have the branchlets hardened into spines, it has also received the names of *Lawsomia tinawiti* and *L. spinosa*. It forms a slender shrubby plant of from 8 to 10 ft. high, with opposite lance-shaped smooth leaves, which are entire at the margins, and bears small white four-petalled sweet-scented flowers disposed in panicles. Its Egyptian name is *Khenna*, its Arabic name *Al Khanna*, its Indian name *Menda*, while in England it is called *Egyptian priest*, and in the West Indies, where it is naturalized, *Jamaica misnonette*.

Henna or Henné is of ancient repute as a cosmetic. This consists of the leaves of the *Lawsomia* powdered and made up into a paste; this is employed by the Egyptian women, and also by the Mahomedan women in India, to dye their finger-nails and other parts of their hands and feet of an orange-red colour, which is considered to add to their beauty. The colour lasts for three or four weeks, when it requires to be renewed. It is moreover used for dyeing the hair and beard, and even the manes of horses; and the same material is employed for dyeing skins and morocco-leather a reddish-yellow, but it contains no tannin. The practice of dyeing the nails was common amongst the Egyptians, and not to conform to it would have been considered indecent. It has descended from very remote ages, as is proved by the evidence afforded by Egyptian mummies, the nails of which are most commonly stained of a reddish hue. Henna is also said to have been held in repute amongst the Hebrews, being considered to be the plant referred to as camphire in the Bible (Song of Solomon i. 14, iv. 13). "The custom of dyeing the nails and palms of the hands and soles of the feet of an iron-rust colour with henna," observes Dr J. Forbes Royle, "exists throughout the East from the Mediterranean to the Ganges, as well as in northern Africa. In some parts the practice is not confined to women and children, but is also followed by men, especially in Persia. In dyeing the beard the hair is turned to red by this application, which is then changed to black by a preparation of indigo. In dyeing the hair of children, and the tails and manes of horses and asses, the process is allowed to stop at the red colour which the henna produces." Mahomet, it is said, used henna as a dye for his beard, and the fashion was adopted by the caliphs. "The use of henna," remarks Lady Callcott in her *Scripture Herbal*, "is scarcely to be called a caprice in the East. There is a quality in the drug which gently restrains perspiration in the hands and feet, and produces an agreeable coolness equally conducive to health and comfort." She further suggests that if the Jewish women were not in the habit of using this dye before the time of Solomon, it might probably have been introduced amongst them by his wife, the daughter of Pharaoh, and traces to this probability the allusion to "camphire" in the passages in Canticles above referred to.

The preparation of henna consists in reducing the leaves and young twigs to a fine powder, catechu or lucerne leaves

in a pulverized state being sometimes mixed with them. When required for use, the powder is made into a pasty mass with hot water, and is then spread upon the part to be dyed, where it is generally allowed to remain for one night. According to Lady Callcott, the flowers are often used by the Eastern women to adorn their hair. The distilled water from the flowers is used as a perfume.

HENNEBONT, a town of western France, in the department of Morbihan, 6m. N.E. of Lorient by road. Pop. (1906) 7250. It is situated about 10 m. from the mouth of the Blavet, which divides it into two parts—the *Ville Close*, the medieval military town, and the *Ville Neuve* on the left bank and the *Vieille Ville* on the right bank. The *Ville Close*, surrounded by ramparts and entered by a massive gateway flanked by machicolated towers, consists of narrow quiet streets bordered by houses of the 16th and 17th centuries. The *Ville Neuve*, which lies nearer the river, developed during the 17th century and later than the *Ville Close*, while the *Vieille Ville* is older than either. The only building of architectural importance is the church of Notre-Dame de Paradis (16th century) preceded by a tower with an ornamented stone spire. There are scanty remains of the old fortress. Hennebont has a small but busy river-port accessible to vessels of 200 to 300 tons. An important foundry in the environs of the town employs 1400 work-people in the manufacture of tin-plate for sardine boxes and other purposes. Boat-building, tanning, distilling and the manufacture of earthenware, white lead and chemical manures are also carried on. Granite is worked in the neighbourhood. Hennebont is famed for the resistance which it made, under the widow of Jean de Montfort, when besieged in 1342 by the armies of Philip of Valois and Charles of Blois during the War of the Succession in Brittany (see BRITTANY).

HENNEQUIN, PHILIPPE AUGUSTE (1763-1833), French painter, was a pupil of David. He was born at Lyons in 1763, distinguished himself early by winning the "Grand Prix," and left France for Italy. The disturbances at Rome, during the course of the Revolution, obliged him to return to Paris, where he executed the Federation of the 14th of July, and he was at work on a large design commissioned for the town-hall of Lyons, when in July 1794 he was accused before the revolutionary tribunal and thrown into prison. Hennequin escaped, only to be anew accused and imprisoned in Paris, and after running great danger of death, seems to have devoted himself thenceforth wholly to his profession. At Paris he finished the picture ordered for the municipality of Lyons, and in 1801 produced his chief work, "Orestes pursued by the Furies" (Louvre, engraved by Landon, *Annales du Musée*, vol. i. p. 105). He was one of the four painters who competed when in 1802 Gros carried off the official prize for a picture of the Battle of Nazareth, and in 1808 Napoleon himself ordered Hennequin to illustrate a series of scenes from his German campaigns, and commanded that his picture of the "Death of General Salomon" should be engraved. After 1815 Hennequin retired to Liège, and there, aided by subventions from the Government, carried out a large historical picture of the "Death of the Three Hundred in defence of Liège"—a sketch of which he himself engraved. In 1824 Hennequin settled at Tournay, and became director of the academy; he exhibited various works at Lille in the following year, and continued to produce actively up to the day of his death in May 1833.

HENNER, JEAN JACQUES (1829-1905), French painter, was born on the 5th of March 1829 at Dornach (Alsace). At first a pupil of Drolling and of Picot, he entered the École des Beaux-Arts in 1848, and took the Prix de Rome with a painting of "Adam and Eve finding the Body of Abel" (1858). At Rome he was guided by Flandrin, and, among other works, painted four pictures for the gallery at Colmar. He first exhibited at the Salon in 1863 a "Bather Asleep," and subsequently contributed "Chaste Susanna" (1865); "Byblis turned into a Spring" (1867); "The Magdalene" (1878); "Portrait of M. Hayem" (1878); "Christ Entombed" (1879); "Saint Jerome" (1881); "Herodias" (1887); "A Study" (1891); "Christ in His Shroud," and a "Portrait of Carolus-Duran" (1896); a "Portrait

of Mlle Fouquier" (1897); "The Levite of the Tribe of Ephraim" (1898), for which a first-class medal was awarded to him; and "The Dream" (1900). Among other professional distinctions Henner also took a Grand Prix for painting at the Paris International Exhibition of 1900. He was made Knight of the Legion of Honour in 1873, Officer in 1878 and Commander in 1889. In 1889 he succeeded Cabanel in the Institut de France.

See E. Bricon, *Psychologie d'art* (Paris, 1900); C. Phillips, *Art Journal* (1888); F. Wedmore, *Magazines of Art* (1888).

HENRIETTA MARIA (1600-1666), queen of Charles I. of England, born on the 25th of November 1600, was the daughter of Henry IV. of France. When the first serious overtures for her hand were made on behalf of Charles, prince of Wales, in the spring of 1624, she was little more than fourteen years of age. Her brother, Louis XIII., only consented to the marriage on the condition that the English Roman Catholics were relieved from the operation of the penal laws. When therefore she set out for her new home in June 1625, she had already pledged the husband to whom she had been married by proxy on the 1st of May to a course of action which was certain to bring unpopularity on him as well as upon herself.

That husband was now king of England. The early years of the married life of Charles I. were most unhappy. He soon found an excuse for breaking his promise to relieve the English Catholics. His young wife was deeply offended by treatment which she naturally regarded as unhandsome. The favourite Buckingham stirred the flames of his master's discontent. Charles in vain strove to reduce her to tame submission. After the assassination of Buckingham in 1628 the barrier between the married pair was broken down, and the bond of affection which from that moment united them was never loosened. The children of the marriage were Charles II. (b. 1630), Mary, princess of Orange (b. 1631), James II. (b. 1633), Elizabeth (b. 1636), Henry, duke of Gloucester (b. 1640), and Henrietta, duchess of Orleans (b. 1644).

For some years Henrietta Maria's chief interests lay in her young family, and in the amusements of a gay and brilliant court. She loved to be present at dramatic entertainments, and her participation in the private rehearsals of the *Shepherd's Pastoral*, written by her favourite Walter Montague, probably drew down upon her the savage attack of Prynne. With political matters she hardly meddled as yet. Even her co-religionists found little aid from her till the summer of 1637. She had then recently opened a diplomatic communication with the see of Rome. She appointed an agent to reside at Rome, and a papal agent, a Scotsman named George Conn, accredited to her, was soon engaged in effecting conversions amongst the English gentry and nobility. Henrietta Maria was well pleased to become a patroness of so holy a work, especially as she was not asked to take any personal trouble in the matter. Protestant England took alarm at the proceedings of a queen who associated herself so closely with the doings of "the grim wolf with privy paw."

When the Scottish troubles broke out, she raised money from her fellow-Catholics to support the king's army on the borders in 1639. During the session of the Short Parliament in the spring of 1640, the queen urged the king to oppose himself to the House of Commons in defence of the Catholics. When the Long Parliament met, the Catholics were believed to be the authors and agents of every arbitrary scheme which was supposed to have entered into the plans of Strafford or Laud. Before the Long Parliament had sat for two months, the queen was urging upon the pope the duty of lending money to enable her to restore her husband's authority. She threw herself heart and soul into the schemes for rescuing Strafford and coercing the parliament. The army plot, the scheme for using Scotland against England, and the attempt upon the five members were the fruits of her political activity.

In the next year the queen effected her passage to the Continent. In February 1643 she landed at Burlington Quay, placed herself at the head of a force of loyalists, and marched through England to join the king near Oxford. After little more than a year's residence there, on the 3rd of April 1644, she left her husband,

to see his face no more. Henrietta Maria found a refuge in France. Richelieu was dead, and Anne of Austria was compassionate. As long as her husband was alive the queen never ceased to encourage him to resistance.

During her exile in France she had much to suffer. Her husband's execution in 1649 was a terrible blow. She brought up her youngest child Henrietta in her own faith, but her efforts to induce her youngest son, the duke of Gloucester, to take the same course only produced discomfort in the exiled family. The story of her marriage with her attached servant Lord Jermyn needs more confirmation than it has yet received to be accepted, but all the information which has reached us of her relations with her children points to the estrangement which had grown up between them. When after the Restoration she returned to England, she found that she had no place in the new world. She received from parliament a grant of £30,000 a year in compensation for the loss of her dower-lands, and the king added a similar sum as a pension for himself. In January 1661 she returned to France to be present at the marriage of her daughter Henrietta to the duke of Orleans. In July 1662 she set out again for England, and took up her residence once more at Somerset House. Her health failed her, and on the 24th of June 1665, she departed in search of the clearer air of her native country. She died on the 31st of August 1666, at Colombes, not far from Paris.

See I. A. Taylor, *The Life of Queen Henrietta Maria* (1908).

HENRY (Fr. *Henri*; Span. *Enrique*; Ger. *Hainrich*; Mid. H. Ger. *Heinrich* and *Heimrich*; O.H.G. *Heimi-* or *Heimrich*, *is.* "prince, or chief of the house," from O.H.G. *heim*, the Eng. *home*, and *rih*, Goth. *reiks*; compare Lat. *rex* "king"—"rich," therefore "mighty," and so "a ruler." Compare Sans. *ráditi* "to shine forth, rule, &c." and mod. *raj* "rule" and *raja*, "king"), the name of many European sovereigns, the more important of whom are noticed below in the following order: (1) emperors and German kings; (2) kings of England; (3) other kings in the alphabetical order of their states; (4) other reigning princes in the same order; (5) non-reigning princes; (6) bishops, nobles, chroniclers, &c.

HENRY I. (c. 876-936), surnamed the "Fowler," German king, son of Otto the Illustrious, duke of Saxony, grew to manhood amid the disorders which witnessed to the decay of the Carolingian empire, and in early life shared in various campaigns for the defence of Saxony. He married Hatburg, a daughter of Irwin, count of Merseburg, but as she had taken the veil on the death of a former husband this union was declared illegal by the church, and in 909 he married Matilda, daughter of a Saxon count named Thiederich, and a reputed descendant of the hero Widukind. On his father's death in 912 he became duke of Saxony, which he ruled with considerable success, defending it from the attacks of the Slavs and resisting the claims of the German king Conrad I. (see SAXONY). He afterwards won the esteem of Conrad to such an extent that in 918 the king advised the nobles to make the Saxon duke his successor. After Conrad's death the Franks and the Saxons met at Fritzlar in May 919 and chose Henry as German king, after which the new king refused to allow his election to be sanctioned by the church. His authority, save in Saxony, was merely nominal; but by negotiation rather than by warfare he secured a recognition of his sovereignty from the Bavarians and the Swabians. A struggle soon took place between Henry and Charles III., the Simple, king of France, for the possession of Lorraine. In 921 Charles recognised Henry as king of the East Franks, and when in 923 the French king was taken prisoner by Herbert, count of Vermandois, Lorraine came under Henry's authority, and Gisilbert, who married his daughter Gerberga; was recognized as duke. Turning his attention to the east, Henry reduced various Slavonic tribes to subjection, took Brennabor, the modern Brandenburg, from the Hevelli, and secured both banks of the Elbe for Saxony. In 923 he had bought a truce for ten years with the Hungarians, by a promise of tribute, but on its expiration he gained a great victory over these formidable foes in March 933. The Danes were defeated, and territory as far as the Elbe secured for Germany; and the king sought further to extend his influence by entering into relations with the kings

of England, France and Burgundy. He is said to have been contemplating a journey to Rome, when he died at M'embleben on the 2nd of July 936, and was buried at Quedlinburg. By his first wife, Hatburg, he left a son, Thankmar, who was excluded from the succession as illegitimate; and by Matilda he left three sons, the eldest of whom; Otto (afterwards the emperor Otto the Great), succeeded him, and two daughters. Henry was a successful ruler, probably because he was careful to undertake only such enterprises as he was able to carry through. Laying more stress on his position as duke of Saxony than king of Germany, he conferred great benefits on his duchy. The founder of her town life and the creator of her army, he ruled in harmony with her nobles and secured her frontiers from attack. The story that he received the surname of "Fowler" because the nobles, sent to inform him of his election to the throne, found him engaged in laying snares for the birds, appears to be mythical.

See Widukind of Corvei, *Res gestae Saxonicae*, edited by G. Waitz in the *Monumenta Germaniae historica. Scriptores*, Band iii. (Hanover and Berlin, 1826 seq.); "Die Urkunde des deutschen Königs Heinrichs I.," edited by T. von Sicking in the *Monumenta Germaniae historica. Diplomata* (Hanover, 1879); W. von Giesebrecht, *Geschichte der deutschen Kaiserzeit*, Bände i. u. (Leipzig, 1881); G. Waitz, *Jahrbücher des deutschen Reichs unter König Heinrich I.* (Leipzig, 1885); and F. Löher, *Die deutsche Politik König Heinrich I.* (Munich, 1857).

HENRY II. (973-1024), surnamed the "Saint," Roman emperor, son of Henry II., the Quarrelsome, duke of Bavaria, and Gisela, daughter of Conrad, king of Burgundy, or Arles (d. 993), and great-grandson of the German king Henry I., the Fowler, was born on the 6th of May 973. When his father was driven from his duchy in 976 it was intended that Henry should take holy orders, and he received the earlier part of a good education at Hildesheim. This idea, however, was abandoned when his father was restored to Bavaria in 985; but young Henry, whose education was completed at Regensburg, retained a lively interest in ecclesiastical affairs. He became duke of Bavaria on his father's death in 995, and appears to have governed his duchy quietly and successfully for seven years. He showed a special regard for monastic reform and church government, accompanied his kinsman, the emperor Otto III., on two occasions to Italy, and about 1001 married Kunigunde (d. 1037), daughter of Siegfried, count of Luxemburg. When Otto III. died childless in 1002, Henry sought to secure the German throne, and seizing the imperial insignia made an arrangement with Otto I., duke of Carinthia. There was considerable opposition to his claim; but one rival, Ekkard I., margrave of Meissen, was murdered, and, hurrying to Mainz, Henry was chosen German king by the Franks and Bavarians on the 7th of June 1002, and subsequently crowned by Willigis, archbishop of Mainz, who had been largely instrumental in securing his election. Having ravaged the lands of another rival, Hermann II., duke of Swabia, Henry purchased the allegiance of the Thuringians and the Saxons; and when shortly afterwards the nobles of Lorraine did homage and Hermann of Swabia submitted, he was generally recognized as king. Danger soon arose from Boleslaus I., the Great, king of Poland, who had extended his authority over Meissen and Lusatia, seized Bohemia; and allied himself with some discontented German nobles, including the king's brother, Bruno, bishop of Augsburg. Henry easily crushed his domestic foes; but the incipient war with Boleslaus was abandoned in favour of an expedition into Italy, where Arduin, margrave of Ivrea, had been elected king. Crossing the Alps Henry met with no resistance from Arduin, and in May 1004 he was chosen and crowned king of the Lombards at Pavia; but a tumult caused by the presence of the Germans soon arose in the city, and having received the homage of several cities of Lombardy the king returned to Germany. He then freed Bohemia from the rule of the Poles, led an expedition into Friesland, and was successful in compelling Boleslaus to sue for peace in 1005. A struggle with Baldwin IV., count of Flanders, in 1006 and 1007 was followed by trouble with the king's brothers-in-law, Dietrich and Adalbero of Luxemburg, who had seized respectively the bishopric of Metz and the

archbishopric of Trier (Treves). Henry sought to dislodge them, but aided by their elder brother Henry, who had been made duke of Bavaria in 1004, they held their own in a desultory warfare in Lorraine. In 1009, however, the eldest of the three brothers was deprived of Bavaria, while Adalbero had in the previous year given up his claim to Trier, but Dietrich retained the bishopric of Metz. The Polish war had been renewed in 1007, but it was not until 1010 that the king was able to take a personal part in these campaigns. Meeting with indifferent success, he made peace with Boleslaus early in 1013, when the duke retained Lusatia, but did homage to Henry at Merseburg.

In 1013 the king made a second journey to Italy where two popes were contending for the papal chair, and meeting with no opposition was received with great honour at Rome. Having recognized Benedict VIII. as the rightful pope, he was crowned emperor on the 14th of February 1014, and soon returned to Germany laden with treasures from Italian cities. But the struggle with the Poles now broke out afresh, and in 1015 and 1017 the king, having obtained assistance from the heathen Lütici, led formidable armies against Boleslaus. During the campaign of 1017 he had as an ally the grand duke of Russia, but his troops suffered considerable loss, and on the 30th of January 1018 he made peace at Bautzen with Boleslaus, who again retained Lusatia. As early as 1006 Henry had concluded a succession treaty with his uncle Rudolph III., the childless king of Burgundy, or Arles; but when Rudolph desired to abdicate in 1016 Henry's efforts to secure possession of the territory were foiled by the resistance of the nobles. In 1020 the emperor was visited at Bamberg by Pope Benedict, in response to whose entreaty for assistance against the Greeks of southern Italy he crossed the Alps in 1021 for the third and last time. With the aid of the Normans he captured many fortresses and seriously crippled the power of the Greeks, but was compelled by the ravages of pestilence among his troops to return to Germany in 1022. It was probably about this time that Henry gave Benedict the diploma which ratified the gifts made by his predecessors to the papacy. Spending his concluding years in disputes over church reform he died on the 13th of July 1024 at Grona near Göttingen, and was buried at Bamberg, where he had founded and richly endowed a bishopric.

Henry was an enthusiast for church reform, and under the influence of his friend Odilo, abbot of Cluny, sought to further the principles of the Cluniacs, and seconded the efforts of Benedict VIII. to prevent the marriage of the clergy and the sale of spiritual dignities. He was energetic and capable, but except in his relations with the church was not a strong ruler. But though devoted to the church and a strict observer of religious rites, he was by no means the slave of the clergy. He appointed bishops without the formality of an election, and attacked clerical privileges although he made clerics the representatives of the imperial power. He held numerous diets and issued frequent ordinances for peace, but feuds among the nobles were common, and the frontiers of the empire were insecure. Henry, who was the last emperor of the Saxon house, was the first to use the title "King of the Romans." He died childless, and a tradition of the 12th century says he and his wife took vows of chastity. He was canonized in 1146 by Pope Eugenius III.

See Adalbold of Utrecht, *Vita Heinrici II.*, Thietmar of Merseburg, *Chronicon*, both in the *Monumenta Germaniae historica*, *Scriptores*, Bände iii. and iv. (Hanover and Berlin, 1826 seq.); W. von Giesebrecht, *Geschichte der deutschen Kaiserzeit* (Leipzig, 1881-1890); S. Hirsch, continued by R. Usinger, H. Fabst and H. Bresslau, *Jahrbücher des deutschen Reichs unter Kaiser Heinrich II.* (Leipzig, 1874); A. Cohn, *Kaiser Heinrich II.* (Halle, 1867); H. Zeissberg, *Die Kriege Kaiser Heinrichs II. mit Boleslaw I. von Polen* (Vienna, 1868); and G. Matthaei, *Die Klosterpolitik Kaiser Heinrichs II.* (Göttingen, 1877).

HENRY III. (1017-1056), surnamed the "Black," Roman emperor, only son of the emperor Conrad II., and Gisela, widow of Ernest I., duke of Swabia, was born on the 28th of October 1017, designated as his father's successor in 1026, and crowned German king at Aix-la-Chapelle by Pilgrim, archbishop of Cologne, on the 14th of April 1028. In 1027 he was appointed

duke of Bavaria, and his early years were mainly spent in this country, where he received an excellent education under the care of Bruno, bishop of Augsburg and, afterwards, of Egilbert, bishop of Freising. He soon began to take part in the business of the empire. In 1032 he took part in a campaign in Burgundy; in 1033 led an expedition against Ulrich, prince of the Bohemians; and in June 1036 was married at Nijmwegen to Gunhilda, afterwards called Kunigunde, daughter of Canute, king of Denmark and England. In 1038 he followed his father to Italy, and in the same year the emperor formally handed over to him the kingdom of Burgundy, or Arles, and appointed him duke of Swabia. In spite of the honours which Conrad heaped upon Henry the relations between father and son were not uniformly friendly, as Henry disapproved of the emperor's harsh treatment of some of his allies and adherents. When Conrad died in June 1039, Henry became sole ruler of the empire, and his authority was at once recognized in all parts of his dominions. Three of the duchies were under his direct rule, no rival appeared to contest his claim, and the outlying parts of the empire, as well as Germany, were practically free from disorder. This peaceful state of affairs was, however, soon broken by the ambition of Bretislaus, prince of the Bohemians, who revived the idea of an independent Slavonic state, and conquered various Polish towns. Henry took up arms, and having suffered two defeats in 1040 renewed the struggle with a stronger force in the following year, when he compelled Bretislaus to sue for peace and to do homage for Bohemia at Regensburg. In 1042 he received the homage of the Burgundians and his attention was then turned to the Hungarians, who had driven out their king Peter, and set up in his stead one Aba Samuel, or Ovo, who attacked the eastern border of Bavaria.

In 1043 and the two following years Henry crushed the Hungarians, restored Peter, and brought Hungary completely under the power of the German king. In 1038 Queen Kunigunde had died in Italy, and in 1043 the king was married at Ingelheim to Agnes, daughter of William V., duke of Guienne, a union which drew him much nearer to the reforming party in the church. In 1044 Gothelon (Gozelo), duke of Lorraine, died, and some disturbance arose over Henry's refusal to grant the whole of the duchy to his son Godfrey, called the Bearded. Godfrey took up arms, but after a short imprisonment was released and confirmed in the possession of Upper Lorraine in 1046 which, however, he failed to secure. About this time Henry was invited to Italy where three popes were contending for power, and crossing the Alps with a large army he marched to Rome. Councils held at Sutri and at Rome having declared the popes deposed, the king secured the election of Suigger, bishop of Bamberg, who took the name of Clement II., and by this pontiff Henry was crowned as emperor on the 25th of December 1046. He was immediately recognized by the Romans as *Patricius*, an office which carried with it at this time the right to appoint the pope. Supreme in church and state alike, ruler of Germany, Italy and Burgundy, overlord of Hungary and Bohemia, Henry occupied a commanding position, and this time may be regarded as marking the apogee of the power of the Roman empire of the Germans. The emperor assisted Pope Clement in his efforts to banish simony. He made a victorious progress in southern Italy, where he restored Pandolph IV. to the principality of Capua, and asserted his authority over the Normans in Apulia and Aversa. Returning to Germany, in 1047 he appointed two popes, Damasus II. and Leo IX., in quick succession, and turned to face a threatening combination in the west of the empire, where Godfrey of Lorraine was again in revolt, and with the help of Baldwin V., count of Flanders and Dirk IV., count of Holland, who had previously caused trouble to Henry, was ravaging the lands of the emperor's representatives in Lorraine. Assisted by the kings of England and Denmark, Henry succeeded with some difficulty in bringing the rebels to submission in 1050. Godfrey was deposed; but Baldwin soon found an opportunity for a further revolt, which an expedition undertaken by the emperor in 1054 was unable to crush.

Meanwhile a reaction against German influence had taken place in Hungary. King Peter had been driven out in 1046 and his place taken by Andreas I. Inroads into Bavaria followed, and in 1051 and 1052 Henry led his forces against the Hungarians, and after the pope had vainly attempted to mediate, peace was made in 1053. It was quickly broken, however, and the emperor, occupied elsewhere, soon lost most of his authority in the east; although in 1054 he made peace between Bratislav of Bohemia and Casimir I, duke of the Poles. Henry had not lost sight of affairs in Italy during these years, and had received several visits from the pope, whose aim was to bring southern Italy under his own dominion. Henry had sent military assistance to Leo, and had handed over to him the government of the principality of Benevento in return for the bishopric of Bamberg. But the pope's defeat by the Normans was followed by his death: Henry then nominated Gebhard, bishop of Eichstätt, who took the name of Victor II., to the vacant chair, and promised his assistance to the reluctant candidate. In 1055 the emperor went a second time to Italy, where his authority was threatened by Godfrey of Lorraine, who had married Beatrice, widow of Boniface III., margrave of Tuscany, and was ruling her vast estates. Godfrey died, however, on the appearance of Henry, who only remained a short time in Italy, during which he granted the duchy of Spoleto to Pope Victor, and negotiated for an attack upon the Normans. Before the journey to Italy, Henry had found it necessary to depose Conrad III., duke of Bavaria, and to suppress a rising in southern Germany. During his absence Conrad formed an alliance with Welf, duke of Carinthia, and Gebhard III., bishop of Regensburg. A conspiracy to depose the emperor, support for which was found in Lorraine, was quickly discovered, and Henry, leaving Victor as his representative in Italy, returned in 1055 to Germany to receive the submission of his foes. In 1056, the emperor was visited by the pope; and on the 5th of October in the same year he died at Bodfeld and was buried at Spire. Henry was a pious and peace-loving prince, who favoured church reform, sought earnestly to suppress private warfare, and alone among the early emperors is said to have been innocent of simony. Although under his rule Germany enjoyed considerable tranquillity, and a period of wealth and progress set in for the towns, yet his secular and ecclesiastical policy showed signs of weakness. Unable, or unwilling, seriously to curb the increasing power of the church, he alienated the sympathies of the nobles as a class, and by allowing the southern duchies to pass into other hands restored a power which true to its traditions was not always friendly to the royal house. Henry was a patron of learning, a founder of schools, and built or completed cathedrals at Spire, Worms and Mainz.

The chief original authorities for the life and reign of Henry III. are the *Chronicon* of Herimann of Reichenau, the *Annales Sangallenses majores*, the *Annales Hildeshaimenses*, all in the *Monumenta Germaniae historica. Scriptores* (Hanover and Berlin, 1826 fol.). The best modern authorities are W. von Giesbrecht, *Geschichte der deutschen Kaiserzeit*, Band ii. (Leipzig, 1888); M. Perlbach, "Die Kriege Heinrichs III. gegen Böhmen," in the *Forschungen zur deutschen Geschichte*, Band x. (Göttingen, 1862-1886); E. Steindorff, *Jahrbücher des deutschen Reichs unter Heinrich III.* (Leipzig, 1874-1881); and F. Steinhoff, *Das Königthum und Kaiserthum Heinrichs III.* (Göttingen, 1865).

HENRY IV. (1050-1106), Roman emperor, son of the emperor Henry III. and Agnes, daughter of William V., duke of Guienne, was born on the 21th of November 1050, chosen German king at Tribur in 1053, and crowned at Aix-la-Chapelle on the 17th of July 1054. In 1055 he was appointed duke of Bavaria, and on his father's death in October 1056 inherited the kingdoms of Germany, Italy and Burgundy. These territories were governed in his name by his mother, who was unable to repress the internal disorder or to take adequate measures for their defence. Some opposition was soon aroused, and in 1062 Anno, archbishop of Cologne, and others planned to seize the person of the young king and to deprive Agnes of power. This plot met with complete success. Henry, who was at Kaiserwerth, was persuaded to board a boat lying in the Rhine; it was

immediately unmoored and the king sprang into the stream, but was rescued by one of the conspirators and carried to Cologne. Agnes made no serious effort to regain her control, and the chief authority was exercised for a time by Anno; but his rule proved unpopular, and he was soon compelled to share his power with Adalbert, archbishop of Bremen. The education and training of Henry were supervised by Anno, who was called his *magister*, while Adalbert was styled *patronus*; but Anno was disliked by Henry, and during his absence in Italy the chief power passed into the hands of Adalbert. Henry's education seems to have been neglected, and his wilful and headstrong nature was developed by the conditions under which his early years were passed. In March 1063 he was declared of age, and in the following year a powerful coalition of ecclesiastical and lay nobles brought about the banishment of Adalbert from court and the return of Anno to power. In 1066 Henry was persuaded to marry Bertha, daughter of Otto, count of Savoy, to whom he had been betrothed since 1055. For some time he regarded his wife with strong dislike and sought in vain for a divorce, but after she had borne him a son in 1071 she gained his affections, and became his most trusted friend and companion.

In 1069 the king took the reins of government into his own hands. He recalled Adalbert to court; led expeditions against the Liutici, and against Dedo or Dedi II., margrave of a district east of Saxony; and soon afterwards quarrelled with Rudolph, duke of Swabia, and Berthold, duke of Carinthia. Much more serious was Henry's struggle with Otto of Nordheim, duke of Bavaria. This prince, who occupied an influential position in Germany, was accused in 1070 by a certain Egino of being privy to a plot to murder the king. It was decided that a trial by battle should take place at Goslar, but when the demand of Otto for a safe conduct for himself and his followers, to and from the place of meeting, was refused, he declined to appear. He was thereupon declared deposed in Bavaria, and his Saxon estates were plundered. He obtained sufficient support, however, to carry on a struggle with the king in Saxony and Thuringia until 1072, when he submitted at Halberstadt. Henry aroused the hostility of the Thuringians by supporting Siegfried, archbishop of Mainz, in his efforts to exact tithes from them; but still more formidable was the enmity of the Saxons, who had several causes of complaint against the king. He was the son of one enemy, Henry III., and the friend of another, Adalbert of Bremen. He had ordered a restoration of all crown lands in Saxony and had built forts among this people, while the country was ravaged to supply the needs of his courtiers, and its duke Magnus was a prisoner in his hands. All classes were united against him, and when the struggle broke out in 1073 the Thuringians joined the Saxons; and the war, which lasted with slight intermissions until 1088, exercised a most potent influence upon Henry's fortunes elsewhere (see SAXONY).

Henry soon found himself confronted by an abler and more stubborn antagonist than either Thuringian or Saxon. In 1073 Hildebrand became pope as Gregory VII. Two years later this great ecclesiastic issued his memorable prohibition of lay investiture, and the blow then struck at the secular power by the papacy threatened seriously to undermine the imperial authority. Spurred on by his advisers, Henry did not refuse the challenge. Threatened with the papal ban, he summoned a synod of German bishops which met at Worms in January 1076 and declared Gregory deposed; and he wrote his famous letter to the pope, in which he referred to him as "not pope, but false monk." The king was at once excommunicated. His adherents gradually fell away, the Saxons were again in arms, and Otto of Nordheim succeeded in uniting the malcontents of north and south Germany. In October 1076 an important diet met at Tribur, and after discussing the deposition of the king, decided that he should be judged by an assembly to be held at Augsburg in the following February under the presidency of the pope. This union of the temporal and spiritual forces was too strong for the king, and he decided to submit.

Crossing the Alps, Henry appeared in January 1077 as a penitent before the castle of Canossa, where Gregory had taken

refuge. The story of this famous occurrence, which represents the king standing in the courtyard of the castle for three days in the snow, clad as a penitent, and entreating to be admitted to the pope's presence, is now regarded as mythical in its details; but there is no doubt that the king visited the castle at intervals, and prayed for admission for three days until the 28th of January, when he was received by Gregory and absolved, after promising to submit to the pope's authority and to secure for him a safe journey to Germany. No historical incident has more profoundly impressed the imagination of the Western world. It marked the highest point reached by papal authority, and presents a vivid picture of the awe inspired during the middle ages by the supernatural powers supposed to be wielded by the church.

Scorned by his Lombard allies, Henry left Italy to find that in his absence Rudolph, duke of Swabia, had been chosen German king; and although Gregory had taken no part in this election, Henry sought to prevent the pope's journey to Germany, and regaining courage, tried to recover his former position. Supported by most of the German bishops and by the Lombards, now reconciled to him, and recognized in Burgundy, Bavaria and Franconia, Henry (who at this time is referred to by Bruno, the author of *De bello Saxonico*, as *rex*) appeared stronger than his rival Rudolph; but the ensuing war was waged with varying success. He was beaten at Mellrichstadt in 1078, and at Flarchheim in 1080, but these defeats were due rather to the fierce hostility of the Saxons, and the military skill of Otto of Nordheim, than to any general sympathy with Rudolph. Gregory's attitude remained neutral, in spite of appeals from both sides, until March 1080, when he again excommunicated Henry, but without any serious effect on the fortunes of the king: At Henry's initiative, Gregory was declared deposed on three occasions, and an anti-pope was elected in the person of Wibert, archbishop of Ravenna, who took the name of Clement III.

The death of Rudolph in October 1080, and a consequent lull in the war, enabled the king to go to Italy early in 1081. He found considerable support in Lombardy; placed Matilda, marchioness of Tuscany, the faithful friend of Gregory, under the imperial ban; took the Lombard crown at Pavia; and secured the recognition of Clement by a council. Marching to Rome, he undertook the siege of the city, but was soon compelled to retire to Tuscany, where he granted privileges to various cities, and obtained monetary assistance from a new ally, the eastern emperor, Alexius I. A second and equally unsuccessful attack on Rome was followed by a war of devastation in northern Italy with the adherents of Matilda; and towards the end of 1082 the king made a third attack on Rome. After a siege of seven months the Leonine city fell into his hands. A treaty was concluded with the Romans, who agreed that the quarrel between king and pope should be decided by a synod, and secretly bound themselves to induce Gregory to crown Henry as emperor, or to choose another pope. Gregory, however, shut up in the castle of St Angelo, would hear of no compromise; the synod was a failure, as Henry prevented the attendance of many of the pope's supporters; and the king, in pursuance of his treaty with Alexius, marched against the Normans. The Romans soon fell away from their allegiance to the pope; and, recalled to the city, Henry entered Rome in March 1084, after which Gregory was declared deposed and Clement was recognized by the Romans. On the 31st of March 1084 Henry was crowned emperor by Clement, and received the patrician authority. His next step was to attack the fortresses still in the hands of Gregory. The pope was saved by the advance of Robert Guiscard, duke of Apulia, with a large force, which compelled Henry to return to Germany.

Meanwhile the German rebels had chosen a fresh anti-king, Hermann, count of Luxemburg, whom Henry's supporters had already driven to his last line of defence in Saxony. During the campaign of 1086 Henry was defeated near Würzburg, but in 1088 Hermann abandoned the struggle and the emperor was generally recognized in Saxony, to which country he showed considerable clemency. Although Henry's power was in the ascendant, a few powerful nobles adhered to the cause of Gregory's

successor, Urban II. Among them was Welf, son of Welf I., the deposed duke of Bavaria, whose marriage with Matilda of Tuscany rendered him too formidable to be neglected. The emperor accordingly returned to Italy in 1090, where Mantua and Milan were taken, and Pope Clement was restored to Rome. Henry's communications with Germany were, however, threatened by a league of the Lombard cities, and his anxieties were soon augmented by domestic troubles.

Henry's first wife had died in 1087, and in 1089 he had married a Russian princess, Praxedis, afterwards called Adelaide. Her conduct soon aroused his suspicions, and his own eldest son, Conrad, who had been crowned German king in 1087, was thought to be a partner in her guilt. Escaping from prison, Adelaide fled to Henry's enemies and brought grave charges against her husband; while the papal party induced Conrad to desert his father and to be crowned king of Italy at Monza in 1093. Crushed by this blow, Henry remained almost helpless and inactive in northern Italy for five years, until 1097, when having lost every shred of authority in that country, he returned to Germany, where his position was stronger than ever. Welf had submitted, had forsaken the cause of Matilda and had been restored to Bavaria, and in 1098 the diet assembled at Mainz declared Conrad deposed, and chose the emperor's second son, Henry, afterwards the emperor Henry V., as German king. The crusade of 1096 had freed Germany from many turbulent spirits, and the emperor, meeting with some success in his efforts to restore order, could afford to ignore his repeated excommunication. A successful campaign in Flanders was followed in 1103 by a diet at Mainz, where serious efforts were made to restore peace, and Henry himself promised to go on crusade. But this plan was shattered by the revolt of the younger Henry in 1104, who, encouraged by the adherents of the pope, declared he owed no allegiance to an excommunicated father. Saxony and Thuringia were soon in arms, the bishops held mainly to the younger Henry, while the emperor was supported by the towns. A desultory warfare was unfavourable, however, to the emperor, who, deceived by false promises, became a prisoner in the hands of his son in 1105. The diet met at Mainz in December, when he was compelled to abdicate; but contrary to the conditions, he was detained at Ingelheim and denied his freedom. Escaping to Cologne, he found considerable support in the lower Rhineland; he entered into negotiations with England, France and Denmark, and was engaged in collecting an army when he died at Liège on the 7th of August 1106. His body was buried by the bishop of Liège with suitable ceremony, but by command of the papal legate it was unearthed, taken to Spire, and placed in an unconsecrated chapel. After being released from the sentence of excommunication the remains were buried in the cathedral of Spire in August 1117.

Henry IV. was very licentious and in his early years was careless and self-willed, but better qualities were developed in his later life. He displayed much diplomatic ability, and his abasement at Canossa may fairly be regarded as a move of policy to weaken the pope's position at the cost of a personal humiliation to himself. He was always regarded as a friend of the lower orders, was capable of generosity and gratitude, and showed considerable military skill. Unfortunate in the time in which he lived, and in the troubles with which he had to contend, he holds an honourable position in history as a monarch who resisted the excessive pretensions both of the papacy and of the ambitious feudal lords of Germany.

The authorities for the life and reign of Henry are Lambert of Hersfeld, *Annales*; Berold of Reichenau, *Chronicon*; Ekkehard of Aura, *Chronicon*; and Bruno, *De bello Saxonico*, which gives several of the more important letters that passed between Henry and Gregory VII. These are all found in the *Monumenta Germaniæ historica. Scriptores*, Bände v. and vi. (Hanover and Berlin, 1826-1892). There is an anonymous *Vita Heinrici IV.*, edited by W. Wattenbach (Hanover, 1876). The best modern authorities are: G. Meyer von Knonau, *Jahrbücher des deutschen Reiches unter Heinrich IV.* (Leipzig, 1890); H. Floto, *Kaiser Heinrich IV. und sein Zeitalter* (Stuttgart, 1895); E. Killan, *Itinær Kaiser Heinrichs IV.* (Karlsruhe, 1886); K. W. Nitzsch, "Das deutsche Reich und Heinrich IV.," in the *Historische Zeitschrift*, Band xlv. (Munich, 1859); H. Ulmann, *Zum Verständnis der sächsischen Erhebung gegen Heinrich IV.* (Hanover, 1886); W. von Giesebrecht, *Geschichte*

der deutschen Kaiserzeit (Leipzig, 1881-1890); B. Gebhardt, *Handbuch der deutschen Geschichte* (Berlin, 1901). For a list of other works, especially those on the relations between Henry and Gregory, see Dahlmann-Waltz, *Quellenkunde der deutschen Geschichte* (Göttingen, 1894). (A. W. H.)

HENRY V. (1081-1125), Roman emperor, son of the emperor Henry IV., was born on the 8th of January 1081, and after the revolt and deposition of his elder brother, the German king Conrad (d. 1101), was chosen as his successor in 1098. He promised to take no part in the business of the Empire during his father's lifetime, and was crowned at Aix-la-Chapelle on the 6th of January 1099. In spite of his oath Henry was induced by his father's enemies to revolt in 1104, and some of the princes did homage to him at Mainz in January 1106. In August of the same year the elder Henry died, when his son became sole ruler of the Empire. Order was soon restored in Germany, the citizens of Cologne were punished by a fine, and an expedition against Robert II., count of Flanders, brought this rebel to his knees. In 1107 a campaign, which was only partially successful, was undertaken to restore Bořivoj II. to the dukedom of Bohemia, and in the year following the king led his forces into Hungary, where he failed to take Pressburg. In 1109 he was unable to compel the Poles to renew their accustomed tribute, but in 1110 he succeeded in securing the dukedom of Bohemia for Ladislaus I.

The main interest of Henry's reign centres in the controversy over lay investiture, which had caused a serious dispute during the previous reign. The papal party who had supported Henry in his resistance to his father hoped he would assent to the decrees of the pope, which had been renewed by Paschal II. at the synod of Gaustalla in 1106. The king, however, continued to invest the bishops, but wished the pope to hold a council in Germany to settle the question. Paschal after some hesitation preferred France to Germany, and, after holding a council at Troyes, renewed his prohibition of lay investiture. The matter slumbered until 1110, when, negotiations between king and pope having failed, Paschal renewed his decrees and Henry went to Italy with a large army. The strength of his forces helped him to secure general recognition in Lombardy, and at Sutri he concluded an arrangement with Paschal by which he renounced the right of investiture in return for a promise of coronation, and the restoration to the Empire of all lands given by kings, or emperors, to the German church since the time of Charlemagne. It was a treaty impossible to execute, and Henry, whose consent to it is said to have been conditional on its acceptance by the princes and bishops of Germany, probably foresaw that it would occasion a breach between the German clergy and the pope. Having entered Rome and sworn the usual oaths, the king presented himself at St Peter's on the 12th of February 1114 for his coronation and the ratification of the treaty. The words commanding the clergy to restore the fiefs of the crown to Henry were read amid a tumult of indignation, whereupon the pope refused to crown the king, who in return declined to hand over his renunciation of the right of investiture. Paschal was seized by Henry's soldiers and, in the general disorder into which the city was thrown, an attempt to liberate the pontiff was thwarted in a struggle during which the king himself was wounded. Henry then left the city carrying the pope with him; and Paschal's failure to obtain assistance drew from him a confirmation of the king's right of investiture and a promise to crown him emperor. The coronation ceremony accordingly took place on the 23th of April 1114, after which the emperor returned to Germany, where he sought to strengthen his power by granting privileges to the inhabitants of the region of the upper Rhine.

In 1112 Lothair, duke of Saxony, rose in arms against Henry, but was easily quelled. In 1113, however, a quarrel over the succession to the counties of Weimar and Orlamünde gave occasion for a fresh outbreak on the part of Lothair, whose troops were defeated at Warnstätt, after which the duke was pardoned. Having been married at Mainz on the 7th of January 1114 to Matilda, or Maud, daughter of Henry I., king of England, the emperor was confronted with a further rising, initiated by the

citizens of Cologne, who were soon joined by the Saxons and others. Henry failed to take Cologne, his forces were defeated at Welfesholz on the 11th of February 1115, and complications in Italy compelled him to leave Germany to the care of Frederick II. of Hohenstaufen, duke of Swabia, and his brother Conrad, afterwards the German king Conrad III. After the departure of Henry from Rome in 1111 a council had declared the privilege of lay investiture, which had been extorted from Paschal, to be invalid, and Guido, archbishop of Vienna, excommunicated the emperor and called upon the pope to ratify this sentence. Paschal, however, refused to take so extreme a step; and the quarrel entered upon a new stage in 1115 when Matilda, daughter and heiress of Boniface, margrave of Tuscany, died leaving her vast estates to the papacy. Crossing the Alps in 1116 Henry won the support of town and noble by privileges to the one and presents to the other, took possession of Matilda's lands, and was gladly received in Rome. By this time Paschal had withdrawn his consent to lay investiture and the excommunication had been published in Rome; but the pope was compelled to fly from the city. Some of the cardinals withstood the emperor, but by means of bribes he broke down the opposition, and was crowned a second time by Burdinus, archbishop of Braga. Meanwhile the defeat at Welfesholz had given heart to Henry's enemies; many of his supporters, especially among the bishops, fell away; the excommunication was published at Cologne, and the pope, with the assistance of the Normans, began to make war. In January 1118 Paschal died and was succeeded by Gelasius II. The emperor immediately returned from northern Italy to Rome. But as the new pope escaped from the city, Henry, despairing of making a treaty, secured the election of an antipope who took the name of Gregory VIII., and who was left in possession of Rome when the emperor returned across the Alps in 1118. The opposition in Germany was gradually crushed and a general peace declared at Tribur, while the desire for a settlement of the investiture dispute was growing. Negotiations, begun at Würzburg, were continued at Worms, where the new pope, Calixtus II., was represented by Cardinal Lambert, bishop of Ostia. In the concordat of Worms, signed in September 1122, Henry renounced the right of investiture with ring and crozier, recognized the freedom of election of the clergy and promised to restore all church property. The pope agreed to allow elections to take place in presence of the imperial envoys, and the investiture with the sceptre to be granted by the emperor as a symbol that the estates of the church were held under the crown. Henry, who had been solemnly excommunicated at Reims by Calixtus in October 1119, was received again into the communion of the church, after he had abandoned his nominee, Gregory, to defeat and banishment. The emperor's concluding years were occupied with a campaign in Holland, and with a quarrel over the succession to the margraviate of Meissen, two disputes in which his enemies were aided by Lothair of Saxony. In 1124 he led an expedition against King Louis VI. of France, turned his arms against the citizens of Worms, and on the 23rd of May 1125 died at Utrecht and was buried at Spire. Having no children, he left his possessions to his nephew, Frederick II. of Hohenstaufen, duke of Swabia, and on his death the line of Franconians, or Salian, emperors became extinct.

The character of Henry is unattractive. His love of power was inordinate; he was wanting in generosity, and he did not shrink from treachery in pursuing his ends.

The chief authority for the life and reign of Henry V. is Ekkehard of Aura, *Chronicon*, edited by G. Waltz in the *Monumenta Germaniae historica. Scriptores*, Band vi. (Hanover and Berlin, 1826-1892). See also W. von Giesebrecht, *Geschichte der deutschen Kaiserzeit*, Band iii. (Leipzig, 1881-1890); L. von Ranke, *Weltgeschichte*, pt. vii. (Leipzig, 1886); M. Manitius, *Deutsche Geschichte* (Stuttgart, 1889); G. Meyer von Knonau, *Jahrbücher des deutschen Reiches unter Heinrich IV. und Heinrich V.* (Leipzig, 1890); E. Cerval, *Politische Geschichte Deutschlands unter der Regierung der Kaiser Heinrich V. und Lothar III.* (Leipzig, 1841-1842); G. Feiser, *Der deutsche Investiturstreit unter Kaiser Heinrich V.* (Berlin, 1883); C. Stutzer, "Zur Kritik der Investiturstreitverhandlungen im Jahre 1119," in the *Forschungen zur deutschen Geschichte*, Band xviii. (Göttingen, 1862-1886); T. von Sicking and H. Brunsau, "Die

kaiserliche Ausrüstung des Wormser Konkordats," in the *Mitteilungen des Instituts für österreichische Geschichtsforschung* (Innsbruck, 1886); B. Gebhardt, *Handbuch der deutschen Geschichte*, Band I. (Berlin, 1901), and E. Bernheim, *Zur Geschichte des Wormser Konkordats* (Göttingen, 1828).

HENRY VI. (1165-1197), Roman emperor, son of the emperor Frederick I. and Beatrice, daughter of Renaud III., count of upper Burgundy, was born at Nijmegen, and educated under the care of Conrad of Querfurt, afterwards bishop of Hildesheim and Würzburg. Chosen German king, or king of the Romans, at Bamberg in June 1169, he was crowned at Aix-la-Chapelle on the 15th of August 1169, invested with lands in Germany in 1179, and at Whitsuntide 1184 his knighthood was celebrated in the most magnificent manner at Mainz. Frederick was anxious to associate his son with himself in the government of the empire, and when he left Germany in 1184 Henry remained behind as regent, while his father sought to procure his coronation from Pope Lucius III. The pope was hesitating when he heard that the emperor had arranged a marriage between Henry and Constance, daughter of the late king of Sicily, Roger I., and aunt and heiress of the reigning king, William II.; and this step, which threatened to unite Sicily with Germany, decided him to refuse the proposal. This marriage took place at Milan on the 27th of January 1186, and soon afterwards Henry was crowned king of Italy. The claim of Henry and his wife on Sicily was recognized by the barons of that kingdom; and having been recognized by the pope as Roman emperor elect, Henry returned to Germany, and was again appointed regent when Frederick set out on crusade in May 1189. His attempts to bring peace to Germany were interrupted by the return of Henry the Lion, duke of Saxony, in October 1189, and a campaign against him was followed by a peace made at Fulda in July 1190.

Henry's desire to make this peace was due to the death of William of Sicily, which was soon followed by that of the emperor Frederick. Germany and Italy alike seemed to need the king's presence, but for him, like all the Hohenstaufen, Italy had the greater charm, and having obtained a promise of his coronation from Pope Clement III. he crossed the Alps in the winter of 1190. He purchased the support of the cities of northern Italy, but on reaching Rome he found Clement was dead and his successor, Celestine III., disinclined to carry out the engagement of his predecessor. The strength of the German army and a treaty made between the king and the Romans induced him, however, to crown Henry as emperor on the 14th of April 1191. The aid of the Romans had been purchased by the king's promise to place in their possession the city of Tusculum, which they had attacked in vain for three years. After the ceremony the emperor fulfilled this contract, when the city was destroyed and many of the inhabitants massacred. Meanwhile a party in Sicily had chosen Tancred, an illegitimate son of Roger, son of King Roger II., as their king, and he had already won considerable authority and was favoured by the pope. Leaving Rome Henry met with no resistance until he reached Naples, which he was unable to take, as the ravages of fever and threatening news from Germany, where his death was reported, compelled him to raise the siege. In December 1191 he returned to Germany. Disorder was general and a variety of reasons induced both the Welfs and their earlier opponents to join in a general league against the emperor. Vacancies in various bishoprics added to the confusion, and Henry's enemies gained in numbers and strength when it was suspected that he was implicated in the murder of Albert, bishop of Liège. Henry acted energetically in fighting this formidable combination, but his salvation came from the captivity of Richard I., king of England, and the skill with which he used this event to make peace with his foes; and, when Henry the Lion came to terms in March 1194, order was restored to Germany.

In the following May, Henry made his second expedition to Italy, where Pope Celestine had definitely espoused the cause of Tancred. The ransom received from Richard enabled him to equip a large army, and aided by a fleet fitted out by Genoa and Pisa he soon secured a complete mastery over the Italian main-

land. When he reached Sicily, he found Tancred dead, and, meeting with very little resistance, he entered Palermo, where he was crowned king on Christmas day 1194. A stay of a few months' duration enabled Henry to settle the affairs of the kingdom; and leaving his wife, Constance, as regent, and appointing many Germans to positions of influence, he returned to Germany in June 1195.

Having established his position in Germany and Italy, Henry began to cherish ideas of universal empire. Richard of England had already owned his supremacy, and declaring he would compel the king of France to do the same Henry sought to stir up strife between France and England. Nor did the Spanish kingdoms escape his notice. Tunis and Tripoli were claimed, and when the eastern emperor, Isaac Angelus, asked his help, he demanded in return the cession of the Balkan peninsula. The kings of Cyprus and Armenia asked for investiture at his hands; and in general Henry, in the words of a Byzantine chronicler, put forward his demands as "the lord of all lords, the king of all kings." To complete this scheme two steps were necessary, a reconciliation with the pope and the recognition of his young son, Frederick, as his successor in the Empire. The first was easily accomplished; the second was more difficult. After attempting to suppress the renewed disorder in Germany, Henry met the princes at Worms in December 1195 and put his proposal before them. In spite of promises they disliked the suggestion as tending to draw them into Sicilian troubles, and avoided the emperor's displeasure by postponing their answer. By threats or negotiations, however, Henry won the consent of about fifty princes; but though the diet which met at Würzburg in April 1196 agreed to the scheme, the vigorous opposition of Adolph, archbishop of Cologne, and others rendered it inoperative. In June 1196 Henry went again to Italy, sought vainly to restore order in the north, and tried to persuade the pope to crown his son who had been chosen king of the Romans at Frankfurt. Celestine, who had many causes of complaint against the emperor and his vassals, refused. The emperor then went to the south, where the oppression of his German officials had caused an insurrection, which was put down with terrible cruelty. At Messina on the 28th of September 1197 Henry died from a cold caught whilst hunting, and was buried at Palermo. He was a man of small frame and delicate constitution, but possessed considerable mental gifts and was skilled in knightly exercises. His ambition was immense, and to attain his ends he often resorted deliberately to cruelty and treachery. His chief recreation was hunting, and he also found pleasure in the society of the Minneingers and in writing poems, which appear in F. H. von der Hagen's *Minnesinger* (Leipzig, 1838). He left an only son Frederick, afterwards the emperor Frederick II.

The chief authorities for the life and reign of Henry VI. are Otto of Freising, *Chronicon*, continued by Otto of St Blasius; Godfrey of Viterbo, *Gesta Friderici I.* and *Gesta Henrici VI.*; Giselbert of Mons, *Chronicon Hanoniense*, all of which appear in the *Monumenta Germaniae historica. Scriptores*, Bände xx., xxi., xxii. (Hanover and Berlin, 1826-1892), and the various annals of the time.

The best modern authorities are: W. von Giesebrecht, *Geschichte der deutschen Kaiserzeit*, Band iv. (Brunswick, 1877); T. Toebe, *Kaiser Heinrich VI.* (Leipzig, 1867); H. Bloch, *Forschungen zur Politik Kaiser Heinrichs VI.* (Berlin, 1892), and K. A. Kneller, *Des Richard Löwenherz deutsche Gefangenschaft* (Freiburg, 1893).

HENRY VII. (c. 1269-1313), Roman emperor, son of Henry III., count of Luxemburg, was knighted by Philip IV., king of France, and passed his early days under French influences, while the French language was his mother-tongue. His father was killed in battle in 1288, and Henry ruled his tiny inheritance with justice and prudence, but came into collision with the citizens of Trier over a question of tolls. In 1292 he married Margaret (d. 1311), daughter of John I., duke of Brabant, and after the death of the German king, Albert I., he was elected to the vacant throne on the 27th of November 1308. Recognized at once by the German princes and by Pope Clement V., the aspirations of the new king turned to Italy, where he hoped by restoring the imperial authority to prepare the way for the conquest of

the Holy Land. Meanwhile he strove to secure his position in Germany. The Rhenish archbishops were pacified by the restoration of the Rhine tolls, negotiations were begun with Philip IV., king of France, and with Robert, king of Naples, and the Habsburgs were confirmed in their possessions. At this time Bohemia was ruled by Henry V., duke of Carinthia, but the terrible disorder which prevailed induced some of the Bohemians to offer the crown, together with the hand of Elizabeth, daughter of the late king Wenceslas II., to John, the son of the German king. Henry accepted the offer, and in August 1310 John was invested with Bohemia and his marriage was celebrated. Before John's coronation at Prague, however, in February 1311, Henry had crossed the Alps. His hopes of reuniting Germany and Italy and of restoring the empire of the Hohenstaufen were flattered by an appeal from the Ghibellines to come to their assistance, and by the fact that many Italians, sharing the sentiments expressed by Dante in his *De Monarchia*, looked eagerly for a restoration of the imperial authority. In October 1310 he reached Turin where, on receiving the homage of the Lombard cities, he declared that he favoured neither Guelphs nor Ghibellines, but only sought to impose peace. Having entered Milan he placed the Lombard crown upon his head on the 6th of January 1311. But trouble soon showed itself. His poverty compelled him to exact money from the citizens; the peaceful professions of the Guelphs were insincere, and Robert, king of Naples, watched his progress with suspicion. Florence was fortified against him, and the mutual hatred of Guelph and Ghibelline was easily renewed. Risings took place in various places and, after the capture of Brescia, Henry marched to Rome only to find the city in the hands of the Guelphs and the troops of King Robert. Some street fighting ensued, and the king, unable to obtain possession of St Peter's, was crowned emperor on the 29th of June 1312 in the church of St John Lateran by some cardinals who declared they only acted under compulsion. Failing to subdue Florence, the emperor from his headquarters at Pisa prepared to attack Robert of Naples, for which purpose he had allied himself with Frederick III., king of Sicily. But Clement, anxious to protect Robert, threatened Henry with excommunication. Undeterred by the threat the emperor collected fresh forces, made an alliance with the Venetians, and set out for Naples. On the march he was, however, taken ill, and died at Buonconvento near Siena on the 24th of August 1313, and was buried at Pisa. His death was attributed, probably without reason, to poison given him by a Dominican friar in the sacramental wine. Henry is described by his contemporary Albertino Mussato, in the *Historia Augusta*, as a handsome man, of well-proportioned figure, with reddish hair and arched eyebrows, but disfigured by a squint. He adds, among other details, that he was slow and laconic in his speech, magnanimous and devout, but impatient of any compacts with his subjects, loathing the mention of the Guelph and Ghibelline factions, and insisting on the absolute authority of the Empire over all (*cuncta absolutio complectens Imperio*). He was, however, a lover of justice, and as a knight both bold and skilful. He was hailed by Dante as the deliverer of Italy, and in the *Paradiso* the poet reserved for him a place marked by a crown.

The contemporary documents for the life and reign of Henry VII. are very numerous. Many of them are found in the *Rezum italicarum scriptores*, edited by L. A. Muratori (Milan, 1723-1751), others in *Foelas rerum Germanicarum*, edited by J. F. Böhm (Stuttgart, 1843-1868), and in *Die Geschichtschreiber der deutschen Vorseit*, Bände 79 and 80 (Leipzig, 1884). The following modern works may also be consulted: *Acta Henrici VII. imperatoris Romanorum*, edited by G. Dönniges (Berlin, 1839); F. Boissai, *Acta Henrici VII. Romanorum imperatoris* (Florence, 1877); T. Lindner, *Deutsche Geschichte unter den Habsburgern und Luxemburgern* (Stuttgart, 1888-1893); J. Heidemann, *Die Königswahl Heinrichs von Luxemburg*, in the *Forschungen zur deutschen Geschichte*, Band xi. (Göttingen, 1862-1886); B. Thomas, *Zur Königswahl des Grafen Heinrich von Luxemburg* (Strassburg, 1875); D. König, *Kritische Erörterungen zu einigen italienischen Quellen für die Geschichte des Römerzuges Königs Heinrich VII.* (Göttingen, 1874); K. Wenck, *Clemens V. und Heinrich VII.* (Halle, 1882); F. W. Barthold, *Der Römerzug König Heinrichs von Lützelburg*

(Königsberg, 1830-1831); R. Pöhlmann, *Der Römerzug König Heinrichs VII. und die Politik der Curie* (Nuremberg, 1875); W. Dönniges, *Kritik der Quellen für die Geschichte Heinrichs VII. des Luxemburgers* (Berlin, 1841), and G. Sommerfeldt, *Die Romfahrt Kaiser Heinrichs VII.* (Königsberg, 1888).

HENRY VII. (1211-1242), German king, son of the emperor Frederick II. and his first wife Constance, daughter of Alphonso II., king of Aragon, was crowned king of Sicily in 1212 and made duke of Swabia in 1216. Pope Innocent III. had favoured his coronation as king of Sicily in the hope that the union of this island with the Empire would be dissolved, and had obtained a promise from Frederick to this effect. In spite of this, however, Henry was chosen king of the Romans, or German king, at Frankfort in April 1220, and crowned at Aix-la-Chapelle on the 8th of May 1222 by his guardian Engelbert, archbishop of Cologne. He appears to have spent most of his youth in Germany, and on the 18th of November 1225 was married at Nuremberg to Margaret (d. 1267), daughter of Leopold VI., duke of Austria. Henry's marriage was the occasion of some difference of opinion, as Engelbert wished him to marry an English princess, and the name of a Bohemian princess was also mentioned in this connexion, but Frederick insisted upon the union with Margaret. The murder of Engelbert in 1225 was followed by an increase of disorder in Germany in which Henry soon began to participate, and in 1227 he took part in a quarrel which had arisen on the death of Henry V., the childless count palatine of the Rhine. About this time the relations between Frederick and his son began to be somewhat strained. The emperor had favoured the Austrian marriage because Margaret's brother, Duke Frederick II., was childless; but Henry took up a hostile attitude towards his brother-in-law and wished to put away his wife and marry Agnes, daughter of Wenceslas I., king of Bohemia. Other causes of trouble probably existed, for in 1231 Henry not only refused to appear at the diet at Ravenna, but opposed the privileges granted by Frederick to the princes at Worms. In 1232, however, he submitted to his father, promising to adopt the emperor's policy and to obey his commands. He did not long keep his word and was soon engaged in thwarting Frederick's wishes in several directions, until in 1233 he took the decisive step of issuing a manifesto to the princes, and the following year raised the standard of revolt at Boppard. He obtained very little support in Germany, however, while the suspicion that he favoured heresy deprived him of encouragement from the pope. On the other hand, he succeeded in forming an alliance with the Lombards in December 1234, but his few supporters fell away when the emperor reached Germany in 1235, and, after a vain attack on Worms, Henry submitted and was kept for some time as a prisoner in Germany, though his formal deposition as German king was not considered necessary, as he had broken the oath taken in 1232. He was soon removed to San Felice in Apulia, and afterwards to Martirano in Calabria, where he died, probably by his own hand, on the 12th of February 1242, and was buried at Cosenza. He left two sons, Frederick and Henry, both of whom died in Italy about 1251.

See J. Rohden, *Der Sturz Heinrichs VII.* (Göttingen, 1883); F. W. Schirrmacher, *Die letzten Hohenstaufen* (Göttingen, 1871), and E. Winkelmann, *Kaiser Friedrich II.* (Leipzig, 1889).

HENRY RASPE (c. 1202-1247), German king and landgrave of Thuringia, was the second surviving son of Hermann I., landgrave of Thuringia, and Sophia, daughter of Otto I., duke of Bavaria. When his brother the landgrave Louis IV. died in Italy in September 1227, Henry seized the government of Thuringia and expelled his brother's widow, St Elizabeth of Hungary, and her son Hermann. With some trouble Henry made good his position, although his nephew Hermann II. was nominally the landgrave, and was declared of age in 1237. Henry, who governed with a zealous regard for his own interests, remained loyal to the emperor Frederick II. during his quarrel with the Lombards and the revolt of his son Henry. In 1236 he accompanied the emperor on a campaign against Frederick II., duke of Austria, and took part in the election of his son Conrad as German king at Vienna in 1237. He appears, however, to have become somewhat estranged from Frederick after this

expedition, for he did not appear at the diet of Verona in 1238; and it is not improbable that he disliked the betrothal of his nephew Hermann to the emperor's daughter Margaret. At all events, when the projected marriage had been broken off the landgrave publicly showed his loyalty to the emperor in 1239 in opposition to a plan formed by various princes to elect an anti-king. Henry, whose attitude at this time was very important to Frederick, was probably kept loyal by the influence which his brother Conrad, grand-master of the Teutonic Order, exercised over him, for after the death of this brother in 1241 Henry's loyalty again wavered, and he was himself mentioned as a possible anti-king. Frederick's visit to Germany in 1242 was successful in preventing this step for a time, and in May of that year the landgrave was appointed administrator of Germany for King Conrad; and by the death of his nephew in this year he became the nominal, as well as the actual, ruler of Thuringia. Again he contemplated deserting the cause of Frederick, and in April 1246 Pope Innocent IV. wrote to the German princes advising them to choose Henry as their king in place of Frederick who had just been declared deposed. Acting on these instructions, Henry was elected at Veitshöchheim on the 22nd of May 1246, and owing to the part played by the spiritual princes in this election was called the *Pfaffenkönig*, or parsons' king. Collecting an army, he defeated King Conrad near Frankfurt on the 5th of August 1246, and then, after holding a diet at Nuremberg, undertook the siege of Ulm. But he was soon compelled to give up this enterprise, and returning to Thuringia died at the Wartburg on the 17th of February 1247. Henry married Gertrude, sister of Frederick II., duke of Austria, but left no children, and on his death the male line of his family became extinct.

See F. Reuss, *Die Wahl Heinrich Raspe* (Lüdenscheid, 1878); A. Rübensamen, *Landgraf Heinrich Raspe von Thüringen* (Halle, 1885); F. W. Schirrmacher, *Die letzten Hohenstaufen* (Göttingen, 1871); E. Winkelmann, *Kaiser Friedrich II.* (Leipzig, 1889), and T. Knochenhauer, *Geschichte Thüringens zur Zeit des ersten Landgrafenhauses* (Gotha, 1871).

HENRY (c. 1174–1216), emperor of Romania, or Constantinople, was a younger son of Baldwin, count of Flanders and Hainaut (d. 1199). Having joined the Fourth Crusade about 1201, he distinguished himself at the siege of Constantinople in 1204 and elsewhere, and soon became prominent among the princes of the new Latin empire of Constantinople. When his brother, the emperor Baldwin I., was captured at the battle of Adrianople in April 1205, Henry was chosen regent of the empire, succeeding to the throne when the news of Baldwin's death arrived. He was crowned on the 20th of August 1205. Henry was a wise ruler, whose reign was largely passed in successful struggles with the Bulgarians and with his rival, Theodore Lascaris I., emperor of Nicaea. Henry appears to have been brave but not cruel, and tolerant but not weak; possessing "the superior courage to oppose, in a superstitious age, the pride and avarice of the clergy." The emperor died, poisoned, it is said, by his Greek wife, on the 11th of June 1216.

See Gibbon's *Decline and Fall of the Roman Empire*, vol. vi. (ed. J. B. Bury, 1898).

HENRY I. (1068–1135), king of England, nicknamed Beauclerk, the fourth and youngest son of William I. by his queen Matilda of Flanders, was born in 1068 on English soil. Of his life before 1086, when he was solemnly knighted by his father at Westminster, we know little. He was his mother's favourite, and she bequeathed to him her English estates, which, however, he was not permitted to hold in his father's lifetime. Henry received a good education, of which in later life he was proud; he is credited with the saying that an unlettered king is only a crowned ass. His attainments included Latin, which he could both read and write; he knew something of the English laws and language, and it may have been from an interest in natural history that he collected, during his reign, the Woodstock menagerie which was the admiration of his subjects. But from 1087 his life was one of action and vicissitudes which left him little leisure. Receiving, under the Conqueror's last dispositions, a legacy of five thousand pounds of silver, but no land,

he traded upon the pecuniary needs of Duke Robert of Normandy, from whom he purchased, for the small sum of £3000, the district of the Cotentin. He negotiated with Rufus to obtain the possession of their mother's inheritance, but only incurred thereby the suspicions of the duke, who threw him into prison. In 1090 the prince vindicated his loyalty by suppressing, on Robert's behalf, a revolt of the citizens of Rouen which Rufus had fomented. But when his elder brothers were reconciled in the next year they combined to evict Henry from the Cotentin. He dissembled his resentment for a time, and lived for nearly two years in the French Vexin in great poverty. He then accepted from the citizens of Domfront an invitation to defend them against Robert of Bellême; and subsequently, coming to an agreement with Rufus, assisted the king in making war on their elder brother Robert. When Robert's departure for the First Crusade left Normandy in the hands of Rufus (1096) Henry took service under the latter, and he was in the royal hunting train on the day of Rufus's death (August 2nd, 1100). Had Robert been in Normandy the claim of Henry to the English crown might have been effectually opposed. But Robert only returned to the duchy a month after Henry's coronation. In the meantime the new king, by issuing his famous charter, by recalling Anselm, and by choosing the Anglo-Scottish princess Edith-Matilda, daughter of Malcolm III., king of the Scots, as his future-queen, had cemented that alliance with the church and with the native English which was the foundation of his greatness. Anselm preached in his favour, English levies marched under the royal banner both to repel Robert's invasion (1101) and to crush the revolt of the Montgomeries headed by Robert of Bellême (1102). The alliance of crown and church was subsequently imperilled by the question of investiture (1103–1106). Henry was sharply criticized for his ingratitude to Anselm (q.v.), in spite of the marked respect which he showed to the archbishop. At this juncture a sentence of excommunication would have been a dangerous blow to Henry's power in England. But the king's diplomatic skill enabled him to satisfy the church without surrendering any rights of consequence (1106); and he skillfully threw the blame of his previous conduct upon his counsellor, Robert of Meulan. Although the Peterborough Chronicle accuses Henry of oppression in his early years, the nation soon learned to regard him with respect. William of Malmesbury, about 1125, already treats Tinchebrai (1106) as an English victory and the revenge for Hastings. Henry was disliked but feared by the baronage, towards whom he showed gross bad faith in his disregard of his coronation promises. In 1110 he banished the more conspicuous malcontents, and from that date was safe against the plots of his English feudatories.

With Normandy he had more trouble, and the military skill which he had displayed at Tinchebrai was more than once put to the test against Norman rebels. His Norman, like his English administration, was popular with the non-feudal classes, but doubtless oppressive towards the barons. The latter had abandoned the cause of Duke Robert, who remained a prisoner in England till his death (1134); but they embraced that of Robert's son William the Clito, whom Henry in a fit of generosity had allowed to go free after Tinchebrai. The Norman conspiracies of 1112, 1118, and 1123–24 were all formed in the Clito's interest. Both France and Anjou supported this pretender's cause from time to time; he was always a thorn in Henry's side till his untimely death at Alost (1128), but more especially after the catastrophe of the White Ship (1120) deprived the king of his only lawful son. But Henry emerged from these complications with enhanced prestige. His campaigns had been uneventful, his chief victory (Brémule, 1119) was little more than a skirmish. But he had held his own as a general, and as a diplomatist he had shown surpassing skill. The chief triumphs of his foreign policy were the marriage of his daughter Matilda to the emperor Henry V. (1114) which saved Normandy in 1124; the detachment of the pope, Calixtus II., from the side of France and the Clito (1119), and the Angevin marriages which he arranged for his son William Aetheling (1119) and for

the widowed empress Matilda (1129) after her brother's death. This latter match, though unpopular in England and Normandy, was a fatal blow to the designs of Louis VI., and prepared the way for the expansion of English power beyond the Loire. After 1124 the disaffection of Normandy was crushed. The severity with which Henry treated the last rebels was regarded as a blot upon his fame; but the only case of merely vindictive punishment was that of the poet Luke de la Barre, who was sentenced to lose his eyes for a lampoon upon the king, and only escaped the sentence by committing suicide.

Henry's English government was severe and grasping; but he "kept good peace" and honourably distinguished himself among contemporary statesmen in an age when administrative reform was in the air. He spent more time in Normandy than in England. But he showed admirable judgment in his choice of subordinates; Robert of Meulan, who died in 1118, and Roger of Salisbury, who survived his master, were statesmen of no common order; and Henry was free from the mania of attending in person to every detail, which was the besetting sin of medieval sovereigns. As a legislator Henry was conservative. He issued few ordinances; the unofficial compilation known as the *Leges Henrici* shows that, like the Conqueror, he made it his ideal to maintain the "law of Edward." His itinerant justices were not altogether a novelty in England or Normandy. It is characteristic of the man that the exchequer should be the chief institution created in his reign. The eulogies of the last *Peterborough Chronicle* on his government were written after the anarchy of Stephen's reign had invested his predecessor's "good peace" with the glamour of a golden age. Henry was respected and not tyrannous. He showed a lofty indifference to criticism such as that of Eadmer in the *Historia novorum*, which was published early in the reign. He showed, on some occasions, great deference to the opinions of the magnates. But dark stories, some certainly unfounded, were told of his prison-houses. Men thought him more cruel and more despotic than he actually was.

Henry was twice married. After the death of his first wife, Matilda (1080-1118), he took to wife Adelaide, daughter of Godfrey, count of Louvain (1121), in the hope of male issue. But the marriage proved childless, and the empress Matilda was designated as her father's successor, the English baronage being compelled to do her homage both in 1126, and again, after the Angevin marriage, in 1131. He had many illegitimate sons and daughters by various mistresses. Of these bastards the most important is Robert, earl of Gloucester, upon whom fell the main burden of defending Matilda's title against Stephen.

Henry died near Gisors on the 1st of December, 1135, in the thirty-sixth year of his reign, and was buried in the abbey of Reading which he himself had founded.

ORIGINAL AUTHORITIES.—The *Peterborough Chronicle* (ed. Plummer, Oxford, 1882-1889); *Florence of Worcester* and his first continuator (ed. B. Thorpe, 1848-1849); Eadmer, *Historia novorum* (ed. Rule, Rolls Series, 1884); William of Malmesbury, *Gesta regum et Historia novella* (ed. Stubbs, Rolls Series, 1887-1889); Henry of Huntingdon, *Historia Anglorum* (ed. Arnold, Rolls Series, 1879); Simeon of Durham (ed. Arnold, Rolls Series, 1882-1885); Orderic Vitalis, *Historia ecclesiastica* (ed. le Prévost, Paris, 1838-1855); Robert of Torigni, *Chronica* (ed. Howlett, Rolls Series, 1889), and *Continuatio Willelmi Gemmeticensis* (ed. Duchesne, *Hist. Normannorum scriptores*, pp. 215-317, Paris, 1619). See also the Pipe Roll of 31 H. I. (ed. Hunter, *Record Commission*, 1833); the documents in W. Stubbs's *Select Chapters* (Oxford, 1895); the *Leges Henrici* in Liebermann's *Gesetze der Angel-Sachsen* (Halle, 1898, &c.); and the same author's monograph, *Leges Henrici* (Halle, 1901); the treaties, &c., in the Record Commission edition of Thomas Rymer's *Foedera*, vol. i. (1616).

MODERN AUTHORITIES.—E. A. Freeman, *History of the Norman Conquest*, vol. v.; J. M. Lappenberg, *History of England under the Norman Kings* (tr. Thorpe, Oxford, 1867); Kate Norgate, *England under the Angevin Kings*, vol. i. (1887); Sir James Ramsay, *Foundations of England*, vol. ii.; W. Stubbs, *Constitutional History*, vol. i.; H. W. C. Davis, *England under the Normans and Angevins*; Hunt and Poole, *Political History of England*, vol. ii. (H. W. C. D.)

HENRY II. (1133-1189), king of England, son of Geoffrey Plantagenet, count of Anjou, by Matilda, daughter of Henry I., was born at Le Mans on the 25th of March 1133. He was

brought to England during his mother's conflict with Stephen (1142), and was placed under the charge of a tutor at Bristol. He returned to Normandy in 1146. He next appeared on English soil in 1149¹ when he came to court the help of Scotland and the English baronage against King Stephen. The second visit was of short duration. In 1150 he was invested with Normandy by his father, whose death in the next year made him also count of Anjou. In 1152 by a marriage with Eleanor of Aquitaine, the divorced wife of the French king Louis VII., he acquired Poitou, Guienne and Gascony; but in doing so incurred the ill-will of his suzerain from which he suffered not a little in the future. Lastly in 1153 he was able, through the aid of the Church and his mother's partisans, to extort from Stephen the recognition of his claim to the English succession; and this claim was asserted without opposition immediately after Stephen's death (25th of October 1154). Matilda retired into seclusion, although she possessed, until her death (1167), great influence with her son.

The first years of the reign were largely spent in restoring the public peace and recovering for the crown the lands and prerogatives which Stephen had bartered away. Amongst the older partisans of the Angevin house the most influential were Archbishop Theobald, whose good will guaranteed to Henry the support of the Church, and Nigel, bishop of Ely, who presided at the exchequer. But Thomas Becket, archdeacon of Canterbury, a younger statesman whom Theobald had discovered and promoted, soon became all-powerful. Becket lent himself entirely to his master's ambitions, which at this time centred round schemes of territorial aggrandizement. In 1155 Henry asked and obtained from Adrian IV. a licence to invade Ireland, which the king contemplated bestowing upon his brother, William of Anjou. This plan was dropped; but Malcolm of Scotland was forced to restore the northern counties which had been ceded to David; North Wales was invaded in 1157; and in 1159 Henry made an attempt, which was foiled by the intervention of Louis VII., to assert his wife's claims upon Toulouse. After vainly invoking the aid of the emperor Frederick I., the young king came to terms with Louis (1160), whose daughter was betrothed to Henry's namesake and heir. The peace proved unstable, and there was desultory skirmishing in 1163. The following year was chiefly spent in reforming the government of the continental provinces. In 1163 Henry returned to England, and almost immediately embarked on that quarrel with the Church which is the keynote to the middle period of the reign.

Henry had good cause to complain of the ecclesiastical courts, and had only awaited a convenient season to correct abuses which were admitted by all reasonable men. But he allowed the question to be complicated by personal issues. He was bitterly disappointed that Becket, on whom he bestowed the primacy, left vacant by the death of Theobald (1162), at once became the champion of clerical privilege; he and the archbishop were no longer on speaking terms when the Constitutions of Clarendon came up for debate. The king's demands were not intrinsically irreconcilable with the canon law, and the papacy would probably have allowed them to take effect *sub silentio*, if Becket (q.v.) had not been goaded to extremity by persecution in the forms of law. After Becket's flight (1164), the king put himself still further in the wrong by impounding the revenues of Canterbury and banishing at one stroke a number of the archbishop's friends and connexions. He showed, however, considerable dexterity in playing off the emperor against Alexander III. and Louis VII., and contrived for five years, partly by these means, partly by insincere negotiations with Becket, to stave off a papal interdict upon his dominions. When, in July 1170, he was forced by Alexander's threats to make terms with Becket, the king contrived that not a word should be said of the Constitutions. He undoubtedly hoped that in this matter he would have his way when Becket should be more in England and within his grasp. For the murder of Becket (Dec. 29, 1170) the king cannot be held responsible, though the

¹ For a supposed visit in 1147, see J. H. Round in *English Historical Review*, v. 747.

deed was suggested by his impatient words. It was a misfortune to the royal cause; and Henry was compelled to purchase the papal absolution by a complete surrender on the question of criminous clerks (1172). When he heard of the murder he was panic-stricken; and his expedition to Ireland (1171), although so momentous for the future, was originally a mere pretext for placing himself beyond the reach of Alexander's censures.

Becket's fate, though it supplied an excuse, was certainly not the real cause of the troubles with his sons which disturbed the king's later years (1173-1189). But Henry's misfortunes were largely of his own making. Queen Eleanor, whom he alienated by his faithlessness, stirred up her sons to rebellion; and they had grievances enough to be easily persuaded. Henry was an affectionate but a suspicious and close-handed father. The titles which he bestowed on them carried little power, and served chiefly to denote the shares of the paternal inheritance which were to be theirs after his death. The excessive favour which he showed to John, his youngest-born, was another cause of heart-burning; and Louis, the old enemy, did his utmost to foment all discords. It must, however, be remembered in Henry's favour, that the supporters of the princes, both in England and in the foreign provinces, were animated by resentment against the soundest features of the king's administration; and that, in the rebellion of 1173, he received from the English commons such hearty support that any further attempt to raise a rebellion in England was considered hopeless. Henry, like his grandfather, gained in popularity with every year of his reign. In 1183 the death of Prince Henry, the heir-apparent, while engaged in a war against his brother Richard and their father, secured a short interval of peace. But in 1184 Geoffrey of Brittany and John combined with their father's leave to make war upon Richard, now the heir-apparent. After Geoffrey's death (1186) the feud between John and Richard drove the latter into an alliance with Philip Augustus of France. The ill-success of the old king in this war aggravated the disease from which he was suffering; and his heart was broken by the discovery that John, for whose sake he had alienated Richard, was in secret league with the victorious allies. Henry died at Chinon on the 6th of July 1189, and was buried at Fontevraud. By Eleanor of Aquitaine the king had five sons and three daughters. His eldest son, William, died young; his other sons, Henry, Richard, Geoffrey and John, are all mentioned above. His daughters were: Matilda (1156-1189), who became the wife of Henry the Lion, duke of Saxony; Eleanor (1162-1214), who married Alphonso III., king of Castile; and Joanna, who, after the death of William of Sicily in 1189, became the wife of Raymond VI., count of Toulouse, having previously accompanied her brother, Richard, to Palestine. He had also three illegitimate sons: Geoffrey, archbishop of York; Morgan; and William Longsword, earl of Salisbury.

Henry's power impressed the imagination of his contemporaries, who credited him with aiming at the conquest of France and the acquisition of the imperial title. But his ambitions of conquest were comparatively moderate in his later years. He attempted to secure Maurienne and Savoy for John by a marriage-alliance, for which a treaty was signed in 1173. But the project failed through the death of the intended bride; nor did the marriage of his third daughter, the princess Joanna (1165-1190), with William II., king of Sicily (1177) lead to English intervention in Italian politics. Henry once declined an offer of the Empire, made by the opponents of Frederick Barbarossa; and he steadily supported the young Philip Augustus against the intrigues of French feudatories. The conquest of Ireland was carried out independently of his assistance, and perhaps against his wishes. He asserted his suzerainty over Scotland by the treaty of Falaise (1175), but not so stringently as to provoke Scottish hostility. This moderation was partly due to the embarrassments produced by the ecclesiastical question and the rebellions of the princes. But Henry, despite a violent and capricious temper, had a strong taste for the work of a legislator and administrator. He devoted infinite pains and thought to the reform of government both in England and Normandy.

The legislation of his reign was probably in great part of his own contriving. His supervision of the law courts was close and jealous; he transacted a great amount of judicial business in his own person, even after he had formed a high court of justice which might sit without his personal presence. To these activities he devoted his scanty intervals of leisure. His government was stern; he over-rode the privileges of the baronage without regard to precedent; he persisted in keeping large districts under the arbitrary and vexatious jurisdiction of the forest-courts. But it is the general opinion of historians that he had a high sense of his responsibilities and a strong love of justice; despite the looseness of his personal morals, he commanded the affection and respect of Gilbert Foliot and Hugh of Lincoln, the most upright of the English bishops.

ORIGINAL AUTHORITIES.—Henry's laws are printed in W. Stubbs's *Select Charters* (Oxford, 1895). The chief chroniclers of his reign are William of Newburgh, Ralph de Diceto, the so-called Benedict of Peterborough, Roger of Hoveden, Robert de Torigni (or de Monte), Jordan Fantosme, Giraldus Cambrensis, Gervase of Canterbury; all printed in the *Rolls Series*. The biographies and letters contained in the 7 vols. of *Materials for the History of Thomas Becket* (ed. J. C. Robertson, *Rolls Series*, 1875-1885) are valuable for the early and middle part of the reign. For Irish affairs the *Song of Dermot* (ed. Orpen, Oxford, 1892), for the rebellions of the princes the metrical *Histoire de Guillaume le Maréchal* (ed. Paul Meyer, 3 vols., Paris, 1891, &c.) are of importance. Henry's legal and administrative reforms are illustrated by the *Tractatus de legibus* attributed to Ranulph Glanville, his chief justiciar (ed. G. Phillips, Berlin, 1828); by the *Dialogus de scaccario* of Richard fitz Nigel (Oxford, 1902); the *Pipe Rolls*, printed by J. Hunter for the Record Commission (1844) and by the *Pipe-Roll Society* (London, 1884, &c.) supply valuable details. The works of John of Salisbury (ed. Giles, 1848), Peter of Blois (ed. Migne), Walter Map (Camden Society, 1841, 1850) and the letters of Gilbert Foliot (ed. J. A. Giles, Oxford, 1845) are useful for the social and Church history of the reign.

MODERN AUTHORITIES.—R. W. Eyton, *Itinerary of Henry II.* (London, 1878); W. Stubbs, *Constitutional History*, vol. 1. (Oxford, 1893), *Lectures on Medieval and Modern History* (Oxford, 1886) and *Early Plantagenets* (London, 1876); the same author's introduction to the *Rolls editions* of "Benedict"; Gervase, Diceto, Hoveden; Mrs. J. R. Green, *Henry II.* (London, 1888); Misc. K., Hoveden; *England under the Angevin Kings* (2 vols., London, 1887); Sir J. H. Ramsay's *The Angevin Empire* (London, 1893); H. W. C. Davis's *England under the Normans and Angevins* (London, 1905); Sir F. Pollock and F. W. Maitland, *History of English Law* (2 vols., Cambridge, 1898); and F. Hardegen, *Imperialpolitik König Heinrichs II. von England* (Heidelberg, 1905). (H. W. C. D.)

HENRY III. (1207-1272), king of England, was the eldest son of King John by Isabella of Angoulême. Born on the 1st of October 1207, the prince was but nine years old at the time of his father's death. The greater part of eastern England being in the hands of the French pretender, Prince Louis, afterwards King Louis VIII., and the rebel barons, Henry was crowned by his supporters at Gloucester, the western capital. John had committed his son to the protection of the Holy See, and a share in the government was accordingly allowed to the papal legates, Gualo and Pandulf, both during the civil war and for some time afterwards. But the title of regent was given by the loyal barons to William Marshal, the aged earl of Pembroke; and Peter des Roches, the Poitevin bishop of Winchester, received the charge of the king's person. The cause of the young Henry was fully vindicated by the close of the year 1217. Defeated both by land and sea, the French prince renounced his pretensions and evacuated England, leaving the regency to deal with the more difficult questions raised by the lawless insolence of the royal partisans. Henry remained a passive spectator of the measures by which William Marshal (d. 1210), and his successor, the justiciar Hubert de Burgh, asserted the royal prerogative against native barons and foreign mercenaries. In 1223 Honorius III. declared the king of age, but this was a mere formality, intended to justify the resumption of the royal castles and demesnes which had passed into private hands during the commotions of the civil war.

The personal rule of Henry III. began in 1227, when he was again proclaimed of age. Even then he remained for some time under the influence of Hubert de Burgh, whose chief rival, Peter des Roches, found it expedient to quit the kingdom for four years. But Henry was ambitious to recover the continent.

possessions which his father had lost. Against the wishes of the justiciar he planned and carried out an expedition to the west of France (1230); when it failed he laid the blame upon his minister. Other differences arose soon afterwards. Hubert was accused, with some reason, of enriching himself at the expense of the crown, and of encouraging popular riots against the alien clerks for whom the papacy was providing at the expense of the English Church. He was disgraced in 1232; and power passed for a time into the hands of Peter des Roches, who filled the administration with Poitevins. So began the period of misrule by which Henry III. is chiefly remembered in history. The Poitevins fell in 1234; they were removed at the demand of the barons and the primate Edmund Rich, who held them responsible for the tragic fate of the rebellious Richard Marshal. But the king replaced them with a new clique of servile and rapacious favourites. Disregarding the wishes of the Great Council, and excluding all the more important of the barons and bishops from office, he acted as his own chief minister and never descended to justify his policy except when he stood in need of subsidies. When these were refused, he extorted aids from the towns, the Jews or the clergy, the three most defenceless interests in the kingdom. Always in pecuniary straits through his extravagance, he pursued a foreign policy which would have been expensive under the most careful management. He hoped not only to regain the French possessions but to establish members of his own family as sovereigns in Italy and the Empire. These plans were artfully fostered by the Savoyard kinsmen of Eleanor, daughter of Raymond Berenger, count of Provence, whom he married at Canterbury in January 1236, and by his half-brothers, the sons of Queen Isabella and Hugo, count of la Marche. These favourites, not content with pushing their fortunes in the English court, encouraged the king in the wildest designs. In 1242 he led an expedition to Gascony which terminated disastrously with the defeat of Taillebourg; and hostilities with France were intermittently continued for seventeen years. The Savoyards encouraged his natural tendency to support the Papacy against the Empire; at an early date in the period of misrule he entered into a close alliance with Rome, which resulted in heavy taxation of the clergy and gave great umbrage to the barons. A cardinal-legate was sent to England at Henry's request, and during four years (1237-1241) administered the English Church in a manner equally profitable to the king and to the pope. After the recall of the legate Otho the alliance was less open and less cordial. Still the pope continued to share the spoils of the English clergy with the king, and the king to enforce the demands of Roman tax-collectors.

Circumstances favoured Henry's schemes. Archbishop Edmund Rich was timid and inexperienced; his successor, Boniface of Savoy, was a kinsman of the queen; Grosseteste, the most eminent of the bishops, died in 1253, when he was on the point of becoming a popular hero. Among the lay barons, the first place naturally belonged to Richard of Cornwall who, as the king's brother, was unwilling to take any steps which might impair the royal prerogative; while Simon de Montfort, earl of Leicester, the ablest man of his order, was regarded with suspicion as a foreigner, and linked to Henry's cause by his marriage with the princess Eleanor. Although the Great Council repeatedly protested against the king's misrule and extravagance, their remonstrances came to nothing for want of leaders and a clear-cut policy. But between 1248 and 1252 Henry alienated Montfort from his cause by taking the side of the Gascons, whom the earl had provoked to rebellion through his rigorous administration of their duchy. A little later, when Montfort was committed to opposition, Henry foolishly accepted from Innocent IV. the crown of Sicily for his second son Edmund Crouchback (1255). Sicily was to be conquered from the Hohenstaufen at the expense of England; and Henry pledged his credit to the papacy for enormous subsidies, although years of comparative inactivity had already overwhelmed him with debts. On the publication of the ill-considered bargain the baronage at length took vigorous action. They forced upon the king the Provisions of Oxford (1258), which placed the govern-

ment in the hands of a feudal oligarchy; they reduced expenditure, expelled the alien favourites from the kingdom, and insisted upon a final renunciation of the French claims. The king submitted for the moment, but at the first opportunity endeavoured to cancel his concessions. He obtained a papal absolution from his promises; and he tricked the opposition into accepting the arbitration of the French king, Louis IX., whose verdict was a foregone conclusion. But Henry was incapable of protecting with the strong hand the rights which he had recovered by his double-dealing. Ignominiously defeated by Montfort at Lewes (1264) he fell into the position of a cipher, equally despised by his opponents and supporters. He acquiesced in the earl's dictatorship; left to his eldest son, Edward, the difficult task of reorganising the royal party; marched with the Montfortians to Evesham; and narrowly escaped sharing the fate of his gaoler. After Evesham he is hardly mentioned by the chroniclers. The compromise with the surviving rebels was arranged by his son in concert with Richard of Cornwall and the legate Ottobono; the statute of Marlborough (1267), which purchased a lasting peace by judicious concessions, was similarly arranged between Edward and the earl of Gloucester. Edward was king in all but name for some years before the death of his father, by whom he was alternately suspected and adored.

Henry had in him some of the elements of a fine character. His mind was cultivated; he was a discriminating patron of literature, and Westminster Abbey is an abiding memorial of his artistic taste. His personal morality was irreproachable, except that he inherited the Plantagenet taste for crooked courses and dissimulation in political affairs; even in this respect the king's reputation has suffered unduly at the hands of Matthew Paris, whose literary skill is only equalled by his malice. The ambitions which Henry cherished, if extravagant, were never sordid; his patriotism, though seldom attested by practical measures, was thoroughly sincere. Some of his worst actions as a politician were due to a sincere, though exaggerated, gratitude for the support which the Papacy had given him during his minority. But he had neither the training nor the temper of a statesman. His dreams of autocracy at home and far-reaching dominion abroad were anachronisms in a century of constitutional ideas and national differentiation. Above all he earned the contempt of Englishmen and foreigners alike by the instability of his purpose. Matthew Paris said that he had a heart of wax; Dante relegated him to the limbo of ineffectual souls; and later generations have endorsed these scathing judgments.

Henry died at Westminster on the 16th of November 1272; his widow, Eleanor, took the veil in 1276 and died at Amesbury on the 25th of June 1291. Their children were: the future king Edward I.; Edmund, earl of Lancaster; Margaret (1240-1275), the wife of Alexander III., king of Scotland; Beatrice; and Katherine.

ORIGINAL AUTHORITIES.—Roger of Wendover, *Flores historiarum* (ed. H. O. Coxe, 4 vols., 1841-1844); and Matthew of Paris, *Chronica majora* (ed. H. R. Luard, Rolls Series, 7 vols., 1872-1883) are the chief narrative sources. See also the *Annales monastice* (ed. H. R. Luard, Rolls Series, 5 vols., 1864-1866); the collection of *Royal and other Historical Letters* edited by W. Shirley (Rolls Series, 2 vols., 1862-1866); the Close and Patent Rolls edited for the Record Commission and the Master of the Rolls; the *Epistolae Roberti Grosseteste* (ed. H. R. Luard, Rolls Series, 1861); the *Monumenta Franciscana*, vol. i. (ed. J. S. Brewer, Rolls Series, 1858); the documents in the new *Foedera*, vol. i. (Record Commission, 1816).

MODERN WORKS.—G. J. Turner's article on the king's minority in *Transactions of the Royal Historical Society*, New Series, vol. xviii.; Dom Gasquet's *Henry III. and the Church* (1905); the lives of Simon de Montfort by G. W. Prothero (1871), R. Pauli (Eng. ed., 1876) and C. Bémont (Paris, 1884); W. Stubbs's *Constitutional History of England*, vol. ii. (1887); R. Pauli's *Geschichte von England*, vol. iii. (Hamburg, 1853); T. F. Tout in the *Political History of England*, vol. iii. (1905), and H. W. C. Davis in *England under the Normans and Angevins* (1905). (H. W. C. D.)

HENRY IV. (1367-1413), king of England, son of John of Gaunt, by Blanche, daughter of Henry, duke of Lancaster, was born on the 3rd of April 1367, at Bolingbroke in Lincolnshire. As early as 1377 he is styled earl of Derby, and in 1380 he married

Mary de Bohun (d. 1394) one of the co-heiresses of the last earl of Hereford. In 1387 he supported his uncle Thomas, duke of Gloucester, in his armed opposition to Richard II. and his favourites. Afterwards, probably through his father's influence, he changed sides. He was already distinguished for his knightly prowess, and for some years devoted himself to adventure. He thought of going on the crusade to Barbary; but instead, in July 1390, went to serve with the Teutonic knights in Lithuania. He came home in the following spring, but next year went again to Prussia, whence he journeyed by way of Venice to Cyprus and Jerusalem. After his return to England he sided with his father and the king against Gloucester, and in 1397 was made duke of Hereford. In January 1398 he quarrelled with the duke of Norfolk, who charged him with treason. The dispute was to have been decided in the lists at Coventry in September; but at the last moment Richard intervened and banished them both.

When John of Gaunt died in February 1399 Richard, contrary to his promise, confiscated the estates of Lancaster. Henry then felt himself free, and made friends with the exiled Arundels. Early in July, whilst Richard was absent in Ireland, he landed at Ravenspur in Yorkshire. He was at once joined by the Percies, and Richard, abandoned by his friends, surrendered at Flint on the 19th of August. In the parliament, which assembled on the 30th of September, Richard was forced to abdicate. Henry then made his claim as coming by right line of blood from King Henry III., and through his right to recover the realm which was in point to be undone for default of governance and good law. Parliament formally accepted him, and thus Henry became king, "not so much by title of blood as by popular election" (Capgrave). The new dynasty had consequently a constitutional basis. With this Henry's own political sympathies well accorded. But though the revolution of 1399 was popular in form, its success was due to an oligarchical faction. From the start Henry was embarrassed by the power and pretensions of the Percies. Nor was his hereditary title so good as that of the Mortimers. To domestic troubles was added the complication of disputes with Scotland and France. The first danger came from the friends of Richard, who plotted prematurely, and were crushed in January 1400. During the summer of 1400 Henry made a not over-successful expedition to Scotland. The French court would not accept his overtures, and it was only in the summer of 1401 that a truce was patched up by the restoration of Richard's child-queen, Isabella of Valois. Meantime a more serious trouble had arisen through the outbreak of the Welsh revolt under Owen Glendower (*q.v.*). In 1400 and again in each of the two following autumns Henry invaded Wales in vain. The success of the Percies over the Scots at Homildon Hill (Sept. 1402) was no advantage. Henry Percy (Hotspur) and his father, the earl of Northumberland, thought their services ill-requited, and finally made common cause with the partisans of Mortimer and the Welsh. The plot was frustrated by Hotspur's defeat at Shrewsbury (21st of July 1403); and Northumberland for the time submitted. Henry had, however, no one on whom he could rely outside his own family, except Archbishop Arundel. The Welsh were unsubdued; the French were plundering the southern coast; Northumberland was fomenting trouble in the north. The crisis came in 1405. A plot to carry off the young Mortimers was defeated; but Mowbray, the earl marshal, who had been privy to it, raised a rebellion in the north supported by Archbishop Scrope of York. Mowbray and Scrope were taken and beheaded; Northumberland escaped into Scotland. For the execution of the archbishop Henry was personally responsible, and he could never free himself from its odium. Popular belief regarded his subsequent illness as a judgment for his impiety. Apart from ill-health and unpopularity Henry had succeeded — relations with Scotland were secured by the capture of James, the heir to the crown; Northumberland was at last crushed at Bramham Moor (Feb. 1408); and a little later the Welsh revolt was mastered.

Henry, stricken with sore disease, was unable to reap the advantage. His necessities had all along enabled the Commons

to extort concessions in parliament, until in 1406 he was forced to nominate a council and govern by its advice. However, with Archbishop Arundel as his chancellor, Henry still controlled the government. But in January 1410 Arundel had to give way to the king's half-brother, Thomas Beaufort. Beaufort and his brother Henry, bishop of Winchester, were opposed to Arundel and supported by the prince of Wales. For two years the real government rested with the prince and the council. Under the prince's influence the English intervened in France in 1411 on the side of Burgundy. In this, and in some matters of home politics, the king disagreed with his ministers. There is good reason to suppose that the Beauforts had gone so far as to contemplate a forced abdication on the score of the king's ill-health. However, in November 1411 Henry showed that he was still capable of vigorous action by discharging the prince and his supporters. Arundel again became chancellor, and the king's second son, Thomas, took his brother's place. The change was further marked by the sending of an expedition to France in support of Orleans. But Henry's health was failing steadily. On the 20th of March 1413, whilst praying in Westminster Abbey he was seized with a fainting fit, and died that same evening in the Jerusalem Chamber. At the time he was believed to have been a leper, but as it would appear without sufficient reason.

As a young man Henry had been chivalrous and adventurous, and in politics anxious for good government and justice. As king the loss and failure of friends made him cautious, suspicious and cruel. The persecution of the Lollards, which began with the burning statute of 1401, may be accounted for by Henry's own orthodoxy, or by the influence of Archbishop Arundel, his one faithful friend. But that political Lollardry was strong is shown by the proposal in the parliament of 1410 for a wholesale confiscation of ecclesiastical property. Henry's faults may be excused by his difficulties. Throughout he was practical and steadfast, and he deserved credit for maintaining his principles as a constitutional ruler. So after all his troubles he founded his dynasty firmly, and passed on the crown to his son with a better title. He is buried under a fine tomb at Canterbury.

By Mary Bohun Henry had four sons: his successor Henry V., Thomas, duke of Clarence, John, duke of Bedford, and Humphrey, duke of Gloucester; and two daughters, Blanche, who married Louis III., elector palatine of the Rhine, and Philippa, who married Eric XIII., king of Sweden. Henry's second wife was Joan, or Joanna, (*c.* 1370-1437), daughter of Charles the Bad, king of Navarre, and widow of John IV. or V., duke of Brittany, who survived until July 1437. By her he had no children.

The chief contemporary authorities are the *Annales Henrici Quarti* and T. Walsingham's *Historia Anglicana* (Rolls Series). Adam of Usk's *Chronicle* and the various *Chronicles of London*. The life by John Capgrave (*De illustribus Henricis*) is of little value. Some personal matter is contained in *Wardrobe Accounts of Henry, Earl of Derby* (Camden Soc.). For documents consult T. Rymer's *Foedera*; Sir N. H. Nicolas, *Proceedings and Ordinances of the Privy Council*; Sir H. Ellis, *Original Letters illustrative of English History* (London, 1825-1846); *Rolls of Parliament; Royal and Historical Letters, Henry IV.* (Rolls Series) and the *Calendars of Patent Rolls*. Of modern authorities the foremost is J. H. Wylie's minute and learned *Hist. of England under Henry IV.* (4 vols., London, 1884-1898). See also W. Stubbs, *Constitutional History*; Sir J. Ramsay, *Lancaster and York* (2 vols., Oxford, 1892); and C. W. C. Oman, *The Political History of England*, vol. iv. (C. L. K.)

HENRY V. (1387-1422), king of England, son of Henry IV. by Mary de Bohun, was born at Monmouth, in August 1387. On his father's exile in 1398 Richard II. took the boy into his own charge, and treated him kindly. Next year the Lancastrian revolution forced Henry into precocious prominence as heir to the throne. From October 1400 the administration of Wales was conducted in his name; less than three years later he was in actual command of the English forces and fought against the Percies at Shrewsbury. The Welsh revolt absorbed his energies till 1408. Then through the king's ill-health he began to take a wider share in politics. From January 1410, helped by his uncles Henry and Thomas Beaufort, he had practical control of the government. Both in foreign and domestic policy he

differed from the king, who in November 1411 discharged the prince from the council. The quarrel of father and son was political only, though it is probable that the Beauforts had discussed the abdication of Henry IV., and their opponents certainly endeavoured to defame the prince. It may be that to political enmity the tradition of Henry's riotous youth, immortalized by Shakespeare, is partly due. To that tradition Henry's strenuous life in war and politics is a sufficient general contradiction. The most famous incident, his quarrel with the chief-justice, has no contemporary authority and was first related by Sir Thomas Elyot in 1531. The story of Falstaff originated partly in Henry's early friendship for Oldcastle (*q.v.*). That friendship, and the prince's political opposition to Archbishop Arundel, perhaps encouraged Lollard hopes. If so, their disappointment may account for the statements of ecclesiastical writers, like Walsingham, that Henry on becoming king was changed suddenly into a new man.

Henry succeeded his father on the 20th of March 1413. With no past to embarrass him, and with no dangerous rivals, his practical experience had full scope. He had to deal with three main problems—the restoration of domestic peace, the healing of schism in the Church and the recovery of English prestige in Europe. Henry grasped them all together, and gradually built upon them a yet wider policy. From the first he made it clear that he would rule England as the head of a united nation, and that past differences were to be forgotten. Richard II. was honourably reinterred; the young Mortimer was taken into favour; the heirs of those who had suffered in the last reign were restored gradually to their titles and estates. With Oldcastle Henry used his personal influence in vain, and the gravest domestic danger was Lollard discontent. But the king's firmness nipped the movement in the bud (Jan. 1414), and made his own position as ruler secure. Save for the abortive Scropes and Cambridge plot in favour of Mortimer in July 1415, the rest of his reign was free from serious trouble at home. Henry could now turn his attention to foreign affairs. A writer of the next generation was the first to allege that Henry was encouraged by ecclesiastical statesmen to enter on the French war as a means of diverting attention from home troubles. For this story there is no foundation. The restoration of domestic peace was the king's first care, and until it was assured he could not embark on any wider enterprise abroad. Nor was that enterprise one of idle conquest. Old commercial disputes and the support which the French had lent to Glendower gave a sufficient excuse for war, whilst the disordered state of France afforded no security for peace. Henry may have regarded the assertion of his own claims as part of his kingly duty, but in any case a permanent settlement of the national quarrel was essential to the success of his world policy. The campaign of 1415, with its brilliant conclusion at Agincourt (October 25), was only the first step. Two years of patient preparation followed. The command of the sea was secured by driving the Genoese allies of the French out of the Channel. A successful diplomacy detached the emperor Sigismund from France, and by the Treaty of Canterbury paved the way to end the schism in the Church. So in 1417 the war was renewed on a larger scale. Lower Normandy was quickly conquered, Rouen cut off from Paris and besieged. The French were paralysed by the disputes of Burgundians and Armagnacs. Henry skillfully played them off one against the other, without relaxing his warlike energy. In January 1419 Rouen fell. By August the English were outside the walls of Paris. The intrigues of the French parties culminated in the assassination of John of Burgundy by the dauphin's partisans at Montreuil (September 20, 1419). Philip, the new duke, and the French court threw themselves into Henry's arms. After six months' negotiation Henry was by the Treaty of Troyes recognized as heir and regent of France, and on the 2nd of June 1420 married Catherine, the king's daughter. He was now at the height of his power. His eventual success in France seemed certain. He shared with Sigismund the credit of having ended the Great Schism by obtaining the election of Pope Martin V. All the states of western Europe were being brought within the web of his diplomacy.

The headship of Christendom was in his grasp, and schemes for a new crusade began to take shape. He actually sent an envoy to collect information in the East; but his plans were cut short by death. A visit to England in 1422 was interrupted by the defeat of Clarence at Baugé. The hardships of the longer winter siege of Meaux broke down his health, and he died at Bois de Vincennes on the 31st of August 1422.

Henry's last words were a wish that he might live to rebuild the walls of Jerusalem. They are significant. His ideal was founded consciously on the models of Arthur and Godfrey as national king and leader of Christendom. So he is the typical medieval hero. For that very reason his schemes were doomed to end in disaster, since the time was come for a new departure. Yet he was not reactionary. His policy was constructive: a firm central government supported by parliament; church reform on conservative lines; commercial development; and the maintenance of national prestige. His aims in some respects anticipated those of his Tudor successors, but he would have accomplished them on medieval lines as a constitutional ruler. His success was due to the power of his personality. He could train able lieutenants, but at his death there was no one who could take his place as leader. War, diplomacy and civil administration were all dependent on his guidance. His dazzling achievements as a general have obscured his more sober qualities as a ruler, and even the sound strategy, with which he aimed to be master of the narrow seas. If he was not the founder of the English navy he was one of the first to realize its true importance. Henry had so high a sense of his own rights that he was merciless to disloyalty. But he was scrupulous of the rights of others, and it was his eager desire to further the cause of justice that impressed his French contemporaries. He has been charged with cruelty as a religious persecutor; but in fact he had as prince opposed the harsh policy of Archbishop Arundel, and as king sanctioned a more moderate course. Lollard executions during his reign had more often a political than a religious reason. To be just with sternness was in his eyes a duty. So in his warfare, though he kept strict discipline and allowed no wanton violence, he treated severely all who had in his opinion transgressed. In his personal conduct he was chaste, temperate and sincerely pious. He delighted in sport and all manly exercises. At the same time he was cultured, with a taste for literature, art and music. Henry lies buried in Westminster Abbey. His tomb was stripped of its splendid adornment during the Reformation. The shield, helmet and saddle, which formed part of the original funeral equipment, still hang above it.

Of original authorities the best on the English side is the *Gesta Henrici Quinti* (down to 1416), printed anonymously for the English Historical Society, but probably written by Thomas Elmham, one of Henry's chaplains. Two lives edited by Thomas Hearne under the names of Elmham and Titus Livius Forjulianensis come from a common source; the longer, which Hearne ascribed incorrectly to Elmham, is perhaps the original work of Livius, who was an Italian in the service of Humphrey of Gloucester, and wrote about 1440. Other authorities are the *Chronicles of Walsingham* and *Otterbourne*, the *English Chronicle or Brut*, and the various *London Chronicles*. On the French side the most valuable are *Chronicles of Monstrelet* and *St Rémy* (both Burgundian) and the *Chronique du religieux de S. Denis* (the official view of the French court). For documents and modern authorities see under HENRY IV. See also Sir N. H. Nicolas, *Hist. of the Battle of Agincourt and the Expedition of 1415* (London, 1833); C. L. Kingsford, *Henry V., the Typical Medieval Hero* (New York, 1901), where a fuller bibliography will be found. (C. L. K.)

HENRY VI. (1413–1422), king of England, son of Henry V. and Catherine of Valois, was born at Windsor on the 6th of December 1413. He became king of England on the 1st of September 1422, and a few weeks later, on the death of his grandfather Charles VI., was proclaimed king of France also. Henry V. had directed that Richard Beauchamp, earl of Warwick (*q.v.*), should be his son's preceptor; Warwick took up his charge in 1428; he trained his pupil to be a good man and refined gentleman, but he could not teach him kingship. As early as 1423 the baby king was made to appear at public functions and take his place in parliament. He was knighted by his uncle Bedford at Leicester in May 1426, and on the 6th of November 1429 was crowned at Westminster.

Early in the next year he was taken over to France, and after long delay crowned in Paris on the 16th of December 1431. His return to London on the 14th of February 1432 was celebrated with a great pageant devised by Lydgate.

During these early years Bedford ruled France wisely and at first with success, but he could not prevent the mischief which Humphrey of Gloucester (*q.v.*) caused both at home and abroad. Even in France the English lost ground steadily after the victory of Joan of Arc before Orleans in 1429. The climax came with the death of Bedford, and defection of Philip of Burgundy in 1435. This closed the first phase of Henry's reign. There followed fifteen years of vain struggle in France, and growing disorder at home. The determining factor in politics was the conduct of the war. Cardinal Beaufort, and after him Suffolk, sought by working for peace to secure at least Guienne and Normandy. Gloucester courted popularity by opposing them throughout; with him was Richard of York, who stood next in succession to the crown. Beaufort controlled the council, and it was under his guidance that the king began to take part in the government. Thus it was natural that as Henry grew to manhood he seconded heartily the peace policy. That policy was wise, but national pride made it unpopular and difficult. Henry himself had not the strength or knowledge to direct it, and was unfortunate in his advisers. The cardinal was old, his nephews John and Edmund Beaufort were incompetent, Suffolk, though a man of noble character, was tactless. Suffolk, however, achieved a great success by negotiating the marriage of Henry to Margaret of Anjou (*q.v.*) in 1445. Humphrey of Gloucester and Cardinal Beaufort both died early in 1447. Suffolk was now all-powerful in the favour of the king and queen. But his home administration was unpopular, whilst the incapacity of Edmund Beaufort ended in the loss of all Normandy and Guienne. Suffolk's fall in 1450 left Richard of York the foremost man in England. Henry's reign then entered on its last phase of dynastic struggle. Cade's rebellion suggested first that popular discontent might result in a change of rulers. But York, as heir to the throne, could abide his time. The situation was altered by the mental derangement of the king, and the birth of his son in 1453. York after a struggle secured the protectorship, and for the next year ruled England. Then Henry was restored to sanity, and the queen and Edmund Beaufort, now Duke of Somerset, to power. Open war followed, with the defeat and death of Somerset at St Albans on the 22nd of May 1455. Nevertheless a hollow peace was patched up, which continued during four years with lack of all governance. In 1459 war broke out again. On the 10th of July 1460 Henry was taken prisoner at Northampton, and forced to acknowledge York as heir, to the exclusion of his own son. Richard of York's death at Wakefield (Dec. 30, 1460), and the queen's victory at St Albans (Feb. 17, 1461), brought Henry his freedom and no more. Edward of York had himself proclaimed king, and by his decisive victory at Towton on the 29th of March, put an end to Henry's reign. For over three years Henry was a fugitive in Scotland. He returned to take part in an abortive rising in 1464. A year later he was captured in the north, and brought a prisoner to the Tower. For six months in 1470-1471 he emerged to hold a shadowy kingship as Warwick's puppet. Edward's final victory at Tewkesbury was followed by Henry's death on the 21st of May 1471, certainly by violence, perhaps at the hands of Richard of Gloucester.

Henry was the most hapless of monarchs. He was so honest and well-meaning that he might have made a good ruler in quiet times. But he was crushed by the burden of his inheritance. He had not the genius to find a way out of the French entanglement or the skill to steer a constitutional monarchy between rival factions. So the system and policy which were the creations of Henry IV. and Henry V. led under Henry VI. to the ruin of their dynasty. Henry's very virtues added to his difficulties. He was so trusting that any one could influence him, so faithful that he would not give up a minister who had become impossible. Thus even in the middle period he had no real control of the government. In his latter years he was mentally too weak for independent action. At his best he was a "good and gentle

creature," but too kindly and generous to rule others. Religious observances and study were his chief occupations. His piety was genuine; simple and pure, he was shocked at any suggestion of impropriety, but his rebuke was only "Fie, for shame! forsooth ye are to blame." For education he was really zealous. Even as a boy he was concerned for the upbringing of his half-brothers, his mother's children by Owen Tudor. Later, the planning of his great foundations at Eton and King's College, Cambridge, was the one thing which absorbed his interest. To both he was more than a royal founder, and the credit of the whole scheme belongs to him. The charter for Eton was granted on the 11th of October 1440, and that for King's College in the following February. Henry himself laid the foundation-stones of both buildings. He frequently visited Cambridge to superintend the progress of the work. When at Windsor he loved to send for the boys from his school and give them good advice.

Henry's only son was Edward, prince of Wales (1453-1471), who, having shared the many journeys and varying fortunes of his mother, Margaret, was killed after the battle of Tewkesbury (May 4, 1471) by some noblemen in attendance on Edward IV.

There is a life of Henry by his chaplain John Blakman (printed at the end of Hearne's edition of Otterbourne); but it is concerned only with his piety and patience in adversity. English chronicles for the reign are scanty; the best are the *Chronicles of London* (ed. C. L. Kingsford), with the analogous *Gregory's Chronicle* (ed. J. Gairdner for Camden Soc.) and *Chronicle of London* (ed. Sir H. N. Nicolas). *The Paston Letters*, with James Gairdner's valuable Introduction, are indispensable. Other useful authorities are Joseph Stevenson's *Letters and Papers illustrative of the Wars of the English in France during the Reign of Henry VI.*; and *Correspondence of T. Bekynston* (both in "Rolls" series). For the French war the chief sources are the *Chronicles of Monstrelet*, D'Escouchy and T. Basin. For other documents and modern authorities see under HENRY IV. For Henry's foundations see Sir H. C. Maxwell-Lyte, *History of Eton College* (London, 1899), and J. B. Mullinger, *History of the University of Cambridge* (London, 1888). (C. L. R.)

HENRY VII. (1457-1509), king of England, was the first of the Tudor dynasty. His claim to the throne was through his mother from John of Gaunt and Catherine Swynford, whose issue born before their marriage had been legitimated by parliament. This, of course, was only a Lancastrian claim, never valid, even as such, till the direct male line of John of Gaunt had become extinct. By his father the genealogists traced his pedigree to Cadwallader, but this only endeared him to the Welsh when he had actually become king. His grandfather, Owen Tudor, however, had married Catherine, the widow of Henry V. and daughter to Charles VI. of France. Their son Edmund, being half brother of Henry VI., was created by that king earl of Richmond, and having married Margaret Beaufort, only daughter of John, duke of Somerset, died more than two months before their only child, Henry, was born in Pembroke Castle in January 1457. The fatherless child had sore trials. Edward IV. won the crown when he was four years old, and while Wales partly held out against the conqueror, he was carried for safety from one castle to another. Then for a time he was made a prisoner; but ultimately he was taken abroad by his uncle Jasper, who found refuge in Brittany. At one time the duke of Brittany was nearly induced to surrender him to Edward IV.; but he remained safe in the duchy till the cruelties of Richard III. drove more and more Englishmen abroad to join him. An invasion of England was planned in 1483 in concert with the duke of Buckingham's rising; but stormy weather at sea and an inundation in the Severn defeated the two movements. A second expedition, two years later, aided this time by France, was more successful. Henry landed at Milford Haven among his Welsh allies and defeated Richard at the battle of Bosworth (August 22, 1485). He was crowned at Westminster on the 30th of October following. Then, in fulfilment of pledges by which he had procured the adhesion of many Yorkist supporters, he was married at Westminster to Elizabeth (1465-1503), eldest daughter and heiress of Edward IV. (Jan. 18, 1486), whose two brothers had both been murdered by Richard III. Thus the Red and White Roses were united and the pretexts for civil war done away with.

Nevertheless, Henry's reign was much disturbed by a succession

of Yorkist conspiracies and pretenders. Of the two most notable impostors, the first, Lambert Simnel, personated the earl of Warwick, son of the duke of Clarence, a youth of seventeen whom Henry had at his accession taken care to imprison in the Tower. Simnel, who was but a boy, was taken over to Ireland to perform his part, and the farce was wonderfully successful. He was crowned as Edward VI. in Christchurch Cathedral, Dublin, and received the allegiance of every one—bishops, nobles and judges, alike with others. From Ireland, accompanied by some bands of German mercenaries procured for him in the Low Countries, he invaded England; but the rising was put down at Stoke near Newark in Nottinghamshire, and, Simnel being captured, the king made him a menial of his kitchen.

This movement had been greatly assisted by Margaret, duchess dowager of Burgundy, sister of Edward IV., who could not endure to see the House of York supplanted by that of Tudor. The second pretender, Perkin Warbeck, was also much indebted to her support; but he seems to have entered on his career at first without it. And his story, which was more prolonged, had to do with the attitude of many countries towards England. Anxious as Henry was to avoid being involved in foreign wars, it was not many years before he was committed to a war with France, partly by his desire of an alliance with Spain, and partly by the indignation of his own subjects at the way in which the French were undermining the independence of Brittany. Henry gave Brittany defensive aid; but after the duchess Anne had married Charles VIII. of France, he felt bound to fulfil his obligations to Ferdinand and Isabella of Spain, and also to the German king Maximilian, by an invasion of France in 1492. His allies, however, were not equally scrupulous or equally able to fulfil their obligations to him; and after besieging Boulogne for some little time, he received very advantageous offers from the French king and made peace with him.

Now Perkin Warbeck had first appeared in Ireland in 1492, and had somehow been persuaded there to personate Richard, duke of York, the younger of the two princes murdered in the Tower, pretending that he had escaped, though his brother had been killed. Charles VIII., then expiring war with England, called him to France, recognized his pretensions and gave him a retinue; but after the peace he dismissed him. Then Margaret of Burgundy received him as her nephew, and Maximilian, now estranged from Henry, recognized him as king of England. With a fleet given him by Maximilian he attempted to land at Deal, but sailed away to Ireland and, not succeeding very well there either, sailed farther to Scotland, where James IV. received him with open arms, married him to an earl's daughter and made a brief and futile invasion of England along with him. But in 1497 he thought best to dismiss him, and Perkin, after attempting something again in Ireland, landed in Cornwall with a small body of men.

Already Cornwall had risen in insurrection that year, not liking the taxation imposed for the purpose of repelling the Scotch invasion. A host of the country people, led first by a blacksmith, but afterwards by a nobleman, marched up towards London and were only defeated at Blackheath. But the Cornishmen were quite ready for another revolt, and indeed had invited Perkin to their shores. He had little fight in him, however, and after a futile siege of Exeter and an advance to Taunton he stole away and took sanctuary at Beaulieu in Hampshire. But, being assured of his life, he surrendered, was brought to London, and was only executed two years later, when, being imprisoned near the earl of Warwick in the Tower, he inveigled that simple-minded youth into a project of escape. For this Warwick, too, was tried, condemned and executed—no doubt to deliver Henry from repeated conspiracies in his favour.

Henry had by this time several children, of whom the eldest, Arthur, had been proposed in infancy for a bridegroom to Catherine, daughter of Ferdinand of Aragon. The match had always been kept in view, but its completion depended greatly on the assurance Ferdinand and Isabella could feel of Henry's secure position upon the throne. At last Catherine was brought

to England and was married to Prince Arthur at St Paul's on the 14th of November 1501. The lad was just over fifteen and the co-habitation of the couple was wisely delayed; but he died on the 2nd of April following. Another match was presently proposed for Catherine with the king's second son, Henry, which only took effect when the latter had become king himself. Meanwhile Henry's eldest daughter Margaret was married to James IV. of Scotland—a match distinctly intended to promote international peace, and make possible that ultimate union which actually resulted from it. The espousals had taken place at Richmond in 1502, and the marriage was celebrated in Scotland the year after. In the interval between these two events Henry lost his queen, who died on the 11th of February 1503, and during the remainder of his reign he made proposals in various quarters for a second marriage—proposals in which political objects were always the chief consideration; but none of them led to any result. In his latter years he became unpopular from the extortions practised by his two instruments, Empson and Dudley, under the authority of antiquated statutes. From the beginning of his reign he had been accumulating money, mainly for his own security against intrigues and conspiracies, and avarice had grown upon him with success. He died in April 1509, undoubtedly the richest prince in Christendom. He was not a niggard, however, in his expenditure. Before his death he had finished the hospital of the Savoy and made provision for the magnificent chapel at Westminster which bears his name. His money-getting was but part of his statesmanship, and for his statesmanship his country owes him not a little gratitude. He not only terminated a disastrous civil war and brought under control the spirit of ancient feudalism, but with a clear survey of the conditions of foreign powers he secured England in almost uninterrupted peace while he developed her commerce, strengthened her slender navy and built, apparently for the first time, a naval dock at Portsmouth.

In addition to his sons Arthur and Henry, Henry VII. had several daughters, one of whom, Margaret, married James IV., king of Scotland, and another, Mary, became the wife of Louis XII. of France, and afterwards of Charles Brandon, duke of Suffolk.

The popular view of Henry VII.'s reign has always been derived from Bacon's *History* of that king. This has been edited by J. R. Lumby (Cambridge, 1881). But during the last half century large accessions to our knowledge have been made from foreign and domestic archives, and the sources of Bacon's work have been more critically examined. For a complete account of those sources the reader may be referred to W. Bush's *England under the Tudors*, published in German in 1892 and in an English translation in 1893. Some further information of a special kind will be found in M. Oppenheim's *Naval Accounts and Inventories*, published by the Navy Records Society in 1896. See also J. Gairdner's *Henry VII.* (1889).

HENRY VIII. (1491-1547), king of England and Ireland, the third child and second son of Henry VII. and Elizabeth of York; was born on the 28th of June 1491 and, like all the Tudor sovereigns except Henry VII., at Greenwich. His two brothers, Prince Arthur and Edmund, duke of Somerset, and two of his sisters predeceased their father; Henry was the only son, and Margaret, afterwards queen of Scotland, and Mary, afterwards queen of France and duchess of Suffolk, were the only daughters who survived. Henry is said, on authority which has not been traced farther back than Paolo Sarpi, to have been destined for the church; but the story is probably a mere surmise from his theological accomplishments, and from his earliest years high secular posts such as the vicerealty of Ireland were conferred upon the child. He was the first English monarch to be educated under the influence of the Renaissance, and his tutors included the poet Skelton; he became an accomplished scholar, linguist, musician and athlete, and when by the death of his brother Arthur in 1502 and of his father on the 22nd of April 1509 Henry VIII. succeeded to the throne, his accession was hailed with universal acclamation.

He had been betrothed to his brother's widow Catherine of Aragon, and in spite of the protest which he had been made to register against the marriage, and of the doubts expressed by Julius II. and Archbishop Warham as to its validity, it was

completed in the first few months of his reign. This step was largely due to the pressure brought to bear by Catherine's father Ferdinand upon Henry's council; he regarded England as a tool in his hands and Catherine as his resident ambassador. The young king himself at first took little interest in politics, and for two years affairs were managed by the pacific Richard Fox (q.v.) and Warham. Then Wolsey became supreme, while Henry was immersed in the pursuit of sport and other amusements. He took, however, the keenest interest from the first in learning and in the navy, and his inborn pride easily led him to support Wolsey's and Ferdinand's war-like designs on France. He followed an English army across the Channel in 1513, and personally took part in the successful sieges of Therouanne and Tournay and the battle of Guinegate which led to the peace of 1514. Ferdinand, however, deserted the English alliance, and amid the consequent irritation against everything Spanish, there was talk of a divorce between Henry and Catherine (1514), whose issue had hitherto been attended with fatal misfortune. But the renewed antagonism between England and France which followed the accession of Francis I. (1515) led to a rapprochement with Ferdinand; the birth of the lady Mary (1516) held out hopes of the male issue which Henry so much desired; and the question of a divorce was postponed. Ferdinand died in that year (1516) and the emperor Maximilian in 1519. Their grandson Charles V. succeeded them both in all their realms and dignities in spite of Henry's hardly serious candidature for the empire; and a lifelong rivalry broke out between him and Francis I. Wolsey used this antagonism to make England arbiter between them; and both monarchs sought England's favour in 1520, Francis at the Field of Cloth of Gold and Charles V. more quietly in Kent. At the conference of Calais in 1521 English influence reached its zenith; but the alliance with Charles destroyed the balance on which that influence depended. Francis was overweighed, and his defeat at Pavia in 1525 made the emperor supreme. Feeble efforts to challenge his power in Italy provoked the sack of Rome in 1527; and the peace of Cambrai in 1529 was made without any reference to Wolsey or England's interests.

Meanwhile Henry had been developing a serious interest in politics, and he could brook no superior in whatever sphere he wished to shine. He began to adopt a more critical attitude towards Wolsey's policy, foreign and domestic; and to give ear to the murmurs against the cardinal and his ecclesiastical rule. Parliament had been kept at arm's length since 1515 lest it should attack the church; but Wolsey's expensive foreign policy rendered recourse to parliamentary subsidies indispensable. When it met in 1523 it refused Wolsey's demands, and forced loans were the result which increased the cardinal's unpopularity. Nor did success abroad now blunt the edge of domestic discontent. His fate, however, was sealed by his failure to obtain a divorce for Henry from the papal court. The king's hopes of male issue had been disappointed, and by 1526 it was fairly certain that Henry could have no male heir to the throne while Catherine remained his wife. There was Mary, but no queen regnant had yet ruled in England; Margaret Beaufort had been passed over in favour of her son in 1485, and there was a popular impression that women were excluded from the throne. No candidate living could have secured the succession without a recurrence of civil war. Moreover the unexampled fatality which had attended Henry's issue revived the theological scruples which had always existed about the marriage; and the breach with Charles V. in 1527 provoked a renewal of the design of 1514. All these considerations were magnified by Henry's passion for Anne Boleyn, though she certainly was not the sole or the main cause of the divorce. That the succession was the main point is proved by the fact that Henry's efforts were all directed to securing a wife and not a mistress. Wolsey persuaded him that the necessary divorce could be obtained from Rome, as it had been in the case of Louis XII. of France and Margaret of Scotland. For a time Clement VII. was inclined to concede the demand, and Campeggio in 1528 was given ample powers. But the prospect of French success in Italy which had encouraged the

pope proved delusive, and in 1529 he had to submit to the yoke of Charles V. This involved a rejection of Henry's suit, not because Charles cared anything for his aunt, but because a divorce would mean disinheriting Charles's cousin Mary, and perhaps the eventual succession of the son of a French princess to the English throne.

Wolsey fell when Campeggio was recalled, and his fall involved the triumph of the anti-ecclesiastical party in England. Laymen who had resented their exclusion from power were now promoted to offices such as those of lord chancellor and lord privy seal which they had rarely held before; and parliament was encouraged to propound lay grievances against the church. On the support of the laity Henry relied to abolish papal jurisdiction and reduce clerical privilege and property in England; and by a close alliance with Francis I. he insured himself against the enmity of Charles V. But it was only gradually that the breach was completed with Rome. Henry had defended the papacy against Luther in 1521 and had received in return the title "defender of the faith." He never liked Protestantism, and he was prepared for peace with Rome on his own terms. Those terms were impossible of acceptance by a pope in Clement VII.'s position; but before Clement had made up his mind to reject them, Henry had discovered that the papacy was hardly worth conciliating. His eyes were opened to the extent of his own power as the exponent of national antipathy to papal jurisdiction and ecclesiastical privilege; and his appetite for power grew. With Cromwell's help he secured parliamentary support, and its usefulness led him to extend parliamentary representation to Wales and Calais, to defend the privileges of Parliament, and to yield rather than forfeit its confidence. He had little difficulty in securing the Acts of Annates, Appeals and Supremacy which completed the separation from Rome, or the dissolution of the monasteries which, by transferring enormous wealth from the church to the crown, really, in Cecil's opinion, ensured the reformation.

The abolition of the papal jurisdiction removed all obstacles to the divorce from Catherine and to the legalization of Henry's marriage with Anne Boleyn (1533). But the recognition of the royal supremacy could only be enforced at the cost of the heads of Sir Thomas More, Bishop Fisher and a number of monks and others among whom the Carthusians signalized themselves by their devotion (1535-1536). Anne Boleyn fared no better than the Catholic martyrs; she failed to produce a male heir to the throne, and her conduct afforded a jury of peers, over which her uncle, the duke of Norfolk, presided, sufficient excuse for condemning her to death on a charge of adultery (1536). Henry then married Jane Seymour, who was obnoxious to no one, gave birth to Edward VI., and then died (1537). The dissolution of the monasteries had meanwhile evoked a popular protest in the north, and it was only by skillful and unscrupulous diplomacy that Henry was enabled to suppress so easily the Pilgrimage of Grace. Foreign intervention was avoided through the renewal of war between Francis and Charles; and the insurgents were hampered by having no rival candidate for the throne and no means of securing the execution of their programme.

Nevertheless their rising warned Henry against further doctrinal change. He had authorized the English Bible and some approach towards Protestant doctrine in the Ten Articles. He also considered the possibility of a political and theological alliance with the Lutheran princes of Germany. But in 1538 he definitely rejected their theological terms, while in 1539-1540 they rejected his political proposals. By the statute of Six Articles (1539) he took his stand on Catholic doctrine; and when the Lutherans had rejected his alliance, and Cromwell's nominee, Anne of Cleves, had proved both distasteful on personal grounds and unnecessary because Charles and Francis were not really projecting a Catholic crusade against England, Anne was divorced and Cromwell beheaded. The new queen Catherine Howard represented the triumph of the reactionary party under Gardiner and Norfolk; but there was no idea of returning to the papal obedience, and even Catholic orthodoxy as represented

by the Six Articles was only enforced by spasmodic outbursts of persecution and vain attempts to get rid of Cranmer.

The secular importance of Henry's activity has been somewhat obscured by his achievements in the sphere of ecclesiastical politics; but no small part of his energies was devoted to the task of expanding the royal authority at the expense of temporal competitors. Feudalism was not yet dead, and in the north and west there were medieval franchises in which the royal writ and common law hardly ran at all. Wales and its marches were brought into legal union with the rest of England by the statutes of Wales (1534-1536); and after the Pilgrimage of Grace the Council of the North was set up to bring into subjection the extensive jurisdictions of the northern earls. Neither they nor the lesser chiefs who flourished on the lack of common law and order could be reduced by ordinary methods, and the Councils of Wales and of the North were given summary powers derived from the Roman civil law similar to those exercised by the Star Chamber at Westminster and the court of Castle Chamber at Dublin. Ireland had been left by Walsey to wallow in its own disorder; but disorder was anathema to Henry's mind, and in 1535 Sir William Skeffington was sent to apply English methods and artillery to the government of Ireland. Sir Anthony St Leger continued his policy from 1540; Henry, instead of being merely lord of Ireland dependent on the pope, was made by an Irish act of parliament king, and supreme head of the Irish church. Conciliation was also tried with some success; plantation schemes were rejected in favour of an attempt to Anglicize the Irish; their chieftains were created earls and endowed with monastic lands; and so peaceful was Ireland in 1542 that the lord-deputy could send Irish kernes and gallowglasses to fight against the Scots.

Henry, however, seems to have believed as much in the coercion of Scotland as in the conciliation of Ireland. Margaret Tudor's marriage had not reconciled the realms; and as soon as James V. became a possible pawn in the hands of Charles V., Henry bethought himself of his old claims to suzerainty over Scotland. At first he was willing to subordinate them to an attempt to win over Scotland to his anti-papal policy, and he made various efforts to bring about an interview with his nephew. But James V. was held aloof by Beaton and two French marriages; and France was alarmed by Henry's growing friendliness with Charles V., who was mollified by his cousin Mary's restoration to her place in the succession to the throne. In 1542 James madly sent a Scottish army to ruin at Solway Moss; his death a few weeks later left the Scottish throne to his infant daughter Mary Stuart, and Henry set to work to secure her hand for his son Edward and the recognition of his own suzerainty. A treaty was signed with the Scottish estates; but it was torn up a few months later under the influence of Beaton and the queen-dowager Mary of Guise, and Hertford was sent in 1544 to punish this breach of promise by sacking Edinburgh.

Perhaps to prevent French intervention in Scotland Henry joined Charles V. in invading France, and captured Boulogne (Sept. 1544). But Charles left his ally in the lurch and concluded the peace of Crépy that same month; and in 1545 Henry had to face alone a French invasion of the Isle of Wight. This attack proved abortive, and peace between England and France was made in 1546. Charles V.'s desertion inclined Henry to listen to the proposals of the threatened Lutheran princes, and the last two years of his reign were marked by a renewed tendency to advance in a Protestant direction. Catherine Howard had been brought to the block (1542) on charges in which there was probably a good deal of truth, and her successor, Catherine Parr, was a patroness of the new learning. An act of 1545 dissolved chantries, colleges and other religious foundations; and in the autumn of 1546 the Spanish ambassador was anticipating further anti-ecclesiastical measures. Gardiner had almost been sent to the Tower, and Norfolk and Surrey were condemned to death, while Cranmer asserted that it was Henry's intention to convert the mass into a communion service. An opportunist to the last, he would readily have sacrificed any theological convictions he

may have had in the interests of national uniformity. He died on the 28th of January 1547, and was buried in St. George's Chapel, Windsor.

The atrocity of many of Henry's acts, the novelty and success of his religious policy, the apparent despotism of his methods, or all combined, have made it difficult to estimate calmly the importance of Henry's work or the conditions which made it possible. Henry's egotism was profound, and personal motives underlay his public action. While political and ecclesiastical conditions made the breach with Rome possible—and in the view of most Englishmen desirable—Henry VIII. was led to adopt the policy by private considerations. He worked for the good of the state because he thought his interests were bound up with those of the nation; and it was the real coincidence of this private and public point of view that made it possible for so selfish a man to achieve so much for his country. The royal supremacy over the church and the means by which it was enforced were harsh and violent expedients; but it was of the highest importance that England should be saved from religious civil war, and it could only be saved by a despotic government. It was necessary for the future development of England that its governmental system should be centralized and unified, that the authority of the monarchy should be more firmly extended over Wales and the western and northern borders, and that the still existing feudal franchises should be crushed; and these objects were worth the price paid in the methods of the Star Chamber and of the Councils of the North and of Wales. Henry's work on the navy requires no apology; without it Elizabeth's victory over the Spanish Armada, the liberation of the Netherlands and the development of English colonies would have been impossible; and "of all others the year 1545 best marks the birth of the English naval power" (Corbett, *Drake*, i. 59). His judgment was more at fault when he conquered Boulogne and sought by violence to bring Scotland into union with England. But at least Henry appreciated the necessity of union within the British Isles; and his work in Ireland laid the foundations of English rule. No less important was his development of the parliamentary system. Representation was extended to Wales, Cheshire, Berwick and Calais; and parliamentary authority was enhanced, largely that it might deal with the church, until men began to complain of this new parliamentary infallibility. The privileges of the two Houses were encouraged and expanded, and parliament was led to exercise ever wider powers. This policy was not due to any belief on Henry's part in parliamentary government, but to opportunism, to the circumstance that parliament was willing to do most of the things which Henry desired, while competing authorities, the church and the old nobility, were not. Nevertheless, to the encouragement given by Henry VIII. parliament owed not a little of its future growth, and to the aid rendered by parliament Henry owed his success.

He has been described as a "despot under the forms of law"; and it is apparently true that he committed no illegal act. His despotism consists not in any attempt to rule unconstitutionally, but in the extraordinary degree to which he was able to use constitutional means in the furtherance of his own personal ends. His industry, his remarkable political insight, his lack of scruple, and his combined strength of will and subtlety of intellect enabled him to utilize all the forces which tended at that time towards strong government throughout western Europe. In Michelet's words, "le nouveau Messie est le roi"; and the monarchy alone seemed capable of guiding the state through the social and political anarchy which threatened all nations in their transition from medieval to modern organisation. The king was the emblem, the focus and the bond of national unity; and to preserve it men were ready to put up with vagaries which to other ages seem intolerable. Henry could thus behold ministers and divorce wives with comparative impunity, because the individual appeared to be of little importance compared with the state. This impunity provoked a licence which is responsible for the unlovely features of Henry's reign and character. The elevation and the isolation of his position fostered a detachment from ordinary virtues and compassion,

and he was a remorseless incarnation of Machiavelli's *Prince*. He had an elastic conscience which was always at the beck and call of his desire, and he cared little for principle. But he had a passion for efficiency, and for the greatness of England and himself. His mind, in spite of its clinging to the outward forms of the old faith, was intensely secular; and he was as devoid of a moral sense as he was of a genuine religious temperament. His greatness consists in his practical aptitude, in his political perception, and in the self-restraint which enabled him to confine within limits tolerable to his people an insatiable appetite for power.

The original materials for Henry VIII.'s biography are practically all incorporated in the monumental *Letters and Papers of the Reign of Henry VIII.* (21 vols.), edited by Brewer and Gairdner and completed after fifty years' labour in 1910. A few further details may be gleaned from such contemporary sources as Hall's *Chronicle*, Cavendish's *Life of Wolsey*, W. Thomas's *The Pilgrim* and others; and some additions have been made to the documentary sources contained in the *Letters and Papers* by recent works, such as Ehaes' *Römische Dokumente*, and Merriman's *Life and Letters of Thomas Cromwell*. Lord Herbert of Cherbury's *Life and Reign of Henry VIII.* (1649), while good for its time, is based upon a very partial knowledge of the sources and somewhat antiquated principles of historical scholarship. Froude's famous portrait of Henry is coloured by the ideas of hero-worship and history which the author imbibed from Carlyle, and the rival portraits in Lingard, R. W. Dixon's *Church History* and Gasquet's *Henry VIII. and the Monasteries* by strong religious feeling. A more discriminating estimate is attempted by H. A. L. Fisher in Messrs Longmans' *Political History of England*, vol. v. (1906). Of the numerous paintings of Henry none is by Holbein, who, however, executed the striking chalk-drawing of Henry's head, now at Munich, and the famous but decaying cartoon at Devonshire House. The well-known three-quarter length at Windsor, usually attributed to Holbein, is by an inferior artist. The best collection of Henry's portraits was exhibited at the Burlington Fine Arts Club in 1909, and the catalogue of that exhibition contains the best description of them; several are reproduced in Pollard's *Henry VIII.* (Gouppil) (1902), the letterpress of which was published by Longmans in a cheaper edition (1905). Henry composed numerous state papers still extant; his only book was his *Assertio septem sacramentorum contra M. Lutherum* (1521), a copy of which, signed by Henry himself, is at Windsor. Several anthems composed by him are extant; and one at least, *O Lord, the Maker of all Things*, is still occasionally rendered in English cathedrals. (A. F. P.)

HENRY I. (1214-1217), king of Castile, son of Alphonso VIII. of Castile, and his wife Eleanor of Aquitaine, daughter of Henry II. of England, after whom he was named, was born about 1207. He was killed, while still a boy, by the fall of a tile from a roof.

HENRY II. of Trastamara (1360-1379), king of Castile, founder of the dynasty known as "the new kings," was the eldest son of Alphonso XI. and of his mistress Leonora de Guzman. He was born in 1333. His father endowed him with great lordships in northern Spain, and made him count of Trastamara. After the death of Alphonso XI. in 1350, Leonora was murdered to satisfy the revenge of the king's neglected wife. Several of the numerous children she had borne to Alphonso were slain at different times by Peter the Cruel, the king's legitimate son and successor. Henry preserved his life by submissions and by keeping out of the king's way. At last, after taking part in several internal commotions, he fled to France in 1356. In 1366 he persuaded the mercenary soldiers paid off by the kings of England and France to accompany him on an expedition to upset Peter, who was driven out. The Black Prince having intervened on behalf of Peter, Henry was defeated at Najera (3rd of April 1367) and had again to flee to Aragon. When the Black Prince was told that "the Bastard" had neither been slain nor taken, he said that nothing had been done. And so it turned out; for, when the Black Prince had left Spain, Henry came back with a body of French soldiers of fortune under du Guesclin, and drove his brother into the castle of Montiel in La Mancha. Peter was tempted out by du Guesclin, and the half brothers met in the Frenchman's tent. They rushed at one another, and Peter, the stronger man, threw Henry down, and fell on him. One of Henry's pages seized the king by the leg and threw him on his back. Henry then pulled up Peter's hauberk and stabbed him mortally in the stomach, on the 23rd of March

1369. He reigned for ten years, with some success both in pacifying the kingdom and in war with Portugal. But as his title was disputed he was compelled to purchase support by vast grants to the nobles and concessions to the cities, by which he gained the title of *El de las Mercedes*—he of the largesse. Henry was a strong ally of the French king in his wars with the English, who supported the claims of Peter's natural daughters. He died on the 30th of May 1379.

HENRY III. (1300-1406) king of Castile, called *El Doliente*, the Sufferer, was the son of John I. of Castile and Leon, and of his wife Beatrice, daughter of Ferdinand of Portugal. He was born in 1379. The period of minority was exceptionally anarchical, even for Castile, but as the cities, always the best supporters of the royal authority, were growing in strength, Henry was able to reduce his kingdom to obedience, and, when he took the government into his own hands after 1393, to compel his nobles with comparative ease to surrender the crown lands they had seized. The meeting of the Cortes summoned by him at Madrid in 1394 marked a great epoch in the establishment of a practically despotic royal authority, based on the consent of the commons, who looked to the crown to protect them against the excesses of the nobles. Henry strengthened his position still further by his marriage with Catherine, daughter of John of Gaunt and of Constance, elder daughter of Peter the Cruel and Maria de Padilla. This union combined the rival claims of the descendants of Peter and of Henry of Trastamara. The king's bodily weakness limited his real capacity, and his early death on the 25th of December 1406 cut short the promise of his reign.

HENRY IV. (1453-1474), king of Castile, surnamed the Impotent, or the Spendthrift, was the son of John II. of Castile and Leon, and of his wife, Mary, daughter of Ferdinand I. of Aragon and Sicily. He was born at Valladolid on the 6th of January 1425. The surnames given to this king by his subjects are of much more than usual accuracy. His personal character was one of mere weakness, bodily and mental. Henry was an undutiful son, and his reign was one long period of confusion, marked by incidents of the most ignominious kind. He divorced his first wife Blanche of Navarre in 1455 on the ground of "mutual impotence." Yet in 1468 he married Joan of Portugal, and when she bore a daughter, first repudiated her as adulterine, and then claimed her for his own. In 1460 he was solemnly deposed in favour of his brother Alphonso, on whose death in the same year his authority was again recognized. The last years of his life were spent in vain endeavours, first to force his half-sister Isabella, afterwards queen, to marry his favourite, the Master of Santiago, and then to exclude her from the throne. Henry died at Madrid on the 12th of December 1474.

HENRY I. (1008-1060), king of France, son of King Robert and his queen, Constance of Aquitaine, and grandson of Hugh Capet, came to the throne upon the death of his father in 1031, although in 1027 he had been anointed king at Reims and associated in the government with his father. His mother, who favoured her younger son Robert, and had retired from court upon Henry's coronation, formed a powerful league against him, and he was forced to take refuge with Robert II., duke of Normandy. In the civil war which resulted, Henry was able to break up the league of his opponents in 1032. Constance died in 1034, and the rebel brother Robert was given the duchy of Burgundy, thus founding that great collateral line which was to rival the kings of France for three centuries. Henry atoned for this by a reign marked by unceasing struggle against the great barons. From 1033 to 1043 he was involved in a life and death contest with those nobles whose territory adjoined the royal domains, especially with the great house of Blois, whose count, Odo II., had been the centre of the league of Constance, and with the counts of Champagne. Henry's success in these wars was largely due to the help given him by Robert of Normandy, but upon the accession of Robert's son William (the Conqueror), Normandy itself became the chief danger. From 1047 to the year of his death, Henry was almost constantly at war with William, who held his own against the king's formidable leagues and beat back two royal invasions, in 1053 and 1058. Henry's reign

marks the height of feudalism. The Normans were independent of him, with their frontier barely 25 m. west of Paris; to the south his authority was really bound by the Loire; in the east the count of Champagne was little more than nominally his subject, and the duchy of Burgundy was almost entirely cut off from the king. Yet Henry maintained the independence of the clergy against the pope Leo IX., and claimed Lorraine from the emperor Henry III. In an interview at Ivois, he reproached the emperor with the violation of promises, and Henry III. challenged him to a single combat. According to the German chronicler—which French historians doubt—the king of France declined the combat and fled from Ivois during the night. In 1059 he had his eldest son Philip crowned as joint king, and died the following year. Henry's first wife was Maud, niece of the emperor Henry III., whom he married in 1043. She died childless in 1044. Historians have sometimes confused her with Maud (or Matilda), the emperor Conrad II.'s daughter, to whom Henry was affianced in 1033, but who died before the marriage. In 1051 Henry married the Russian princess Anne, daughter of Yaroslav I., grand duke of Kiev. She bore him two sons, Philip, his successor, and Hugh the great, count of Vermandois.

See the *Historiae* of Rudolph Glaber, edited by M. Pagan (Paris, 1886); F. Sochnée, *Catalogue des actes d'Henri I^{er}* (1907); de Caiz de Saint Aymour, *Anne de Russie, reine de France* (1896); E. Lavisse, *Histoire de France*, tome ii. (1901), and the article on Henry I. in *La Grande Encyclopédie* by M. Prota.

HENRY II. (1519–1559), king of France, the second son of Francis I. and Claude, succeeded to the throne in 1547. When only seven years old he was sent by his father, with his brother the dauphin Francis, as a hostage to Spain in 1526, whence they returned after the conclusion of the peace of Cambrai in 1530. Henry was too young to have carried away any abiding impressions, yet throughout his life his character, dress and bearing were far more Spanish than French. In 1533 his father married him to Catherine de' Medici, from which match, as he said, Francis hoped to gain great advantage, even though it might be somewhat of a misalliance. In 1536 Henry, hitherto duke of Orleans, became dauphin by the death of his elder brother Francis. From that time he was under the influence of two personages, who dominated him completely for the remainder of his life—Diane de Poitiers, his mistress, and Anne de Montmorency, his mentor. Moreover, his younger brother, Charles of Orleans, who was of a more sprightly temperament, was his father's favourite; and the rivalry of Diane and the duchesse d'Étampes helped to make still wider the breach between the king and the dauphin. Henry supported the constable Montmorency when he was disgraced in 1541; protested against the treaty of Crépy in 1544; and at the end of the reign held himself completely aloof. His accession in 1547 gave rise to a veritable revolution at the court. Diane, Montmorency and the Guises were all-powerful, and dismissed Cardinal de Tournon, de Longueval, the duchesse d'Étampes and all the late king's friends and officials. At that time Henry was twenty-eight years old. He was a robust man, and inherited his father's love of violent exercise; but his character was weak and his intelligence mediocre, and he had none of the superficial and brilliant gifts of Francis I. He was cold, haughty, melancholy and dull. He was a bigoted Catholic, and showed to the Protestants even less mercy than his father. During his reign the royal authority became more severe and more absolute than ever. Resistance to the financial extortions of the government was cruelly chastised, and the "Chambre Ardente" was instituted against the Reformers. Abroad, the struggle was continued against Charles V. and Philip II., which ended in the much-discussed treaty of Cateau-Cambrésis. Some weeks afterwards high feast was held on the occasion of the double marriage of the king's daughter Elizabeth with the king of Spain, and of his sister Margaret with the duke of Savoy. On the 30th of June 1559, when tilting with the count of Montgomery, Henry was wounded in the temple by a lance. In spite of the attentions of Ambroise Paré he died on the 10th of July. By his wife Catherine de' Medici he had seven children living: Elizabeth, queen of Spain;

Claude, duchess of Lorraine; Francis (II.), Charles (IX.) and Henry (III.), all of whom came to the throne; Marguerite, who became queen of Navarre in 1572; and Francis, duke of Alençon and afterwards of Anjou, who died in 1584.

The bulk of the documents for the reign of Henry II. are unpublished, and are in the Bibliothèque Nationale, Paris. Of the published documents, see especially the correspondence of Catherine de' Medici (ed. by de la Ferrière, Paris, 1880), of Diane de Poitiers (ed. by Guiffrey, Paris, 1866), of Antoine de Bourbon and Jeanne d'Albret (ed. by Rochambeau, Paris, 1877), of Odet de Selve, ambassador to England (ed. by Lefèvre-Fontalis, Paris, 1888) and of Dominique du Gabre, ambassador to Venice (ed. by Vitalis, Paris, 1903); Ribier, *Lettres et mémoires d'état* (Paris, 1666); *Relations des ambassadeurs vénitiens*, &c. Of the contemporary memoirs and histories, see Brantôme (ed. by Lalanne, Paris, 1864–1882), François de Lorraine (ed. by Michaud and Poujoulat, Paris, 1839), Montluc (ed. by de Ruble, Paris, 1864), F. de Boyvin du Villars (Michaud and Poujoulat), F. de Rabutin (*Pantheon littéraire*, Paris, 1836). See also de Thou, *Historia sui temporis* . . . (London, 1733); Decrue, *Anne de Montmorency* (Paris, 1889); H. Forneron, *Les Ducs de Guise et leur époque*, vol. i. (Paris, 1877); and H. Lemonnier, "La France sous Henri II." (Paris, 1904), in the *Histoire de France*, by E. Lavisse, which contains a fuller bibliography of the subject.

HENRY III. (1551–1589), king of France, third son of Henry II. and Catherine de' Medici, was born at Fontainebleau on the 19th of September 1551, and succeeded to the throne of France on the death of his brother Charles IX. in 1574. In his youth, as duke of Anjou, he was warmly attached to the Huguenot opinions, as we learn from his sister Marguerite de Valois; but his unstable character soon gave way before his mother's will, and both Henry and Marguerite remained choice ornaments of the Catholic Church. Henry won, under the direction of Marshal de Tavannes, two brilliant victories at Jarnac and Moncontour (1569). He was the favourite son of his mother, and took part with her in organizing the massacre of St. Bartholomew. In 1573 Catherine procured his election to the throne of Poland. Passionately enamoured of the princess of Condé, he set out reluctantly to Warsaw, but, on the death of his brother Charles IX. in 1574, he escaped from his Polish subjects, who endeavoured to retain him by force, came back to France and assumed the crown. He returned to a wretched kingdom, torn with civil war. In spite of his good intentions, he was incapable of governing, and abandoned the power to his mother and his favourites. Yet he was no dullard. He was a man of keen intelligence and cultivated mind, and deserves as much as Francis I. the title of patron of letters and art. But his incurable indolence and love of pleasure prevented him from taking any active part in affairs. Surrounded by his *mignons*, he scandalized the people by his effeminate manners. He dressed himself in women's clothes, made a collection of little dogs and hid in the cellars when it thundered. The disgust aroused by the vices and effeminacy of the king increased the popularity of Henry of Guise. After the "day of the barricades" (the 12th of May 1588), the king, perceiving that his influence was lost, resolved to rid himself of Guise by assassination; and on the 23rd of December 1588 his faithful bodyguard, the "forty-five," carried out his design at the château of Blois. But the fanatical preachers of the League clamoured furiously for vengeance, and on the 1st of August 1589, while Henry III. was investing Paris with Henry of Navarre, Jacques Clement, a Dominican friar, was introduced into his presence on false letters of recommendation, and plunged a knife into the lower part of his body. He died a few hours afterwards with great fortitude. By his wife Louise of Lorraine, daughter of the count of Vaudémont, he had no children, and on his deathbed he recognized Henry of Navarre as his successor.

See the memoirs and chronicles of l'Estoile, Villeroy, Ph. Hurault de Cheverny, Brantôme, Marguerite de Valois, la Huguerye, du Plessis-Mornay, &c.; *Archives curieuses* of Cimber and Danjou, vols. x. and xi.; *Mémoires de la Ligue* (new ed., Amsterdam, 1758); the histories of T. A. d'Aubigné and J. A. de Thou; Correspondence of Catherine de' Medici and of Henry IV. (in the *Collection de documents inédits*), and of the Venetian ambassadors, &c.; P. Matthieu, *Histoire de France*, vol. i. (1631); Scipion Dupleix, *Histoire de Henri III* (1633); Robiquet, *Paris et la Ligue* (1886); and J. H. Mariéjol, "La Réforme et la Ligue," in the *Histoire de France*, by E. Lavisse (Paris, 1904), which contains a more complete bibliography.

HENRY IV. (1553-1610), king of France, the son of Antoine de Bourbon, duke of Vendôme, head of the younger branch of the Bourbons, descendant of Robert of Clermont, sixth son of St Louis and of Jeanne d'Albret, queen of Navarre, was born at Pau (Basses Pyrénées) on the 14th of December 1553. He was educated as a Protestant, and in 1557 was sent to the court at Amiens. In 1561 he entered the Collège de Navarre at Paris, returning in 1565 to Béarn. During the third war of religion in France (1568-1570) he was taken by his mother to Gaspard de Coligny, leader of the Protestant forces since the death of Louis I., prince of Condé, at Jarnac, and distinguished himself at the battle of Arnay-le-Duc in Burgundy in 1569. On the 9th of June 1572, Jeanne d'Albret died and Henry became king of Navarre, marrying Margaret of Valois, sister of Charles IX. of France, on the 18th of August of that year. He escaped the massacre of St Bartholomew on the 24th of August by a feigned abjuration. On the 2nd of February 1576, after several vain attempts, he escaped from the court, joined the combined forces of Protestants and of opponents of the king, and obtained by the treaty of Beaulieu (1576) the government of Guienne. In 1577 he secured the treaty of Bergerac, which foreshadowed the edict of Nantes. As a result of quarrels with his unworthy wife, and the unwelcome intervention of Henry III., he undertook the seventh war of religion, known as the "war of the lovers" (*des amoureux*), seized Cahors on the 5th of May 1580, and signed the treaty of Fleix on the 26th of November 1580. On the 10th of June 1584 the death of Monsieur, the duke of Anjou, brother of King Henry III., made Henry of Navarre heir presumptive to the throne of France. Excluded from it by the treaty of Nemours (1585) he began the "war of the three Henrys" by a campaign in Guienne (1586) and defeated Anne, duc de Joyeuse, at Coutras on the 20th of October 1587. Then Henry III., driven from Paris by the League on account of his murder of the duke of Guise at Blois (1588), sought the aid of the king of Navarre to win back his capital, recognizing him as his heir. The assassination of Henry III. on the 1st of August 1589 left Henry king of France; but he had to struggle for ten more years against the League and against Spain before he won his kingdom. The main events in that long struggle were the victory of Arques over Charles, duke of Mayenne, on the 28th of September 1589; of Ivry, on the 14th of March 1590; the siege of Paris (1590); of Rouen (1592); the meeting of the Estates of the League (1593), which the *Saïre Menippée* turned to ridicule; and finally the conversion of Henry IV. to Catholicism in July 1593—an act of political wisdom, since it brought about the collapse of all opposition. Paris gave in to him on the 22nd of March 1594 and province by province yielded to arms or negotiations; while the victory of Fontaine-Française (1595) and the capture of Amiens forced Philip II. of Spain to sign the peace of Vervins on the 2nd of May 1598. On the 13th of April of that year Henry IV. had promulgated the Edict of Nantes.

Then Henry set to work to pacify and restore prosperity to his kingdom. Convinced by the experience of the wars that France needed an energetic central power, he pushed at times his royal prerogatives to excess, raising taxes in spite of the Estates, interfering in the administration of the towns, reforming their constitutions, and holding himself free to reject the advice of the notables if he consulted them. Aided by his faithful friend Maximilien de Béthune, baron de Rosny and duc de Sully (*q.v.*), he reformed the finances, repressed abuses, suppressed useless offices, extinguished the formidable debt and realized a reserve of eighteen millions. To alleviate the distress of the people he undertook to develop both agriculture and industry: planting colonies of Dutch and Flemish settlers to drain the marshes of Saintonge, issuing prohibitive measures against the importation of foreign goods (1597), introducing the silk industry, encouraging the manufacture of cloth, of glass-ware, of tapestries (Gobelins), and under the direction of Sully—named *grand-vooyer de France*—improving and increasing the routes for commerce. A complete system of canals was planned, that of Briare partly dug. New capitulations were concluded with the sultan Ahmed I. (1604) and treaties of commerce with England (1606), with

Spain and Holland. Attempts were made in 1604 and 1608 to colonize Canada (see CHAMPLAIN, SAMUEL DE). The army was reorganized, its pay raised and assured, a school of cadets formed to supply it with officers, artillery constituted and strongholds on the frontier fortified. While lacking the artistic tastes of the Valois, Henry beautified Paris, building the great gallery of the Louvre, finishing the Tuileries, building the Pont Neuf, the Hôtel-de-Ville and the Place Royale.

The foreign policy of Henry IV. was directed against the Habsburgs. Without declaring war, he did all possible harm to them by alliances and diplomacy. In Italy he gained the grand duke of Tuscany—marrying his niece Marie de' Medici in 1600—the duke of Mantua, the republic of Venice and Pope Paul V. The duke of Savoy, who had held back from the treaty of Vervins in 1598, signed the treaty of Lyons in 1601; in exchange for the marquise of Saluzzo, France acquired Bresse, Bugey, Valromey and the bailliage of Gex. In the Low Countries, Henry sent subsidies to the Dutch in their struggle against Spain. He concluded alliances with the Protestant princes in Germany, with the duke of Lorraine, the Swiss cantons (treaty of Soleure, 1602) and with Sweden.

The opening on the 25th of March 1600 of the question of the succession of John William the Good, duke of Cleves, of Jülich and of Berg, led Henry, in spite of his own hesitations and those of his German allies, to declare war on the emperor Rudolph II. But he was assassinated by Ravailiac (*q.v.*) on the 14th of May 1610, upon the eve of his great enterprise, leaving his policy to be followed up later by Richelieu. Sully in his *Economies royales* attributes to his master the "great design" of constituting, after having defeated Austria, a vast European confederation of fifteen states—a "Christian Republic"—directed by a general council of sixty deputies reapportioned every three years. But this "design" has been attributed rather to the imagination of Sully himself than to the more practical policy of the king.

No figure in France has been more popular than that of "Henry the Great." He was affable to the point of familiarity, quick-witted like a true Gascon, good-hearted, indulgent, yet skilled in reading the character of those around him, and he could at times show himself severe and unyielding. His courage amounted almost to recklessness. He was a better soldier than strategist. Although at bottom authoritative he surrounded himself with admirable advisers (Sully, Sillery, Villeroy, Jeannin) and profited from their co-operation. His love affairs, undoubtedly too numerous (notably with Gabrielle d'Estrées and Henriette d'Entragues), if they injure his personal reputation, had no bad effect on his policy as king, in which he was guided only by an exalted ideal of his royal office, and by a sympathy for the common people, his reputation for which has perhaps been exaggerated somewhat in popular tradition by the circumstances of his reign.

Henry IV. had no children by his first wife, Margaret of Valois. By Marie de' Medici he had Louis, later Louis XIII.; Gaston, duke of Orleans; Elizabeth, who married Philip IV. of Spain; Christine, duchess of Savoy; and Henrietta, wife of Charles I. of England. Among his bastards the most famous were the children of Gabrielle d'Estrées—Caesar, duke of Vendôme, Alexander of Vendôme, and Catherine Henriette, duchess of Elbeuf.

Several portraits of Henry are preserved at Paris, in the Bibliothèque Nationale (cf. Bouchot, *Portraits au crayon*, p. 189), at the Louvre (by Probus, bust by Barthélemy Prieur) at Versailles, Geneva (Henry at the age of fifteen), at Hampton Court, at Munich and at Florence.

The works dealing with Henry IV. and his reign are too numerous to be enumerated here. For sources, see the *Recueil des lettres missives de Henri IV.* published from 1899 to 1893 by B. de Xivrey, in the *Collection de documents inédits relatifs à l'histoire de France*, and the various researches of Galitzin, Bautiot, Halphen, Dusseix and others. Besides their historic interest, the letters written personally by Henry, whether love notes or letters of state, reveal a charming writer. Mention should be made of Auguste Poirson's *Histoire du règne de Henri IV.* (2nd ed., 4 vols., Paris, 1860-1867) and of J. H. Mariéjol's volume (vi.) in the *Histoire de France*, edited by Ernest Lavisse (Paris, 1905), where main sources and literature

are given with each chapter. A *Rexum Henri IV* has been founded at Paris (1905). Finally, a complete survey of the sources for the period 1494-1610 is given by Henri Hauser in vol. vii. of *Sources de l'histoire de France* (Paris, 1906) in continuation of A. Molinier's collection of the sources for French history during the middle ages.

HENRY I. (c. 1210-1274), surnamed *le Gros*, king of Navarre and count of Champagne, was the youngest son of Theobald I. king of Navarre by Margaret of Foix, and succeeded his eldest brother Theobald III. as king of Navarre and count of Champagne in December 1270. His proclamation at Pamplona, however, did not take place till March of the following year, and his coronation was delayed until May 1273. After a brief reign, characterized, it is said, by dignity and talent, he died in July 1274, suffocated, according to the generally received accounts, by his own fat. In him the male line of the counts of Champagne and kings of Navarre, became extinct. He married in 1269 Blanche, daughter of Robert, count of Artois, and niece of King Louis IX. and was succeeded by his only legitimate child, Jeanne or Joanna, by whose marriage to Philip IV. afterwards king of France in 1284, the crown of Navarre became united to that of France.

HENRY II. (1503-1555), titular king of Navarre, was the eldest son of Jean d'Albret (d. 1516) by his wife Catherine de Foix, sister and heiress of Francis Phoebus, king of Navarre, and was born at Sanquesa in April 1503. When Catherine died in exile in 1517 Henry succeeded her in her claim on Navarre, which was disputed by Ferdinand I. king of Spain; and under the protection of Francis I. of France he assumed the title of king. After ineffectual conferences at Noyon in 1516 and at Montpellier in 1518, an active effort was made in 1521 to establish him in the *de facto* sovereignty; but the French troops which had seized the country were ultimately expelled by the Spaniards. In 1525 Henry was taken prisoner at the battle of Pavia, but he contrived to escape, and in 1526 married Margaret, the sister of Francis I. and widow of Charles, duke of Alençon. By her he was the father of Jeanne d'Albret (d. 1572), and was consequently the grandfather of Henry IV. of France. Henry, who had some sympathy with the Huguenots, died at Pau on the 25th of May 1555.

HENRY I. (1512-1580), king of Portugal, third son of Emmanuel the Fortunate, was born in Lisbon, on the 31st of January 1512. He was destined for the church, and in 1532 was raised to the archiepiscopal see of Braga. In 1542 he received the cardinal's hat, and in 1578 when he was called to succeed his grandnephew Sebastian on the throne, he held the archbishoprics of Lisbon and Coimbra as well as that of Praga, in addition to the wealthy abbacy of Alcobazar. As an ecclesiastic he was pious, pure, simple in his mode of life, charitable, and a learned and liberal patron of letters; but as a sovereign he proved weak, timid and incapable. On his death in 1580, after a brief reign of seventeen months, the male line of the royal family which traced its descent from Henry, first count of Portugal (c. 1100), came to an end; and all attempts to fix the succession during his lifetime having ignominiously failed, Portugal became an easy prey to Philip II. of Spain.

HENRY II. (1489-1568), duke of Brunswick-Wolfenbüttel, was a son of Duke Henry I., and was born on the 10th of November 1489. He began to reign in 1514, but his brother William objected to the indivisibility of the duchy which had been decreed by the elder Henry, and it was only in 1535, after an imprisonment of eleven years, that William recognized his brother's title. Sharing in an attack on John, bishop of Hildesheim, Henry was defeated at the battle of Soltau in June 1519, but afterwards he was more successful, and when peace was made received some lands from the bishop. In 1525 he assisted Philip, landgrave of Hesse, to crush the rising of the peasants in north Germany, and in 1528 took help to Charles V. in Italy, where he narrowly escaped capture. As a pronounced opponent of the reformed doctrines, he joined the Catholic princes in concerting measures for defence at Dessau and elsewhere, but on the other hand promised Philip of Hesse to aid him in restoring his own brother-in-law Ulrich, duke of Württemberg, to his

duchy. However he gave no assistance when this enterprise was undertaken in 1534, and subsequently the hostility between Philip and himself was very marked. Henry was attacked by Luther with unmeasured violence in a writing *Wider Hans Worst*; but mere serious was his isolation in north Germany. The duke soon came into collision with the Protestant towns of Goslar and Brunswick, against the former of which a sentence of restitution had been pronounced by the imperial court of justice (*Reichskammergericht*). To conciliate the Protestants Charles V. had suspended the execution of this sentence, a proceeding which Henry declared was *ultra vires*. The league of Schmalkalden, led by Philip of Hesse and John Frederick, elector of Saxony, then took up arms to defend the towns; and in 1542 Brunswick was overrun and the duke forced to flee. In September 1545 he made an attempt to regain his duchy, but was taken prisoner by Philip, and only released after the victory of Charles V. at Mühlberg in April 1547. Returning to Brunswick, where he was very unpopular, he soon quarrelled with his subjects both on political and religious questions, while his duchy was ravaged by Albert Alcibiades, prince of Bayreuth. Henry was among the princes who banded themselves together to crush Albert, and after the death of Maurice, elector of Saxony, at Stevershausen in July 1553, he took command of the allied troops and defeated Albert in two engagements. In his later years he became more tolerant, and was reconciled with his Protestant subjects. He died at Wolfenbüttel on the 11th of June 1568. The duke was twice married, firstly in 1515 to Maria (d. 1541), sister of Ulrich of Württemberg, and secondly in 1558 to Sophia (d. 1575) daughter of Sigismund I., king of Poland. He attained some notoriety through his romantic attachment to Eva von Trott, whom he represented as dead and afterwards kept concealed at Staufenburg. Henry was succeeded by his only surviving son, Julius (1528-1589).

See F. Koldewey, *Heins von Wolfenbüttel* (Halle, 1883); and F. Bruns, *Die Vertreibung Herzog Heinrichs von Braunschweig durch den Schmalkaldischen Bund* (Marburg, 1889).

HENRY (c. 1108-1139), surnamed the "Proud," duke of Saxony and Bavaria, second son of Henry the Black, duke of Bavaria, and Wulfhild, daughter of Magnus Billung, duke of Saxony, was a member of the Welf family. His father and mother both died in 1126, and as his elder brother Conrad had entered the church, Henry became duke of Bavaria and shared the family possessions in Saxony, Bavaria and Swabia with his younger brother, Welf. At Whitsuntide 1127 he was married to Gertrude, the only child of the German king, Lothair the Saxon, and at once took part in the warfare between the king and the Hohenstaufen brothers, Frederick II., duke of Swabia, and Conrad, afterwards the German king Conrad III. While engaged in this struggle Henry was also occupied in suppressing a rising in Bavaria, led by Frederick, count of Bogen, during which both duke and count sought to establish their own candidates in the bishopric of Regensburg. After a war of devastation, Frederick submitted in 1133, and two years later the Hohenstaufen brothers made their peace with Lothair. In 1136 Henry accompanied his father-in-law to Italy, and taking command of one division of the German army marched into southern Italy, devastating the land as he went. It was probably about this time that he was invested with the margraviate of Tuscany and the lands of Matilda, the late margravine. Having distinguished himself by his military genius during this campaign Henry left Italy with the German troops, and was appointed by the emperor as his successor in the dukedom of Saxony. When Lothair died in December 1137 Henry's wealth and position made him a formidable candidate for the German throne, but the same qualities which earned for him the surname of "Proud," aroused the jealousy of the princes, and so prevented his election. The new king, Conrad III., demanded the imperial *insignia* which were in Henry's possession, and the duke in return asked for his investiture with the Saxon duchy. But Conrad, who feared his power, refused to assent to this on the pretext that it was unlawful for two duchies to be in one hand. Attempts at a settlement failed, and in July 1138 the duke was placed

under the ban, and Saxony was given to Albert the Bear, afterwards margrave of Brandenburg. War broke out in Saxony and Bavaria, but was cut short by Henry's sudden death at Quedlinburg on the 20th of October 1139. He was buried at Königsutter. Henry was a man of great ability, and his early death alone prevented him from playing an important part in German history. Conrad the Priest, the author of the *Rolandslied*, was in Henry's service, and probably wrote this poem at the request of the duchess, Gertrude.

See S. Riezler, *Geschichte Bayerns*, Band i. (Gotha, 1878); W. Bernhardt, *Lothar von Supplinburg* (Leipzig, 1879); W. von Giesebrecht, *Geschichte der deutschen Kaiserzeit*, Band iv. (Brunswick, 1877).

HENRY (1129-1195), surnamed the "Lion," duke of Saxony and Bavaria, only son of Henry the Proud, duke of Saxony and Bavaria, and Gertrude, daughter of the emperor Lothair the Saxon, was born at Ravensburg, and was a member of the family of Welf. In 1138 the German king Conrad III. had sought to deprive Henry the Proud of his duchies, and when the duke died in the following year the interests of his young son were maintained in Saxony by his mother, and his grandmother Richenza, widow of Lothair, and in Bavaria by his uncle, Count Welf VI. This struggle ended in May 1142 when Henry was invested as duke of Saxony at Frankfort, and Bavaria was given to Henry II., Jasomirgott, margrave of Austria, who married his mother Gertrude. In 1147 he married Clementia, daughter of Conrad, duke of Zähringen (d. 1152), and began to take an active part in administering his dukedom and extending its area. He engaged in a successful expedition against the Abotrites, or Obotrites, in 1147, and won a considerable tract of land beyond the Elbe, in which were re-established the bishoprics of Mecklenburg,¹ Oldenburg² and Ratzeburg. Hartwig, archbishop of Bremen, wished these sees to be under his authority, but Henry contested this claim, and won the right to invest these bishops himself, a privilege afterwards confirmed by the emperor Frederick I. Henry, meanwhile, had not forgotten Bavaria. In 1147 he made a formal claim on this duchy, and in 1151 sought to take possession, but failing to obtain the aid of his uncle Welf, did not effect his purpose. The situation was changed in his favour when Frederick I., who was anxious to count the duke among his supporters, succeeded Conrad as German king in February 1152. Frederick was unable at first to persuade Henry Jasomirgott to abandon Bavaria, but in June 1154 he recognized the claim of Henry the Lion, who accompanied him on his first Italian campaign and distinguished himself in suppressing a rising at Rome, Henry's formal investiture as duke of Bavaria taking place in September 1156 on the emperor's return to Germany. Henry soon returned to Saxony, where he found full scope for his untiring energy. Adolph II., count of Holstein, was compelled to cede Lübeck to him in 1158; campaigns in 1163 and 1164 beat down further resistance of the Abotrites; and Saxon garrisons were established in the conquered lands. The duke was aided in this work by the alliance of Valdemar I., king of Denmark, and, it is said, by engines of war brought from Italy. During these years he had also helped Frederick I. in his expedition of 1157 against the Poles, and in July 1159 had gone to his assistance in Italy, where he remained for about two years.

The vigorous measures taken by Henry to increase his power aroused considerable opposition. In 1166 a coalition was formed against him at Merseburg under the leadership of Albert the Bear, margrave of Brandenburg, and Archbishop Hartwig. Neither side met with much success in the desultory warfare that ensued, and Frederick made peace between the combatants at Würzburg in June 1168. Having obtained a divorce from his first wife in 1162, Henry was married at Minden in February 1168 to Matilda (1156-1180), daughter of Henry II., king of England, and was soon afterwards sent by the emperor Frederick I. on an embassy to the kings of England and France. A war with Valdemar of Denmark, caused by a quarrel over the booty obtained from

¹ The see was transferred to Schwerin by Henry in 1167.

² Transferred to Lübeck in 1163.

the conquest of Rügen, engaged Henry's activity until June 1171, when, in pursuance of a treaty which restored peace, Henry's daughter, Gertrude, married the Danish prince, Canute. Henry, whose position was now very strong, made a pilgrimage to Jerusalem in 1172, was received with great respect by the eastern emperor Manuel Comnenus at Constantinople, and returned to Saxony in 1173.

A variety of reasons were leading to a rupture in the harmonious relations between Frederick and Henry, whose increasing power could not escape the emperor's notice, and who showed little inclination to sacrifice his interests in Germany in order to help the imperial cause in Italy. He was not pleased when he heard that his uncle, Welf, had bequeathed his Italian and Swabian lands to the emperor, and the crisis came after Frederick's check before Alessandria in 1175. The emperor appealed personally to Henry for help in February, or March 1176, but Henry made no move in response, and his defection contributed in some measure to the emperor's defeat at Legnano. The peace of Venice provided for the restoration of Ulalrich to his see of Halberstadt. Henry, however, refused to give up the lands which he had seized belonging to the bishopric, and this conduct provoked a war in which Ulalrich was soon joined by Philip, archbishop of Cologne. No attack on Henry appears to have been contemplated by Frederick to whom both parties carried their complaints, and a day was fixed for the settlement of the dispute at Worms. But neither then, nor on two further occasions, did Henry appear to answer the charges preferred against him; accordingly in January 1180 he was placed under the imperial ban at Würzburg, and was declared deprived of all his lands.

Meanwhile the war with Ulalrich continued, but after his victory at Weissensee Henry's allies began to fall away, and his cause to decline. When Frederick took the field in June 1181 the struggle was soon over. Henry sought for peace, and the conditions were settled at Erfurt in November 1181, when he was granted the counties of Lüneburg and Brunswick, but was banished under oath not to return without the emperor's permission. In July 1182 he went to his father-in-law's court in Normandy, and afterwards to England, returning to Germany with Frederick's permission in 1185. He was soon regarded once more as a menace to the peace of Germany, and of the three alternatives presented to him by the emperor in 1188 he rejected the idea of making a formal renunciation of his claim, or of participating in the crusade, and chose exile, going again to England in 1189. In October of the same year, however, he returned to Saxony, excusing himself by asserting that his lands had not been defended according to the emperor's promise. He found many allies, took Lübeck, and soon almost the whole of Saxony was in his power. King Henry VI. was obliged to take the field against him, after which the duke's cause declined, and in July 1190 a peace was arranged at Fulda, by which he retained Brunswick and Lüneburg, received half the revenues of Lübeck, and gave two of his sons as hostages. Still hoping to regain his former position, he took advantage of a league against Henry VI. in 1193 to engage in a further revolt, but the captivity of his brother-in-law Richard I., king of England, led to a reconciliation. Henry passed his later years mainly at his castle of Brunswick, where he died on the 6th of August 1195, and was buried in the church of St Blasius which he had founded in the town. He had by his first wife a son and a daughter, and by his second wife five sons and a daughter. One of his sons was Otto, afterwards the emperor Otto IV., and another was Henry (d. 1227) count palatine of the Rhine.

Henry was a man of great ambition, and won his surname of "Lion" by his personal bravery. His influence on the fortunes of Saxony and northern Germany was very considerable. He planted Flemish and Dutch settlers in the land between the Elbe and the Oder, fostered the growth and trade of Lübeck, and in other ways encouraged trade and agriculture. He sought to spread Christianity by introducing the Cistercians, founding bishoprics, and building churches and monasteries. In 1874 a colossal statue was erected to his memory at Brunswick.

The authorities for the life of Henry the Lion are those dealing with the reign of the emperor Frederick I., and the early years of his son King Henry VI. The chief modern works are H. Prutz, *Heinrich der Löwe* (Leipzig, 1865); M. Philippson, *Geschichte Heinrichs des Löwen* (Leipzig, 1867); and L. Weiland, *Das sächsische Herzogtum unter Lothar und Heinrich dem Löwen* (Greifswald, 1866).

HENRY, PRINCE OF BATTENBERG (1836-1896), was the third son of Prince Alexander of Hesse and hismorganatic wife, the beautiful Countess Julia von Hauke, to whom was granted in 1858 the title of princess of Battenberg, which her children inherited. He was born at Milan on the 5th of October 1838, was educated with a special view to military service, and in due time became a lieutenant in the first regiment of Rhenish hussars. By their relationship to the grand dukes of Hesse the princes of Battenberg were brought into close contact with the English court, and Prince Henry paid several visits to England, where he soon became popular both in public and in private circles. It therefore created but little surprise when, towards the close of 1884, it was announced that Queen Victoria had sanctioned his engagement to the Princess Beatrice. The wedding took place at Whipplingham on the 23rd of July 1885, and after the honeymoon the prince and princess settled down to a quiet home life with the queen, being seldom absent from the court, and accompanying her majesty in her annual visits to the continent. Three sons and a daughter were the issue of the marriage. On the 31st of July 1885 a bill to naturalize Prince Henry was passed by the House of Lords, and he received the title of royal highness. He was made a Knight of the Garter and a member of the Privy Council, and also appointed a colonel in the army, and afterwards captain-general and governor of the Isle of Wight and governor of Carlsbrooke Castle. He adapted himself very readily to English country life, for he was an excellent shot and an enthusiastic yachtsman. Coming of a martial race, the prince would gladly have embraced an active military career, and when the Ashanti expedition was organized in November 1856 he volunteered to join it. But when the expedition reached Prahu, about 30 m. from Kumasi, he was struck down by fever, and being promptly conveyed back to the coast, was placed on board H.M.S. "Blonde." On the 17th of January he seemed to recover slightly, but a relapse occurred on the 19th, and he died on the evening of the 20th off the coast of Sierra Leone.

HENRY FITZ HENRY (1155-1183), second son of Henry II., king of England, by Eleanor of Aquitaine, became heir to the throne on the death of his brother William (1156), and at the age of five was married to Marguerite, the infant daughter of Louis VII. In 1170 he was crowned at Westminster by Roger of York. The protests of Becket against this usurpation of the rights of Canterbury were the ultimate cause of the primate's murder. The young king soon quarrelled with his father, who allowed him no power and a wholly inadequate revenue, and headed the great baronial revolt of 1173. He was assisted by his father-in-law, to whose court he had repaired; but, failing to shake the old king's power either in Normandy or England, made peace in 1174. Despite the generous terms which he received, he continued to intrigue with Louis VII., and was in consequence jealously watched by his father. In 1182 he and his younger brother Geoffrey took up arms, on the side of the Poitevin rebels, against Richard Cœur de Lion; apparently from resentment at the favour which Henry II. had shown to Richard in giving him the government of Poitou while they were virtually landless. Henry II. took the field in aid of Richard; but the young king and Geoffrey had no scruples about withstanding their father, and continued to aid the Aquitanian rising until the young king fell ill of a fever which proved fatal to him (June 11, 1183). His death was bitterly regretted by his father and by all who had known him. Though of a fickle and treacherous nature, he had all the personal fascination of his family, and is extolled by his contemporaries as a mirror of chivalry. His train was full of knights who served him without pay for the honour of being associated with his exploits in the tilting-lists and in war.

The original authorities for Henry's life are Robert de Torigin, *Chronica*; Giraldus Cambrensis, *De instructione principum*, Guil-

laume le Marchal (ed. P. Meyer, Paris, 1891, &c.); Bénédict, *Gesta Henrici*, William of Newburgh. See also Kate Norgate, *England under the Angevin Kings* (1887); Sir James Ramsay, *Angevin Empire* (1903); and C. E. Hodgson, *Jung Heinrich, König von England* (Jena, 1906).

HENRY, or in full, **HENRY BENEDICT MARIA CLEMENT STUART** (1725-1807), usually known as Cardinal York, the last prince of the royal house of Stuart, was the younger son of James Stuart, and was born in the Palazzo Muti at Rome on the 6th of March 1725. He was created duke of York by his father soon after his birth, and by this title he was always alluded to by Jacobite adherents of his house. British visitors to Rome speak of him as a merry high-spirited boy with martial instincts; nevertheless, he grew up studious, peace-loving and serious. In order to be of assistance to his brother Charles, who was then campaigning in Scotland, Henry was despatched in the summer of 1745 to France, where he was placed in nominal command of French troops at Dunkirk, with which the marquis d'Argenson had some vague idea of invading England. Seven months after Charles's return from Scotland Henry secretly departed to Rome and, with the full approval of his father, but to the intense disgust of his brother, was created a cardinal deacon under the title of the cardinal of York by Pope Benedict XIV. on the 3rd of July 1747. In the following year he was ordained priest, and nominated arch-priest of the Vatican Basilica. In 1759 he was consecrated archbishop of Corinth *in partibus*, and in 1761 bishop of Frascati (the ancient Tusculum) in the Alban Hills near Rome. Six years later he was appointed vice-chancellor of the Holy See. Henry Stuart likewise held sinecure benefices in France, Spain and Spanish America, so that he became one of the wealthiest churchmen of the period, his annual revenue being said to amount to £30,000 sterling. On the death of his father, James Stuart (whose affairs he had managed during the last five years of his life), Henry made persistent attempts to induce Pope Clement XIII. to acknowledge his brother Charles as legitimate king of Great Britain, but his efforts were defeated, chiefly through the adverse influence of Cardinal Alessandro Albani, who was bitterly opposed to the Stuart cause. On Charles's death in 1788 Henry issued a manifesto asserting his hereditary right to the British crown, and likewise struck a medal, commemorative of the event, with the legend "Hen. IX. Mag. Brit. Fr. et Hib. Rex. Fid. Def. Card. Ep. Tusc." (Henry the Ninth of Great Britain, France and Ireland; King, Defender of the Faith, Cardinal, Bishop of Frascati). In February 1798, at the approach of the invading French forces, Henry was forced to fly from Frascati to Naples, whence at the close of the same year he sailed to Messina. From Messina he proceeded by sea in order to be present at the expected conclave at Venice, where he arrived in the spring of 1799, aged, ill and almost penniless. His sad plight was now made known by Cardinal Stefano Borgia to Sir John Cox Hoppisley (d. 1825), who had formerly acted semi-officially on behalf of the British government at the court of Pius VI. Sir John Hoppisley appealed to George III., who on the warm recommendation of Prince Augustus Frederick, duke of Sussex, gave orders for the annual payment of a pension of £4000 to the last of the Royal Stuarts. Henry received the proffered assistance gratefully, and in return for the king's kindness subsequently left by his will certain British crown jewels in his possession to the prince regent. In 1800 Henry was able to return to Rome, and in 1803, being now senior cardinal bishop, he became *ipso facto* dean of the Sacred College and bishop of Ostia and Velletri. He died at Frascati on the 13th of July 1807, and was buried in the *Grotte Vaticane* of St Peter's in an urn bearing the title of "Henry IX.", he is also commemorated in Canova's well-known monument to the Royal Stuarts (see JAMES). The Stuart archives, once the property of Cardinal York, were subsequently presented by Pope Pius VII. to the prince regent, who placed them in the royal library at Windsor Castle.

See B. W. Kelly, *Life of Cardinal York*; H. M. Vaughan, *Last of the Royal Stuarts*; and A. Shield, *Henry Stuart, Cardinal of York, and his Times* (1908). (H. M. V.)

HENRY OF PORTUGAL, surnamed the "Navigator" (1394-1460), duke of Viseu, governor of the Algarve, was born at Oporto on the 4th of March 1394. He was the third (or, counting children who died in infancy, the fifth) son of John (João) I., the founder of the Avis dynasty, under whom Portugal, victorious against Castile and against the Moors of Morocco, began to take a prominent place among European nations, his mother was Philippa, daughter of John of Gaunt. When Ceuta, the "African Gibraltar," was taken in 1415, Prince Henry performed the most distinguished service of any Portuguese leader, and received knighthood; he was now created duke of Viseu and lord of Covilham, and about the same time began his explorations, which, however, limited in their original conception, certainly developed into a search for a better knowledge of the western ocean and for a sea-way along the unknown coast of Africa to the supposed western Nile (our Senegal), to the rich negro lands beyond the Sahara desert, to the half-true, half-fabled realm of Prester John, and so ultimately to the Indies.

Regarding the traditions which assign 1412 or even 1410 as the commencement of these explorations, it appears that in 1415, the year of Ceuta, the prince sent out one John de Trasto on a voyage which brought the Portuguese to Grand Canary. There was no discovery here, for the whole Canarian archipelago was now pretty well known to French and Spanish mariners, especially since the conquest of 1402-06 by French adventurers under Castilian overlordship; but in 1418 Henry's captain, João Gonçalves Zarco rediscovered Porto Santo, and in 1420 Madeira, the chief members of an island group which had originally been discovered (probably by Genoese pioneers) before 1351 or perhaps even before 1330, but had rather faded from Christian knowledge since. The story of the rediscovery of Madeira by the Englishman Robert Machim or Machin, eloping from Bristol with his lady-love, Anne d'Arlet, in the reign of Edward III. (about 1370), has been the subject of much controversy; in any case it does not affect the original Italian discovery, nor the first sighting of Porto Santo by Zarco, who, while exploring the west African mainland coast, was driven by storms to this island. In 1424-1425 Prince Henry attempted to purchase the Canaries, and began the colonization of the Madeira group, both in Madeira itself and in Porto Santo; to aid this latter movement he procured the famous charters of 1430 and 1433 from the Portuguese crown. In 1427, again, with the co-operation of his father King John, he seems to have sent out the royal pilot Diogo de Sevil, followed in 1431 by Gonçalo Velho Cabral, to explore the Azores, first mentioned and depicted in a Spanish treatise of 1345 (the *Conosçimiento de todos los Reynos*) and in an Italian map of 1351 (the *Laurentian Portolano*, also the first cartographical work to give us the Madeiras with modern names), but probably almost unvisited from that time to the advent of Sevil. This rediscovery of the far western archipelago, and the expeditions which, even within Prince Henry's life (as in 1452) pushed still deeper into the Atlantic, seem to show that the infante was not entirely forgetful of the possibility of such a western route to Asia as Columbus attempted in 1492, only to find America across his path. Meantime, in 1418, Henry had gone in person to relieve Ceuta from an attack of Morocco and Granada Mussulmans; had accomplished his task, and had planned, though he did not carry out, a seizure of Gibraltar. About this time, moreover, it is probable that he had begun to gather information from the Moors with regard to the coast of "Guinea" and the interior of Africa. In 1419, after his return to Portugal, he was created governor of the "kingdom" of Algarve, the southernmost province of Portugal; and his connexion now appears to have begun with what afterwards became known as the "Infante's Town" (*Villa do Infante*) at Sagres, close to Cape St Vincent; where, before 1438, a *Terçena Naval* or naval arsenal grew up; where, from 1438, after the Tangier expedition, the prince certainly resided for a great part of his later life; and where he died in 1460.

In 1433 died King John, exhorting his son not to abandon those schemes which were now, in the long-continued failure to round Cape Bojador, ridiculed by many as costly absurdities;

and in 1434 one of the prince's ships, commanded by Gil Eannes, at length doubled the cape. In 1435 Afonso Gonçalves Baldaya, the prince's cup-bearer, passed fifty leagues beyond; and before the close of 1436 the Portuguese had almost reached Cape Blanco. Plans of further conquest in Morocco, resulting in 1437 in the disastrous attack upon Tangier, and followed in 1438 by the death of King Edward (Duarte) and the domestic troubles of the earlier minority of Afonso V., now interrupted Atlantic and African exploration down to 1441, except only in the Azores. Here rediscovery and colonization both progressed, as is shown by the royal licence of the 2nd of July 1439, to people "the seven islands" of the group then known. In 1441 exploration began again in earnest with the venture of Antam Gonçalves, who brought to Portugal the first slaves and gold-dust from the Guinea coasts beyond Bojador; while Nuno Tristam in the same year pushed on to Cape Blanco. These successes produced a great effect; the cause of discovery, now connected with boundless hopes of profit, became popular; and many volunteers, especially merchants and scamen from Lisbon and Lagos, came forward. In 1442 Nuno Tristam reached the Bay or Bight of Arguim, where the infante erected a fort in 1448, and where for years the Portuguese carried on vigorous slave-raiding. Meantime the prince, who had now, in 1443, been created by Henry VI. a knight of the Garter of England, proceeded with his Sagres buildings, especially the palace, church and observatory (the first in Portugal) which formed the nucleus of the "Infante's Town," and which were certainly commenced soon after the Tangier fiasco (1437), if not earlier. In 1444-1446 there was an immense burst of maritime and exploring activity; more than 30 ships sailed with Henry's licence to Guinea; and several of their commanders achieved notable success. Thus Diniz Diaz, Nuno Tristam, and others reached the Senegal in 1445; Dias rounded Cape Verde in the same year; and in 1446 Alvaro Fernandez pushed on almost to our Sierra Leone, to a point 110 leagues beyond Cape Verde. This was perhaps the most distant point reached before 1461. In 1444, moreover, the island of St Michael in the Azores was sighted (May 8), and in 1445 its colonization was begun. During this latter year also John Fernandez (*q.v.*) spent seven months among the natives of the Arguim coast, and brought back the first trustworthy first-hand European account of the Sahara hinterland. Slave-raiding continued ceaselessly; by 1446 the Portuguese had carried off nearly a thousand captives from the newly surveyed coasts; but between this time and the voyages of Cadamosto (*q.v.*) in 1455-1456, the prince altered his policy, forbade the kidnapping of the natives (which had brought about fierce reprisals, causing the death of Nuno Tristam in 1446, and of other pioneers in 1445, 1448, &c.), and endeavoured to promote their peaceful intercourse with his men. In 1445-1446, again, Dom Henry renewed his earlier attempts (which had failed in 1424-1425) to purchase or seize the Canaries for Portugal; by these he brought his country to the verge of war with Castile; but the home government refused to support him, and the project was again abandoned. After 1446 our most voluminous authority, Azurara, records but little; his narrative ceases altogether in 1448; one of the latest expeditions noticed by him is that of a foreigner in the prince's service, "Vallarte the Dane," which ended in utter destruction near the Gambia, after passing Cape Verde in 1448. After this the chief matters worth notice in Dom Henry's life are, first, the progress of discovery and colonization in the Azores—where Terceira was discovered before 1450, perhaps in 1445, and apparently by a Fleming, called "Jacques de Bruges" in the prince's charter of the 2nd of March 1450 (by this charter Jacques receives the captaincy of this isle as its intending colonizer); secondly, the rapid progress of civilization in Madeira, evidenced by its timber trade to Portugal, by its sugar, corn and honey, and above all by its wine, produced from the Malvoisie or Malmsey grape, introduced from Crete; and thirdly, the explorations of Cadamosto and Diogo Gomez (*q.v.*). Of these the former, in his two voyages of 1455 and 1456, explored part of the courses of the Senegal and the Gambia, discovered the Cape Verde Islands (1456), named and mapped more carefully than

before a considerable section of the African littoral beyond Cape Verde, and gave much new information on the trade-routes of north-west Africa and on the native races; while Gomez, in his first important venture (after 1448 and before 1458), though not accomplishing the full Indian purpose of his voyage (he took a native interpreter with him for use "in the event of reaching India"), explored and observed in the Gambia valley and along the adjacent coasts with fully as much care and profit. As a result of these expeditions the infante seems to have sent out in 1458 a mission to convert the Gambia negroes. Gomez's second voyage, resulting in another "discovery" of the Cape Verde Islands, was probably in 1462, after the death of Prince Henry; it is likely that among the infante's last occupations were the necessary measures for the equipment and despatch of this venture, as well as of Pedro de Sintra's important expedition of 1461.

The infante's share in home politics was considerable, especially in the years of Alfonso V.'s minority (1438, &c.) when he helped to make his elder brother Pedro regent, reconciled him with the queen-mother, and worked together with them both in a council of regency. But when Dom Pedro rose in revolt (1447), Henry stood by the king and allowed his brother to be crushed. In the Morocco campaigns of his last years, especially at the capture of Alcazar the Little (1458), he restored the military fame which he had founded at Ceuta and compromised at Tangier, and which brought him invitations from the pope, the emperor and the kings of Castile and England, to take command of their armies. The prince was also grand master of the Order of Christ, the successor of the Templars in Portugal; and most of his Atlantic and African expeditions sailed under the flag of his order, whose revenues were at the service of his explorations, in whose name he asked and obtained the official recognition of Pope Eugenius IV. for his work, and on which he bestowed many privileges in the new-won lands—the tithes of St. Michael in the Azores and one-half of its sugar revenues, the tithe of all merchandise from Guinea, the ecclesiastical dues of Madeira, &c. As "protector of Portuguese studies," Dom Henry is credited with having founded a professorship of theology, and perhaps also chairs of mathematics and medicine, in Lisbon—where also, in 1431, he is said to have provided house-room for the university teachers and students. To instruct his captains, pilots and other pioneers more fully in the art of navigation and the making of maps and instruments he procured, says Barros, the aid of one Master Jacome from Majorca, together with that of certain Arab and Jewish mathematicians. We hear also of one Master Peter, who inscribed and illuminated maps for the infante; the mathematician Pedro Nunes declares that the prince's mariners were well taught and provided with instruments and rules of astronomy and geometry "which all map-makers should know"; Cadamosto tells us that the Portuguese caravels in his day were the best sailing ships afloat; while, from several matters recorded by Henry's biographers, it is clear that he devoted great attention to the study of earlier charts and of any available information he could gain upon the trade-routes of north-west Africa. Thus we find an Oran merchant corresponding with him about events happening in the negro-world of the Gambia basin in 1458. Even if there were never a formal "geographical school" at Sagres, or elsewhere in Portugal, founded by Prince Henry, it appears certain that his court was the centre of active and useful geographical study, as well as the source of the best practical exploration of the time.

The prince died on the 13th of November 1460, in his town near Cape St. Vincent, and was buried in the church of St. Mary in Lagos, but a year later his body was removed to the superb monastery of Batalha. His great-nephew, King Dom Manuel, had a statue of him placed over the centre column of the side gate of the church of Belem. On the 24th of July 1840, a monument was erected to him at Sagres at the instance of the marquis de Sá da Bandeira.

The glory attaching to the name of Prince Henry does not rest merely on the achievements effected during his own lifetime, but on the subsequent results to which his genius and perseverance had lent the primary inspiration. To him the human race is

indebted, in large measure, for the maritime exploration; within one century (1470-1522), of more than half the globe, and especially of the great waterways from Europe to Asia both by east and by west. His own life only sufficed for the accomplishment of a small portion of his task. The complete opening out of the African or south-east route to the Indies needed nearly forty years of somewhat intermittent labour after his death (1460-1498), and the prince's share has often been forgotten in that of pioneers who were really his executors—Diogo Cam, Bartholomew Diaz or Vasco da Gama. Less directly, other sides of his activity may be considered as fulfilled by the Portuguese penetration of inland Africa, especially of Abyssinia, the land of the "Prester John" for whom Dom Henry sought, and even by the finding of a western route to Asia through the discoveries of Columbus, Balboa and Magellan.

See *Alguns documentos do archivo nacional da Torre do Tombo acerca das navegações . . . portuguesas* (Lisbon, 1892); Alves, *Dom Henrique o Infante* (Oporto, 1894); *Arquivo das Açores* (Ponta Delgada, 1878-1894); Gomes Eannes de Azurara, *Chronica do descobrimento e conquista de Guiné*, ed. Carreira and Santarem (Paris, 1841; Eng. trans. by Raymond Beazley and Edgar Prestage, Hakluyt Society, London, 1896-1899); João de Barros, *Decadas da Asia* (Lisbon, 1652); Raymond Beazley, *Prince Henry the Navigator* (London, 1895), and introduction to Azurara, vol. II, in Hakluyt Soc. trans. (see above); Antonio Cordeiro, *Historia Insulana* (Lisbon, 1717); Freire (Candido Luisitano), *Vida do Infante D. Henrique* (Lisbon, 1855); "Diogo Gomez," in Dr. Schmeller's *Über Valentim Fernandez Alencão*, vol. IV. pt. III, in the publications of the 1st class of the Royal Bavarian Academy of Sciences (Munich, 1845); R. H. Major, *The Life of Henry of Portugal, surnamed the Navigator* (London, 1868); Jules Mees, *Henri le Navigateur et l'Académie . . . de Sagres* (Brussels, 1901), and *Histoire de la découverte des Îles Açores* (Ghent, 1901); Duarte Pacheco Pereira, *Esmeraldo de situ orbis* (Lisbon, 1892); Sophus Ruge, "Prinz Heinrich der Seefahrer," in vol. 65 of *Globus*, p. 153 (Brunswick, 1894); Gustav de Veer, *Prinz Heinrich der Seefahrer* (Danzig, 1863); H. E. Wauwerpman, *Henri le Navigateur et l'Académie portugaise de Sagres* (Antwerp and Brussels, 1890). (C. R. B.)

HENRY OF ALMAIN (1235-1271), so called from his father's German connexions, was the son of Richard, earl of Cornwall and king of the Romans. As a nephew of both Henry III. and Simon de Montfort he wavered between the two at the beginning of the Barons' War, but finally took the royalist side and was among the prisoners taken by Montfort at Lewes (1264). In 1268 he took the cross with his cousin Edward, who, however, sent him back from Sicily to pacify the unruly province of Gascony. Henry took the land route with the kings of France and Sicily. While attending mass at Viterbo (13 March 1271) he was attacked by Guy and Simon de Montfort, sons of Earl Simon, and foully murdered. This revenge was the more outrageous since Henry had personally exerted himself on behalf of the Montforts after Evesham. The deed is mentioned by Dante, who put Guy de Montfort in the seventh circle of hell.

See W. H. Blaauw's *The Barons' War* (ed. 1871); Ch. Bémont's *Simon de Montfort* (1884).

HENRY OF BLOIS, bishop of Winchester (1101-1171), was the son of Stephen, count of Blois, by Adela, daughter of William I., and brother of King Stephen. He was educated at Cluny, and consistently exerted himself for the principles of Cluniac reform. If these involved high claims of independence and power for the Church, they also asserted a high standard of devotion and discipline. Henry was brought to England by Henry I. and made abbot of Glastonbury. In 1129 he was given the bishopric of Winchester and allowed to hold his abbey in conjunction with it. His hopes of the see of Canterbury were disappointed, but he obtained in 1139 a legate commission which gave him a higher rank than the pope. In fact as well as in theory he became the master of the Church in England. He even contemplated the erection of a new province, with Winchester as its centre, which was to be independent of Canterbury. Owing both to local and to general causes the power of the Church in England has never been higher than in the reign of Stephen (1135-1154). Henry as its leader and a legate of the pope was the real "lord of England," as the chronicles call him. Indeed, one of the ecclesiastical councils over which he presided formally declared that the election of the king in England was the special privilege of the

clergy. Stephen owed his crown to Henry (1135), but they quarrelled when Stephen refused to give Henry the primacy; and the bishop took up the cause of Roger of Salisbury (1139). After the battle of Lincoln (1141) Henry declared for Matilda; but finding his advice treated with contempt, rejoined his brother's side, and his successful defence of Winchester against the empress (Aug.-Sept. 1141) was the turning-point of the civil war. The expiration of his legatine commission of 1144 deprived him of much of his power. He spent the rest of Stephen's reign in trying to procure its renewal. But his efforts were unsuccessful, though he made a personal visit to Rome. At the accession of Henry II. (1154) he retired from the world and spent the rest of his life in works of charity and penitence. He died in 1171. Henry seems to have been a man of high character, great courage, resolution and ability. Like most great bishops of his age he had a passion for architecture. He built, among other castles, that of Farnham; and he began the hospital of St Cross at Winchester.

AUTHORITIES.—Original: William of Malmesbury, *De gestis regum; the Gesta Stephani*. Modern: Sir James Ramsay, *Foundations of England*, vol. ii.; Kate Norgate's *Anglo-Norman Kings; Kitchin's Winchester*.

HENRY OF GHENT [Henricus a Gandavo] (c. 1217-1293), scholastic philosopher, known as "Doctor Solennis," was born in the district of Mude, near Ghent, and died at Tournai (or Paris). He is said to have belonged to an Italian family named Bonicollì, in Flemish Goethals, but the question of his name has been much discussed (see authorities below). He studied at Ghent and then at Cologne under Albertus Magnus. After obtaining the degree of doctor he returned to Ghent, and is said to have been the first to lecture there publicly on philosophy and theology. Attracted to Paris by the fame of the university, he took part in the many disputes between the orders and the secular priests, and warmly defended the latter. A contemporary of Aquinas, he opposed several of the dominant theories of the time, and united with the current Aristotelian doctrines a strong infusion of Platonism. He distinguished between knowledge of actual objects and the divine inspiration by which we cognize the being and existence of God. The first throws no light upon the second. Individuals are constituted not by the material element but by their independent existence, *i.e.* ultimately by the fact that they are created as separate entities. Universals must be distinguished according as they have reference to our minds or to the divine mind. In the divine intelligence exist exemplars or types of the genera and species of natural objects. On this subject Henry is far from clear; but he defends Plato against the current Aristotelian criticism, and endeavours to show that the two views are in harmony. In psychology, his view of the intimate union of soul and body is remarkable. The body he regards as forming part of the substance of the soul, which through this union is more perfect and complete.

WORKS.—*Quodlibeta theologica* (Paris, 1518; Venice, 1608 and 1613); *Summa theologiae* (Paris, 1520; Ferrara, 1646); *De scripturis ecclesiasticis* (Cologne, 1580).

AUTHORITIES.—F. Huet's *Recherches hist. et crit. . . de H. de G.* (Paris, 1838) has been superseded by F. Ehrle's monograph in *Archiv für Lit. u. Kirchengeschichte des Mittelalters*, i. (1885); see also A. Wauters and N. de Pauw in the *Bull. de la Com. royale d'histoire de Belgique* (4th series, xiv., xv., xvi., 1887-1889); H. Delehay, *Nouvelles Recherches sur Henri de Gand* (1886); C. Werner, *Heinrich von Gent als Repräsentant des christlichen Platonismus im 13ten Jahrh.* (Vienna, 1878); A. Stöckl, *Phil. d. Mittelalters*, ii. 738-758; C. Bréchillet Jourdain, *La Philosophie de St Thomas d'Aquin* (1858), ii. 29-46; Alphonse le Roy in *Biographie nationale de Belgique*, vii. (Brussels, 1880); and article **SCHOLASTICISM**.

HENRY OF HUNTINGDOM, English chronicler of the 12th century, was born, apparently, between the years 1080 and 1090. His father, by name Nicholas, was a clerk, who became archdeacon of Cambridge, Hertford and Huntingdon, in the time of Remigius, bishop of Lincoln (d. 1092). The celibacy of the clergy was not strictly enforced in England before 1102. Hence the chronicler makes no secret of his antecedents, nor did they interfere with his career. At an early age Henry entered the household of Bishop Robert Bloet, who appointed him, immediately after the death of Nicholas (1110), archdeacon of Hertford and Huntingdon. Henry was on familiar terms with his patron;

and also, it would seem, with Bloet's successor, by whom he was encouraged to undertake the writing of an English history from the time of Julius Caesar. This work, undertaken before 1130, was first published in that year; the author subsequently published in succession four more editions, of which the last ends in 1154 with the accession of Henry II. The only recorded fact of the chronicler's later life is that he went with Archbishop Theobald to Rome in 1139. On the way Henry halted at Bec, and there made the acquaintance of Robert de Torigni, who mentions their encounter in the preface to his Chronicle.

The *Historia Anglorum* was first printed in Savile, *Reverum Anglicarum scriptores post Bedam* (London, 1596). The first six books, excepting the third, which is almost entirely taken from Bede, are given in *Monumenta historica Britannica*, vol. i. (ed. H. Petrie and J. Sharpe, London, 1848). The standard edition is that of T. Arnold in the Rolls Series (London, 1879). There is a translation by T. Forester in Bohn's *Antiquarian Library* (London, 1853). The *Historia* is of little independent value before 1126. Up to that point the author compiles from Eutropius, Aurelius Victor, Nennius, Bede and the English chronicles, particularly that of Peterborough; in some cases he professes to supplement these sources from oral tradition; but most of his amplifications are pure rhetoric (see F. Liebermann in *Forschungen zur deutschen Geschichte* for 1878, pp. 265 seq.). Arnold prints, in an appendix, a minor work from Henry's pen, the *Epistola ad Wallerum de contemptu mundi*, which was written in 1135. It is a moralizing tract, but contains some interesting anecdotes about contemporaries. Henry also wrote epistles to Henry I. (on the succession of kings and emperors in the great monarchies of the world) and to "Warrinus, a Briton" (on the early British kings, after Geoffrey of Monmouth). A book, *De miraculis*, composed of extracts from Bede, was appended along with these three epistles to the later recensions of the *Historia*. Henry composed eight books of Latin epigrams; two books survive in the Lambeth MS., No. 118. His value as a historian, formerly much overrated, is discussed at length by Liebermann and in T. Arnold's introduction to the Rolls edition of the *Historia*.

(H. W. C. D.)

HENRY OF LAUSANNE (variously known as of Bruys, of Cluny, of Toulouse, and as the Deacon), French heresiarch of the first half of the 12th century. Practically nothing is known of his origin or early life. He may have been one of those hermits who at that time swarmed in the forests of western Europe, and particularly in France, always surrounded by popular veneration, and sometimes the founders of monasteries or religious orders, such as those of Prémontré or Fontevrault. If St Bernard's reproach (*Ep.* 241) be well founded, Henry was an apostate monk—a "black monk" (Benedictine) according to the chronicler Alberic de Trois Fontaines. The information we possess as to his degree of instruction is scarcely more precise or less conflicting. When he arrived at Le Mans in 1101, his *terminus a quo* was probably Lausanne. At that moment Hildebert, the bishop of Le Mans, was absent from his episcopal town, and this is one of the reasons why Henry was granted permission to preach (March to July 1101), a function jealously guarded by the regular clergy. Whether by his prestige as a hermit and ascetic or by his personal charm, he soon acquired enormous influence over the people. His doctrine at that date appears to have been very vague; he seemingly rejected the invocation of saints and also second marriages, and preached penitence. Women, inflamed by his words, gave up their jewels and luxurious apparel, and young men married courtesans in the hope of reclaiming them. Henry was peculiarly fitted for a popular preacher. In person he was tall and had a long beard; his voice was sonorous, and his eyes flashed fire. He went bare-footed, preceded by a man carrying a staff surmounted with an iron cross; he slept on the bare ground, and lived by alms. At his instigation the inhabitants of Le Mans soon began to slight the clergy of their town and to reject all ecclesiastical authority. On his return from Rome, Hildebert had a public disputation with Henry, in which, according to the bishop's *Acta episcoporum Cenomannensium*, Henry was shown to be less guilty of heresy than of ignorance. He, however, was forced to leave Le Mans, and went probably to Poitiers and afterwards to Bordeaux. Later we find him in the diocese of Arles, where the archbishop arrested him and had his case referred to the tribunal of the pope. In 1134 Henry appeared before Pope Innocent III. at the council of Pisa, where he was compelled

to abjure his errors and was sentenced to imprisonment. It appears that St Bernard offered him an asylum at Clairvaux; but it is not known if he reached Clairvaux, nor do we know when or in what circumstances he resumed his activities. Towards 1130, however, Peter the Venerable, abbot of Cluny, wrote a treatise called *Epistole seu tractatus adversus Petrobrusianos* (Migne, *Patr. Lat.* clxxxix.) against the disciples of Peter of Bruys and Henry of Lausanne, whom he calls Henry of Bruys, and whom, at the moment of writing, he accuses of preaching, in all the dioceses in the south of France, errors which he had inherited from Peter of Bruys. According to Peter the Venerable, Henry's teaching is summed up as follows: rejection of the doctrinal and disciplinary authority of the church; recognition of the Gospel freely interpreted as the sole rule of faith; condemnation of the baptism of infants, of the eucharist, of the sacrifice of the mass, of the communion of saints, and of prayers for the dead; and refusal to recognize any form of worship or liturgy. The success of this teaching spread very rapidly in the south of France. Speaking of this region, St Bernard (*Ep.* 241) says: "Thé churches are without flocks, the flocks without priests, the priests without honour; in a word, nothing remains save Christians without Christ." On several occasions St Bernard was begged to fight the innovator on the scene of his exploits, and in 1145, at the instance of the legate Alberic, cardinal bishop of Ostia, he set out, passing through the diocese of Angoulême and Limoges, sojourning for some time at Bordeaux, and finally reaching the heretical towns of Bergerac, Périgueux, Sarlat, Cahors and Toulouse. At Bernard's approach Henry quitted Toulouse, leaving there many adherents, both of noble and humble birth, and especially among the weavers. But Bernard's eloquence and miracles made many converts, and Toulouse and Albi were quickly restored to orthodoxy. After inviting Henry to a disputation, which he refused to attend, St Bernard returned to Clairvaux. Soon afterwards the heresiarch was arrested, brought before the bishop of Toulouse, and probably imprisoned for life. In a letter to the people of Toulouse, undoubtedly written at the end of 1146, St Bernard calls upon them to extirpate the last remnants of the heresy. In 1151, however, some Henricians still remained in Languedoc, for Matthew Paris relates (*Chron. maj.*, at date 1151) that a young girl, who gave herself out to be miraculously inspired by the Virgin Mary, was reputed to have converted a great number of the disciples of Henry of Lausanne. It is impossible to designate definitely as Henricians one of the two sects discovered at Cologne and described by Everwin, provost of Steinfeld, in his letter to St Bernard (Migne, *Patr. Lat.*, clxxxii. 676-680), or the heretics of Périgord mentioned by a certain monk Heribert (Martin Bouquet, *Recueil des historiens des Gaules et de la France*, xii. 550-551).

See "Les Origines de l'hérésie albigeoise," by Vacandard in the *Revue des questions historiques* (Paris, 1894, pp. 67-83). (P. A.)

HENRY, EDWARD LAMSON (1841-), American genre painter, was born in Charleston, South Carolina, on the 12th of January 1841. He was a pupil of the schools of the Pennsylvania Academy of Fine Arts in Philadelphia, and of Gleyre and Courbet in Paris, and in 1870 was elected to the National Academy of Design, New York. As a painter of colonial and early American themes and incidents of rural life, he displays a quaint humour and a profound knowledge of human nature. Among his best-known compositions are some of early railroad travel, incidents of stage coach and canal boat journeys, rendered with much detail on a minute scale.

HENRY, JAMES (1798-1876), Irish classical scholar, was born in Dublin on the 13th of December 1798. He was educated at Trinity College, and until 1845 practised as a physician in the city. In spite of his unconventionality and unorthodox views on religion and his own profession, he was very successful. His accession to a large fortune enabled him to devote himself entirely to the absorbing occupation of his life—the study of Virgil. Accompanied by his wife and daughter, he visited all those parts of Europe where he was likely to find rare editions or MSS. of the poet. He died near Dublin on the 14th of July

1876. As a commentator on Virgil Henry will always deserve to be remembered, notwithstanding the occasional eccentricity of his notes and remarks. The first fruits of his researches were published at Dresden in 1853 under the quaint title *Notes of a Twelve Years' Voyage of Discovery in the first six Books of the Æneis*. These were embodied, with alterations and additions, in the *Æneides, or Critical, Exegetical and Aesthetical Remarks on the Æneis* (1873-1892), of which only the notes on the first book were published during the author's lifetime. As a textual critic Henry was exceedingly conservative. His notes, written in a racy and interesting style, are especially valuable for their wealth of illustration and references to the less-known classical authors. Henry was also the author of several poems, some of them descriptive accounts of his travels, and of various pamphlets of a satirical nature.

See obituary notice by J. P. Mahaffy in the *Academy* of the 12th of August 1876, where a list of his works, nearly all of which were privately printed, is given.

HENRY, JOSEPH (1797-1878), American physicist, was born in Albany, N.Y., on the 17th of December 1797. He received his education at an ordinary school, and afterwards at the Albany Academy, which enjoyed considerable reputation for the thoroughness of its classical and mathematical courses. On finishing his academic studies he contemplated adopting the medical profession, and prosecuted his studies in chemistry, anatomy and physiology with that view. He occasionally contributed papers to the Albany Institute, in the years 1824 and 1825, on chemical and mechanical subjects; and in the latter year, having been unexpectedly appointed assistant engineer on the survey of a route for a state road from the Hudson river to Lake Erie, a distance somewhat over 300 m., he at once embarked with zeal and success in the new enterprise. This diversion from his original bent gave him an inclination to the career of civil and mechanical engineering; and in the spring of 1826 he was elected by the trustees of the Albany Academy to the chair of mathematics and natural philosophy in that institution. In the latter part of 1827 he read before the Albany Institute his first important contribution, "On Some Modifications of the Electro-Magnetic Apparatus." Struck with the great improvements then recently introduced into such apparatus by William Sturgeon of Woolwich, he had still further extended their efficiency, with considerable reduction of battery-power, by adopting in all the experimental circuits (where applicable) the principle of J. S. C. Schweigger's "multiplier," that is, by substituting for single wire circuits, voluminous coils (*Trans. Albany Institute*, 1827, 1, p. 22). In June 1828 and in March 1829 he exhibited before the institute small electro-magnets closely and repeatedly wound with silk-covered wire, which had a far greater lifting power than any then known; Henry appears to have been the first to adopt insulated or silk-covered wire for the magnetic coil; and also the first to employ what may be called the "spool" winding for the limbs of the magnet. He was also the first to demonstrate experimentally the difference of action between what he called a "quantity" magnet excited by a "quantity" battery of a single pair, and an "intensity" magnet with long fine wire coil excited by an "intensity" battery of many elements, having their resistances suitably proportioned. He pointed out that the latter form alone was applicable to telegraphic purposes. A detailed account of these experiments and exhibitions was not, however, published till 1831 (*Sill. Journ.*, 19, p. 400). Henry's "quantity" magnets acquired considerable celebrity at the time, from their unprecedented attractive power—one (August 1830) lifting 750 lb, another (March 1831) 2300, and a third (1834) 3500.

Early in 1831 he arranged a small office-bell to be tapped by the polarized armature of an "intensity" magnet, whose coil was in continuation of a mile of insulated copper wire, suspended about one of the rooms of his academy. This was the first instance of magnetizing iron at a distance, or of a suitable combination of magnet and battery being so arranged as to be capable of such action. It was, therefore, the earliest example of a true "magnetic" telegraph, all preceding experiments to

this end having been on the galvanometer or needle principle. About the same time he devised and constructed the first electromagnetic engine with automatic pole-changer (*Sill. Journ.*, 1831, 20, p. 340; and Sturgeon's *Annals Electr.*, 1839, 3, p. 554). Early in 1832 he discovered the induction of a current on itself, in a long helical wire, giving greatly increased intensity of discharge (*Sill. Journ.*, 1832, 22, p. 408). In 1832 he was elected to the chair of natural philosophy in the New Jersey college at Princeton. In 1834 he continued and extended his researches "On the Influence of a Spiral Conductor in increasing the Intensity of Electricity from a Galvanic Arrangement of a Single Pair," a memoir of which was read before the American Philosophical Society on the 5th of February 1835. In 1835 he combined the short circuit of his monster magnet (of 1834) with the small "intensity" magnet of an experimental telegraph wire, thereby establishing the fact that very powerful mechanical effects could be produced at a great distance by the agency of a very feeble magnet used as a circuit maker and breaker, or as a "trigger"—the precursor of later forms of relay and receiving magnets. In 1837 he paid his first visit to England and Europe. In 1838 he made important investigations in regard to the conditions and range of induction from electrical currents—showing that induced currents, although merely momentary, produce still other or tertiary currents, and thus on through successive orders of induction, with alternating signs, and with reversed initial and terminal signs. He also discovered similar successive orders of induction in the case of the passage of frictional electricity (*Trans. Am. Phil. Soc.*, 6, pp. 303-337). Among many minor observations, he discovered in 1842 the oscillatory nature of the electrical discharge, magnetizing about a thousand needles in the course of his experiments (*Proc. Am. Phil. Soc.*, 1, p. 301). He traced the influence of induction to surprising distances, magnetizing needles in the lower story of a house through several intervening floors by means of electrical discharges in the upper story, and also by the secondary current in a wire 220 ft. distant from the wire of the primary circuit. The five numbers of his *Contributions to Electricity and Magnetism* (1835-1842) were separately republished from the *Transactions*. In 1843 he made some interesting original observations on "Phosphorescence" (*Proc. Am. Phil. Soc.*, 3, pp. 38-44). In 1844, by experiments on the tenacity of soap-bubbles, he showed that the molecular cohesion of water is equal (if not superior) to that of ice, and hence, generally, that solids and their liquids have practically the same amount of cohesion (*Proc. Am. Phil. Soc.*, 4, pp. 56 and 84). In 1845 he showed, by means of a thermo-galvanometer, that the solar spots radiate less heat than the general solar surface (*Proc. Am. Phil. Soc.*, 4, pp. 173-176).

In December 1846 Henry was elected secretary and director of the Smithsonian Institution, then just established. While closely occupied with the exacting duties of that office, he still found time to prosecute many original inquiries—as into the application of acoustics to public buildings, and the best construction and arrangement of lecture-rooms, into the strength of various building materials, &c. Having early devoted much attention to meteorology, both in observing and in reducing and discussing observations, he (among his first administrative acts) organized a large and widespread corps of observers, and made arrangements for simultaneous reports by means of the electric telegraph, which was yet in its infancy (*Smithson. Report* for 1847, pp. 146, 147). He was the first to apply the telegraph to meteorological research, to have the atmospheric conditions daily indicated on a large map, to utilize the generalizations made in weather forecasts, and to embrace a continent under a single system—British America and Mexico being included in the field of observation. In 1852, on the reorganization of the American lighthouse system, he was appointed a member of the new board; and in 1871 he became the presiding officer of the establishment—a position he continued to hold during the rest of his life. His diligent investigations into the efficiency of various illuminants in differing circumstances, and into the best conditions for developing their several maximum powers of brilliancy, while greatly improving the usefulness of the line of beacons along the

extensive coast of the United States, effected at the same time a great economy of administration. His equally careful experiments on various acoustic instruments also resulted in giving to his country the most servicable system of fog-signals known to maritime powers. In the course of these varied and prolonged researches from 1865 to 1877, he also made important contributions to the science of acoustics; and he established by several series of laborious observations, extending over many years and along a wide coast range, the correctness of G. G. Stokes's hypothesis (*Report Brit. Assoc.*, 1857, part ii. 27) that the wind exerts a very marked influence in refracting sound-beams. From 1868 Henry continued to be annually chosen as president of the National Academy of Sciences; and he was also president of the Philosophical Society of Washington from the date of its organization in 1871.

Henry was by general concession the foremost of American physicists. He was a man of varied culture, of large breadth and liberality of views, of generous impulses, of great gentleness and courtesy of manner, combined with equal firmness of purpose and energy of action. He died at Washington on the 13th of May 1878. (S. F. B.)

HENRY, MATTHEW (1662-1714), English nonconformist divine, was born at Broad Oak, a farm-house on the confines of Flintshire and Shropshire, on the 18th of October 1662. He was the son of Philip Henry, who had, two months earlier, been ejected by the Act of Uniformity. Unlike most of his fellow-sufferers, Philip Henry possessed some private means, and was thus enabled to give a good education to his son, who went first to a school at Islington, and then to Gray's Inn. He soon relinquished his legal studies for theology, and in 1687 became minister of a Presbyterian congregation at Chester, removing in 1712 to Mare Street, Hackney. Two years later (22nd of June 1714), he died suddenly of apoplexy at Nantwich while on a journey from Chester to London. Henry's well-known *Exposition of the Old and New Testaments* (1708-1710) is a commentary of a practical and devotional rather than of a critical kind, covering the whole of the Old Testament, and the Gospels and Acts in the New. Here it was broken off by the author's death, but the work was finished by a number of ministers; and edited by G. Burder and John Hughes in 1811. Of no value as criticism, its unflinching good sense, its discriminating thought, its high moral tone, its simple piety and its singular felicity of practical application, combine with the well-sustained flow of its racy English style to secure for it the foremost place among works of its class.

His *Miscellaneous Writings*, including a *Life of Mr Philip Henry*, *The Communicant's Companion*, *Directions for Daily Communion with God*, *A Method for Prayer*, *A Scriptural Catechism*, and numerous sermons, were edited in 1800 and in 1830. See biographies by W. Tong (1816), C. Chapman (1859), J. B. Williams (1828, new ed. 1865); and M. H. Lee's *Diaries and Letters of Philip Henry* (1883).

HENRY, PATRICK (1736-1799), American statesman and orator, was born at Studley, Hanover county, Virginia, on the 29th of May 1736. He was the son of John Henry, a well-educated Scotsman, among whose relatives was the historian William Robertson, and who served in Virginia as county surveyor, colonel and judge of a county court. His mother was one of a family named Winston, of Welsh descent, noted for conversational and musical talent. At the age of ten Patrick was making slow progress in the study of reading, writing and arithmetic at a small country school, when his father became his tutor and taught him Latin, Greek and mathematics for five years, but with limited success. His school days being then terminated, he was employed as a store-clerk for one year. Within the seven years next following he failed twice as a store-keeper and once as a farmer; but in the meantime acquired a taste for reading, of history especially, and read and re-read the history of Greece and Rome, of England, and of her American colonies. Then, poor but not discouraged, he resolved to be a lawyer, and after reading *Coke upon Littleton* and the Virginia laws for a few weeks only, he strongly impressed one of his

examiners, and was admitted to the bar at the age of twenty-four, on condition that he spend more time in study before beginning to practise. He rapidly acquired a considerable practice, his fee books shewing that for the first three years he charged fees in 1185 cases. Then in 1763 was delivered his speech in "The Parson's Cause"—a suit brought by a clergyman, Rev. James Maury, in the Hanover County Court, to secure restitution for money considered by him to be due on account of his salary (16,000 pounds of tobacco by law) having been paid in money calculated at a rate less than the current market price of tobacco. This speech, which, according to reports, was extremely radical and denied the right of the king to disallow acts of the colonial legislature, made Henry the idol of the common people of Virginia and procured for him an enormous practice. In 1765 he was elected a member of the Virginia legislature, where he became in the same year the author of the "Virginia Resolutions," which were no less than a declaration of resistance to the Stamp Act and an assertion of the right of the colonies to legislate for themselves independently of the control of the British parliament, and gave a most powerful impetus to the movement resulting in the War of Independence. In a speech urging their adoption appear the often-quoted words: "Tarquin and Cæsar had each his Brutus, Charles the First his Cromwell, and George the Third [here he was interrupted by cries of "Treason"] and George the Third may profit by their example! If *this* be treason, make the most of it." Until 1775 he continued to sit in the House of Burgesses, as a leader during all that eventful period. He was prominent as a radical in all measures in opposition to the British government, and was a member of the first Virginia committee of correspondence. In 1774 and 1775 he was a delegate to the Continental Congress and served on three of its most important committees: that on colonial trade and manufactures, that for drawing up an address to the king, and that for stating the rights of the colonies. In 1775, in the second revolutionary convention of Virginia, Henry, regarding war as inevitable, presented resolutions for arming the Virginia militia. The more conservative members strongly opposed them as premature, whereupon Henry supported them in a speech familiar to the American school-boy for several generations following, closing with the words, "Is life so dear or peace so sweet as to be purchased at the price of chains and slavery? Forbid it, Almighty God! I know not what course others may take, but as for me, give me liberty or give me death!" The resolutions were passed and their author was made chairman of the committee for which they provided. The chief command of the newly organized army was also given to him, but previously, at the head of a body of militia, he had demanded satisfaction for powder removed from the public store by order of Lord Dunmore, the royal governor, with the result that £350 was paid in compensation. But his military appointment required obedience to the Committee of Public Safety, and this body, largely dominated by Edmund Pendleton, so restrained him from active service that he resigned on the 28th of February 1776. In the Virginia convention of 1776 he favoured the postponement of a declaration of independence, until a firm union of the colonies and the friendship of France and Spain had been secured. In the same convention he served on the committee which drafted the first constitution for Virginia, and was elected governor of the State—to which office he was re-elected in 1777 and 1778, thus serving as long as the new constitution allowed any man to serve continuously. As governor he gave Washington able support and sent out the expedition under George Rogers Clark (q.v.) into the Illinois country. In 1778 he was chosen a delegate to Congress, but declined to serve. From 1780 to 1784 and from 1787 to 1790 he was again a member of his State legislature; and from 1784 to 1786 was again governor. Until 1786 he was a leading advocate of a stronger central government but when chosen a delegate to the Philadelphia constitutional convention of 1787, he had become cold in the cause and declined to serve. Moreover, in the state convention called to decide whether Virginia should ratify the Federal Constitution he led the opposition, contending that the proposed

Constitution, because of its centralizing character, was dangerous to the liberties of the country. This change of attitude in thought to have been due chiefly to his suspicion of the North aroused by John Jay's proposal to surrender to Spain for twenty-five or thirty years the navigation of the Mississippi. From 1794 until his death he declined in succession the following offices: United States senator (1794), secretary of state in Washington's cabinet (1795), chief justice of the United States Supreme Court (1795), governor of Virginia (1796), to which office he had been elected by the Assembly, and envoy to France (1799). In 1799, however, he consented to serve again in his State legislature, where he wished to combat the Virginia Resolutions; he never took his seat, since he died, on his Red Hill estate in Charlotte county, Virginia, on the 6th of June of that year. Henry was twice married, first to Sarah Skelton, and second to Dorothea Spotswood Dandridge, a grand-daughter of Governor Alexander Spotswood.

See Moses Coit Tyler, *Patrick Henry* (Boston, 1887; new ed., 1899), and William Wirt Henry (Patrick Henry's grandson), *Patrick Henry: Life, Correspondence and Speeches* (New York, 1890-1891); these supersede the very unsatisfactory biography by William Wirt, *Sketches of the Life and Character of Patrick Henry* (Philadelphia, 1817). See also George Morgan, *The True Patrick Henry* (Philadelphia, 1907). (N. D. M.)

HENRY, ROBERT (1718-1790), British historian, was the son of James Henry, a farmer of Muirton, near Stirling. Born on the 18th of February 1718 he was educated at the parish school of St Ninians, and at the grammar school of Stirling, and, after completing his course at Edinburgh University, became master of the grammar school at Annan. In 1746 he was licensed to preach, and in 1748 was chosen minister of a Presbyterian congregation at Carlisle, where he remained until 1760, when he removed to a similar charge at Berwick-on-Tweed. In 1768 he became minister of the New Greyfriars' Church, Edinburgh, and having received the degree of D.D. from Edinburgh University in 1771, and served as moderator of the general assembly of the church of Scotland in 1774, he was appointed one of the ministers of the Old Greyfriars' Church, Edinburgh, in 1776, remaining in this charge until his death on the 24th of November 1790. During his residence in Berwick, Henry commenced his *History of Great Britain, written on a new plan*; but, owing to the difficulty of consulting the original authorities, he did not make much progress with the work until his removal to Edinburgh in 1768. The first five volumes appeared between 1771 and 1785, and the sixth, edited and completed by Malcolm Laing, was published three years after the author's death. A life of Henry was prefixed to this volume. The *History* covers the years between the Roman invasion and the death of Henry VIII., and the "new plan" is the combination of an account of the domestic life and commercial and social progress of the people with the narrative of the political events of each period. The work was violently assailed by Dr Gilbert Stuart (1742-1786), who appeared anxious to damage the sale of the book; but the injury thus effected was only slight, as Henry received £3300 for the volumes published during his lifetime. In 1781, through the influence of the earl of Mansfield, he obtained a pension of £100 a year from the British government.

The *History of Great Britain* has been translated into French, and has passed into several English editions. An account of Stuart's attack on Henry is given in Isaac D'Israeli's *Calamities of Authors*.

HENRY, VICTOR (1850-), French philologist, was born at Colmar in Alsace. Having held appointments at Douai and Lille, he was appointed professor of Sanskrit and comparative grammar in the university of Paris. A prolific and versatile writer, he is probably best known by the English translations of his *Précis de Grammaire comparée de l'anglais et de l'allemand* and *Précis . . . du Grec et du Latin*. Important works by him on India and Indian languages are: *Manuel pour étudier le Sanscrit védique* (with A. Bergaigne, 1890); *Éléments de Sanscrit classique* (1902); *Précis de grammaire Pâli* (1904); *Les Littératures de l'Inde: Sanscrit, Pâli, Prâkrit* (1904); *La Magie dans l'Inde antique* (1904); *Le Parsisme* (1905); *L'Agâstema* (1906);

Obscure languages (such as Inok, Quichua, Greenland) and local dialects (*Lexique étymologique du Breton moderne; Le Dialecte Alaman de Colmar*) also claimed his attention. *Le Langage Marien* is a curious book. It contains a discussion of some 40 phrases (amounting to about 300 words), which a certain Mademoiselle Hélène Smith (a well-known spiritualist medium of Geneva), while on a hypnotic visit to the planet Mars, learnt and repeated and even wrote down during her trance as specimens of a language spoken there, explained to her by a disembodied interpreter.

HENRY, WILLIAM (1775-1836), English chemist, son of Thomas Henry (1734-1816), an apothecary and writer on chemistry, was born at Manchester on the 12th of December 1775. He began to study medicine at Edinburgh in 1795, taking his doctor's degree in 1807, but ill-health interrupted his practice as a physician, and he devoted his time mainly to chemical research, especially in regard to gases. One of his best-known papers (*Phil. Trans.*, 1803) describes experiments on the quantity of gases absorbed by water at different temperatures and under different pressures, the conclusion he reached ("Henry's law") being that "water takes up of gas condensed by one, two or more additional atmospheres, a quantity which, ordinarily compressed, would be equal to twice, thrice, &c. the volume absorbed under the common pressure of the atmosphere." Others of his papers deal with gas-analysis, fire-damp, illuminating gas, the composition of hydrochloric acid and of ammonia, urinary and other morbid concretions, and the disinfecting powers of heat. His *Elements of Experimental Chemistry* (1799) enjoyed considerable vogue in its day, going through 11 editions in 30 years. He died at Pendlebury, near Manchester, on the 2nd of September 1836.

HENRYSON, ROBERT (c. 1425-c. 1500), Scottish poet, was born about 1425. It has been surmised that he was connected with the family of Henderson of Fordell, but of this there is no evidence. He is described, on the title-page of the 1570 edition of his *Fables*, as "scholemaister of Dunfermeling," probably of the grammar-school of the Benedictine Abbey there. There is no record of his having studied at St Andrews, the only Scottish university at this time; but in 1462 a "Master Robert Henryson" is named among those incorporated in the recently founded university of Glasgow. It is therefore likely that his first studies were completed abroad, at Paris or Louvain. He would appear to have been in lower orders, if, in addition to being master of the grammar-school, he is the notary Robert Henryson who subscribes certain deeds in 1478. As Dunbar (*q.v.*) refers to him as deceased in his *Lament for the Makaris*, his death may be dated about 1500.

Efforts have been made to draw up a chronology of his poems; but every scheme of this kind, is, in a stronger sense than in the case of Dunbar, mere guess-work. There are no biographical or bibliographical facts to guide us, and the "internal evidence" is inconclusive.

Henryson's longest, and in many respects his most original and effective work, is his *Morall Fabillis of Esope*, a collection of thirteen fables, chiefly based on the versions of Anonymus, Lydgate and Caxton. The outstanding merit of the work is its freshness of treatment. The old themes are retold with such vivacity, such fresh lights on human character, and with so much local "atmosphere," that they deserve the credit of original productions. They are certainly unrivalled in English fabulistic literature. The earliest available texts are the Charter text printed by Lekpreuk in Edinburgh in 1570 and the Harleyan MS. No. 3865 in the British Museum.

In the *Testament of Cresseid* Henryson supplements Chaucer's tale of Troilus with the story of the tragedy of Cresseid. Here again his literary craftsmanship saves him from the disaster which must have overcome another poet in undertaking to continue the part of the story which Chaucer had intentionally left untold. The description of Cresseid's leprosy, of her meeting with Troilus, of his sorrow and charity, and of her death, give the poem a high place in writings of this genre.

The poem entitled *Orpheus and Eurydice*, which is drawn from

Boethius, contains some good passages, especially the lyrical lament of Orpheus, with the refrains "Quhar art thou gane, my luf Erudices?" and "My lady quene and luf, Erudices." It is followed by a long *moralitas*, in the manner of the *Fables*.

Thirteen shorter poems have been ascribed to Henryson. Of these the pastoral dialogue "Robene and Makyne," perhaps the best known of his work, is the most successful. Its model may perhaps be found in the *pastourelles*, but it stands safely on its own merits. Unlike most of the minor poems it is independent of Chaucerian tradition. The other pieces deal with the conventional 15th-century topics, Age; Death; Hasty Credece; Want of Wise Men and the like. The verses entitled "Sum Practyals of Modecyde," in which some have failed to see Henryson's hand, is an example of that boisterous alliterative burlesque which is represented by a single specimen in the work of the greatest makers, Dunbar, Douglas and Lyndsay. For this reason, if not for others, the difference of its manner is no argument against its authenticity.

The MS. authorities for the text are the Asloan, Bannatyne, Maitland Folio, Macculloch, Gray and Riddell. Chepman and Myllar's Prints (1598) have preserved two of the minor poems and a fragment of *Orpheus and Eurydice*. The first complete edition was prepared by David Laing (4 vol., Edinburgh, 1865). A more exhaustive edition in three volumes, containing all the texts, was undertaken by the Scottish Text Society (ed. G. Gregory Smith), the first volume of the text (vol. ii. of the work) appearing in 1907. For a critical account of Henryson, see Irving's *History of Scottish Poetry*, Henderson's *Vernacular Scottish Literature*, Gregory Smith's *Transition Period*, J. H. Millar's *Literary History of Scotland*, and the second volume of the *Cambridge History of English Literature* (G. G. S.).

HENSCHEL, GEORGE (IMDOR GEORG) (1850-), English musician (naturalized 1900), of German family, was born at Breslau, and educated as a pianist, making his first public appearance in Berlin in 1862. He subsequently, however, took up singing, having developed a fine baritone voice; and in 1868 he sang the part of Hans Sachs in *Meistersinger* at Munich. In 1877 he began a successful career in England, singing at the principal concerts; and in 1881 he married the American soprano, Lillian Bailey (d. 1901), who was associated with him in a number of vocal recitals. He was also prominent as a conductor, starting the London symphony concerts in 1886, and both in England and America (where he was the first conductor of the Boston symphony concerts, 1881) he took a leading part in advancing his art. He composed a number of instrumental works, a fine *Stabat Mater* (Birmingham festival, 1894), &c., and an opera, *Nubia* (Dresden, 1899).

HENSELT, ADOLF VON (1814-1886), German composer, was born at Schwabach, in Bavaria, on the 12th of May 1814. At three years old he began to learn the violin, and at five the pianoforte under Frau v. Fladt. On obtaining financial help from King Louis I. he went to study under Hummel in Weimar, and thence in 1832 to Vienna, where, besides studying composition under Simon Sechter, he made a great success as a concert pianist. In order to recruit his health he made a prolonged tour in 1836 through the chief German towns. In 1837 he settled at Breslau, where he had married, but in the following year he migrated to St Petersburg, where previous visits had made him *persona grata* at Court. He then became court pianist and inspector of musical studies in the Imperial Institute of Female Education, and was ennobled. In 1852 and again in 1867 he visited England, though in the latter year he made no public appearance. St Petersburg was his home practically until his death, which took place at Warmbrunn on the 10th of October 1886. The characteristic of Henselt's playing was a combination of Liszt's sonority with Hummel's smoothness. It was full of poetry, remarkable for the great use he made of extended chords, and for his perfect technique. He excelled in his own works and in those of Weber and Chopin. His concerts in F minor is frequently played on the continent; and of his many valuable studies, *Si oiseau j'étais* is very familiar. His A minor trio deserves to be better known. At one time Henselt was second to Rubinstein in the direction of the St Petersburg Conservatorium.

HENSLOW, JOHN STEVENS (1796-1861), English botanist and geologist, was born at Rochester on the 6th of February 1796. From his father, who was a solicitor in that city, he imbibed a love of natural history which largely influenced his career. He was educated at St John's College, Cambridge, where he graduated as sixteenth wrangler in 1818, the year in which Sedgwick became Woodwardian professor of geology. He accompanied Sedgwick in 1819 during a tour in the Isle of Wight, and there he learned his first lessons in geology. He also studied chemistry under Professor James Cumming and mineralogy under E. D. Clarke. In the autumn of 1819 he made some valuable observations on the geology of the Isle of Man (*Trans. Geol. Soc.*, 1821), and in 1821 he investigated the geology of parts of Anglesey, the results being printed in the first volume of the *Transactions of the Cambridge Philosophical Society* (1821), the foundation of which society was originated by Sedgwick and Henslow. Meanwhile, Henslow had studied mineralogy with considerable zeal, so that on the death of Clarke he was in 1822 appointed professor of mineralogy in the university at Cambridge. Two years later he took holy orders. Botany, however, had claimed much of his attention, and to this science he became more and more attached, so that he gladly resigned the chair of mineralogy in 1825, to succeed to that of botany. As a teacher both in the class-room and in the field he was eminently successful. To him Darwin largely owed his attachment to natural history, and also his introduction to Captain Fitzroy of H.M.S. "Beagle." In 1832 Henslow was appointed vicar of Cholesey-cum-Moulsoford in Berkshire, and in 1837 rector of Hitcham in Suffolk, and at this latter parish he lived and laboured, endeared to all who knew him, until the close of his life. His energies were devoted to the improvement of his parishioners, but his influence was felt far and wide. In 1843 he discovered nodules of coprolitic origin in the Red Crag at Felixstowe in Suffolk, and two years later he called attention to those also in the Cambridge Greensand and remarked that they might be of use in agriculture. Although Henslow derived no benefit, these discoveries led to the establishment of the phosphate industry in Suffolk and Cambridgeshire; and the works proved lucrative until the introduction of foreign phosphates. The museum at Ipswich, which was established in 1847, owed much to Henslow, who was elected president in 1850, and then superintended the arrangement of the collections. He died at Hitcham on the 16th of May 1861. His publications included *A Catalogue of British Plants* (1829; ed. 2, 1835); *Principles of Descriptive and Physiological Botany* (1835); *Flora of Suffolk* (with E. Skepper) (1860).

Memoir, by the Rev. Leonard Jenyns (1862).

HENSLOWE, PHILIP (d. 1616), English theatrical manager, was the son of Edmund Henslowe of Lindfield, Sussex, master of the game in Ashdown Forest and Broil Park. He was originally a servant in the employment of the bailiff to Viscount Montague, whose property included Montague House in Southwark, and his duties led him to settle there before 1577. He subsequently married the bailiff's widow, and, with the fortune he got with her, he developed into a clever business man and became a considerable owner of Southwark property. He started his connexion with the stage when, on the 24th of March 1584, he bought land near what is now the southern end of Southwark Bridge, on which stood the Little Rose playhouse, afterwards rebuilt as the Rose. Successive companies played in it under Henslowe's financial management between 1592 and 1603. The theatre at Newington Butts was also under him in 1594. A share of the control in the Swan theatre, which like the Rose was on the Bankside, fell to Henslowe before the close of the 16th century. With the actor Edward Alleyn, who married his step-daughter Joan Woodward, he built in Golden Lane, Cripplegate Without, the Fortune Playhouse, opened in November 1600. In December of 1594, they had secured the Paris Garden, a place for bear-baiting, on the Bankside, and in 1604 they bought the office of master of the royal game of bears, bulls and mastiffs from the holder, and obtained a patent. Alleyn sold his share to Henslowe in February 1610, and three years later Henslowe formed a new partnership with Jacob Meade and built the Hope playhouse,

designed for stage performances as well as bull and bear-baiting, and managed by Meade.

In Henslowe's theatres were first produced many plays by the famous Elizabethan dramatists. What is known as "Henslowe's Diary" contains some accounts referring to Ashdown Forest between 1576 and 1581, entered by John Henslowe, while the later entries by Philip Henslowe from 1592 to 1609 are those which throw light on the theatrical matters of the time, and which have been subjected to much controversial criticism as a result of injuries done to the manuscript. "Henslowe's Diary" passed into the hands of Edward Alleyn, and thence into the Library of Dulwich College, where the manuscript remained intact for more than a hundred and fifty years. In 1780 Malone tried to borrow it, but it had been mislaid; in 1790 it was discovered and given into his charge. He was then at work on his *Variorum Shakespeare*. Malone had a transcript made of certain portions, and collated it with the original; and this transcript, with various notes and corrections by Malone, is now in the Dulwich Library. An abstract of this transcript he also published with his *Variorum Shakespeare*. The MS. of the diary was eventually returned to the library in 1812 by Malone's executor. In 1840 it was lent to J. P. Collier, who in 1845 printed for the Shakespeare Society what purported to be a full edition, but it was afterwards shown by G. F. Warner (*Catalogue* of the Dulwich Library, 1881) that a number of forged interpolations have been made, the responsibility for which rests on Collier.

The complicated history of the forgeries and their detection has been exhaustively treated in Walter W. Greg's edition of *Henslowe's Diary* (London, 1904; enlarged 1908).

HENTY, GEORGE ALFRED (1832-1902), English war-correspondent and author, was born at Trumpington, near Cambridge, in December 1832, and educated at Westminster School and Caius College, Cambridge. He served in the Crimea in the Purveyor's department, and after the peace filled various posts in the department in England and Ireland, but he found the routine little to his taste, and drifted into journalism for the *London Standard*. He volunteered as Special Correspondent for the Austro-Italian War of 1866, accompanied Garibaldi in his Tirolese Campaign, followed Lord Napier through the mountains gorges to Magdala, and Lord Wolseley across bush and swamp to Kumasi. Next he reported the Franco-German War, starved in Paris through the siege of the Commune, and then turned south to rough it in the Pyrenees during the Carlist insurrection. He was in Asiatic Russia at the time of the Khlva expedition, and later saw the desperate hand-to-hand fighting of the Turks in the Servian War. He found his real vocation in middle life. Invited to edit a magazine for boys called the *Union Jack*, he became the mainstay of the new periodical, to which he contributed several serials in succession. The stories pleased their public, and had ever increasing circulation in book form, until Henty became a name to conjure with in juvenile circles. Altogether he wrote about eighty of these books. Henty was an enthusiastic yachtsman, having spent at least six months afloat each year, and he died on board his yacht in Weymouth Harbour on the 16th of November 1902.

HENWOOD, WILLIAM JORY (1805-1875), English mining geologist, was born at Perron Wharf, Cornwall, on the 16th of January 1805. In 1822 he commenced work as a clerk in a mining office, and soon took an active interest in the working of mines and in the metalliferous deposits. In 1832 he was appointed to the office of assay-master and supervisor of tin in the duchy of Cornwall, a post from which he retired in 1838. Meanwhile he had commenced in 1826 to communicate papers on mining subjects to the Royal Geological Society of Cornwall, and the Geological Society of London, and in 1840 he was elected F.R.S. In 1843 he went to take charge of the Gongo-Soco mines in Brazil; afterwards he proceeded to India to report on certain metalliferous deposits for the Indian government; and in 1858, impaired in health, he retired and settled at Penzance. His most important memoirs on the metalliferous deposits of Cornwall and Devon were published in 1843 by the Royal Geological Society of Cornwall. At a much later date he communicated with enlarged

experience a second series of *Observations on Metalliferous Deposits, and on Subterranean Temperature* (reprinted from *Trans. R. Geol. Soc. Cornwall*, 2 vols., 1871). In 1874 he contributed a paper on the *Detrital Tin-ore of Cornwall* (*Journ. R. Inst. Cornwall*). The Murchison medal of the Geological Society was awarded to him in 1875, and the mineral Henwoodite was named after him. He died at Penzance on the 5th of August 1875.

HENZADA, a district of Lower Burma, formerly in the Pegu, but now in the Irrawaddy division. Area, 2870 sq. m. Pop. (1901) 484,558. It stretches from north to south in one vast plain, forming the valley of the Irrawaddy, and is divided by that river into two nearly equal portions. This country is protected from inundation by immense embankments, so that almost the whole area is suitable for rice cultivation. The chief mountains are the Arakan and Pegu Yoma ranges. The greatest elevation of the Arakan Yomas in Henzada, attained in the latitude of Myan-aung, is 4003 ft. above sea-level. Numerous torrents pour down from the two boundary ranges, and unite in the plains to form large streams, which fall into the chief streams of the district, which are the Irrawaddy, Hlaing and Bassein, all of them branches of the Irrawaddy. The forests comprise almost every variety of timber found in Burma. The bulk of the cultivation is rice, but a number of acres are under tobacco. The chief town of the district is HENZADA, which had in 1901 a population of 24,756. It is a municipal town, with ten elective and three *ex-officio* members. Other municipal towns in the district are Zalun, with a population of 6642; Myan-aung, with a population of 6351; and Kyangin, with a population of 7183, according to the 1901 census. The town of Lemythna had a population of 5831. The steamers of the Irrawaddy Flotilla Company call at Henzada and Myan-aung.

The district was once a portion of the Talaing kingdom of Pegu, afterwards annexed to the Burmese empire in 1753, and has no history of its own. During the second Burmese war, after Promé had been seized, the Burmese on the right bank of the Irrawaddy crossed the river and offered resistance to the British, but were completely routed. Meanwhile, in Tharawaddy, or the country east of the Irrawaddy, and in the south of Henzada, much disorder was caused by a revolt, the leaders of which were, however, defeated by the British and their gangs dispersed.

HEPBURN, SIR JOHN (c. 1598-1636), Scottish soldier in the Thirty Years' War, was a son of George Hepburn of Athelstanford near Haddington. In 1620 and in the following years he served in Bohemia, on the lower Rhine and in the Netherlands, and in 1623 he entered the service of Gustavus Adolphus, who, two years later, appointed him colonel of a Scottish regiment of his army. He took part with his regiment in Gustavus's Polish wars, and in 1631, a few months before the battle of Breitenfeld he was placed in command of the "Scots" or "Green" brigade of the Swedish army. At Breitenfeld it was Hepburn's brigade which delivered the decisive stroke, and after this he remained with the king, who placed the fullest reliance on his skill and courage, until the battle of the Alte Veste near Nuremberg. He then entered the French service, and raised two thousand men in Scotland for the French army, to which force was added in France the historic Scottish archer bodyguard of the French kings. The existing Royal Scots (Lothian) regiment (late 1st Foot) represents in the British army of to-day Hepburn's French regiment, and indirectly, through the amalgamation referred to, the Scottish contingent of the Hundred Years' War. Hepburn's claim to the right of the line of battle was bitterly resented by the senior French regiments. Shortly after this, in 1633, Hepburn was under a *maréchal de camp*, and he took part in the campaigns in Alsace and Lorraine (1634-36). In 1635 Bernhard of Saxe-Weimar, on entering the French service, brought with him Hepburn's former Swedish regiment, which was at once amalgamated with the French "régiment d'Hébron," the latter thus attaining the unusual strength of 8300 men. Sir John Hepburn was killed shortly afterwards during the siege of Saverne (Zabern) on the 8th of July 1636. He was buried in Toul cathedral. With his friend

Sir Robert Monro, Hepburn was the foremost of the Scottish soldiers of fortune who bore so conspicuous a part in the Thirty Years' War. He was a sincere Roman Catholic. It is stated that he left Gustavus owing to a jest about his religion, and at any rate he found in the French service, in which he ended his days, the opportunity of reconciling his beliefs with the desire of military glory which had led him into the Swedish army, and with the patriotic feeling which had first brought him out to the wars to fight for the Stuart princess, Queen Elizabeth of Bohemia. See James Grant, *Memoirs of Sir John Hepburn*.

HEPHAESTION, a Macedonian general, celebrated as the friend of Alexander the Great, who, comparing himself with Achilles, called Hephæstion his Patroclus. In the later campaigns in Bactria and India, he was entrusted with the task of founding cities and colonies, and built the fleet intended to sail down the Indus. He was rewarded with a golden crown and the hand of Drypetis, the sister of Alexander's wife Stateira (374). In the same year he died suddenly at Ecbatana. A general mourning was ordered throughout Asia; at Babylon a funeral pile was erected at enormous cost, and temples were built in his honour (see ALEXANDER THE GREAT).

HEPHAESTION, a grammarian of Alexandria, who flourished in the age of the Antonines. He was the author of a manual (abridged from a larger work in 48 books) of Greek metres ('Εργασμάτων περί μέτρων'), which is most valuable as the only complete treatise on the subject that has been preserved. The concluding chapter (Περὶ ποιημάτων) discusses the various kinds of poetical composition. It is written in a clear and simple style, and was much used as a school-book.

Editions by T. Gaisford (1855, with the valuable scholia), R. Westphal (1886, in *Scripturæ metricæ Græcæ*) and M. Conbruch (1906); translation by T. F. Barham (1843); see also W. Christ, *Gesch. der griech. Litt.* (1898); M. Conbruch, *De veterum Græcæ ποιημάτων doctrina* (1890); J. E. Sandys, *Hist. Class. Schol.* I. (1906).

HEPHAESTUS, in Greek mythology, the god of fire, analogous to, and by the ancients often confused with, the Roman god Vulcan (*g.w.*); the derivation of the name is uncertain, but it may well be of Greek origin. The elemental character of Hephæstus is far more apparent than is the case with the majority of the Olympian gods; the word Hephæstus was used as a synonym for fire not only in poetry (Homer, *Il.* ii. 426 and later), but also in common speech (Diod. v. 74). It is doubtful whether the origin of the god can be traced to any specific form of fire. As all earthly fire was thought to have come from heaven, Hephæstus has been identified with the lightning. This is supported by the myth of his fall from heaven, and by the fact that, according to the Homeric tradition, his father was Zeus, the heaven-god. On the other hand, the lightning is not associated with him in literature or cult, and his connexion with volcanic fires is so close as to suggest that he was originally a volcano-god. The connexion, however, though it may be early, is probably not primitive, and it seems reasonable to conclude that Hephæstus was a general fire-god, though some of his characteristics were due to particular manifestations of the element.

In Homer the fire-god was the son of Zeus and Hera, and found a place in the Olympian system as the divine smith. The *Iliad* contains two versions of his fall from heaven. In one account (i. 590) he was cast out by Zeus and fell on Lemnos; in the other, Hera threw him down immediately after his birth in disgust at his lameness, and he was received by the sea-goddesses Eurynome and Thetis. The Lemnian version is due to the prominence of his cult at Lemnos in very early times; and his fall into the sea may have been suggested by volcanic activity in Mediterranean islands, as at Lipara and Thera. The subsequent return of Hephæstus to Olympus is a favourite theme in early art. His wife was Charis, one of the Graces (in the *Iliad*) or Aphrodite (in the *Odyssey*). The connexion of the rough Hephæstus with these goddesses is curious; it may be due to the beautiful works of the smith-god (χαρῆνα ἔργα), but it is possibly derived from the supposed fertilizing and productive power of fire, in which case Hephæstus is a natural mate of Charis, a goddess of spring, and Aphrodite the goddess

of love. In Homer, the skill of Hephaestus in metallurgy is often mentioned; his forge was on Olympus, where he was served by images of golden handmaids which he had animated. Similar myths are found in relation to the Finnish smith-god Ilmarinen, who made a golden woman, and the Teutonic Wieland; a belief in the magical power of metal-workers is a common survival from an age in which their art was new and mysterious. In epic poetry Hephaestus is rather a comic figure, and his limping gait provokes "Homeric laughter" among the gods. In Vedic poetry Agni, the fire-god, is footless; and the ancients themselves attributed this lameness to the crooked appearance of flame (Servius on *Aen.* viii. 814), and possibly no better explanation can be found, though it has been suggested that in an early stage of society the trade of a smith would be suitable for the lame; Hephaestus and the lame Wieland would thus conform to the type of their human counterparts.

Except in Lemnos and Attica, there are few indications of any cult of Hephaestus. His association with Lemnos can be traced from Homer to the Roman age. A town in the island was called Hephaestia, and the functions of the god must have been wide, as we are told that his Lemnian priests could cure snake-bites. Once a year every fire was extinguished on the island for nine days, during which period sacrifice was offered to the gods of the underworld and the dead. After the nine days were passed, new fire was brought from the sacred hearth at Delos. The significance of this and similar customs is examined by J. G. Frazer, *Golden Bough*, iii. ch. 4. The close connexion of Hephaestus with Lemnos and especially with its mountain Mosychlus has been explained by the supposed existence of a volcano; but no crater or other sign of volcanic agency is now apparent, and the "Lemnian fire"—a phenomenon attributed to Hephaestus—may have been due to natural gas (see *LEMNOS*). In Sicily, however, the volcanic nature of the god is prominent in his cult at Etna, as well as in the neighbouring Liparaean isles. The Olympian forge had been transferred to Etna or some other volcano, and Hephaestus had become a subterranean rather than a celestial power.

The divine smith naturally became a "culture-god"; in Crete the invention of forging in iron was attributed to him, and he was honoured by all metal-workers. But we have little record of his cult in this aspect, except at Athens, where his worship was of real importance, belonging to the oldest stratum of Attic religion. A tribe was called after his name, and Erichthonius, the mythical father of the Attic people, was the son of Hephaestus. Terra-cotta statuettes of the god seem to have been placed before the hearths of Athenian houses. This temple has been identified, not improbably, with the so-called "Theseum"; it contained a statue of Athena, and the two deities are often associated, in literature and cult, as the joint givers of civilization to the Athenians. The class of artisans was under their special protection; and the joint festival of the two divinities—the Chalceia—commemorated the invention of bronze-working by Hephaestus. In the Hephaestea (the particular festival of the god) there was a torch race, a ceremonial not indeed confined to fire-gods like Hephaestus and Prometheus, but probably in its origin connected with them, whether its object was to purify and quicken the land, or (according to another theory) to transmit a new fire with all possible speed to places where the fire was polluted. If the latter view is correct, the torch race would be closely akin to the Lemnian fire-ritual which has been mentioned. The relation between Hephaestus and Prometheus is in some respects close, though the distinction between these gods is clearly marked. The fire, as an element, belongs to the Olympian Hephaestus; the Titan Prometheus, a more human character, steals it for the use of man. Prometheus resembles the Polynesian Maui, who went down to fetch fire from the volcano of Mahuika, the fire-god. Hephaestus is a culture-god mainly in his secondary aspect as the craftsman, whereas Prometheus originates all civilization with the gift of fire. But the importance of Prometheus is mainly mythological; the Titan belonged to a fallen dynasty, and in actual cult was largely superseded by Hephaestus.

In archaic art Hephaestus is generally represented as bearded, though occasionally a younger beardless type is found, as on a vase (in the British Museum), on which he appears as a young man assisting Athena in the creation of Pandora. At a later time the bearded type prevails. The god is usually clothed in a short sleeveless tunic, and wears a round close-fitting cap. His face is that of a middle-aged man, with unkempt hair. He is in fact represented as an idealized Greek craftsman, with the hammer, and sometimes the pincers. Some mythologists have compared the hammer of Hephaestus with that of Thor, and have explained it as the emblem of a thunder-god; but it is Zeus, not Hephaestus, who causes the thunder, and the emblems of the latter god are merely the signs of his occupation as a smith. In art no attempt was made, as a rule, to indicate the lameness of Hephaestus; but one sculptor (Alcámenes) is said to have suggested the deformity without spoiling the statue.

AUTHORITIES.—L. Preller (ed. C. Robert), *Griech. Mythologie*, i. 174 f. (Berlin, 1894); W. H. Roscher, *Lex. der griech. u. röm. Mythologie*, s.v. "Hephaistos" (Leipzig, 1884-1886); Harrison, *Myth. and Mon. of Ancient Athens*, p. 119 f. (London, 1890); O. Gruppe, *Griech. Mythologie u. Religionsgesch.* p. 1304 f. (Munich, 1906); O. Schrader and F. B. Jevons, *Prehistoric Antiquities of the Aryan People*, p. 161, &c. (London, 1890); L. R. Farnell, *Cults of the Greek States*, v. (1909). (E. E. S.)

HEPPENHEIM, a town of Germany, in the grand-duchy of Hesse-Darmstadt, on the Bergstrasse, between Darmstadt and Heidelberg, 21 m. N. of the latter by rail. Pop. (1905), 6364. It possesses a parish church, occupying the site of one reputed to have been built by Charlemagne about 805, an interesting town hall and several schools. On an isolated hill close by stand the extensive ruins of the castle of Starckenburg, built by the abbot, Ulrich von Lorsch, about 1064 and destroyed during the Seven Years' War, and another hill, the Landberg, was a place of assembly in the middle ages. Heppenheim, at first the property of the abbey of Lorsch, became a town in 1318. After belonging to the Rhenish Palatinate, it came into the possession of Hesse-Darmstadt in 1803. Hops, wine and tobacco are grown, and there are large stone quarries, and several small industries in the town.

HEPPLEWHITE, GEORGE (d. 1786), one of the most famous English cabinet-makers of the 18th century. There is practically no biographical material relating to Hepplewhite. The only facts that are known with certainty are that he was apprenticed to Gillow at Lancaster, that he carried on business in the parish of Saint Giles, Cripplegate, and that administration of his estate was granted to his widow Alice on the 27th of June 1786. The administrator's accounts, which were filed in the Prerogative Court of Canterbury a year later, indicate that his property was of considerable value. After his death the business was continued by his widow under the style of A. Hepplewhite & Co. Our only approximate means of identifying his work are *The Cabinet-Maker and Upholsterer's Guide*, which was first published in 1788, two years after his death, and ten designs in *The Cabinet-maker's London Book of Prices* (1788), issued by the London Society of Cabinet-Makers. It is, however, exceedingly difficult to earmark any given piece of furniture as being the actual work or design of Hepplewhite, since it is generally recognized that to a very large extent the name represents rather a fashion than a man. Lightness, delicacy and grace are the distinguishing characteristics of Hepplewhite work. The massiveness of Chippendale had given place to conceptions that, especially in regard to chairs—which had become smaller as hoops went out of fashion—depended for their effect more upon inlay than upon carving. In one respect at least the Hepplewhite style was akin to that of Chippendale—in both cases the utmost ingenuity was lavished upon the chair, and if Hepplewhite was not the originator he appears to have been the most constant and successful user of the shield back. This elegant form was employed by the school in a great variety of designs, and nearly always in a way artistically satisfying. Where Chippendale, his contemporaries and his immediate successors had used the cabriole and the square leg with a good deal of carving, the Hepplewhite manner preferred a slighter leg, plain, fluted or reeded, tapering to

a spade foot which often became the "spider leg" that characterized much of the late 18th-century furniture; this form of leg was indeed not confined to chairs but was used also for tables and sideboards. Of the dainty drawing-room grace of the style there can be no question. The great majority of modern chairs are of Hepplewhite inspiration, while he, or those who worked with him, appears to have a clear claim to have originated, or at all events popularized, the winged easy-chair, in which the sides are continued to the same height as the back. This is probably the most comfortable type of chair that has ever been made. The backs of Hepplewhite chairs were often adorned with galleries and festoons of wheat-ears or pointed fern leaves, and not infrequently with the prince of Wales's feathers in some more or less decorative form. The frequency with which this badge was used has led to the suggestion either that A. Hepplewhite & Co. were employed by George IV. when prince of Wales, or that the feathers were used as a political emblem. The former suggestion is obviously the more feasible, but there is little doubt that the feathers were used by other makers working in the same style. It has been objected as an artistic flaw in Hepplewhite's chairs that they have the appearance of fragility. They are, however, constructionally sound as a rule. The painted and japanned work has been criticized on safer grounds. This delicate type of furniture, often made of satinwood, and painted with wreaths and festoons, with amorini and musical instruments or floral motives, is the most elegant and pleasing that can be imagined. It has, however, no elements of decorative permanence. With comparatively little use the paintings wear off and have to be renewed. A piece of untouched painted satinwood is almost unknown, and one of the essential charms of old furniture as of all other antiques is that it should retain the patina of time. A large proportion of Hepplewhite furniture is inlaid with the exotic woods which had come into high favour by the third quarter of the 18th century. While the decorative use upon furniture of so evanescent a medium as paint is always open to criticism, any form of marquetry is obviously legitimate, and, if inlaid furniture be less ravishing to the eye, its beauty is but enhanced by time. It was not in chairs alone that the Hepplewhite manner excelled. It acquired, for instance, a speciality of seats for the tall, narrow Georgian sash windows, which in the Hepplewhite period had almost entirely superseded the more picturesque forms of an earlier time. These window-seats had ends rolling over outwards, and no backs, and despite their skimpiness their elegant simplicity is decidedly pleasing. Elegance, in fact, was the note of a style which on the whole was more distinctly English than that which preceded or immediately followed it. The smaller Hepplewhite pieces are much prized by collectors. Among these may be included urn-shaped knife-boxes in mahogany and satinwood, charming in form and decorative in the extreme; inlaid tea-caddies, varying greatly in shape and material, but always appropriate and *coquet*; delicate little fire-screens with shaped poles; painted work-tables, and inlaid stands. Hepplewhite's bedsteads with carved and fluted pillars were very handsome and attractive. The evolution of the dining-room sideboard made rapid progress towards the end of the 18th century, but neither Hepplewhite nor those who worked in his style did much to advance it. Indeed they somewhat retarded its development by causing it to revert to little more than that side-table which had been its original form. It was, however, a very delightful table with its undulating front, its many elegant spade-footed legs and its delicate carving. If we were dealing with a less elusive personality it would be just to say that Hepplewhite's work varies from the extreme of elegance and the most delicious simplicity to an unimaginative commonplace, and sometimes to actual ugliness. As it is, this summary may well be applied to the style as a whole—a style which was assuredly not the creation of any one man, but owed much alike of excellence and of defect to a school of cabinet-makers who were under the influence of conflicting tastes and changing ideals. At its best the taste was so fine and so full of distinction, so simple, modest and sufficient, that it amounted to genius. On its lower planes it was clearly influenced

by commercialism and the desire to make what tasteless people preferred. Yet this is no more than to say that the Hepplewhite style succumbed sometimes, perhaps very often, to the eternal enemy of all art—the uninspired banality of the average man. (J. P.-B.)

HEPTARCHY (Gr. *ἑπτὰ* seven, and *ἀρχή*, rule), a word which is frequently used to designate the period of English history between the coming of the Anglo-Saxons in 449 and the union of the kingdoms under Egbert in 828. It was first used during the 16th century because of the belief held by Camden and other older historians, that during this period there were exactly seven kingdoms in England, these being Northumbria, Mercia, East Anglia, Essex, Kent, Sussex and Wessex. This belief is erroneous, as the number of kingdoms varied considerably from time to time; nevertheless the word still serves a useful purpose to denote the period.

HERA, in Greek mythology, the sister and wife of Zeus and queen of the Olympian gods; she was identified by the Romans with Juno. The derivation of the name is obscure, but there is no reason to doubt that she was a genuine Greek deity. There are no signs of Oriental influence in her cults, except at Corinth, where she seems to have been identified with Astarte. It is probable that she was originally a personification of some department of nature; but the traces of her primitive significance are vague, and have been interpreted to suit various theories. Some of the ancients connected her with the earth; Plato, followed by the Stoics, derived her name from *ἀήρ*, the air. Both theories have been revived in modern times, the former notably by F. G. Welcker, the latter by L. Preller. A third view, that Hera is the moon, is held by W. H. Roscher and others. Of these explanations, that advanced by Preller has little to commend it, even if, with O. Gruppe, we understand the air-goddess as a storm deity; some of the arguments in support of the two other theories will be examined in this article.

Whatever may have been the origin of Hera, to the historic Greeks (except a few poets or philosophers) she was a purely anthropomorphic goddess, and had no close relation to any province of nature. In literature, from the times of Homer and Hesiod, she played an important part, appearing most frequently as the jealous and resentful wife of Zeus. In this character she pursues with vindictive hatred the heroines, such as Alcmena, Leto and Semele, who were beloved by Zeus. She visits his sins upon the children born of his intrigues, and is thus the constant enemy of Heracles and Dionysus. This character of the offended wife was borrowed by later poets from the Greek epic; but it belongs to literature rather than to cult, in which the dignity and power of the goddess is naturally more emphasized.

The worship of Hera is found, in different degrees of prominence, throughout the Greek world. It was especially important in the ancient Achaean centres, Argos, Mycenae and Sparta, which she claims in the *Iliad* (iv. 51) as her three dearest cities. Whether Hera was also worshipped by the early Dorians is uncertain; after the Dorian invasion she remained the chief deity of Argos, but her cult at Sparta was not so conspicuous. She received honour, however, in other parts of the Peloponnese, particularly in Olympia, where her temple was the oldest, and in Arcadia. In several Boeotian cities she seems to have been one of the principal objects of worship, while the neighbouring island of Euboea probably derived its name from a title of Hera, who was "rich in cows" (*Βεβωα*). Among the islands of the Aegean, Samos was celebrated for the cult of Hera; according to the local tradition, she was born in the island. As Hera Lacinia (from her Lacinian temple near Croton) she was extensively worshipped in Magna Graecia.

The connexion of Zeus and Hera was probably not primitive, since Dione seems to have preceded Hera as the wife of Zeus at Dodona. The origin of the connexion may possibly be due to the fusion of two "Pelagic" tribes, worshipping Zeus and Hera respectively; but speculation on the earliest cult of the goddess, before she became the wife of Zeus, must be largely conjectural. The close relation of the two deities appears in a

frequent community of altars and sacrifices, and also in the *ἑρπὸς γάμος*, a dramatic representation of their sacred marriage. The festival, which was certainly ancient, was held not only in Argos, Samos, Euboea and other centres of Hera-worship, but also in Athens, where the goddess was obscured by the predominance of Athena. The details of the *ἑρπὸς γάμος* may have varied locally, but the main idea of the ritual was the same. In the Daedala, as the festival was called at Plataea, an effigy was made from an oak-tree, dressed in bridal attire, and carried in a cart with a woman who acted as bridesmaid. The image was called Daedale, and the ritual was explained by a myth: Hera had left Zeus in her anger; in order to win her back, Zeus announced that he was about to marry, and dressed up a puppet to imitate a bride; Hera met the procession, tore the veil from the false bride, and, on discovering the ruse, became reconciled to her husband. The image was put away after each occasion; every sixty years a large number of such images, which had served in previous celebrations, were carried in procession to the top of Mount Cithaeron, and were burned on an altar together with animals and the altar itself. As Frazer notes (*Golden Bough*,³ i. 227), this festival appears to belong to the large class of mimetic charms designed to quicken the growth of vegetation; the marriage of Zeus and Hera would in this case represent the union of the king and queen of May. But it by no means follows that Hera was therefore originally a goddess of the earth or of vegetation. When the real nature of the ritual had become lost or obscured, it was natural to explain it by the help of an aetiological myth; in European folklore, images, corresponding to those burnt at the Daedala, were sometimes called Judas Iscariot or Luther (*Golden Bough*,³ iii. 315). At Samos the *ἑρπὸς γάμος* was celebrated annually; the image of Hera was concealed on the sea-shore and solemnly discovered. This rite seems to reflect an actual custom of abduction; or it may rather refer to the practice of intercourse between the betrothed before marriage. Such intercourse was sanctioned by the Samians, who excused it by the example of Zeus and Hera (schol. on *Il.* xiv. 296). There is nothing in the Samian *ἑρπὸς γάμος* to suggest a marriage of heaven and earth, or of two vegetation-spirits; as Dr Farnell points out, the ritual appears to explain the custom of human nuptials. The sacred marriage, therefore, though connected with vegetation at the Daedala, was not necessarily a vegetation-charm in its origin; consequently, it does not prove that Hera was an earth-goddess or tree-spirit. It is at least remarkable that, except at Argos, Hera had little to do with agriculture, and was not closely associated with such deities as Cybele, Demeter, Persephone and Dionysus, whose connexion with the earth, or with its fruits, is beyond doubt.

In her general cult Hera was worshipped in two main capacities: (1) as the consort of Zeus and queen of heaven; (2) as the goddess who presided over marriage, and, in a wider sense, over the various phases of a woman's life. Dionysius of Halicarnassus (*Ant. rhet.* ii. 2) calls Zeus and Hera the first wedded pair, and a sacrifice to Zeus *ἑλευος* and Hera *ἑλεία* was a regular feature of the Greek wedding. Girls offered their hair or veils to Hera before marriage. In Aristophanes (*Thesm.* 973) she "keeps the keys of wedlock." The marriage-goddess naturally became the protector of women in childbirth, and bore the title of the birth-goddess (Eileithyia), at Argos and Athens. In Homer (*Il.* xi. 270) and Hesiod (*Theog.* 922) she is the mother of the Eileithyiae, or the single Eileithyia. Her cult-titles *παρθένος* (or *παῖς*), *ἑλεία* and *χώρα* the "maiden," "wife," and "widow" (or "divorced") have been interpreted as symbolical of the earth in spring, summer, and winter; but they may well express the different conditions in the lives of her human worshippers. The Argives believed that Hera recovered her virginity every year by bathing in a certain spring (Paus. viii. 22, 2), a belief which probably reflects the custom of ceremonial purification after marriage (see Frazer, *Adonis*, p. 176). Although Hera was not the bestower of feminine charm to the same extent as Aphrodite, she was the patron of a contest for beauty in a Lesbian festival (*καλλιστεία*). This intimate

relation with women has been held a proof that Hera was originally a moon-goddess, as the moon is often thought to influence childbirth and other aspects of feminine life. But Hera's patronage of women, though undoubtedly ancient, is not necessarily primitive. Further, the Greeks themselves, who were always ready to identify Artemis with the moon, do not seem to have recognized any lunar connexion in Hera.

Among her particular worshippers, at Argos and Samos, Hera was much more than the queen of heaven and the marriage-goddess. As the patron of these cities (*πολιούχος*) she held a place corresponding to that of Athena in Athens. The Argives are called "the people of Hera" by Pindar; the Heraeum, situated under a mountain significantly called Mt. Euboea, was the most important temple in Argolis. Here the agricultural character of her ritual is well marked; the first oxen used in ploughing were, according to an Argive myth, dedicated to her as *ἑρπιδία*; and the sprouting ears of corn were called "the flowers of Hera." She was worshipped as the goddess of flowers (*ἄρθεία*); girls served in her temple under the name of "flower-bearers," and a flower festival (*Ἡροσθαθία*, *Ἡροσθία*) was celebrated by Peloponnesian women in spring. These rites recall our May day observance, and give colour to the earth-goddess theory. On the other hand it must be remembered that the patron deity of a Greek state had very wide functions; and it is not surprising to find that Hera (whatever her origin may have been) assumed an agricultural character among her own people whose occupations were largely agricultural. So, although the warlike character of Hera was not elsewhere prominent, she assumed a militant aspect in her two chief cities; a festival called the Shield (*ἀσπίς*, in Pindar *ἀγών χάλκεος*) was part of the Argive cult, and there was an armed procession in her honour at Samos. The city-goddess, whether Hera or Athena, must be chief alike in peace and war.

The cow was the animal specially sacred to Hera both in ritual and in mythology. The story of Io, metamorphosed into a cow, is familiar; she was priestess of Hera, and was originally, no doubt, a form of the goddess herself. The Homeric epithet *βοώπις* may have meant "cow-faced" to the earliest worshippers of Hera, though by Homer and the later Greeks it was understood as "large-eyed," like the cow. A car drawn by oxen seems to have been widely used in the processions of Hera, and the cow was her most frequent sacrifice. The origin of Hera's association with the cow is uncertain, but there is no need to see in it, with Roscher, a symbol of the moon. The cuckoo was also sacred to Hera, who, according to the Argive legend, was wooed by Zeus in the form of the bird. In later times the peacock, which was still unfamiliar to the Greeks in the 5th century, was her favourite, especially at Samos.

The earliest recorded images of Hera preceded the rise of Greek sculpture; a log at Thespiea, a plank at Samos, a pillar at Argos served to represent the goddess. In the archaic period of sculpture the *ἑραῖον* or wooden statue of the Samian Hera by Smilis was famous. In the first half of the 5th century the sacred marriage was represented on an extant metope from a temple at Selinus. The most celebrated statue of Hera was the chryselephantine work of Polyclitus, made for the Heraeum at Argos soon after 423 B.C. It is fully described by Pausanias, who says that Hera was seated on a throne, wearing a crown (*στέφανος*), and carrying a sceptre in one hand and a pomegranate in the other. Various ancient writers testify to the beauty and dignity of the statue, which was considered equal to the Zeus of Pheidias. Polyclitus seems to have fixed the type of Hera as a youthful matron, but unfortunately the exact character of her head cannot be determined. A majestic and rather severe beauty marks the conception of Hera in later art, of which the Farnese bust at Naples and the Ludovisi Hera are the most conspicuous examples.

AUTHORITIES.—F. G. Welcker, *Griech. Götterl.* i. 262 f. (Göttingen, 1857-1863); L. Fretler (ed. C. Roberts), *Griech. Mythologie*, i. 160 f. (Berlin, 1894); W. H. Roscher, *Lex. der griech. u. röm. Mythologie*, s.v. (Leipzig, 1884); C. Daremberg and E. Saglio,

Dict. des ant. grecques et rom. s.v. "Juno" (Paris, 1877); L. R. Farnell, Cults of the Greek States, i. 179 f. (Oxford, 1896); A. B. Cook in Class. Rev. xx. 365 f. 416 f.; O. Gruppe, Griech. Mythologie u. Religionsgesch., p. 1121 f. (Munich, 1903). In the article GREEK ART, fig. 24, will be found a roughly executed head of Hera, from the pediment of the treasury of the Megarians. (E. E. S.)

HERACLEA, the name of a large number of ancient cities founded by the Greeks.

1. **HERACLEA** (Gr. Ἡράκλεια), an ancient city of Lucania, situated near the modern Policoro, 3 m. from the coast of the gulf of Tarentum, between the rivers Aciris (Agri) and Siris (Sinni) about 13 m. S.S.W. of Metapontum. It was a Greek colony founded by the Tarentines and Thurians in 432 B.C., the former being predominant. It was chosen as the meeting-place of the general assembly of the Italiot Greeks, which Alexander of Epirus, after his alienation from Tarentum, tried to transfer to Thurii. Here Pyrrhus, king of Epirus, defeated the consul Laevinus in 280 B.C., after he had crossed the river Siris. In 278 B.C., or possibly in 282 B.C., probably in order to detach it from Tarentum, the Romans made a special treaty with Heraclea, on such favourable terms that in 80 B.C. the Roman citizenship given to the inhabitants by the Lex Plautia Papiria was only accepted after considerable hesitation. We hear that Heraclea surrendered under compulsion to Hannibal in 212 B.C. and that in the Social war the public records were destroyed by fire. Cicero in his defence of the poet Archias, an adopted citizen of Heraclea, speaks of it as a flourishing town. As a consequence of its having accepted Roman citizenship, it became a *municipium*; part of a copy of the Lex Iulia Municipalis of 46 B.C. (engraved on the back of two bronze tablets, on the front of which is a Greek inscription of the 3rd century B.C. defining the boundaries of lands belonging to various temples), which was found between Heraclea and Metapontum, is of the highest importance for our knowledge of that law. It was still a place of some importance under the empire; a branch road from Venusia joined the coast road here. The circumstances of its destruction and abandonment was unknown; the site is now marked by a few heaps of ruins. Its medieval representative was Anglona, once a bishopric, but now itself a heap of ruins, among which are those of an 11th-century church.

2. **HERACLEA MINOA**, an ancient town on the south coast of Sicily, at the mouth of the river Halycus, near the modern Montallegro, some 20 m. N.W. of Girgenti. It was at first an outpost of Selinus (Herod. v. 46), then overthrown by Carthage, later a border town of Agrigentum. It passed into Carthaginian hands by the treaty of 405 B.C., was won back by Dionysius in his first Punic war, but recovered by Carthage in 383. From this date onwards coins bearing its Semitic name, *Ras Melkart*, become common, and it was obviously an important border fortress. It was here that Dion landed in 357 B.C., when he attacked Syracuse. The Agrigentines won it back in 309, but it soon fell under the power of Agathocles. It was temporarily recovered for Greece by Pyrrhus. (T. As.)

3. **HERACLEA PONTICA** (mod. *Bender Ereğli*), an ancient city on the coast of Bithynia in Asia Minor, at the mouth of the Kilijsu. It was founded by a Megarian colony, which soon subjugated the native Mariandynians and extended its power over a considerable territory. The prosperity of the city, rudely shaken by the Galatians and the Bithynians, was utterly destroyed in the Mithradatic war. It was the birthplace of Heracles Ponticus. The modern town is best known for its lignite coal-mines, from which Constantinople receives a good part of its supply.

4. **HERACLEA SYNTICA**, a town in Thracian Macedonia, to the south of the Strymon, the site of which is marked by the village of Zervokhori, and identified by the discovery of local coins.

5. **HERACLEA**, a town on the borders of Caria and Ionia, near the foot of Mount Latmus. In its neighbourhood was the burial cave of Endymion.

6. **HERACLEA-CYBISTRA** (mod. *Ereğli* in the vilayet of Konia), under the name Cybistra, had some importance in Hellenistic times owing to its position near the point where the road to the Cilician Gates enters the hills. It lay in the way of armies and was

more than once sacked by the Arab invaders of Asia Minor (A.D. 805 and 832). It became Turkish (Seljuk) in the 11th century. Modern Ereğli had grown from a large village to a town since the railway reached it from Konia and Karaman in 1904; and it has now an hotel and good shops. Three hours' ride S. is the famous "Hittite" rock-relief of Ivritz, representing a king (probably of neighbouring Tyana) adoring a god (see HITTITES). This was the first "Hittite" monument discovered in modern times (early 18th century, by the Swede Otter, an emissary of Louis XIV.).

For Heraclea Trachinia see TRACHIS, and for Heraclea Perinthus see PERINTHUS.

HERACLEA was also the name of one of the Sporades, between Naxos and Ios, which is still called Raklia, and bears traces of a Greek township with temples to Tyche and Zeus Lophites.

(D. C. H.)

HERACLEON, a Gnostic who flourished about A.D. 125, probably in the south of Italy or in Sicily, and is generally classed by the early heresiologists with the Valentinian school of heresy. In his system he appears to have regarded the divine nature as a vast abyss in whose *pleroma* were aeons of different orders and degrees,—emanations from the source of being. Midway between the supreme God and the material world was the Demiurgus, who created the latter, and under whose jurisdiction the lower, animal soul of man proceeded after death, while his higher, celestial soul returned to the *pleroma* whence at first it issued. Though conspicuously uniting faith in Christ with spiritual maturity, there are evidences that, like other Valentinians, Heracleon did not sufficiently emphasize abstinence from the moral laxity and worldliness into which his followers fell. He seems to have received the ordinary Christian scriptures; and Origen, who treats him as a notable exegete, has preserved fragments of a commentary by him on the fourth gospel (brought together by Grabe in the second volume of his *Spicilegium*), while Clement of Alexandria quotes from him what appears to be a passage from a commentary on Luke. These writings are remarkable for their intensely mystical and allegorical interpretations of the text.

HERACLEONAS, east-Roman emperor (Feb.—Sept. 641), was the son of Heraclius (q.v.) and Martina. At the end of Heraclius' reign he obtained through his mother's influence the title of Augustus (638), and after his father's death was proclaimed joint emperor with his half-brother Constantine III. The premature death of Constantine, in May 641, left Heracleonas sole ruler. But a suspicion that he and Martina had murdered Constantine led soon after to a revolt, and to the mutilation and banishment of the supposed offenders. Nothing further is known about Heracleonas subsequent to 641.

HERACLIDAE, the general name for the numerous descendants of Heracles (Hercules), and specially applied in a narrower sense to the descendants of Hyllus, the eldest of his four sons by Deianeirathe, conquerors of Peloponnesus. Heracles, whom Zeus had originally intended to be ruler of Argos, Lacedaemon and Messenian Pylos, had been supplanted by the cunning of Hera, and his intended possessions had fallen into the hands of Eurystheus, king of Mycenae. After the death of Heracles, his children, after many wanderings, found refuge from Eurystheus at Athens. Eurystheus, on his demand for their surrender being refused, attacked Athens, but was defeated and slain. Hyllus and his brothers then invaded Peloponnesus, but after a year's stay were forced by a pestilence to quit. They withdrew to Thessaly, where Aegimius, the mythical ancestor of the Dorians, whom Heracles had assisted in war against the Lapithae, adopted Hyllus and made over to him a third part of his territory. After the death of Aegimius, his two sons, Pamphilus and Dymas, voluntarily submitted to Hyllus (who was, according to the Dorian tradition in Herodotus v. 72, really an Achaean), who thus became ruler of the Dorians, the three branches of that race being named after these three heroes. Being desirous of reconquering his paternal inheritance, Hyllus consulted the Delphic oracle, which told him to wait for "the third fruit," and then enter Peloponnesus by "a narrow passage by sea."

Accordingly, after three years, Hyllus marched across the isthmus of Corinth to attack Atreus, the successor of Eurystheus, but was slain in single combat by Echemus, king of Tegea. This second attempt was followed by a third under Cleodaeus and a fourth under Aristomachus, both of which were equally unsuccessful. At last, Temenus, Cresphontes and Aristodemus, the sons of Aristomachus, complained to the oracle that its instructions had proved fatal to those who had followed them. They received the answer that by the "third fruit" the "third generation" was meant, and that the "narrow passage" was not the isthmus of Corinth, but the straits of Rhium. They accordingly built a fleet at Naupactus, but before they set sail, Aristodemus was struck by lightning (or shot by Apollo) and the fleet destroyed, because one of the Heraclidae had slain an Acarnanian soothsayer. The oracle, being again consulted by Temenus, bade him offer an expiatory sacrifice and banish the murderer for ten years, and look out for a man with three eyes to act as guide. On his way back to Naupactus, Temenus fell in with Oxylius, an Aetolian, who had lost one eye, riding on a horse (thus making up the three eyes) and immediately pressed him into his service. According to another account, a mule on which Oxylius rode had lost an eye. The Heraclidae repaired their ships, sailed from Naupactus to Antirrhium, and thence to Rhium in Peloponnesus. A decisive battle was fought with Tisamenus, son of Orestes, the chief ruler in the peninsula, who was defeated and slain. The Heraclidae, who thus became practically masters of Peloponnesus, proceeded to distribute its territory among themselves by lot. Argos fell to Temenus, Lacedaemon to Procles and Eurysthenes, the twin sons of Aristodemus; and Messene to Cresphontes. The fertile district of Elis had been recovered by agreement for Oxylius. The Heraclidae ruled in Lacedaemon till 221 B.C., but disappeared much earlier in the other countries. This conquest of Peloponnesus by the Dorians, commonly called the "Return of the Heraclidae," is represented as the recovery by the descendants of Heracles of the rightful inheritance of their hero ancestor and his sons. The Dorians followed the custom of other Greek tribes in claiming as ancestor for their ruling families one of the legendary heroes, but the traditions must not on that account be regarded as entirely mythical. They represent a joint invasion of Peloponnesus by Aetolians and Dorians, the latter having been driven southward from their original northern home under pressure from the Thessalians. It is noticeable that there is no mention of these Heraclidae or their invasion in Homer or Hesiod. Herodotus (vi. 52) speaks of poets who had celebrated their deeds, but these were limited, to events immediately succeeding the death of Heracles. The story was first amplified by the Greek tragedians, who probably drew their inspiration from local legends, which glorified the services rendered by Athens to the rulers of Peloponnesus.

Apollodorus ii. 8; Diod. Sic. iv. 57, 58; Pausanias i. 32, 41, ii. 13, 18, iii. 1, iv. 3, v. 3; Euripides, *Heraclidae*; Pindar, *Pythia*, ix. 137; Herodotus ix. 27. See Müller's *Dorians*, i. ch. 3; Thirlwall, *History of Greece*, ch. vii.; Grote, *Hist. of Greece*, pt. i. ch. xviii.; Busolt, *Griechische Geschichte*, i. ch. ii. sec. 7, where a list of modern authorities is given.

HERACLIDES PONTICUS, Greek philosopher and miscellaneous writer, born at Heraclea in Pontus, flourished in the 4th century B.C. He studied philosophy at Athens under Spensippus, Plato and Aristotle. According to Suidas, Plato, on his departure for Sicily, left his pupils in charge of Heraclides. The latter part of his life was spent at Heraclea. He is said to have been vain and fat, and to have been so fond of display that he was nicknamed Pompicus, or the Showy (unless the epithet refers to his literary style). Various idle stories are related about him. On one occasion, for instance, Heraclea was afflicted with famine, and the Pythian priestess at Delphi, bribed by Heraclides, assured his inquiring townsmen that the dearth would be stayed if they granted a golden crown to that philosopher. This was done; but just as Heraclides was receiving his honour in a crowded assembly, he was seized with apoplexy, while the dishonest priestess perished at the same moment from the bite of a serpent. On his death-bed he is said to have requested a

friend to hide his body as soon as life was extinct, and, by putting a serpent in its place, induce his townsmen to suppose that he had been carried up to heaven. The trick was discovered, and Heraclides received only ridicule instead of divine honours (Diogenes Laërtius v. 6). Whatever may be the truth about these stories, Heraclides seems to have been a versatile and prolific writer on philosophy, mathematics, music, grammar, physics, history and rhetoric. Many of the works attributed to him, however, are probably by one or more persons of the same name.

The extant fragment of a treatise *On Constitutions* (C.W. Müller, *F.H.G.* ii. 197-207) is probably a compilation from the *Politics* of Aristotle by Heraclides Lembos, who lived in the time of Ptolemy VI. Philometor (181-146). See Otto Voss, *De Heraclidis Pontici vita et scriptis* (1896).

HERACLITUS (Ἡράκλειτος; c. 540-475 B.C.), Greek philosopher, was born at Ephesus of distinguished parentage. Of his early life and education we know nothing; from the contempt with which he spoke of all his fellow-philosophers and of his fellow-citizens as a whole we may gather that he regarded himself as self-taught and a pioneer of wisdom. So intensely aristocratic (hence his nickname *ὄχλοδόμος*, "he who rails at the people") was his temperament that he declined to exercise the regal-hieratic office of *βασιλεύς* which was hereditary in his family, and presented it to his brother. It is probable, however, that he did occasionally intervene in the affairs of the city at the period when the rule of Persia had given place to autonomy; it is said that he compelled the usurper Melancomas to abdicate. From the lonely life he led, and still more from the extreme profundity of his philosophy and his contempt for mankind in general, he was called the "Dark Philosopher" (ὁ σκοτεινός), or the "Weeping Philosopher," in contrast to Democritus, the "Laughing Philosopher."

Heraclitus is in a real sense the founder of metaphysics. Starting from the physical standpoint of the Ionian physicists, he accepted their general idea of the unity of nature, but entirely denied their theory of being. The fundamental uniform fact in nature is constant change (*πάντα χωρεῖ καὶ οὐδὲν μένει*); everything both is and is not at the same time. He thus arrives at the principle of Relativity; harmony and unity consist in diversity and multiplicity. The senses are "bad witnesses" (*κακοὶ μάρτυρες*); only the wise man can obtain knowledge.

To appreciate the significance of the doctrines of Heraclitus, it must be borne in mind that to Greek philosophy the sharp distinction between subject and object which pervades modern thought was foreign, a consideration which suggests the conclusion that, while it is a great mistake to reckon Heraclitus with the materialistic cosmologists of the Ionic schools, it is, on the other hand, going too far to treat his theory, with Hegel and Lassalle, as one of pure Panlogism. Accordingly, when he denies the reality of Being, and declares Becoming, or eternal flux and change, to be the sole actuality, Heraclitus must be understood to enunciate not only the unreality of the abstract notion of being, except as the correlative of that of not-being, but also the physical doctrine that all phenomena are in a state of continuous transition from non-existence to existence, and vice versa, without either distinguishing these propositions or qualifying them by any reference to the relation of thought to experience. "Every thing is and is not"; all things are, and nothing remains. So far he is in general agreement with Anaximander (*q.v.*), but he differs from him in the solution of the problem, disliking, as a poet and a mystic, the primary matter which satisfied the patient researcher, and demanding a more vivid and picturesque element. Naturally he selects fire, according to him the most complete embodiment of the process of Becoming, as the principle of empirical existence, out of which all things, including even the soul, grow by way of a *quasi* condensation, and into which all things must in course of time be again resolved. But this primordial fire is in itself that divine rational process, the harmony of which constitutes the law of the universe (see *LOGOS*). Real knowledge consists in comprehending this all-pervading harmony as embodied in the manifold of perception, and the senses are "bad-witnesses," because they apprehend phenomena,

not as its manifestation, but as "stiff and dead." In like manner real virtue consists in the subordination of the individual to the laws of this harmony as the universal reason wherein alone true freedom is to be found. "The law of things is a law of Reason Universal (*λόγος*), but most men live as though they had a wisdom of their own." Ethics here stands to sociology in a close relation, similar, in many respects, to that which we find in Hegel and in Comte. For Heraclitus the soul approaches most nearly to perfection when it is most akin to the fiery vapour out of which it was originally created, and as this is most so in death, "while we live our souls are dead in us, but when we die our souls are restored to life." The doctrine of immortality comes prominently forward in his ethics, but whether this must not be reckoned with the figurative accommodation to the popular theology of Greece which pervades his ethical teaching, is very doubtful.

The school of disciples founded by Heraclitus flourished for long after his death, the chief exponent of his teaching being Cratylus. A good deal of the information in regard to his doctrines has been gathered from the later Greek philosophy, which was deeply influenced by it.

BIBLIOGRAPHY.—The only authentic extant work of Heraclitus is the *περὶ φύσεως*. The best edition (containing also the probably spurious *Ἐπιστολαί*) is that of I. Bywater, *Heracliti Ephesii reliquias* (Oxford, 1877); of the epistles alone by A. Westermann (Leipzig, 1857). See also in A. H. Ritter and L. Preller's *Historia Philosophiæ Græcæ* (8th ed. by E. Wellmann, 1898); F. W. A. Mullach, *Fragn. philo. Græc.* (Paris, 1869); A. Fairbanks, *The First Philosophers of Greece* (1898); H. Diels, *Heraclit von Ephesus* (2nd ed., 1909), Greek and German. English translation of Bywater's edition with introduction by G. T. W. Patrick (Baltimore, 1889). For criticism see, in addition to the histories of philosophy, F. Lassalle, *Die Philosophie Heraclitios' das Dunkeln* (Berlin, 1858; 2nd ed., 1892), which, however, is too strongly dominated by modern Hegelianism; Paul Schuster, *Heraclit von Ephesus* (Leipzig, 1873); J. Bernays, *Die heraklitischen Briefe* (Berlin, 1869); T. Gomperz, *Zu Heraclitus Lehre und den Überresten seines Werkes* (Vienna, 1887), and in his *Greek Thinkers* (English translation, L. Magnus, vol. i, 1901); J. Burnet, *Early Greek Philosophy* (1892); A. Patin, *Heracliti Einheitslehre* (Leipzig, 1886); E. Pfeleiderer, *Die Philosophie des Heraclitus von Ephesus im Lichte der Mysterienidee* (Berlin, 1886); G. T. Schäfer, *Die Philosophie des Heraclitus von Ephesus und die moderne Heraklitforschung* (Leipzig, 1902); Wolfgang Schultz, *Studien zur antiken Kultur*, I; *Pythagoras und Heraclit* (Leipzig, 1903); O. Spengler, *Heraclit. Eine Studie über den energetischen Grundgedanken seiner Philosophie* (Halle, 1904); A. Brieger, "Die Grundzüge der heraklitischen Physik" in *Hermes*, xxxix. (1904) 183-223, and "Heraclit der Dunkle" in *Neue Jahrb. f. das klass. Altertum* (1904), p. 687. For his place in the development of early philosophy see also articles IONIAN SCHOOL OF PHILOSOPHY and LOGOS. Ancient authorities: Diog. Laërt. ix.; Sext. Empiric, *Adv. mathem.* vii. 126, 127, 133; Plato, *Cratylus*, 402 A and *Theaetetus*, 152 E; Plutarch, *Isis and Osiris*, 45, 48; Arist. *Nic. Eth.* vii. 3, 4; Clement of Alexandria, *Stromata*, v. 599, 603 (ed. Paris). (J. M. M.)

HERACLIUS (*Ἡρακλῆος*) (c. 575-642), East Roman emperor, was born in Cappadocia. His father held high military command under the emperor Maurice, and as governor of Africa maintained his independence against the usurper Phocas (q.v.). When invited to head a rebellion against the latter, he sent his son with a fleet which reached Constantinople unopposed, and precipitated the dethronement of Phocas. Proclaimed emperor, Heraclius set himself to reorganize the utterly disordered administration. At first he found himself helpless before the Persian armies (see PERSIA: *Ancient History*; and CHOSROËS II.) of Chosroës II., which conquered Syria and Egypt and since 616 had encamped opposite Constantinople; in 618 he even proposed in despair to abandon his capital and seek a refuge in Carthage, but at the entreaty of the patriarch he took courage. By securing a loan from the Church and suspending the corn-distribution at Constantinople, he raised sufficient funds for war, and after making a treaty with the Avars, who had nearly surprised the capital during an incursion in 619, he was at last able to take the field against Persia. During his first expedition (622) he failed to secure a footing in Armenia, whence he had hoped to take the Persians in flank, but by his unwearied energy he restored the discipline and efficiency of the army. In his second campaign (624-26) he penetrated into Armenia and Albania, and beat the enemy in the open field. After a short stay at Constantinople,

which his son Constantine had successfully defended against renewed incursions by the Avars, Heraclius resumed his attacks upon the Persians (627). Though deserted by the Khazars, with whom he had made an alliance upon entering into Pontus, he gained a decisive advantage by a brilliant march across the Armenian highlands into the Tigris plain, and a hard-fought victory over Chosroës' general, Shahrbaraz, in which Heraclius distinguished himself by his personal bravery. A subsequent revolution at the Persian court led to the dethronement of Chosroës in favour of his son Kavadh II. (q.v.); the new king promptly made peace with the emperor, whose troops were already advancing upon the Persian capital Ctesiphon (628). Having thus secured his eastern frontier, Heraclius returned to Constantinople with ample spoils, including the true cross, which in 629 he brought back in person to Jerusalem. On the northern frontier of the empire he kept the Avars in check by inducing the Serbs to migrate from the Carpathians to the Balkan lands so as to divert the attention of the Avars.

The triumphs which Heraclius had won through his own energy and skill did not bring him lasting popularity. In his civil administration he followed out his own ideas without deferring to the nobles or the Church, and the opposition which he encountered from these quarters went far to paralyse his attempts at reform. Worn out by continuous fighting and weakened by dropsy, Heraclius failed to show sufficient energy against the new peril that menaced his eastern provinces towards the end of his reign. In 639 the Saracens made their first incursion into Syria (see CALIPHATE, section A, § 1); in 636 they won a notable victory on the Yermuk (Hieromax), and in the following years conquered all Syria, Palestine and Egypt. Heraclius made no attempt to retrieve the misfortunes of his generals, but evacuated his possessions in sullen despair. The remaining years of his life he devoted to theological speculation and ecclesiastical reforms. His religious enthusiasm led him to oppress his Jewish subjects; on the other hand he sought to reconcile the Christian sects, and to this effect propounded in his *Echthesis* a conciliatory doctrine of monothelism. Heraclius died of his disease in 642. He had been twice married; his second union, with his niece Martina, was frequently made a matter of reproach to him. In spite of his partial failures, Heraclius must be regarded as one of the greatest of Byzantine emperors, and his early campaigns were the means of saving the realm from almost certain destruction.

AUTHORITIES.—C. Finlay, *History of Greece* (Oxford, 1877) i. 311-358; J. B. Bury, *The Later Roman Empire* (London, 1889), ii. 207-273; T. E. Evangelides, *Ἡρακλῆος ὁ αὐτοκράτωρ τοῦ Βυζαντίου* (Odessa, 1903); A. Pernice, *L'Imperatore Eraclio* (Florence, 1905). On the Persian campaigns: the epic of George Pisides (ed. 1836, Bonn); F. Macler, *Histoire d'Héraclius par l'évêque Sebdo* (Paris, 1904); E. Gerland in *Byzantinische Zeitschrift*, iii. (1894) 330-337; N. H. Baynes in the *English Historical Review* (1904), pp. 694-702. (M. O. B. C.)

HERALD (O. Fr. *heraut, herant*; the origin is uncertain, but O.H.G. *heren*, to call, or *herwald*, leader of an army, have been proposed; the Gr. equivalent is *ἠρπυξ*; Lat. *praeco, caduceator, fetialis*), in Greek and Roman antiquities, the term for the officials described below; in modern usage, while the word "herald" is often used generally in a sense analogous to that of the ancients, it is more specially restricted to that dealt with in the article HERALDRY.

The Greek heralds, who claimed descent from Hermes, the messenger of the gods, through his son Kerxys, were public functionaries of high importance in early times. Like Hermes, they carried a staff of olive or laurel wood surrounded by two snakes (or with wool as messengers of peace); their persons were inviolable; and they formed a kind of priesthood or corporation. In the Homeric age, they summoned the assemblies of the people, at which they preserved order and silence; proclaimed war; arranged the cessation of hostilities and the conclusion of peace; and assisted at public sacrifices and banquets. They also performed certain menial offices for the kings (mixing and pouring out the wine for the guests), by whom they were treated as confidential servants. In later times,

their position was a less honourable one; they were recruited from the poorer classes, and were mostly paid servants of the various officials. Pollux in his *Onomasticon* distinguishes four classes of heralds: (1) the sacred heralds at the Eleusinian mysteries;¹ (2) the heralds at the public games, who announced the names of the competitors and victors; (3) those who superintended the arrangements of festal processions; (4) those who proclaimed goods for sale in the market (for which purpose they mounted a stone), and gave notice of lost children and runaway slaves. To these should be added (5) the heralds of the *boulé* and *demos*, who summoned the members of the council and ecclesia, recited the solemn formula of prayer before the opening of the meeting, called upon the orators to speak, counted the votes and announced the results; (6) the heralds of the law courts, who gave notice of the time of trials and summoned the parties. The heralds received payment from the state and free meals together with the officials to whom they were attached. Their appointment was subject to some kind of examination, probably of the quality of their voice. Like the earlier heralds, they were also employed in negotiations connected with war and peace.

Among the Romans the *praecones* or "criers" exercised their profession both in private and official business. As private criers they were especially concerned with auctions; they advertised the time, place and conditions of sale, called out the various bids, and like the modern auctioneer varied the proceedings with jokes. They gave notice in the streets of things that had been lost, and took over various commissions, such as funeral arrangements. Although the calling was held in little estimation, some of these criers amassed great wealth. The state criers, who were mostly freedmen and well paid, formed the lowest class of *apparitores* (attendants on various magistrates). On the whole, their functions resembled those of the Greek heralds. They called the popular assemblies together, proclaimed silence and made known the result of the voting; in judicial cases, they summoned the plaintiff, defendant, advocates and witnesses; in criminal executions they gave out the reasons for the punishment and called on the executioner to perform his duty; they invited the people to the games and announced the names of the victors. Public criers were also employed at state auctions in the *municipia* and colonies, but, according to the *lex Julia municipalis* of Caesar, they were prohibited from holding office.

Amongst the Romans the settlement of matters relating to war and peace was entrusted to a special class of heralds called *Fetiales* (not *Feciales*), a word of uncertain etymology, possibly connected with *fator, fari*, and meaning "the speakers." They formed a priestly college of 20 (or 15) members, the institution of which was ascribed to one of the kings. They were chosen from the most distinguished families, held office for life, and filled up vacancies in their number by co-optation. Their duties were to demand redress for insult or injury to the state, to declare war unless satisfaction was obtained within a certain number of days and to conclude treaties of peace. A deputation of four (or two), one of whom was called *pater patratus*, wearing priestly garments, with sacred herbs plucked from the Capitoline hill borne in front, proceeded to the frontier of the enemy's territory and demanded the surrender of the guilty party. This demand was called *clarigatio* (perhaps from its being made in a loud, clear voice). If no satisfactory answer was given within 30 days, the deputation returned to Rome and made a report. If war was decided upon, the deputation again repaired to the frontier, pronounced a solemn formula, and hurled a charred and blood-stained javelin across the frontier, in the presence of three witnesses, which was tantamount to a declaration of war (Livy i. 24, 32). With

¹ These heralds are regarded by some as a branch of the Eumolpidae, by others as of Athenian origin. They enjoyed great prestige and formed a hieratic caste like the Eumolpidae, with whom they shared the most important liturgical functions. From them were selected the *ἀγροκόρυς* or torch-bearer, the *ἑσπεροκόρυς*, whose chief duty was to proclaim silence, and *ἰεὺς βωμῆς*, an official connected with the service at the altar (see L. R. Farnell, *Cults of the Greek States*, iii. 161; J. Töpffer, *Altische Genealogie* (1889); Dittenberger in *Hermes*, xx.: P. Foucart, "Les Grands Mystères d'Eleusis" in *Mém. de l'Institut National de France*, xxxvii. (1904).

the extension of the Roman empire, it became impossible to carry out this ceremonial, for which was substituted the hurling of a javelin over a column near the temple of Bellona in the direction of the enemy's territory. When the termination of a war was decided upon, the *fetiales* either made an arrangement for the suspension of hostilities for a definite term of years, after which the war recommenced automatically or they concluded a solemn treaty with the enemy. Conditions of peace or alliance proposed by the general on his own responsibility (*sponsio*) were not binding upon the people, and in case of rejection the general, with hands bound, was delivered by the *fetiales* to the enemy (Livy ix. 10). But if the terms were agreed to, a deputation carrying the sacred herbs and the flint stones, kept in the temple of Jupiter Feretrius for sacrificial purposes, met a deputation of *fetiales* from the other side. After the conditions of the treaty had been read, the sacrificial formula was pronounced and the victims slain by a blow from a stone (hence the expression *foedus ferire*). The treaty was then signed and handed over to the keeping of the *fetial* college. These ceremonies usually took place in Rome, but in 201 a deputation of *fetiales* went to Africa to ratify the conclusion of peace with Carthage. From that time little is heard of the *fetiales*, although they appear to have existed till the end of the 4th century A.D. The *caduceator* (from *caduceus*, the latinized form of *κρηκεῖον*) was the name of a person who was sent to treat for peace. His person was considered sacred; and like the *fetiales* he carried the sacred herbs, instead of the *caduceus*, which was not in use amongst the Romans.

For the Greek heralds, see Ch. Ostermann, *De praeconeibus Graecorum* (1845); for the Roman *praecones*, Mommsen, *Römisches Staatsrecht*, i. 363 (3rd ed., 1887); also article *PRÆCONES* in Pauly's *Realencyclopädie* (1852 edition); for the *Fetiales*, monographs by F. C. Conradi (1734, containing all the necessary material), and G. Fusinato (1884, from *Atti della R. Accad. dei Lincei*, series iii. vol. 13); also Marquardt, *Römische Staatsverwaltung*, iii. 415 (3rd ed., 1885), and A. Weiss in Daremberg and Saglio's *Dictionnaire des antiquités*. (J. H. F.)

HERALDRY. Although the word Heraldry properly belongs to all the business of the herald (*q.v.*), it has long attached itself to that which in earlier times was known as armory, the science of armorial bearings.

History of Armorial Bearings.—In all ages and in all quarters of the world distinguishing symbols have been adopted by tribes or nations, by families or by chieftains. Greek and Roman poets describe the devices borne on the shields of heroes, and many such painted shields are pictured on antique vases. Rabbinical writers have supported the fancy that the standards of the tribes set up in their camps bore figures devised from the prophecy of Jacob, the ravening wolf for Benjamin, the lion's whelp for Judah and the ship of Zebulon. In the East we have such ancient symbols as the five-clawed dragon of the Chinese empire and the chrysanthemum of the emperor of Japan. In Japan, indeed, the systematized badges borne by the noble clans may be regarded as akin to the heraldry of the West, and the circle with the three asarum leaves of the Tokugawa shoguns has been made as familiar to us by Japanese lacquer and porcelain as the red pellets of the Medici by old Italian fabrics. Before the landing of the Spaniards in Mexico the Aztec chiefs carried shields and banners, some of whose devices showed after the fashion of a phonetic writing the names of their bearers; and the eagle on the new banner of Mexico may be traced to the eagle that was once carved over the palace of Montezuma. That mysterious business of totemism, which students of folk-lore have discovered among most primitive peoples, must be regarded as another of the forerunners of true heraldry, the totem of a tribe supplying a badge which was sometimes displayed on the body of the tribesman in paint, scars or tattooing. Totemism so far touches our heraldry that some would trace to its symbols the white horse of Westphalia, the bull's head of the Mecklenburgers and many other ancient armories.

When true heraldry begins in Western Europe nothing is more remarkable than the suddenness of its development, once the idea of hereditary armorial symbols was taken by the nobles and

knights. Its earliest examples are probably still to be discovered by research, but certain notes may be made which narrow the dates between which we must seek its origin. The older writers on heraldry, lacking exact archaeology, were wont to carry back the beginnings to the dark ages, even if they lacked the assurance of those who distributed blazons among the angelic host before the Creation. Even in our own times old misconceptions give ground slowly. Georg Ruxner's *Thurnier Buch* of 1522 is still cited for its evidence of the tournament laws of Henry the Fowler, by which those who would contend in tournaments were forced to show four generations of arms-bearing ancestors. Yet modern criticism has shattered the elaborated fiction of Ruxner. In England many legends survive of arms borne by the Conqueror and his companions. But nothing is more certain than that neither armorial banners nor shields of arms were borne on either side at Hastings. The famous record of the Bayeux tapestry shows shields which in some cases suggest rudely devised armorial bearings, but in no case can a shield be identified as one which is recognized in the generations after the Conquest. So far is the idea of personal arms from the artist, that the same warrior, seen in different parts of the tapestry's history, has his shield with differing devices. A generation later, Anna Comnena, the daughter of the Byzantine emperor, describing the shields of the French knights who came to Constantinople, tells us that their polished faces were plain.

Of all men, kings and princes might be the first to be found bearing arms. Yet the first English sovereign who appears on his great seal with arms on his shield is Richard I. His seal of 1189 shows his shield charged with a lion ramping towards the sinister side. Since one half only is seen of the rounded face of the shield, English antiquaries have perhaps too hastily suggested that the whole bearing was two lions face to face. But the mounted figure of Philip of Alsace, count of Flanders, on his seal of 1164 bears a like shield charged with a like lion, and in this case another shield on the counterseal makes it clear that this is the single lion of Flanders. Therefore we may take it that, in 1189, King Richard bore arms of a lion rampant, while, nine years later, another seal shows him with a shield of the familiar bearings which have been borne as the arms of England by each one of his successors.

That seal of Philip of Alsace is the earliest known example of the arms of the great counts of Flanders. The ancient arms of the kings of France, the blue shield powdered with golden fleurs-de-lys, appear even later. Louis le Jeune, on the crowning of his son Philip Augustus, ordered that the young prince should be clad in a blue dalmatic and blue shoes, sewn with golden fleurs-de-lys, a flower whose name, as "Fleur de Loys," played upon that of his own, and possibly upon his epithet name of Florus. A seal of the same king has the device of a single lily. But the first French royal seal with the shield of the lilies is that of Louis VIII. (1223-1226). The eagle of the emperors may well be as ancient a bearing as any in Europe, seeing that Charlemagne is said, as the successor of the Caesars, to have used the eagle as his badge. The emperor Henry III. (1039-1056) has the sceptre on his seal surmounted by an eagle; in the 12th century the eagle was embroidered upon the imperial gloves. At Mülsen in 1080 the emperor's banner is said by William of Tyre to have borne the eagle, and with the beginning of regular heraldry this imperial badge would soon be displayed on a shield. The double-headed eagle is not seen on an imperial seal until after 1414, when the bird with one neck becomes the recognized arms of the king of the Romans.

There are, however, earlier examples of shields of arms than any of these. A document of the first importance is the description by John of Marmouster of the marriage of Geoffrey of Anjou with Maude the empress, daughter of Henry I., when the king is said to have hung round the neck of his son-in-law a shield with golden "lioncels." Afterwards the monk speaks of Geoffrey in fight, "pictos leones preferens in clypeo." Two notes may be added to this account. The first is that the enamelled plate now in the museum at Le Mans, which is said to have been placed over the tomb of Geoffrey after his death in 1151, shows him bearing a

long shield of azure with six golden lioncels, thus confirming the monk's story. The second is the well-known fact that Geoffrey's bastard grandson, William with the Long Sword, undoubtedly bore these same arms of the six lions of gold in a blue field, even as they are still to be seen upon his tomb at Salisbury. Some ten years before Richard I. seals with the three leopards, his brother John, count of Mortain, is found using a seal upon which he bears two leopards, arms which later tradition assigns to the ancient dukes of Normandy and to their descendants the kings of England before Henry II., who is said to have added the third leopard in right of his wife, a legend of no value. Mr Round has pointed out that Gilbert of Clare, earl of Hertford, who died in 1152, bears on his seal to a document sealed after 1138 and not later than 1146, the three cheverons afterwards so well known in England as the bearings of his successors. An old drawing of the seal of his uncle Gilbert, earl of Pembroke (*Lansdowne MS.* 203), shows a cheveronny shield used between 1138 and 1148. At some date between 1144 and 1150, Waleran, count of Meulan, shows on his seal a pennon and saddle-cloth with a checkered pattern; the house of Warrene, sprung from his mother's son, bore shields checky of gold and azure. If we may trust the inventory of Norman seals made by M. Demay, a careful antiquary, there is among the archives of the Manche a grant by Eudes, seigneur du Pont, sealed with a seal and counterseal of arms, to which M. Demay gives a date as early as 1128. The writer has not examined this seal, the earliest armorial evidence of which he has any knowledge, but it may be remarked that the arms are described as varying on the seal and counterseal, a significant touch of primitive armory. Another type of seal common in this 12th century shows the personal device which had not yet developed into an armorial charge. A good example is that of Enguerrand de Candavène, count of St Pol, where, although the shield of the horseman is uncharged, sheaves of oats, playing on his name, are strewn at the foot of the seal. Five of these sheaves were the arms of Candavène when the house came to display arms. In the same fashion three different members of the family of Armenteres in England show one, two or three swords upon their seals, but here the writer has no evidence of a coat of arms derived from these devices.

From the beginning of the 13th century arms upon shields increase in number. Soon the most of the great houses of the west display them with pride. Leaders in the field, whether of a royal army or of a dozen spears, saw the military advantage of a custom which made shield and banner things that might be recognized in the press. Although it is probable that armorial bearings have their first place upon the shield, the charges of the shield are found displayed on the knight's long surcoat, his "coat of arms," on his banner or pennon; on the trappers of his horse and even upon the peaks of his saddle. An attempt has been made to connect the rise of armory with the adoption of the barrel-shaped close helm; but even when wearing the earlier Norman helmet with its long nasal the knight's face was not to be recognized. The Conqueror, as we know, had to bare his head before he could persuade his men at Hastings that he still lived. Armory satisfied a need which had long been felt. When fully armed, one galloping knight was like another; but friend and foe soon learned that the gold and blue checkers meant that Warrene was in the field and that the gold and red vair was for Ferrers. Earl Simon at Evesham sent up his barber to a spying place and, as the barber named in turn the banners which had come up against him, he knew that his last fight was at hand. In spite of these things the growth of the custom of sealing deeds and charters had at least as much influence in the development of armory as any military need. By this way, women and clerks, citizens and men of peace, corporations and colleges, came to share with the fighting man in the use of armorial bearings. Arms in stone, wood and brass decorated the tombs of the dead and the houses of the living; they were brodered in bed-curtains, coverlets and copes, painted on the sails of ships and enamelled upon all manner of goldsmiths' and silversmiths' work. And, even by warriors, the full splendour of armory was at all times displayed more fully

HERALDRY

PLATE I.



PART OF A ROLL OF ARMS PAINTED IN ENGLAND AT THE BEGINNING OF THE 14TH CENTURY. THE NAMES HAVE BEEN ADDED BY A SOMEWHAT LATER HAND, AND ARE IN MANY CASES MISTAKEN AND MIS-SPelled.

Drawn by William GIBB for the ENCYCLOPÆDIA BRITANNICA, ELEVENTH EDITION. Niagara Litho. Co., Buffalo, N. Y.



HERALDRY



SIXTEEN SHIELDS FROM A ROLL OF ARMS OF ENGLISH KNIGHTS AND BARONS MADE BY AN ENGLISH PAINTER EARLY IN THE REIGN OF EDWARD III.

Drawn by William Gibb

Niagara Litho. Co., Buffalo, N. Y.



HERALDRY

PLATE III.



SHIELDS OF ARMS OF "LE ROY DARRABE," "LE ROY DE TARSSE," AND OTHER SOVEREIGNS, MOSTLY MYTHICAL. TAKEN FROM A ROLL OF ARMS MADE BY AN ENGLISH PAINTER IN THE TIME OF HENRY VI.

Niagara Litho Co., Buffalo, N. Y.

Drawn by William Gibb.

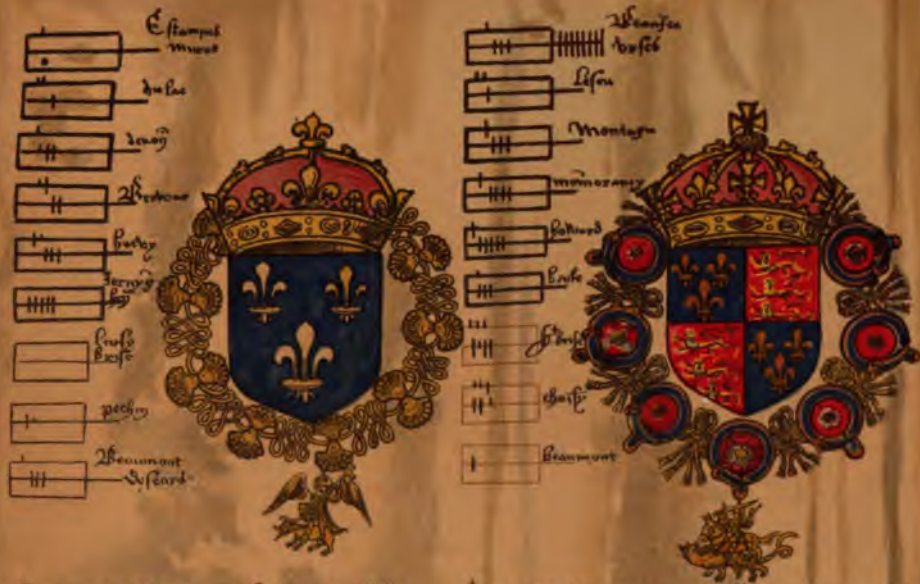

le Duc de Bourgoigne



le Rochepot

le Duc de Suffolte



Messr. de Valby & Greynton

le Comte de Brie



Brie

le marquis de Soffelt



Messr. Richard & Janyngton



THE BEGINNING OF A ROLL OF THE ARMS OF THOSE JOUSTING IN A TOURNAMENT HELD ON THE FIELD OF THE CLOTH OF GOLD. BESIDES THE ARMS OF THE KINGS OF FRANCE AND ENGLAND ARE TWO COLUMNS OF "CHEQUES," MARKED WITH THE NAMES AND SCORING POINTS OF THE JOUSTERS.

Drawn by William Gibb,

Niagara Litho. Co., Buffalo, N. Y.

in the fantastic magnificence of the tournament than in the rougher business of war.

There can be little doubt that ancient armorial bearings were chosen at will by the man who bore them, many reasons guiding his choice. Crosses in plenty were taken. Old writers have asserted that these crosses commemorate the badge of the crusaders, yet the fact that the cross was the symbol of the faith was reason enough. No symbolism can be found in such charges as bends and fesses; they are on the shield because a broad band, aslant or athwart, is a charge easily recognized. Medieval wisdom gave every noble and magnanimous quality to the lion, and therefore this beast is chosen by hundreds of knights as their bearing. We have already seen how the arms of a Candavène play upon his name. Such an example was imitated on all sides. Salle of Bedfordshire has two salamanders *sa/tirewise*; Belet has his namesake the weasel. In ancient shields almost all beasts and birds other than the lion and the eagle play upon the bearer's name. No object is so humble that it is unwelcome to the knight seeking a pun for his shield. Trivet has a three-legged trivet; Trumpington two trumps; and Montbocher three pots. The legends which assert that certain arms were "won in the Holy Land" or granted by ancient kings for heroic deeds in the field are for the most part worthless fancies.

Tenants or neighbours of the great feudal lords were wont to make their arms by differencing the lord's shield or by bringing some charge of it into their own bearings. Thus a group of Kentish shields borrow lions from that of Leyborne, which is azure with six lions of silver. Shirland of Minster bore the same arms differenced with an ermine quarter. Detling had the silver lions in a sable field. Rokesle's lions are azure in a golden field with a fesse of gules between them; while Wateringbury has six sable lions in a field of silver, and Tilmansstone six ermine lions in a field of azure. The Vipont ring or anelet is in several shields of Westmorland knights, and the cheverons of Clare, the cinquefoil badge of Beaumont and the sheaves of Chester can be traced in the coats of many of the followers of those houses. Sometimes the lord himself set forth such arms in a formal grant, as when the baron of Greystock grants to Adam of Blencowe a shield in which his own three chaplets are charges. The Whitgreave family of Staffordshire still show a shield granted to their ancestor in 1442 by the earl of Stafford, in which the Stafford red chevron on a golden field is four times repeated.

Differences.—By the custom of the middle ages the "whole coat," which is the undifferenced arms, belonged to one man only and was inherited whole only by his heirs. Younger branches differenced in many ways, following no rule. In modern armory the label is reckoned a difference proper only to an eldest son. But in older times, although the label was very commonly used by the son and heir apparent, he often chose another distinction during his father's lifetime, while the label is sometimes found upon the shields of younger sons. Changing the colours or varying the number of charges, drawing a bend or baston over the shield or adding a border are common differences of cadet lines. Beauchamp, earl of Warwick, bore "Gules with a fesse and six crosslets gold." His cousins are seen changing the crosslets for martlets or for billets. Bastards difference their father's arms, as a rule, in no more striking manner than the legitimate cadets. Towards the end of the 14th century we have the beginning of the custom whereby certain bastards of princely houses differenced the paternal arms by charging them upon a bend, a fesse or a chief, a chevron or a quarter. Before his legitimation the eldest son of John of Gaunt by Katharine Swinford is said to have borne a shield party silver and azure with the arms of Lancaster on a bend. After his legitimation in 1307 he changed his bearings to the royal arms of France and England within a border gobony of silver and azure. Warren of Poynton, descended from the last earl Warren and his concubine, Maude of Neirford, bore the checkered shield of Warrenne with a quarter charged with the ermine lion of Neirford. By the end of the middle ages the baston under continental influence tended to become a bastard's

difference in England and the jingle of the two words may have helped to support the custom. About the same time the border gobony began to acquire a like character. The "bar sinister" of the novelists is probably the baston sinister, with the ends coupé, which has since the time of Charles II. been familiar on the arms of certain descendants of the royal house. But it has rarely been seen in England over other shields; and, although the border gobony surrounds the arms granted to a peer of Victorian creation, the modern heralds have fallen into the habit of assigning, in nineteen cases out of twenty, a wavy border as the standard difference for illegitimacy.

Although no general register of arms was maintained it is remarkable that there was little conflict between persons who had chanced to assume the same arms. The famous suit in which Scrope, Grosvenor and Carminow all claimed the blue shield with the golden bend is well known, and there are a few cases in the 14th century of like disputes which were never carried to the courts. But the men of the middle ages would seem to have had marvellous memories for blazonry; and we know that rolls of arms for reference, some of them the records of tournaments, existed in great numbers. A few examples of these remain to us, with painted shields or descriptions in French blazon, some of them containing many hundreds of names and arms.

To women were assigned, as a rule, the undifferenced arms of their fathers. In the early days of armory married women—well-born spinsters of full age were all but unknown outside the walls of religious houses—have seals on which appear the shield of the husband or the father or both shields side by side. But we have some instances of the shield in which two coats of arms are parted or, to use the modern phrase, "impaled." Early in the reign of King John, Robert de Pinkney seals with a parted shield. On the right or dexter side—the right hand of a shield is at the right hand of the person covered



Shield from seal of Robert de Pinkney, an early example of parted arms.

by it—are two fusils of an indented fesse: on the left or sinister side are three waves. The arms of Pinkney being an indented fesse, we may see in this shield the parted arms of husband and wife—the latter being probably a Basset. In many of the earliest examples, as in this, the dexter half of the husband's shield was united with the sinister half of that of the wife, both coats being, as modern antiquaries have it, dimidiated. This "dimidiation," however, had its inconvenience. With some coats it was impossible. If the wife bore arms with a quarter for the only charge, her half of the shield would be blank. Therefore the practice was early abandoned by the majority of bearers of parted shields although there is a survival of it in the fact that borders and tressures continue to be "dimidiated" in order that the charges within them shall not be cramped. Parted shields came into common use from the reign of Edward II., and the rule is established that the husband's arms should take the dexter side. There are, however, several instances of the contrary practice. On the seal of Maude, wife of John Boutetort of Halstead, the engrailed saltire of the Boutetorts takes the sinister place. A twice-married woman would sometimes show a shield charged with her paternal arms between those of both of her husbands, as did Beatrice Stafford in 1404, while in 1412 Elizabeth, Lady of Clinton, seals with a shield pale with five coats—her arms



Shield of Joan atte Pole, widow of Robert of Hemenhale, from her seal (1403), showing parted arms.

engrailed saltire of the Boutetorts takes the sinister place. A twice-married woman would sometimes show a shield charged with her paternal arms between those of both of her husbands, as did Beatrice Stafford in 1404, while in 1412 Elizabeth, Lady of Clinton, seals with a shield pale with five coats—her arms

of la Planchette between those of four husbands. In most cases the parted shield is found on the wife's seal alone. Even in our own time it is recognized that the wife's arms should not appear upon the husband's official seal, upon his banner or surcoat or upon his shield when it is surrounded by the collar of an order. Parted arms, it may be noted, do not always represent a husband and wife. Richard II. parted with his quartered

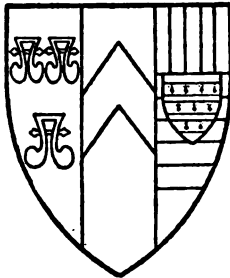

Shield of Beatrice Stafford from her seal (1404), showing her arms of Stafford between those of her husbands—Thomas, Lord Roos, and Sir Richard Burley.

arms of France and England those ascribed to Edward the Confessor, and parting is often used on the continent where quartering would serve in England. In 1497 the seal of Giles Daubeney and Reynold Bray, fellow justices in eyre, shows their arms parted in one shield. English bishops, by a custom begun late in the 14th century, part the see's arms with their own. By modern English custom a husband and wife, where the wife is not an heir, use the parted coat on a shield, a widow bearing the same upon the lozenge on which, when a spinster, she displayed her father's coat alone. When the wife is an heir, her arms are now borne in a little scocheon above those of her husband. If the husband's arms be in an unquartered shield the central charge is often hidden away by this scocheon.

The practice of marshalling arms by quartering spread in England by reason of the example given by Eleanor, wife of Edward I., who displayed the castle of Castille quartered with the lion of Leon. Isabel of France, wife of Edward II., seals with a shield in whose four quarters are the arms of England, France, Navarre and Champagne. Early in the 14th century Simon de Montagu, an ancestor of the earls of Salisbury, quartered with his own arms a coat of azure with a golden griffon. In 1340 we have Laurence Hastings, earl of Pembroke, quartering with the Hastings arms the arms of Valence, as heir of his great-uncle Aymer, earl of Pembroke. In the preceding year, the king had already asserted his claim to another kingdom by quartering France with England, and after this quartered shields became common in the great houses whose sons were carefully matched with heirs female. When the wife was an heir the husband would quarter her arms with his own, displaying, as a rule,



Shield of John Talbot, first earl of Shrewsbury (d. 1453), showing four coats quartered.

the more important coat in the first quarter. Marshalling becomes more elaborate with shields showing both quarterings and partings, as in the seal (1368) of Sibil Arundel, where Arundel (Fitzalan) is quartered with Warenne and parted with the arms of Montagu. In all, save one, of these examples the quartering is in its simplest form, with one coat repeated in the first and fourth quarters of the shield and another in the second and third. But to a charter of 1434 Sir Henry Bromfiere sets a seal upon which Bromfiere quarters

arms of France and England those ascribed to Edward the Confessor, and parting is often used on the continent where quartering would serve in England. In 1497 the seal of Giles Daubeney and Reynold Bray, fellow justices in eyre, shows their arms parted in one shield. English bishops, by a custom begun late in the 14th century, part the see's arms with their own. By modern English custom a husband and wife, where the wife is not an heir, use the parted coat on a shield, a widow bearing the same upon the lozenge on which, when a spinster, she displayed her father's coat alone. When the wife is an heir, her arms are now borne in a little scocheon above those of her husband. If the husband's arms be in an unquartered shield the central charge is often hidden away by this scocheon.

The practice of marshalling arms by quartering spread in England by reason of the example given by Eleanor, wife of Edward I., who displayed the castle of Castille quartered with the lion of Leon. Isabel of France, wife of Edward II., seals with a shield in whose four quarters are the arms of England, France, Navarre and Champagne. Early in the 14th century Simon de Montagu, an ancestor of the earls of Salisbury, quartered with his own arms a coat of azure with a golden griffon. In 1340 we have Laurence Hastings, earl of Pembroke, quartering with the Hastings arms the arms of Valence, as heir of his great-uncle Aymer, earl of Pembroke. In the preceding year, the king had already asserted his claim to another kingdom by quartering France with England, and after this quartered shields became common in the great houses whose sons were carefully matched with heirs female. When the wife was an heir the husband would quarter her arms with his own, displaying, as a rule,

the more important coat in the first quarter. Marshalling becomes more elaborate with shields showing both quarterings and partings, as in the seal (1368) of Sibil Arundel, where Arundel (Fitzalan) is quartered with Warenne and parted with the arms of Montagu. In all, save one, of these examples the quartering is in its simplest form, with one coat repeated in the first and fourth quarters of the shield and another in the second and third. But to a charter of 1434 Sir Henry Bromfiere sets a seal upon which Bromfiere quarters

Yesci in the second quarter, Aton in the third and St John in the fourth, after the fashion of the much earlier seal of Edward II.'s queen. Another development is that of what armorists style the "grand quarter," a quarter which is itself quartered, as in the shield of Reynold Grey of Ruthyn, which bears Grey in the first and fourth quarters and Hastings quartered with Valence in the third and fourth. Humphrey Bouchier, Lord Cromwell, in 1469, bears one grand

quarter quartered with another, the first having Bouchier and Lovaine, the second Tatershall and Cromwell.

The last detail to be noted in medieval marshalling is the introduction into the shield of another surmounting shield called by old armorists the "inerscocheon" and by modern blazoners the "inescutcheon." John the Fearless, count of Flanders, marshalled his arms in 1409 as a quartered shield of the new and old coats of Burgundy. Above these coats a little scocheon, borne over the crossing of the quartering lines, had the black lion of Flanders, the arms of his mother. Richard Beauchamp, the adventurous earl of Warwick, who had seen most European courts during his wanderings, may have had this shield in mind when, over his arms of Beauchamp quartering Newburgh, he set a scocheon of Clare quartering Despenser, the arms of his wife Isabel Despenser, co-heir of the earls of Gloucester. The seal of his son-in-law, the King-Maker, shows four quarters—Beauchamp quartering Clare, Montagu quartering Monthermer, Nevill alone, and Newburgh quartering Despenser. An interesting use of the scocheon *en surtout* is that made by

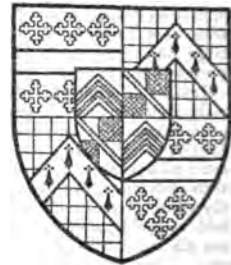

Shield of Richard Beauchamp, earl of Warwick, from his garter stall-plate (after 1423). The arms are Beauchamp quartering Newburgh, with a scocheon of Clare quartering Despenser.

Richard Wydville, Lord Rivers, whose garter stall-plate has a grand quarter of Wydville and Prouz quartering Beauchamp of Hache, the whole surmounted by a scocheon with the arms of Rieviers or Rivers, the house from which he took the title of his barony. On the continent the common use of the scocheon is to bear the paternal arms of a sovereign or noble, surmounting the quarterings of his kingdoms, principalities, fiefs or seigniories. Our own prince of Wales bears the arms of Saxony above those of the United Kingdom differentiated with his silver label. Marshalling takes its most elaborate form, the most removed from the graceful simplicity of the

middle ages, in such shields as the "Great Arms" of the Austrian empire, wherein are nine grand quarters each marshalling in various fashions from three to eleven coats, six of the grand-quarters bearing scocheons *en surtout*, each scocheon ensigned with a different crown.

Crests.—The most important accessory of the arms is the crested helm. Like the arms it has its pre-heraldic history in the crests of the Greek helmets, the wings, the wild boar's and bull's heads of Viking headpieces. A little roundel of the arms of a Japanese house was often borne as a crest in the Japanese helmet, stepped in a socket above the middle of the brim. The 12th-century seal of Philip of Alsace, count of Flanders, shows a demi-lion painted or beaten on the side of the upper part of his helm, and on his seal of 1198 our own Richard Cœur de Lion's barrel-helm has a leopard upon the semicircular comb-ridge, the edge of which is set off with feathers arranged as two wings. Crests, however, came slowly into use in England, although before 1250 Roger de Quincy, earl of Winchester, is seen on his seal with a wyver upon his helm. Of the long roll of earls and barons sealing the famous letter to the pope in 1301 only five show true crests on their seals. Two of them are the earl of Lancaster and his brother, each with a wyver crest like that of Quincy. One, and the most remarkable, is John St John of Halnaker, whose crest is a leopard standing between two upright palm branches. Ralph de Monthermer has an eagle crest, while Walter de Moncy's helm is surmounted by a fox-like beast. In three of these instances the crest is borne, as was often the case, by the horse as well as the rider. Others of these seals to the barons' letter have the fan-shaped crest without any decoration upon it. But as the furniture of tournaments grew more magnificent the crest gave a new field for display, and many strange shapes appear in painted and gilded wood,

metal, leather or parchment above the helms of the joustiers. The Berkeleys, great patrons of abbeys, bore a mitre as their crest painted with their arms, like crests being sometimes seen on the continent where the wearer was *advocatus* of a bishopric or abbey. The whole or half figures or the heads and necks of beasts and birds were employed by other families. Saracens' heads topped many helms, that of the great Chandos among them. Astley bore for his crest a silver harpy standing in marsh-sedge, a golden chain fastened to a crown about her neck. Dymoke played pleasantly on his name with a long-eared moke's scalp. Stanley took the eagle's nest in which the eagle is lighting down with a swaddled babe in his claws. Burnell had a burdock bush, la Vache a cow's leg, and Lisle's strange fancy was to perch a huge millstone on edge above his head. Many early helms, as that of Sir John Loterel, painted in the Loterel psalter, repeat the arms on the sides of a fan-crest. Howard bore for a crest his arms painted on a pair of wings, while simple "bushes" or feathers are seen in great plenty. The crest of a cadet is often differenced like the arms, and thus a wyver or a leopard will have a label about its neck. The Montagu griffin on the helm of John, marquess of Montagu, holds in its beak the gimel ring with which he differenced his father's shield. His brother,



Ralph de Monthermer (1301), showing shield of arms, helm with crest and mantle, horse-crest and armorial trappera.

the King-Maker, following a custom commoner abroad than at home, shows two crested helms on his seal, one for Montagu and one for Beauchamp—none for his father's house of Nevill. It is often stated that a man, unless by some special grace or allowance, can have but one crest. This, however, is contrary to the spirit of medieval armory in which a man, inheriting the coat of arms of another house than his own, took with it all its belongings, crest, badge and the like. The heraldry books, with more reason, deny crests to women and to the clergy, but examples are not wanting of medieval seals in which even this rule is broken. It is perhaps unfair to cite the case of the bishops of Durham who ride in full harness on their palatinate seals; but Henry Despenser, bishop of Norwich, has a helm on which the winged griffin's head of his house springs from a mitre, while Alexander Nevill, archbishop of York, seals with shield, supporters and crested helm like those of any lay magnate. Richard Holt, a Northamptonshire clerk in holy orders, bears on his seal in the reign of Henry V. a shield of arms and a mantled helm with the crest of a collared greyhound's head. About the middle of the same century a seal cut for the wife of Thomas Chetwode, a Cheshire squire, has a shield of her husband's arms parted with her own and surmounted by a crowned helm with the crest of a demi-lion; and this is not the only example of such bearings by a woman.

Before passing from the crest let us note that in England the

junction of crest and helm was commonly covered, especially after the beginning of the 15th century, by a torse or "wreath" of silk, twisted with one, two or three colours. Coronets or crowns and "hats of estate" often take the place of the wreath as a base for the crest, and there are other curious variants. With the wreath may be considered the mantle, a hanging cloth which, in its earliest form, is seen as two strips of silk or sendal attached to the top of the helm below the crest and streaming like pennants as the rider bent his head and charged. Such strips are often displayed from the conical top of an uncrested helm, and some ancient examples have the air of the two ends of a stole or of the *insulas* of a bishop's mitre. The general opinion of antiquaries has been that the mantle originated among the crusaders as a protection for the steel helm from the rays of an Eastern sun; but the fact that mantles take in England their fuller form after our crusading days were over seems against this theory. When the fashion for slitting the edges of



Shield and crested helm with hat and clothing came in, the edges of the mantle were slitted like the edge Hengrave (1401).

of the sleeve or skirt, and, flourished out on either side of the helm, it became the delight of the painter of armories and the seal engraver. A worthless tale, repeated by popular manuals, makes the slitted edge represent the shearing work of the enemy's sword, a fancy which takes no account of the like developments in civil dress. Modern heraldry in England paints the mantle with the principal colour of the shield, lining it with the principal metal. This in cases where no old grant of arms is cited as evidence of another usage. The mantles of the king and of the prince of Wales are, however, of gold lined with ermine and those of other members of the royal house of gold lined with silver. In ancient examples there is great variety and freedom. Where the crest is the head of a griffin or bird the feathering of the neck will be carried on to cover the mantle. Other mantles will be powdered with badges or with charges from the shield, others checkered, barred or paled. More than thirty of the mantles enamelled on the stall-plates of the mediæval Garter-knights are of red with an ermine lining, tinctures which in most cases have no reference to the shields below them.

Supporters.—Shields of arms, especially upon seals, are sometimes figured as hung round the necks of eagles, lions, swans and griffons, as strapped between the horns of a hart or to the boughs of a tree. Badges may fill in the blank spaces at the sides between the shield and the inscription on the rim, but in the later 13th and early 14th centuries the commonest objects so serving are sprigs of plants, lions, leopards, or, still more frequently, lithe-necked wyvers. John of Segrave in 1301 flanks his shields with two of the sheaves of the older coat of Segrave: William Marshal of Hingham does the like with his two marshal's staves. Henry of Lancaster at the same time shows on his seal a shield and a helm crested with a wyver, with two like wyvers ranged on either side of the shield as "supporters." It is uncertain at what time in the 14th century these various fashions crystallize into the recognized use of beasts, birds, reptiles, men or inanimate objects, definitely chosen as "supporters" of the shield, and not to be taken as the ornaments suggested by the fancy of the seal engraver. That supporters originated in the decoration of the seal there can be little doubt. Some writers, the learned Menétrier among them, will have it that they were first the fantastically clad fellows who supported and displayed the knight's shield at the opening of the tournament. If the earliest supporters were wild men, angels or Saracens, this theory might be defended; but lions, boars and talbots, dogs and trees are guises into which a man would put himself with difficulty.

By the middle of the 14th century we find what are clearly recognizable as supporters. These, as in a lesser degree the crest, are often personal rather than hereditary, being changed generation by generation. The same person is found using more



Arms of William, Lord Hastings, from his seal (1477), showing shield, crowned and crested helm with mantle and supporters.

than one pair of them. The kings of France have had angels as supporters of the shield of the fleurs de lys since the 15th century, but the angels have only taken their place as the sole royal supporters since the time of Louis XIV. Sovereigns of England from Henry IV. to Elizabeth changed about between supporters of harts, leopards, antelopes, bulls, greyhounds, boars and dragons. James I. at his accession to the English throne brought the Scottish unicorn to face the English leopard rampant across his shield, and, ever since, the "lion and unicorn" have been the royal supporters.

An old herald wrote as his opinion that "there is little or nothing in precedent to direct the use of supporters." Modern custom gives them, as a rule, only to peers, to knights of the Garter, the Thistle and St Patrick, and to knights who are "Grand



Badge of John of Whethamstede, abbot of St Albans (d. 1465), from his tomb in the abbey church.

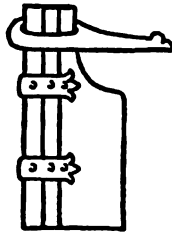

Rudder badge of Willoughby.

Crosses" or Grand Commanders of other orders. Royal warrants are sometimes issued for the granting of supporters to baronets, and, in rare cases, they have been assigned to untitled persons. But in spite of the jealousy with which official heraldry hedges about the display of these supporters once assumed so freely, a few old English families still assert their

right by hereditary prescription to use these ornaments as their forefathers were wont to use them.

Badges.—The badge may claim a greater antiquity and a wider use than armorial bearings. The "Plantagenet" broom is an early example in England, sprigs of it being figured on the seal of Richard I. In the 14th and 15th centuries every magnate had his badge, which he displayed on his horse-furniture, on the hangings of his bed, his wall and his chair of state, besides giving it as a "livery" to his servants and followers. Such were the knots of Stafford, Bouchier and Wake, the scabbard-crampet of La Warr, the sickle of Hungerford, the swan of Tocani, Bohun and Lancaster, the dun-bull of Nevill, the blue boar of Vere and the bear and ragged staff of Beauchamp, Nevill of Warwick and Dudley of Northumberland. So well known of all were these symbols that a political ballad of 1449 sings of the misfortunes of the great lords without naming one of them, all men understanding what signified the Falcon, the Water Bowge and the Cresset and the other badges of the doggerel. More famous still were the White Hart, the Red Rose, the White Rose, the Sun, the Falcon and Fetterlock, the Portucullis and the many other badges of the royal house. We still call those wars that blotted out the old baronage the Wars of the Roses, and the Prince of Wales's feathers are as well known to-day as the royal arms. The Flint and Steel of Burgundy make a collar for the order of the Golden Fleece.

Mottos.—The motto now accompanies every coat of arms in these islands. Few of these Latin aphorisms, these bald assertions of virtue, high courage, patriotism, piety and loyalty have any antiquity. Some few, however, like the "Espérance" of Percy, were the war-cries of remote ancestors. "I mak' sicker" of Kirkpatrick recalls proudly a bloody deed done on a wounded man, and the "Dieu Ayde," "Agincourt" and "D'Accomplir Agincourt" of the Irish "Montmorencys" and the English Wodehouses and Dalisons, glorious traditions based upon untrustworthy genealogy. The often-quoted punning mottoes may be illustrated by that of Cust, who says "Qui Cust-odit caveat," a modern example and a fair one. Ancient mottoes as distinct from the war or gathering cry of a house are often cryptic sentences whose meaning might be known to the user and perchance to his mistress. Such are the "Plus est en vous" of Louis de Bruges, the Flemish earl of Winchester, and the "So have I cause" and "Till then thus" of two Englishmen. The word motto is of modern use, our forefathers speaking rather of their "word" or of their "reason."

Coronets of Rank.—Among accessories of the shield may now be counted the coronets of peers, whose present form is post-medieval. When Edward III. made dukes of his sons, gold circlets were set upon their heads in token of their new dignity. In 1385 John de Vere, marquess of Dublin, was created in the same fashion. Edward VI. extended the honour of the gold circle to earls. Caps of honour were worn with these circles or coronets, and viscounts wore the cap by appointment of James I., Vincent the herald stating that "a verge of pearls on top of the circulet of gold" was added at the creation of Robert Cecil as Viscount Cranborne. At the coronation of Charles I. the viscounts walked in procession with their caps and coronets. A few days before the coronation of Charles II. the privilege



Badge of Dacre of Gilsland and Dacre of the North.



Ostrich feather badge of Beaufort, from a garter stall-plate of 1440. The silver feather has silver and azure.

of the cap of honour was given to the lowest rank of the peerage, and letters patent of January 1661 assign to them both cap and coronet. The caps of velvet turned up with miniver, which are now always worn with the peer's coronet, are therefore the ancient caps of honour, akin to that "cap of maintenance" worn by English sovereigns on their coronation days when walking to the Abbey Church, and borne before them on occasions of royal state.

The ancient circles were enriched according to the taste of the bearer, and, although used at creations as symbols of the rank conferred, were worn in the 14th and 15th centuries by men and women of rank without the use signifying a rank in the peerage. Edmund, earl of March, in his will of 1380, named his *sercis one roses, emeraudes et rubies d'alisaundre en les roses*, and bequeathed it to his daughter. Modern coronets are of silver-gilt, without jewels, set upon caps of crimson velvet turned up with ermine, with a gold tassel at the top. A duke's coronet has the circle decorated with eight gold "strawberry leaves"; that of a marquess has four gold strawberry leaves and four silver balls. The coronet of an earl has eight silver balls, raised upon points, with gold strawberry leaves between the points. A viscount's coronet has on the circle sixteen silver balls, and a baron's coronet six silver balls. On the continent the modern use of coronets is not ordered in the precise English fashion, men of gentle birth displaying coronets which afford but slight indication of the bearer's rank.

Lines.—Eleven varieties of lines, other than straight lines, which divide the shield, or edge our cheverons, pales, bars and the like, are pictured in the heraldry books and named as engrailed, embattled, indented, invected, wavy or undy, nebuly, dancetty, raguly, potenté, dovetailed and urdy.

As in the case of many other such lists of the later armorists these eleven varieties need some pruning and a new explanation.

The most commonly found is the line engrailed, which for the student of mediæval armory must be associated with the line indented. In its earliest form the line which a roll of arms will describe indifferently as indented or engrailed takes almost invariably the form to which the name indented is restricted by modern armorists.

The cross may serve as our first example. A cross, engrailed or indented, the words being used indifferently, is a cross so deeply notched at the edges that it seems made up of so many lozenge-shaped wedges or fusils. About the middle of the 14th century begins a tendency, resisted in practice by many conservative families, to draw the engrailing lines in the fashion to which modern armorists restrict the word "engrailed," making shallower indentures in the form of lines of half circles. Thus



Mohun.

the engrailed cross of the Mohuns takes either of the two forms which we illustrate. Bends follow the same fashion, early bends engrailed or indented being some four or more fusils joined bendwise by their blunt sides, bends of less than four fusils being very rare. Thus also the engrailed or indented saltires, pales or cheverons, the exact number of the fusils which go to the making of these being unconsidered. For the fesse there is another law. The fesse indented or engrailed is made up of fusils as is the engrailed bend. But although early rolls of arms sometimes neglect this detail in their blazon, the fusils making a fesse must always be of an ascertained number. Montagu, earl of Salisbury, bore a fesse engrailed or indented of three fusils only, very few shields imitating this. Mediæval armorists will describe his arms as a fesse indented of three indentures, as a fesse fusilly of three pieces, or as a fesse engrailed of three points or pieces, all of these blazons having the same value. The indented fesse on the red shield of the Dynhams has four such fusils of ermine. Four, however, is almost as rare a number as three, the normal form of a fesse indented being that of five fusils as borne by Percys, Pinkenys, Newmarches and many other ancient houses. Indeed, accuracy of blazon is served

if the number of fusils in a fesse be named in the cases of three and four. Fesses of six fusils are not to be found. Note that bars indented or engrailed are, for a reason which will be evident, never subject to this counting of fusils. Fauconberg, for example, bore "Silver with two bars engrailed, or indented, sable." Displayed on a shield of the flat-iron outline, the lower bar would show fewer fusils than the upper, while on a square banner each bar would have an equal number—usually five or six.

While bends, cheverons, crosses, saltires and pales often follow, especially in the 15th century, the tendency towards the



Montagu.

Dynham.

Percy.

Fauconberg.

rounded "engrailed," fesses keep, as a rule, their bold indentures—neither Percy nor Montagu being ever found with his bearings in aught but their ancient form. Borders take the newer fashion as leaving more room for the charges of the field. But indented chiefs do not change their fashion, although many saw-tooth sometimes take the place of the three or four strong points of early arms, and parti-coloured shields whose party line is indented never lose the bold zig-zag.

While bearing in mind that the two words have no distinctive force in ancient armory, the student and the herald of modern times may conveniently allow himself to blazon the sharp and saw-toothed line as "indented" and the scalloped line as "engrailed," especially when dealing with the debased armory in which the distinction is held to be a true one and one of the first importance. One error at least he must avoid, and that is the following of the heraldry-book compilers in their use of the word "dancetty." A "dancetty" line, we are told, is a line having fewer and deeper indentures than the line indented. But no dancetty line could make a bolder dash across the shield than do the lines which the old armorists recognized as "indented."

In old armory we have fesses dancy—commonly called "dances"—bends dancy, or cheverons dancy; there are no chiefs dancy nor borders dancy, nor are there shields blazoned as parted with a dancy line. Waved lines, battled lines and ragged lines need little explanation that a picture cannot give. The word invected or invected is sometimes applied by old-fashioned heraldic pedants to engrailed lines; later pedants have given it to a line found in modern grants of arms, an engrailed line reversed. Dove-tailed and urdy lines are mere modernisms. Of the very rare nebuly or clouded line we can only say that the ancient form, which imitated the conventional cloud-bank of the old painters, is now almost forgotten, while the bold "wavy" lines of early armory have the word "nebuly" misapplied to them.



West.

The Ordinary Charges.—The writers upon armory have given the name of Ordinaries to certain conventional figures commonly charged upon shields. Also they affect to divide these into Honourable Ordinaries and Sub-Ordinaries without explaining the reason for the superior honour of the Saltire or for the subordination of the Quarter. Disregarding such distinctions, we may begin with the description of the "Ordinaries" most commonly to be found.

From the first the Cross was a common bearing on English shields, "Silver a cross gules" being given early to St George, patron of knights and of England, for his arms; and under St George's red cross the English were wont to fight. Our armorial crosses took many shapes, but the "crosses innumerable" of the Book of St Albans and its successors may be left to the heraldic dictionary makers who have devised them. It is more

important to define those forms in use during the middle ages, and to name them accurately after the custom of those who bore them in war, a task which the heraldry books have never as yet attempted with success.

The cross in its simple form needs no definition, but it will be noted that it is sometimes borne "voided" and that in a very few cases it appears as a lesser charge with its ends cut off square, in which case it must be clearly blazoned as "a plain Cross."

Andrew Harcla, the march-warden, whom Edward II. made an earl and executed as a traitor, bore the arms of St George with a martlet sable in the quarter.

Crevequer of Kent bore "Gold a voided cross gules."

Newsom (14th century) bore "Azure a fesse silver with three plain crosses gules."

Next to the plain Cross may be taken the Cross paty, the *crois patee* or *pate* of old rolls of arms. It has several forms, according to the taste of the artist and the age. So, in the 13th and early 14th centuries, its limbs curve out broadly, while at a later date the limbs become more slender and of even breadth, the ends somewhat resembling *fleurs-de-lys*. Each of these forms has been seized by the heraldic writers as the type of a distinct cross for which a name must be found, none of them, as a rule, being recognized as a cross paty, a word which has its misapplica-

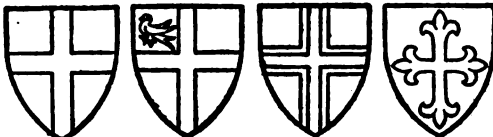

St George.

Harcla.

Crevequer.

Latimer.

tion elsewhere. Thus the books have "cross patonce" for the earlier form, while "cross clechée" and "cross fleurie" serve for the others. But the true identification of the various crosses is of the first importance to the antiquary, since without it descriptions of the arms on early seals or monuments must needs be valueless. Many instances of this need might be cited from the British Museum catalogue of seals, where, for example, the cross paty of Latimer is described twice as a "cross flory," six times as a "cross patonce," but not once by its own name, although there is no better known example of this bearing in England.

Latimer bore "Gules a cross paty gold."

The cross formly follows the lines of the cross paty save that its broadening ends are cut off squarely.

Chetwode bore "Quarterly silver and gules with four crosses formy countercoloured"—that is to say, the two crosses in the gules are of silver and the two in the silver of gules.

The cross flory or flowered cross, the "cross with the ends flowered"—*ad les bouies floretes* as some of the old rolls have it—is, like the cross paty, a mark for the misapprehension of writers on armory, who describe some shapes of the cross paty by its name. Playing upon discovered or fancied variants of the word, they bid us mark the distinctions between crosses "fleur-de-lise," "flory" and "fleurétée," although each author has his own version of the value which must be given these precious words. But the facts of the medieval practice are clear to those



Mill-rinds.

who take their armory from ancient examples and not from phrases plagiarized from the hundredth plagiarist. The flowered cross is one whose limbs end in *fleur-de-lys*, which spring sometimes from a knop or bud but more frequently issue from the square ends of a cross of the "formy" type.

Swynerton bore "Silver a flowered cross sable."

The mill-rind, which takes its name from the iron of a mill-stone—*for de molino*—must be set with the crosses. Some of the old rolls call it *crois recercele*, from which armorial writers have leaped to imagine a distinct type. Also they call the mill-rind itself a "cross moline" keeping the word

mill-rind for a charge having the same origin but of somewhat differing form. Since this charge became common in Tudor armory it is perhaps better that the original mill-rind should be called for distinction a mill-rind cross.

Willoughby bore "Gules a mill-rind cross silver."

The crosslet, cross bottonny or cross crosetted, is a cross whose limbs, of even breadth, end as trefoils or treble buds. It is rarely found in medieval examples in the shape—that of a cross with limbs ending in squarely cut plain crosses—which it took

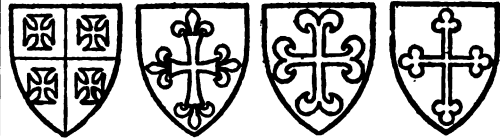

Chetwode.

Swynerton.

Willoughby.

Brerelegh.

during the 16th-century decadence. As the sole charge of a shield it is very rare; otherwise it is one of the commonest of charges.

Breerlegh bore "Silver a crosslet gules."

Within these modest limits we have brought the greater part of that monstrous host of crosses which cumber the dictionaries. A few rare varieties may be noticed.

Dukinfield bore "Silver a voided cross with sharpened ends."

Skirlaw, bishop of Durham (d. 1406), the son of a basket-weaver, bore "Silver a cross of three upright wattles sable, crossed and interwoven by three more."

Drury bore "Silver a chief vert with a St Anthony's cross gold between two golden molets, pierced gules."

Brytton bore "Gold a patriarch's cross set upon three degrees or steps of gules."

Hurleston of Cheshire bore "Silver a cross of four ermine tails sable."

Melton bore "Silver a Toulouse cross gules." By giving this cross

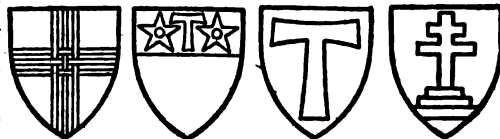

Skirlaw.

Drury.

St Anthony's Cross.

Brytton.

a name from the counts of Toulouse, its best-known bearers, some elaborate blazonry is spared.

The crosses paty and formy, and more especially the crosslets, are often borne fitchy, that is to say, with the lower limb somewhat lengthened and ending in a point, for which reason the 15th-century writers call these "crosses fixabil." In the 14th-century rolls the word "potent" is sometimes used for these crosses fitchy, the long foot suggesting a potent or staff. From this source modern English armorists derive many of their "crosses potent," whose four arms have the T heads of old-fashioned walking staves.

Howard bore "Silver a bend between six crosslets fitchy gules."

Scott of Congerhurst in Kent bore "Silver a crosslet fitchy sable."

The Saltire is the cross in the form of that on which St Andrew

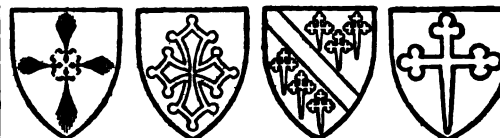

Hurleston.

Melton.

Howard.

Scott.

suffered, whence it is borne on the banner of Scotland, and by the Andrew family of Northamptonshire.

Neville of Raby bore "Gules a saltire silver."

Nicholas Upton, the 15th-century writer on armory, bore "Silver a saltire sable with the ends coupé and five golden rings thereon."

Aynho bore "Sable a saltire silver having the ends flowered between four leopards gold."
 "Mayer Elwett of Yorke chyre" in a 15th-century roll bears "Silver a saltire of chains sable with a crescent in the chief."

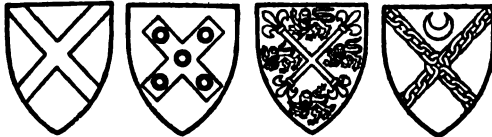

Nevile. Upton. Ayho. Elwett.

Restwilde bore "Party saltirewise of gules and ermine."

The chief is the upper part of the shield and, marked out by a line of division, is taken as one of the Ordinaries. Shields with a plain chief and no more are rare in England, but Tichborne of Tichborne has borne since the 13th century "Vair a chief gold." According to the heraldry books the chief should be marked off as a third part of the shield, but its depth varies, being broader when charged with devices and narrower when, itself uncharged, it surmounts a charged field. Fenwick bore "Silver a chief gules with six martlets countercoloured," and in this case the chief would be the half of the shield. Clinging to the belief that the chief must not fill more than a third of the shield, the heraldry books abandon the word in such cases, blazoning them as "party per fesse."



Fenwick.

Hastang bore "Azure a chief gules and a lion with a forked tail over all."

Walter Kingston seals in the 13th century with a shield of "Two rings or annelets in the chief."

Hilton of Westmoreland bore "Sable three rings gold and two saltires silver in the chief."

With the chief may be named the Foot, the nether part of the shield marked off as an Ordinary. So rare is this charge that we can cite but one example of it, that of the shield of John of Skipton, who in the 14th century bore "Silver with the foot indented purple and a lion purple." The foot, however, is a recognized bearing in France, whose heralds gave it the name of *champagne*.

The Pale is a broad stripe running the length of the shield. Of a single pale and of three pales there are several old examples. Four red pales in a golden shield were borne by Eleanor of Provence, queen of Henry III.; but the number did not com-



Restwilde. Hastang. Hilton. Provence.

mend itself to English armorists. When the field is divided evenly into six pales it is said to be paly; if into four or eight pales, it is blazoned as paly of that number of pieces. But paly of more or less than six pieces is rarely found.

The Yorkshire house of Gascoigne bore "Silver a pale sable with a golden conger's head thereon, cut off at the shoulder."

Ferlington bore "Gules three pales vair and a chief gold."

Strelley bore "Paly silver and azure."

Rothinge bore "Paly silver and gules of eight pieces."

When the shield or charge is divided palewise down the middle into two tinctures it is said to be "party." "Party silver and gules" are the arms of the Waldegraves. Bermingham bore "Party silver and sable indented." Caldecote bore "Party silver and azure with a chief gules." Such partings of the field often cut through charges whose colours change about on

either side of the parting line. Thus Chaucer the poet bore "Party silver and gules with a bend countercoloured."

The Fesse is a band athwart the shield, filling, according to the rules of the heraldic writers, a third part of it. By ancient use, however, as in the case of the chief and pale, its width varies with the taste of the painter, narrowing when set in a field full of charges and broadening when charges are displayed on itself.

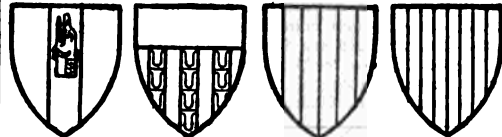

Gascoigne. Ferlington. Strelley. Rothinge.

When two or three fesses are borne they are commonly called Bars. "Ermine four bars gules" is given as the shield of Sir John Sully, a 14th-century Garter knight, on his stall-plate at Windsor; but the plate belongs to a later generation, and should probably have three bars only. Little bars borne in couples are styled Gemels (twins). The field divided into an even number of bars of alternate colours is said to be barry,

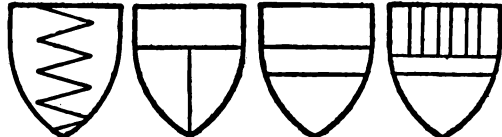

Bermingham. Caldecote. Colevile. Fauconberg.

barry of six pieces being the normal number. If four or eight divisions be found the number of pieces must be named; but with ten or more divisions the number is unreckoned and "burely" is the word.

Colevile of Bitham bore "Gold a fesse gules."

West bore "Silver a dance (or fesse dancy) sable."

Fauconberg bore "Gold a fesse azure with three pales gules in the chief."

Cayvile bore "Silver a fesse gules, flowered on both sides."

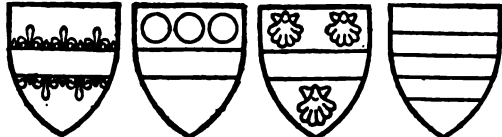

Cayvile. Devereux. Chamberlayne. Harcourt.

Devereux bore "Gules a fesse silver with three roundels silver in the chief."

Chamberlayne of Northamptonshire bore "Gules a fesse and three scallops gold."

Harcourt bore "Gules two bars gold."

Manners bore "Gold two bars azure and a chief gules."

Wake bore "Gold two bars gules with three roundels gules in the chief."

Bussy bore "Silver three bars sable."

Badlesmere of Kent bore "Silver a fesse between two gemels gules."

Melsanby bore "Sable two gemels and a chief silver."



Manners. Wake. Melsanby. Grey.

Grey bore "Barry of silver and azure."

Fitzmaes of Bedale bore "Barry of eight pieces gold and gules."

Stutevile bore "Burely of silver and gules."

The Bend is a band traversing the shield aslant, arms with one, two or three bends being common during the middle ages in England. Bendy shields follow the rule of shields paly and Barry, but as many as ten pieces have been counted in them. The bend is often accompanied by a narrow bend on either side, these companions being called Cotices. A single narrow bend, struck over all other charges, is the Baston, which during the 13th and 14th centuries was a common difference for the shields of the younger branches of a family, coming in later times to suggest itself as a difference for bastards.

The Bend Sinister, the bend drawn from right to left beginning at the "sinister" corner of the shield, is reckoned in the heraldry books as a separate Ordinary, and has a peculiar significance



Fitzalan of Bedale. Mauley. Harley. Wallop.

accorded to it by novelists. Medieval English seals afford a group of examples of Bends Sinister and Bastons Sinister, but there seems no reason for taking them as anything more than cases in which the artist has neglected the common rule.

Mauley bore "Gold a bend sable."
 Harley bore "Gold a bend with two cotices sable."
 Wallop bore "Silver a bend wavy sable."
 Raleigh bore "Gules a bend indented, or engrailed, silver."

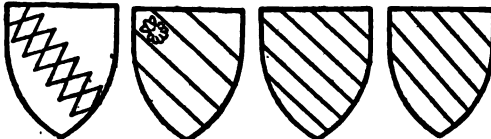

Raleigh. Tracy. Bodrigan. St Philibert.

Tracy bore "Gold two bends gules with a scallop sable in the chief between the bends."
 Bodrigan bore "Gules three bends sable."
 St Philibert bore "Bendy of six pieces, silver and azure."
 Bishopsdon bore "Bendy of six pieces, gold and azure, with a quarter ermine."
 Montfort of Whitchurch bore "Bendy of ten pieces gold and azure."
 Henry of Lancaster, second son of Edmund Crouchback, bore the

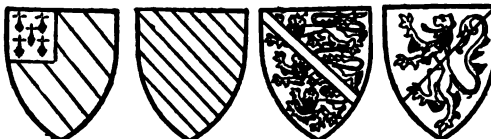

Bishopsdon. Montfort. Lancaster. Fraunceys.

arms of his cousin, the king of England, with the difference of "a baston azure."

Adam Fraunceys (14th century) bore "Party gold and sable bendwise with a lion countercoloured." The parting line is here commonly shown as "sinister."

The Chevron, a word found in medieval building accounts for the barge-boards of a gable, is an Ordinary whose form is explained by its name. Perhaps the very earliest of English armorial charges, and familiarized by the shield of the great house of Clare, it became exceedingly popular in England. Like the bend and the chief, its width varies in different examples. Likewise its angle varies, being sometimes so acute as to touch the top of the shield, while in post-medieval armory the point is often blunted beyond the right angle. One, two or three chevrons occur in numberless shields, and five chevrons have been found. Also there are some examples of the bearing of cheverony.

The earls of Gloucester of the house of Clare bore "Gold three chevrons gules" and the Staffords derived from them their shield of "Gold a cheveron gules."

Chaworth bore "Azure two chevrons gold."
 Peytevyn bore "Cheverony of ermine and gules."
 St Quintin of Yorkshire bore "Gold two chevrons gules and a chief vair."
 Sheffield bore "Ermine a cheveron gules between three sheaves gold."
 Cobham of Kent bore "Gules a cheveron gold with three fleurs-de-lys azure thereon."
 Fitzwalter bore "Gold a fesse between two chevrons gules."

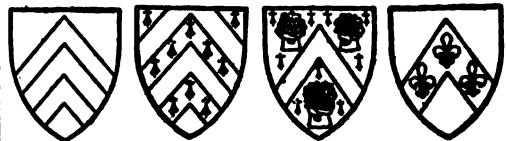

Chaworth. Peytevyn. Sheffield. Cobham.

Shields parted cheveronwise are common in the 15th century, when they are often blazoned as having chiefs "enty" or grafted. Aston of Cheshire bore "Party sable and silver cheveronwise" or "Silver a chief enty sable."

The Pile or stake (*estache*) is a wedge-shaped figure jutting from the chief to the foot of the shield, its name allied to the pile of the bridge-builder. A single pile is found in the notable arms of Chandos, and the black piles in the ermine shield of Hollis are seen as an example of the bearing of two piles. Three piles are more easily found, and when more than one is represented the points are brought together at the foot. In ancient armory piles in a shield are sometimes reckoned as a variety of pales, and a Basset with three piles on his shield is seen with three pales on his square banner.

Chandos bore "Gold a pile gules."
 Bryene bore "Gold three piles azure."

The Quarter is the space of the first quarter of the shield divided crosswise into four parts. As an Ordinary it is an ancient charge and a common one in medieval England, although it has all but disappeared from modern heraldry books, the "Canton," an alleged "diminutive," unknown to early armory, taking its place. Like the other Ordinaries, its size is found to vary with the scheme of the shield's charges, and this has persuaded those armorists who must needs call a narrow bend a "bendlet," to the invention of the "Canton," a word which in the sense of a quarter or small quarter appears for the first time in the latter part of the 15th century. Writers of the 14th century sometimes give it the name of the Cantel, but this word is also applied to the void space on the opposite side of the chief, seen above a bend.

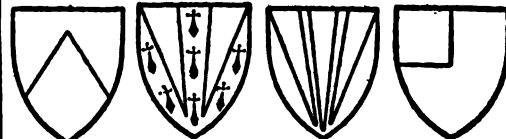

Aston. Hollis. Bryene. Blencowe.

Blencowe bore "Gules a quarter silver."
 Basset of Drayton bore "Gold three piles (or pales) gules with a quarter ermine."
 Wydvile bore "Silver a fesse and a quarter gules."
 Odingales bore "Silver a fesse gules with a molet gules in the quarter."

Robert Dene of Sussex (14th century) bore "Gules a quarter azure embelif, or aslant, and thereon a sleeved arm and band of silver."

Shields or charges divided crosswise with a downward line and a line athwart are said to be quarterly. An ancient coat of this fashion is that of Say who bore (13th century) "Quarterly gold and gules"—the first and fourth quarters being gold and the second and third red. Ever or Eure bore the same with the

addition of "a bend sable with three silver scallops thereon." Phelip, Lord Bardolf, bore "Quarterly gules and silver with an eagle gold in the quarter."

With the 15th century came a fashion of dividing the shield into more than four squares, six and nine divisions being often found in arms of that age. The heraldry books, eager to work

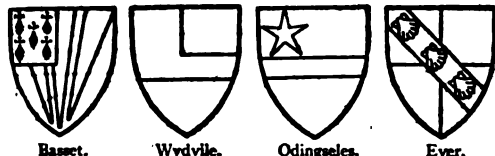

out problems of blazonry, decide that a shield divided into six squares should be described as "Party per fesse with a pale counterchanged," and one divided into nine squares as bearing "a cross quarter-pierced." It seems a simpler business to follow a 15th-century fashion and to blazon such shields as being of six or nine "pieces." Thus John Garther (15th century) bore "Nine pieces erminees and ermine" and Whitgreave of Staffordshire "Nine pieces of azure and of Stafford's arms, which are gold with a cheveron gules." The Tallow Chandlers of London had a grant in 1456 of "Six pieces azure and silver with three doves in the azure, each with an olive sprig in her beak."

Squared into more than nine squares the shield becomes checky or checkered and the number is not reckoned. Warene's checker of gold and azure is one of the most ancient coats in England and checkered fields and charges follow in great numbers. Even lions have been borne checkered.

- Warene bore "Checky gold and azure."
- Clifford bore the like with "a fesse gules."
- Cobham bore "Silver a lion checky gold and sable."
- Arderne bore "Ermine a fesse checky gold and gules."

Such charges as this fesse of Arderne's and other checkered fesses, bars, bends, borders and the like, will commonly bear but

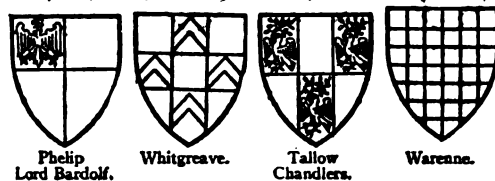

two rows of squares, or three at the most. The heraldry writers are ready to note that when two rows are used "counter-compony" is the word in place of checky, and "compony-counter-compony" in the case of three rows. It is needless to say that these words have neither practical value nor antiquity to commend them. But bends and bastons, labels, borders and the rest are often coloured with a single row of alternating tinctures. In this case the pieces are said to be "gobony." Thus John Cromwell (14th century) bore "Silver a chief gules with a baston gobony of gold and azure."

The scocheon or shield used as a charge is found among the earliest arms. Itself charged with arms, it served to indicate alliance by blood or by tenure with another house, as in the bearings of St Owen whose shield of "Gules with a cross silver" has a scocheon of Clare in the quarter. In the latter half of the 15th century it plays an important part in the curious marshalling of the arms of great houses and lordships.

Erpingham bore "Vert a scocheon silver with an orle (or border) of silver martlets." Davillers bore at the battle of Boroughbridge "Silver three scocheons gules."

The scocheon was often borne voided or pierced, its field cut away to a narrow border. Especially was this the case in the far North, where the Balliols, who bore such a voided scocheon,

were powerful. The voided scocheon is wrongly named in all the heraldry books as an orle, a term which belongs to a number of small charges set round a central charge. Thus the martlets in the shield of Erpingham, already described, may be called an orle of martlets or a border of martlets. This misnaming of the voided scocheon has caused a curious misapprehension of its form, even Dr Woodward, in his *Heraldry, British and Foreign*, describing the "orle" as "a narrow border detached from the edge of the shield." Following this definition modern armorial artists will, in the case of quartered arms, draw the "orle" in a first or second quarter of a quartered shield as a rectangular figure and in a third or fourth quarter as a scalene triangle with one arched side. Thereby the original voided scocheon changes into forms without meaning.

- Balliol bore "Gules a voided scocheon silver."
- Surtees bore "Ermine with a quarter of the arms of Balliol."

The *Tressure* or flowered tressure is a figure which is correctly described by Woodward's incorrect description of the orle as cited above, being a narrow inner border of the shield. It is distinguished, however, by the fleurs-de-lys which decorate it,

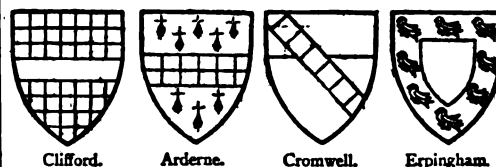

setting off its edges. The double tressure which surrounds the lion in the royal shield of Scotland, and which is borne by many Scottish houses who have served their kings well or mated with their daughters, is carefully described by Scottish heralds as "flowered and counter-flowered," a blazon which is held to mean that the fleurs-de-lys show head and tail in turn from the outer rim of the outer tressure and from the inner rim of the innermost. But this seems to have been no essential matter with medieval armorists and a curious 15th-century enamelled roundel of the arms of Vampage shows that in this English case the flowering takes the more convenient form of allowing all the lily heads to sprout from the outer rim.

- Vampage bore "Azure an eagle silver within a flowered tressure silver."
- The King of Scots bore "Gold a lion within a double tressure flowered and counterflowered gules."
- Felton bore "Gules two lions passant within a double tressure fofry silver."

The Border of the shield when marked out in its own tincture is counted as an Ordinary. Plain or charged, it was commonly used as a difference. As the principal charge of a shield it is very rare, so rare that in most cases where it apparently occurs

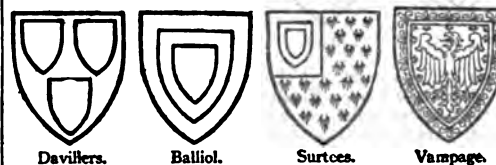

we may, perhaps, be following medieval custom in blazoning the shield as one charged with a scocheon and not with a border. Thus Hondesdote bore "Ermine a border gules" or "Gules a scocheon ermine."

- Somerville bore "Burely silver and gules and a border azure with golden martlets."
- Paynel bore "Silver two bars sable with a border, or orle, of martlets gules."

The Flaunches are the flanks of the shield which, cut off by rounded lines, are borne in pairs as Ordinaries. These charges are found in many coats devised by 15th-century armorists.

"Ermine two fanches azure with six golden wheat-ears" was borne by John Greyby of Oxfordshire (15th century).

The Label is a narrow fillet across the upper part of the chief, from which hang three, four, five or more pendants, the pendants being, in most old examples, broader than the fillet. Reckoned with the Ordinaries, it was commonly used as a means of differentiating a cadet's shield, and in the heraldry books it has become the accepted difference for an eldest son, although the cadets often bore it in the middle ages. John of Hastings bore in 1300 before Carlarock "Gold a sleeve (or maunche) gules," while Edmund his brother bore the same arms with a sable label. In modern armory the pendants are all but invariably reduced to three, which, in debased examples, are given a dovetailed form while the ends of the fillet are cut off.

The Fret, drawn as a voided lozenge interlaced by a slender saltire, is counted an Ordinary. A charge in such a shape is extremely rare in medieval armory, its ancient form when the field is covered by it being a number of bastons—three being the customary number—interlaced by as many more from the sinister side. Although the whole is described as a fret in certain English blazons of the 15th century, the adjective "fretty" is

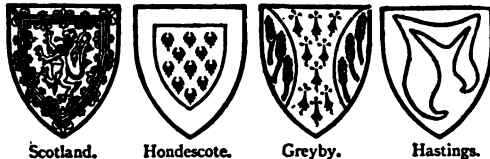

is more commonly used. Trussel's fret is remarkable for its bezants at the joints, which stand, doubtless, for the golden nail-heads of the "trellis" suggested by his name. Curwen, Wyville and other northern houses bearing a fret and a chief have, owing to their fashion of drawing their frets, often seen them changed by the heraldry books into "three cheverons braced or interlaced."

Huddleston bore "Gules fretty silver."
Trussel bore "Silver fretty gules, the joints bezanty."
Hugh Giffard (14th century) bore "Gules with an engrailed fret of ermine."
Wyville bore "Gules fretty vair with a chief gold."
Boxhull bore "Gold a lion azure fretty silver."

Another Ordinary is the Giron or Gyron—a word now commonly mispronounced with a hard "g." It may be defined as the

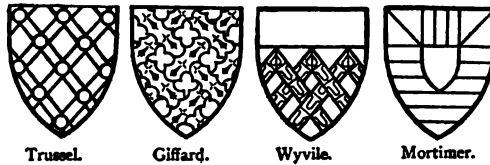

lower half of a quarter which has been divided bendwise. No old example of a single giron can be found to match the figure in the heraldry books. Gironny, or gyronny, is a manner of dividing the field into sections, by lines radiating from a centre point, of which many instances may be given. Most of the earlier examples have some twelve divisions although later armory gives eight as the normal number, as Campbell bears them.

Bassingbourne bore "Gironny of gold and azure of twelve pieces."
William Stoker, who died Lord Mayor of London in 1484, bore "Gironny of six pieces azure and silver with three popinjays in the silver pieces."

A pair of girons on either side of a chief were borne in the strange shield of Mortimer, commonly blazoned as "Barry azure and gold of six pieces, the chief azure with two pales and two girons gold, a scocheon silver over all." An early example shows that this shield began as a plain field with a gobony border.

With the Ordinaries we may take the Roundels or Pellets, disks or balls of various colours. Ancient custom gives the name of a bezant to the golden roundel, and the folly of the herakdic writers has found names for all the others, names which may be disregarded together with the belief that, while bezants and silver roundels, as representing coins, must be pictured with a flat surface, roundels of other hues must needs be shaded by the painter to represent rounded balls. Rings or Annelets were common charges in the North, where Lowthers, Musgraves

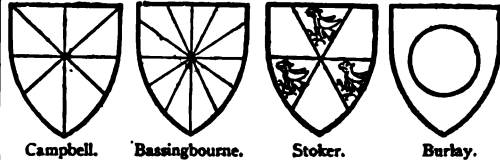

and many more, differed the six rings of Vipont by bearing them in various colours.

Burlay of Wharfedale bore "Gules a bezant."
Courtenay, earl of Devon, bore "Gold three roundels gules with a label azure."
Caraunt bore "Silver three roundels azure, each with three cheverons gules."
Vipont bore "Gold six annelets gules."
Avenel bore "Silver a fesse and six annelets (annelets) gules."
Hawberk of Stapleford bore "Silver a bend sable charged with three pieces of a mail hawberk, each of three linked rings of gold."
Stourton bore "Sable a bend gold between six fountains." The fountain is a roundel charged with waves of white and blue.

The Lozenge is linked in the heraldry book with the Fusil. This Fusil is described as a lengthened and sharper lozenge. But

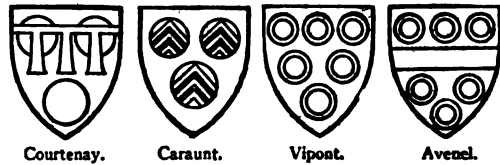

it will be understood that the Fusil, other than as part of an engrailed or indented bend, pale or fesse, is not known to true armory. Also it is one of the notable achievements of the English writers on heraldry that they should have allotted to the lozenge, when borne voided, the name of Mascle. This "mascle" is the word of the oldest armorists for the unvoided charge, the voided being sometimes described by them as a lozenge, without further qualifications. Fortunately the difficulty can be solved by following the late 14th-century custom in distinguishing between "lozenges" and "voided lozenges" and by abandoning altogether this misleading word Mascle.

Thomas of Merstone, a clerk, bore on his seal in 1359 "Ermine a lozenge with a pierced molet thereon."

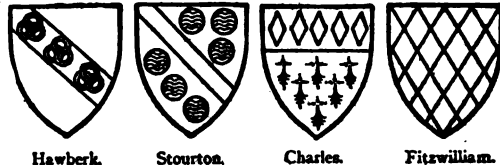

Braybroke bore "Silver seven voided lozenges gules."
Charles bore "Ermine a chief gules with five golden lozenges thereon."
Fitzwilliam bore "Lozengy silver and gules."

Billets are oblong figures set upright. Black billets in the arms of Delves of Cheshire stand for "delves" of earth and the gads of steel in the arms of the London Ironmongers' Company took a somewhat similar form.

Sir Ralph Mouchensy bore in the 14th century "Silver a chevron between three billets sable."
Haggerston bore " Azure a bend with cotices silver and three billets sable on the bend."

With the Billet, the Ordinaries, uncertain as they are in number, may be said to end. But we may here add certain armorial charges which might well have been counted with them.

First of these is the Molet, a word corrupted in modern heraldry to Mullet, a fish-like charge with nothing to commend it. This figure is as a star of five or six points, six points being perhaps the commonest form in old examples, although the sixth point is, as a rule, lost during the later period. Medieval armorists are not, it seems, inclined to make any distinction between molets of five and six points, but some families, such as the Harpedens and Asshetons, remained constant to the five-pointed form. It was generally borne pierced with a round hole, and then represents, as its name implies, the rowel of a spur. In ancient rolls of arms the word Rowel is often used, and probably indicated the pierced molet. That the piercing was reckoned an essential difference is shown by a roll of the time of Edward II., in which Sir John of Pabenharn bears " Barry azure and silver, with a bend gules and three molets gold thereon," arms which Sir John his son differences by piercing the molets. Beside these names is that of Sir Walter Baa with " Gules a chevron and three rowels silver," rowels which are shown on seals of this family as pierced molets. Probably an older bearing than the molet, which would be popularized when the rowelled spur began to take the place of the prick-spur, is the Star or Estoile, differing from the molet in that its five or six points are wavy. It is possible that several star bearings of the 13th century were changed in the 14th for molets. The star is not pierced in the fashion of the molet; but, like the molet, it tends to lose its sixth point in armory of the decadence. Suns, sometimes blazoned in old rolls as Sun-rays—*rays de soleil*—are pictured as unpierced molets of many points, which in rare cases are waved.

Harpeden bore " Silver a pierced molet gules."
Gentil bore " Gold a chief sable with two molets goles pierced gules."

Grimston bore " Silver a fesse sable and thereon three molets silver pierced gules."

Ingleby of Yorkshire bore " Sable a star silver."
Sir John de la Haye of Lincolnshire bore " Silver a sun gules."

The Crescent is a charge which has to answer for many idle tales concerning the crusading ancestors of families who bear

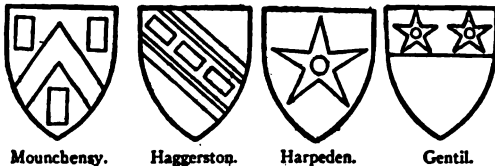

it. It is commonly borne with both points uppermost, but when representing the waning or the waxing moon—decrecent or increcent—its horns are turned to the sinister or dexter side of the shield.

Peter de Marines (13th century) bore on his seal a shield charged with a crescent in the chief.

William Gobioun (14th century) bore " A bend between two waxing moons."

Longchamp bore " Ermine three crescents gules, pierced silver."

Tinctures.—The tinctures or hues of the shield and its charges are seven in number—gold or yellow, silver or white, red, blue, black, green and purple. Medieval custom gave, according to a rule often broken, "gules," "azure" and "sable" as more high-sounding names for the red, blue and black. Green was often named as "vert," and sometimes as "synobill," a word which as "sinople" is used to this day by French armorists. The song of the siege of Carlarverock and other early documents have red, gules or "vermeil," sable or black, azure or blue, but gules, azure, sable and vert came to be recognized as armorists'

adjectives, and an early 15th-century romance discards the simple words deliberately, telling us of its hero that

"His shield was black and blue, sanz fable,
Barred of azure and of sable."

But gold and silver served as the armorists' words for yellows and whites until late in the 16th century, when, gold and silver made way for "or" and "argent," words which those for whom the interest of armory lies in its liveliest days will not be eager to accept. Likewise the colours of "sanguine" and "tenné" brought in by the pedants to bring the tinctures to the mystical number of nine may be disregarded.

A certain armorial chart of the duchy of Brabant, published in 1600, is the earliest example of the practice whereby later engravers have indicated colours in uncoloured plates by the use of lines and dots. Gold is indicated by a powdering of dots;

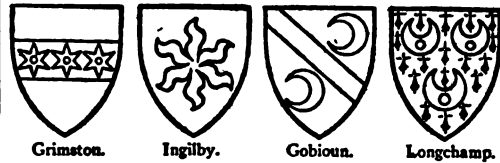

silver is left plain. Azure is shown by horizontal shading lines; gules by upright lines; sable by cross-hatching of upright and horizontal lines. Diagonal lines from sinister to dexter indicate purple; vert is marked with diagonal lines from dexter to sinister. The practice, in spite of a certain convenience, has been disastrous in its cramping effects on armorial art, especially when applied to seals and coins.

Besides the two "metals" and five "colours," fields and charges are varied by the use of the furs ermine and vair. Ermine is shown by a white field flecked with black ermine tails, and vair by a conventional representation of a fur of small skins sewn in rows, white and blue skins alternately. In the 15th century there was a popular variant of ermine, white tails upon a black field. To this fur the books now give the name of "erminees"—a most unfortunate choice, since ermine is a name used in old documents for the original ermine. "Erminees," which has at least a 15th-century authority, will serve for those who are not content to speak of "sable ermined with silver." Vair, although silver and blue be its normal form, may be made up of gold, silver or ermine, with sable or gules or vert, but in these latter cases the colours must be named in the blazon. To the vairs and erminees of old use the heraldry books have added "erminois," which is a gold field with black ermine tails, "pean," which is "erminois" reversed, and "erminites," which is ermine with a single red hair on either side of each black tail. The vairs, mainly by misunderstanding of the various patterns found in old paintings, have been amplified with "countervair," "potent," "counter-potent" and "vair-en-point," no one of which merits description.

No shield of a plain metal or colour has ever been borne by an Englishman, although the knights at Carlarverock and Falkirk saw Amaneu d'Albret with his banner all of red having no charge thereon. Plain ermine was the shield of the duke of Brittany and no Englishman challenged the bearing. But Beauchamp of Hatch bore simple vair, Ferrers of Derby "Vairy gold and gules," and Ward "Vairy silver and sable." Gresley had "Vairy ermine and gules," and Beche "Vairy silver and gules."

Only one English example has hitherto been discovered of a field covered not with a fur but with overlapping feathers. A 15th-century book of arms gives "Plumetty of gold and purple" for "Mydlam in Coverdale."

Drops of various colours which variegates certain fields and charges are often mistaken for ermine tails when ancient seals are deciphered. A simple example of such spattering is in the shield of Grayndore, who bore "Party ermine and vert, the vert

dropped with gold." Sir Richard le Brun (14th century) bore "Azure a silver lion dropped with gules."

A very common variant of charges and fields is the sowing or "powdering" them with a small charge repeated many times. Mortimer of Norfolk bore "gold powdered with fleurs-de-lys sable" and Edward III. quartered for the old arms of France "Azure powdered with fleurs-de-lys gold," such fields being often

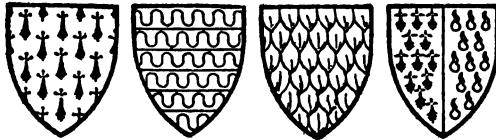

Brittany. Beauchamp. Mydlam. Grayndorpe.

described as flowered or flory. Golden billets were scattered in Cowdry's red shield, which is blazoned as "Gules billey gold," and bezants in that of Zouche, which is "Gules bezanty with a quarter ermine." The disposition of such charges varied with the users. Zouche as a rule shows ten bezants placed four, three, two and one on his shield, while the old arms of France in the royal coat allows the pattern of flowers to run over the edge, the shield border thus showing halves and tops and stalk ends of the fleurs-de-lys. But the commonest of these powderings is that with crosslets, as in the arms of John la Warr "Gules crasily silver with a silver lion."

Trees, Leaves and Flowers.—Sir Stephen Cheyndut, a 13th-century knight, bore an oak tree, the *cheyne* of his first syllable, while for like reasons a Pirton had a pear tree on his shield. Three pears were borne (*temp.* Edward III.) by Nicholas Stivecle of Huntingdonshire, and about the same date is Applegarth's

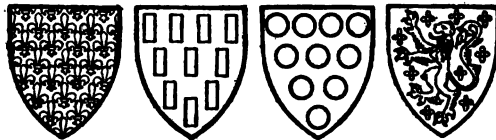

Mortimer. Cowdry. Zouche. La Warr.

shield of three red apples in a silver field. Leaves of burdock are in the arms (14th century) of Sir John de Lisle and mulberry leaves in those of Sir Hugh de Morieux. Three roots of trees are given to one Richard Rotour in a 14th-century roll. Malherbe (13th century) bore the "evil herb"—a teazel bush. Pineapples are borne here and there, and it will be noted that armorists have not surrendered this, our ancient word for the "fir-cone," to the foreign *ananas*. Out of the cornfield English armory took the sheaf, three sheaves being on the shield of an earl of Chester early in the 13th century and Sheffield bearing sheaves for a play on his name. For a like reason Peverel's sheaves were sheaves of pepper. Rye bore three ears of rye on a bend, and Graindorge had barley-ears. Flowers are few in this

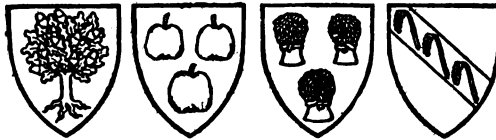

Cheyndut. Applegarth. Chester. Rye.

field of armory, although lilies with their stalks and leaves are in the grant of arms to Eton College. Ousethorpe has water flowers, and now and again we find some such strange charges as those in the 15th-century shield of Thomas Porthelyne who bore "Sable a chevron gules between three 'poppebolles,' or poppy-heads vert."

The fleur-de-lys, a conventional form from the beginnings of

armory, might well be taken amongst the "ordinaries." In England as in France it is found in great plenty.

Aguylon bore "Gules a fleur-de-lys silver."

Peyferer bore "Silver three fleur-de-lys sable."

Trefoils are very rarely seen until the 15th century, although Hervey has them, and Gausill, and a Bosville coat seems to have borne them. They have always their stalk left hanging to them. Vincent, Hattecliffe and Massingberd all bore the quatrefoil, while the Bardolfs, and the Quincys, earls of Winchester, had cinquefoils. The old rolls of arms made much confusion between cinquefoils and sixfoils (*quintefoilles e sixfoilles*) and the rose. It is still uncertain how far that confusion extended amongst the families which bore these charges. The cinquefoil and sixfoil, however, are all but invariably pierced in the middle like the spur rowel, and the rose's blunt-edged petals give it definite shape soon after the decorative movement of the Edwardian age began to carve natural buds and flowers in stone and wood.

Hervey bore "Gules a bend silver with three trefoils vert thereon."

Vincent bore "Azure three quatrefoils silver."

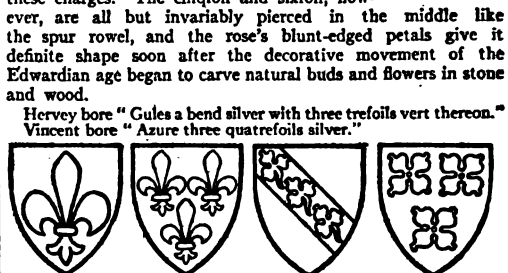

Aguylon. Peyferer. Hervey. Vincent.

Quincy bore "Gules a cinquefoil silver."

Bardolf of Wormesgay bore "Gules three cinquefoils silver."

Cosington bore "Azure three roses gold."

Hilton bore "Silver three chaplets or garlands of red roses."

Beasts and Birds.—The book of natural history as studied in the middle ages lay open at the chapter of the lion, to which royal beast all the noble virtues were set down. What is the oldest armorial seal of a sovereign prince as yet discovered bears the rampant lion of Flanders. In England we know of no royal shield earlier than that first seal of Richard I. which has a like device. A long roll of our old earls, barons and knights wore the

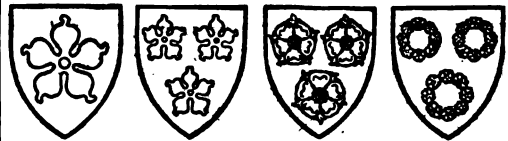

Quincy. Bardolf. Cosington. Hilton.

lion on their coats—Lacy, Marshal, Fitzalan and Montfort, Percy, Mowbray and Talbot. By custom the royal beast is shown as rampant, touching the ground with but one foot and clawing at the air in noble rage. So far is this the normal attitude of a lion that the adjective "rampant" was often dropped, and we have leave and good authority for blazoning the rampant beast simply as "a lion," leave which a writer on armory may take gladly to the saving of much repetition. In France and Germany this licence has always been the rule, and the modern English herald's blazon of "Gules a lion rampant or" for the arms of Fitzalan, becomes in French *de gueules au lion d'or* and in German *in Rot ein goldener Loewe*. Other positions must be named with care and the prowling "lion passant" distinguished from the rampant beast, as well as from such rarer shapes as the couchant lion, the lion sleeping, sitting or leaping. Of these the lion passant is the only one commonly encountered. The lion standing with his forepaws together is not a figure for the shield, but for the crest, where he takes this position for greater stableness upon the helm, and the sitting lion is also found rather upon helms than in shields. For a



Eton College.

couchant lion or a dormant lion one must search far afield, although there are some medieval instances. The leaping lion is in so few shields that no maker of a heraldry book has, it would appear, discovered an example. In the books this "lion salient" is described as with the hind paws together on the ground and the fore paws together in the air, somewhat after the fashion of a diver's first movement. But examples from seals and monuments of the Felbrigges and the Merks show that the leaping lion differed only from the rampant in that he leans somewhat forward in his eager spring. The compiler of the British Museum catalogue of medieval armorial seals, and others equally unfamiliar with medieval armory, invariably describe this position as "rampant," seeing no distinction from other rampings. As rare as the leaping lion is the lion who looks backward over his shoulder. This position is called "regardant" by modern armorists. The old French blazon calls it *vere regardant* or *turnaunt le visage arere*, "regardant" alone meaning simply "looking," and therefore we shall describe it more reasonably in plain English as "looking backward." The two-headed lion occurs in a 15th-century coat of Mason, and at the same period a monstrous lion of three bodies and one head is borne, apparently, by a Sharingbury.

The lion's companion is the leopard. What might be the true form of this beast was a dark thing to the old armorist, yet knowing from the report of grave travellers that the leopard was begotten in spouse-breach between the lion and the pard, it was felt that his shape would favour his sire's. But nice distinctions of outline, even were they ascertainable, are not to be marked on the tiny seal, or easily expressed by the broad strokes of the shield painter. The leopard was indeed lesser than the lion, but in armory, as in the Noah's arks launched by the old yards, the bear is no bigger than the badger. Then a happy device came to the armorist. He would paint the leopard like the lion at all points. But as the lion looks forward the leopard should look sidelong, showing his whole face. The matter was arranged, and until the end of the middle ages the distinction held and served. The disregarded writers on armory, Nicholas Upton, and his fellows, protested that a lion did not become a leopard by turning his face sidelong, but none who fought in the field under lion and leopard banners heeded this pedantry from cathedral closes. The English king's beasts were leopards in blazon, in ballad and chronicle, and in the mouths of liegeman and enemy. Henry V.'s herald, named from his master's coat,



England.

was Leopard Herald; and Napoleon's gazettes never fail to speak of the English leopards. In our own days, those who deal with armory as antiquaries and students of the past will observe the old custom for convenience' sake. Those for whom the interest of heraldry lies in the nonsense-language brewed during post-medieval years may correct the medieval ignorance at their pleasure. The knight who saw the king's banner fly at Falkirk or Crécy tells us that it bore "Gules with three leopards of gold." The modern armorist will shame the uninstructed warrior with "Gules three lions passant gardant in pale or."

As the lion rampant is the normal lion, so the normal leopard is the leopard passant, the adjective being needless. In a few cases only the leopard rises up to ramp in the lion's fashion, and here he must be blazoned without fail as a leopard rampant.

Parts of the lion and the leopard are common charges. Chief of these are the demi-lion and the demi-leopard, beasts complete above their slender middles, even to the upper parts of their lashing tails. Rampant or passant, they follow the customs of the unmaimed brute. Also the heads of lion and leopard are in many shields, and here the armorist of the modern handbooks stumbles by reason of his refusal to regard clearly marked medieval distinctions. The instructed will know a lion's head because it shows but half the face and a leopard's head because it is seen full-face. But the handbooks of heraldry, knowing naught of leopards, must judge by absence or presence of a mane, speaking uncertainly of leopards' faces and lions' heads

and faces. Here again the old path is the straighter. The head of a lion, or indeed of any beast, bird or monster, is generally painted as "razed," or torn away with a ragged edge which is pleasantly conventionalized. Less often it is found "couped" or cut off with a sheer line. But the leopard's head is neither razed nor couped, for no neck is shown below it. Likewise the lion's fore leg or paw—"gamb" is the book word—may be borne, razed or couped. Its normal position is raided upright, although Newdegate seems to have borne "Gules three lions' legs razed silver, the paws downward." With the strange bearing of the lion's whip-like tail cut off at the rump, we may end the list of these oddments.

- Fitzalan, earl of Arundel, bore "Gules a lion gold."
- Simon de Montfort bore "Gules a silver lion with a forked tail."
- Segrave bore "Sable a lion silver crowned gold."
- Havering bore "Silver a lion rampant gules with a forked tail, having a collar azure."
- Felbrigg of Felbrigg bore "Gold a leaping lion gules."
- Esturmy bore "Silver a lion sable (or purple) looking backward."
- Marmion bore "Gules a lion vair."
- Mason bore "Silver a two-headed lion gules."
- Lovetot bore "Silver a lion parted atwart of sable and gules."
- Richard le Jea bore "Vert a lion gold"—the arms of Wakelin of Arderne—with a fesse gules on the lion."
- Fiennes bore "Azure three lions gold."
- Leyburne of Kent bore "Azure six lions silver."



Fitzalan. Felbrigg. Fiennes. Leyburne.

- Carew bore "Gold three lions passant sable."
- Fotheringhay bore "Silver two lions passant sable, looking backward."
- Richard Norton of Waddeworth (1357) sealed with arms of "A lion dormant."
- Lisle bore "Gules a leopard silver crowned gold."
- Ludlowe bore "Azure three leopards silver."
- Brocas bore "Sable a leopard rampant gold."



Carew. Fotheringhay. Brocas. Lisle.

- John Hardrys of Kent seals in 1372 with arms of "a sitting leopard."
- John Northampton, Lord Mayor of London in 1381, bore "Azure a crowned leopard gold with two bodies rampant against each other."
- Newenham bore "Azure three demi-lions silver."
- A deed delivered at Lapworth in Warwickshire in 1466 is sealed with arms of "a molet between three demi-leopards."
- Kenton bore "Gules three lions' heads razed sable."



Kenton. Pole. Cantelou. Fynchebek.

- Pole, earl and duke of Suffolk, bore "Azure a fesse between three leopards' heads gold."
- Cantelou bore "Azure three leopards' heads silver with silver fleurs-de-lys issuing from them."
- Wederton bore "Gules a chevron between three lions' legs razed silver."
- Fynchebek bore "silver three forked tails of lions sable."
- The tiger is rarely named in collections of medieval arms. Deep mystery wrapped the shape of him, which was never during

the middle ages standardized by artists. A crest upon a 15th-century brass shows him as a lean wolf-like figure, with a dash of the boar, gazing after his vain wont into a looking-glass; and the 16th-century heralds gave him the body of a lion with the head of a wolf, head and body being tufted here and there with thick tufts of hair. But it is noteworthy that the arms of Sir John Norwich, a well-known knight of the 14th century, are blazoned in a roll of that age as "party azure and gules with a tiger rampant ermine." Now this beast in the arms of Norwich has been commonly taken for a lion, and the Norwich family seem in later times to have accepted the lion as their bearing. But a portion of a painted roll of Sir John's day shows on careful examination that his lion has been given two moustache-like tufts to the nose. A copy made about 1600 of another roll gives the same decoration to the Norwich lion, and it is at least possible we have here evidence that the economy of the medieval armorist allowed him to make at small cost his lion, his leopard and his tiger out of a single beast form.

Take away the lions and the leopards, and the other beasts upon medieval shields are a little herd. In most cases they are here to play upon the names of their bearers. Thus Swinburne of Northumberland has the heads of swine in his coat and Bacon has bacon pigs. Three white bears were borne by Barlingham, and a bear ramping on his hind legs is for Barnard. Lovett of Astwell has three running wolves, Videlou three wolves' heads, Colfox three foxes' heads.

Three hedgehogs were in the arms of Heriz. Barnewall reminds us of extinct natives of England by bearing two beavers, and Otter of Yorkshire had otters. Harewell had hares' heads,



Lovett.



Talbot.



Saunders.

Cunliffe conies, Mitford moles or moldiwarpes. A Talbot of Lancashire had three purple squirrels in a silver shield. An elephant was brought to England as early as the days of Henry III., but he had no immediate armorial progeny, although Saunders of Northants may have borne before the end of the middle ages the elephants' heads which speak of Alysaunder the Great, patron of all Saunderses. Bevil of the west had a red bull, and Bulkeley bore three silver bulls' heads. The heads in Neteham's 14th-century shield are neat's heads, ox heads are for Oxwyk. Calves are for Veel, and the same mild beasts are in the arms of that fierce knight Hugh Calveley. Stansfeld bore three rams with bells at their necks, and a 14th-century Lechefeld thought no shame to bear the head of the ram who is the symbol of lechery. Lambton had lambs. Goats were borne by Chevercourt to play on his name, a leaping goat by Bardwell, and goats' heads by Gateshead. Of the race of dogs the greyhound and the talbot, or mastiff, are found most often. Thus Talbot of Cumberland had talbots, and Mauleverer, running greyhounds or "leverers" for his name's sake. The alaund, a big, crop-eared dog, is in the 15th-century shield of John Woode of Kent, and "kenets," or little tracking dogs, in a 13th-century coat of Kenet. The horse is not easily found as an English charge, but Moyle's white mule seems an old coat; horses' heads are in Horsey's shield, and ass heads make crests for more than one noble house. Askew has three asses in his arms. Three bats or flittermice are in the shield of Burningham and in that of Heyworth of Whethamstede.

As might be looked for in a land where forest and greenwood once linked from sea to sea, the wild deer is a common charge in the shield. Downes of Cheshire bore a hart "lodged" or lying down. Hertford had harts' heads, Malebis, fawns' heads (*testes de bis*), Bukingham, heads of bucks. The harts in Rotherham's arms are the rocs of his name's first syllable. Reindeer

heads were borne by Bowet in the 14th century. Antelopes, fierce beasts with horns that have something of the ibex, show by their great claws, their lion tails, and their boar muzzles and tusks that they are midway between the hart and the monster.

Of the outlandish monsters the griffon is the oldest and the chief. With the hinder parts of a lion, the rest of him is eagle, head and shoulders, wings and fore legs. The long tuft under the beak and his pointed ears mark him out from the eagle when his head alone is borne. At an early date a griffon rampant, his normal position, was borne by the great house of Montagu as a quartering, and another griffon played upon Griffin's name.



Griffin.

The wyver, who becomes wyvern in the 16th century, and takes a new form under the care of inventive heralds, was in the middle ages a lizard-like dragon, generally with small wings. Sir Edmund Mauley in the 14th century is found differencing the black bend of his elder brother by charging it with three wyvers of silver. During the middle ages there seems small distinction between the wyver and the still rarer dragon, which, with the coming of the Tudors, who bore it as their badge, is seen as a four-legged monster with wings and a tail that ends like a broad arrow. The monster in the arms of Drake, blazoned by Tudor heralds as a wyvern, is clearly a fire-drake or dragon in his origin.



Drake.

The unicorn rampant was borne by Harlyn of Norfolk, unicorn's heads by the Cambridge-shire family of Paris. The mermaid with her comb and looking-glass makes a 14th-century crest for Byron, while "Silver a bend gules with three silver harpies thereon" is found in the 15th century for Entyrdene.

Concerning beasts and monsters the heraldry books have many adjectives of blazonry which may be disregarded. Even as it was once the pride of the cook pedant to carve each bird on the board with a new word for the act, so it became the delight of the pedant herald to order that the rampant horse should be "forcené," the rampant griffon "segreant," the passant hart "trippant"; while the same hart must needs be "attired" as to its horns and "unguled" as to its hoofs. There is ancient authority for the nice blazonry which sometimes gives a separate colour to the tongue and claws of the lion, but even this may be set aside. Though a black lion in a silver field may be armed with red claws, and a golden leopard in a red field given blue claws and tongues, these trifles are but fancies which follow the taste of the painter, and are never of obligation. The tusks and hoofs of the boar, and often the horns of the hart, are thus given in some paintings a colour of their own which elsewhere is neglected.

As the lion is among armorial beasts, so is the eagle among the birds. A bold convention of the earliest shield painters displayed him with spread wing and claw, the feat of a few strokes of the brush, and after this fashion he appears on many scores of shields. Like the claws and tongue of the lion, the beak and claws of the eagle are commonly painted of a second colour in all but very small representations. Thus the golden eagle of Lymesey in a red field may have blue beak and claws, and golden beak and claws will be given to Jorce's silver eagle upon red. A lure, or two wings joined and spread like those of an eagle, is a rare charge sometimes found. When fitted with the cord by which a falconer's lure is swung, the cord must be named.

Monthermer bore "Gold an eagle vert."
Siggoston bore "Silver a two-headed eagle sable."
Gavaston, earl of Cornwall, bore "Vert six eagles gold."
Bayforde of Fordingbridge sealed (in 1388) with arms of "An eagle bendwise, with a border engrailed and a baston."
Graunson bore "Paly silver and azure with a bend gules and three golden eagles thereon."
Seymour bore "Gules a lure of two golden wings."

Commoner than the eagle as a charge is the martlet, a humbler bird which is never found as the sole charge of a shield. In all

but a few early representations the feathers of the legs are seen without the legs or claws. The martlet indicates both swallow and martin, and in the arms of the Cornish Arundels the martlets must stand for "hirundels" or swallows.

The falcon or hawk is borne as a rule with close wings, so that he may not be taken for the eagle. In most cases he is there



Monthermer. Siggoston. Cavaston. Graunson.



to play on the bearer's name, and this may be said of most of the flight of lesser birds.

Naunton bore "Sable three martlets silver."

Heron bore "Azure three herons silver."

Fauconer bore "Silver three falcons gules."

Hauville bore "Azure a dance between three hawks gold."

Twenge bore "Silver a fesse gules between three popinjays (or parrots) vert."

Cransley bore "Silver a chevron gules between three cranes azure."

Asdale bore "Gules a swan silver."

Dalston bore "Silver a chevron engrailed between three daws' heads rased sable."

Corbet bore "Gold two corbies sable."



Seymour. Naunton. Fauconer. Twenge.

Cockfield bore "Silver three cocks gules."

Burton bore "Sable a chevron sable between three silver owls."

Rokeyby bore "Silver a chevron silver between three rooks."

Duffelde bore "Sable a chevron silver between three doves."

Pelham bore "Azure three pelicans silver."



Asdale. Corbet. Cockfield. Burton.

Sumeri (13th century) sealed with arms of "A peacock with his tail spread."

John Pyeshale of Suffolk (14th century) sealed with arms of "Three magpies."

Fishes, Reptiles and Insects.—Like the birds, the fishes are borne for the most part to call to mind their bearers' names. Unless their position be otherwise named, they are painted as upright in the shield, as though rising towards the water surface. The dolphin is known by his bowed back, old artists making him a grotesquely decorative figure.

Lucy bore "Gules three lucas (or pike) silver."

Heringaud bore "Azure, crusilly gold, with six golden herrings."

Fishacre bore "Gules a dolphin silver."

La Roche bore "Three roach swimming."

John Samon (14th century) sealed with arms of "Three salmon swimming."

Sturgeon bore "Azure three sturgeon swimming gold, with a fess gules over all."

Whalley bore "Silver three whales' heads rased sable."

Shell-fish would hardly have place in English armory were it not for the abundance of scallops which have followed their appearance in the banners of Dacre and Scales. The crest

of the Yorkshire Scropes, playing upon their name, was a pair of crabs' claws.

Dacre bore "Gules three scallops silver."

Shelley bore "Sable a fesse engrailed between three whelk-shells gold."

Reptiles and insects are barely represented. The lizards in the crest and supporters of the Ironmongers of London belong to the 15th century. Gawdy of Norfolk may have borne the tortoise in his shield in the same age. "Silver three toads sable" was quartered as a second coat for Botreaux of Cornwall



Rokeby. Pelham. Lucy. Fishacre.

in the 16th century—Botereau or Boterel signifying a little toad in the old French tongue—but the arms do not appear on the old Botreaux seals beside their ancient bearing of the griffon. Beston bore "Silver a bend between six bees sable" and a 15-century Harbottle seems to have sealed with arms of three bluebottle flies. Three butterflies are in the shield of Presfen of Lancashire in 1415, while the winged insect shown on the seal of John Mayre, a King's Lynn burgess of the age of Edward I., is probably a mayfly.

Human Charges.—Man and the parts of him play but a small part in English shields, and we have nothing to put beside such a coat as that of the German Manessen, on which two armed knights attack each other's hauberks with their teeth. But certain arms of religious houses and the like have the whole figure, the see of Salisbury bearing the Virgin and Child in a

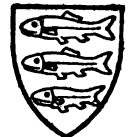

Roche.



Dacre. Shelley. See of Salisbury. Isle of Man.

blue field. And old crests have demi-Saracens and falchion men, coal-miners, monks and blackmoors. Sowdan bore in his shield a turbaned soldan's head; Eady, three old men's "heads"; Heads of maidens, the "winsome marrows" of the ballad, are in the arms of Marow. The Stanleys, as kings of Man, quartered the famous three-armed legs whirling mill-sail fashion, and Tremayne of the west bore three men's arms in like wise. "Gules three hands silver" was for Malmeyns as early as the 13th century, and Tynte of Colchester displayed hearts.

Miscellaneous Charges.—Other charges of the shield are less frequent but are found in great variety, the reason for most of them being the desire to play upon the bearer's name.

Weapons and the like are rare, having regard to the military associations of armory. Daubency bore three helms; Phillip Marmion took with his wife, the coheir of Kilpek, the Kilpek shield of a sword (*esppek*). Tuck had a stabbing sword or "tuck." Bent bows were borne by Bowes, an arblast by Arblastar, arrows by Archer, birding-bolts or *boswons* by Bosun, the mangonel by Mangnall. The three lances of Amherst is probably a medieval coat; Leweston had battle-axes.

A scythe was in the shield of Praers; Picot had picks; Bilsby a hammer or "beal"; Malet showed mallets. The chamberlain's key is in the shield of a Chamberlain, and the spenser's key in that of a Spenser. Porter bore the porter's bell, Botcher the butler's cup. Three-legged pots were borne by Moaboches'

Crowns are for Corouñ. Yarde had yard-wands; Bordoun a burdon or pilgrim's staff.

Of horse-furniture we have the stirrups of Scudamore and Giffard, the horse-barnacles of Bernake, and the horse-shoes borne by many branches and tenants of the house of Ferrers.

Of musical instruments there are pipes, trumps and harps for Pipe, Trumpington and Harpesfeld. Hunting horns are common among families bearing such names as Forester or Horne. Remarkable charges are the three organs of Grenville, who held of the house of Clare, the lords of Glamorgan.

Combs play on the name of Tunstall, and gloves (*wauns* or *gouns*) on that of Wauncy. Hose were borne by Hoese; buckles by a long list of families. But the most notable of the charges derived from clothing is the hanging sleeve familiar in the arms of Hastings, Conyers and Mansel.

Chess-rooks, hardly to be distinguished from the *roc* or *roquet* at the head of a jousting-lance, were borne by Rokewode and by many more. Topcliffe had pegtops in his shield, while Ambesas had a cast of three dice which should each show the point of one, for "to throw ambasec" is an ancient phrase used of those who throw three aces.

Although we are a sea-going people, there are few ships in our armory, most of these in the arms of sea-ports. Anchors are commoner.

Castles and towers, bridges, portcullises and gates have all examples, and a minster-church was the curious charge borne by the ancient house of Musters of Kirklington.

Letters of the alphabet are very rarely found in ancient armory; but three capital T's, in old English script, were borne by Toft of Cheshire in the 14th century. In the period of decadence whole words or sentences, commonly the names of military or naval victories, are often seen.

Blazonry.—An ill-service has been done to the students of armory by those who have pretended that the phrases in which the shields and their charges are described or blazoned must follow arbitrary laws devised by writers of the period of armorial decadence. One of these laws, and a mischievous one, asserts that no tincture should be named a second time in the blazon of one coat. Thus if gules be the hue of the field any charge of that colour must thereafter be styled "of the first." Obeying this law the blazoner of a shield of arms elaborately charged may find himself sadly involved among "of the first," "of the second," and "of the third." It is needless to say that no such law obtained among armorists of the middle ages. The only rule that demands obedience is that the brief description should convey to the reader a true knowledge of the arms described.

The examples of blazonry given in that part of this article which deals with armorial charges will be more instructive to the student than any elaborated code of directions. It will be observed that the description of the field is first set down, the blazoner giving its plain tincture or describing it as burely, party, paly or Barry, as powdered or sown with roses, crosslets or fleurs-de-lys. Then should follow the main or central charges, the lion or griffon dominating the field, the chevron or the pale, the fesse, bend or bars, and next the subsidiary charges in the field beside the "ordinary" and those set upon it. Chiefs and quarters are blazoned after the field and its contents, and the border, commonly an added difference, is taken last of all. Where there are charges both upon and beside a bend, fesse or the like, a curious inversion is used by pedantic blazoners. The arms of Mr Samuel Pepys of the Admiralty Office would have been described in earlier times as "Sable a bend gold between two horses' heads razed silver, with three fleurs-de-lys sable on the bend." Modern heraldic writers would give the sentence as "Sable, on a bend or between two horses' heads erased argent, three fleurs-de-lys of the first." Nothing is gained by this inversion but the precious advantage of naming the bend but once. On the other side it may be said that, while the newer blazon couches itself in a form that seems to prepare for the naming of the fleurs-de-lys as the important element of the shield, the older form gives the fleurs-de-lys as a mere postscript, and rightly, seeing that charges in such a position are very commonly

the last additions to a shield by way of difference. In like manner when a crest is described it is better to say "a lion's head out of a crown" than "out of a crown a lion's head." The first and last necessity in blazonry is lucidity, which is cheaply gained at the price of a few syllables repeated.

Modern Heraldry.—With the accession of the Tudors armory began a rapid decadence. Heraldry ceased to play its part in military affairs, the badges and banners under which the medieval noble's retinue came into the field were banished, and even the tournament in its later days became a renaissance pageant which did not need the painted shield and armorial trappers. Treatises on armory had been rare in the days before the printing press, but even so early a writer as Nicholas Upton had shown himself as it were unconcerned with the heraldry that any man might see in the camp and the street. From the Book of St Albans onward the treatises on armory are informed with a pedantry which touches the point of crazy mysticism in such volumes as that of Sylvanus Morgan. Thus came into the books those long lists of "diminutions of ordinaries," the closets and escarpes, the endorses and ribands, the many scores of strange crosses and such wild fancies as the rule, based on an early German pedantry, that the tinctures in peers shields should be given the names of precious stones and those in the shields of sovereigns the names of planets. Blazon became cumbered with that vocabulary whose French of Stratford atte Bowe has driven serious students from a business which, to use a phrase as true as it is hackneyed, was at last "abandoned to the coachpainter and the undertaker."

With the false genealogy came in the assumption or assigning of shields to which the new bearers had often no better claim than lay in a surname resembling that of the original owner. The ancient system of differencing arms disappeared. Now and again we see a second son obeying the book-rules and putting a crescent in his shield or a third son displaying a molet, but long before our own times the practice was disregarded, and the most remote kinsman of a gentle house displayed the "whole coat" of the head of his family.

The art of armory had no better fate. An absurd rule current for some three hundred years has ordered that the helms of princes and knights should be painted full-faced and those of peers and gentlemen sidelong. Obeying this, the herald painters have displayed the crests of knights and princes as sideways upon a full-faced helm; the torse or wreath, instead of being twisted about the brow of the helm, has become a sausage-shaped bar see-sawing above the helm; and upon this will be balanced a crest which might puzzle the ancient craftsman to mould in his leather or parchment. A ship on a lee-shore with a thunder-storm lowering above its masts may stand as an example of such devices. "Tastes, of course, differ," wrote Dr Woodward, "but the writer can hardly think that the *épergne* given to Lieut.-General Smith by his friends at Bombay was a fitting ornament for a helmet." As with the crest, so with the shield. It became crowded with ill-balanced figures devised by those who despised and ignored the ancient examples whose painters had followed instinctively a simple and pleasant convention. Landscapes and seascapes, musical lines, military medals and corrugated boiler-flues have all made their appearance in the shield. Even as on the signs of public houses, written words have taken the place of figures, and the often-cited arms exemplified to the first Earl Nelson marked, it may be hoped, the high watermark of these distressing modernisms. Of late years, indeed, official armory in England has shown a disposition to follow the lessons of the archaeologist, although the recovery of mediæval use has not yet been as successful as in Germany, where for a long generation a school of vigorous armorial art has flourished.

Officers of Arms.—Officers of arms, styled kings of arms, heralds and pursuivants, appear at an early period of the history of armory as the messengers in peace and war of princes and magnates. It is probable that from the first they bore in some wise their lord's arms as the badge of their office. In the 14th century we have heralds with the arms on a short mantle, witness the figure of the duke of Gelderland's herald painted in the

Armorial de Gobre. The title of Blue Mantle pursuivant, as old as the reign of Edward III., suggests a like usage in England. When the tight-laced coat of arms went out of fashion among the knighthood the loose tabard of arms with its wide sleeves was at once taken in England as the armorial dress of both herald and cavalier, and the fashion of it has changed but little since those days. Clad in such a coat the herald was the image of his master and, although he himself was rarely chosen from any rank above that of the lesser gentry, his person, as a messenger, acquired an almost priestly sacredness. To injure or to insult him was to affront the coat that he wore.

We hear of kings of arms in the royal household of the 13th century, and we may compare their title with those of such officers as the King of the Ribalds and the King of the Minstrels; but it is noteworthy that, even in modern warrants for heralds' patents, the custom of the reign of Edward III. is still cited as giving the necessary precedents for the officers' liveries. Officers of arms took their titles from their provinces or from the titles and badges of their masters. Thus we have Garter, Norroy and Clarenceux, March, Lancaster, Windsor, Leicester, Leopard, Falcon and Blanc Sanglier as officers attached to the royal house; Chandos, the herald of the great Sir John Chandos; Vert Eagle of the Nevill earls of Salisbury, Esperance and Crescent of the Percys of Northumberland. The spirit of Henry VII.'s legislation was against such usages in baronial houses, and in the age of the Tudors the last of the private heralds disappears.

In England the royal officers of arms were made a corporation by Richard III. Nowadays the members of this corporation, known as the College of Arms or Herald's College, are Garter Principal King of Arms, Clarenceux King of Arms South of Trent, Norroy King of Arms North of Trent, the heralds Windsor, Chester, Richmond, Somerset, York and Lancaster, and the pursuivants Rouge Croix, Bluemantle, Rouge Dragon and Portcullis. Another king of arms, not a member of this corporation, has been attached to the order of the Bath since the reign of George I., and an officer of arms, without a title, attends the order of St Michael and St George.

There is no college or corporation of heralds in Scotland or Ireland. In Scotland "Lyon-king-of-arms," "Lyon rex armorum," or "Leo feccialis," so called from the lion on the royal shield, is the head of the office of arms. When first the dignity was constituted is not known, but Lyon was a prominent figure in the coronation of Robert II. in 1371. The office was at first, as in England, attached to the earl marshal, but it has long been conferred by patent under the great seal, and is held direct from the crown. Lyon is also king-of-arms for the national order of the Thistle. He is styled "Lord Lyon," and the office has always been held by men of family, and frequently by a peer who would appoint a "Lyon depute." He is supreme in all matters of heraldry in Scotland. Besides the "Lyon depute," there are the Scottish heralds, Albany, Ross and Rothessay, with precedence according to date of appointment; and the pursuivants, Carrick, March and Unicorn. Herald and pursuivants are appointed by Lyon.

In Ireland also there is but one king-of-arms, Ulster. The office was instituted by Edward VI. in 1553. The patent is given by Rymer, and refers to certain emoluments as "praedicto officio . . . ab antiquo spectantibus." The allusion is to an Ireland king-of-arms mentioned in the reign of Richard II. and superseded by Ulster. Ulster holds office by patent, during pleasure; under him the Irish office of arms consists of two heralds, Cork and Dublin; and a pursuivant, Athlone. Ulster is king-of-arms to the order of St Patrick. He held visitations in parts of Ireland from 1568 to 1620, and these and other records, including all grants of arms from the institution of the office, are kept in the Birmingham Tower, Dublin.

The armorial duties of the ancient heralds are not clearly defined. The patent of Edward IV., creating John Wrythe king of arms of England with the style of Garter, speaks vaguely of the care of the office of arms and those things which belong to that office. We know that the heralds had their part in the ordering of tournaments, wherein armory played its greatest

part, and that their expert knowledge of arms gave them such duties as reckoning the noble slain on a battlefield. But it is not until the 15th century that we find the heralds following a recognized practice of granting or assigning arms, a practice on which John of Guildford comments, saying that such arms given by a herald are not of greater authority than those which a man has taken for himself. The Book of St Albans, put forth in 1486, speaking of arms granted by princes and lords, is careful to add that "armys bi a manny's proper auctorite take, if an other man have not borne theym afore, be of strength enogh," repeating, as it seems, Nicholas Upton's opinion which, in this matter, does not conflict with the practice of his day. It is probable that the earlier grants of arms by heralds were made by reason of persons uncunning in armorial lore applying for a suitable device to experts in such matters—and that such setting forth of arms may have been practised even in the 14th century.

The earliest known grants of arms in England by sovereigns or private persons are, as a rule, the conveyance of a right in a coat of arms already existing or of a differenced version of it. Thus in 1301 Thomas Grendale, a squire who had inherited through his grandmother the right in the shield of Beaumeys, granted his right in it to Sir William Moigne, a knight who seems to have acquired the whole or part of the Beaumeys manor in Sawtry. Under Henry VI. we have certain rare and curious letters of the crown granting nobility with arms "in signum hujusmodi nobilitatis" to certain individuals, some, and perhaps all of whom, were foreigners who may have asked for letters which followed a continental usage. After this time we have a regular series of grants by heralds who in later times began to assert that new arms, to be valid, must necessarily be derived from their assignments, although ancient use continued to be recognized.

An account of the genealogical function of the heralds, so closely connected with their armorial duties will be found in the article GENEALOGY. In spite of the work of such distinguished men as Camden and Dugdale they gradually fell in public estimation until Blackstone could write of them that the marshaling of coat-armor had fallen into the hands of certain officers called heralds, who had allowed for lucre such falsity and confusion to creep into their records that even their common seal could no longer be received as evidence in any court of justice. From this low estate they rose again when the new archaeology included heraldry in its interests, and several antiquaries of repute have of late years worn the herald's tabard.

In spite of the vast amount of material which the libraries catalogue under the head of "Heraldry," the subject has as yet received little attention from antiquaries working in the modern spirit. The old books are as remarkable for their detachment from the facts as for their folly. The work of Nicholas Upton, *De studio militari*, although written in the first half of the 15th century, shows, as has been already remarked, no attempt to reconcile the conceits of the author with the armorial practice which he must have seen about him on every side. Gerard Leigh, Bossewell, Ferne and Morgan carry on this bad tradition, each adding his own extravagances. The *Display of Heraldry*, first published in 1610 under the name of John Guillim, is more reasonable if not more learned, and in its various editions gives a valuable view of the decadent heraldry of the 17th century. In the 19th century many important essays on the subject are to be found in such magazines as the *Genealogist*, the *Herald and Genealogist* and the *Ancestor*, while Planché's *Pursuivant of Arms* contains some slight but suggestive work which attempts original enquiry. But Dr Woodward's *Treatise on Heraldry, British and Foreign* (1806), in spite of many errors arising from the author's reliance upon unchecked material, must be counted the only scholarly book in English upon a matter which has engaged so many pens. Among foreign volumes may be cited those of Menestrier and Spenser, and the vast compilation of the German Siebmacher. Notable ordinaries of arms are those of Papworth and Renesse, companions to the armorials of Burke and Rietstap. The student may be advised to turn his attention to

all works dealing with the effigies, brasses and other monuments of the middle ages, to the ancient heraldic seals and to the heraldry of medieval architecture and ornament. (O. BA.)

HERAT, a city and province of Afghanistan. The city of Herat lies in $34^{\circ} 20' 30''$ N., and $62^{\circ} 11' 0''$ E., at an altitude of 2500 ft. above sea-level. Estimated pop. about 10,000. It is a city of great interest historically, geographically, politically and strategically, but in modern days it has quite lost its ancient commercial importance. From this central point great lines of communication radiate in all directions to Russian, British, Persian and Afghan territory. Sixty-six miles to the north lies the terminus of the Russian railway system; to the south-east is Kandahar (360 m.) and about 70 m. beyond that, New Chaman, the terminus of the British railway system. Southward lies Seistan (200 m.), and eastward Kabul (550 m.); while on the west four routes lead into Persia by Turbat to Meshed (215 m.), and by Birjend to Kerman (400 m.), to Yazd (500 m.), or to Isfahan (600 m.). The city forms a quadrangle of nearly 1 m. square (more accurately about 1000 yds. by 1500 yds.); on the western, southern and eastern faces the line of defence is almost straight, the only projecting points being the gateways, but on the northern face the contour is broken by a double outwork, consisting of the *Ark* or citadel, which is built of sundried brick on a high artificial mound within the enceinte, and a lower work at its foot, called the *Ark-i-nao*, or "new citadel," which extends 100 yds. beyond the line of the city wall. That which distinguishes Herat from all other Oriental cities, and at the same time constitutes its main defence, is the stupendous character of the earthwork upon which the city wall is built. This earthwork averages 250 ft. in width at the base and about 50 ft. in height, and as it is crowned by a wall 25 ft. high and 14 ft. thick at the base, supported by about 150 semi-circular towers, and is further protected by a ditch 45 ft. in width and 16 in depth, it presents an appearance of imposing strength. When the royal engineers of the Russo-Afghan Boundary Commission entered Herat in 1885 they found its defences in various stages of disrepair. The gigantic rampart was unflanked, and the covered ways in the face of it subject to enfilade from end to end. The ditch was choked, the gates were unprotected; the tumbled mass of irregular mud buildings which constituted the city clung tightly to the walls; there were no gun emplacements. Outside, matters were almost worse than inside. To the north of the walls the site of old Herat was indicated by a vast mass of debris—mounds of bricks and pottery intersected by a network of shallow trenches, where the only semblance of a protective wall was the irregular line of the Tal-i-Bangi. South of the city was a vast area filled in with the graveyards of centuries. Here the trenches dug by the Persians during the last siege were still in a fair state of preservation; they were within a stone's-throw of the walls. Round about the city on all sides were similar opportunities for close approach; even the villages stretched out long irregular streets towards the city gates. To the north-west, beyond the Tal-i-Bangi, the magnificent outlines of the Mosalla filled a wide space with the glorious curves of dome and gateway and the stately grace of tapering minars, but the impressive beauty of this, by far the finest architectural structure in all Afghanistan, could not be permitted to weigh against the fact that the position occupied by this pile of solid buildings was fatal to the interests of effective defence. By the end of August 1885, when a political crisis had supervened between Great Britain and Russia, under the orders of the Amir the Mosalla was destroyed; but four minars standing at the corners of the wide plinth still remain to attest to the glorious proportions of the ancient structure, and to exhibit samples of that decorative tilework, which for intricate beauty of design and exquisite taste in the bleeding of colour still appeals to the memory as unique. At the same time the ancient graveyards round the city were swept smooth and levelled; obstructions were demolished, outworks constructed, and the defences generally renovated. Whether or no the strength of this bulwark of North-Western Afghanistan should ever be practically tested, the general result of the most recent in-

vestigations into the value of Herat as a strategic centre has been largely to modify the once widely-accepted view that the key to India lies within it. Abdur Rahman and his successor Habibullah steadfastly refused the offer of British engineers to strengthen its defences; and though the Afghans themselves have occasionally undertaken repairs, it is doubtful whether the old walls of Herat are maintained in a state of efficiency.

The exact position of Herat, with reference to the Russian station of Kushk (now the terminus of a branch railway from Merv), is as follows: From Herat, a gentle ascent northwards for 3 m. reaches to the foot of the Koh-i-Mulla Khwaja, crossing the Jul Nao or "new" canal, which here divides the gravel-covered foot hills from the alluvial flats of the Hari Rud plain. The crest of the outer ridges of this subsidiary range is about 700 ft. above the city, at a distance of 4 m. from it. For 28 m. farther the road winds first amongst the broken ridges of the Koh-i-Mulla Khwaja, then over the intervening *dashi* into the southern spurs of the Paropamisus to the Ardewan pass. This is the highest point it attains; and it has risen about 2150 ft. from Herat. From the pass it drops over the gradually decreasing grades of a wide sweep of Chol (which here happens to be locally free from the intersecting network of narrow ravines which is generally a distinguishing feature of Turkestan loess formations) for a distance of 35 m. into the Russian railway station, falling some 2700 ft. from the crest of the Paropamisus. To the south the road from Herat to India through Kandahar lies across an open plain, which presents no great engineering difficulties, but is of a somewhat waterless and barren character.

The city possesses five gates, two on the northern face, the Kutab-chak near the north-east angle of the wall, and the Malik at the re-entering angle of the Ark-i-nao; and three others in the centres of the remaining faces, the Irak gate on the west, the Kandahar gate on the south and the Kushk gate on the east face. Four streets called the *Chakar-sak*, running from the centre of each face, meet in the centre of the town in a small domed quadrangle. The principal street runs from the south or Kandahar gate to the market in front of the citadel, and is covered in with a vaulted roof through its entire length, the shops and buildings of this bazaar being much superior to those of the other streets, and the merchants' caravanserais, several of which are spacious and well built, all opening out on this great thoroughfare. Near the central quadrangle of the city is a vast reservoir of water, the dome of which is of bold and excellent proportions. The only other public building of any consequence in Herat is the great mosque or *Masjid-i-Juma*, which comprises an area of 800 yds. square, and must have been a most magnificent structure. It was erected towards the close of the 15th century, during the reign of Shah Sultan Hussein of the family of Timur, and is said when perfect to have been 465 ft. long by 275 ft. wide, to have had 408 cupolas, 130 windows, 444 pillars and 6 entrances, and to have been adorned in the most magnificent manner with gilding, carving, precious mosaics and other elaborate and costly embellishments. Now, however, it is falling rapidly into ruin, the ever-changing provincial governors who administer Herat having neither the means nor the inclination to undertake the necessary repairs. Neither the palace of the Charbagh within the city wall, which was the residence of the British mission in 1840-1841, nor the royal quarters in the citadel deserve any special notice. At the present day, with the exception of the *Chakar-sak*, where there is always a certain amount of traffic, and where the great diversity of race and costume imparts much liveliness to the scene, Herat presents a very melancholy and desolate appearance. The mud houses in rear of the bazaars are for the most part uninhabited and in ruins, and even the burnt brick buildings are becoming everywhere dilapidated. The city is also one of the filthiest in the East, as there are no means of drainage or sewerage, and garbage of every description lies in heaps in the open streets.

Along the slopes of the northern hills there is a space of some 4 m. in length by 3 m. in breadth, the surface of the plain, strewn over its whole extent with pieces of pottery and crumbling bricks, and also broken here and there by earthen mounds and

ruined walls, the debris of palatial structures which at one time were the glory and wonder of the East. Of these structures indeed some have survived to the present day in a sufficiently perfect state to bear witness to the grandeur and beauty of the old architecture of Herat. Such was the mosque of the Mosalla before its destruction. Scarcely inferior in beauty of design and execution, though of more moderate dimensions, is the tomb of the saint Abdullah Ansari, in the same neighbourhood. This building, which was erected by Shah Rukh Mirza, the grandson of Timur, over 500 years ago, contains some exquisite specimens of sculpture in the best style of Oriental art. Adjoining the tomb also are numerous marble mausoleums, the sepulchres of princes of the house of Timur; and especially deserving of notice is a royal building tastefully decorated by an Italian artist named Gheraldi, who was in the service of Shah Abbas the Great. The locality, which is further enlivened by gardens and running streams, is named *Gasir-gah*, and is a favourite resort of the Heratis. It is held indeed in high veneration by all classes, and the famous Dost Mahomed Khan is himself buried at the foot of the tomb of the saint. Two other royal palaces named respectively *Bagh-i-Shah* and *Takht-i-Sefer*, are situated on the same rising ground somewhat farther to the west. The buildings are now in ruins, but the view from the pavilions, shaded by splendid plane trees on the terraced gardens formed on the slope of the mountain, is said to be very beautiful.

The population of Herat and the neighbourhood is of a very mixed character. The original inhabitants of Ariana were no doubt of the Aryan family, and immediately cognate with the Persian race, but they were probably intermixed at a very early period with the Sacae and Massagetae, who seem to have held the mountains from Kabul to Herat from the first dawn of history, and to whom must be ascribed—rather than to an infusion of Turco-Tartaric blood introduced by the armies of Jenghiz and Timur—the peculiar broad features and flatish countenance which distinguish the inhabitants of Herat, Seistan and the eastern provinces of Persia from their countrymen farther to the west. Under the government of Herat, however, there are a very large number of tribes, ruled over by separate and semi-independent chiefs, and belonging probably to different nationalities. The principal group of tribes is called the *Chahar-Aimakh*, or "four races," the constituent parts of which, however, are variously stated by different authorities both as to strength and nomenclature. The Heratis are an agricultural race, and are not nearly so warlike as the Pathans from the neighbourhood of Kabul or Kandahar.

The long narrow valley of the Hari Rud, starting from the western slopes of the Koh-i-Baba, extends almost due west for 300 m. before it takes its great northern bend at Kuhsan, and passes northwards through the broken ridges of the Siah Bubuk (the western extremity of the range which we now call Paropamisus) towards Sarakhs. For the greater part of its length it drains the southern slopes only of the Paropamisus and the northern slopes of a parallel range called Koh-i-Safed. The Paropamisus forms the southern face of the Turkestan plateau, which contains the sources of the Murghab river; the northern face of the same plateau is defined by the Band-i-Turkestan. On the south of the plateau we find a similar succession of narrow valleys dividing parallel flexures, or anticlines, formed under similar geological conditions to those which appear to be universally applicable to the Himalaya, the Hindu Kush, and the Indus frontier mountain systems. From one of these long lateral valleys the Hari Rud receives its principal tributary, which joins the main river below Obek, 180 m. from its source; and it is this tributary (separated from the Hari Rud by the narrow ridges of the Koh-i-Safed and Band-i-Baian) that offers the high road from Herat to Kabul, and not the Hari Rud itself. From its source to Obek the Hari Rud is a valley of sandy desolation. There are no glaciers near its sources, although they must have existed there in geologically recent times, but masses of melting snow annually give rise to floods, which rush through the midst of the valley in a turbid red stream, frequently rendering the river impassable and cutting off the

crazy brick bridges at Herat and Tirpal. It is impossible, whilst watching the rolling, seething volume of flood-water which swirls westwards in April, to imagine the waste stretches of dry river-bed which in a few months' time (when every available drop of water is carried off for irrigation) will represent the Hari Rud. The soft shales or clays of the hills bounding the valley render these hills especially subject to the action of denudation, and the result, in rounded slopes and easily accessible crests, determines the nature of the easy tracks and passes which intersect them. At the same time, any excessive local rainfall is productive of difficulty and danger from the floods of liquid mud and loose boulders which sweep like an avalanche down the hill sides. The intense cold which usually accompanies these sudden northern blizzards of Herat and Turkestan is a further source of danger.

From Obek, 50 m. east of Herat, the cultivated portion of the valley commences, and it extends, with a width which varies from 8 to 16 m., to Kuhsan, 60 m. west of the city. But the great stretch of highly irrigated and valuable fruit-growing land, which appears to spread from the walls of Herat east and west as far as the eye can reach, and to sweep to the foot of the hills north and south with an endless array of vineyards and melon-beds, orchards and villages, varied with a brilliant patchwork of poppy growth brightening the width of green wheat-fields with splashes of scarlet and purple—all this is really comprised within a narrow area which does not extend beyond a ten-miles' radius from the city. The system of irrigation by which these agricultural results are attained is most elaborate. The despised Herati Tajik, in blue shirt and akul-cap, and with no instrument better than a three-cornered spade, is as skilled an agriculturist as is the Ghilzai engineer, but he cannot effect more than the limits of his water-supply will permit. He adopts the *karez* (or, Persian, *kandj*) system of underground irrigation, as does the Ghilzai, and brings every drop of water that he can find to the surface; but it cannot be said that he is more successful than the Ghilzai. It is the startling contrast of the Herati oasis with the vast expanse of comparative sterility that encloses it which has given such a fictitious value to the estimates of the material wealth of the valley of the Hari Rud.

The valley about Herat includes a flat alluvial plain which might, for some miles on any side except the north, be speedily reduced to an impassable swamp by means of flood-water from the surrounding canals. Three miles to the south of the city the river flows from east to west, spanned by the Pal-i-Malun, a bridge possessing grand proportions, but which was in 1885 in a state of grievous disrepair and practically useless. East and west stretches the long vista of the Hari Rud. Due north the hills called the Koh-i-Mulla Khwaja appear to be close and dominating, but the foot of these hills is really about 3 m. distant from the city. This northern line of barren, broken sandstone hills is geographically no part of the Paropamisus range, from which it is separated by a stretch of sandy upland about 20 m. in width, called the *Dasht-i-Hamdamao*, or *Dasht-i-Ardewan*, formed by the talus or drift of the higher mountains, which, washed down through centuries of denudation, now forms long sweeping spurs of gravel and sand, scantily clothed with worm-wood scrub and almost destitute of water. Through this stretch of *dasht* the drainage from the main water-divide breaks downwards to the plains of Herat, where it is arrested and utilized for irrigation purposes. To the north-east of the city a very considerable valley has been formed between the Paropamisus and the subsidiary Koh-i-Mulla Khwaja range, called Korokh. Here there are one or two important villages and a well-known shrine marked by a group of pine trees which is ubiquitous in this part of Afghanistan. The valley leads to a group of passes across the Paropamisus into Turkestan, of which the Zirmast is perhaps the best known. The main water-divide between Herat and the Turkestan Chol (the loess district) has been called Paropamisus for want of any well-recognized general name. To the north of the Korokh valley it exhibits something of the formation of the Hindu Kush (of which it is apparently a geological extension), but as it passes westwards it becomes broken

into fragments by processes of denudation, until it is hardly recognizable as a distinct range at all. The direct passes across it from Herat (the Baba and the Ardewān) wind amongst masses of disintegrating sandstone for some miles on each side of the dividing watershed, but farther west the rounded knolls of the rain-washed downs may be crossed almost at any point without difficulty. The names applied to this débris of a once formidable mountain system are essentially local and hardly distinctive. Beyond this range the sand and clay loess formation spreads downwards like a tumbled sea, hiding within the folds of its many-crested hills the twisting course of the Kushk and its tributaries.

History.—The origin of Herat is lost in antiquity. The name first appears in the list of primitive Zoroastrian settlements contained in the *Vendidād Sade*, where, however, like most of the names in the same list,—such as *Sughudu* (Sogdiana), *Mowā* (Merv or Margus), *Haragūti* (Arachotus or Arghand-ab), *Haetumant* (Etymander or Helmund), and *Ragha* (or Argha-stan),—it seems to apply to the river or river-basin, which was the special centre of population. This name of *Haroyu*, as it is written in the *Vendidād*, or *Harivo*, as it appears in the inscriptions of Darius, is a cognate form with the Sanskrit *Sarasvati*, which signifies “a river,” and its resemblance to the ethnic title of Aryan (Sana. *Arya*) is purely fortuitous; though from the circumstance of the city being named “Aria Metropolis” by the Greeks, and being also recognized as the capital of Ariana, “the country of the Arians,” the two forms have been frequently confounded. Of the foundation of Herat (or Heri, as it is still often called) nothing is known. We can only infer from the colossal character of the earth-works which surround the modern town, that, like the similar remains at Bost on the Helmund and at Ulan Robat of Arachosia, they belong to that period of Central-Asian history which preceded the rise of Achaemenian power, and which in Grecian romance is illustrated by the names of Bacchus, of Hercules and of Semiramis. To trace in any detail the fortunes of Herat would be to write the modern history of the East, for there has hardly been a dynastic revolution, or a foreign invasion, or a great civil war in Central Asia since the time of the prophet, in which Herat has not played a conspicuous part and suffered accordingly. Under the Tahirids of Khorasan, the Saffarids of Seistan and the Samanids of Bokhara, it flourished for some centuries in peace and progressive prosperity; but during the succeeding rule of the Ghaznevīd kings its metropolitan character was for a time obscured by the celebrity of the neighbouring capital of Ghazni, until finally in the reign of Sultan Sanjar of Merv about 1157 the city was entirely destroyed by an irruption of the Ghuzz, the predecessors, in race as well as in habitat, of the modern Turkomans. Herat gradually recovered under the enlightened Ghorid kings, who were indeed natives of the province, though they preferred to hold their court amid their ancestral fortresses in the mountains of Ghor, so that at the time of Jenghiz Khan's invasion it equalled or even exceeded in populousness and wealth its sister capitals of Balkh, Merv and Nishapur, the united strength of the four cities being estimated at three millions of inhabitants. But this Mogul visitation was most calamitous; forty persons, indeed, are stated to have alone survived the general massacre of 1232, and as a similar catastrophe overtook the city at the hands of Timur in 1398, when the local dynasty of Kurt, which had succeeded the Ghorides in eastern Khorasan, was put an end to, it is astonishing to find that early in the 15th century Herat was again flourishing and populous, and the favoured seat of the art and literature of the East. It was indeed under the princes of the house of Tirhur that most of the noble buildings were erected, of which the remains still excite our admiration at Herat, while all the great historical works relative to Asia, such as the *Rozet-es-Sefā*, the *Habib-es-seir*, *Hafiz Abrā's Tarikh*, the *Mallā' a-es-Sā'adīn*, &c., date from the same place and the same age. Four times was Herat sacked by Turkomans and Uzbegs during the centuries which intervened between the Timuride princes and the rise of the Afghan power, and it has never in modern times attained to anything like its old importance. Afghan

tribes, who had originally dwelt far to the east, were first settled at Herat by Nadir Shah, and from that time they have monopolized the government and formed the dominant element in the population. It will be needless to trace the revolutions and counter-revolutions which have followed each other in quick succession at Herat since Ahmad Shah Durani founded the Afghan monarchy about the middle of the 18th century. Let it suffice to say that Herat has been throughout the seat of an Afghan government, sometimes in subordination to Kabul and sometimes independent. Persia indeed for many years showed a strong disposition to reassert the supremacy over Herat which was exercised by the Safawid kings, but great Britain, disapproving of the advance of Persia towards the Indian frontier, steadily resisted the encroachment; and, indeed, after helping the Heratis to beat off the attack of the Persian army in 1838, the British at length compelled the shah in 1857 at the close of his war with them to sign a treaty recognizing the further independence of the place, and pledging Persia against any further interference with the Afghans. In 1863 Herat, which for fifty years previously had been independent of Kabul, was incorporated by Dost Mahomed Khan in the Afghan monarchy, and the Amir, Habibullah of Afghanistan, like his father Abdur Rahman before him, remained Amir of Herat and Kandahar, as well as Kabul.

See Holdich, *Indian Borderland* (1901); C. E. Yate, *North Afghanistan* (1888). (T. H. H.)

HÉRAULT, a département in the south of France, formed from Lower Languedoc. Pop. (1906) 482,779. Area, 2,403 sq. m. It is bounded N.E. by Gard, N.W. by Aveyron and Tarn, and S. by Aude and the Golfe du Léon. The southern prolongation of the Cévennes mountains occupies the north-western zone of the département, the highest point being about 4,290 ft. above the sea-level. South-east of this range comes a region of hills and plateaus decreasing in height as they approach the sea, from which they are separated by the rich plains at the mouth of the Orb and the Hérault and, farther to the north-east, by the line of intercommunicating salt lagoons (Etang de Thau, &c.) which fringes the coast. The region to the north-west of Montpellier comprises an extensive tract of country known as the Garrigues, a district of dry limestone plateaus and hills, which stretches into the neighbouring département of Gard. The mountains of the north-west form the watershed between the Atlantic and Mediterranean basins. From them flow the Hérault, its tributary the Lergue, and more to the south-west the Livron and the Orb, which are the main rivers of the département. Dry summers, varied by occasional violent storms, are characteristic of Hérault. The climate is naturally colder and more rainy in the mountains.

A third of the surface of Hérault is planted with vines, which are the chief source of agricultural wealth, the département ranking first in France with respect to the area of its vineyards; the red wines of St Georges, Cazouls-lès-Béziers, Picpoul and Maranssan, and the white wines of Frontignan and Lunel (pop. in 1906, 6760) are held in high estimation. The area given over to arable land and pasture is small in extent. Fruit trees of various kinds, but especially mulberries, olives and chestnuts flourish. The rearing of silk-worms is largely carried on. Considerable numbers of sheep are raised, their milk being utilized for the preparation of Roquefort cheeses. The mineral wealth of the département is considerable. There are mines of lignite, coal in the vicinity of Graissessac, iron, calamine and copper, and quarries of building-stone, limestone, gypsum, &c.; the marshes supply salt. Mineral springs are numerous, the most important being those of Lamalon-les-Bains and Balaruc-les-Bains. The chief manufactures are woollen and cotton cloth, especially for military use, silk (Gangcs), casks, soap and fertilizing stuffs. There are also oil-works, distilleries (Béziers) and tanneries (Bédarieux). Fishing is an important industry. Certe and Mèze (pop. in 1906, 5574) are the chief ports. Hérault exports salt fish, wine, liqueurs, timber, salt, building-material, &c. It imports cattle, skins, wool, cereals, vegetables, coal and other commodities. The railway lines belong chiefly to the

Southern and Paris-Lyon-Méditerranée companies. The Canal du Midi traverses the south of the department for 44 m. and terminates at Cette. The Canal des Étangs traverses the department for about 20 m., forming part of a line of communication between Cette and Aigues-Mortes. Montpellier, the capital, is the seat of a bishopric of the province of Avignon, and of a court of appeal and centre of an académie (educational division). The department belongs to the 16th military region, which has its headquarters at Montpellier. It is divided into the arrondissements of Montpellier, Béziers, Lodève and St Pons, with 36 cantons and 340 communes.

Montpellier, Béziers, Lodève, Bédarieux, Cette, Agde, Pézenas, Lamalou-les-Bains and Clermont-l'Hérault are the more noteworthy towns and receive separate treatment. Among the other interesting places in the department are St Pons, with a church of the 12th century, once a cathedral, Villemagne, which has several old houses and two ruined churches, one of the 13th, the other of the 14th century; Pignan, a medieval town, near which is the interesting abbey-church of Vignogoul in the early Gothic style; and St Guilhem-le-Désert, which has a church of the 11th and 12th centuries. Maguelonne, which in the 6th century became the seat of a bishopric transferred to Montpellier in 1536, has a cathedral of the 12th century.

HÉRAULT DE SÉCHELLES, MARIE JEAN (1750-1794), French politician, was born at Paris on the 20th of September 1750, of a noble family connected with those of Contades and Polignac. He made his début as a lawyer at the Châtelet, and delivered some very successful speeches; later he was *avocat général* to the parlement of Paris. His legal occupations did not prevent him from devoting himself also to literature, and after 1780 he published an account of a visit he had made to the comte de Buffon at Montbard. Héroult's account is marked by a delicate irony, and it has with some justice been called a masterpiece of interviewing, before the day of journalists. Héroult, who was an ardent champion of the Revolution, took part in the taking of the Bastille, and on the 8th of December 1789 was appointed judge of the court of the first arrondissement in the department of Paris. From the end of January to April 1791 Héroult was absent on a mission in Alsace, where he had been sent to restore order. On his return he was appointed *commissaire du roi* in the court of cassation. He was elected as a deputy for Paris to the Legislative Assembly, where he gravitated more and more towards the extreme left; he was a member of several committees, and, when a member of the diplomatic committee, presented a famous report demanding that the nation should be declared to be in danger (11th June 1793). After the revolution of the 10th of August 1792 (see FRENCH REVOLUTION), he co-operated with Danton, one of the organizers of this rising, and on the 2nd of September was appointed president of the Legislative Assembly. He was a deputy to the National Convention for the department of Seine-et-Oise, and was sent on a mission to organize the new department of Mont Blanc. He was thus absent during the trial of Louis XVI., but he made it known that he approved of the condemnation of the king, and would probably have voted for the death penalty. On his return to Paris, Héroult was several times president of the Convention, notably on the 2nd of June 1793, the occasion of the attack on the Girondins, and on the 10th of August 1793, on which the passing of the new constitution was celebrated. On this occasion Héroult, as president of the Convention, had to make several speeches. It was he, moreover, who, on the rejection of the projected constitution drawn up by Condorcet, was entrusted with the task of preparing a fresh one; this work he performed within a few days, and his plan, which, however, differed very little from that of Condorcet, became the Constitution of 1793, which was passed, but never applied. As a member of the Committee of Public Safety, it was with diplomacy that Héroult was chiefly concerned, and from October to December 1793 he was employed on a diplomatic and military mission in Alsace. But this mission helped to make him an object of suspicion to the other members of the Committee of Public Safety, and especially to Robespierre,

who as a deist and a fanatical follower of the ideas of Rousseau, hated Héroult, the follower of the naturalism of Diderot. He was accused of treason, and after being tried before the revolutionary tribunal, was condemned at the same time as Danton, and executed on the 16th Germinal in the year II. (5th April 1794). He was handsome, elegant and a lover of pleasure, and was one of the most individual figures of the Revolution.

See the *Voyage à Montbard*, published by A. Aulard (Paris, 1890); A. Aulard, *Les Orateurs de la Législative et de la Convention*, 2nd ed. (Paris, 1906); J. Claretie, *Camille Desmoulins. Étude sur les Dantonistes* (Paris, 1875); Dr Robinet, *Le Procès des Dantonistes* (Paris, 1879); "Héroult de Séchelles, sa première mission en Alsace" in the review *La Révolution Française*, tome 22; E. Daudet, *Le Roman d'un conventionnel. Héroult de Séchelles et les dames de Bellegarde* (1904). His *Œuvres littéraires* were edited (Paris, 1907) by E. Dard. (R. A.)

HERB (Lat. *herba*, grass, food for cattle, generally taken to represent the Old Lat. *forbea*, Gr. *φορβή*, pasture, *φάρβειν*, to feed, Sans. *bharb*, to eat), in botany, the name given to those plants whose stem or stalk dies entirely or down to the root each year, and does not become, as in shrubs or trees, woody or permanent, such plants are also called "herbaceous." The term "herb" is also used of those herbaceous plants, which possess certain properties, and are used for medicinal purposes, for flavouring or garnishing in cooking, and also for perfumes (see HORTICULTURE and PHARMACOLOGY).

HERBARIUM, or **HORTUS SECCUS**, a collection of plants so dried and preserved as to illustrate as far as possible their characters. Since the same plant, owing to peculiarities of climate, soil and situation, degree of exposure to light and other influences may vary greatly according to the locality in which it occurs, it is only by gathering together for comparison and study a large series of examples of each species that the flora of different regions can be satisfactorily represented. Even in the best equipped botanical garden it is impossible to have, at one and the same time, more than a very small percentage of the representatives of the flora of any given region or of any large group of plants. Hence a good herbarium forms an indispensable part of a botanical museum or institution. There are large herbaria at the British Museum and at the Royal Gardens, Kew, and smaller collections at the botanical institutions at the principal British universities. The original herbarium of Linnaeus is in the possession of the Linnaean Society of London. It was purchased from the widow of Linnaeus by Dr (afterwards Sir) J. E. Smith, one of the founders of the Linnaean Society, and after his death was purchased by the society. Herbaria are also associated with the more important botanic gardens and museums in other countries. The value of a herbarium is much enhanced by the possession of "types," that is, the original specimens on the study of which a species was founded. Thus the herbarium at the British Museum, which is especially rich in the earlier collections made in the 18th and early 19th centuries, contains the types of many species founded by the earlier workers in botany. It is also rich in the types of Australian plants in the collections of Sir Joseph Banks and Robert Brown, and contains in addition many valuable modern collections. The Kew herbarium, founded by Sir William Hooker and greatly increased by his son Sir Joseph Hooker, is also very rich in types, especially those of plants described in the *Flora of British India* and various colonial floras. The collection of Dillenius is deposited at Oxford, and that of Professor W. H. Harvey at Trinity College, Dublin. The collections of Antoine Laurent de Jussieu, his son Adrien, and of Auguste de St Hilaire, are included in the large herbarium of the Jardin des Plantes at Paris, and in the same city is the extensive private collection of Dr Ernest Cosson. At Geneva are three large collections—Augustin Pyramide de Candolle's, containing the typical specimens of the *Prodromus*, a large series of monographs of the families of flowering plants, Benjamin Delessert's fine series at the Botanic Garden, and the Boissier Herbarium, which is rich in Mediterranean and Oriental plants. The university of Göttingen has had bequeathed to it the largest collection (exceeding 40,000 specimens) ever made by a single individual—that of Professor Grisebach. At the

herbarium in Brussels are the specimens obtained by the traveller Karl Friedrich Philipp von Martius, the majority of which formed the groundwork of his *Flora Brasiliensis*. The Berlin herbarium is especially rich in more recent collections, and other national herbaria sufficiently extensive to subserve the requirements of the systematic botanist exist at St Petersburg, Vienna, Leiden, Stockholm, Upsala, Copenhagen and Florence. Of those in the United States of America, the chief, formed by Asa Gray, is the property of Harvard university; there is also a large one at the New York Botanical Garden. The herbarium at Melbourne, Australia, under Baron Müller, attained large proportions; and that of the Botanical Garden of Calcutta is noteworthy as the repository of numerous specimens described by writers on Indian botany.

Specimens of flowering plants and vascular cryptogams are generally mounted on sheets of stout smooth paper, of uniform quality; the size adopted at Kew is 17 in. long by 11 in. broad, that at the British Museum is slightly larger; the palms and their allies, however, and some ferns, require a larger size. The tough but flexible coarse grey paper (German *Fliesspapier*), upon which on the Continent specimens are commonly fixed by gummed strips of the same, is less hygroscopic than ordinary cartridge paper, but has the disadvantage of affording harbourage in the inequalities of its surface to a minute insect, *Atropis pulsatoria*, which commits great havoc in damp specimens, and which, even if noticed, cannot be dislodged without difficulty. The majority of plant specimens are most suitably fastened on paper by a mixture of equal parts of gum tragacanth and gum arabic made into a thick paste with water. Rigid leathery leaves are fixed by means of glue, or, if they present too smooth a surface, by stitching at their edges. Where, as in private herbaria, the specimens are not liable to be handled with great frequency, a stitch here and there round the stem, tied at the back of the sheet, or slips of paper passed over the stem through two slits in the sheet and attached with gum to its back, or simply strips of gummed paper laid across the stem, may be resorted to.

To preserve from insects, the plants, after mounting, are often brushed over with a liquid formed by the solution of $\frac{1}{2}$ lb. each of corrosive sublimate and carbolic acid in 1 gallon of methylated spirits. They are then laid out to dry on shelves made of a network of stout galvanized iron wire. The use of corrosive sublimate is not, however, recommended, as it forms on drying a fine powder which when the plants are handled will rub off and, being carried into the air, may prove injurious to workers. If the plants are subjected to some process, before mounting, by which injurious organisms are destroyed, such as exposure in a closed chamber to vapour of carbon bisulphide for some hours, the presence of pieces of camphor or naphthalene in the cabinet will be found a sufficient preservative. After mounting are written—usually in the right-hand corner of the sheet, or on a label there affixed—the designation of each species, the date and place of gathering, and the name of the collector. Other particulars as to habit, local abundance, soil and claim to be indigenous may be written on the back of the sheet or on a slip of writing paper attached to its edge. It is convenient to place in a small envelope gummed to an upper corner of the sheet any flowers, seeds or leaves needed for dissection or microscopical examination, especially where from the fixation of the specimen it is impossible to examine the leaves for oil-receptacles and where seed is apt to escape from ripe capsules and be lost. The addition of a careful dissection of a flower greatly increases the value of the specimen. To ensure that all shall lie evenly in the herbarium the plants should be made to occupy as far as possible alternately the right and left sides of their respective sheets. The species of each genus are then arranged either systematically or alphabetically in separate covers of stout, usually light brown paper, or, if the genus be large, in several covers with the name of the genus clearly indicated in the lower left-hand corner of each, and opposite it the names or reference numbers of the species. Undetermined species are relegated to the end of the genus. Thus prepared,

the specimens are placed on shelves or movable trays, at intervals of about 6 in., in an air-tight cupboard, on the inner side of the door of which, as a special protection against insects, is suspended a muslin bag containing a piece of camphor.

The systematic arrangement varies in different herbaria. In the great British herbaria the orders and genera of flowering plants are usually arranged according to Bentham and Hooker's *Genera plantarum*; the species generally follow the arrangement of the most recent complete monograph of the family. In non-flowering plants the works usually followed are for ferns, Hooker and Baker's *Synopsis filicum*; for mosses, Müller's *Synopsis muscorum frondosorum*, Jaeger & Sauerbeck's *Genera et species muscorum*, and Engler & Prantl's *Pflanzenfamilien*; for algae, de Toni's *Sylloge algarum*; for hepaticae, Gottsche, Lindenberg and Nees ab Esenbeck's *Synopsis hepaticarum*, supplemented by Stephani's *Species hepaticarum*; for fungi, Saccardo's *Sylloge fungorum*, and for mycetozoa Lister's monograph of the group. For the members of large genera, e.g. *Piper* and *Ficus*, since the number of cosmopolitan or very widely distributed species is comparatively few, a geographical grouping is found specially convenient by those who are constantly receiving parcels of plants from known foreign sources. The ordinary systematic arrangement possesses the great advantage, in the case of large genera, of readily indicating the affinities of any particular specimen with the forms most nearly allied to it. Instead of keeping a catalogue of the species contained in the herbarium, which, owing to the constant additions, would be almost impossible, such species are usually ticked off with a pencil in the systematic work which is followed in arranging them, so that by reference to this work it is possible to see at a glance whether the specimen sought is in the herbarium and what species are still wanted.

Specimens intended for the herbarium should be collected when possible in dry weather, care being taken to select plants or portions of plants in sufficient number and of a size adequate to illustrate all the characteristic features of the species. When the root-leaves and roots present any peculiarities, they should invariably be collected, but the roots should be dried separately in an oven at a moderate heat. Roots and fruits too bulky to be placed on the sheet of the herbarium may be conveniently arranged in glass-covered boxes contained in drawers. The best and most effective mode of drying specimens is learned only by experience, different species requiring special treatment according to their several peculiarities. The chief points to be attended to are to have a plentiful supply of botanical drying paper, so as to be able to use about six sheets for each specimen; to change the paper at intervals of six to twelve hours; to avoid contact of one leaf or flower with another; and to increase the pressure applied only in proportion to the dryness of the specimen. To preserve the colour of flowers pledgets of cotton wool, which prevent bruising, should be introduced between them, as also, if the stems are thick and succulent, as in *Digitalis*, between these and the corolla. A flower dissected and gummed on the sheets will often retain the colour which it is impossible to preserve in a crowded inflorescence. A flat sheet of lead or some other suitable weight should be laid upon the top of the pile of specimens, so as to keep up a continuous pressure. Succulent specimens, as many of the *Orchidaceae* and sedums and various other *Crassulaceae* plants, require to be killed by immersion in boiling water before being placed in drying paper, or, instead of becoming dry, they will grow between the sheets. When, as with some plants like *Verbascum*, the thick hard stems are liable to cause the leaves to wrinkle in drying by removing the pressure from them, small pieces of bibulous paper or cotton wool may be placed upon the leaves near their point of attachment to the stem. When a number of specimens have to be submitted to pressure, ventilation is secured by means of frames corresponding in size to the drying paper, and composed of strips of wood or wires laid across each other so as to form a kind of network. Another mode of drying is to keep the specimens in a box of dry sand in a warm place for ten or twelve hours, and then press them in drying paper. A third method consists in placing the specimen within bibulous paper, and enclosing the whole between two plates of coarsely perforated zinc supported in a wooden frame. The zinc plates are then drawn close together by means of straps, and suspended before a fire until the drying is effected. By the last two methods the colour of the flowers may be well preserved. When the leaves are finely divided, as in *Cotinus*, much trouble will be experienced in lifting a half-dried specimen from one paper to another; but the plant may be placed in a sheet of thin blotting paper, and the sheet containing the plant, instead of the plant itself, can then be moved. Thin straw-coloured paper, such as is used for biscuit bags, may be conveniently employed by travellers unable to carry a quantity of

fibulous paper. It offers the advantage of fitting closely to thick-stemmed specimens and of rapidly drying. A light but strong portfolio, to which pressure by means of straps can be applied, and a few quires of this paper, if the paper be changed night and morning, will be usually sufficient to dry all except very succulent plants. When a specimen is too large for one sheet, and it is necessary, in order to show its habit, &c., to dry the whole of it, it may be divided into two or three portions, and each placed on a separate sheet for drying. Specimens may be judged to be dry when they no longer cause a cold sensation when applied to the cheek, or assume a rigidity not evident in the earlier stages of preparation.

Each class of flowerless or cryptogamic plants requires special treatment for the herbarium.

Marine algae are usually mounted on tough smooth white cartridge paper in the following manner. Growing specimens of good colour and in fruit are if possible selected, and cleansed as much as practicable from adhering foreign particles, either in the sea or a rocky pool. Some species rapidly change colour, and cause the decay of any others with which they come in contact. This is especially the case with the *Ectocarpus*, *Desmarestia*, and a few others, which should therefore be brought home in a separate vessel. In mounting, the specimen is floated out in a flat white dish containing sea-water, so that foreign matter may be detached, and a piece of paper of suitable size is placed under it, supported either by the fingers of the left hand or by a palette. It is then pruned, in order clearly to show the mode of branching, and is spread out as naturally as possible with the right hand. For this purpose a bone knitting-needle answers well for the coarse species, and a camel's-hair pencil for the more delicate ones. The paper with the specimen is then carefully removed from the water by sliding it over the edge of the dish so as to drain it as much as possible. If during this process part of the fronds run together, the beauty of the specimen may be restored by dipping the edge into water, so as to float out the part and allow it to subside naturally on the paper. The paper, with the specimen upwards, is then laid on bibulous paper for a few minutes to absorb as much as possible of the superfluous moisture. When freed from excess of water it is laid on a sheet of thick white blotting-paper, and a piece of smooth washed calico is placed upon it (unwashed calico, on account of its "facing," adheres to the sea-weed). Another sheet of blotting-paper is then laid over it; and, a number of similar specimens being formed into a pile, the whole is submitted to pressure, the paper being changed every hour or two at first. The pressure is increased, and the papers are changed less frequently as the specimens become dry, which usually takes place in thirty-six hours. Some species, especially those of a thick or leathery texture, contract so much in drying that without strong pressure the edges of the paper become puckered. Other species of a gelatinous nature, like *Nematium* and *Dudresnaya*, may be allowed to dry on the paper, and need not be submitted to pressure until they no longer present a gelatinous appearance. Large coarse algae, such, for instance, as the *Fucales* and *Laminariae*, do not readily adhere to paper, and require soaking for some time in fresh water before being pressed. The less robust species, such as *Sphaerularia scoparia*, which do not adhere well to paper, may be made to do so by brushing them over either with milk carefully skimmed, or with a liquid formed by placing isinglass (1 oz.) and water (1 oz.) in a wide-mouthed bottle, and the bottle in a small glue-pot or sauceron containing cold water, heating until solution is effected, and then adding 1 oz. of rectified spirits of wine; the whole is next stirred together, and when cold is kept in a stoppered bottle. For use, the mixture is warmed to render it fluid, and applied by means of a camel's hair brush to the under side of the specimen, which is then laid neatly on paper. For the more delicate species, such as the *Callithamnion* and *Ectocarpus*, it is an excellent plan to place a small fruiting fragment, carefully floated out in water, on a slip of mica of the size of an ordinary microscopical slide, and allow it to dry. The plant can then be at any time examined under the microscope without injuring the mounted specimen. Many of the fresh-water algae which form a mere crust, such as *Palmella cruenta*, may be placed in a vessel of water, where after a time they float like a scum, the earthy matter settling down to the bottom, and may then be mounted by slipping a piece of mica under them and allowing it to dry. *Oscillatoria* may be mounted by laying a portion on a silver coin placed on a piece of paper in a plate, and pouring in water until the edge of the coin is just covered. The alga by its own peculiar movement will soon form a radiating circle, perfectly free from dirt, around the coin, which may then be removed. There is considerable difficulty in removing mounted specimens of algae from paper, and therefore a small portion preserved on mica should accompany each specimen, enclosed for safety in a small envelope fastened at one corner of the sheet of paper. Filamentous diatoms may be mounted like ordinary seaweeds, and, as well as all parasitic algae, should whenever possible be allowed to remain attached to portion of the alga on which they grow, some species being almost always found found parasitical on particular plants. Ordinary diatoms and desmids may be mounted on mica, as above described, by putting a portion in a vessel of water and exposing it to sunlight, when they rise to the surface, and may be thus removed comparatively free from dirt or impurity. Owing to their want of adhesiveness, they are, however, usually mounted on glass as microscopic slides, either in glycerin jelly, Canada balsam or some other suitable medium.

Lichens are generally mounted on sheets of paper of the ordinary size, several specimens from different localities being laid upon one sheet, each specimen having been first placed on a small square of paper which is gummed on the sheet, and which has the locality, date, name of collector, &c., written upon it. This mode has some disadvantages attending it; such sheets are difficult to handle; the crustaceous species are liable to have their surfaces rubbed; the foliaceous species become so compressed as to lose their characteristic appearance; and the spaces between the sheets caused by the thickness of the specimen permit the entrance of dust. A plan which has been found to answer well is to arrange them in cardboard boxes, either with glass tops or in sliding covers, in drawers—the name being placed outside each box and the specimens gummed into the boxes. Lichens for the herbarium should, whenever possible, be sought for on a slaty or laminated rock, so as to procure them on flat thin pieces of the same, suitable for mounting. Specimens on the bark of trees require pressure until the bark is dry, lest they become curled; and those growing on sand or friable soil, such as *Coniocybe furfuracea*, should be laid carefully on a layer of gum in the box in which they are intended to be kept. Many lichens, such as the *Verrucariae* and *Collemae*, are found in the best condition during the winter months. In mounting collemas it is advisable to let the specimen become dry and hard, and then to separate a portion from adherent mosses, earth, &c., and mount it separately so as to show the branching of the thallus. *Pertusariae* should be represented by both fruiting and sorediate specimens.

The larger species of fungi, such as the *Agaricini* and *Polyporei*, &c., are prepared for the herbarium by cutting a slice out of the centre of the plant so as to show the outline of the cap or pileus, the attachment of the gills, and the character of the interior of the stem. The remaining portions of the pileus are then lightly pressed, as well as the central slices, between bibulous paper until dry, and the whole is then "poisoned," and gummed on a sheet of paper in such a manner as to show the under surface of the one and the upper surface of the other half of the pileus on the same sheet. A "map" of the spores should be taken by separating a pileus and placing it flat on a piece of thin paper for a few hours when the spores will fall and leave a nature print of the arrangement of the gills which may be fixed by gumming the other side of the paper. As it is impossible to preserve the natural colours of fungi, the specimens should, whenever possible, be accompanied by a coloured drawing of the plant. Microscopic fungi are usually preserved in envelopes, or simply attached to sheets of paper or mounted as microscopic slides. Those fungi which are of a dusty nature, and the *Myxomycetes* or *Mycelozoa* may, like the lichens, be preserved in small boxes and arranged in drawers. Fungi under any circumstances form the least satisfactory portion of an herbarium.

Mosses when growing in tufts should be gathered just before the capsules have become brown, divided into small flat portions, and pressed lightly in drying paper. During this process the capsules ripen, and are thus obtained in a perfect state. They are then preserved in envelopes attached to a sheet of paper of the ordinary size, a single perfect specimen being washed, and spread out under the envelope so as to show the habit of the plant. For attaching it to the paper a strong mucilage of gum tragacanth, or for attaching an eighth of its weight of spirit of wine, answers best. If not preserved in an envelope the calyptra and operculum are very apt to fall off and become lost. Scale-mosses are mounted in the same way, or may be floated out in water like sea-weeds, and dried in white blotting paper under strong pressure before gumming on paper, but are best mounted as microscopic slides, care being taken to show the stipules. The specimens should be collected when the capsules are just appearing above or in the colesule or calyx; if kept in a damp saucer they soon arrive at maturity, and can then be mounted in better condition, the fruit-stalks being too fragile to bear carriage in a botanical tin case without injury.

Of the *Characeae* many are so exceedingly brittle that it is best to float them out like sea-weeds, except the prickly species, which may be carefully laid out on bibulous paper, and when dry fastened on sheets of white paper by means of gummed strips. Care should be taken in collecting charae to secure, in the case of dioecious species, specimens of both forms, and also to get when possible the roots of those species on which the small granular starchy bodies or gemmae are found, as in *C. fragifera*. Portions of the fructification may be preserved in small envelopes attached to the sheets.

HERBART, JOHANN FRIEDRICH (1776-1841), German philosopher and educationist, was born at Oldenburg on the 4th of May 1776. After studying under Fichte at Jena he gave his first philosophical lectures at Göttingen in 1805, whence he removed in 1809 to occupy the chair formerly held by Kant at Königsberg. Here he also established and conducted a seminary of pedagogy till 1833, when he returned once more to Göttingen, and remained there as professor of philosophy till his death on the 14th of August 1841.

Philosophy, according to Herbart, begins with reflection upon our empirical conceptions, and consists in the reformation and elaboration of these—its three primary divisions being determined by an

many distinct forms of elaboration. Logic, which stands first, has to render our conceptions and the judgments and reasonings arising from them clear and distinct. But some conceptions are such that the more distinct they are made the more contradictory their elements become; so to change and supplement these as to make them at length thinkable is the problem of the second part of philosophy, or metaphysics. There is still a class of conceptions requiring more than a logical treatment, but differing from the last in not involving latent contradictions, and in being independent of the reality of their objects, the conceptions, viz. that embody our judgments of approval and disapproval; the philosophic treatment of these conceptions falls to Aesthetic.

In Herbart's writings logic receives comparatively meagre notice; he insisted strongly on its purely formal character, and expressed himself in the main at one with Kantians such as Fries and Krug.

As a metaphysician he starts from what he terms "the higher scepticism" of the Hume-Kantian sphere of thought, the beginnings of which he discerns in Locke's perplexity about the idea of substance. By this scepticism the real validity of even the forms of experience is called in question on account of the contradictions they are found to involve. And yet that these forms are "given" to us, as truly as sensations are, follows beyond doubt when we consider that we are as little able to control the one as the other. To attempt at this stage a psychological inquiry into the origin of these conceptions would be doubly a mistake; for we should have to use these unlegitimated conceptions in the course of it, and the task of clearing up their contradictions would still remain, whether we succeeded in our enquiry or not. But how are we to set about this task? We have given to us a conception A uniting among its constituent marks two that prove to be contradictory, say M and N; and we can neither deny the unity nor reject one of the contradictory members. For to do either is forbidden by experience; and yet to do nothing is forbidden by logic. We are thus driven to the assumption that the conception is contradictory because incomplete; but how are we to supplement it? What we have must point the way to what we want, or our procedure will be arbitrary. Experience asserts that M is the same (i.e. a mark of the same concept) as N, while logic denies it; and so—it being impossible for one and the same M to sustain these contradictory positions—there is but one way open to us; we must posit several Ms. But even now we cannot say one of these Ms is the same as N, another is not; for every M must be both thinkable and valid. We may, however, take the Ms not singly but together; and again, no other course being open to us, this is what we must do; we must assume that N results from a combination of Ms. This is Herbart's method of relations, the counterpart in his system of the Hegelian dialectic.

In the *Ontology* this method is employed to determine what in reality corresponds to the empirical conceptions of substance and cause, or rather of inference and change. But first we must analyse this notion of reality itself, to which our scepticism had already led us, for, though we could doubt whether "the given" is what it appears, we cannot doubt that it is something; the conception of the real thus consists of the two conceptions of being and quality. That which we are compelled to "posit," which cannot be sublated, is that which is, and in the recognition of this lies the simple conception of being. But when is a thing thus posited? When it is posited as we are wont to posit the things we see and taste and handle. If we were without sensations, i.e. were never bound against our will to endure the persistence of a presentation, we should never know what being is. Keeping fast hold of this idea of absolute position, Herbart leads us next to the quality of the real. (1) This must exclude everything negative; for non-A sublates instead of positing, and is not absolute, but relative to A. (2) The real must be absolutely simple; for if it contain two determinations, A and B, then either these are reducible to one, which is the true quality, or they are not, when each is conditioned by the other and their position is no longer absolute. (3) All quantitative conceptions are excluded, for quantity implies parts, and these are incompatible with simplicity. (4) But there may be a plurality of "reals," albeit the mere conception of being can tell us nothing as to this. The doctrine here developed is the first cardinal point of Herbart's system, and has obtained for it the name of "pluralistic realism."

The contradictions he finds in the common-sense conception of inference, or of "a thing with several attributes," will now become obvious. Let us take some thing, say A, having n attributes, a, b, c, \dots ; we are forced to posit each of these because each is presented in intuition. But in conceiving A we make, not n positions, still less $n+1$ positions, but one position simply; for common sense removes the absolute position from its original source, sensation. So when we ask, What is the one posited? we are told—the possessor of a, b, c, \dots , or in other words, their seat or substance. But if so, then A, as a real, being simple, must = a ; similarly it must = b ; and so on. Now this would be possible if a, b, c, \dots were but "contingent aspects" of A, as e.g. $2^1, \sqrt{64}, 4+3+1$ are contingent aspects of 8. Such, of course, is not the case, and so we have as many contradictions as there are attributes; for we must say A is a , is not a , is b , is not b , &c. There must then, according to the method of relations, be several As. For a let us assume $A_1+A_2+A_3, \dots$; for $b, A_2+A_3+A_4, \dots$; and so on for the rest. But now what relation can there be among these several As, which will restore to us

the unity of our original A or substance? There is but one: we must assume that the first A of every series is identical, just as the centre is the same point in every radius. By way of concrete illustration Herbart instances "the common observation that the properties of things exist only under external conditions. Bodies, we say, are coloured, but colour is nothing without light, and nothing without eyes. They sound, but only in a vibrating medium, and for healthy ears. Colour and tone present the appearance of inherence, but on looking closer we find they are not really immanent in things but rather presuppose a communion among several." The result then is briefly thus: In place of the one absolute position, which in some unthinkable way the common understanding substitutes for the absolute positions of the n attributes, we have really a series of two or more positions for each attribute, every series, however, beginning with the same (as it were, central) real (hence the unity of substance in a group of attributes), but each being continued by different reals (hence the plurality and difference of attributes in unity of substance). Where there is the appearance of inference, therefore, there is always a plurality of reals; no such correlative to substance as attribute or accident can be admitted at all. Substantiality is impossible without causality, and to this as its true correlative we now turn.

The common-sense conception of change involves at bottom the same contradiction of opposing qualities in one real. The same A that was a, b, c, \dots becomes a, b, d, \dots ; and this, which experience thrusts upon us, proves on reflection unthinkable. The metaphysical supplementing is also fundamentally as before. Since c depended on a series of reals $A_1+A_2+A_3, \dots$ in connexion with A, and d may be said similarly to depend on a series $A_1+A_2+A_3, \dots$ then the change from c to d means, not that the central real A or any real has changed, but that A is now in connexion with $A_1, \&c.,$ and no longer in connexion with $A_2, \&c.$

But to think a number of reals "in connexion" (*Zusammensein*) will not suffice as an explanation of phenomena; something or other must happen when they are in connexion; what is it? The answer to this question is the second hinge-point of Herbart's theoretical philosophy. What "actually happens" as distinct from all that seems to happen, when two reals A and B are together is that, assuming them to differ in quality, they tend to disturb each other to the extent of that difference, at the same time that each preserves itself intact by resisting, as it were, the other's disturbance. And so by coming into connexion with different reals the "self-preserved" of A will vary accordingly, A remaining the same through all; just as, by way of illustration, hydrogen remains the same in water and in ammonia, or as the same line may be now a normal and now a tangent. But to indicate this opposition in the qualities of the reals $A+B$, we must substitute for these symbols others, which, though only "contingent aspects" of A and B, i.e. representing their relations, not themselves, yet like similar devices in mathematics enable thought to advance. Thus we may put $A = a+\beta-\gamma, B = \alpha+\eta+\zeta$; γ then represents the character of the self-preservation in this case, and $a+\beta-\eta+\zeta$ represents all that could be observed by a spectator who did not know the simple qualities, but was himself involved in the relations of A to B; and such is exactly our position.

Having thus determined what really is and what actually happens, our philosopher proceeds next to explain synthetically the objective semblance (*der objective Schein*) that results from these. But if this construction is to be truly objective, i.e. valid for all intelligences, ontology must furnish us with a clue. This we have in the forms of Space, Time and Motion which are involved whenever we think the reals as being in, or coming into, connexion and the opposite. These forms then cannot be merely the products of our psychological mechanism, though they may turn out to coincide with these. Meanwhile let us call them "intelligible," as being valid for all who comprehend the real and actual by thought, although no such forms are predicable of the real and actual themselves. The elementary spatial relation Herbart conceives to be "the contiguity (*Aneinander*) of two points," so that every "pure and independent line" is discrete. But an investigation of dependent lines which are often incommensurable forces us to adopt the contradictory fiction of partially overlapping, i.e. divisible points, or in other words, the conception of Continuity.¹ But the contradiction here is one we cannot eliminate by the method of relations, because it does not involve anything real; and in fact as a necessary outcome of an "intelligible" form, the fiction of continuity is valid for the "objective semblance," and no more to be discarded than say $\sqrt{-1}$. By its help we are enabled to comprehend what actually happens among reals to produce the appearance of matter. When three or more reals are together, each disturbance and self-preservation will (in general) be imperfect, i.e. of less intensity than when only two reals are together. But "objective semblance" corresponds with reality; the spatial or external relations of the reals in this case must, therefore, tally with their inner or actual states. Had the self-pervations been perfect, the coincidence in space would have been complete, and the group of reals would have been intertended; or had the several reals been simply contiguous, i.e. without connexion, then, as nothing

¹ Hence Herbart gave the name *Synechology* to this branch of metaphysics, instead of the usual one, *Cosmology*.

would actually have happened, nothing would appear. As it is we shall find a continuous molecule manifesting attractive and repulsive forces; attraction corresponding to the tendency of the self-preservation to become perfect, repulsion to the frustration of this. Motion, even more evidently than space, implicates the contradictory conception of continuity, and cannot, therefore, be a real predicate, though valid as an intelligible form and necessary to the comprehension of the objective semblance. For we have to think of the reals as absolutely independent and yet as entering into conceptions. This we can only do by conceiving them as originally moving through intelligible space in rectilinear paths and with uniform velocities. For such motion no cause need be supposed; motion, in fact, is no more a state of the moving real than rest is, both alike being but relations, with which, therefore, the real has no concern. The changes in this motion, however, for which we should require a cause, would be the objective semblance of the self-pervations that actually occur when reals meet. Further, by means of such motion these actual occurrences, which are in themselves timeless, fall for an observer in a definite time—a time which becomes continuous through the partial coincidence of events.

But in all this it has been assumed that we are spectators of the objective semblance; it remains to make good this assumption, or, in other words, to show the possibility of knowledge; this is the problem of what Herbert terms Eidology, and forms the transition from metaphysics to psychology. Here, again, a contradictory conception blocks the way, that, viz. of the Ego as the identity of knowing and being, and as such the stronghold of idealism. The contradiction becomes more evident when the ego is defined to be a subject (and so a real) that is its own object. As real and not merely formal, this conception of the ego is amenable to the method of relations. The solution this method furnishes is summarily that there are several objects which mutually modify each other, and so constitute that ego we take for the presented real. But to explain this modification is the business of psychology; it is enough now to see that the subject like all reals is necessarily unknown, and that, therefore, the idealist's theory of knowledge is unsound. But though the simple quality of the subject or soul is beyond knowledge, we know what actually happens when it is in connexion with other's reals, for its self-pervations then are what we call sensations. And these sensations are the sole material of our knowledge; but they are not given to us as a chaos but in definite groups and series, whence we come to know the relations of those reals, which, though themselves unknown, our sensations compel us to posit absolutely.

In his *Psychology* Herbert rejects altogether the doctrine of mental faculties as one refuted by his metaphysics, and tries to show that all psychical phenomena whatever result from the action and interaction of elementary ideas or presentations (*Vorstellungen*). The soul being one and simple, its separate acts of self-preservation or primary presentations must be simple too, and its several presentations must become united together. And this they can do at once and completely when, as is the case, for example, with the several attributes of an object, they are not of opposite quality. But otherwise there ensues a conflict in which the opposed presentations comport themselves like forces and mutually suppress or obscure each other. The act of presentation (*Vorstellen*) then becomes partly transformed into an effort, and its product, the idea, becomes in the same proportion less and less intense till a position of equilibrium is reached; and then at length the remainders coalesce. We have thus a statics and a mechanics of mind which investigate respectively the conditions of equilibrium and of movement among presentations. In the statics two magnitudes have to be determined: (1) the amount of the suppression or inhibition (*Hemmungssumme*), and (2) the ratio in which this is shared among the opposing presentations. The first must obviously be as small as possible; thus for two totally-opposed presentations a and b , of which a is the greater, the *inhibendum* = b . For a given degree of opposition this burden will be shared between the conflicting presentations in the inverse ratio of their strength. When its remainder after inhibition = 0, a presentation is said to be on the threshold of consciousness, for on a small diminution of the inhibition the "effort" will become actual presentation in the same proportion. Such total exclusion from consciousness is, however, manifestly impossible with only two presentations,¹ though with three or a greater number the residual value of one may even be negative. The first and simplest law in psychological mechanics relates to the "sinking" of inhibited presentations. As the presentations yield to the pressure, the pressure itself diminishes, so that the velocity of sinking decreases, i.e. we have the equation $(S - a) dt = da$, where S is the total *inhibendum*, and a the intensity actually inhibited after the time t . Hence $t = \log \frac{S}{S-a}$, and $a = S(1 - e^{-t})$. From this law it follows, for example, that equilibrium is never quite obtained for those presentations which continue above the threshold of consciousness, while the rest

¹ Thus, taking the case above supposed, the share of the *inhibendum* falling to the smaller presentation b is the fourth term of the proportion $a+b : a :: b : \frac{ab}{a+b}$; and so b 's remainder is $b - \frac{ab}{a+b} = \frac{b^2}{a+b}$ which only = 0 when $a = \infty$.

which cannot so continue are very speedily driven beyond the threshold. More important is the law according to which a presentation freed from inhibition and rising anew into consciousness tends to raise the other presentations with which it is combined. Suppose two presentations ρ and π united by the residua r and ρ ; then the amount of ρ 's "help" to π is r , the portion of which appropriated by π is given by the ratio $\rho : \pi$; and thus the initial help is $\frac{r\rho}{\pi}$.

But after a time t , when a portion of ρ represented by ω has been actually brought into consciousness, the help afforded in the next instant will be found by the equation

$$\frac{r\rho}{\pi} \cdot \frac{\rho - \omega}{\rho} dt = d\omega,$$

from which by integration we have the value of ω .

$$\omega = \rho \left(1 - e^{-\frac{r\rho}{\pi} t} \right)$$

So that if there are several ρ 's connected with π by smaller and smaller parts, there will be a definite "serial" order in which they will be revived by π ; and on this fact Herbert rests all the phenomena of the so-called faculty of memory, the development of spatial and temporal forms and much besides. Emotions and volitions, he holds, are not directly self-pervations of the soul, as our presentations are, but variable states of such presentations resulting from their interaction when above the threshold of consciousness. Thus when some presentations tend to force a presentation into consciousness, and others at the same time tend to drive it out, that presentation is the seat of painful feeling; when, on the other hand, its entrance is favoured by all, pleasure results. Desires are presentations struggling into consciousness against hindrances, and when accompanied by the supposition of success become volitions. Transcendental freedom of will in Kant's sense is an impossibility. Self-consciousness is the result of an interaction essentially the same in kind as that which takes place when a comparatively simple presentation finds the field of consciousness occupied by a long-formed and well-consolidated "mass" of presentations—as, e.g. one's business or garden, the theatre, &c., which promptly inhibit the isolated presentation if incongruent, and unite it to themselves if not. What we call Self is, above all, such a central mass, and Herbert seeks to show with great ingenuity and detail how this position is occupied at first chiefly by the body, then by the seat of ideas and desires, and finally by that first-personal Self which recollects the past and resolves concerning the future. But at any stage the actual constituents of this "complexion" are variable; the concrete presentation of Self is never twice the same. And, therefore, finding on reflection any particular concrete factor contingent, we abstract the position from that which occupies it, and so reach the speculative notion of the pure Ego.

Aesthetics elaborates the "ideas" involved in the expression of taste called forth by those relations of object which acquire for them the attribution of beauty or the reverse. The beautiful (*schön*) is to be carefully distinguished from the allied conceptions of the useful and the pleasant, which vary with time, place and person; whereas beauty is predicated absolutely and involuntarily by all who have attained the right standpoint. Ethics, which is but one branch of aesthetics, although the chief, deals with such relations among volitions (*Willensverhältnisse*) as thus unconditionally please or displease. These relations Herbert finds to be reducible to five, which do not admit of further simplification; and corresponding to them are as many moral ideas (*Moralbegriffe*), viz.: (1) *Internal Freedom*, the underlying relation being that of the individual's will to his judgment of it; (2) *Perfection*, the relation being that of his several volitions to each other in respect of intensity, variety and concentration; (3) *Benevolence*, the relation being that between his own will and the thought of another's; (4) *Right*, in case of actual conflict with another; and (5) *Retribution or Equity*, for intended good or evil done. The ideas of a final society, a system of rewards and punishments, a system of administration, a system of culture and a "unanimated society," corresponding to the ideas of law, equity, benevolence, perfection and internal freedom respectively, result when we take account of a number of individuals. Virtue is the perfect conformity of the will with the moral ideas; of this the single virtues are but special expressions. The conception of duty arises from the existence of hindrances to the attainment of virtue. A general scheme of principles of conduct is possible, but the assumption of special cases under these must remain matter of tact. The application of ethics to things as they are with a view to the realization of the moral ideas is moral technology (*Tugendlehre*), of which the chief divisions are Paedagogy and Politics.

In *Theology* Herbert held the argument from design to be as valid for divine activity as for human, and to justify the belief in a super-sensible real, concerning which, however, exact knowledge is neither attainable nor on practical grounds desirable.

Among the post-Kantian philosophers Herbert doubtless ranks next to Hegel in importance, and this without taking into account his very great contributions to the science of education. His disciples speak of theirs as the "exact philosophy," and the term well expresses their master's chief excellence and the character of

the chief influence he has exerted upon succeeding thinkers of his own and other schools. His criticisms are worth more than his constructions; indeed for exactness and penetration of thought he is quite on a level with Hume and Kant. His merits in this respect, however, can only be appraised by the study of his works at first hand. But we are most of all indebted to Herbart for the enormous advance psychology has been enabled to make, thanks to his fruitful treatment of it, albeit as yet but few among the many who have appropriated and improved his materials have ventured to adopt his metaphysical and mathematical foundations. (J. W.*)

BIBLIOGRAPHY.—Herbart's works were collected and published by his disciple G. Hartenstein (Leipzig, 1850-1852; reprinted at Hamburg, with supplementary volume, 1883-1893); another edition by K. Kehrbach (Leipzig, 1882, and Langensalza, 1887). The following are the most important: *Allgemeine Pädagogik* (1806; new ed., 1804); *Hauptpunkte der Metaphysik* (1808); *Allgemeine praktische Philosophie* (1808); *Lehrbuch zur Einleitung in die Philosophie* (1813; new ed. by Hartenstein, 1883); *Lehrbuch der Psychologie* (1816; new ed. by Hartenstein, 1887); *Psychologie als Wissenschaft* (1824-1825); *Allgemeine Metaphysik* (1828-1829); *Encyclopädie der Philosophie* (2nd ed., 1841); *Umriss pädagogischer Vorlesungen* (2nd ed., 1841); *Psychologische Untersuchungen* (1839-1840).

Some of his works have been translated into English under the following titles: *Textbook in Psychology*, by M. K. Smith (1891); *The Science of Education and the Aesthetic Revelation of the World* (1892), and *Letters and Lectures on Education* (1898), by H. M. and E. Felkin; *A B C of Sense Perception and minor pedagogical works* (New York, 1896), by W. J. Eckhoff and others; *Application of Psychology to the Science of Education* (1898), by B. C. Mulliner; *Outlines of Educational Doctrine*, by A. F. Lange (1901).

There is a life of Herbart in Hartenstein's introduction to his *Kleinere philosophische Schriften und Abhandlungen* (1842-1843) and by F. H. T. Allin in *Zeitschrift für exacte Philosophie* (Leipzig, 1861), the organ of Herbart and his school, which ceased to appear in 1873. In America the National Society for the Scientific Study of Education was originally founded as the National Herbart Society.

Of the large number of writings dealing with Herbart's works and theories, the following may be mentioned: H. A. Fechner, *Zur Kritik der Grundlagen von Herbart's Metaphysik* (Leipzig, 1853); J. Kalfan, *Sollen und Sein in ihrem Verhältnis zu einander: eine Studie zur Kritik Herbart's* (Leipzig, 1872); M. W. Drobisch, *Über die Fortbildung der Philosophie durch Herbart* (Leipzig, 1876); K. S. Just, *Die Fortbildung der Kant'schen Ethik durch Herbart* (Eisenach, 1876); C. Ufer, *Vorschule der Pädagogik Herbart's* (1883; Eng. tr. by J. C. Zinser, 1895); G. Kozle, *Die pädagogische Schule Herbart's und ihre Lehre* (Gutersloh, 1889); L. Strümpell, *Das System der Pädagogik Herbart's* (Leipzig, 1894); J. Christinger, *Herbart's Erziehungslehre und ihre Vorbildner* (Zurich, 1895); O. H. Lang, *Outline of Herbart's Pedagogics* (1894); H. M. and E. Felkin, *Introduction to Herbart's Science and Practice of Education* (1895); C. de Garmo, *Herbart and the Herbartians* (New York, 1895); E. Wagner, *Die Praxis der Herbartianer* (Langensalza, 1897) and *Vollständige Darstellung der Lehre Herbart's* (ib., 1899); J. Adams, *The Herbartian Psychology applied to Education* (1897); F. H. Hayward, *The Student's Herbart* (1902); *The Critics of Herbartianism* (1903); *Three Historical Educators: Pestalozzi, Froebel, Herbart* (1903); *The Secret of Herbart* (1907); *The Meaning of Education as interpreted by Herbart* (1907); W. Kinkel, *J. F. Herbart: sein Leben und seine Philosophie* (1903); A. Darroch, *Herbart and the Herbartian Theory of Education* (1903); C. J. Dodd, *Introduction to the Herbartian Principles of Teaching* (1904); J. Davidson, *A new Interpretation of Herbart's Psychology and Educational Theory through the Philosophy of Leibnitz* (1906); see also J. M. Baldwin, *Dictionary of Psychology and Philosophy* (1901-1905).

HERBELOT DE MOLAINVILLE, BARTHÉLEMY D' (1625-1695), French orientalist, was born on the 14th of December 1625 at Paris. He was educated at the university of Paris, and devoted himself to the study of oriental languages, going to Italy to perfect himself in them by converse with the orientals who frequented its sea-ports. There he also made the acquaintance of Holstenius, the Dutch humanist (1596-1661), and Leo Allatius, the Greek scholar (1586-1669). On his return to France after a year and a half, he was received into the house of Fouquet, superintendent of finance, who gave him a pension of 1500 livres. Losing this on the disgrace of Fouquet in 1661, he was appointed secretary and interpreter of Eastern languages to the king. A few years later he again visited Italy, when the grand-duke Ferdinand II. of Tuscany presented him with a large number of valuable Oriental MSS., and tried to attach him to his court. Herbelot, however, was recalled to France by Colbert, and received from the king a pension equal to the one he had lost. In 1692 he succeeded D'Auvergne in the chair of Syriac, in the Collège de France. He died in Paris on the 8th of December 1695. His great work is the *Bibliothèque orientale,*

ou dictionnaire universel contenant tout ce qui regarde la connaissance des peuples de l'Orient, which occupied him nearly all his life, and was completed in 1697 by A. Galland. It is based on the immense Arabic dictionary of Hadji Khalifa, of which indeed it is largely an abridged translation, but it also contains the substance of a vast number of other Arabic and Turkish compilations and manuscripts.

The *Bibliothèque* was reprinted at Maestricht (fol. 1776), and at the Hague (4 vols. 4to, 1777-1799). The latter edition is enriched with the contributions of the Dutch orientalist Schultens, Johann Jakob Reiske (1716-1774), and by a supplement provided by Visdelou and Galland. Herbelot's other works, none of which have been published, comprise an *Oriental Anthology*, and an *Arabic, Persian, Turkish and Latin Dictionary*.

HERBERAY DES ESSARTS, NICOLAS DE (d. about 1557), French translator, was born in Picardy. He served in the artillery, and at the expressed desire of Francis I. he translated into French the first eight books of *Amadis de Gaul* (1540-1548). The remaining books were translated by other authors. His other translations from the Spanish include *L'Amant maltraité de sa mye* (1539); *Le Premier Livre de la chronique de dom Floris de Grèce* (1552); and *L'Horloge des princes* (1555) from Guevara. He also translated the works of Josephus (1557). He died about 1557. The *Amadis de Gaul* was translated into English by Anthony Munday in 1619.

HERBERT (FAMILY). The sudden rising of this English family to great wealth and high place is the more remarkable in that its elevation belongs to the 15th century and not to that age of the Tudors when many new men made their way upwards into the ranks of the nobility. Earlier generations of a pedigree which carries the origin of the Herberts to Herbert the Chamberlain, a Domesday tenant, being disregarded, their patriarch may be taken to be one Jenkin ap Adam (temp. Edward III.), who had a small Monmouthshire estate at Llanvapley and the office of master sergeant of the lordship of Abergavenny, a place which gave him precedence after the steward of that lordship. Jenkin's son, Gwiliam ap Jenkin, who followed his father as master sergeant, is given six sons by the border genealogists, no less than six score pedigrees finding their origin in these six brothers. Their order is uncertain, although the Progers of Werndee, the last of whom sold his ancestral estate in 1780, are reckoned as the senior line of Gwiliam's descendants. But Thomas ap Gwiliam Jenkin, called the fourth son, is ancestor of all those who bore the surname of Herbert.

Thomas's fifth son, William or Gwiliam ap Thomas, who died in 1446, was the first man of the family to make any figure in history. This Gwiliam ap Thomas was steward of the lordships of Usk and Caerleon under Richard, duke of York. Legend makes him a knight on the field of Agincourt, but his knighthood belongs to the year 1426. He appears to have married twice, his first wife being Elizabeth Bluet of Raglan, widow of Sir James Berkeley, and his second a daughter of David Gam, a valiant Welsh squire slain at Agincourt. Royal favour enriched Sir William, and he was able to buy Raglan Castle from the Lord Berkeley, his first wife's son, the deed, which remains among the Beaufort muniments, refuting the pedigree-maker's statement that he inherited the castle as heir of his mother "Maude, daughter of Sir John Morley." His sons William and Richard, both partisans of the White Rose, took the surname of Herbert in or before 1461. Playing a part in English affairs remote from the Welsh Marches, their lack of a surname may well have inconvenienced them, and their choice of the name Herbert can only be explained by the suggestion that their long pedigree from Herbert the Chamberlain, absurdly represented as a bastard son of Henry I., must already have been discovered for them. Copies exist of an alleged commission issued by Edward IV. to a committee of Welsh bards for the ascertaining of the true ancestry of William Herbert, earl of Pembroke, whom "the chiefest men of skill" in the province of South Wales declare to be the descendant of "Herbert, a noble lord, natural son to King Henry the first," and it is recited that King Edward, after the creation of the earldom, commanded the earl and Sir Richard his brother to "take their surnames after their first progenitor

Herbert fitz Roy and to forego the British order and manner." But this commission, whose date anticipates by some years the true date of the creation of the earldom, is the work of one of the many genealogical forgers who flourished under the Tudors.

Sir William Herbert, called by the Welsh Gwiliam Ddu or Black William, was a baron in 1461 and a Knight of the Garter in the following year. With many manors and castles on the Marches he had the castle, town and lordship of Pembroke, and after the attainder of Jasper Tudor in 1468 was created earl of Pembroke. When in July 1469 he was taken by Sir John Conyers and the northern Lancastrians on Hedgecote, he was beheaded with his brother Sir Richard Herbert of Coldbrook. The second earl while still a minor exchanged at the king's desire in 1479 his earldom of Pembroke for that of Huntingdon. In 1484 this son of one whom Hall not unjustly describes as born "a mean gentleman" contracted to marry Katharine the daughter of King Richard III., but her death annulled the contract and the earl married Mary, daughter of the Earl Rivers, by whom he had a daughter Elizabeth, whose descendants, the Somersets, lived in the Herbert's castle of Raglan until the cannon of the parliament broke it in ruins. With the second earl's death in 1491 the first Herbert earldom became extinct. No claim being set up among the other descendants of the first earl, it may be taken that their lines were illegitimate. One of the chief difficulties which beset the genealogist of the Herberts lies in their Cambrian disregard of the marriage tie, bastards and legitimate issue growing up, it would seem, side by side in their patriarchal households. Thus the ancestor of the present earls of Pembroke and Carnarvon and of the Herbert who was created marquess of Powis was a natural son of the first earl, one Richard Herbert, whom the restored inscription on his tomb at Abergavenny incorrectly describes as a knight. He was constable and porter of Abergavenny Castle, and his son William, "a mad fighting fellow" in his youth, married a sister of Catherine Parr and thus in 1543 became nearly allied to the king, who made him one of the executors of his will. The earldom of Pembroke was revived for him in 1551. It is worthy of note that all traces of illegitimacy have long since been removed from the arms of the noble descendants of Richard Herbert.

The honours and titles of this clan of marchmen make a long list. They include the marquessate of Powis, two earldoms with the title of Pembroke, two with that of Powis, and the earldoms of Huntingdon and Montgomery, Torrington and Carnarvon, the viscounties of Montgomery and Ludlow, fourteen baronies and seven baronetcies. Seven Herberts have worn the Garter. The knights and rich squires of the stock can hardly be reckoned, more especially as they must be sought among Raglans, Morgans, Parrys, Vaughans, Progers, Hugheses, Thomases, Phillips, Powels, Gwyns, Evanses and Joneses, as well as among those who have borne the surname of Herbert, a surname which in the 19th century was adopted by the Joneses of Llanarth and Clytha, although they claim no descent from those sons of Sir William ap Thomas for whom it was devised. (O. BA.)

HERBERT, GEORGE (1593-1633), English poet, was born at Montgomery Castle on the 3rd of April 1593. He was the fifth son of Sir Richard Herbert and a brother of Lord Herbert of Cherbury. His mother, Lady Magdalen Herbert, a woman of great good sense and sweetness of character, and a friend of John Donne, exercised great influence over her son. Educated privately until 1605, he was then sent to Westminster School, and in 1609 he became a scholar of Trinity College, Cambridge, where he was made B.A. in 1613, M.A. and major fellow of the college in 1616. In 1618 he became Reader in Rhetoric, and in 1619 orator for the university. In this capacity he was several times brought into contact with King James. From Cambridge he wrote some Latin satiric verses¹ in defence of the universities and the English Church against Andrew Melville, a Scottish Presbyterian minister. He numbered among his friends Dr

¹Printed in 1662 as an appendix to J. Vivian's *Ecclesiastes Solomonis*.

Donne, Sir Henry Wotton, Izaak Walton, Bishop Andrewes and Francis Bacon, who dedicated to him his translation of the Psalms. Walton tells us that "the love of a court conversation, mixed with a laudable ambition to be something more than he was, drew him often from Cambridge to attend the king wheresoever the court was," and James I. gave him in 1623 the sinecure lay rectory of Whitford, Flintshire, worth £120 a year. The death of his patrons, the duke of Richmond and the marquess of Hamilton, and of King James put an end to his hopes of political preferment; moreover he probably distrusted the conduct of affairs under the new reign. Largely influenced by his mother, he decided to take holy orders, and in July 1626 he was appointed prebendary of Layton Ecclesia (Leighton Bromswold), Huntingdon. Here he was within two miles of Little Gidding, and came under the influence of Nicholas Ferrar. It was at Ferrar's suggestion that he undertook to rebuild the church at Layton, an undertaking carried through by his own gifts and the generosity of his friends. There is little doubt that the close friendship with Ferrar had a large share in Herbert's adoption of the religious life. In 1630 Charles I., at the instance of the earl of Pembroke, whose kinsman Herbert was, presented him to the living of Fugglestone with Bemerton, near Salisbury, and he was ordained priest in September. A year before, after three days' acquaintance, he had married Jane Danvers, whose father had been set on the marriage for a long time. He had often spoken of his daughter Jane to Herbert, and "so much commended Mr Herbert to her, that Jane became so much a Platonic as to fall in love with Mr Herbert unseen." The story of the poet's life at Bemerton, as told by Walton, is one of the most exquisite pictures in literary biography. He devoted much time to explaining the meaning of the various parts of the Prayer-Book, and held services twice every day, at which many of the parishioners attended, and some "let their plough rest when Mr Herbert's saints-bell rung to prayers, that they might also offer their devotions to God with him." Next to Christianity itself he loved the English Church. He was passionately fond of music, and his own hymns were written to the accompaniment of his lute or viol. He usually walked twice a week to attend the cathedral at Salisbury, and before returning home, would "sing and play his part" at a meeting of music lovers. Walton illustrates Herbert's kindness to the poor by many touching anecdotes, but he had not been three years in Bemerton when he succumbed to consumption. He was buried beneath the altar of his church on the 3rd of March 1633.

None of Herbert's English poems was published during his lifetime. On his death-bed he gave to Nicholas Ferrar a manuscript with the title *The Temple: Sacred Poems and Private Ejaculations*. This was published at Cambridge, apparently for private circulation, almost immediately after Herbert's death, and a second imprint followed in the same year. On the title-page of both is the quotation "In his Temple doth every man speak of his honour." *The Temple* is a collection of religious poems connected by unity of sentiment and inspiration. Herbert tried to interpret his own devout meditations by applying images of all kinds to the ritual and beliefs of the Church. Nothing in his own church at Bemerton was too commonplace to serve as a starting-point for the epigrammatic expression of his piety. The church key reminds him that "it is my sin that locks his hands," and the stones of the floor are patience and humility, while the cement that binds them together is love and charity. The chief faults of the book are obscurity, verbal conceits and a forced ingenuity which shows itself in grotesque puns, odd metres and occasional want of taste. But the quaint beauty of Herbert's style and its musical quality give *The Temple* a high place. "The Church Porch," "The Agony," "Sin," "Sunday," "Virtue," "Man," "The British Church," "The Quip," "The Collar," "The Pulley," "The Flower," "Aaron" and "The Elixir" are among the best known of these poems. Herbert and Keble are the poets of Anglican theology. No book is fuller of devotion to the Church of England than *The Temple*, and no poems in our language exhibit more of the spirit of true Christianity. Every page is marked by

transparent sincerity, and reflects the beautiful character of "holy George Herbert."

Nicholas Ferrar's translation (Oxford, 1638) of the *Hundred and Ten Considerations* . . . of Juan de Valdes contained a letter and notes by Herbert. In 1652 appeared *Herbert's Remains; or, Sundry Pieces of that Sweet Singer of the Temple, Mr George Herbert*. This included *A Priest to the Temple; or, The Country Parson, his Character, and Rule of Holy Life*, in prose; *Jacula prudentium*, a collection of proverbs with a separate title-page dated 1651, which had appeared in a shorter form as *Ouldandish Proverbs* in 1640; and some miscellaneous matter. The completest edition of his works is that by Dr A. B. Grosart in 1874, this edition of the Poetical works being reproduced in the "Aldine edition" in 1876. *The English Works of George Herbert* . . . (3 vols., 1905) were edited in much detail by G. H. Palmer. A contemporary account of Herbert's life by Barnabas Oley was prefixed to the *Remains* of 1652, but the classic authority is Isaac Walton's *Life of Mr George Herbert*, published in 1670, with some letters from Herbert to his mother. See also A. G. Hyde, *George Herbert and his Times* (1907), and the "Oxford" edition of his poems by A. Waugh (1908).

HERBERT, HENRY WILLIAM ["Frank Forester"] (1807-1858), English novelist and writer on sport, son of the Hon. and Rev. William Herbert, dean of Manchester, a son of the first earl of Carnarvon, was born in London on the 3rd of April 1807. He was educated at Eton and at Caius College, Cambridge, where he graduated B.A. in 1830. Having become involved in debt, he emigrated to America, and from 1831 to 1839 was teacher of Greek in a private school in New York. In 1833 he started the *American Monthly Magazine*, which he edited, in conjunction with A. D. Patterson, till 1835. In 1834 he published his first novel, *The Brothers: a Tale of the Fronde*, which was followed by a number of others which obtained a certain degree of popularity. He also wrote a series of historical studies, including *The Cavaliers of England* (1852), *The Knights of England, France and Scotland* (1852), *The Chevaliers of France* (1853), and *The Captains of the Old World* (1851); but he is best known for his works on sport, published under the pseudonym of "Frank Forester." These include *The Field Sports of the United States and British Provinces* (1849), *Frank Forester and his Friends* (1849), *The Fish and Fishing of the United States* (1850), *The Young Sportsman's Complete Manual* (1852), and *The Horse and Horsemanship in the United States and British Provinces of North America* (1858). He also translated many of the novels of Eugene Sue and Alexandre Dumas. Herbert was a man of varied accomplishments, but of somewhat dissipated habits. He died by his own hand in New York on the 17th of May 1858.

HERBERT, SIR THOMAS (1606-1682), English traveller and author, was born at York in 1606. Several of his ancestors were aldermen and merchants in that city—e.g. his grandfather and benefactor, Alderman Herbert (d. 1614)—and they traced a connexion with the earls of Pembroke. Thomas became a commoner of Jesus College, Oxford, in 1621, but afterwards removed to Cambridge, through the influence of his uncle Dr Ambrose Akroyd. In 1627 the earl of Pembroke procured his appointment in the suite of Sir Dodmore Cotton, then starting as ambassador for Persia with Sir Robert Shirley. Sailing in March they visited the Cape, Madagascar, Goa and Surat; landing at Gambun (10th of January 1627-1628), they travelled inland to Ashraf and thence to Kazvin, where both Cotton and Shirley died, and whence Herbert made extensive travels in the Persian *Hinterland*, visiting Kashan, Bagdad, &c. On his return voyage he touched at Ceylon, the Coromandel coast, Mauritius and St Helena. He reached England in 1629, travelled in Europe in 1630-1631, married in 1632 and retired from court in 1634 (his prospects perhaps blighted by Pembroke's death in 1630); after this he resided on his Tintern estate and elsewhere till the Civil War, siding with the parliament till his appointment to attend on the king in 1646. Becoming a devoted royalist, he was rewarded with a baronetcy at the Restoration (1660). He resided mainly in York Street, Westminster, till the Great Plague (1666), when he retired to York, where he died (at Petergate House) on the 1st of March 1682.

Herbert's chief work is the *Description of the Persian Monarchy now being: the Orientall Indyes, Iles and other parts of the Greater Asia and Africk* (1634), reissued with additions, &c., in 1638 as

Some Yeares Travels into Africa and Asia the Great (al. into divers parts of Asia and Afrique); a third edition followed in 1664, and a fourth in 1677. This is one of the best records of 17th-century travel. Among its illustrations are remarkable sketches of the dodo, cuneiform inscriptions and Persepolis. Herbert's *Threnodia Carolina; or, Memoirs of the two last years of the reign of that unparalleled & prince of ever blessed memory King Charles I.*, was in great part printed at the author's request in Wood's *Athenae Oxonienses*: in full by Dr C. Goodall in his *Collection of Tracts* (1702, repr. C. & W. Nicol, 1813). Sir William Dugdale is understood to have received assistance from Herbert in the *Monasticon Anglicanum*, vol. iv.; see two of Herbert's papers on St John's, Beverley and Ripon collegiate church, now cathedral, in Drake's *Eboracum* (appendix). Cf. also Robert Davies' account of Herbert in *The Yorkshire Archaeological and Topographical Journal*, part iii., pp. 182-214 (1870), containing a facsimile of the inscription on Herbert's tomb; Wood's *Athenae*, iv. 15-41; and *Fasti*, ii. 26, 131, 138, 143-144, 150.

HERBERT OF CHERBURY, EDWARD HERBERT, BARON (1583-1648), English soldier, diplomatist, historian and religious philosopher, eldest son of Richard Herbert of Montgomery Castle (a member of a collateral branch of the family of the earls of Pembroke) and of Magdalen, daughter of Sir Richard Newport, was born at Eytton-on-Severn near Wroxeter on the 3rd of March 1583. After careful private tuition he matriculated at University College, Oxford, as a gentleman commoner, in May 1596. On the 28th of February 1599 he married his cousin Mary, daughter and heiress of Sir William Herbert (d. 1593). He returned to Oxford with his wife and mother, continued his studies, and obtained proficiency in modern languages as well as in music, riding and fencing. On the accession of James I. he presented himself at court and was created a knight of the Bath on the 24th of July 1603. In 1608 he went to Paris, enjoying the friendship and hospitality of the old constable de Montmorency, and being entertained by Henry IV. On his return, as he says himself with naïve vanity, he was "in great esteem both in court and city, many of the greatest desiring my company." In 1610 he served as a volunteer in the Low Countries under the prince of Orange, whose intimate friend he became, and distinguished himself at the capture of Juliers from the emperor. He offered to decide the war by engaging in single combat with a champion chosen from among the enemy, but his challenge was declined. During an interval in the fighting he paid a visit to Spinola, in the Spanish camp near Wezel, and afterwards to the elector palatine at Heidelberg, subsequently travelling in Italy. At the instance of the duke of Savoy he led an expedition of 4000 Huguenots from Languedoc into Piedmont to help the Savoyards against Spain, but after nearly losing his life in the journey to Lyons he was imprisoned on his arrival there, and the enterprise came to nothing. Thence he returned to the Netherlands and the prince of Orange, arriving in England in 1617. In 1619 he was made by Buckingham ambassador at Paris, but a quarrel with de Luynes and a challenge sent by him to the latter occasioned his recall in 1621. After the death of de Luynes Herbert resumed his post in February 1622. He was very popular at the French court and showed considerable diplomatic ability, his chief objects being to accomplish the union between Charles and Henrietta Maria and secure the assistance of Louis XIII. for the unfortunate elector palatine. This latter advantage he could not obtain, and he was dismissed in April 1624. He returned home greatly in debt and received little reward for his services beyond the Irish peerage of Castle island in 1624 and the English barony of Cherbury, or Chirbury, on the 7th of May 1629. In 1632 he was appointed a member of the council of war. He attended the king at York in 1639, and in May 1642 was imprisoned by the parliament for urging the addition of the words "without cause" to the resolution that the king violated his oath by making war on parliament. He determined after this to take no further part in the struggle, retired to Montgomery Castle, and declined the king's summons. On the 5th of September 1644 he surrendered the castle to the parliamentary forces, returned to London, submitted, and was granted a pension of £20 a week. In 1647 he paid a visit to Cassendi at Paris, and died in London on the 20th of August 1648, being buried in the church of St Giles's in the Fields.

Lord Herbert left two sons, Richard (c. 1600-1656), who succeeded him as 2nd Lord Herbert of Cherbury, and Edward, the title becoming extinct in the person of Henry Herbert, the 4th baron, grandson of the 1st Lord Herbert in 1691. In 1694, however, it was revived in favour of Henry Herbert (1654-1700), son of Sir Henry Herbert (1595-1673), brother of the 1st Lord Herbert of Cherbury. Sir Henry was master of the revels to Charles I. and Charles II., being busily employed in reading and licensing plays and in supervising all kinds of public entertainments. He died in April 1673; his son Henry died in January 1709, when the latter's son Henry became 2nd Lord Herbert of Cherbury of the second creation. He died without issue in April 1738, and again the barony became extinct. In 1743 it was revived for Henry Arthur Herbert (c. 1703-1772), who five years later was created earl of Powis. This nobleman was a great-grandson of the 2nd Lord Herbert of Cherbury of the first creation, and since his time the barony has been held by the earls of Powis.

Lord Herbert's cousin, Sir Edward Herbert (c. 1591-1657), was a member of parliament under James I. and Charles I. Having become attorney-general he was instructed by Charles to take proceedings against some members of parliament who had been concerned in the passing of the Grand Remonstrance; the only result, however, was Herbert's own impeachment by the House of Commons and his imprisonment. Later in life he was with the exiled royal family in Holland and in France, becoming lord keeper of the great seal to Charles II., an office which he had refused in 1645. He died in Paris in December 1657. One of Herbert's sons was Arthur Herbert, earl of Torrington, and another was Sir Edward Herbert (c. 1648-1698), titular earl of Portland, who was made chief justice of the king's bench in 1685 in succession to Lord Jeffreys. It was Sir Edward who declared for the royal prerogative in the case of *Godden v. Hales*, asserting that the kings of England, being sovereign princes, could dispense with particular laws in particular cases. After the escape of James II. to France this king made Herbert his lord chancellor and created him earl of Portland, although he was a Protestant and had exhibited a certain amount of independence during 1687.

The first Lord Herbert's real claim to fame and remembrance is derived from his writings. Herbert's first and most important work is the *De veritate prout distinguitur a revelatione, a verisimili, a possibili, et a falso* (Paris, 1624; London, 1633; translated into French 1639, but never into English; a MS. in add. MSS. 7081. Another, Sloane MSS. 3957, has the author's dedication to his brother George in his own hand, dated 1622). It combines a theory of knowledge with a partial psychology, a methodology for the investigation of truth, and a scheme of natural religion. The author's method is prolix and often far from clear; the book is no compact system, but it contains the skeleton and much of the soul of a complete philosophy. Giving up all past theories as useless, Herbert professedly endeavours to constitute a new and true system. Truth, which he defines as a just conformation of the faculties with one another and with their objects, he distributed into four classes or stages: (1) truth in the thing or the truth of the object; (2) truth of the appearance; (3) truth of the apprehension (*conceptus*); (4) truth of the intellect. The faculties of the mind are as numerous as the differences of their objects, and are accordingly innumerable; but they may be arranged in four groups. The first and fundamental and most certain group is the *Natural Instinct*, to which belong the *causal veritates*, the *notitia communis*, which are innate, of divine origin and indisputable. The second group, the next in certainty, is the *sensus internus* (under which head Herbert discusses amongst others love, hate, fear, conscience with its *communis notitia*, and free will); the third is the *sensus externus*; and the fourth is *discursus*, reasoning, to which, as being the least certain, we have recourse when the other faculties fail. The ratiocinative faculties proceed by division and analysis, by questioning, and are slow and gradual in their movement; they take aid from the other faculties, those of the *instinctus naturalis* being always the final test. Herbert's categories or questions to be used in investigation are ten in number whether (a thing is), what, of what sort, how much, in what relation, how, when, whence, wherefore. No faculty, rightly used, can err "even in dreams"; badly exercised, reasoning becomes the source of almost all our errors. The discussion of the *notitia communis* is the most characteristic part of the book. The exposition of them, though highly dogmatic, is at times strikingly Kantian in substance. "So far as these elements or sacred principles from being derived from experience or observation that without some of them, or at least some one of them, we can neither experience

nor even observe." Unless we felt driven by them to explore the nature of things, "it would never occur to us to distinguish one thing from another." It cannot be said that Herbert proves the existence of the common notions; he does not deduce them or even give any list of them. But each faculty has its common notion; and they may be distinguished by six marks, their *priority, independence, universality, certainty, necessity* (for the well-being of man), and *immediacy*. Law is based on certain common notions; so is religion. Though Herbert expressly defines the scope of his book as dealing with the intellect, not faith, it is the common notions of religion he has illustrated most fully; and it is plain that it is in this part of his system that he is chiefly interested. The common notions of religion are the famous five articles, which became the charter of the English deists (see DEISM). There is little polemic against the received form of Christianity, but Herbert's attitude towards the Church's doctrine is distinctly negative, and he denies revelation except to the individual soul. In the *De religione gentium* (completed 1645, published Amsterdam, 1663, translated into English by W. Lewis, London, 1705) he gives what may be called, in Hume's words, "a natural history of religion." By examining the heathen religions Herbert finds, to his great delight, the universality of his five great articles, and that these are clearly recognizable under their absurdities as they are under the rites, ceremonies and polytheism invented by sacerdotal superstition. The same vein is maintained in the tracts *De causis errorum*, an unfinished work on logical fallacies, *Religio laici*, and *Ad sacerdotem de religione laici* (1645). In the *De veritate* Herbert produced the first purely metaphysical treatise written by an Englishman, and in the *De religione gentium* one of the earliest studies extant in comparative theology; while both his metaphysical speculations and his religious views are throughout distinguished by the highest originality and provoked considerable controversy. His achievements in historical writing are vastly inferior, and vitiated by personal aims and his preoccupation to gain the royal favour. Herbert's first historical work is the *Expeditio Buckinghami ducis* (published in a Latin translation in 1656 and in the original English by the earl of Powis for the Philobiblon Society in 1860), a defence of Buckingham's conduct of the ill-fated expedition of 1627. *The Life and Reign of King Henry VIII.* (1649) derives its chief value from its composition from original documents, but is ill-proportioned, and the author judges the character and statesmanship of Henry with too obvious a partiality.

His poems, published in 1665 (reprinted and edited by J. Churton Collins in 1881), show him in general a faithful disciple of Donne, obscure and uncouth. His satires are miserable compositions, but a few of his lyrical verses show power of reflection and true inspiration, while his use of the metre afterwards employed by Tennyson in his "In Memoriam" is particularly happy and effective. His Latin poems are evidence of his scholarship. Three of these had appeared together with the *De causis errorum* in 1645. To these works must be added *A Dialogue between a Tutor and a Pupil* (1768; a treatise on education, MS. in the Bodleian Library); a treatise on the king's supremacy in the Church (MS. in the Record Office and at Queen's College, Oxford), and his well-known autobiography, first published by Horace Walpole in 1764, a naive and amusing narrative, too much occupied, however, with his duels and amorous adventures, to the exclusion of more creditable incidents in his career, such as his contributions to philosophy and history, his intimacy with Donne, Ben Jonson, Selden and Carew, Casaubon, Gasendi and Grotius, or his embassy in France, in relation to which he only described the splendour of his retinue and his social triumphs.

BIBLIOGRAPHY.—The autobiography edited by Sidney Lee with correspondence from add. MSS. 7082 (1886); article in the *Dict. of Nat. Biog.* by the same writer and the list of authorities there collated; *Hist. MSS. Comm. Rep.* x, app. iv., 378; *Lord Herbert de Cherbury*, by Charles de Rémusat (1874); *Edward, Lord Herbert von Cherbury*, by C. Güttler (a criticism of his philosophy; 1897); *Collections Historical and Archaeological relating to Montgomeryshire*, vols. vii., xi., xx.; R. Warner's *Epistolary Curiosities*, i. ser.; Reid's works, edited by Sir William Hamilton; *National Review*, xxxv. 661 (Leslie Stephen); *Locke's Essay on Human Understanding*; Wood, *Ath. Oxon.* (Bliss), iii. 239; *Gentleman's Magazine* (1816), i. 201 (print of remains of his birthplace); *Lord Herbert's Poems*, ed. by J. Churton Collins (1881); *Aubrey's Lives of Eminent Men*; also works quoted under DEISM.

HERBERT OF LEA, SIDNEY HERBERT, 1ST BARON (1810-1861), English statesman, was the younger son of the 11th earl of Pembroke. Educated at Harrow and Oriel, Oxford, he made a reputation at the Oxford Union as a speaker, and entered the House of Commons as Conservative member for a division of Wiltshire in 1832. Under Peel he held minor offices, and in 1845 was included in the cabinet as secretary at war, and again held this office in 1852-1855, being responsible for the War Office during the Crimean difficulties, and in 1859. It was Sidney Herbert who sent Florence Nightingale out to the Crimea, and he led the movement for War Office reform after the war,

the hard work entailed causing his breakdown in health, so that in July 1861, having been created a baron, he had to resign office, and died on the 2nd of August 1861. His statue was placed in front of the War Office in Pall Mall. He was succeeded in the title by his eldest son, who later became 13th earl of Pembroke, and the barony is now merged in that earldom; his second son became 14th earl. Another son, the Hon. Michael Herbert (1857-1904), was British Ambassador at Washington in succession to Lord Pauncefoot.

A life of Lord Herbert by Lord Stanmore was published in 1906.

HERBERTON, a mining town of Cardwell county, Queensland, Australia, 55 m. S.W. of Cairns. Pop. (1901) 2806. Tin was discovered in the locality in 1879, and to this mineral the town chiefly owes its prosperity, though copper, bismuth and some silver and gold are also found. Atherton, 12 m. from the town, is served by rail from Cairns, which is the port for the Herberton district.

HERCULANEUM, an ancient city of Italy, situated about two-thirds of a mile from the Portici station of the railway from Naples to Pompeii. The ruins are less frequently visited than those of Pompeii, not only because they are smaller in extent and of less obvious interest, but also because they are more difficult of access. The history of their discovery and exploration, and the artistic and literary relics which they have yielded, are worthy, however, of particular notice. The small part of the city, which was investigated at the spot called *Gli scavi nuovi* (the new excavations) was discovered in the 19th century. But the more important works were executed in the 18th century; and of the buildings then explored at a great depth, by means of tunnels, none is visible except the theatre, the orchestra of which lies 85 ft. below the surface.

The brief notices of the classical writers inform us that Herculaneum¹ was a small city of Campania between Neapolis and Pompeii, that it was situated between two streams at the foot of Vesuvius on a hill overlooking the sea, and that its harbour was at all seasons safe. With regard to its earlier history nothing is known. The account given by Dionysius repeats a tradition which was most natural for a city bearing the name of Hercules. Strabo follows up the topographical data with a few brief historical statements—“Ὅσον εἶχον καὶ τὰ ἄλλα καὶ τὴν ἐπέκεινται Πουσάδας . . . ἐκ τῆς Τυρρηπίας καὶ Πελαγονίας, μετὰ τὰ ἄλλα Σαυίνας. But leaving the questions suggested by these names (see *ΕΡΧΥΡΙΑ*, &c.),² as well as those which relate to the origin of Pompeii (*q.v.*), it is sufficient here to say that the first historical record about Herculaneum has been handed down by Livy (viii. 25), where he relates how the city fell under the power of Rome during the Samnite wars. It remained faithful to Rome for a long time, but it joined the Italian allies in the Social War. Having submitted anew in June of the year 665 (88 B.C.), it appears to have been less severely treated than Pompeii, and to have escaped the imposition of a colony of Sulla's veterans, although Zumpt has suspected the contrary (*Comm. epigr.* i. 259). It afterwards became a municipium, and enjoyed great prosperity towards the close of the republic and in the earlier times of the empire, since many noble families of Rome selected this pleasant spot for the construction of splendid villas, one of which indeed belonged to the imperial house (Seneca, *De ira*, iii.), and another to the

¹ A fragment of L. Sisenna calls it “Oppidum tumulo in excelso loco propter mare, parvis moenibus, inter duas fluvias, infra Vesuvium collocatum” (*Ibid.* iv., fragm. 53, Peters). Of one of these rivers this historian again makes mention in the passage where probably he related the capture of Herculaneum by Minastius Magnus and T. Didius (Velleius Paterculus ii. 16). Further topographical details are supplied by Strabo, who, after speaking about Naples, continues—“Ἐξήμιστον δὲ ἀπὸ τῆς ἑστέρας ἑστὶν Ἐρкулανῶν ἑσπερίως ἐκ τῆς Πάλαστρου ἕκαστον ἔχον, καταστρέφουσιν Ἀδελφῶν ἑσπερίως ἐκ τῆς καρούρας. Dionysius of Halicarnassus relates that Hercules, in the place where he stopped with his fleet on the return voyage from Iberia, founded a little city (πόλις), to which he gave his own name; and he adds that this city was in his time inhabited by the Romans, and that, situated between Neapolis and Pompeii, it had ἑσπερίως ἐκ τῆς καρούρας (i. 44).

² See also Niebuhr, *Hist. of Rome*, i. 76, and Mommsen, *Die antike römische Dialekte* (1850), p. 314; for later discussions see *OCCA LINGUA, PELASGICANS*.

family of Calpurnius Piso. By means of the Via Campana it had easy communication north-westward with Neapolis, Puteoli and Capua, and thence by the Via Appia with Rome; and southwards with Pompeii and Nuceria, and thence with Lucania and the Bruttii. In the year A.D. 63 it suffered terribly from the earthquake which, according to Seneca, “Campaniam nunquam securam huius mali, indemnem tamen, et toties defunctam metu magna strage vastavit. Nam et Herculaneus oppidi pars ruit dubieque stant etiam quae relicta sunt” (*Nat. quaest.* vi. 1). Hardly had Herculaneum completed the restoration of some of its principal buildings (cf. Mommsen, *I.N.* n. 2384; *Catalogo del Museo Nazionale di Napoli*, n. 1151) when it fell beneath the great eruption of the year 79, described by Pliny the younger (*Ep.* vi. 16, 20), in which Pompeii also was destroyed, with other flourishing cities of Campania. According to the commonest account, on the 23rd of August of that year Pliny the elder, who had command of the Roman fleet at Misenum, set out to render assistance to a young lady of noble family named Rectina and others dwelling on that coast, but, as there was no escape by sea, the little harbour having been on a sudden filled up so as to be inaccessible, he was obliged to abandon to their fate those people of Herculaneum who had managed to flee from their houses, overwhelmed in a moment by the material poured forth by Vesuvius. But the text of Pliny the younger, where this account is given, has been subjected to various interpretations; and from the comparison of other classical testimonies and the study of the excavations it has been concluded that it is impossible to determine the date of the catastrophe, though there are satisfactory arguments to justify the statement that the event took place in the autumn. The opinion that immediately after the first outbreak of Vesuvius a torrent of lava was ejected over Herculaneum was refuted by the scholars of the 18th century, and their refutation is confirmed by Beulé (*Le Drame du Vésuve*, p. 240 seq.). And the last recessions of the passage quoted from Pliny, aided by an inscription,³ prove that Rectina cannot have been the name of the harbour described by Beulé (*ib.* pp. 122, 247), but the name of a lady who had implored succour, the wife of Caesius Bassus, or rather Tascius (cf. Pliny, ed. Keil, Leipzig, 1870; Aulus Persius, ed. Jahn, *Sat.* vi.). The shore, moreover, according to the accurate studies of the engineer Michele Ruggiero, director of the excavations, was not altered by the causes adduced by Beulé (p. 125), but by a simpler event. “It is certain,” he says (*Pompei e la regione sotterrata dal Vesuvio l'anno 79*, Naples, 1879, p. 21 seq.), “that the districts between the south and west, and those between the south and east, were overwhelmed in two quite different ways. From Torre Annunziata (which is believed to be the site of the ancient Oplontii) to San Giovanni a Teduccio, for a distance of about 9 m., there flowed a muddy eruption which in Herculaneum and the neighbouring places, where it was most abundant, raised the level of the country more than 65 ft. The matter transported consisted of soil of various kinds—sand, ashes, fragments of lava, pozzolana and whitish pumice, enclosing grains of uncalcined lime, similar in every respect to those of Pompeii. In the part of Herculaneum already excavated the corridors in the upper portions of the theatre are compactly filled, up to the head of the arches, with pozzolana and pumice transformed into tufa (which proves that the formation of this stone may take place in a comparatively short time). Tufa is also found in the lowest part of the city towards the sea in front of the few houses that have been discovered; and in the very high banks that surround them, as also in the lowest part of the theatre, there are plainly to be seen earth, sand, ashes, fragments

³ *C.I.L.* ii. No. 3866. This Spanish inscription refers to a Rectina who died at the age of 18 and was the wife of Voconius Romanus. It is quite possible that she was the Rectina whom Pliny the elder wished to assist during the disaster of Vesuvius, for her husband, Voconius Romanus, was an intimate friend of Pliny the younger. The latter addressed four letters to Voconius (i. 5, ii. 1, iii. 13, ix. 28), in another letter commended him to the emperor Trajan (x. 3), and in another (ii. 13) says of him: “Hunc ego cum simul studeremus arte familiariterque dilexi; ille meus in urbe, ille in secessu contubernalis; cum hoc aetate et jocos miscui.”

of lava and pumice, with little distinction of strata, almost always confused and mingled together, and varying from spot to spot in degree of compactness. It is clear that this immense congeries of earth and stones could not flow in a dry state over those 5 m. of country (in the beginning very steep, and at intervals almost level), where certainly it would have been arrested and all accumulated in a mound; but it must have been borne along by a great quantity of water, the effects of which may be distinctly recognized, not only in the filling and choking up even of the most narrow, intricate and remote parts of the buildings, but also in the formation of the tufa, in which water has so great a share; for it cannot be supposed that enough of it has filtered through so great a depth of earth. The torrent ran in a few hours to the sea, and formed that shallow or lagoon called by Pliny *Subitum Vadum*, which prevented the ships approaching the shores." Hence it is that, while many made their escape from Pompeii (which was overwhelmed by the fall of the small stones and afterwards by the rain of ashes), comparatively few can have managed to escape from Herculaneum, and these, according to the interpretation given to the inscription preserved in the National Museum (Mommson, *I.N. n. 2455*), found shelter in the neighbouring city of Neapolis, where they inhabited a quarter called that of the buried city (Suetonius, *Titus*, 8; *C.I.L.* x. No. 1492, in Naples: "Regio primaria splendissima Herculanensis"). The name of Herculaneum, which for some time remained attached to the site of the disaster, is mentioned in the later itineraries; but in the course of the middle ages all recollection of it perished.

In 1719, while Prince Elbeuf of the house of Lorraine, in command of the armies of Charles VI., was seeking crushed marble to make plaster for his new villa near Portici, he learned from the peasants that there were in the vicinity some pits from which they not only quarried excellent marble, but had extracted many statues in the course of years (see Jorio, *Notizia degli scavi d' Ercolano*, Naples, 1827). In 1738, while Colonel D. Rocco de Alcubierre was directing the works for the construction of the "Reali Delizie" at Portici, he received orders from Charles IV. (later, Charles III. of Spain) to begin excavations on the spot where it had been reported to the king that the Elbeuf statues had been found. At first it was believed that a temple was being explored, but afterwards the inscriptions proved that the building was a theatre. This discovery excited the greatest commotion among the scholars of all nations; and many of them hastened to Naples to see the marvellous statues of the Balbi and the paintings on the walls. But everything was kept private, as the government wished to reserve to itself the right of illustrating the monuments. First of all Monsignor Bayardi was brought from Rome and commissioned to write about the antiquities which were being collected in the museum at Portici under the care of Camillo Paderni, and when it was recognized that the prelate had not sufficient learning, and by the progress of the excavations other most abundant material was accumulated, about which at once scholars and courtiers were anxious to be informed, Bernardo Tanucci, having become secretary of state in 1755, founded the Accademia Ercolanese, which published the principal works on Herculaneum (*La Pùtura ed i bronzi d' Ercolano*, 8 vols., 1757, 1792; *Dissertationis isoposice ad Herculanensium voluminum explanationem pars prima*, 1797). The criterion which guided the studies of the academicians was far from being worthy of unqualified praise, and consequently their work did not always meet the approval of the best scholars who had the opportunity of seeing the monuments. Among these was Winckelmann, who in his letters gave ample notices of the excavations and the antiquities which he was able to visit on several occasions. Other notices were furnished by Gori, *Symbolae litterariae Florentinae* (1748, 1751), by Marcello Venuti, *Descrizione delle prime scoperte d' Ercolano* (Rome, 1748), and Scipione Maffei, *Le lettere intorno alle scoperte d' Ercolano* (Verona, 1748). The excavations, which continued for more than forty years (1738-1780), were executed at first under the immediate direction of Alcubierre (1738-1741), and then with the assistance of the engineers Rorro and Bardet (1741-1745), Carl Weber (1750-1764), and Francesco La Vega. After the death of Alcubierre (1780) the last-named was appointed director-in-chief of the excavations; but from that time the investigations at Herculaneum were intermitted, and the researches at Pompeii were vigorously carried on. Resumed in 1827, the excavations at Herculaneum were shortly after suspended, nor were the new attempts made in 1866 with the money bestowed by King Victor Emmanuel attended with success, being impeded by the many dangers arising from the houses built overhead. The meagreness of the results obtained by the occasional works executed in the last century, and the fact that the investigators were unfortunate enough to strike upon places already explored, gave rise to the opinion that the whole area of the city had been crossed by tunnels in the time of Charles III. and in the beginning of the

reign of Ferdinand IV. And although it is recognized that the works had not been prosecuted with the caution that they required, yet in view of the serious difficulties that would attend the collection of the little that had been left by the first excavators, every proposal for new investigations has been abandoned. But in a memoir which Professor Barnabei read in the Reale Accademia dei Lincei (*Atti della R. A. c.* series iii. vol. ii. p. 751) he undertook to prove that the researches made by the government in the 18th century did not cover any great area. The antiquities excavated at Herculaneum in that century (*i.e.* the 18th) form a collection of the highest scientific and artistic value. They come partly from the buildings of the ancient city (theatre, basilica, houses and forum), and partly from the private villa of a great Roman family (*cf.* Comparetti and de Petra, *La Villa Ercolanese dei Pisoni*, Turin, 1883). From the city come, among many other marble statues, the two equestrian statues of the Balbi (*Museo Borbonico*, vol. ii. pl. xxxviii-xxxix.), and the great imperial and municipal bronze statues. Mural paintings of extraordinary beauty were also discovered here, such as those that represent Theseus after the slaughter of the Minotaur (Heibig, *Wandgemälde*, Leipzig, 1878, No. 1214), Chiron teaching Achilles the art of playing on the lyre (*ibid.* No. 1291), and Hercules finding Telephus who is being suckled by the hind (*ibid.*, No. 1143).

Notwithstanding subsequent discoveries of stupendous paintings in the gardens of the Villa Farnesina on the banks of the Tiber, the monochromes of Herculaneum remain among the finest specimens of the exquisite taste and consummate skill displayed by the ancient artists. Among the best preserved is Leto and Niobe, which has been the subject of so many studies and so many publications (*ibid.* No. 1706). There is also a considerable number of lapidary inscriptions edited in vol. ii. of the epigraphic collection of the *Cat. del Mus. Naz. di Napoli*. The Villa Suburbana has given us a good number of marble busts, and the so-called statue of Aristides, but above all that splendid collection of bronze statues and busts mostly reproductions of famous Greek works now to be found in the Naples Museum. It is thence that we have obtained the reposing Hermes, the drunken Silenus, the sleeping Faunus, the dancing girls, the bust called Plato's, that believed to be Seneca's, the two quoit-throwers or discoboli, and so many masterpieces more, figured by the academicians in their volume on the bronzes. But a still further discovery made in the Villa Suburbana contributed to magnify the greatness of Herculaneum; within its walls was found the famous library, of which, counting both entire and fragmentary volumes, 1803 papyri are preserved. Among the nations which took the greatest interest in the discovery of the Herculanean library, the most honourable rank belongs to England, which sent Hayter and other scholars to Naples to solicit the publication of the volumes. Of the 341 papyri which have been unrolled, 195 have been published (*Herculanensium voluminum quae supersunt* (Naples, 1793-1809); *Collectio altera*, 1862-1876). They contain works by Epicurus, Demetrius, Polystratus, Colotes, Chrysippus, Carneius and Philodemus. The names of the authors are in themselves sufficient to show that the library belonged to a person whose principal study was the Epicurean philosophy. But of the great master of this school only a few works have been found. Of his treatise *Πηλοποιου*, divided into 37 books, it is known that there were three copies in the library (*Coll. alt.* vi.). Professor Comparetti, studying the first fasciculus of volume xi. of the same new collection, recognized most important fragments of the *Ethics* of Epicurus, and these he published in 1879 in Nos. ix. and xi. of the *Rivista di filologia e d'istruzione classica* (Turin). Even the other authors above mentioned are but poorly represented with the exception of Philodemus, of whom 26 different treatises have been recognized. But all these philosophic discussions, belonging for the most part to an author less than secondary among the Epicureans, fall short of the high expectations excited by the first discovery of the library. Among the many volumes unrolled only a few are of historical importance—that edited by Bücheler, which treats of the philosophers of the academy (*Acad. phil. index Hercul.*, Greifswald, 1859), and that edited by Comparetti, which deals with the Stoics ("Papiro ercolanese inedito," in *Rivista di fil. e d'ist. class.* anno iii. fasc. x.-xii.). To appreciate the value of the volumes unrolled but not yet published (for 146 vols. were only copied and not printed) the student must read Comparetti's paper, "Relazione sui papiri ercolanesi." Contributions of some value have been made to the study of Herculanean fragments by Spengel ("Die hercul. Rollen," in *Philologus*, 1863, suppl. vol.), and Gomperz (*Hercul. Studien*, Leipzig, 1865-1866, cf. *Zeitschr. f. österr. Gymn.*, 1867-1872). There are in the library some volumes written in Latin, which, according to Boot (*Notice sur les manuscrits trouvés à Herculaneum*, Amsterdam, 1845), were found tied up in a bundle apart. Of these we know 18, but they are all so damaged that hardly any of them can be deciphered. One with verses relating to the battle of Actium is believed to belong to a poem of Rabirius. The numerical preponderance of the works of Philodemus led some people to believe that this had been the library of that philosopher. Professor Comparetti has thrown out a conjecture (*cf.* Comparetti and de Petra, *op. cit.*) that the library was collected by Lucius Piso Caesoninus (*see Regione sotterranea dal Vesuvio*, Naples, 1879, p. 159 sq.), but this conjecture has not found many supporters. Professor de Petra (in the same work) has also published the official notices upon the antiquities unearthed in the sumptuous

HERCULANO DE CARVALHO E ARAUJO

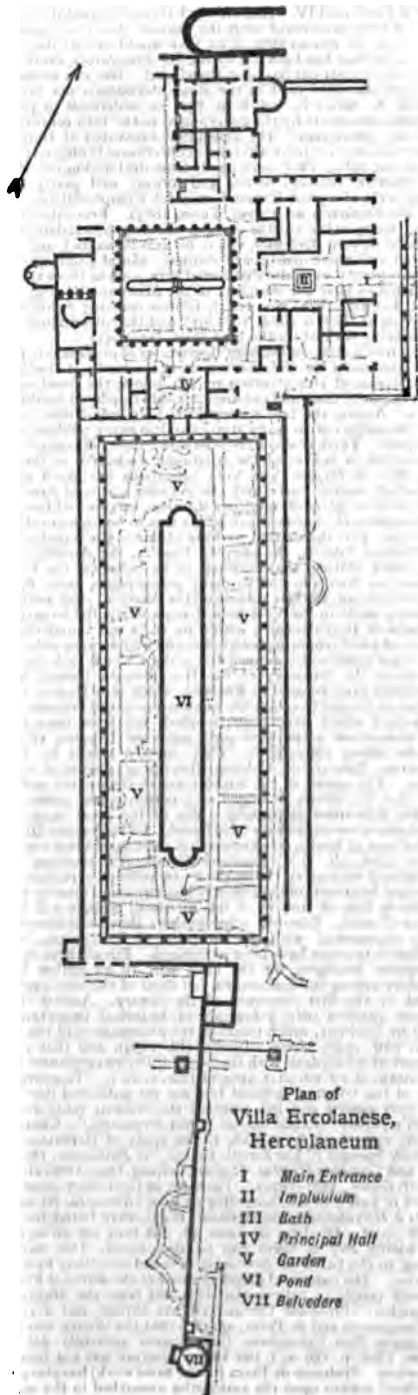

villa, giving the plan executed by Weber and recovered by chance by the director of excavations, Michele Ruggiero. This plan, which is here reproduced from de Petra¹ is the only satisfactory document for the topography of Herculaneum; for the plan of the theatre published in the *Bullettino archeologico italiano* (Naples, 1861, i. p. 53, tab. iii.) was executed in 1747, when the excavations were not completed. And even for the history of the "finds" made in the Villa Suburbana the necessity for further studies makes itself felt, since there is a lack of agreement between the accounts given by Alcubierre and Weber and those communicated to the *Philosophical Transactions* (London, vol. x.) by Camillo Paderni, conservator of the Portici Museum.

Among the older works relating to Herculaneum, in addition to those already quoted, may be mentioned de Brosse, *Lettre sur l'état actuel de la ville souterraine d'Héraclée* (Paris, 1750); Seigneux de Correvon, *Lettre sur la découverte de l'ancienne ville d'Herculane* (Yverdon, 1770); David, *Les Antiquités d'Herculaneum* (Paris, 1780); D' Ancora Gaetano, *Prospetto storico-fisico degli scavi d'Ercolano e di Pompei* (Naples, 1803); Venuti, *Prime Scoperte di Ercolano* (Rome, 1748); and Romanelli, *Viaggio ad Ercolano* (Naples, 1811). A full list will be found in vol. I. of *Museo Borbonico* (Naples, 1824), pp. 1-11.

The most important reference work is C. Waldstein and L. Shoo-bridge, *Herculaneum, Past, Present and Future* (London, 1908); it contains full references to the history and the explorations, and to the buildings and objects found (with illustrations). Miss E. R. Barker's *Excavated Herculaneum* (1908) is exceedingly useful.

In 1904 Professor Waldstein expounded both in Europe and in America an international scheme for thorough investigation of the site. Negotiations of a highly complex character ensued with the Italian government, which ultimately in 1908 decided that the work should be undertaken by Italian scholars with Italian funds. The work was begun in the autumn of 1908, but financial difficulties with property owners in Resina immediately arose with the result that progress was practically stopped. (F. B.)

HERCULANO DE CARVALHO E ARAUJO, ALEXANDRE (1810-1877), Portuguese historian, was born in Lisbon of humble stock, his grandfather having been a foreman stonemason in the royal employ. He received his early education, comprising Latin, logic and rhetoric, at the *Necessidades* Monastery, and spent a year at the Royal Marine Academy studying mathematics with the intention of entering on a commercial career. In 1828 Portugal fell under the absolute rule of D. Miguel, and Herculano, becoming involved in the unsuccessful military *pronunciamento* of August 1831, had to leave Portugal clandestinely and take refuge in England and France. In 1832 he accompanied the Liberal expedition to Terceira as a volunteer, and was one of D. Pedro's famous army of 7500 men who landed at the Mindello and occupied Oporto. He took part in all the actions of the great siege, and at the same time served as a librarian in the city archives. He published his first volume of verses, *A Vos do Profeta*, in 1832, and two years later another entitled *A Harpa do Crente*. Privation had made a man of him, and in these little books he proves himself a poet of deep feeling and considerable power of expression. The stirring incidents in the political emancipation of Portugal inspired his muse, and he describes the bitterness of exile, the adventurous expedition to Terceira, the heroic defence of Oporto, and the final combats of liberty. In 1837 he founded the *Panorama* in imitation of the *English Penny Magazine*, and there and in *Ilustração* he published the historical tales which were afterwards collected into *Lendas e Narrativas*; in the same year he became royal librarian at the Ajuda Palace, which enabled him to continue his studies of the past. The *Panorama* had a large circulation and influence, and Herculano's biographical sketches of great men and his articles of literary and historical criticism did much to educate the middle class by acquainting them with the story of their nation, and with the progress of knowledge and the state of letters in foreign countries. On entering parliament in 1840 he resigned the editorship to devote himself to history, but he still remained its most important contributor.

Up to the age of twenty-five Herculano had been a poet, but he then abandoned poetry to Garrett, and after several essays in that direction he definitely introduced the historical novel into Portugal in 1844 by a book written in imitation of Walter Scott. *Eurico* treats of the fall of the Visigothic monarchy and the beginnings of resistance in the Asturias which gave

¹ The diagram shows the arrangement and proportions of the Villa Ercolanese. The dotted lines show the course taken by the excavations, which began at the lower part of the plan.

birth to the Christian kingdoms of the Peninsula, while the *Monge de Cister*, published in 1848, describes the time of King John I., when the middle class and the municipalities first asserted their power and elected a king in opposition to the nobility. From an artistic standpoint, these stories are rather laboured productions, besides being ultra-romantic in tone; but it must be remembered that they were written mainly with an educational object, and, moreover, they deserve high praise for their style. Herculano had greater book learning than Scott, but lacked descriptive talent and skill in dialogue. His touch is heavy, and these novels show no dramatic power, which accounts for his failure as a playwright, but their influence was as great as their followers were many, and they still find readers. These and editions of two old chronicles, the *Chronica de D. Sebastião* (1839) and the *Annaes del rei D. João III* (1844), prepared Herculano for his life's work, and the year 1846 saw the first volume of his *History of Portugal from the Beginning of the Monarchy to the end of the Reign of Afonso III.*, a book written on critical lines and based on documents. The difficulties he encountered in producing it were very great, for the foundations had been ill-prepared by his predecessors, and he was obliged to be artisan and architect at the same time. He had to collect MSS. from all parts of Portugal, decipher, classify and weigh them before he could begin work, and then he found it necessary to break with precedents and destroy traditions. Serious students in Portugal and abroad welcomed the book as an historical work of the first rank, for its evidence of careful research, its able marshalling of facts, its learning and its painful accuracy, while the sculptural simplicity of the style and the correctness of the diction have made it a Portuguese classic. The first volume, however, gave rise to a celebrated controversy, because Herculano had reduced the famous battle of Ourique, which was supposed to have seen the birth of the Portuguese monarchy, to the dimensions of a mere skirmish, and denied the apparition of Christ to King Afonso, a fable first circulated in the 15th century. Herculano was denounced from the pulpit and the press for his lack of patriotism and piety, and after bearing the attack for some time his pride drove him to reply. In a letter to the cardinal patriarch of Lisbon entitled *Eu e o Clero* (1850), he denounced the fanaticism and ignorance of the clergy in plain terms, and this provoked a fierce pamphlet war marked by much personal abuse. The professor of Arabic in Lisbon intervened to sustain the accepted view of the battle, and charged Herculano and his supporter Gayangos with ignorance of the Arab historians and of their language. The conduct of the controversy, which lasted some years, did credit to none of the contending parties, but Herculano's statement of the facts is now universally accepted as correct. The second volume of his history appeared in 1847, the third in 1849 and the fourth in 1853. In his youth, the excesses of absolutism had made Herculano a Liberal, and the attacks on his history turned this man, full of sentiment and deep religious conviction, into an anti-clerical who began to distinguish between political Catholicism and Christianity. His *History of the Origin and Establishment of the Inquisition* (1854-1855), relating the thirty years' struggle between King John III. and the Jews—he to establish the tribunal and they to prevent him—was compiled, as the preface showed, to stem the Ultramarine reaction, but none the less carried weight because it was a recital of events with little or no comment or evidence of passion in its author. Next to these two books his study, *Do Estado das classes servas na Peninsula desde o VII. até o XII. seculo.*, is Herculano's most valuable contribution to history. In 1856 he began editing a series of *Portugalliae monumenta historica*, but personal differences between him and the keeper of the Archive office, which he was forced to frequent, caused him to interrupt his historical studies, and on the death of his friend King Pedro V. he left the Ajuda and retired to a country house near Santarém.

Disillusioned with men and despairing of the future of his country, he spent the rest of his life devoted to agricultural pursuits, and rarely emerged from his retirement; when he did so, it was to fight political and religious reaction. Once he

had defended the monastic orders, advocating their reform and not their suppression, supported the rural clergy and idealized the village priest in his *Párocho da Aldeia*, after the manner of Goldsmith in the *Vicar of Wakefield*. Unfortunately, however, the brilliant epoch of the alliance of Liberalism and Catholicism, represented on its literary side by Chateaubriand and by Lamartine, to whose poetic school Herculano had belonged, was past, and fanatical attacks and the progress of events drove this former champion of the Church into conflict with the ecclesiastical authorities. His protest against the Concordat of the 27th of February 1857 between Portugal and the Holy See, regulating the Portuguese Padroado in the East, his successful opposition to the entry of foreign religious orders, and his advocacy of civil marriage, were the chief landmarks in his battle with Ultramontanism, and his *Estudos sobre o Casamento Civil* were put on the Index. Finally in 1871 he attacked the dogmas of the Immaculate Conception and papal infallibility, and fell into line with the Old Catholics. In the domain of letters he remained until his death a veritable pontiff, and an article or book of his was an event celebrated from one end of Portugal to the other. The nation continued to look up to him for mental leadership, but, in his later years, lacking hope himself, he could not stimulate others or use to advantage the powers conferred upon him. In politics he remained a constitutional Liberal of the old type, and for him the people were the middle classes in opposition to the lower, which he saw to have been the supporters of tyranny in all ages, while he considered Radicalism to mean a return via anarchy to absolutism. However, though he conducted a political propaganda in the newspaper press in his early days, Herculano never exercised much influence in politics. Grave as most of his writings are, they include a short description of a crossing from Jersey to Granville, in which he satirizes English character and customs, and reveals an unexpected sense of humour. A rare capacity for tedious work, a dour Catoian rectitude, a passion for truth, pride, irritability at criticism and independence of character, are the marks of Herculano as a man. He could be broken but never bent, and his rude frankness accorded with his hard, sombre face, and alienated men's sympathies though it did not lose him their respect. His lyricism is vigorous, feeling, austere and almost entirely subjective and personal, while his pamphlets are distinguished by energy of conviction, strength of affirmation, and contempt for weaker and more ignorant opponents. His *History of Portugal* is a great but incomplete monument. A lack of imagination and of the philosophic spirit prevented him from penetrating or drawing characters, but his analytical gift, joined to persevering toil and honesty of purpose enabled him to present a faithful account of ascertained facts and a satisfactory and lucid explanation of political and economic events. His remains lie in a majestic tomb in the Jeronymos at Belem, near Lisbon, which was raised by public subscription to the greatest modern historian of Portugal and of the Peninsula. His more important works have gone through many editions and his name is still one to conjure with.

AUTHORITIES.—Antonio de Serpa Pimentel, *Alexandre Herculano e o seu tempo* (Lisbon, 1881); A. Romero Ortiz, *La Literatura Portuguesa en el siglo XIX.* (Madrid, 1869); Moniz Barreto, *Revista de Portugal* (July 1889). (E. Fx.)

HERCULES (O. Lat. *Hercules, Heracles*), the latinized form of the mythical Heracles, the chief national hero of Hellas. The name Ἡρακλῆς (Ἥρα, and κλέος = glory) is explained as "renowned through Hera" (i.e. in consequence of her persecution) or "the glory of Hera" i.e. of Argos. The thoroughly national character of Heracles is shown by his being the mythical ancestor of the Dorian dynastic tribe, while revered by Ionian Athens, Lelegian Opus and Aeolo-Phoenician Thebes, and closely associated with the Achæan heroes Peleus and Telamon. The Perseid Alcmena, wife of Amphitryon of Tiryns, was Hercules' mother, Zeus his father. After his father he is often called Amphitryoniades, and also Alcides, after the Perseid Alcæus, father of Amphitryon. His mother and her husband lived at Thebes in exile as guests of King Creon. By the craft of Hera,

his foe through life, his birth was delayed, and that of Eurystheus, son of Sthenelus of Argos, hastened, Zeus having in effect sworn that the elder of the two should rule the realm of Perseus. Hera sent two serpents to destroy the new-born Hercules, but he strangled them. He was trained in all manly accomplishments by heroes of the highest renown in each, until in a transport of anger at a reprimand he slew Linus, his instructor in music, with the lyre. Thereupon he was sent to tend Amphitryon's oxen, and at this period slew the lion of Mount Cithaeron. By freeing Thebes from paying tribute to the Minyans of Orchomenus he won Creon's daughter, Megara, to wife. Her children by him he killed in a frenzy induced by Hera. After purification he was sent by the Pythia to serve Eurystheus. Thus began the cycle of the twelve labours.

1. Wrestling with the Nemean lion.
2. Destruction of the Lernean hydra.
3. Capture of the Arcadian hind (a stag in art).
4. Capture of the boar of Erymanthus, while chasing which he fought the Centaurs and killed his friends Chiron and Pholus, this homicide leading to Demeter's institution of *mysteria*.
5. Cleansing of the stables of Augeas.
6. Shooting the Stymphalian birds.
7. Capture of the Cretan bull subsequently slain by Theseus at Marathon.
8. Capture of the man-eating mares of the Thracian Diomedes.
9. Seizure of the girdle of Hippolyte, queen of the Amazons.
10. Bringing the oxen of Geryones from Erythia in the far west, which errand involved many adventures in the coast lands of the Mediterranean, and the setting up of the " Pillars of Hercules " at the Straits of Gibraltar.
11. Bringing the golden apples from the garden of the Hesperides.
12. Carrying Cerberus from Hades to the upper world.

Most of the labours lead to various adventures called *πρότερα*. On Hercules' return to Thebes he gave his wife Megara to his friend and charioteer Iolaus, son of Iphicles, and by beating Eurystus of Oechalia and his sons in a shooting match won a claim to the hand of his daughter Iole, whose family, however, except her brother Iphitus, withheld their consent to the union. Iphitus persuaded Hercules to search for Eurystus' lost oxen, but was killed by him at Tiryns in a frenzy. He consulted the Pythia about a cure for the consequent madness, but she declined to answer him. Whereupon he seized the oracular tripod, and so entered upon a contest with Apollo, which Zeus stopped by sending a flash of lightning between the combatants. The Pythia then sent him to serve the Lydian queen Omphale. He then, with Telamon, Peleus and Theseus, took Troy. He next helped the gods in the great battle against the giants. He destroyed sundry sea-monsters, set free the bound Prometheus, took part in the Argonautic voyage and the Calydonian boar hunt, made war against Augeas, and against Nestor and the Pyliaans, and restored Tyndareus to the sovereignty of Lacedaemon. He sustained many single combats, one very famous struggle being the wrestling with the Libyan Antaeus, son of Poseidon and Ge (Earth), who had to be held in the air, as he grew stronger every time he touched his mother, Earth. Hercules withstood Ares, Poseidon and Hera, as well as Apollo. The close of his career is assigned to Aetolia and Trachis. He wrestles with Achelous for Deianeira ("destructive to husband"), daughter of Oeneus, king of Calydon, vanquishes the river god, and breaks off one of his horns, which as a horn of plenty is found as an attribute of Hercules in art. Driven from Calydon for homicide, he goes with Deianeira to Trachis. On the way he slays the centaur Nessus, who persuades Deianeira that his blood is a love-charm. From Trachis he wages successful war against the Dryopes and Lapithae as ally of Aegimius, king of the Dorians, who promised him a third of his realm, and after his death adopted Hyllus, his son by Deianeira. Finally Hercules attacks Eurystus, takes Oechalia and carries off Iola. Thereupon Deianeira, prompted by love and jealousy, sends him a tunic dipped in the blood of Nessus, and the unsuspecting hero puts it on just before sacrificing at the headland of Cenaeum in Euboea. (So far the dithyramb of Bacchylides xv. [xvi.], agrees with Sophocles' *Trachiniae* as to the hero's end.) Mad with pain, he seizes Lichas, the messenger who had brought the fatal garment, and hurls him on the rocks; and then he

wanders in agony to Mount Oeta, where he mounts a pyre, which, however, no one will kindle. At last Peas, father of Philoctetes, takes pity on him, and is rewarded with the gift of his bow and arrows. The immortal part of Hercules passes to Olympus, where he is reconciled to Hera and weds her daughter Hebe. This account of the hero's principal labours, exploits and crimes is derived from the mythologists Apollodorus and Diodorus, who probably followed the *Heracleia* by Peisander of Rhodes as to the twelve labours or that of Panyasis of Halicarnassus, but sundry variations of order and incident are found in classical literature.

In one aspect Hercules is clearly a sun-god, being identified, especially in Cyprus and in Thasos (as Makar), with the Tyrian Melkarth. The third and twelfth labours may be solar, the horned hind representing the moon, and the carrying of Cerberus to the upper world an eclipse, while the last episode of the hero's tragedy is possibly a complete solar myth developed at Trachis. The winter sun is seen rising over the Cenaeum promontory to toil across to Mount Oeta and disappear over it in a bank of fiery cloud. But more important and less speculative is the hero's aspect as a national type or an amalgamation of tribal types of physical force, of dauntless effort and endurance, of militant civilization; and of Hellenic enterprise, "stronger than everything except his own passions," and "at once above and below the noblest type of man" (Jebb). The fifth labour seems to symbolize some great improvement in the drainage of Elis. Strenuous devotion to the deliverance of mankind from dangers and pests is the "virtue" which, in Prodicus' famous apologue on the *Choice of Hercules*, the hero preferred to an easy and happy life. Ethically, Hercules symbolizes the attainment of glory and immortality by toil and suffering.

The Old-Dorian Hercules is represented in three cycles of myth, the Argive, the Boeotian and the Thessalian; the legends of Arcadia, Aetolia, Lydia, &c., and Italy are either local or symbolical and comparatively late. The fatality by which Hercules kills so many friends as well as foes recalls the destroying Apollo; while his career frequently illustrates the Delphic views on blood-guiltiness and expiation. As Apollo's champion Hercules is Daphnephoros, and fights Cycnus and Amyntor to keep open the sacred way from Tempe to Delphi. As the Dorian tutelary he aids Tyndareus and Aegimius. As patron of maritime adventure (*ἡγεμόνων*) he struggles with Nereus and Triton, slays Eryx and Busiris, and perhaps captures the wild horses and oxen, which may stand for pirates. As a god of athletes he is often a wrestler (*παλαίμαχος*), and founds the Olympian games. In comedy and occasionally in myths he is depicted as voracious (*βουφάγος*). He is also represented as the companion of Dionysus, especially in Asia Minor. The "Resting" (*ἀναπαυόμενος*) Hercules is, as at Thermopylae and near Himera, the natural tutelary of hot springs in conjunction with his protectress Athena, who is usually depicted attending him on ancient vases. The glorified Hercules was worshipped both as a god and a hero. In the Attic deme Melita he was invoked as *ἀλεξίακος* ("Helper in ills"), at Olympia as *καλλίσκος* ("Nobly-victorious"), in the rustic worship of the Oetaeans as *κοροστῆλιον* (*κόροστος*, "locusts"), by the Erythraeans of Ionia as *ἰσχυρόστος* ("Canker-worm-slayer"). He was *σωτήρ* ("Saviour"), i.e. a protector of voyagers, at Thasos and Smyrna. Games in his honour were held at Thebes and Marathon and annual festivals in every deme of Attica, in Sicily and Agyrium (Sicily). His guardian goddess was Athena (Homer, *Il.* viii. 638; Bacchylides v. 91 f.). In early poetry, as often in art, he is an archer, afterwards a club-wielder and fully-armed warrior. In early art the adult Hercules, is bearded, but not long-haired. Later he is sometimes youthful and beardless, always with short curly hair and thick neck, the lower part of the brow prominent. A lion's skin is generally worn or carried. Lysippus worked out the finest type of sculptured Hercules, of which the Farnese by Glycon is a grand specimen. The infantine struggle with serpents was a favourite subject.

Quite distinct was the Idaean Hercules, a Cretan Dactyl connected with the cult of Rhea or Cybele. The Greeks recognized

Hercules in an Egyptian deity *Chons* and an Indian *Dorsanes*, not to mention personages of other mythologies.

Hercules is supposed to have visited Italy on his return from Erythia, when he slew Cacus, son of Vulcan, the giant of the Aventine mount of Rome, who had stolen his oxen. To this victory was assigned the founding of the *Ara maxima* by Evander. His worship, introduced from the Greek colonies in Etruria and in the south of Italy, seems to have been established in Rome from the earliest times, as two old Patrician *gentes* were associated with his cult and the Fabii claimed him as their ancestor. The tithes vowed to him by Romans and men of Sora and Reate, for safety on journeys and voyages, furnished sacrifices and (in Rome) public entertainment (*polluctum*). Tibur was a special seat of his cult. In Rome he was patron of gladiators, as of athletes in Greece. With respect to the Roman relations of the hero, it is manifest that the native myths of Recaranus, or Sancus, or Dius Fidius, were transferred to the Hellenic Hercules. (C. A. M. F.)

See L. Preller, *Griechische Mythologie* (4th ed., Berlin, 1900); W. H. Roscher, *Ausführliches Lexikon der griechischen und römischen Mythologie* (1884); Sir R. C. Jebb, *Trachiniae* of Sophocles (Introd., 1892); Ch. Daremberg and E. Saglio, *Dictionnaire des antiquités grecques et romaines*; Bréal, *Hercule et Cacus*, 1863; J. G. Winter, *Myth of Hercules at Rome* (New York, 1910).

In the article *GRÆK ART*, fig. 16 represents Heracles wrestling with the river-god Achelous; fig. 20 (from a small pediment, possibly of a shrine of the hero) the slaying of the Hydra; fig. 35 Heracles holding up the sky on a cushion.

Hercules was a favourite figure in French medieval literature. In the romance of Alexander the tent of the hero is decorated with incidents from his adventures. In the prose romance *Les Pruesses et vaillances du preux Hercules* (Paris, 1500), the hero's labours are represented as having been performed in honour of a Boeotian princess; Pluto is a king dwelling in a dismal castle; the Fates are duennas watching Proserpine; the entrance to Pluto's castle is watched by the giant Cerberus. Hercules conquers Spain and takes Merida from Geryon. The book is translated into English as *Hercules of Greece* (n. d.). Fragments of a French poem on the subject will be found in the *Bulletin de la soc. des anciens textes français* (1877). Don Enrique de Villena took from *Les Pruesses* his prose *Los Doze Trabajos de Hercules* (Zamora, 1483 and 1499), and Fernandez de Heredia wrote *Trabajos y afanes de Hercules* (Madrid, 1682), which belies its title, being a collection of adages and allegories. *Le Fatihes d' Ercole* (1475) is a romance in poetic prose by Pietro Bassi, and the *Dodeci Travagli di Ercole* (1544) a poem by J. Perillos.

HERCULES, in astronomy, a constellation of the northern hemisphere, mentioned by Eudoxus (4th century B.C.) and Aratus (3rd century B.C.) and catalogued by Ptolemy (20 stars) and Tycho Brahe (28 stars). Represented by a man kneeling, this constellation was first known as "the man on his knees," and was afterwards called Cæthus, Theseus and Hercules by the ancient Greeks. Interesting objects in this constellation are: *a Herculis*, a fine coloured double star, composed of an orange star of magnitude 2½, and a blue star of magnitude 6; *ξ Herculis*, a binary star, discovered by Sir William Herschel in 1782; one component is a yellow star of the third magnitude, the other a bluish, which appears to vary from red to blue, of magnitude 6; *g* and *u Herculis*, irregularly variable stars; and the cluster *M. 13 Herculis*, the finest globular cluster in the northern hemisphere, containing at least 5000 stars and of the 1000 determined only 2 are variable.

HERD (a word common to Teutonic languages; the O. Eng. form was *heord*; cf. Ger. *Herde*, Swed. and Dan. *hjord*; the Sans. *caṛdhas*, which shows the pre-Teutonic form, means a troop), a number of animals of one kind driven or fed together, usually applied to cattle as "flock" is to sheep, but used also of whales, porpoises, &c., and of birds, as swans, cranes and curlews. A "herd-book" is a book containing the pedigree and other information of any breed of cattle or pigs, like the "flock-book" for sheep or "stud-book" for horses. Formerly the word "herdwick" was applied to the pasture ground under the care of a shepherd, and it is now used of a special hardy breed of sheep in Cumberland and Westmorland. The word "herd" is also applied in a disparaging sense to a company of people, a mob or rabble, as "the vulgar herd." As the name for a keeper of a herd or flock of domestic animals, the herdsman, it is usually qualified to denote the kind of animal under his

protection, as swine-herd, shepherd, &c., but in Ireland, Scotland and the north of England, "herd" alone is commonly used.

HERDER, JOHANN GOTTFRIED VON (1744-1803), one of the most prolific and influential writers that Germany has produced, was born in Mohrungen, a small town in East Prussia, on the 25th of August 1744. Like his contemporary Lessing, Herder had throughout his life to struggle against adverse circumstances. His father was poor, having to put together a subsistence by uniting the humble offices of sexton, choir-singer and petty schoolmaster. After receiving some rudimentary instruction from his father, the boy was sent to the grammar school of his native town. The mode of discipline practised by the pedantic and irritable old man who stood at the head of this institution was not at all to the young student's liking, and the impression made upon him stimulated him later on to work out his projects of school reform. The hardships of his early years drove him to introspection and to solitary communion with nature, and thus favoured a more than proportionate development of the sentimental and poetic side of his mind. When quite young he expressed a wish to become a minister of the gospel, but his aspirations were discouraged by the local clergyman. In 1762, at the age of eighteen, he went up to Königsberg with the intention of studying medicine, but finding himself unequal to the operations of the dissecting-room, he abandoned this object, and, by the help of one or two friends and his own self-supporting labours, followed out his earlier idea of the clerical profession by joining the university. There he came under the influence of Kant, who was just then passing from physical to metaphysical problems. Without becoming a disciple of Kant, young Herder was deeply stimulated to fresh critical inquiry by that thinker's revolutionary ideas in philosophy. To Kant's lectures and conversations he further owed something of his large interest in cosmological and anthropological problems. Among the writers whom he most carefully read were Plato, Hume, Shaftesbury, Leibnitz, Diderot and Rousseau. Another personal influence under which he fell at Königsberg, and which was destined to be far more permanent, was that of J. G. Hamann, "the northern Blage." This writer had already won a name, and in young Herder he found a mind well fitted to be the receptacle and vehicle of his new ideas on literature. From this vague, incoherent, yet gifted writer our author acquired some of his strong feeling for the naive element in poetry, and for the earliest developments of national literature. Even before he went to Königsberg he had begun to compose verses, and at the age of twenty he took up the pen as a chief occupation. His first published writings were occasional poems and reviews contributed to the *Königsbergische Zeitung*. Soon after this he got an appointment at Riga, as assistant master at the cathedral school, and a few years later, became assistant pastor. In this busy commercial town, in somewhat improved pecuniary and social circumstances, he developed the main ideas of his writings. In the year 1767 he published his first considerable work *Fragments über die neuere deutsche Literatur*, which at once made him widely known and secured for him the favourable interest of Lessing. From this time he continued to pour forth a number of critical writings on literature, art, &c. His bold ideas on these subjects, which were a great advance even on Lessing's doctrines, naturally excited hostile criticism, and in consequence of this opposition, which took the form of aspersions on his religious orthodoxy, he resolved to leave Riga. He was much carried away at this time by the idea of a radical reform of social life in Livonia, which (after the example of Rousseau) he thought to effect by means of a better method of school-training. With this plan in view he began (1766) a tour through France, England, Holland, &c., for the purpose of collecting information respecting their systems of education. It was during the solitude of his voyage to France, when on deck at night, that he first shaped his idea of the genesis of primitive poetry, and of the gradual evolution of humanity. Having received an offer of an appointment as travelling tutor and chaplain to the young prince of Eutin-Holstein, he abandoned his somewhat visionary scheme of a social reconstruction of a

Russian province. He has, however, left a curious sketch of his projected school reforms. His new duties led him to Strassburg, where he met the young Goethe, on whose poetical development he exercised so potent an influence. At Darmstadt he made the acquaintance of Caroline Flachsland, to whom he soon became betrothed, and who for the rest of his life supplied him with that abundance of consolatory sympathy which his sensitive and rather querulous nature appeared to require. The engagement as tutor did not prove an agreeable one, and he soon threw it up (1771) in favour of an appointment as court preacher and member of the consistory at Bückeberg. Here he had to encounter bitter opposition from the orthodox clergy and their followers, among whom he was regarded as a frothinker. His health continued poor, and a fistula in the eye, from which he had suffered from early childhood, and to cure which he had undergone a number of painful operations, continued to trouble him. Further, pecuniary difficulties, from which he never long managed to keep himself free, by delaying his marriage, added to his depression. Notwithstanding these trying circumstances he resumed literary work, which his travels had interrupted. For some time he had been greatly interested by the poetry of the north, more particularly Percy's *Reliques*, the poems of "Ossian" (in the genuineness of which he like many others believed) and the works of Shakespeare. Under the influence of this reading he now finally broke with classicism and became one of the leaders of the new *Sturm und Drang* movement. He co-operated with a band of young writers at Darmstadt and Frankfurt, including Goethe, who in a journal of their own sought to diffuse the new ideas. His marriage took place in 1773. In 1776 he obtained through Goethe's influence the post of general superintendent and court preacher at Weimar, where he passed the rest of his life. There he enjoyed the society of Goethe, Wieland, Jean Paul (who came to Weimar in order to be near Herder), and others, the patronage of the court, with whom as a preacher he was very popular, and an opportunity of carrying out some of his ideas of school reform. Yet the social atmosphere of the place did not suit him. His personal relations with Goethe again and again became embittered. This, added to ill-health, served to intensify a natural irritability of temperament, and the history of his later Weimar days is a rather dreary page in the chronicles of literary life. He had valued more than anything else a teacher's influence over other minds, and as he began to feel that he was losing it he grew jealous of the success of those who had outgrown this influence. Yet while presenting these unlovely traits, Herder's character was on the whole a worthy and attractive one. This seems to be sufficiently attested by the fact that he was greatly liked and esteemed, not only in the pulpit but in private intercourse, by cultivated women like the countess of Bückeberg, the duchess of Weimar and Frau von Stein, and, what perhaps is more, was exceedingly popular among the gymnasium pupils, in whose education he took so lively an interest. While much that Herder produced after settling in Weimar has little value, he wrote also some of his best works, among others his collection of popular poetry on which he had been engaged for many years, *Stimmen der Völker in Liedern* (1778-1779); his translation of the Spanish romances of the *Cid* (1805); his celebrated work on Hebrew poetry, *Vom Geist der hebräischen Poesie* (1782-1783); and his *opus magnum*, the *Ideen zur Philosophie der Geschichte der Menschheit* (1784-1791). Towards the close of his life he occupied himself, like Lessing, with speculative questions in philosophy and theology. The boldness of some of his ideas cost him some valuable friendships, as that of Jacobi, Lavater and even of his early teacher Hamann. He died on the 18th of December 1803, full of new literary plans up to the very last.

Herder's writings were for a long time regarded as of temporary value only, and fell into neglect. Recent criticism, however, has tended very much to raise their value by tracing out their wide and far-reaching influence. His works are very voluminous, and to a large extent fragmentary and devoid of artistic finish; nevertheless they are nearly always worth investigating for the brilliant suggestions in which they abound. His place in German

literature has already been indicated in tracing his mental development. Like Lessing, whose work he immediately continued, he was a pioneer of the golden age of this literature. Lessing had given the first impetus to the formation of a national literature by exposing the folly of the current imitation of French writers. But in doing this he did not so much call his fellow-countrymen to develop freely their own national sentiments and ideas as send them back to classical example and principle. Lessing was the exponent of German classicism; Herder, on the contrary, was a pioneer of the romantic movement. He fought against all imitation as such, and bade German writers be true to themselves and their national antecedents. As a sort of theoretic basis for this adhesion to national type in literature, he conceived the idea that literature and art, together with language and national culture as a whole, are evolved by a natural process, and that the intellectual and emotional life of each people is correlated with peculiarities of physical temperament and of material environment. In this way he became the originator of that genetic or historical method which has since been applied to all human ideas and institutions. Herder was thus an evolutionist, but an evolutionist still under the influence of Rousseau. That is to say, in tracing back the later acquisitions of civilization to impulses which are as old as the dawn of primitive culture, he did not, as the modern evolutionist does, lay stress on the superiority of the later to the earlier stages of human development, but rather became enamoured of the simplicity and spontaneity of those early impulses which, since they are the oldest, easily come to look like the most real and precious. Yet even in this way he helped to found the historical school in literature and science, for it was only after an excessive and sentimental interest in primitive human culture had been awakened that this subject would receive the amount of attention which was requisite for the genetic explanation of later developments. This historical idea was carried by Herder into the regions of poetry, art, religion, language, and finally into human culture as a whole. It colours all his writings, and is intimately connected with some of the most characteristic attributes of his mind, a quick sympathetic imagination, a fine feeling for local differences, and a scientific instinct for seizing the sequences of cause and effect.

Herder's works may be arranged in an ascending series, corresponding to the way in which the genetic or historical idea was developed and extended. First come the works on poetic literature, art, language and religion as special regions of development. Secondly, we have in the *Ideen* a general account of the process of human evolution. Thirdly, there are a number of writings which, though inferior in interest to the others, may be said to supply the philosophic basis of his leading ideas.

1. In the region of poetry Herder sought to persuade his countrymen, both by example and precept, to return to a natural and spontaneous form of utterance. His own poetry has but little value; Herder was a skillful verse-maker but hardly a creative poet. He was most successful in his translation of popular song, in which he shows a rare sympathetic insight into the various feelings and ideas of peoples as unlike as Greenlanders and Spaniards, Indians and Scots. In the *Fragmente* he aims at nationalizing German poetry and freeing it from all extraneous influence. He ridicules the ambition of German writers to be classic, as Lessing had ridiculed their eagerness to be French. He looked at poetry as a kind of "proteus among the people, which changes its form according to language, manners, habits, according to temperament and climate, nay, even according to the accent of different nations." This fact of the idiosyncrasy of national poetry he illustrated with great fulness and richness in the case of Homer, the nature of whose works he was one of the first to elucidate, the Hebrew poets, and the poetry of the north as typified in "Ossian." This same idea of necessary relation to national character and circumstance is also applied to dramatic poetry, and more especially to Shakespeare. Lessing had done much to make Shakespeare known to Germany, but he had regarded him in contrast to the French dramatists with whom he also contrasted the Greek dramatic poets, and accordingly did not bring out his essentially modern and Teutonic character. Herder does this, and in doing so shows a far deeper understanding of Shakespeare's genius than his predecessor had shown.

2. The views on art contained in Herder's *Kritische Walden* (1769), *Plastik* (1778), &c. are chiefly valuable as a correction of the excesses into which reverence for Greek art had betrayed Winkelmann and Lessing, by help of his fundamental idea of national idiosyncrasy. He argues against the setting up of classic art as an unchanging type,

valid for all peoples and all times. He was one of the first to bring to light the characteristic excellences of Gothic art. Beyond this, he eloquently pleaded the cause of painting as a distinct art, which Lessing in his desire to mark off the formative arts from poetry and music had confounded with sculpture. He regarded this as the art of the eye, while sculpture was rather the art of the organ of touch. Painting being less real than sculpture, because lacking the third dimension of space, and a kind of dream, admitted of much greater freedom of treatment than this last. Herder had a genuine appreciation for early German painters, and helped to awaken the modern interest in Albrecht Dürer.

3. By his work on language *Über den Ursprung der Sprache* (1772), Herder may be said to have laid the first rude foundations of the science of comparative philology and that deeper science of the ultimate nature and origin of language. It was specially directed against the supposition of a divine communication of language to man. Its main argument is that speech is a necessary outcome of that special arrangement of mental forces which distinguishes man, and more particularly from his habits of reflection. "If," Herder says, "it is incomprehensible to others how a human mind could invent language, it is as incomprehensible to me how a human mind could be what it is without discovering language for itself." The writer does not make that use of the fact of man's superior organic endowments which one might expect from his general conception of the relation of the physical and the mental in human development.

4. Herder's services in laying the foundations of a comparative science of religion and mythology are even of greater value than his somewhat crude philological speculations. In opposition to the general spirit of the 18th century he saw, by means of his historic sense, the naturalness of religion, its relation to man's wants and impulses. Thus with respect to early religious beliefs he rejected Hume's notion that religion sprang out of the fears of primitive men, in favour of the theory that it represents the first attempts of our species to explain phenomena. He thus intimately associated religion with mythology and primitive poetry. As to later forms of religion, he appears to have held that they owe their vitality to their embodiment of the deep-seated moral feelings of our common humanity. His high appreciation of Christianity, which contrasts with the contemptuous estimate of the contemporary rationalists, rested on a firm belief in its essential humanity, to which fact, and not to conscious deception, he attributes its success. His exposition of this religion in his sermons and writings was simply an unfolding of its moral side. In his later life, as we shall presently see, he found his way to a speculative basis for his religious beliefs.

5. Herder's masterpiece, the *Ideen zur Philosophie der Geschichte*, has the ambitious aim of explaining the whole of human development in close connexion with the nature of man's physical environment. Man is viewed as a part of nature, and all his widely differing forms of development as strictly natural processes. It thus stands in sharp contrast to the anthropology of Kant, which opposes human development conceived as the gradual manifestation of a growing faculty of rational free will to the operations of physical nature. Herder defines human history as "a pure natural history of human powers, actions and propensities, modified by time and place." The *Ideen* shows us that Herder is an evolutionist after the manner of Leibnitz, and not after that of more modern evolutionists. The lower forms of life prefigure man in unequal degrees of imperfection; they exist for his sake, but they are not regarded as representing necessary antecedent conditions of human existence. The genetic method is applied to varieties of man, not to man as a whole. It is worth noting, however, that Herder in his provokingly tentative way of thinking comes now and again very near ideas made familiar to us by Spencer and Darwin. Thus in a passage in book xv, chap. ii., which unmistakably foreshadows Darwin's idea of a struggle for existence, we read: "Among millions of creatures whatever could preserve itself abides, and still after the lapse of thousands of years remains in the great harmonious order. Wild animals and tame, carnivorous and graminivorous, insects, birds, fishes and man are adapted to each other." With this may be compared a passage in the *Ursprung der Sprache*, where there is a curious adumbration of Spencer's idea that intelligence, as distinguished from instinct, arises from a growing complexity of action, or, to use Herder's words, from the substitution of a more for a less contracted sphere. Herder is more successful in tracing the early developments of particular peoples than in constructing a scientific theory of evolution. Here he may be said to have laid the foundations of the science of primitive culture as a whole. His account of the first dawns of culture, and of the ruder Oriental civilizations, is marked by genuine insight. On the other hand the development of classic culture is traced with a less skillful hand. Altogether this work is rich in suggestion to the philosophic historian and the anthropologist, though marked by much vagueness of conception and hastiness of generalization.

6. Of Herder's properly metaphysical speculations little needs to be said. He was too much under the sway of feeling and concrete imagination to be capable of great things in abstract thought. It is generally admitted that he had no accurate knowledge either of Spinoza, whose monism he advocated, or of Kant, whose critical philosophy he so fiercely attacked. Herder's Spinozism, which is set forth in his little work, *Vom Erkennen und Empfinden der menschlichen Seele* (1778), is much less logically conceived than

Lessing's. It is the religious aspect of it which attracts him, the presentation in God of an object which at once satisfies the feeling and the intellect. With respect to his attacks on the critical philosophy in the *Metakritik* (1799), it is easy to understand how his concrete mind, ever alive to the unity of things, instinctively rebelled against that analytic separation of the mental processes which Kant attempted. However crude and hasty this critical investigation, it helped to direct philosophic reflection to the unity of mind, and so to develop the post-Kantian line of speculation. Herder was much attracted by Schelling's early writings, but appears to have disliked Hegelianism because of the atheism it seemed to him to involve. In the *Kalligone* (1800), work directed against Kant's *Kritik der Urteilskraft*, Herder argues for the close connexion of the beautiful and the good. To his mind the content of art, which he conceived as human feeling and human life in its completeness, was much more valuable than the form, and so he was naturally led to emphasize the moral element in art. Thus his theoretic opposition to the Kantian aesthetics is but the reflection of his practical opposition to the form-idolatry of the Weimar poets. (J. S.)

BIBLIOGRAPHY.—An edition of Herder's *Sämmtliche Werke* in 45 vols. was published after his death by his widow (1805-1820); a second in 60 vols. followed in 1827-1830; a third in 40 vols. in 1852-1854. There is also an edition by H. Duntzer (24 vols., 1869-1879). But these have all been superseded by the monumental critical edition by B. Suphan (32 vols., 1877 seq.). Of the many "selected works," mention may be made of those by B. Suphan (4 vols., 1884-1887); by H. Lambel, H. Meyer and E. Kühnemann in Kurschner's *Deutsche Nationalliteratur* (10 vols., 1885-1894). For Herder's correspondence, see *Aus Herders Nachlass* (3 vols., 1856-1857); *Herders Reise nach Italien* (1859); *Von und aus Herder: Ungedruckte Briefe* (3 vols., 1861-1862)—all three works edited by H. Duntzer and F. G. von Herder. Herder's *Briefwechsel mit Nicolai* and his *Briefe an Hamann* have been edited by O. Hoffmann (1887 and 1889). For biography and criticism, see *Erinnerungen aus dem Leben Herders*, by his wife, edited by J. G. Müller (2 vols., 1820); *J. G. von Herders Lebensbild* (with his correspondence), by his son, E. G. von Herder (6 vols., 1846); C. Joret, *Herder et la renaissance littéraire en Allemagne au XVIII^e siècle* (1875); F. von Bärenbach, *Herder als Vorgänger Darwins* (1877); R. Haym, *Herder nach seinem Leben und seinen Werken* (2 vols., 1880-1885); H. Neivison, *A Sketch of Herder and his Times* (1884); M. Kronenberg, *Herders Philosophie nach ihrem Entwicklungsgang* (1889); E. Kühnemann, *Herders Leben* (1895); R. Bürkner, *Herder, sein Leben und Wirken* (1904).

HEREDIA, JOSÉ MARIA DE (1842-1905), French poet, the modern master of the French sonnet, was born at Fortuna Cafeyere, near Santiago de Cuba, on the 22nd of November 1842, being in blood part Spanish Creole and part French. At the age of eight he came from the West Indies to France, returning thence to Havana at seventeen, and finally making France his home not long afterwards. He received his classical education with the priests of Saint Vincent at Senlis, and after a visit to Havana he studied at the École des Chartes at Paris. In the later 'sixties, with François Coppée, Sully-Prudhomme, Paul Verlaine and others less distinguished, he made one of the band of poets who gathered round Leconte de Lisle, and received the name of Parnassiens. To this new school, form—the technical side of their art—was of supreme importance, and, in reaction against the influence of Musset, they rigorously repressed in their work the expression of personal feeling and emotion. "True poetry," said M. de Heredia in his discourse on entering the Academy—"true poetry dwells in nature and in humanity, which are eternal, and not in the heart of the creature of a day, however great." M. de Heredia's place in the movement was soon assured. He wrote very little, and published even less, but his sonnets circulated in MS., and gave him a reputation before they appeared in 1893, together with a few longer poems, as a volume, under the title of *Les Trophées*. He was elected to the Academy on the 22nd of February 1894, in the place of Louis de Mazade-Percin the publicist. Few purely literary men can have entered the Academy with credentials so small in quantity. A small volume of verse—a translation, with introduction, of Diaz del Castillo's *History of the Conquest of New Spain* (1878-1881)—a translation of the life of the nun Alferéz (1894), de Quincey's "Spanish Military Nun"—and one or two short pieces of occasional verse, and an introduction or so—this is but small literary baggage, to use the French expression. But the sonnets are of their kind among the most superb in modern literature. "A *Légende des siècles* in sonnets," M. François Coppée called them. Each presents a picture, striking, brilliant, drawn with unflinching hand—the picture of some

characteristic scene in man's long history. The verse is flawless, polished like a gem; and its sound has distinction and fine harmony. If one may suggest a fault, it is that each picture is sometimes too much of a picture only, and that the poetical line, like that of M. de Heredia's master, Leconte de Lisle himself, is occasionally overcrowded. M. de Heredia was none the less one of the most skilful craftsmen who ever practised the art of verse. In 1901 he became librarian of the Bibliothèque de l'Arsenal at Paris. He died at the Château de Bourdonné (Seine-et-Oise) on the 3rd of October 1905, having completed his critical edition of André Chénier's works.

HEREDIA Y CAMPUZANO, JOSÉ MARIA (1803-1839), Cuban poet, was born at Santiago de Cuba on the 31st of December 1803, studied at the university of Havana, and was called to the bar in 1823. In the autumn of 1823 he was arrested on a charge of conspiracy against the Spanish government, and was sentenced to banishment for life. He took refuge in the United States, published a volume of verses at New York in 1825, and then went to Mexico, where, becoming naturalized, he obtained a post as magistrate. In 1832 a collection of his poems was issued at Toluca, and in 1836 he obtained permission to visit Cuba for two months. Disappointed in his political ambitions, and broken in health, Heredia returned to Mexico in January 1837, and died at Toluca on the 21st of May 1839. Many of his earlier pieces are merely clever translations from French, English and Italian; but his originality is placed beyond doubt by such poems as the *Himno del desterrado*, the epistle to Emilia, *Desengaños*, and the celebrated ode to Niagara. Bello may be thought to excel Heredia in execution, and a few lines of Olmedo's *Canto á Junta* vibrate with a virile passion to which the Cuban poet rarely attained; but the sincerity of his patriotism and the sublimity of his imagination have secured for Heredia a real supremacy among Spanish-American poets.

The best edition of his works is that published at Paris in 1893 with a preface by Elias Zerolo.

HEREDITAMENT (from Lat. *hereditare*, to inherit, *heres*, heir), in law, every kind of property that can be inherited. Hereditaments are divided into corporeal and incorporeal; corporeal hereditaments are "such as affect the senses, and may be seen and handled by the body; incorporeal are not the subject of sensation, can neither be seen nor handled, are creatures of the mind, and exist only in contemplation" (Blackstone, *Commentaries*). An example of a corporeal hereditament is land held in freehold, of incorporeal hereditaments, tithes, advowsons, pensions, annuities, rents, franchises, &c. It is still used in the phrase "lands, tenements and hereditaments" to describe property in land, as distinguished from goods and chattels or movable property.

HEREDITY, in biological science, the name given to the generalization, drawn from the observed facts, that animals and plants closely resemble their progenitors. (That the resemblance is not complete involves in the first place the subject of variation (see VARIATION AND SELECTION); but it must be clearly stated that there is no adequate ground for the current loose statements as to the existence of opposing "laws" or "forces" of heredity and variation.) In the simplest cases there seems to be no separate problem of heredity. When a creeping plant propagates itself by runners, when a *Nais* or *Myriasis* breaks up into a series of similar segments, each of which becomes a worm like the parent, we have to do with the general fact that growing organisms tend to display a symmetrical repetition of equivalent parts, and that reproduction by fission is simply a special case of metamerism. When we try to answer the question why the segments of an organism resemble one another, whether they remain in association to form a segmented animal, or break into different animals, we come to the conclusion, which at least is on the way to an answer, that it is because they are formed from pieces of the same protoplasm, growing under similar conditions. It is apparently a fundamental property of protoplasm to be able to multiply by division into parts, the properties of which are similar to each other and to those of the parent.

This leads us directly to the cases of reproduction where there is an obvious problem of heredity. In the majority of cases among animals and plants the new organisms arise from portions of living matter, separated from the parents, but different from the parents in size and structure. These germs of the new organisms may be spores, reproductive cells, fused reproductive cells or multicellular masses (see REPRODUCTION). For the present purpose it is enough to state that they consist of portions of the parental protoplasm. These pass through an embryological history, in which by growth, multiplication and specialization they form structures closely resembling the parents. Now, if it could be shown that these reproductive masses arose directly from the reproductive masses which formed the parent body, the problems of heredity would be extremely simplified. If the first division of a reproductive cell set apart one mass to lie dormant for a time and ultimately to form the reproductive cells of the new generation, while the other mass, exactly of the same kind, developed directly into the new organism, then heredity would simply be a delayed case of what is called organic symmetry, the tendency of similar living material to develop in similar ways under the stimulus of similar external conditions. The cases in which this happens are very rare. In the Diptera the first division of the egg-cell separates the nuclear material of the subsequent reproductive cells from the material that is elaborated into the new organism to contain these cells. In the *Daphniidae* and in *Sagitta* a similar separation occurs at slightly later stages; in vertebrates it occurs much later; while in some hydroids the germ-cells do not arise in the individual which is developed from the egg-cell at all, but in a much later generation, which is produced from the first by budding. However, it is not necessary to dismiss the fertile idea of what Moritz Nussbaum and August Weismann, who drew attention to it, called "continuity of the germ-plasm." Weismann has shown that an actual series of organic forms might be drawn up in which the formation of germ-cells begins at stages successively more remote from the first division of the egg-cell. He has also shown evidence, singularly complete in the case of the hydroids, for the existence of an actual migration of the place of formation of the germ-cells, the migration reaching farther and farther from the egg-cell. He has elaborated the conception of the germ-track, a chain of cell generations in the development of any creature along which the reproductive material saved over from the development of one generation for the germ-cells of the next generation is handed on in a latent condition to its ultimate position. And thus he supposes a real continuity of the germ-plasm, extending from generation to generation in spite of the apparent discontinuity in the observed cases. The conception certainly ranks among the most luminous and most fertile contributions of the 19th century to biological thought, and it is necessary to examine at greater length the superstructure which Weismann has raised upon it.

Weismann's Theory of the Germ-plasm.—A living being takes its individual origin only where there is separated from the stock of the parent a little piece of the peculiar reproductive plasm, the so-called germ-plasm. In sexless reproduction one parent is enough; in sexual reproduction equivalent masses of germ-plasm from each parent combine to form the new individual. The germ-plasm resides in the nucleus of cells, and Weismann identifies it with the nuclear material named chromatin. Like ordinary protoplasm, of which the bulk of cell bodies is composed, germ-plasm is a living material, capable of growing in bulk without alteration of structure when it is supplied with appropriate food. But it is a living material much more complex than protoplasm. In the first place, the mass of germ-plasm which is the starting-point of a new individual consists of several, sometimes of many, pieces named "idants," which are either the chromosomes into a definite number of which the nuclear material of a dividing cell breaks up, or possibly smaller units named chromomeres. These idants are a collection of "ids," which Weismann tentatively identifies with the microsomata contained in the chromosomes, which are visible after treatment with certain reagents. Each id contains all the possibilities—

generic, specific, individual—of a new organism, or rather the directing substance which in appropriate surroundings of food, &c., forms a new organism. Each id is a veritable microcosm, possessed of an historic architecture that has been elaborated slowly through the multitudinous series of generations that stretch backwards in time from every living individual. This microcosm, again, consists of a number of minor vital units called "determinants," which cohere according to the architecture of the whole id. The determinants are hypothetical units corresponding to the number of parts of the organism independently variable. Lastly, each determinant consists of a number of small hypothetical units, the "biophores." These are adaptations of a conception of H. de Vries, and are supposed to become active by leaving the nucleus of the cell in which they lie, passing out into the general protoplasm of the cell and ruling its activities. Each new individual begins life as a nucleated cell, the nucleus of which contains germ-plasm of this complex structure derived from the parent. The reproductive cell gives rise to the new individual by continued absorption of food, by growth, cell-divisions and cell-specializations. The theory supposes that the first divisions of the nucleus are "doubling," or homogeneous divisions. The germ-plasm has grown in bulk without altering its character in any respect, and, when it divides, each resulting mass is precisely alike. From these first divisions a chain of similar doubling divisions stretches along the "germ-tracks," so marshalling unaltered germ-plasm to the generative organs of the new individual, to be ready to form the germ-cells of the next generation. In this mode the continuity of the germ-plasm from individual to individual is maintained. This also is the immortality of the germ-cells, or rather of the germ-plasm, the part of the theory which has laid so large a hold on the popular imagination, although it is really no more than a reassertion in new terms of biogenesis. With this also is connected the celebrated denial of the inheritance of acquired characters. It seemed a clear inference that, if the hereditary mass for the daughters were separated off from the hereditary mass that was to form the mother, at the very first, before the body of the mother was formed, the daughters were in all essentials the sisters of their mother, and could take from her nothing of any characters that might be impressed on her body in subsequent development. In the later elaboration of his theory Weismann has admitted the possibility of some direct modification of the germ-plasm within the body of the individual acting as its host.

The mass of germ-plasm which is not retained in unaltered form to provide for the generative cells is supposed to be employed for the elaboration of the individual body. It grows, dividing and multiplying, and forms the nuclear matter of the tissues of the individual, but the theory supposes this process to occur in a peculiar fashion. The nuclear divisions are what Weismann calls "differentiating" or heterogeneous divisions. In them the microcosms of the germ-plasm are not doubled, but slowly disintegrated in accordance with the historical architecture of the plasm, each division differentiating among the determinants and marshalling one set into one portion, another into another portion. There are differences in the observed facts of nuclear division which tend to support the theoretical possibility of two sorts of division, but as yet these have not been correlated definitely with the divisions along the germ-tracks and the ordinary divisions of embryological organogeny. The theoretical conception is, that when the whole body is formed, the cells contain only their own kind of determinants, and it would follow from this that the cells of the tissues cannot give rise to structures containing germ-plasm less disintegrated than their own nuclear material, and least of all to reproductive cells which must contain the undisintegrated microcosms of the germ-plasm. Cases of bud-formation and of reconstructions of lost parts (see REGENERATION OF LOST PARTS) are regarded as special adaptations made possible by the provision of latent groups of accessory determinants, to become active only on emergency.

It is to be noticed that Weismann's conception of the processes of ontogeny is strictly evolutionary, and in so far as a reversion

to the general opinion of biologists of the 17th and 18th centuries. These supposed that the germ-cell contained an image-in-little of the adult, and that the process of development was a mere unfolding or evolution of this, under the influence of favouring and nutrient forces. Hartsoecker, indeed, went so far as to figure the human spermatozoon with a mannikin seated within the "head," and similar extremes of imagination were indulged in by other writers for the spermatozoon or ovum, according to the view they took of the relative importance of these two bodies. C. F. Wolff, in his *Theoria generationis* (1759), was the first distinguished anatomist to make assault on these evolutionary views, but his direct observations on the process of development were not sufficient in bulk nor in clarity of interpretation to convince his contemporaries. Naturally the improved methods and vastly greater knowledge of modern days have made evolution in the old sense an impossible conception; we know that the egg is morphologically unlike the adult, that various external conditions are necessary for its subsequent progress through a slow series of stages, each of which is unlike the adult, but gradually approaching it until the final condition is reached. None the less, Weismann's theory supposes that the important determining factor in these gradual changes lies in the historical architecture of the germ-plasm, and from the theoretical point of view his theory remains strictly an unfolding, a becoming manifest of hidden complexity.

Hertwig's View.—The chief modern holder of the rival view, and the writer who has put together in most cogent form the objections to Weismann's theory, is Oscar Hertwig. He points out that there is no direct evidence for the existence of differentiating as opposed to doubling divisions of the nuclear matter, and, moreover, he thinks that there is very generally diffused evidence as to the universality of doubling division. In the first place, there is the fundamental fact that single-celled organisms exhibit only doubling division, as by that the persistence of species which actually occurs alone is possible. In the case of higher plants, the widespread occurrence of tissues with power of reproduction, the occurrence of budding in almost any part of the body in lower animals and in plants, and the widespread powers of regeneration of lost parts, are easily intelligible if every cell like the egg-cell has been formed by doubling division, and so contains the germinal material for every part of the organism, and thus, on the call of special conditions, can become a germ-cell again. He lays special stress on those experiments in which the process of development has been interfered with in various ways at various stages, as showing that the cells which arise from the division of the egg-cell were not predestined unalterably for a particular rôle, according to a predetermined plan. He dismisses Weismann's suggestion of the presence of accessory determinants which remain latent unless they happen to be required, as being too complicated a supposition to be supported without exact evidence, a view in which he has received strong support from those who have worked most at the experimental side of the question. From consideration of a large number of physiological facts, such as the results of grafting, transplantations of tissues and transfusions of blood, he concludes that the cells of an organism possess, in addition to their patent microscopical characters, latent characters peculiar to the species, and pointing towards a fundamental identity of the germinal substance in every cell.

The Nuclear Matter.—Apart from these two characteristic protagonists of extreme and opposing views, the general consensus of biological opinion does not take us very far beyond the plainest facts of observation. The resemblances of heredity are due to the fact that the new organism takes its origin from a definite piece of the substance of its parent or parents. This piece always contains protoplasm, and as the protoplasm of every animal and plant appears to have its own specific reactions, we cannot exclude this factor; indeed many, following the views of M. Verworn, and seeing in the specific metabolisms of protoplasm a large part of the meaning of life, attach an increasing importance to the protoplasm in the hereditary mass. Next, it always contains nuclear matter, and, in view of the extreme

specialization of the nuclear changes in the process of maturation and fertilization of the generative cells, there is more than sufficient reason for believing that the nuclear substance, if not actually the specific germ-plasm, is of vast importance in heredity. The theory of its absolute dominance depends on a number of experiments, the interpretation of which is doubtful. Moritz Nussbaum showed that in Infusoria non-nucleated fragments of a cell always died, while nucleated fragments were able to complete themselves; but it may be said with almost equal confidence that nuclei separated from protoplasm also invariably die—at least, all attempts to preserve them have failed. Hertwig and others, in their brilliant work on the nature of fertilization, showed that the process always involved the entrance into the female cell of the nucleus of the male cell, but we now know that part of the protoplasm of the spermatozoon also enters. T. Boveri made experiments on the cross-fertilization of non-nucleated fragments of the eggs of *Sphaerechinus granularis* with spermatozoa of *Echinus microtuberculatus*, and obtained dwarf larvae with only the paternal characters; but the nature of his experiments was not such as absolutely to exclude doubt. Finally, in addition to the nucleus and the protoplasm, another organism of the cell, the centrosome, is part of the hereditary mass. In sum, while most of the evidence points to a preponderating importance of the nuclear matter, it cannot be said to be an established proposition that the nuclear matter is the germ-plasm. Nor are we yet definitely in a position to say that the germinal mass (nuclear matter, protoplasm, &c., of the reproductive cells) differs essentially from the general substance of the organism—whether, in fact, there is continuity of germ-plasm as opposed to continuity of living material from individual to individual. The origin of sexual cells from only definite places, in the vast majority of cases, and such phenomena as the phylogenetic migration of their place of origin among the Hydro-medusae, tell strongly in favour of Weismann's conception. Early experiments on dividing eggs, in which, by separation or transposition, cells were made to give rise to tissues and parts of the organism which in the natural order they would not have produced, tell strongly against any profound separation between germ-plasm and body-plasm. It is also to be noticed that the failure of germ-cells to arise except in specific places may be only part of the specialized ordering of the whole body, and does not necessarily involve the interpretation that reproductive material is absolutely different in kind.

Amphimixis.—Hitherto we have considered the material bearer of heredity apart from the question of sexual union, and we find that the new organism takes origin from a portion of living matter, forming a material which may be called germ-plasm, in which resides the capacity to correspond to the same kind of surrounding forces as stimulated the parent germ-plasm by growth of the same fashion. In many cases (e.g. asexual spores) the piece of germ-plasm comes from one parent, and from an organ or tissue not associated with sexual reproduction; in other cases (parthenogenetic eggs) it comes from the ovary of a female, and may have the apparent characters of a sexual egg, except that it develops without fertilization; here also are to be included the cases where normal female ova have been induced to develop, not by the entrance of a spermatozoon, but by artificial chemical stimulation. In such cases the problem of heredity does not differ fundamentally from the symmetrical repetition of parts. In most of the higher plants and animals, however, sexual reproduction is the normal process, and from our present point of view the essential feature of this is that the germ-plasm which starts the new individual (the fertilized egg) is derived from the male (the spermatozoon) and from the female parent (the ovum). Although it cannot yet be set down sharply as a general proposition, there is considerable evidence to show that in the preparation of the ovum and spermatozoon for fertilization the nuclear matter of each is reduced by half (reducing division of the chromosomes), and that fertilization means the restoration of the normal bulk in the fertilized cell by equal contributions from male and female. So far as the known facts of this process of union of germ-plasms go, they take us no

farther than to establish such a relation between the offspring and two parents as exists between the offspring and one parent in the other cases. Amphimixis has a vast importance in the theory of evolution (Weismann, for instance, regards it as the chief factor in the production of variations); for its relation to heredity we are as yet dependent on empirical observations.

Heredity and Development.—The actual process by which the germinal mass slowly assumes the characters of the adult—that is, becomes like the parent—depends on the interaction of two sets of factors: the properties of the germinal material itself, and the influences of substances and conditions external to the germinal material. Naturally, as K. W. von Nägeli and Hertwig in particular have pointed out, there is no perpetual sharp contrast between the two sets of factors, for, as growth proceeds, the external is constantly becoming the internal; the results of influences, which were in one stage part of the environment, are in the next and subsequent stages part of the embryo. The differences between the exponents of evolution and epigenesis offer practical problems to be decided by experiment. Every phenomenon in development that is proved the direct result of epigenetic factors can be discounted from the complexity of the germinal mass. If, for instance, as H. Driesch and Hertwig have argued, much of the differentiation of cells and tissues is a function of locality and is due to the action of different external forces on similar material, then just so much burden is removed from what evolutionists have to explain. That much remains cannot be doubted. Two eggs similar in appearance develop side by side in the same sea-water, one becoming a mollusc, the other an *Amphioxus*. Hertwig would say that the slight differences in the original eggs would determine slight differences in metabolism and so forth, with the result that the segmentation of the two is slightly different; in the next stage the differences in metabolisms and other relations will be increased, and so on indefinitely. But in such cases *c'est le premier pas qui coûte*, and the absolute cost in theoretical complexity of the germinal material can be estimated only after a prolonged course of experimental work in a field which is as yet hardly touched.

Empirical Study of Heredity.—The fundamental basis of heredity is the separation of a mass from the parent (germ-plasm) which under certain conditions grows into an individual resembling the parent. The goal of the study of heredity will be reached only when all the phenomena can be referred to the nature of the germ-plasm and of its relations to the conditions under which it grows, but we have seen how far our knowledge is from any attempt at such references. In the meantime, the empirical facts, the actual relations of the characters in the offspring to the characters of the parents and ancestors, are being collected and grouped. In this inquiry it at once becomes obvious that every character found in a parent may or may not be present in the offspring. When any character occurs in both, it is generally spoken of as transmissible and of having been transmitted. In this broad sense there is no character that is not transmissible. In all kinds of reproduction, the characters of the class, family, genus, species, variety or race, and of the actual individual, are transmissible, the certainty with which any character appears being almost in direct proportion to its rank in the descending scale from order to individual. The transmitted characters are anatomical, down to the most minute detail; physiological, including such phenomena as diathesis, timbre of voice and even compound phenomena, such as *gawcherie* and peculiarity of handwriting; psychological; pathological; teratological, such as syndactylism and all kinds of individual variations. Either sex may transmit characters which in themselves are necessarily latent, as, for instance, a bull may transmit a good milking strain. In forms of asexual reproduction, such as division, budding, propagation by slips and so forth, every character of the parent may appear in the descendant, and apparently even in the descendants produced from that descendant by the ordinary sexual processes. In reproduction by spore formation, in parthenogenesis and in ordinary sexual modes, where there is an embryological history between the separated mass and the new adult, it is necessary

to attempt a difficult discrimination between acquired and innate characters.

Acquired Characters.—Every character is the result of two sets of factors, those resident in the germinal material and those imposed from without. Our knowledge has taken us far beyond any such idea as the formation of a germinal material by the collection of particles from the adult organs and tissues (gemules of C. Darwin). The inheritance of any character means the transmission in the germinal material of matter which, brought under the necessary external conditions, develops into the character of the parent. There is necessarily an acquired or epigenetic side to every character; but there is nothing in our knowledge of the actual processes to make necessary or even probable the supposition that the result of that factor in one generation appears in the germ-plasm of the subsequent generations, in those cases where an embryological development separates parent and offspring. The development of any normal, so-called "innate," character, such as, say, the assumption of the normal human shape and relations of the frontal bone, requires the co-operation of many factors external to the developing embryo, and the absence of abnormal distorting factors. When we say that such an innate character is transmitted, we mean only that the germ-plasm has such a constitution that, in the presence of the epigenetic factors and the absence of abnormal epigenetic factors, the bone will appear in due course and in due form. If an abnormal epigenetic factor be applied during development, whether to the embryo *in utero*, to the developing child, or in after life, abnormality of some kind will appear in the bone, and such an abnormality is a good type of what is spoken of as an "acquired" character. Naturally such a character varies with the external stimulus and the nature of the material to which the stimulus is applied, and probability and observation lead us to suppose that as the germ-plasm of the offspring is similar to that of the parent, being a mass separated from the parent, abnormal epigenetic influences would produce results on the offspring similar to those which they produced on the parent. Scrutiny of very many cases of the supposed inheritance of acquired characters shows that they may be explained in this fashion—that is to say, that they do not necessarily involve any feature different in kind from what we understand to occur in normal development. The effects of increased use or of disuse on organs or tissues, the reactions of living tissues to various external influences, to bacteria, to bacterial or other toxins, or to different conditions of respiration, nutrition and so forth, we know empirically to be different in the case of different individuals, and we may expect that when the living matter of a parent responds in a certain way to a certain external stimulus, the living matter of the descendant will respond to similar circumstances in a similar fashion. The operation of similar influences on similar material accounts for a large proportion of the facts. In the important case of the transmission of disease from parent to offspring it is plain that three sets of normal factors may operate, and other cases of transmission must be subjected to similar scrutiny: (1) a child may inherit the anatomical and physiological constitution of either parent, and with that a special liability of failure to resist the attacks of a wide-spread disease; (2) the actual bacteria may be contained in the ovum or possibly in the spermatozoon; (3) the toxins of the disease may have affected the ovum, or the spermatozoon, or through the placenta the growing embryo. Obviously in the first two cases the offspring cannot be said in any strict sense to have inherited the disease; in the last case, the theoretical nomenclature is more doubtful, but it is at least plain that no inexplicable factor is involved.

It is to be noticed, however, that "Lamarckians" and "Neo-Lamarckians" in their advocacy of an inheritance of "acquired characters" make a theoretical assumption of a different kind, which applies equally to "acquired" and to "innate" characters. They suppose that the result of the epigenetic factors is reflected on the germ-plasm in such a mode that in development the products would display the same or a similar character without the co-operation of the epigenetic factors on the new

individual, or would display the result in an accentuated form if with the renewed co-operation of the external factors. Such an assumption presents its greatest theoretical difficulty if, with Weismann, we suppose the germ-plasm to be different in kind from the general soma-plasm, and its least theoretical difficulty if, with Hertwig, we suppose the essential matter of the reproductive cells to be similar in kind to the essential substance of the general body cells. But, apart from the differences between such theories, it supposes, in all cases where an embryological development lies between parent and descendant, the existence of a factor towards which our present knowledge of the actual processes gives us no assistance. The separated hereditary mass does not contain the organs of the adult; the Lamarckian factor would involve the translation of the characters of the adult back into the characters of the germ-cell in such a fashion that when the germ-cell developed these characters would be re-translated again into those which originally had been produced by co-operation between germ-plasm characters and epigenetic factors. In the present state of our knowledge the theoretical difficulty is not fatal to the Lamarckian supposition; it does no more than demand a much more careful scrutiny of the supposed cases. Such a scrutiny has been going on since Weismann first raised the difficulty, and the present result is that no known case has appeared which cannot be explained without the Lamarckian factor, and the vast majority of cases have been resolved without any difficulty into the ordinary events of which we have full experience. Taking the empirical data in detail, it would appear first that the effects of single mutilations are not inherited. The effects of long-continued mutilations are not inherited, but Darwin cites as a possible case the Mahomedans of Celebes, in whom the prepuce is very small. C. E. Brown-Séquard thought that he had shown in the case of guinea-pigs the inheritance of the results of nervous lesions, but analyses of his results leave the question extremely doubtful. The inheritance of the effects of use and disuse is not proved. The inheritance of the effects of changed conditions of life is quite uncertain. Nägeli grew Alpine plants at Munich, but found that the change was produced at once and was not increased in a period of thirteen years. Alphonse de Candolle starved plants, with the result of producing better blooms, and found that seedlings from these were also above the average in luxuriance of blossom, but in these experiments the effects of selection during the starvation, and of direct effect on the nutrition of the seeds, were not eliminated. Such results are typical of the vast number of experiments and observations recorded. The empirical issue is doubtful, with a considerable balance against the supposed inheritance of acquired characters.

Empirical Study of Effects of Amphimixis.—Inheritance is theoretically possible from each parent and from the ancestry of each. In considering the total effect it is becoming customary to distinguish between "blended" inheritance, where the offspring appears in respect of any character to be intermediate between the conditions in the parents; "prepotent" inheritance, where one parent is supposed to be more effective than the other in stamping the offspring (thus, for instance, Negroes, Jews and Chinese are stated to be prepotent in crosses); "exclusive" inheritance, where the character of the offspring is definitely that of one of the parents. Such a classification depends on the interpretation of the word character, and rests on no certain grounds. An apparently blended character or a prepotent character may on analysis turn out to be due to the inheritance of a certain proportion of minuter characters derived exclusively from either parent. H. de Vries and later on a number of other biologists have advanced the knowledge of heredity in crosses by carrying out further the experimental and theoretical work of Gregor Mendel (see MENDELISM and HYBRIDISM), and results of great practical importance to breeders have already been obtained. These experiments and results, however, appear to relate exclusively to sexual reproduction and almost entirely to the crossing of artificial varieties of animals and plants. So far as they go, they point strongly to the occurrence of alternate inheritance instead of blended inheritance in the case of artificial

varieties. On the other hand, in the case of natural varieties it appears that blended inheritance predominates. The difficulty of the interpretation of the word "character" still remains and the Mendelian interpretation cannot be dismissed with regard to the behaviour of any "character" in inheritance until it is certain that it is a unit and not a composite. There is another fundamental difficulty in making empirical comparisons between the characters of parents and offspring. At first sight it seems as if this mode of work were sufficiently direct and simple, and involved no more than a mere collection of sufficient data. The cranial index, or the height of a human being and of so many of his ancestors being given, it would seem easy to draw an inference as to whether or no in these cases brachycephaly or stature were inherited. But our modern conceptions of the individual and the race make it plain that the problems are not so simple. With regard to any character, the race type is not a particular measurement, but a curve of variations derived from statistics, and any individual with regard to the particular character may be referable to any point of the curve. A tall race like the modern Scots may contain individuals of any height within the human limits; a dolichocephalic race like the modern Spaniards may contain extremely round-headed individuals. What is meant by saying that one race is tall or the other dolichocephalic, is merely that if a sufficiently large number be chosen at random, the average height of the one race will be great, the cranial index of the other low. It follows that the study of variation must be associated with, or rather must precede, the empirical study of heredity, and we are beginning to know enough now to be certain that in both cases the results to be obtained are practically useless for the individual case, and of value only when large masses of statistics are collected. No doubt, when general conclusions have been established, they must be acted on for individual cases, but the results can be predicted not for the individual case, but only for the average of a mass of individual cases. It is impossible within the limits of this article to discuss the mathematical conceptions involved in the formation and applications of the method, but it is necessary to insist on the fact that these form an indispensable part of any valuable study of empirical data. One interesting conclusion, which may be called the "ancestral law" of heredity, with regard to any character, such as height, which appears to be a blend of the male and female characters, whether or no the apparent blend is really due to an exclusive inheritance of separate components, may be given from the work of F. Galton and K. Pearson. Each parent, on the average, contributes $\frac{1}{2}$ or $(0.5)^1$, each grandparent $\frac{1}{4}$ or $(0.5)^2$, and each ancestor of n^{th} place $(0.5)^n$. But this, like all other deductions, is applicable only to the mass of cases and not to any individual case.

Regression.—An important result of quantitative work brings into prominence the steady tendency to maintain the type which appears to be one of the most important results of amphimixis. In the tenth generation a man has 1024 tenth grandparents, and is thus the product of an enormous population, the mean of which can hardly differ from that of the general population. Hence this heavy weight of mediocrity produces regression or progression to type. Thus in the case of height, a large number of cases being examined, it was found that fathers of a stature of 72 in. had sons with a mean stature of 70.8 in., a regression towards the normal stature of the race. Fathers with a stature of 66 in. had sons with a mean of 68.3 in., a progression towards the normal. It follows from this that where there is much in-and-in breeding the weight of mediocrity will be less, and the peculiarities of the breed will be accentuated.

Atavism.—Under this name a large number of ordinary cases of variation are included. A tall man with very short parents would probably be set down as a case of atavism if the existence of a very tall ancestor were known. He would, however, simply be a case of normal variation, the probability of which may be calculated from a table of stature variations in his race. Less marked cases set down to atavism may be instances merely of normal regression. Many cases of more abnormal structure, which are really due to abnormal embryonic or post-embryonic

development, are set down to atavism, as, for instance, the cervical fistulae, which have been regarded as atavistic persistences of the gill clefts. It is also used to imply the reversion that takes place when domestic varieties are set free and when species or varieties are crossed (see *HYBRIDISM*). Atavism is, in fact, a misleading name covering a number of very different phenomena.

Telegony is the name given to the supposed fact that offspring of a mother to one sire may inherit characters from a sire with which the mother had previously bred. Although breeders of stock have a strong belief in the existence of this, there are no certain facts to support it, the supposed cases being more readily explained as individual variations of the kind generally referred to as "atavism." None the less, two theoretical explanations have been suggested: (1) that spermatozoa, or portions of spermatozoa, from the first sire may occasionally survive within the mother for an abnormally long period; (2) that the body, or the reproductive cells of the mother, may be influenced by the growth of the embryo within her, so that she acquires something of the character of the sire. The first supposition has no direct evidence to support it, and is made highly improbable from the fact that a second impregnation is always necessary. Against the second supposition Pearson brings the cogent empirical evidence that the younger children of the same sire show no increased tendency to resemble him. (See *TELEGONY*.)

AUTHORITIES.—The following books contain a fair proportion of the new and old knowledge on this subject:—W. Bateson, *Materials for the Study of Variation* (1894); Y. Dclage, *La Structure du protoplasma et les théories sur l'hérédité* (a very full discussion and list of literature); G. H. T. Eimer, *Organic Evolution*, Eng. trans. by Cunningham (1890); J. C. Ewart, *The Penycuik Experiments* (1899); F. Galton, *Natural Inheritance* (1887); O. Hertwig, *Evolution of Epigenesis?* Eng. trans. by P. C. Mitchell (1896); K. Pearson, *The Grammar of Science* (1900); Verworn, *General Physiology*, Eng. trans. (1899); A. Weismann, *The Germ Plasm*, Eng. trans. by Parker (1893). Lists of separate papers are given in the annual volumes of the *Zoological Record* under heading "General Subject." (P.C.M.)

HEREFORD, a city and municipal and parliamentary borough, and the county town of Herefordshire, England, on the river Wye, 144 m. W.N.W. of London, on the Worcester-Cardiff line of the Great Western railway and on the west-and-north joint line of that company and the North-Western. It is connected with Ross and Gloucester by a branch of the Great Western, and is the terminus of a line from the west worked by the Midland and Neath & Brecon companies. Pop. (1901) 21,382. It is mainly on the left bank of the river, which here traverses a broad valley, well wooded and pleasant. The cathedral of St Ethelbert exemplifies all styles from Norman to Perpendicular. The see was detached from Lichfield in 676, Putta being its first bishop; and the modern diocese covers most of Herefordshire, a considerable part of Shropshire, and small portions of Worcester-shire, Staffordshire and Monmouthshire; extending also a short distance across the Welsh border. The removal of murdered Aethelbert's body from Marden to Hereford led to the foundation of a superior church, reconstructed by Bishop Athelstane, and burnt by the Welsh in 1055. Begun again in 1079 by Bishop Robert Losinga, it was carried on by Bishop Reynelm and completed in 1148 by Bishop R. de Betun. In 1786 the great western tower fell and carried with it the west front and the first bay of the nave, when the church suffered much from unhappy restoration by James Wyatt, but his errors were partly corrected by the further work of Lewis Cottingham and Sir Gilbert Scott in 1841 and 1863 respectively, while the present west front is a reconstruction completed in 1905. The total length of the cathedral outside is 342 ft., inside 327 ft. 5 in., the nave being 158 ft. 6 in., the choir from screen to reredos 75 ft. 6 in. and the lady chapel 93 ft. 5 in. Without, the principal features are the central tower, of Decorated work with ball-flower ornament, formerly surmounted by a timber spire; and the north porch, rich Perpendicular with parvise. The lady chapel has a bold east end with five narrow lancet windows. The bishop's cloisters, of which only two walks remain, are Perpendicular of curious design, with heavy tracery in the bays. A picturesque tower

at the south-east corner, in the same style, is called the "Lady Arbour," but the origin of the name is unknown. Of the former fine hexagonal Decorated chapter-house, only the doorway and slight traces remain. Within, the nave has Norman arcades, showing the wealth of ornament common to the work of this period in the church. Wyatt shortened it by one bay, and the clerestory is his work. There is a fine late Norman font, springing from a base with the rare design of four lions at the corners. The south transept is also Norman, but largely altered by the introduction of Perpendicular work. The north transept was wholly rebuilt in 1287 to contain the shrine of St Thomas de Cantilupe, bishop of Hereford, of which there remains the magnificent marble pedestal surmounted by an ornate arcade. The fine lantern, with its many shafts and vaulting, was thrown open to the floor of the bell-chamber by Cottingham. The choir screen is a florid design by Sir Gilbert Scott, in light wrought iron, with a wealth of ornament in copper, brass, mosaic and polished stones. The dark choir is Norman in the arcades and the stage above, with Early English clerestory and vaulting. At the east end is a fine Norman arch, blocked until 1841 by a Grecian screen erected in 1717. The choir stalls are largely Decorated. The organ contains original work by the famous builder Renuart Harris, and was the gift of Charles II. to the cathedral. The small north-east and south-east transepts are Decorated but retain traces of the Norman apsidal terminations eastward. The eastern lady chapel, dated about 1220, shows elaborate Early English work. On the south side opens the little Perpendicular chantry of Bishop Audley (1492-1502). In the north choir aisle is the beautiful fan-vaulted chantry of Bishop Stanbury (1470). The crypt is remarkable as being, like the lady chapel, Early English, and is thus the only cathedral crypt in England of a later date than the 11th century. The ancient monastic library remains in the archive room, with its heavy oak cupboards. Deeds, documents and several rare manuscripts and relics are preserved, and several of the precious books are still secured by chains. But the most celebrated relic is in the south choir aisle. This is the Map of the World, dating from about 1314, the work of a Lincolnshire monk, Richard of Haldingham. It represents the world as surrounded by ocean, and embodies many ideas taken from Herodotus, Pliny and other writers, being filled with grotesque figures of men, beasts, birds and fishes, together with representations of famous cities and scenes of scriptural classical story, such as the Labyrinth of Crete, the Egyptian pyramids, Mount Sinai and the journeyings of the Israelites. The map is surmounted by representations of Paradise and the Day of Judgment.

From the south-east transept of the cathedral a cloister leads to the quadrangular college of the Vicars-Choral, a beautiful Perpendicular building. On this side of the cathedral, too, the bishop's palace, originally a Norman hall, overlooks the Wye, and near it lies the castle green, the site of the historic castle, which is utterly effaced. There is here a column (1809) commemorating the victories of Nelson. The church of All Saints is Early English and Decorated, and has a lofty spire. Both this and St Peter's (originally Norman) have good carved stalls, but the fabric of both churches is greatly restored. One only of the six gates and a few fragments of the old walls are still to be seen, but there are ruins of the Black Friars' Monastery in Widemarsh, and a mile out of Hereford on the Brecon Road, the White Cross, erected in 1347 by Bishop Louis Charlton, and restored by Archdeacon Lord Saye and Sele, commemorates the departure of the Black Plague. Of domestic buildings the "Old House" is a good example of the picturesque half-timbered style, dating from 1621, and the Coningsby Hospital (almshouses) date from 1614. The inmates wear a remarkable uniform of red, designed by the founder, Sir T. Coningsby. St Ethelbert's hospital is an Early English foundation. Old-established schools are the Cathedral school (1384) and the Blue Coat school (1710); there is also the County College (1880). The public buildings are the shire hall in St Peter's Street, in the Grecian Doric style, with a statue in front of it of Sir George Cornwall Lewis, who represented the county in parliament from 1847 to 1852, the

town hall (1904), the corn-exchange (1858), the free library and museum in Broad Street; the guildhall and mansion house. A musical festival of the choirs of Hereford, Gloucester and Worcester cathedrals is held annually in rotation at these cities.

The government is in the hands of a municipal council consisting of a mayor, 6 aldermen and 18 councillors. Area, 5031 acres.

Hereford (*Hereforunn*), founded after the crossing of the Severn by the West Saxons early in the 7th century, had a strategic importance due to its proximity to the Welsh March. The foundation of the castle is ascribed to Earl Harold, afterwards Harold II. The castle was successfully besieged by Stephen, and was the prison of Prince Edward during the Barons' Wars. The pacification of Wales deprived Hereford of military significance until it became a Royalist stronghold during the Civil Wars. It surrendered easily to Waller in 1643; but was reoccupied by the king's troops and received Rupert on his march to Wales after Naseby. It was besieged by the Scots during August 1645 and relieved by the king. It fell to the Parliamentarians in this year. In 1086 the town included fees of the bishop, the dean and chapter, and the Knights Hospitallers, but was otherwise royal demesne. Richard I. in 1189 sold their town to the citizens at a fee farm rent, which grant was confirmed by John, Henry III., Edward II., Edward III., Richard II., Henry IV. and Edward IV. Incorporation was granted to the mayor, aldermen and citizens in 1597, and confirmed in 1620 and 1697-1698. Hereford returned two members to parliament from 1295 until 1885, when the Redistribution Act deprived it of one representative. In 1116-1117 a fair beginning on St Ethelbert's day was conferred on the bishop, the antecedent of the modern fair in the beginning of May. A fair beginning on St Denis' day, granted to the citizens in 1226-1227, is represented by that held in October. The fair of Easter Wednesday was granted in 1682. In 1792 the existing fairs of Candlemas week and the beginning of July were held. Market days were, under Henry VIII. and in 1792, Wednesday, Friday and Saturday; the Friday market was discontinued before 1835. Hereford was the site of a provincial mint in 1086 and later. A grant of an exclusive merchant gild, in 1215-1216, was several times confirmed. The trade in wool was important in 1202, and eventually responsible for gilds of tailors, drapers, mercers, dyers, fullers, cloth workers, weavers and haberdashers; it brought into the market Welsh friezes and white cloth; but declined in the 16th century, although it existed in 1835. The leather trade was considerable in the 13th century. In 1835 the glove trade had declined. The city anciently had an extensive trade in bread with Wales. It was the birthplace of David Garrick, the actor, in 1716, and probably of Nell Gwyn, mistress of Charles II., to whose memory a tablet was erected in 1883, marking the supposed site of her house.

See R. Johnson, *Ancient Customs of Hereford* (London, 1882); J. Duncumbe, *History of Hereford* (Hereford, 1882); *Journal of Brit. Arch. Assoc.* xvi.

HEREFORDSHIRE, an inland county of England on the south Welsh border, bounded N. by Shropshire, E. by Worcestershire, S. by Monmouthshire and Gloucestershire, and W. by Radnorshire and Brecknockshire. The area is 839.6 sq. m. The county is almost wholly drained by the Wye and its tributaries, but on the north and east includes a small portion of the Severn basin. The Wye enters Herefordshire from Wales at Hay, and with a sinuous and very beautiful course crosses the south-western part of the county, leaving it close above the town of Monmouth. Of its tributaries, the Lugg enters in the north-west near Presteign, and has a course generally easterly to Leominster, where it turns south, receives the Arrow from the west, and joins the Wye 6 m. below Hereford, the Frome flowing in from the east immediately above the junction. The Monnow rising in the mountains of Brecknockshire forms the boundary between Herefordshire and Monmouthshire over one-half of its course (about 20 m.), but it joins the main river at Monmouth. Its principal tributary in Herefordshire is the Dore, which traverses the picturesque Golden Valley. The Wye is celebrated for its

salmon fishing, which is carefully preserved, while the Lugg, Arrow and Frome abound in trout and grayling, as does the Teme. This last is a tributary of the Severn, and only two short reaches lie within this county in the north, while it also forms parts of the northern and eastern boundary. The Leddon, also flowing to the Severn, rises in the east of the county and leaves it in the south-east, passing the town of Ledbury. High ground, of an elevation from 500 to 800 ft., separates the various valleys, while on the eastern boundary rise the Malvern Hills, reaching 1194 ft. in the Herefordshire Beacon, and 1395 ft. in the Worcestershire Beacon, and on the boundary with Brecknockshire the Black Mountains exceed 2000 ft. The scenery of the Wye, with its wooded and often precipitous banks, is famous, the most noteworthy point in this county being about Symond's Yat, on the Gloucestershire border below Ross.

Geology.—The Archean or Pre-Cambrian rocks, the most ancient in the county, emerge from beneath the newer deposits in three small isolated areas. On the western border, Stanner Rock, a picturesque craggy hill near Kington, consists of igneous materials (granitoid rock, felsone, dolerite and gabbro), apparently of intrusive origin and possibly of Uriconian age. In Brampton Bryan Park, a few miles to the north-east, some ancient conglomerates emerge and may be of Longmyndian age. On the east of the county the Herefordshire Beacon in the Malvern chain consists of gneisses and schists and Uriconian volcanic rocks; these have been thrust over various members of the Cambrian and Silurian systems, and owing to their hard and durable nature they form the highest ground in the county. The Cambrian rocks (Tremadoc Beds) come next in order of age and consist of quartzites, sandstones and shales, well exposed at the southern end of the Malvern chain and also at Podwardine near Brampton Bryan. The Silurian rocks are well developed in the north-west part of the county, between Presteign and Ludlow; also along the western flanks of the Malvern Hills and in the eroded dome of Woolhope. Smaller patches come to light at Westhide east of Hereford and at May Hill near Newent. They consist of highly fossiliferous sandstones, mudstones, shales and limestones, known as the Llandoverly, Wenlock and Ludlow Series; the Woolhope, Wenlock and Aymestry Limestones are famed for their rich fossil contents. The remainder and by far the greater part of the county is occupied by the Old Red Sandstone, through which the rocks above described project in detached areas. The Old Red Sandstone consists of a great thickness of red sandstones and marls, with impersistent bands of impure concretionary limestone known as constones, which by their superior hardness give rise to scarps and rounded ridges; they have yielded remains of fishes and crustaceans. Some of the upper beds are conglomeratic. On its south-eastern margin the county just reaches the Carboniferous Limestone cliffs of the Wye Valley near Ross. Glacial deposits, chiefly sand and gravel, are found in the lower ground along the river-courses, while caves in the Carboniferous Limestone have yielded remains of the hyena, cave-lion, rhinoceros, mammoth and reindeer.

Agriculture and Industries.—The soil is generally marl and clay, but in various parts contains calcareous earth in mixed proportions. Westward the soil is tenacious and retentive of water; on the east it is a stiff and often reddish clay. In the south is found a light sandy loam. More than four-fifths of the total area of the county is under cultivation and about two-thirds of this is in permanent pasture. Ash and oak coppices and larch plantations clothe its hillsides and crests. The rich red soil of the Old Red Sandstone formation is famous for its pear and apple orchards, the county, notwithstanding its much smaller area, ranking in this respect next to Devonshire. The apple crop, generally large, is enormous one year out of four. Twenty hogheads of cider have been made from an acre of orchard, twelve being the ordinary yield. Cider is the staple beverage of the county, and the trade in cider and perry is large. Hops are another staple of the county, the vines of which are planted in rows on ploughed land. As early as Camden's day a Herefordshire adage coupled Weobley ale with Leominster bread, indicating the county's capacity to produce fine wheat and barley, as well as hops.

Herefordshire is also famous as a breeding county for its cattle of bright red hue, with mottled or white faces and sleek silky coats. The Herefords are stalwart and healthy, and, though not good milkers, put on more meat and fat at an early age, in proportion to food consumed, than almost any other variety. They produce the finest beef, and are more cheaply fed than Devons or Durhams, with which they are advantageously crossed. As a dairy county Herefordshire does not rank high.

Its small, white-faced, hornless, symmetrical breed of sheep known as "the Ryelands," from the district near Ross, where it was bred in most perfection, made the county long famous both for the flavour of its meat and the merino-like texture of its wool. Fuller says of this that it was best known as "Lempster ore," and the finest in all England. In its original form the breed is extinct, crossing with the Leicester having improved size and stamina at the cost of the fleece, and the chief breeds of sheep on Herefordshire farms at present are Shropshire Downs, Cotswolds and Radnors, with their crosses. Agricultural horses of good quality are bred in the north, and saddle and coach horses may be met with at the fairs. Breeders' names from the county are famous at the national cattle shows, and the number, size and quality of the stock are seen in their supply of the metropolitan and other markets. Prize Herefords are constantly exported to the colonies.

Manufacturing enterprise is small. There are some iron foundries and factories for agricultural implements, and some paper is made. There are considerable limestone quarries, as near Ledbury.

Communications.—Hereford is an important railway centre. The Worcester and Cardiff line of the Great Western railway, entering on the east, runs to Hereford by Ledbury and then southward. The joint line of the Great Western and North-Western companies runs north from Hereford by Leominster, proceeding to Shrewsbury and Crewe. At Leominster a Great Western branch crosses, connecting Worcester, Bromyard and New Radnor. From Hereford a Great Western branch follows the Wye south to Ross, and thence to the Forest of Dean and to Gloucester; a branch connects Ledbury with Gloucester, and the Golden Valley is traversed by a branch from Poatras on the Worcester-Cardiff line. From Hereford the Midland and Neath and Brecon line follows the Wye valley westward. None of the rivers is commercially navigable and the canals are out of use.

Population and Administration.—The area of the ancient county is 537,363 acres, with a population in 1891 of 115,949 and in 1901 of 114,380. The area of the administrative county is 538,921 acres. The county contains 12 hundreds. It is divided into two parliamentary divisions, Leominster (N.) and Ross (S.), and it also includes the parliamentary borough of Hereford, each returning one member. There are two municipal boroughs—Hereford (pop. 21,382) and Leominster (5826). The other urban districts are Bromyard (1663), Kington (1944), Ledbury (3259) and Ross (3303). The county is in the Oxford circuit, and assizes are held at Hereford. It has one court of quarter sessions and is divided into 11 petty sessional divisions. The boroughs of Hereford and Leominster have separate commissions of the peace, and the borough of Hereford has in addition a separate court of quarter sessions. There are 260 civil parishes. The ancient county, which is almost entirely in the diocese of Hereford, with small parts in those of Gloucester, Worcester and Llandaff, contains 222 ecclesiastical parishes or districts, wholly or in part.

History.—At some time in the 7th century the West Saxons pushed their way across the Severn and established themselves in the territory between Wales and Mercia, with which kingdom they soon became incorporated. The district which is now Herefordshire was occupied by a tribe the Hecanas, who congregated chiefly in the fertile area about Hereford and in the mining districts round Ross. In the 8th century Offa extended the Mercian frontier to the Wye, securing it by the earthwork known as Offa's dike, portions of which are visible at Knighton and Moorhampton in this county. In 915 the Danes made their way up the Severn to the district of Archenfield, where they took prisoner Cyfeillawg bishop of Llandaff, and in 921 they besieged Wigmore, which had been rebuilt in that year by Edward. From the time of its first settlement the district was the scene of constant border warfare with the Welsh, and Harold, whose earldom included this county, ordered that any Welshman caught trespassing over the border should lose his right hand. In the period preceding the Conquest much disturbance was

caused by the outrages of the Norman colony planted in this county by Edward the Confessor. Richard's castle in the north of the county was the first Norman fortress erected on English soil, and Wigmore, Ewyas Harold, Clifford, Weobley, Hereford, Donnington and Caldecot were all the sites of Norman strongholds. The conqueror entrusted the subjugation of Herefordshire to William FitzOsbern, but Edric the Wild in conjunction with the Welsh prolonged resistance against him for two years.

In the wars of Stephen's reign Hereford and Weobley castles were held against the king, but were captured in 1138. Edward, afterwards Edward I., was imprisoned in Hereford Castle, and made his famous escape thence in 1265. In 1326 the parliament assembled at Hereford which deposed Edward II. In the 14th and 15th centuries the forest of Deerfold gave refuge to some of the most noted followers of Wycliffe. During the Wars of the Roses the influence of the Mortimers led the county to support the Yorkist cause, and Edward, afterwards Edward IV., raised 23,000 men in this neighbourhood. The battle of Mortimer's Cross was fought in 1461 near Wigmore. Before the outbreak of the civil war of the 17th century, complaints of illegal taxation were rife in Herefordshire, but a strong anti-Parliament feeling induced the county to favour the royalist cause. Hereford, Goodrich and Ledbury all endured sieges.

The earldom of Hereford was granted by William I. to William FitzOsbern, about 1067, but on the outlawry of his son Roger in 1074 the title lapsed until conferred on Henry de Bohun in 1299. It remained in the possession of the Bohuns until the death of Humphrey de Bohun in 1373; in 1397 Henry, earl of Derby, afterwards King Henry IV., who had married Mary Bohun, was created duke of Hereford. Edward VI. created Walter Devereux, a descendant of the Bohun family, Viscount Hereford, in 1550, and his grandson, the famous earl of Essex, was born in this county. Since this date the viscounty has been held by the Devereux family, and the holder ranks as the premier viscount of England. The families of Clifford, Giffard and Mortimer figured prominently in the warfare on the Welsh border, and the Talbots, Lacys, Crofts and Scudamores also had important seats in the county, Sir James Scudamore of Holme Lacy being the original of the Sir Scudamore of Spenser's *Fairy Queen*. Sir John Oldcastle, the leader of the Lollards, was sheriff of Herefordshire in 1406.

Herefordshire probably originated as a shire in the time of Æthelstan, and is mentioned in the Saxon Chronicle in 1037. In the Domesday Survey parts of Monmouthshire and Radnorshire are assessed under Herefordshire, and the western and southern borders remained debatable ground until with the incorporation of the Welsh marches in 1535 considerable territory was restored to Herefordshire and formed into the hundreds of Wigmore, Ewyas Lacy and Huntingdon, while Ewyas Harold was united to Webtree. At the time of the Domesday Survey the divisions of the county were very unsettled. As many as nineteen hundreds are mentioned, but these were of varying extent, some containing only one manor, some from twenty to thirty. Of the twelve modern hundreds, only Greystree, Radlow, Stretford, Wolphy and Wormelow retain Domesday names. Herefordshire has been included in the diocese of Hereford since its foundation in 676. In 1291 it comprised the deaneries of Hereford, Weston, Leominster, Weobley, Frome, Archenfield and Ross in the archdeaconry of Hereford, and the deaneries of Burford, Stottesdon, Ludlow, Pontesbury, Clun and Wenlock, in the archdeaconry of Shropshire. In 1277 the name of the archdeaconry of Shropshire was changed to Ludlow, and in 1890 the deaneries of Abbey Dore, Bromyard, Kingsland, Kington and Ledbury were created in the archdeaconry of Hereford.

Herefordshire was governed by a sheriff as early as the reign of Edward the Confessor, the shire-court meeting at Hereford where later the assizes and quarter sessions were also held. In 1606 an act was passed declaring Hereford free from the jurisdiction of the council of Wales, but the county was not finally relieved from the interference of the Lords Marchers until the reign of William and Mary.

Herefordshire has always been esteemed an exceptionally rich agricultural area, the manufactures being unimportant, with the sole exception of the woollen and the cloth trade which flourished soon after the Conquest. Iron was worked in Wormelow hundred in Roman times, and the Domesday Survey mentions iron workers in Marcle. At the time of Henry VIII. the towns had become much impoverished, and Elizabeth in order to encourage local industries, insisted on her subjects wearing English-made caps from the factory of Hereford. Hops were grown in the county soon after their introduction into England in 1524. In 1580 and again in 1637 the county was severely visited by the plague, but in the 17th century it had a flourishing timber trade and was noted for its orchards and cider.

Herefordshire was first represented in parliament in 1295, when it returned two members, the boroughs of Ledbury, Hereford, Leominster and Weobley being also represented. Hereford was again represented in 1299, and Bromyard and Ross in 1304, but the boroughs made very irregular returns, and from 1306 until Weobley regained representation in 1627, only Hereford and Leominster were represented. Under the act of 1832 the county returned three members and Weobley was disfranchised. The act of 1868 deprived Leominster of one member, and under the act of 1885 Leominster was disfranchised, and Hereford lost one member.

Antiquities.—There are remains of several of the strongholds which Herefordshire possessed as a march county, some of which were maintained and enlarged, after the settlement of the border, to serve in later wars. To the south of Ross are those of Wilton and Goodrich, commanding the Wye on the right bank, the latter a ruin of peculiar magnificence, and both gaining picturesque interest from their beautiful situations. Of the several castles in the valleys of the boundary-river Monnow and its tributaries, those in this county include Pembridge, Kilpeck and Longtown; of which the last shows extensive remains of the strong keep and thick walls. In the north the finest example is Wigmore, consisting of a keep on an artificial mound within outer walls, the seat of the powerful family of Mortimer.

Beside the cathedral of Hereford, and the fine churches of Ledbury, Leominster and Ross, described under separate headings, the county contains some churches of almost unique interest. In that of Kilpeck remarkable and unusual Norman work is seen. It consists of the three divisions of nave, choir and chancel, divided by ornate arches, the chancel ending in an apse, with a beautiful and elaborate west end and south doorway. The columns of the choir arch are composed of figures. A similar plan is seen in Peterchurch in the Golden Valley, and in Moccas church, on the Wye above Hereford. Among the large number of churches exhibiting Norman details that at Bromyard is noteworthy. At Abbey Dore, the Cistercian abbey-church, still in use, is a large and beautiful specimen of Early English work, and there are slight remains of the monastic buildings. At Madley, south of the Wye 5 m. W. of Hereford, is a fine Decorated church (with earlier portions), with the rare feature of a Decorated apsidal chancel over an octagonal crypt. Of the churches in mixed styles those in the larger towns are the most noteworthy, together with that of Weobley.

The half-timbered style of domestic architecture, common in the west and midlands of England in the 16th and 17th centuries, beautifies many of the towns and villages. Among country houses, that of Treago, 9 m. W. of Ross, is a remarkable example of a fortified mansion of the 13th century, in a condition little altered. Rudhall and Sufton Court, between Ross and Hereford, are good specimens of 15th-century work, and portions of Hampton Court, 8 m. N. of Hereford, are of the same period, built by Sir Rowland Lenthall, a favourite of Henry IV. Holme Lacy, 5 m. S.E. of Hereford, is a fine mansion of the latter part of the 17th century; with picturesque Dutch gardens, and much wood-carving by Griaing Gibbons within. This was formerly the seat of the Scudamores, from whom it was inherited by the Stanhopes, earls of Chesterfield, the 9th earl of Chesterfield taking the name of Scudamore-Stanhope. His son, the 10th earl, has recently (1909) sold Holme Lacy to Sir Robert

Lucas-Tooth, Bart. Downton Castle possesses historical interest in having been designed in 1774, in a strange mixture of Gothic and Greek styles, by Richard Payne Knight (1750-1824), a famous scholar, numismatist and member of parliament for Leominster and Ludlow; while Eaton Hall, now a farm, was the seat of the family of the famous geographer Richard Hakluyt.

See *Victoria County History, Herefordshire*; J. Duncomb, *Collections towards the History and Antiquities of the County of Hereford* (Hereford, 1804-1812); John Allen, *Bibliotheca Herefordiensis* (Hereford, 1821); John Webb, *Memorials of the Civil War between Charles I. and the Parliament of England as it affected Herefordshire and the adjacent Counties* (London, 1879); R. Cooke, *Visitation of Herefordshire, 1569* (Exeter, 1886); F. T. Havergal, *Herefordshire Words and Phrases* (Walsall, 1887); J. Hutchinson, *Herefordshire Biographies* (Hereford, 1890).

HERERO, or **OVAHERERO** ("merry people"), a Bantu people of German South-West Africa, living in the region known as Damaraland or Hereroland. They call themselves Ovaherero and their language Otshi-herero. Sometimes they are described as Cattle Damara or "Damara of the Plains" in distinction from the Hill Damara who are of mixed blood and Hottentots in language. The Herero, whose main occupation is that of cattle-rearing, are a warlike race, possessed of considerable military skill, as was shown in their campaigns of 1904-5 against the Germans. (See further **GERMAN SOUTH-WEST AFRICA**.)

HERESY, the English equivalent of the Greek word *aisiōsis* which is used in the Septuagint for "free choice," in later classical literature for a philosophical school or sect as "chosen" by those who belong to it, in Philo for religion, in Josephus for a religious party (the Sadducees, the Pharisees and the Essenes).

It is in this last sense that the term is used in the New Testament, usually with an implicit censure of the factious spirit to which such divisions are due. The term is applied to the Sadducees (Acts v. 17) and Pharisees (Acts xv. 5, xxvi. 5). From the standpoint of opponents, Christianity is itself so described (Acts xxiv. 14, xxviii. 22). In the Pauline Epistles it is used with severe condemnation of the divisions within the Christian Church itself. Heresies with "enmities, strife, jealousies, wraths, factions, divisions, envyings" are reckoned among "the works of the flesh" (Gal. v. 20). Such divisions, proofs of a carnal mind, are censured in the church of Corinth (1 Cor. iii. 3, 4); and the church of Rome is warned against those who cause them (Rom. xvi. 17). The term "schism," afterwards distinguished from "heresy," is also used of these divisions (1 Cor. i. 10). The estrangements of the rich and the poor in the church at Corinth, leading to a lack of Christian fellowship even at the Lord's Supper, is described as "heresy" (1 Cor. xi. 19). Breaches of the law of love, not errors about the truth of the Gospel, are referred to in these passages. But the first step towards the ecclesiastical use of the term is found already in 2 Peter ii. 1, "Among you also there shall be false teachers who shall privily bring in destructive heresies (R.V. margin "sects of perdition"), denying even the Master that bought them, bringing upon themselves swift destruction." The meaning here suggested is "falsely chosen or erroneous tenets. Already the emphasis is moving from persons and their temper to mental products—from the sphere of sympathetic love to that of objective truth" (Bartlet, art. "Heresy," *Hastings's Bible Dictionary*). As the parallel passage in Jude, verse 4, shows, however, that these errors had immoral consequences, the moral reference is not absent even from this passage. The first employment of the term outside the New Testament is also its first use for theological error. Ignatius applies it to Docetism (*Ad Trall.* 6). As doctrine came to be made more important, heresy was restricted to any departure from the recognized creed. Even Constantine the Great describes the Christian Church as "the Catholic heresy," "the most sacred heresy" (Eusebius, *Ecclesiastical History*, x. c. 5, the letter to Chrestus, bishop of Syracuse); but this use was very soon abandoned, and the Catholic Church distinguished itself from the dissenting minorities, which it condemned as "heresies." The use of the term heresy in the New Testament cannot be regarded as defining the attitude of the Christian

Church, even in the Apostolic age, towards errors in belief. The Apostolic writings show a vehement antagonism towards all teaching opposed to the Gospel. Paul declares *anathema* the Judaizer, who required the circumcision of the Gentiles (Gal. i. 8), and even calls them the "dogs of the concision" and "evil workers" (Phil. iii. 2). The elders of Ephesus are warned against the false teachers who would appear in the church after the apostle's death as "grievous wolves not sparing the flock" (Acts xx. 29); and the speculations of the Gnostics are denounced as "seducing spirits and doctrines of devils" (1 Tim. iv. 1), as "profane babblings and oppositions of the knowledge which is falsely so called" (vi. 20). John's warnings are as earnest and severe. Those who deny the fact of the Incarnation are described as "antichrist," and as "deceivers" (1 John iv. 3; 2 John 7). The references to heretics in 2 Peter and Jude have already been dealt with. This antagonism is explicable by the character of the heresies that threatened the Christian Church in the Apostolic age. Each of these heresies involved such a blending of the Gospel with either Jewish or pagan elements, as would not only pollute its purity, but destroy its power. In each of these the Gospel was in danger of being made of none effect by the environment, which it must resist in order that it might transform (see Burton's Bampton Lectures on *The Heresies of the Apostolic Age*).

These Gnostic heresies, which threatened to paganize the Christian Church, were condemned in no measured terms by the fathers. These false teachers are denounced as "servants of Satan, beasts in human shape, dealers in deadly poison, robbers and pirates." Polycarp, Ignatius, Justin Martyr, Irenaeus, Hippolytus, Tertullian and even Clement of Alexandria and Origen are as severe in condemnation as the later fathers (cf. Matt. xiii. 35-43; Tertullian, *Præscr.* 31). While the necessity of the heresies is admitted in accordance with 1 Cor. xi. 19, yet woe is pronounced on those who have introduced them, according to Matt. xviii. 7. (This application of these passages, however, is of altogether doubtful validity.) "It was necessary," says Tertullian (*ibid.* 30), "that the Lord should be betrayed; but woe to the traitor." The very worst motives, "pride, disappointed ambition, sensual lust, and avarice," are recklessly imputed to the heretics; and no possibility of morally innocent doubt, difficulty or difference in thought is admitted. Origen and Augustine do, however, recognize that even false teachers may have good motives. While we must admit that there was a very serious peril to the thought and life of the Christian Church in the teaching thus denounced, yet we must not forget that for the most part these teachers are known to us only in the *ex parte* representation that their opponents have given of them; and we must not assume that even their doctrines, still less their characters, were so bad as they are described.

The attitude of the church in the post-Nicene period differs from that in the ante-Nicene in two important respects. (1) As has already been indicated, the earlier heresies threatened to introduce Jewish or pagan elements into the faith of the church, and it was necessary that they should be vigorously resisted if the church was to retain its distinctive character. Many of the later heresies were differences in the interpretation of Christian truth, which did not in the same way threaten the very life of the church. No vital interest of Christian faith justified the extravagant denunciations in which theological partisanship so recklessly and ruthlessly indulged. (2) In the ante-Nicene period only ecclesiastical penalties, such as reproof, deposition or excommunication, could be imposed. In the post-Nicene the union of church and state transformed theological error into legal offence (see below).

We must now consider the definition of heresy which was gradually reached in the Christian Church. It is "a religious error held in wilful and persistent opposition to the truth after it has been defined and declared by the church in an authoritative manner," or "pertinax defensio dogmatis ecclesiae universalis iudicio condemnati" (Schaff's *Ante-Nicene Christianity*, ii. 512-516). (i.) It "denotes an opinion antagonistic to a fundamental

*Questio-
tum.*

*New
Testam-
ent.*

*Christian
definitio.*

article of the Christian faith," due to the introduction of "foreign elements" and resulting in a perversion of Christianity, and an amalgamation with it of ideas discordant with its nature (Fisher's *History of Christian Doctrine*, p. 9). It has been generally assumed that the ecclesiastical authority was always competent to determine what are the fundamental articles of the Christian faith, and to detect any departures from them; but it is necessary to admit the possibility that the error was in the church, and the truth was with the heresy. (ii.) There cannot be any heresy where there is no orthodoxy, and, therefore, in the definition it is assumed that the church has declared what is the truth or the error in any matter. Accordingly "heresy is to be distinguished from defective stages of Christian knowledge. For example, the Jewish believers, including the Apostles themselves, at the outset required the Gentile believers to be circumcised. They were not on this account chargeable with heresy. Additional light must first come in, and be rejected, before that earlier opinion could be thus stigmatized. Moreover, heresies are not to be confounded with tentative and faulty hypotheses broached in a period prior to the scrutiny of a topic of Christian doctrine, and before that scrutiny has led the general mind to an assured conclusion. Such hypotheses—for example, the idea that in the person of Christ the Logos is substituted for a rational human spirit—are to be met with in certain early fathers" (*ibid.* p. 10). Origen indulged in many speculations which were afterwards condemned, but, as these matters were still open questions in his day, he was not reckoned a heretic. (iii.) In accordance with the New Testament use of the term heresy, it is assumed that moral defect accompanies the intellectual error, that the false view is held pertinaciously, in spite of warning, remonstrance and rebuke; aggressively to win over others, and so factiously, to cause division in the church, a breach in its unity.

A distinction is made between "heresy" and "schism" (from Gr. *σχιζω*, rend asunder, divide). "The fathers commonly use 'heresy' of false teaching in opposition to Catholic doctrine, and 'schism' of a breach of discipline, in opposition to Catholic government" (Schaff). But as the claims of the church to be the guardian through its episcopate of the apostolic tradition, of the Christian faith itself, were magnified, and unity in practice as well as in doctrine came to be regarded as essential, this distinction became a theoretical rather than a practical one. While severely condemning, both Irenaeus and Tertullian distinguished schismatics from heretics. "Though we are by no means entitled to say that they acknowledged orthodox schismatics they did not yet venture to reckon them simply as heretics. If it was desired to get rid of these, an effort was made to impute to them some deviation from the rule of faith; and under this pretext the church freed herself from the Montanists and the Monarchians. Cyprian was the first to proclaim the identity of heretics and schismatics by making a man's Christianity depend on his belonging to the great episcopal church confederation. But in both East and West, this theory of his became established only by very imperceptible degrees, and indeed, strictly speaking, the process was never completed. The distinction between heretics and schismatics was preserved because it prevented a public denial of the old principles, because it was advisable on political grounds to treat certain schismatic communities with indulgence, and because it was always possible in case of need to prove heresy against the schismatics." (Harnack's *History of Dogma*, ii. 92-93).

There was considerable controversy in the early church as to the validity of heretical baptism. As even "the Christian virtues of the heretics were described as hypocrisy and love of ostentation," so no value whatever was attached by the orthodox party to the sacraments performed by heretics. Tertullian declares that the church can have no communion with the heretics, for there is nothing common; as they have not the same God, and the same Christ, so they have not the same baptism (*De bapt.* 15). Cyprian agreed with him. The validity of heretical baptism was denied

by the church of Asia Minor as well as of Africa; but the practice of the Roman Church was to admit without second baptism heretics who had been baptized with the name of Christ, or of the Holy Trinity. Stephen of Rome attempted to force the Roman practice on the whole church in 253. The controversy his intolerance provoked was closed by Augustine's controversial treatise *De Baptismo*, in which the validity of baptism administered by heretics is based on the objectivity of the sacrament. Whenever the name of the three-one God is used, the sacrament is declared valid by whomsoever it may be performed. This was a triumph of sacramentarianism, not of charity.

Three types of heresy have appeared in the history of the Christian Church.¹ The earliest may be called the *syncretic*; it is the fusion of Jewish or pagan with Christian elements. *Ebionitism* asserted "the continual obligation to observe the whole of the Mosaic law," and "outran the Old Testament monotheism by a barren monarchianism that denied the divinity of Christ" (Kurtz, *Church History*, i. 120). *Gnosticism* was the result of the attempt to blend with Christianity the religious notions of pagan mythology, mystery, theosophy and philosophy" (p. 98). The Judaizing and the paganiating tendency were combined in *Gnostic Ebionitism* which was prepared for in *Jewish Essenism*. In the later heresy of *Manichaeism* there were affinities to Gnosticism, but it was a mixture of many elements, Babylonian-Chaldaic theosophy, Persian dualism and even Buddhist ethics (p. 126).

The next type of heresy may be called *evolutionary or formatory*. When the Christian faith is being formulated, undue emphasis may be put on one aspect, and thus so partial a statement of truth may result in error. Thus when in the ante-Nicene age the doctrine of the Trinity was under discussion, dynamic *Monarchianism* "regarded Christ as a mere man, who, like the prophets, though in a much higher measure, had been endowed with divine wisdom and power"; modal *Monarchianism* saw in the Logos dwelling in Christ "only a mode of the activity of the Father"; *Patripassianism* identified the Logos with the Father; and *Sabellianism* regarded Father, Son and Spirit as "the rôles which the God who manifests Himself in the world assumes in succession" (Kurtz, *Church History*, i. 175-181). When Arius asserted the subordination of the Son to the Father, and denied the eternal generation, Athanasius and his party asserted the *Homousia*, the consubstantiality of the Father and the Son. This assertion of the divinity of Christ triumphed, but other problems at once emerged. How was the relation of the humanity to the divinity in Christ to be conceived? Apollinaris denied the completeness of the human nature, and substituted the divine Logos for the reasonable soul of man. Nestorius held the two natures so far apart as to appear to sacrifice the unity of the person of Christ. Eutyches on the contrary "taught not only that after His incarnation Christ had only one nature, but also that the body of Christ as the body of God is not of like substance with our own" (Kurtz, *Church History*, i. 330-334). The Church in the Creed of Chalcedon in A.D. 451 affirmed "that Christ is true God and true man, according to His Godhead begotten from eternity and like the Father in everything, only without sin; and that after His incarnation the unity of the person consists in two natures which are conjoined without confusion, and without change, but also without rending and without separation." The problem was not solved, but the inadequate solutions were excluded, and the data to be considered in any adequate solution were affirmed. After this decision the controversies about the Person of Christ degenerated into mere hair-splitting; and the interference of the imperial authority from time to time in the dispute was not conducive to the settlement of the questions in the interests of truth alone. This problem interested the East for the most part; in the West there was waged a theological warfare around the nature of man and the work of Christ. To Augustine's doctrine of man's total depravity, his incapacity for any good, and the absolute sovereignty of the divine grace in salvation according to the divine election, Pelagius opposed the view that "God's grace

¹ For fuller details see separate articles.

is destined for all men, but man must make himself worthy of it by honest striving after virtue" (Kurtz, *Church History*, I. 348). While Pelagius was condemned, it was only a modified Augustinianism which became the doctrine of the church. It is not necessary in illustration of the second type of heresy—that which arises when the contents of the Christian faith are being defined—to refer to the doctrinal controversies of the middle ages. It may be added that after the Reformation Arianism was revived in Socinianism, and Pelagianism in Arminianism; but the conception of heresy in Protestantism demands subsequent notice.

The third type of heresy is the *revolutionary or reformatory*. This is not directed against doctrine as such, but against the church, its theory and its practice. Such movements of antagonism to the errors or abuses of ecclesiastical authority may be so permeated by defective conceptions and injurious influences as by their own character to deserve condemnation. But on the other hand the church in maintaining its place and power may condemn as heretical genuine efforts at reform by a return, though partial, to the standard set by the Holy Scriptures or the Apostolic Church. On the one hand there were during the middle ages sects, like the Catharists and Albigenses, whose "opposition as a rule developed itself from dualistic or pantheistic premises (surviving effects of old Gnostic or Manichean views)" and who "stood outside of ordinary Christendom, and while no doubt affecting many individual members within it, had no influence on church doctrine." On the other hand there were movements, such as the Waldensian, the Wycliffite and Hussite, which are often described as "reformatory movements anticipating the Reformation" which "set out from the Augustinian conception of the Church, but took exception to the development of the conception," and were pronounced by the medieval church as heretical for (1) "contesting the hierarchical gradation of the priestly order; or (2) giving to the religious idea of the Church implied in the thought of predestination a place superior to the conception of the empirical Church; or (3) applying to the priests, and thereby to the authorities of the Church, the test of the law of God, before admitting their right to exercise, as holding the keys, the power of binding and loosing" (Harnack's *History of Dogma*, vi. 136-137). The Reformation itself was from the standpoint of the Roman Catholic Church heresy and schism.

"In the present divided state of Christendom," says Schaff (*Anti-Nicene Christianity*, II. 513-514), "there are different kinds of orthodoxy and heresy. Orthodoxy is conformity to the recognized creed or standard of public doctrine; heresy is a wilful departure from it. The Greek Church rejects as heretical, because contrary to the teaching of the first seven ecumenical councils, the Roman dogmas of the papacy, of the double procession of the Holy Ghost, the immaculate conception of the Virgin Mary, and the infallibility of the Pope. The Roman Church anathematized, in the council of Trent, all the distinctive doctrines of the Protestant Reformation. Among Protestant churches again there are minor doctrinal differences, which are held with various degrees of exclusiveness or liberality according to the degree of departure from the Roman Catholic Church. Luther, for instance, would not tolerate Zwingli's view on the Lord's Supper, while Zwingli was willing to fraternize with him notwithstanding this difference." At the colloquy of Marburg "Zwingli offered his hand to Luther with the entreaty that they be at least Christian brethren, but Luther refused it and declared that the Swiss were of another spirit. He expressed surprise that a man of such views as Zwingli should wish brotherly relations with the Wittenberg reformers" (Walker, *The Reformation*, p. 174). A difference of opinion on the question of the presence of Christ in the elements at the Lord's Supper was thus allowed to divide and to weaken the forces of the Reformation. On the problem of divine election Lutheranism and Calvinism remained divided. The Formula of Concord (1577), which gave to the whole Lutheran Church of Germany a common doctrinal system, declined to accept the Calvinistic position that man's condemnation as well

as his salvation is an object of divine predestination. Within Calvinism itself Pelagianism was revived in Arminianism, which denied the irresistibility, and affirmed the universality of grace. This heresy was condemned by the synod of Dort (1619). The standpoint of the Reformed churches was the substitution of the authority of the Scriptures for the authority of the church. Whatever was conceived as contrary to the teaching of the Bible was regarded as heresy. The position is well expressed in the *Scotch Confession* (1559). "Protesting, that if any man will note in this our Confession any article or sentence repugning to God's Holy Word, that it would please him, of his gentleness, and for Christian charity's sake, to admonish us of the same in writ, and we of our honour and fidelity do promise unto him satisfaction from the mouth of God; that is, from His Holy Scripture, or else reformation of that which he shall prove to be amiss. In God we take to record in our consciences that from our hearts we abhor all sects of heresy, and all teachers of erroneous doctrines; and that with all humility we embrace purity of Christ's evangel, which is the only food of our souls" (Preface).

Although subsequently to the Reformation period the Protestant churches for the most part relapsed into the dogmatism of the Roman Catholic Church, and were ever ready with censure for every departure from orthodoxy—yet to-day a spirit of diffidence in regard to one's own beliefs, and of tolerance towards the beliefs of others, is abroad. The enlargement of the horizon of knowledge by the advance of science, the recognition of the only relative validity of human opinions and beliefs as determined by and adapted to each stage of human development, which is due to the growing historical sense, the alteration of view regarding the nature of inspiration, and the purpose of the Holy Scriptures, the revolt against all ecclesiastical authority, and the acceptance of reason and conscience as alone authoritative, the growth of the spirit of Christian charity, the clamorous demand of the social problem for immediate attention, all combine in making the Christian churches less anxious about the danger, and less zealous in the discovery and condemnation of heresy.

Having traced the history of opinion in the Christian churches on the subject of heresy, we must now return to resume a subject already mentioned, the persecution of heretics. According to the Canon Law, which "was the ecclesiastical law of medieval Europe, and is still the law of the Roman Catholic Church," heresy was defined as "error which is voluntarily held in contradiction to a doctrine which has been clearly stated in the creed, and has become part of the defined faith of the church," and which is "persisted in by a member of the church." It was regarded not only as an error, but also as a crime to be detected and punished. As it belongs, however, to a man's thoughts and not his deeds, it often can be proved only from suspicions. The canonists define the degrees of suspicion as "light" calling for vigilance, "vehement" demanding denunciation, and "violent" requiring punishment. The grounds of suspicion have been formulated "Pope Innocent III. declared that to lead a solitary life, to refuse to accommodate oneself to the prevailing manners of society, and to frequent unauthorized religious meetings were abundant grounds of suspicion; while later canonists were accustomed to give lists of deeds which made the doers suspect: a priest who did not celebrate mass, a layman who was seen in clerical robes, those who favoured heretics, received them as guests, gave them safe conduct, tolerated them, trusted them, defended them, fought under them or read their books were all to be suspect" (T.M. Lindsay in article "Heresy," *Ency. Brit.* 9th edition). That the dangers of heresy might be avoided, laymen were forbidden to argue about matters of faith by Pope Alexander IV., an oath "to abjure every heresy and to maintain in its completeness the Catholic faith" was required by the council of Toledo (1159), the reading of the Scriptures in the vulgar tongue was not allowed to the laity by Pope Pius IV. The reading of books was restricted and certain books were prohibited. Regarding heresy as a crime, the church was not content with inflicting its spiritual penalties,

Persecution of heretics.

Modern use of the term.

such as excommunication and such civil disabilities as its own organization allowed it to impose (e.g. the heretics were forbidden to give evidence in ecclesiastical courts, fathers were forbidden to allow a son or a daughter to marry a heretic, and to hold social intercourse with a heretic was an offence). It regarded itself as justified in invoking the power of the state to suppress heresy by civil pains and penalties, including even torture and death.

The story of the persecution of heretics by the state must be briefly sketched.

As long as the Christian Church was itself persecuted by the pagan empire, it advocated freedom of conscience, and insisted that religion could be promoted only by instruction and persuasion (Justin Martyr, Tertullian, Lactantius); but almost immediately after Christianity was adopted as the religion of the Roman empire the persecution of men for religious opinions began. While Constantine at the beginning of his reign (313) declared complete religious liberty, and kept on the whole to this declaration, yet he confined his favours to the orthodox hierarchical church, and even by an edict of the year 326 formally asserted the exclusion from these of heretics and schismatics. Arianism, when favoured by the reigning emperor, showed itself even more intolerant than Catholic Orthodoxy. Theodosius the Great, in 380, soon after his baptism, issued, with his co-emperors, the following edict: "We, the three emperors, will that all our subjects steadfastly adhere to the religion which was taught by St Peter to the Romans, which has been faithfully preserved by tradition, and which is now professed by the pontiff Damasus of Rome, and Peter, bishop of Alexandria, a man of apostolic holiness. According to the institution of the Apostles, and the doctrine of the Gospel, let us believe in the one Godhead of the Father, the Son, and the Holy Ghost, of equal majesty in the Holy Trinity. We order that the adherents of this faith be called *Catholic Christians*; we brand all the senseless followers of the other religions with the infamous name of *heretics*, and forbid their conventicles assuming the name of churches. Besides the condemnation of divine justice, they must expect the heavy penalties which our authority, guided by heavenly wisdom, shall think proper to inflict" (Schaff's *Nicene and Post-Nicene Christianity*, i. 142). The fifteen penal laws which this emperor issued in as many years deprived them of all right to the exercise of their religion, "excluded them from all civil offices, and threatened them with fines, confiscation, banishment and even in some cases with death." In 385 Maximus, his rival and colleague, caused seven heretics to be put to death at Treves (Trier). Many bishops approved the act, but Ambrose of Milan and Martin of Tours condemned it. While Chrysostom disapproved of the execution of heretics, he approved "the prohibition of their assemblies and the confiscation of their churches" Jerome by an appeal to Deut. xiii. 6-10 appears to defend even the execution of heretics. Augustine found a justification for these penal measures in the "compel them to come in" of Luke xiv. 23, although his personal leanings were towards clemency. Only the persecuted themselves insisted on toleration as a Christian duty. In the middle ages the church showed no hesitation about persecuting unto death all who dared to contradict her doctrine, or challenge her practice, or question her authority. The instruction and persuasion which St Bernard favoured found little imitation. Even the Dominicans, who began as a preaching order to convert heretics, soon became persecutors. In the Albigensian Crusade (A.D. 1209-1229) thousands were slaughtered. As the bishops were not zealous enough in enforcing penal laws against heretics, the Tribunal of the Inquisition was founded in 1232 by Gregory IX., and was entrusted to the Dominicans who "as *Domini canes* subjected to the most cruel tortures all on whom the suspicion of heresy fell, and all the resolute were handed over to the civil authorities, who readily undertook their execution" (Kurtz, *Church History*, ii. 137-138).

At the Reformation Luther laid down the principle that the civil government is concerned with the province of the external and temporal life, and has nothing to do with faith and conscience.

"How could the emperor gain the right," he asks, "to rule my faith?" With that only the Word of God is concerned. "Heresy is a spiritual thing," he says, "which one cannot hew with any iron, burn with any fire, drown with any water. The Word of God alone is there to do it." Nevertheless Luther assigned to the state, which he assumes to be Christian, the function of maintaining the Gospel and the Word of God in public life. He was not quite consistent in carrying out his principle (see Luthard's *Geschichte der christlichen Ethik*, ii. 33). In the Religious Peace of Augsburg the principle "cujus regio ejus religio" was accepted; by it a ruler's choice between Catholicism and Lutheranism bound his subjects, but any subject unwilling to accept the decision might emigrate without hindrance.

In Geneva under Calvin, while the *Consistoire*, or ecclesiastical court, could inflict only spiritual penalties, yet the medieval idea of the duty of the state to co-operate with the church to maintain the religious purity of the community in matters of belief as well as of conduct so far survived that the civil authority was sure to punish those whom the ecclesiastical had censured. Calvin consented to the death of Servetus, whose views on the Trinity he regarded as most dangerous heresy, and whose denial of the full authority of the Scriptures he dreaded as overthrowing the foundations of all religious authority. Protestantism generally, it is to be observed, quite approved the execution of the heretic. The Synod of Dort (1619) not only condemned Arminianism, but its defenders were expelled from the Netherlands; only in 1625 did they venture to return, and not till 1630 were they allowed to erect schools and churches. In modern Protestantism there is a growing disinclination to deal even with errors of belief by ecclesiastical censure; the appeal to the civil authority to inflict any penalty is abandoned. During the course of the 19th century in Scottish Presbyterianism the affirmation of Christ's atoning death for *all* men, the denial of eternal punishment, the modification of the doctrine of the inspiration of the Scriptures by acceptance of the results of the Higher Criticism, were all censured as perilous errors.

The subject cannot be left without a brief reference to the persecution of witches. To the beginning of the 13th century the popular superstitions regarding sorcery, witchcraft and compacts with the devil were condemned by the ecclesiastical authorities as heathenish, sinful and heretical. But after the establishment of the Inquisition "heresy and sorcery were regarded as correlates, like two agencies resting on and serviceable to the demoniacal powers, and were therefore treated in the same way as offences to be punished with torture and the stake" (Kurtz, *Church History*, ii. 195). While the Franciscans rejected the belief in witchcraft, the Dominicans were most zealous in persecuting witches. In the 15th century this delusion, fostered by the ecclesiastical authorities, took possession of the mind of the people, and thousands, mostly old women, but also a number of girls, were tortured and burned as witches. Protestantism took over the superstition from Catholicism. It was defended by James I. of England. As late as the 18th century death was inflicted in Germany and Switzerland on men, women and even children accused of this crime. This superstition dominated Scotland. Not till 1736 were the statutes against witchcraft repealed; an act which the Associate Presbytery at Edinburgh in 1743 declared to be "contrary to the express law of God, for which a holy God may be provoked in a way of righteous judgment."

The recognition and condemnation of errors in religious belief is by no means confined to the Christian Church. Only a few instances of heresy in other religions can be given. In regard to the fetishism of the Gold Coast ^{Non-Christian religions} of Africa, Jevons (*Introduction to the History of Religion*, pp. 165-166) maintains that "public opinion does not approve of the worship by an individual of a *sahman*, or private tutelary deity, and that his dealings with it are regarded in the nature of 'black art' as it is not a god of the community." In China there is a "classical or canonical, primitive and therefore alone orthodox (*tsching*) and true

religion." Confucianism and Taoism, while the "heterodox (*sic*)," Buddhism especially, is "partly tolerated, but generally forbidden, and even cruelly persecuted" (Chantepie de la Saussaye, *Religionsgeschichte*, i. 57). In Islam "according to an unconfirmed tradition Mahomet is said to have foretold that his community would split into seventy-three sects (see MAHOMEDAN RELIGION, § *Sects*), of which only one would escape the flames of hell." The first split was due to uncertainty regarding the principle which should rule the succession to the Caliphate. The Arabic and orthodox party (*i.e.* the Sunnites, who held by the Koran and tradition) maintained that this should be determined by the choice of the community. The Persian and heterodox party (the Shiites) insisted on heredity. But this political difference was connected with theological differences. The sect of the Mu'tazilites which affirmed that the Koran had been created, and denied predestination, began to be persecuted by the government in the 9th century, and discussion of religious questions was forbidden (see CALIPHATE, sections B and C). The mystical tendency in Islam, Sufism, is also regarded as heretical (see Kuenen's Hibbert Lecture, pp. 45-50). Buddhism is a wide departure in doctrine and practice from Brahmanism, and hence after a swift unfolding and quick spread it was driven out of India and had to find a home in other lands. Essenism from the standpoint of Judaism was heterodox in two respects, the abandonment of animal sacrifices and the adoration of the sun.

Although in Greece there was generally wide tolerance, yet in 390 B.C. Socrates "was indicted as an irreligious man, a corrupter of youth, and an innovator in worship."

Besides the works quoted above, see Gottfried Arnold's *Unpartheiische Kirchen- und Ketzer-Historie* (1699-1700; ed. Schaffhausen, 1740). A very good list of writers on heresy, ancient and medieval, is given in Burton's *Bampton Lectures on Heresies of the Apostolic Age* (1829). The various Trinitarian and Christological heresies may be studied in Dorner's *History of the Doctrine of the Person of Christ* (1845-1856; Eng. trans., 1861-1862); the Gnostic and Manichaean heresies in the works of Mansel, Matter and Beausobre; the medieval heresies in Hahn's *Geschichte der Ketzer im Mittelalter* (1846-1850), and Preger's *Geschichte der deutschen Mystik* (1875); Quietism in Heppes's *Geschichte der quietistischen Mystik* (1875); the Pietist sects in Palmer's *Gemeinschaften und Secten Württembergs* (1875); the Reformation and 17th-century heresies and sects in the *Anabaptistism et enthusiastium Pantheon und geistliches Rüst-Haus* (1701). Böhmer's *Jus ecclesiasticum Protestantium* (1714-1723), and van Espen's *Jus ecclesiasticum* (1702) detail at great length the relations of heresy to canon and civil law. On the question of the baptism of heretics see Smith and Cheetham's *Dict. of Eccl. Antiquities*, "Baptism, Iteration of"; and on that of the readmission of heretics into the church, compare Martene, *De ritibus*, and Morinus, *De poenitentia*. (A. E. G.)

Heresy according to the Law of England.—The highest point reached by the ecclesiastical power in England was in the Act *De Hæretico comburendo* (2 Henry IV. c. 15). Some have supposed that a writ of that name is as old as the common law, but its execution might be arrested by a pardon from the crown. The Act of Henry IV. enabled the diocesan alone, without the co-operation of a synod, to pronounce sentence of heresy, and required the sheriff to execute it by burning the offender, without waiting for the consent of the crown.¹ A large number of penal statutes were enacted in the following reigns, and the statute 1 Eliz. c. 1 is regarded by lawyers as limiting for the first time the description of heresy to tenets declared heretical either by the canonical Scripture or by the first four general councils, or such as should thereafter be so declared by parliament with the assent of Convocation. The writ was abolished by 29 Car. II. c. 9, which reserved to the ecclesiastical courts their jurisdiction over heresy and similar offences, and their power of awarding punishments not extending to death. Heresy became henceforward a purely ecclesiastical offence, although disabling laws of various kinds continued to be enforced against Jews, Catholics and other dissenters. The temporal courts have no knowledge of any offence known as heresy, although incidentally (e.g. in questions of copyright) they have refused protection to persons promulgating irreligious or blasphemous opinions. As an ecclesiastical offence it would at this moment be almost impossible to say what opinion, in the case of a layman at least, would be deemed heretical. Apparently, if a proper case could be made out, an ecclesiastical court might still sentence a layman to excommunication for heresy, but by no other means could his opinions be brought under censure. The last case on the subject (Jenkins v. Cook, *L.R.* 1 P.D. 80) leaves the matter in the same uncertainty. In that case a clergyman refused the communion

to a parishioner who denied the personality of the devil. The judicial committee held that the rights of the parishioners are expressly defined in the statute of 1 Edw. VI. c. 1, and, without admitting that the canons of the church, which are not binding on the laity, could specify a lawful cause for rejection, held that no lawful cause within the meaning of either the canons or the rubric had been shown. It was maintained at the bar that the denial of the most fundamental doctrines of Christianity would not be a lawful cause for such rejection, but the judgment only queries whether a denial of the personality of the devil or eternal punishment is consistent with membership of the church. The right of every layman to the offices of the church is established by statute without reference to opinions, and it is not possible to say what opinions, if any, would operate to disqualify him.

The case of clergymen is entirely different. The statute 13 Eliz. c. 12, § 2, enacts that "if any person ecclesiastical, or which shall have an ecclesiastical living, shall advisedly maintain or affirm any doctrine directly contrary or repugnant to any of the said articles, and by convective before the bishop of the diocese, or the ordinary, or before the queen's highness's commissioners in matters ecclesiastical, shall persist therein or not revoke his error, or after such revocation afterwards affirm such untrue doctrine," he shall be deprived of his ecclesiastical promotions. The act it will be observed applies only to clergymen, and the punishment is strictly limited to deprivation of benefice. The judicial committee of the privy council, as the last court of appeal, has on several occasions pronounced judgments by which the scope of the act has been confined to its narrowest legal effect. The court will construe the Articles of Religion and formularies according to the legal rules for the interpretation of statutes and written instruments. No rule of doctrine is to be ascribed to the church which is not distinctly and expressly stated or plainly involved in the written law of the Church, and where there is no rule, a clergyman may express his opinion without fear of penal consequences. In the *Essays and Reviews* cases (Williams v. the Bishop of Salisbury, and Wilson v. Fendall, 2 Moo. P.C.C., N.S. 375) it was held to be not penal for a clergyman to speak of merit by transfer as a "fiction," or to express a hope of the ultimate pardon of the wicked, or to affirm that any part of the Old or New Testament, however unconnected with religious faith or moral duty, was not written under the inspiration of the Holy Spirit. In the case of Noble v. Vopsey (*L.R.* 3 P.C. 357) in 1871 the committee held that it was not bound to affix a meaning to articles of really dubious import, as it would have been in cases affecting property. At the same time any manifest contradiction of the Articles, or any obvious evasion of them, would subject the offender to the penalties of deprivation. In some of the cases the question has been raised how far the doctrine of the church could be ascertained by reference to the opinions generally expressed by divines belonging to its communion. Such opinions, it would seem, might be taken into account as showing the extent of liberty which had been in practice, claimed and exercised on the interpretation of the articles, but would certainly not be allowed to increase their stringency. It is not the business of the court to pronounce upon the absolute truth or falsehood of any given opinion, but simply to say whether it is formally consistent with the legal doctrines of the Church of England. Whether Convocation has any jurisdiction in cases of heresy is a question which has occasioned some difference of opinion among lawyers. Hale, as quoted by Phillimore (*Eccl. Law*), says that before the time of Richard II., that is, before any acts of Parliament were made about heresy, it is without question that in a convocation of the clergy or provincial synod "they might and frequently did here in England proceed to the sentencing of heretics." But later writers, while adhering to the statement that Convocation might declare opinions to be heretical, doubted whether it could proceed to punish the offender, even when he was a clerk in orders. Phillimore states that there is no longer any doubt, even apart from the effect of the Church Discipline Act, 1840, that Convocation has no power to condemn clergymen for heresy. The supposed right of Convocation to stamp heretical opinions with its disapproval was exercised on a somewhat memorable occasion. In 1864 the Convocation of the province of Canterbury, having taken the opinion of two of the most eminent lawyers of the day (Sir Hugh Cairns and Sir John Rolfe), passed judgment upon the volume entitled *Essays and Reviews*. The judgment purported to "synodically condemn the said volume as containing teaching contrary to the doctrine received by the United Church of England and Ireland, in common with the whole Catholic Church of Christ." These proceedings were challenged in the House of Lords by Lord Houghton, and the lord chancellor (Westbury), speaking on behalf of the government, stated that if there was any "synodical judgment" it would be a violation of the law, subjecting those concerned in it to the penalties of a *proemuniere*, but that the sentence in question was "simply nothing, literally no sentence at all." It is thus at least doubtful whether Convocation has a right even to express an opinion unless specially authorized to do so by the crown, and it is certain that it cannot do anything more. Heresy or no heresy, in the last resort, like all other ecclesiastical questions, is decided by the judicial committee of the council.

The English lawyers, following the Roman law, distinguish between heresy and apostasy. The latter offence is dealt with by an act which still stands on the statute book, although it has long been

¹ Stephen's *Commentaries*, bk. iv. ch. 7.

virtually obsolete—the 9 & 10 Will. III. c. 35. If any person who has been educated in or has professed the Christian religion shall, by writing, printing, teaching, or advised speaking, assert or maintain that there are more Gods than one, or shall deny any of the persons of the Holy Trinity to be God, or shall deny the Christian religion to be true or the Holy Scriptures of the Old and New Testament to be of divine authority, he shall for the first offence be declared incapable of holding any ecclesiastical, civil, or military office or employment, and for the second incapable of bringing any action, or of being guardian, executor, legatee, or grantee, and shall suffer three years' imprisonment without bail. Unitarians were saved from these atrocious penalties by a later act (53 Geo. III. c. 160), which permits Christians to deny any of the persons in the Trinity without penal consequences.

HEREWARD, usually but erroneously styled "the Wake" (an addition of later days), an Englishman famous for his resistance to William the Conqueror. It is now established that he was a tenant of Peterborough Abbey, from which he held lands at Witham-on-the-Hill and Barholme with Stow in the south-western corner of Lincolnshire, and of Crowland Abbey at Rippingale in the neighbouring fenland. His first authentic act is the storm and sacking of Peterborough in 1070, in company with outlaws and Danish invaders. The next year he took part in the desperate stand against the Conqueror's rule made in the isle of Ely, and, on its capture by the Normans, escaped with his followers through the fens. That his exploits made an exceptional impression on the popular mind is certain from the mass of legendary history that clustered round his name; he became, says Mr Davis, "in popular eyes the champion of the English national cause." The Hereward legend has been fully dealt with by him and by Professor Freeman, who observed that "with no name has fiction been more busy."

See E. A. Freeman, *History of the Norman Conquest*, vol. iv.; J. H. Round, *Feudal England*; H. W. C. Davis, *England under the Normans and Angevins*. (J. H. R.)

HERFORD, a town in the Prussian province of Westphalia, situated at the confluence of the Werre and Aa, on the Minden & Cologne railway, 9 m. N.E. of Bielefeld, and at the junction of the railway to Detmold and Altenbeken. Pop. (1885) 15,002; (1905) 24,821. It possesses six Evangelical churches, notably the Münsterkirche, a Romanesque building with a Gothic apse of the 15th century; the Marienkirche, in the Gothic style; and the Johanniskirche, with a steeple 280 ft. high. The other principal buildings are the Roman Catholic church, the synagogue, the gymnasium founded in 1540, the agricultural school and the theatre. There is a statue of Frederick William of Brandenburg. The industries include cotton and flax-spinning, and the manufacture of linen cloth, carpets, furniture, machinery, sugar, tobacco and leather.

Herford owes its origin to a Benedictine nunnery which is said to have been founded in 832, and was confirmed by the emperor Louis the Pious in 839. From the emperor Frederick I. the abbess obtained princely rank and a seat in the imperial diet. Among the abbesses was the celebrated Elizabeth (1618-1680), eldest daughter of the elector palatine Frederick V., who was a philosophical princess, and a pupil of Descartes. Under her rule the sect of the Labadists settled for some time in Herford. The foundation was secularized in 1803. Herford was a member of the Hanseatic League, and its suzerainty passed in 1547 from the abbesses to the dukes of Juliers. In 1631 it became a free imperial town, but in 1647 it was subjugated by the elector of Brandenburg. It came into the possession of Westphalia in 1807, and in 1813 into that of Prussia.

See L. Hölcher, *Reformationsgeschichte der Stadt Herford* (Güterloh, 1888).

HERGENRÖTHER, JOSEPH VON (1824-1890). German theologian, was born at Würzburg in Bavaria on the 15th of September 1824. He studied at Würzburg and at Rome. After spending a year as parish priest at Zelligen, near his native city, he went, in 1850, at his bishop's command, to the university of Munich, where he took his degree of doctor of theology the same year, becoming in 1851 *Privatdozent*, and in 1855 professor of ecclesiastical law and history. At Munich he gained the reputation of being one of the most learned theologians on the Ultramontane side of the Infallibility question,

which had begun to be discussed; and in 1868 he was sent to Rome to arrange the proceedings of the Vatican Council. He was a staunch supporter of the infallibility dogma; and in 1870 he wrote *Anti-Janus*, an answer to *The Pope and the Council*, by "Janus" (Döllinger and J. Friedrich), which made a great sensation at the time. In 1877 he was made prelate of the papal household; he became cardinal deacon in 1879, and was afterwards made curator of the Vatican archives. He died in Rome on the 3rd of October 1890.

Hergenröther's first published work was a dissertation on the doctrine of the Trinity according to Gregory Nazianzen (Regensburg, 1850), and from this time onward his literary activity was immense. After several articles and brochures on Hippolytus and the question of the authorship of the *Philosophumena*, he turned to the study of Photius, patriarch of Constantinople, and the history of the Greek schism. For twelve years he was engaged upon this work, the result being his monumental *Photius, Patriarch von Constantinopel. Sein Leben, seine Schriften und das griechische Schisma* (3 vols., Regensburg, 1867-1869); an additional volume (1869) gave, under the title *Monumenta Græca ad Photium . . . pertinentia*, a collection of the unpublished documents on which the work was largely based. Of Hergenröther's other works, the most important are his history of the Papal States since the Revolution (*Der Kirchenstaat seit der französischen Revolution*, Freiburg i. B., 1860; Fr. trans., Leipzig, 1860), his great work on the relations of church and state (*Katholische Kirche und christlicher Staat in ihrer geschichtlichen Entwicklung und in Beziehung auf Fragen der Gegenwart*, 2 parts, Freiburg i. B., 1872; 2nd ed. expanded, 1876; Eng. trans., London, 1876, Baltimore, 1889), and his universal church history (*Handbuch der allgemeinen Kirchengeschichte*, 3 vols., Freiburg i. B., 1876-1880; 2nd ed., 1879; 8c. 1 3rd ed., 1883-1886; 4th ed. by Peter Kirsch, 1902, 8c.; French trans., Paris, 1880, &c.). He also found time for a while to edit the new edition of Wetzer and Welte's *Kirchenlexikon* (1877), to superintend the publication of part of the *Regesta* of Pope Leo X. (Freiburg i. B., 1884-1885), and to add two volumes to Hehle's *Concilien Geschichte* (ib., 1887 and 1890).

HERINGSBORF, a seaside resort of Germany, in the Prussian province of Pomerania, on the north coast of the island of Usedom, 5 m. by rail N.W. of Swinemünde. It is surrounded by beech woods, and is perhaps the most popular seaside resort on the German shore of the Baltic, being frequented by some 12,000 visitors annually.

HERIOT, GEORGE (1563-1623), the founder of Heriot's Hospital, Edinburgh, was descended from an old Haddington family; his father, a goldsmith in Edinburgh, represented the city in the Scottish parliament. George was born in 1563, and after receiving a good education was apprenticed to his father's trade. In 1586 he married the daughter of a deceased Edinburgh merchant, and with the assistance of her patrimony set up in business on his own account. At first he occupied a small "buih" at the north-east corner of St Giles's church, and afterwards a more pretentious shop at the west end of the building. To the business of a goldsmith he joined that of a money-lender, and in 1597 he had acquired such a reputation that he was appointed goldsmith to Queen Anne, consort of James VI. In 1601 he became jeweller to the king, and followed him to London, occupying a shop opposite the Exchange. Heriot was largely indebted for his fortune to the extravagance of the queen, and the imitation of this extravagance by the nobility. Latterly he had such an extensive business as a jeweller that on one occasion a government proclamation was issued calling upon all the magistrates of the kingdom to aid him in securing the workmen he required. He died in London on the 10th of February 1623. In 1608, having some time previously lost his first wife, he married Alison Primrose, daughter of James Primrose, grandfather of the first earl of Rosebery, but she died in 1612; by neither marriage had he any issue. The surplus of his estate, after deducting legacies to his nearest relations and some of his more intimate friends, was bequeathed to found a hospital for the education of freemen's sons of the town of Edinburgh; and its value afterwards increased so greatly as to supply funds for the erection of several Heriot foundation schools in different parts of the city.

Heriot takes a leading part in Scott's novel, *The Fortunes of Nigel* (see also the Introduction). A *History of Heriot's Hospital, with a Memoir of the Founder*, by William Steven, D.D., appeared in 1827; 2nd ed. 1859.

HERIOT, by derivation the arms and equipment (*goatwa*) of a soldier or army (*here*); the O. Eng. word is thus *here-goatwa*. The lord of a fee provided his tenant with arms and a horse, either as a gift or loan, which he was to use in the military service paid by him. On the death of the tenant the lord claimed the return of the equipment. When by the 10th century land was being given instead of arms, the heriot was still paid, but more in the nature of a "relief" (*gr.*). There seems to have been some connexion between the payment of the heriot and the power of making a will (F. W. Maitland, *Domesday Book and Beyond*, p. 298). By the 13th century the payment was made either in money or in kind by the handing over of the best beast or of the best other chattel of the tenant (see Pollock and Maitland, *History of English Law*, i. 270 sq.). For the manorial law relating to heriots, see **COPYHOLD**.

HERISAU, the largest town in the entire Swiss canton of Appenzell, built on the Glatt torrent, and by light railway 7 m. south-west of St Gall or 13½ m. north of Appenzell. In 1900 it had 13,497 inhabitants, mainly Protestant and German-speaking. The lower portion of the massive tower of the parish church (Protestant) dates from the 11th century or even earlier. It is a prosperous little industrial town in the Ausser Rhoden half of the canton, especially busied with the manufacture of embroidery by machinery, and of muslins. Near it is the goats' whey cure establishment of Heinrichsbad, and the two castles of Rosenberg and Rosenberg, ruined in 1403 when the land rose against its lord, the abbot of St Gall. About 5 m. to the south-east is Hundwil, a village of 1593 inhabitants, where the *Landsgemeinde* of Ausser Rhoden meets in the odd years (in other years at Trogen) on the last Sunday in April.

HERITABLE JURISDICTIONS, in the law of Scotland, grants of jurisdiction made to a man and his heirs. They were a usual accompaniment to feudal tenures, and the power which they conferred on great families, being recognized as a source of danger to the state, led to frequent attempts being made by statute to restrict them, both before and after the Union. They were all abolished in 1746.

HERKIMER, a village and the county-seat of Herkimer county, New York, U.S.A., in the township of the same name, on the Mohawk river, about 15 m. S.E. of Utica. Pop. (1900) 5555 (724 being foreign-born); (1905, state census) 6596; (1910) 7520. It is served by the New York Central & Hudson River railway, a branch of which (the Mohawk & Malone railway) extends through the Adirondacks to Malone, N.Y.; by Interurban electric railway to Little Falls, Syracuse, Richfield Springs, Cooperstown and Oneonta, and by the Erie canal. The village has a public library, and is the seat of the Folts Mission Institute (opened 1893), a training school for young women, controlled by the Women's Foreign Missionary Society of the Methodist Episcopal Church. Herkimer is situated in a rich dairying region, and has various manufactures. The municipality owns and operates its water-supply system and electric-lighting plant. Herkimer, named in honour of General Nicholas Herkimer (c. 1728-1777), who was mortally wounded in the Battle of Oriskany, and in whose memory there is a monument (unveiled on the 6th of August 1907) in the village, was settled about 1725 by Palatine Germans, who bought from the Mohawk Indians a large tract of land including the present site of the village and established thereon several settlements which became known collectively as the "German Flats." In 1756 a stone house, built in 1740 by General Herkimer's father, John Jost Herkimer (d. 1775)—apparently one of the original group of settlers—a stone church, and other buildings, standing within what is now Herkimer village, were enclosed in a stockade and ditch fortifications by Sir William Johnson, and this post, at first known as Fort Kouari (the Indian name), was subsequently called Fort Herkimer. Another fort (Ft. Dayton) was built within the limits of the present village in 1776 by Colonel Elias Dayton (1737-1807), who later became a brigadier-general (1783) and served in the Confederation Congress in 1787-1788. During the French and Indian War the settlement was attacked (12th November 1757) and practically destroyed, many of the

settlers being killed or taken prisoners; and it was again attacked on the 30th of April 1758. In the War of Independence General Herkimer assembled here the force which on the 6th of August 1777 was ambushed near Oriskany on its march from Ft. Dayton to the relief of Ft. Schuyler (see **ORISKANY**); and the settlement was attacked by Indians and "Tories" in September 1778 and in June 1782. The township of Herkimer was organized in 1788, and in 1807 the village was incorporated.

See Nathaniel I. Benton, *History of Herkimer County* (Albany, 1856); and Phoebe S. Cowen, *The Herkimers and Schuylers*, 1903).

HERKOMER, SIR HUBERT VON (1849-), British painter, was born at Waal, in Bavaria, and eight years later was brought to England by his father, a wood-carver of great ability. He lived for some time at Southampton and in the school of art there began his art training; but in 1866 he entered upon a more serious course of study at the South Kensington Schools, and in 1869 exhibited for the first time at the Royal Academy. By his picture, "The Last Muster," at the Academy in 1875, he definitely established his position as an artist of high distinction. He was elected an associate of the Academy in 1879, and academician in 1890; an associate of the Royal Society of Painters in Water Colours in 1893, and a full member in 1894; and in 1885 he was appointed Slade professor at Oxford. He exhibited a very large number of memorable portraits, figure subjects and landscapes, in oil and water colour; he achieved marked success as a worker in enamel, as an etcher, mezzotint engraver and illustrative draughtsman; and he exercised wide influence upon art education by means of the Herkomer School (Incorporated), at Bushey, which he founded in 1883 and directed gratuitously until 1904, when he retired. It was then voluntarily wound up, and is now conducted privately. Two of his pictures, "Found" (1885) and "The Chapel of the Charterhouse" (1889), are in the National Gallery of British Art. In the year 1907 he received the honorary degree of D.C.L. at Oxford, and a knighthood was conferred upon him by the king in addition to the commandership of the Royal Victorian Order with which he was already decorated.

See *Hubert von Herkomer, R.A., a Study and a Biography*, by A. L. Baldry (London, 1901); *Professor Hubert Herkomer, Royal Academician, His Life and Work*, by W. L. Courtney (London, 1892).

HERLEN (or **HERLIN**), **FRITZ**, of Nördlingen, German artist of the early Swabian school, in the 15th century. The date and place of his birth are unknown, but his name is on the roll of the tax-gatherers of Ulm in 1449; and in 1467 he was made citizen and town painter at Nördlingen, "because of his acquaintance with Flemish methods of painting." One of the first of his acknowledged productions is a shrine on one of the altars of the church of Rothenburg on the Tauber, the wings of which were finished in 1466, with seven scenes from the lives of Christ and the Virgin Mary. In the town-hall of Rothenburg is a Madonna and St Catherine of 1467; and in the choir of Nördlingen cathedral a triptych of 1488, representing the "Nativity" and "Christ amidst the Doctors," at the side of a votive Madonna attended by St Joseph and St Margaret as patrons of a family. In each of these works the painter's name certifies the picture, and the manner is truly that of an artist "acquainted with Flemish methods." We are not told under whom Herlen laboured in the Netherlands, but he probably took the same course as Schongauer and Hans Holbein the elder, who studied in the school of van der Weyden. His altarpiece at Rothenburg contains groups and figures, as well as forms of action and drapery, which seem copied from those of van der Weyden's or Memlinc's disciples, and the votive Madonna of 1488, whilst characterized by similar features, only displays such further changes as may be accounted for by the master's constant later contact with contemporaries in Swabia. Herlen had none of the genius of Schongauer. He failed to acquire the delicacy even of the second-rate men who handed down to Matsys the traditions of the 15th century, but his example was certainly favourable to the development of art in Swabia. By general consent critics have assigned to him a large altar-piece, with scenes from the gospels and figures of St Florian and St. Florian, and a Crucifixion, the principal figure of which is carved in high relief on the surface of

a large panel in the church of Dinkelsbühl. A Crucifixion, with eight scenes from the New Testament, is shown as his in the cathedral, a "Christ in Judgment, with Mary and John," and the "Resurrection of Souls" in the town-hall of Nördlingen. A small Epiphany, once in the convent of the Minorites of Ulm, is in the Holzschuher collection at Augsburg, a Madonna and Circumcision in the National Museum at Munich. Herken's epitaph, preserved by Rathgeber, states that he died on the 12th of October 1491, and was buried at Nördlingen.

HERMAE, in Greek antiquities, quadrangular pillars, broader above than at the base, surmounted by a head or bust, so called either because the head of Hermes was most common or from their etymological connexion with the Greek word *ἑρμαρα* (blocks of stone), which originally had no reference to Hermes at all. In the oldest times Hermes, like other divinities, was worshipped in the form of a heap of stones or of an amorphous block of wood or stone, which afterwards took the shape of a phallus, the symbol of productivity. The next step was the addition of a head to this phallic column which became quadrangular (the number 4 was sacred to Hermes, who was born on the fourth day of the month), with the significant indication of sex still prominent. In this shape the number of herms rapidly increased, especially those of Hermes, for which the distinctive name of Hermhermae has been suggested. In Athens they were found at the corners of streets; before the gates and in the courtyards of houses, where they were worshipped by women as having the power to make them prolific; before the temples; in the gymnasia and palaestrae. On each side of the road leading from the Stoa Poikile to the Stoa Basileios, rows of Hermae were set up in such numbers by the piety of private individuals or public corporations, that the Stoa Basileios was called the Stoa of the Hermae. The function of Hermes as protector of the roads, of merchants and of commerce, explains the number of Hermae that served the purpose of signposts on the roads outside the city. It is stated in the pseudo-Platonic *Hipparchus* that the son of Peisistratus had set up marble pillars at suitable places on the roads leading from the different country districts to Athens, having the places connected with the roads inscribed on the one side in a hexameter verse, and on the other a pentameter containing a short proverb or moral precept for the edification of travellers. Sometimes they bore inscriptions celebrating the valour of those who had fought for their country. Just as it was customary for the passer-by to show respect to the rudest form of the god (the heap of stones) by contributing a stone to the heap or anointing it with oil, in like manner small offerings, generally of dried figs, were deposited near the Hermae, to appease the hunger of the necessitous wayfarer. Garlands of flowers were also suspended on the two arm-like tenons projecting from either side of the column at the top (for the oracle at Pharae see **HERMES**). These pillars were also used to mark the frontier boundaries or the limits of different estates. The great respect attaching to them is shown by the excitement caused in Athens by the "Mutilation of the Hermae" just before the departure of the Sicilian expedition (May 415 B.C.). They formed the object of a special industry, the makers of them being called Hermoglyphi. The surmounting heads were not, however, confined to those of Hermes; those of other gods and heroes, and even of distinguished mortals, were of frequent occurrence. In this case a compound was formed: Hermathena (a herm of Athena), Hermares, Hermaphroditus, Hermanubis, Hermalcibiades, and so on. In the case of these compounds it is disputed whether they indicated a herm with the head of Athena, or with a Janus-like head of both Hermes and Athena, or a figure compounded of both deities. The Romans not only borrowed the Hermes pillars for their deities which at an early period they assimilated to those of the Greeks (as Heracles—Hercules) but also for the indigenous gods who preserved their individuality. Thus herms of Jupiter Terminalis (the hermae being identified with the Roman termini) and of Silvanus occur. Under the empire, the function of the hermae was rather architectural than religious. They were used to keep up the draperies in the interior of a house, and in the Circus Maximus they were used to support the barriers.

See the article with bibliography by Pierre Paris in *Darceberg* and Saglio's *Dictionnaire des antiquités*; for the mutilation of the Hermae, Thucydides vi. 27; Andocides, *De mysteriis*; Grote, *Hist. of Greece*, ch. 58; H. Weil, *Études sur l'antiquité grecque* (1900); Burot, *Graech. Gesch.* (ed. 1904), III. ii. p. 1287.

HERMAGORAS, of Temnos, Greek rhetorician of the Rhodian school and teacher of oratory in Rome, flourished during the first half of the 1st century B.C. He obtained a great reputation among a certain section and founded a special school, the members of which called themselves Hermagorei. His chief opponent was Posidonius of Rhodes, who is said to have contended with him in argument in the presence of Pompey (Plutarch, *Pompey*, 42). Hermagoras devoted himself particularly to the branch of rhetoric known as *οἰστροπία* (*inventio*), and is said to have invented the doctrine of the four *εἶδη* (*status*) and to have arranged the parts of an oration differently from his predecessors. Cicero held an unfavourable opinion of his methods, which were approved by Quintilian, although he considers that Hermagoras neglected the practical side of rhetoric for the theoretical. According to Suidas and Strabo, he was the author of *τέχνη ῥητορική* (rhetorical manuals) and of other works, which should perhaps be attributed to his younger namesake, surnamed Carion, the pupil of Theodorus of Gadara.

See Strabo xiii. p. 621; Cicero, *De inventione*, i. 6, 8, *Brutus*, 76, 263, 78, 271; Quintilian, *Instit.* iii. 1. 16, 3. 9, 11, 22; C. W. Piderit, *De Hermagora rhetore* (1839); G. Thiele, *Hermagoras Ein Beitrag zur Geschichte der Rhetorik* (1893).

HERMANDAD (from *hermano*, Lat. *germanus*, a brother), a Castilian word meaning, strictly speaking, a brotherhood. In the Romance language spoken on the east coast of Spain in Catalonia it is written *germandat* or *germania*. In the form *germania* it has acquired the significance of "thieves' Latin" or "thieves' cant," and is applied to any jargon supposed to be understood only by the initiated. But the typical "germania" is a mixture of slang and of the gipsy language. The hermandades have played a conspicuous part in the history of Spain. The first recorded case of the formation of an hermandad occurred in the 12th century when the towns and the peasantry of the north united to police the pilgrim road to Santiago in Galicia, and protect the pilgrims against robber knights. Throughout the middle ages such alliances were frequently formed by combinations of towns to protect the roads connecting them, and were occasionally extended to political purposes. They acted to some extent like the Fehm courts of Germany. The Catholic sovereigns, Ferdinand and Isabella, adapted an existing hermandad to the purpose of a general police acting under officials appointed by themselves, and endowed with large powers of summary jurisdiction even in capital cases. The hermandad became, in fact, a constabulary, which, however, fell gradually into neglect. In Catalonia and Valencia the "germanias" were combinations of the peasantry to resist the exactions of the feudal lords.

HERMAN DE VALENCIENNES, 12th-century French poet, was born at Valenciennes, of good parentage. His father and mother, Robert and Hérembourg, belonged to Hainault, and gave him for god-parents Count Baldwin and Countess Yolande—doubtless Baldwin IV. of Hainault and his mother Yolande. Herman was a priest and the author of a verse *Histoire de la Bible*, which includes a separate poem on the Assumption of the Virgin. The work is generally known as *Le Roman de sapience*, the name arising from a copyist's error in the first line of the poem:

"Comens de sapience, ce est la cremors de Deu"

the first word being miswritten in one MS. *Romens*, and in another *Romanz*. His work has, indeed, the form of an ordinary romance, and cannot be regarded as a translation. He selects such stories from the Bible as suit his purpose, and adds freely from legendary sources, displaying considerable art in the selection and use of his materials. This scriptural poem, very popular in its day, mentions Henry II. of England as already dead, and must therefore be assigned to a date posterior to 1189.

See *Notices et extraits des manuscrits* (Paris, vol. 34), and Jean Bonnard, *Les Traductions de la Bible en vers français au moyen âge* (1884).

HERMANN I. (d. 1217), landgrave of Thuringia and count palatine of Saxony, was the second son of Louis II. the Hard, landgrave of Thuringia, and Judith of Hohenstaufen, sister of the emperor Frederick I. Little is known of his early years, but in 1180 he joined a coalition against Henry the Lion, duke of Saxony, and with his brother, the landgrave Louis III., suffered a short imprisonment after his defeat at Weissensee by Henry. About this time he received from his brother Louis the Saxon palatinate, over which he strengthened his authority by marrying Sophia, sister of Adalbert, count of Sommerschenburg, a former count palatine. In 1190 Louis died and Hermann by his energetic measures frustrated the attempt of the emperor Henry VI. to seize Thuringia as a vacant fief of the Empire, and established himself as landgrave. Having joined a league against the emperor he was accused, probably wrongly, of an attempt to murder him. Henry was not only successful in detaching Hermann from the hostile combination, but gained his support for the scheme to unite Sicily with the Empire. In 1197 Hermann went on crusade. When Henry VI. died in 1198 Hermann's support was purchased by the late emperor's brother Philip, duke of Swabia, but as soon as Philip's cause appeared to be weakening he transferred his allegiance to Otto of Brunswick, afterwards the emperor Otto IV. Philip accordingly invaded Thuringia in 1204 and compelled Hermann to come to terms by which he surrendered the lands he had obtained in 1198. After the death of Philip and the recognition of Otto he was among the princes who invited Frederick of Hohenstaufen, afterwards the emperor Frederick II., to come to Germany and assume the crown. In consequence of this step the Saxons attacked Thuringia, but the landgrave was saved by Frederick's arrival in Germany in 1212. After the death of his first wife in 1195 Hermann married Sophia, daughter of Otto I., duke of Bavaria. By her he had four sons, two of whom, Louis and Henry Raspe, succeeded their father in turn as landgrave. Hermann died at Gotha on the 25th of April 1217, and was buried at Reinhardtsbrunn. He was fond of the society of men of letters, and Walther von der Vogelweide and other Minnesingers were welcomed to his castle of the Wartburg. In this connexion he figures in Wagner's *Tannhäuser*.

See E. Winkelmann, *Philipp von Schwaben und Otto IV. von Braunschweig* (Leipzig, 1873-1878); T. Knochenhauer, *Geschichte Thüringens* (Gotha, 1871); and F. Wächter, *Thüringische und ober-sächsische Geschichte* (Leipzig, 1826).

HERMANN OF REICHENAU (HERIMANNUS AUGIENSIS), commonly distinguished as Hermannus Contractus, i.e. the Lame (1013-1054), German scholar and chronicler, was the son of Count Wollerad of Alshausen in Swabia. Hermann, who became a monk of the famous abbey of Reichenau, is at once one of the most attractive and one of the most pathetic figures of medieval monasticism. Crippled and distorted by gout from his childhood, he was deprived of the use of his legs, but, in spite of this, he became one of the most learned men of his time, and exercised a great personal and intellectual influence on the numerous band of scholars he gathered round him. He died on the 24th of September 1054, at the family castle of Alshausen near Biberach. Besides the ordinary studies of the monastic scholar, he devoted himself to mathematics, astronomy and music, and constructed watches and instruments of various kinds.

His chief work is a *Chronicon ad annum 1054*, which furnishes important and original material for the history of the emperor Henry III. The first edition, from a MS. no longer extant, was printed by J. Siehard at Basel in 1529, and reissued by Heinrich Peter in 1549; another edition appeared at St Blaise in 1790 under the supervision of Usseermann; and a third, as a result of the collation of numerous MSS., forms part of vol. v. of Pertz's *Monumenta Germaniae Historica*. A German translation of the last is contributed by K. F. A. Nobbe to *Die Geschichtschreiber der deutschen Vorzeit* (1st ed., Berlin, 1851; 2nd ed., Leipzig, 1893). The separate lives of Conrad II. and Henry III., often ascribed to Hermann, appear to have perished. His treatises *De mensura astrolabii* and *De utilitatibus astrolabii* (to be found, on the authority of Salzburg MSS., in Pez, *Thesaurus anecdotorum novissimus*, iii.) being the first contributions of moment furnished by a European to this subject, Hermann was for a time considered the inventor of the astrolabe. A didactic poem from his pen, *De octo vitis principalibus*, is printed in Haupt's *Zeitschrift für deutsches Alterthum* (vol. xiii.); and he is sometimes credited

with the composition of the Latin hymns *Veni Sancte Spiritus*, *Saba Regina*, and *Alma Redemptoris*. A *martyrologium* by Hermann was discovered by E. Dümmler in a MS. at Stuttgart, and was published by him in "Das Martyrologium Notkers und seine Verwandten" in *Forschungen zur deutschen Geschichte*, xv. (Göttingen, 1885).

See H. Hansjakob, *Herimann der Lame* (Mainz, 1875); Pottkast, *Bibliotheca med. aev. s. Herimannus Augiensis*.

HERMANN OF WIED (1477-1552), elector and archbishop of Cologne, was the fourth son of Frederick, count of Wied (d. 1487), and was born on the 14th of January 1477. Educated for the Church, he became elector and archbishop in 1515, and ruled his electorate with vigour and intelligence, taking up at first an attitude of hostility towards the reformers and their teaching. A quarrel with the papacy turned, or helped to turn, his thoughts in the direction of Church reform, but he hoped this would come from within rather than from without, and with the aid of his friend John Gropper (1503-1559), began, about 1536, to institute certain reforms in his own diocese. One stepped to another, and as all efforts at union failed the elector invited Martin Bucer to Cologne in 1542. Supported by the estates of the electorate, and relying upon the recess of the diet of Regensburg in 1541, he encouraged Bucer to press on with the work of reform, and in 1543 invited Melancthon to his assistance. His conversion was hailed with great joy by the Protestants, and the league of Schmalkalden declared they were resolved to defend him; but the Reformation in the electorate received checks from the victory of Charles V. over William, duke of Cleves, and the hostility of the citizens of Cologne. Summoned both before the emperor and the pope, the elector was deposed and excommunicated by Paul III. in 1546. He resigned his office in February 1547, and retired to Wied. Hermann, who was also a bishop of Paderborn from 1532 to 1547, died on the 15th of August 1552.

See C. Varrentrapp, *Herzmann von Wied* (Leipzig, 1878).

HERMANN, FRIEDRICH BENEDICT WILHELM VON (1795-1868), German economist, was born on the 5th of December 1795, at Dinkelsbühl in Bavaria. After finishing his primary education he was for some time employed in a draughtsman's office. He then resumed his studies, partly at the gymnasium in his native town, partly at the universities of Erlangen and Würzburg. In 1817 he took up a private school at Nuremberg, where he remained for four years. After filling an appointment as teacher of mathematics at the gymnasium of Erlangen, he became in 1823 *Privatdozent* at the university in that town. His inaugural dissertation was on the notions of political economy among the Romans (*Dissertatio exhibens sententias Romanorum ad oeconomiam politicam pertinentes*, Erlangen, 1823). He afterwards acted as professor of mathematics at the gymnasium and polytechnic school in Nuremberg, where he continued till 1827. During his stay there he published an elementary treatise on arithmetic and algebra (*Lehrbuch der Arith. u. Algeb.*, 1826), and made a journey to France to inspect the organization and conduct of technical schools in that country. The results of his investigation were published in 1826 and 1828 (*Über technische Unterrichts-Anstalten*). Soon after his return from France he was made *professor extraordinarius* of political science of the university of Munich, and in 1833 he was advanced to the rank of ordinary professor. In 1832 appeared the first edition of his great work on political economy, *Staatswirtschaftliche Untersuchungen*. In 1835 he was made member of the Royal Bavarian Academy of Sciences. From the year 1836 he acted as inspector of technical instruction in Bavaria, and made frequent journeys to Berlin and Paris in order to study the methods there pursued. In the state service of Bavaria, to which he devoted himself, he rose rapidly. In 1837 he was placed on the council for superintendence of church and school work; in 1839 he was entrusted with the direction of the bureau of statistics; in 1845 he was one of the councillors for the interior; in 1848 he sat as member for Munich in the national assembly at Frankfort. In this assembly Hermann, with Johann Heckscher and others, was mainly instrumental in organizing the so-called "Great German" party, and was selected as one of the representatives of their views at Vienna. Warmly supporting the customs

union (Zollverein), he acted in 1851 as one of its commissioners at the great industrial exhibition at London, and published an elaborate report on the woollen goods. Three years later he was president of the committee of judges at the similar exhibition at Munich, and the report of its proceedings was drawn up by him. In 1855 he became councillor of state, the highest honour in the service. From 1835 to 1847 he contributed a long series of reviews, mainly of works on economical subjects, to the *Münchener gelehrte Anzeigen* and also wrote for Rau's *Archiv der politischen Ökonomie* and the *Augsburger allgemeine Zeitung*. As head of the bureau of statistics he published a series of valuable annual reports (*Beiträge zur Statistik des Königreichs Bayern*, Hefte 1-17, 1850-1867). He was engaged at the time of his death, on the 23rd of November 1868, upon a second edition of his *Staatswirtschaftliche Untersuchungen*, which was published in 1870.

Hermann's rare technological knowledge gave him a great advantage in dealing with some economic questions. He reviewed the principal fundamental ideas of the science with great thoroughness and acuteness. "His strength," says Roscher, "lies in his clear, sharp, exhaustive distinction between the several elements of a complex conception, or the several steps comprehended in a complex act." For keen analytical power his German brethren compare him with Ricardo. But he avoids several one-sided views of the English economist. Thus he places public spirit beside egoism as an economic motor, regards price as not measured by labour only but as a product of several factors, and habitually contemplates the consumption of the labourer, not as a part of the cost of production to the capitalist, but as the main practical end of economics.

See Kautz, *Gesch. Entwicklung d. National-Ökonomie*, pp. 633-638; Roscher, *Gesch. d. Nat.-Ökon. in Deutschland*, pp. 860-879.

HERMANN, JOHANN GOTTFRIED JAKOB (1772-1848), German classical scholar and philologist, was born at Leipzig on the 28th of November 1772. Entering the university of his native city at the age of fourteen, Hermann at first studied law, which he soon abandoned for the classics. After a session at Jena in 1793-1794, he became a lecturer on classical literature in Leipzig, in 1798 *professor extraordinarius* of philosophy in the university, and in 1803 professor of eloquence (and poetry, 1809). He died on the 31st of December 1848. Hermann maintained that an accurate knowledge of the Greek and Latin languages was the only road to a clear understanding of the intellectual life of the ancient world, and the chief, if not the only, aim of philology. As the leader of this grammatico-critical school, he came into collision with A. Böckh and Otfried Müller, the representatives of the historico-antiquarian school, which regarded Hermann's view of philology as inadequate and one-sided.

Hermann devoted his early attention to the classical poetical metres, and published several works on that subject, the most important being *Elementa doctrinae metricae* (1816), in which he set forth a scientific theory based on the Kantian categories. His writings on Greek grammar are also valuable, especially *De emendanda ratione Graecae grammaticae* (1801), and notes and excursus on Viger's treatise on Greek idioms. His editions of the classics include several of the plays of Euripides; the *Clouds* of Aristophanes (1790); *Trinummus* of Plautus (1800); *Poëtica* of Aristotle (1802); *Orphica* (1805); the Homeric *Hymns* (1806); and the *Lexicon* of Photius (1808). In 1825 Hermann finished the edition of Sophocles begun by Erfurd. His edition of Aeschylus was published after his death in 1852. The *Opuscula*, a collection of his smaller writings in Latin, appeared in seven volumes between 1827 and 1839.

See monographs by O. Jahn (1849) and H. Köchly (1874); C. Bursian, *Geschichte der klassischen Philologie in Deutschland* (1883); art. in *Allgem. deutsche Biog.*; Sandys, *Hist. Class. Schol.* iii.

HERMANN, KARL FRIEDRICH (1804-1855), German classical scholar and antiquary, was born on the 4th of August 1804, at Frankfort-on-Main. Having studied at the universities of Heidelberg and Leipzig, he went for a tour in Italy, on his return from which he lectured as *Privatdozent* in Heidelberg. In 1832 he was called to Marburg as *professor ordinarius* of classical

literature; and in 1842 he was transferred to Göttingen to the chair of philology and archaeology, vacant by the death of Otfried Müller. He died at Göttingen on the 31st of December 1855. His knowledge of all branches of classical learning was profound, but he was chiefly distinguished for his works on Greek antiquities and ancient philosophy. Among these may be mentioned the *Lehrbuch der griechischen Antiquitäten* (new ed., 1889) dealing with political, religious and domestic antiquities; the *Geschichte und System der Platonischen Philosophie* (1839), unfinished; an edition of the Platonic Dialogues (6 vols., 1851-1853); and *Culturgeschichte der Griechen und Römer* (1857-1858), published after his death by C. G. Schmidt. He also edited the text of Juvenal and Persius (1854) and Lucian's *De conscribenda historia* (1828). A collection of *Abhandlungen und Beiträge* appeared in 1849.

See M. Lechner, *Zur Erinnerung an K. F. Hermann* (1864), and article by C. Halm in *Allgemeine deutsche Biographie*, xii. (1880).

HERMAPHRODITUS, in Greek mythology, a being, partly male, partly female, originally worshipped as a divinity. The conception undoubtedly had its origin in the East, where deities of a similar dual nature frequently occur. The oldest traces of the cult in Greek countries are found in Cyprus. Here, according to Macrobius (*Saturnalia*, iii. 8) there was a bearded statue of a male aphrodite, called Aphroditos by Aristophanes (probably in his *Niobos*, a similar variant). Philochorus in his *Attika* (*op. Macrobius loc. cit.*) further identified this divinity, at whose sacrifices men and women exchanged garments, with the moon. This double sex also attributed to Dionysus and Priapus—the union in one being of the two principles of generation and conception—denotes extensive fertilizing and productive powers. This Cyprian Aphrodite is the same as the later Hermaphroditos, which simply means Aphroditos in the form of a herm (see HERMAE), and first occurs in the *Characteres* (16) of Theophrastus. After its introduction at Athens (probably in the 5th century B.C.), the importance of this being seems to have declined. It appears no longer as the object of a special cult, but limited to the homage of certain sects, expressed by superstitious rites of obscure significance. The still later form of the legend, a product of the Hellenistic period, is due to a mistaken etymology of the name. In accordance with this, Hermaphroditus is the son of Hermes and Aphrodite, of whom the nymph of the fountain of Salmacis in Caria became enamoured while he was bathing. When her overtures were rejected, she embraced him and entreated the gods that she might be for ever united with him. The result was the formation of a being, half man, half woman. This story is told by Ovid (*Métam.* iv. 285) to explain the peculiarly enervating qualities of the water of the fountain. Strabo (xiv. p. 656) attributes its bad reputation to the attempt of the inhabitants of the country to find some excuse for the demoralization caused by their own luxurious and effeminate habits of life. There was a famous statue of Hermaphroditus by Polyycles of Athens, probably the younger of the two statuaries of that name. In later Greek art he was a favourite subject.

See articles in Drexler and Sagio, *Dictionnaire des antiquités*, and Roscher's *Lexikon der Mythologie*; and for art, A. Baumeister, *Denkmäler des klassischen Altertums* (1884-1888).

HERMAS, SHEPHERD OF, one of the works representing the Apostolic Fathers (*q.v.*), a hortatory writing which "holds the mirror up" to the Church in Rome during the 3rd Christian generation. This is the period indicated by the evidence of the Muratorian Canon, which assigns it to the brother of Pius, Roman bishop c. 139-154. Probably it was not the fruit of a single effort of its author. Rather its contents came to him piecemeal and at various stages in his ministry as a Christian "prophet," extending over a period of years; and, like certain Old Testament prophets, he shows us how by his own experiences he became the medium of a divine message to his church and to God's "elect" people at large.

In its present form it falls under three heads: *Visions, Mandates, Similitudes*. But these divisions are misleading. The personal and preliminary revelation embodied in *Vision* i. brings the prophet a new sense of sin as essentially a matter of the heart,

and an awakened conscience as before the "glory of God," the Creator and Upholder of all things. His responsibility also for the sad state of religion at home is emphasized, and he is given a mission of repentance to his erring children. How far in all this and in the next vision the author is describing facts, and how far transforming his personal history into a type (after the manner of Bunyan's *Pilgrim's Progress*), the better to impress his moral upon his readers, is uncertain. But the whole style of the work, with its use of conventional apocalyptic forms, favours the more symbolic view. *Vision ii.* records his call proper, through revelation of his essential message, to be delivered both to his wife and children and to "all the saints who have sinned unto this day" (2. 4). It contains the assurances of forgiveness even for the gravest sins after baptism (save blasphemy of the Name and betrayal of the brethren, *Sim. ix.* 10), "if they repent with their whole heart and remove doubts from their minds. For the Master hath sworn by His glory ('His Son,' below) touching His elect, that if there be more sinning after this day which He hath limited, they shall not obtain salvation. For the repentance of the righteous hath an end; the days of repentance for all saints are fulfilled. . . . Stand fast, then, ye that work righteousness and be not of doubtful mind. . . . Happy are all ye that endure the great tribulation which is to come. . . . *The Lord is nigh unto them that turn to Him*, as it is written in the book of Eldad and Modad, who prophesied to the people in the wilderness."

Here, in the gist of the "booklet" received from the hand of a female figure representing the Church, we have in germ the message of *The Shepherd*. But before Hermas announces it to the Roman Church, and through "Clement" to the churches abroad, there are added two *Visions* (iii. iv.) tending to heighten its impressiveness. He is shown the "holy church" under the similitude of a tower in building, and the great and final tribulation (already alluded to as near at hand) under that of a devouring beast, which yet is innocuous to undoubting faith.

Hermas begins to deliver the message of *Vis. i.-iv.*, as bidden. But as he does so, it is added to, in the way of detail and illustration, by a fresh series of revelations through an angel in the guise of a Shepherd, who in a preliminary interview announces himself as the Angel of Repentance, sent to administer the special "repentance" which it was Hermas's mission to declare. This interview appears in our MSS. as *Vis. v.*,¹ but is really a prelude to the *Mandates* and *Similitudes* which form the bulk of the whole work, hence known as "The Shepherd." The relation of this second part to *Vis. i.-iv.* is set forth by the Shepherd himself. "I was sent, quoth he, to show thee *again* all that thou sawest before, to wit the sum of the things profitable for thee. First of all write thou my mandates and similitudes; and the rest, as I will show thee, so shalt thou write." This programme is fulfilled in the xii. *Mandates*—perhaps suggested by the *Teaching of the Twelve Apostles* (see DIDACHE), which Hermas knows—and *Similitudes i.-viii.*, while *Simil. ix.* is "the rest" and constitutes a distinct "book" (*Sim. ix. 1. 1, x. 1. 1*). In this latter the building of the Tower, already shown in outline in *Vis. iii.*, is shown "more carefully" in an elaborate section dealing with the same themes. One may infer that *Sim. ix.* represents a distinctly later stage in Hermas's ministry—during the whole of which he seems to have committed to writing what he received on each occasion,² possibly for recital to the church (cf. *Vis. ii. An.*). Finally came *Sim. x.*, really an epilogue in which Hermas is "delivered" afresh to the Shepherd, for the rest of his days. He is "to continue in this ministry" of proclaiming the Shepherd's

¹ More than one interpretation, typical or otherwise, of this "Clement" is possible; but none justifies us in assigning even to this *Vision* a date consistent with that usually given to the traditional bishop of this name (see CLEMENT I.). Yet we may have to correct the dubious chronology of the first Roman bishops by this datum, and prolong his life to about A.D. 110. This is Harnack's date for the nucleus of *Vis. ii.*, though he places our *Vis. i.-iii.* later in Trajan's reign, and thinks *Vis. iv.* later still.

² That a prior vision in which Hermas was "delivered" to the Shepherd's charge, has dropped out, seems implied by *Vis. v. 3 f., Sim. x. 1. 1*.

³ Harnack places "The Shepherd" proper mostly under Hadrian (117-138), and the completed work c. 140-145.

teaching, "so that they who have repented or are about to repent may have the same mind with thee," and so receive a good report before God (*Sim. x. 2. 2-4*). Only they must "make haste to do aright," lest while they delay the tower be finished (4. 4), and the new æon dawn (after the final tribulation: cf. *Vis. iv. 3. 5*).

The relation here indicated between the Shepherd's instruction and the initial message of one definitive repentance, open to those believers who have already "broken" their "seal" of baptism by deadly sins, as announced in *Visions i.-iv.* is made yet plainer by *Sim. vi. 1. 3 f.* "These mandates are profitable to such as are about to repent; for except they walk in them their repentance is in vain." Hermas sees that mere repentance is not enough to meet the backsliding condition in which so many Christians then were, owing to the recoil of inveterate habits of worldliness entrenched in society around and within. It is, after all, too negative a thing to stand by itself or to satisfy God. "Cease, Hermas," says the Church, "to pray all about thy sins. Ask for righteousness also" (*Vis. iii. 1. 6*). The positive Christian ideal which "the saints" should attain, "the Lord enabling," it is the business of the Shepherd to set forth.

Here lies a great merit of Hermas's book, his insight into experimental religion and the secret of failure in Christians about him, to many of whom Christianity had come by birth rather than personal conviction. They shared the worldly spirit in its various forms, particularly the desire for wealth and the luxuries it affords, and for a place in "good society"—which meant a pagan atmosphere. Thus they were divided in soul between spiritual goods and worldly pleasures, and were apt to doubt whether the rewards promised by God to the life of "simplicity" (all Christ meant by the childlike spirit, including generosity in giving and forgiving) and self-restraint, were real or not. For while the expected "end of the age" delayed, persecutions abounded. Such "doubled-souled" persons, like Mr Facing-both-ways, inclined to say, "The Christian ideal may be glorious, but is it practicable?" It is this most fatal doubt which evokes the Shepherd's sternest rebuke; and he meets it with the ultimate religious appeal, viz. to "the glory of God." He who made man "to rule over all things under heaven," could He have given behests beyond man's ability? If only a man "hath the Lord in his heart," he "shall know that there is nothing easier nor sweeter nor gentler than these mandates" (*Mand. xii. 3-4*). So in the forefront of the *Mandates* stands the secret of all: "First of all believe that there is one God. . . . Believe therefore in Him, and fear Him, and fearing Him have self-mastery. For the fear of the Lord dwelleth in the good desire," and to "put on" this master-desire is to possess power to curb "evil desire" in all its shapes (*Mand. xii. 1-2*). Elsewhere "good desire" is analysed into the "spirits" of the several virtues, which yet are organically related, Faith being mother, and Self-mastery her daughter, and so on (*Vis. iii. 8. 3 seq.; cf. Sim. ix. 15*). These are the specific forms of the Holy Spirit power, without whose indwelling the mandates cannot be kept (*Sim. x. 3; cf. ix. 13. 2, 4. 2*).

Thus the "moralism" sometimes traced in Hermas is apparent rather than real, for he has a deep sense of the enabling grace of God. His defect lies rather in not presenting the historic Christ as the Christian's chief inspiration, a fact which connects itself with the strange absence of the names "Jesus" and "Christ." He uses rather "the Son of God," in a peculiar Adoptianist sense, which, as taken for granted in a work by the bishop's own brother, must be held typical of the Roman Church of his day. But as it is implicit and not part of his distinctive message, it did not hinder his book from enjoying wide quasi-canonical honour during most of the Ante-Nicene period.

The absence of the historic names, "Jesus" and "Christ," may be due to the form of the book as purporting to quote angelic communications. This would also explain the absence of explicit scriptural citations generally, though knowledge both of the Old Testament and of several New Testament books—including the congenially symbolic Gospel of John—is clear (cf. *The New Testament in the Apostolic Fathers*, Oxford, 1905, 105 seq.). The one exception is a prophetic writing, the apocryphal *Book of Eldad and Modad*,

⁴ A careful study of practical Christian ethics at Rome as implied in the *Shepherd*, will be found in E. von Dobschütz, *Christian Life in the Primitive Church* (1904).

which is cited apparently as being similar in the scope of its message. Among its non-scriptural sources may be named the allegoric picture of human life known as *Tabula Cebetis* (cf. C. Taylor, as below), the *Didaché*, and perhaps certain "Sibylline Oracles." Hermas regarded Christians as "justified by the most revered Angel" (i.e. the pre-existent Holy Spirit or Son, who dwelt in Christ's "flesh"), in baptism, the "seal" which even Old Testament saints had to receive in Hades (*Sim.* ix. 16. 3-7) and so attain to "life." Yet the degree of "honour" (e.g. that of martyrs, *Vis.* iii. 2; *Sim.* ix. 28), the exact place in the kingdom or consummated church (the Tower), is given as reward for zeal in doing God's will beyond the minimum requisite in all. Here comes in Hermas's doctrine of works of supererogation, in fulfilment of counsels of perfection, on lines already seen in *Did.* vi. 2, cf. i. 4, and reappearing in the two types of Christian recognized by Clement and Origen and in later Catholicism. Again his doctrine of fasting is a spiritualizing of a current *opus operatum* conception on Jewish lines as though "keeping a watch" (*statio*) in that way atoned for sins (*Sim.* v.). The Shepherd enjoins instead, first, as "a perfect fast," a fast "from every evil word and every evil desire, . . . from all the vanities of this world-age" (3. 6; cf. *Bern.* iii. and the *Oxyrhynchus Saying*, "except ye fast from the world"); and next, as a counsel of perfection, a fast to yield somewhat for the relief of the widow and orphan, that this extra "service" may be to God for a "sacrifice."

Generally speaking, Hermas's poetry, especially in its language, adheres closely to Old Testament forms. But it is doubtful (*pace* Spitta and Völter, who assume a Jewish or a proselyte basis) whether this means more than that the Old Testament was still the Scriptures of the Church. In this respect, too, Hermas faithfully reflects the Roman Church of the early 2nd century (cf. the language of 1 Clem., esp. the liturgical parts, and even the Roman Mass). Indeed the prime value of the *Shepherd* is the light it casts on Christianity at Rome in the otherwise obscure period c. 110-140, when it had as yet hardly felt the influences converging on it from other centres of tradition and thought. Thus Hermas's comparatively mild censures on Gnostic teachers in *Sim.* ix. suggest that the greater systems, like the Valentinian and Marcionite, had not yet made an impression there, as Harnack argues that they must have done by c. 145. This date, then, is a likely lower limit for Hermas's revision of his earlier prophetic memoranda, and their publication in a single homogeneous work, such as the *Shepherd* appears to be. Its wider historic significance—it was felt by its author to be adapted to the needs of the Church at large, and was generally welcomed as such—is great but hard to determine in detail.¹ What is certain is its influence on the development of the Church's policy as to discipline in grave cases, like apostasy and adultery—a burning question for some generations from the end of the 2nd century, particularly in Rome and North Africa. Indirectly, too, Hermas tended to keep alive the idea of the Christian prophet, even after Montanism had helped to discredit it.

LITERATURE.—The chief modern edition is by O. von Gebhardt and A. Harnack, in *Fasc.* iii. of their *Patr. apost. opera* (Leipzig, 1877); it is edited less fully by F. X. Funk, *Patr. apost.* (Tübingen, 1901), and in an English trans., with Introduction and occasional notes, by Dr C. Taylor (S.P.C.K., 2 vols., 1903-1906). For the wide literature of the subject, see the two former editions, also Harnack's *Chronologie der altchr. Lit.* i. 257 seq., and O. Bardenheuer, *Gesch. der altchrh. Lit.* i. 557 seq. For the authorship see APOCALYPTIC LITERATURE, sect. III. (J. V. B.)

HERMENEUTICS (Gr. *ἑρμηνευτική*, sc. *τέχνη*, Lat. *ars hermeneutica*, from *ἑρμηνεύειν*, to interpret, from Hermes, the messenger of the gods), the science or art of interpretation or explanation, especially of the Holy Scriptures (see THEOLOGY).

HERMES, a Greek god, identified by the Romans with Mercury. The derivation of his name and his primitive character are very uncertain. The earliest centres of his cult were Arcadia, where Mt. Cyllene was reputed to be his birthplace, the islands of Lemnos, Imbros and Samothrace, in which he was associated with the Cabeiri and Attica. In Arcadia he was specially worshipped as the god of fertility, and his images were ithyphallic, as also were the "Hermæ" at Athens. Herodotus (ii. 51) states that the Athenians borrowed this type from the Pelasgians, thus testifying to the great antiquity of the phallic Hermes. At Cyllene in Elis a mere phallus served as his emblem, and was highly venerated in the time of Pausanias (vi. 26. 3). Both in literature and cult Hermes was constantly associated with the protection of cattle and sheep; at Tanagra and elsewhere his title was *κρωφόρος*, the ram-bearer. As a pastoral god he was often closely connected with deities of vegetation, especially Pan and the nymphs. His pastoral character is recognized in the

¹ Note the prestige of martyrs and confessors, the visions of true and false prophets in *Mand.* xi., and the different types of evil and good "walk" among Christians, e.g. in *Vis.* iii. 5-7; *Mand.* viii.; *Sim.* viii.

Iliad (xiv. 490) and the later epic hymn to Hermes; and his Homeric titles *ἄκαηρα*, *ἑρμολίος*, *ἄστραρ ἄκων*, probably refer to him as the giver of fertility. In the *Odyssey*, however, he appears mainly as the messenger of the gods, and the conductor of the dead to Hades. Hence in later times he is often represented in art and mythology as a herald. The conductor of souls was naturally a chthonian god; at Athens there was a festival in honour of Hermes and the souls of the dead, and Aeschylus (*Persæ*, 628) invokes Hermes, with Earth and Hades, in summing a spirit from the underworld. The function of a messenger-god may have originated the conception of Hermes as a dream-god; he is called the "conductor of dreams" (*ἡγήτωρ ὀνείρων*), and the Greeks offered to him the last libation before sleep. As a messenger he may also have become the god of roads and doorways; he was the protector of travellers and his images were used for boundary-marks (see HERMÆS). It was a custom to make a cairn of stones near the wayside statues of Hermes, each passer-by adding a stone; the significance of the practice, which is found in many countries, is discussed by Frazer (*Golden Bough*, 2nd ed., iii. 10 f.) and Hartland (*Legend of Perseus*, ii. 228). Treasure found in the road (*ἑρμαίων*) was the gift of Hermes, and any stroke of good luck was attributed to him; but it may be doubted whether his patronage of luck in general was developed from his function as a god of roads. As the giver of luck he became a deity of gain and commerce (*κερφόρος*, *ἀγοραῖος*), an aspect which caused his identification with Mercury, the Roman god of trade. From this conception his thievish character may have been evolved. The trickery and cunning of Hermes is a prominent theme in literature from Homer downwards, although it is very rarely recognized in official cult.² In the hymn to Hermes the god figures as a precocious child (a type familiar in folk-lore, who when a new-born babe steals the cows of Apollo. In addition to these characteristics various other functions were assigned to Hermes, who developed, perhaps, into the most complete type of the versatile Greek. In many respects he was a counterpart of Apollo, less dignified and powerful, but more human than his greater brother. Hermes was a patron of music, like Apollo, and invented the cithara; he presided over the games, with Apollo and Heracles, and his statues were common in the stadia and gymnasia. He became, in fact, the ideal Greek youth, equally proficient in the "musical" and "gymnastic" branches of Greek education. On the "musical" side he was the special patron of eloquence (*λόγιος*); in gymnastic, he was the giver of grace rather than of strength, which was the province of Heracles. Though athletic, he was one of the least militant of the gods; a title *πρωμαχος*, the Defender, is found only in connexion with a victory of young men ("ephebes") in a battle at Tanagra. A further point of contact between Hermes and Apollo may here be noted: both had prophetic powers, although Hermes held a place far inferior to that of the Pythian god, and possessed no famous oracle. Certain forms of popular divination were, however, under his patronage, notably the world-wide process of divination by pebbles (*θραλά*). The "Homeric" Hymn to Hermes explains these minor gifts of prophecy as delegated by Apollo, who alone knew the mind of Zeus. Only a single oracle is recorded for Hermes, in the market-place of Pharae in Achaë, and here the procedure was akin to popular divination. An altar, furnished with lamps, was placed before the statue; the inquirer, after lighting the lamps and offering incense, placed a coin in the right hand of the god; he then whispered his question into the ear of the statue, and, stopping his own ears, left the market place. The first sound which he heard outside was an omen.

From the foregoing account it will be seen that it is difficult to derive the many-sided character of Hermes from a single elemental conception. The various theories which identified him with the sun, the moon or the dawn, may be dismissed, as they do not rest on evidence to which value would now be attached. The Arcadian or "Pelasgic" Hermes may have been an earth-deity, as his connexion with fertility suggests; but his symbol at Cyllene

² We only hear of a Hermes ἄλλιος at Pellene (Paus. vii. 27. 1) and of the custom of allowing promiscuous thieving during the festival of Hermes at Samos (Plut. *Quæst. Græc.* 55).

rather points to a mere personification of reproductive powers. According to Plutarch the ancients "set Hermes by the side of Aphrodite," i.e. the male and female principles of generation; and the two deities were worshipped together in Argos and elsewhere. But this phallic character does not explain other aspects of Hermes, as the messenger-god, the master-thief or the ideal Greek ephebe. It is impossible to adopt the view that the Homeric poets turned the rude shepherd-god of Arcadia into a messenger, in order to provide him with a place in the Olympian circle. To their Achæan audience Hermes must have been more than a phallic god. It is more probable that the Olympian Hermes represents the fusion of several distinct deities. Some scholars hold that the various functions of Hermes may have originated from the idea of good luck which is so closely bound up with his character. As a pastoral god he would give luck to the flocks and herds; when worshipped by townspeople, he would give luck to the merchant, the orator, the traveller and the athlete. But though the notion of luck plays an important part in early thought, it seems improbable that the primitive Greeks would have personified a mere abstraction. Another theory, which has much to commend it, has been advanced by Roscher, who sees in Hermes a wind-god. His strongest arguments are that the wind would easily develop into the messenger of the gods (*Διὸς ὄψος*), and that it was often thought to promote fertility in crops and cattle. Thus the two aspects of Hermes which seem most discordant are referred to a single origin. The Homeric epithet Ἄργυροφόρος, which the Greeks interpreted as "the slayer of Argus," inventing a myth to account for Argus, is explained as originally an epithet of the wind (*ἀργυροφῆς*), which clears away the mists (*ἀργύς*, *φαίωλα*). The uncertainty of the wind might well suggest the trickery of a thief, and its whistling might contain the germ from which a god of music should be developed. But many of Roscher's arguments are forced, and his method of interpretation is not altogether sound. For example, the last argument would equally apply to Apollo, and would lead to the improbable conclusion that Apollo was a wind-god. It must, in fact, be remembered that men make their gods after their own likeness; and, whatever his origin, Hermes in particular was endowed with many of the qualities and habits of the Greek race. If he was evolved from the wind, his character had become so anthropomorphic that the Greeks had practically lost the knowledge of his primitive significance; nor did Greek cult ever associate him with the wind.

The oldest form under which Hermes was represented was that of the Hermae mentioned above. Alcamenes, the rival or pupil of Pheidias, was the sculptor of a herm at Athens, a copy of which, dating from Roman times, was discovered at Pergamum in 1903. But side by side with the Hermae there grew up a more anthropomorphic conception of the god. In archaic art he was portrayed as a full-grown and bearded man, clothed in a long chiton, and often wearing a cap (*κωνή*) or a broad-brimmed hat (*πέτρασος*), and winged boots. Sometimes he was represented in his pastoral character, as when he bears a sheep on his shoulders; at other times he appears as the messenger or herald of the gods with the *κρυπεῖον*, or herald's staff, which is his most frequent attribute. From the latter part of the 5th century his art-type was changed in conformity with the general development of Greek sculpture. He now became a nude and beardless youth, the type of the young athlete. In the 4th century this type was probably fixed by Praxiteles in his statue of Hermes at Olympia.

AUTHORITIES.—F. G. Welcker, *Griech. Götterl.* i. 342 f. (Göttingen, 1857-1863); L. Preller, ed. C. Robert, *Griech. Mythologie*, ii. 385 seq. (Berlin, 1894); W. H. Roscher, *Lex. der griech. u. röm. Mythologie*, s. v. (Leipzig, 1884-1886); A. Lang, *Myth, Ritual and Religion*, ii. 225 seq. (London, 1887); C. Daremberg and E. Saglio, *Dict. des ant. grecques et rom.*; Farnell, *Cults v.* (1909); O. Gruppe, *Griech. Mythologie u. Religionsgesch.* p. 1318 seq. (Munich, 1906). In the article GREEK ART, figs. 43 and 82 (Plate VI.) represent the Hermae of Praxiteles; fig. 57 (Plate II.), a professed copy of the Hermae of Alcamenes. (E. E. S.)

HERMES, GEORG (1775-1831), German Roman Catholic theologian, was born on the 22nd of April 1775, at Dreyerwalde, in Westphalia, and was educated at the gymnasium and university of Münster, in both of which institutions he afterwards

taught. In 1800 he was appointed professor of theology at Bonn, where he died on the 26th of May 1831. Hermes had a devoted band of adherents, of whom the most notable was Peter Josef Elvenich (1796-1886), who became professor at Breslau in 1820, and in 1870 threw in his lot with the Old Catholic movement. His works were *Untersuchungen über die innere Wahrheit des Christenthums* (Münster, 1805), and *Einleitung in die christkatholische Theologie*, of which the first part, a philosophical introduction, was published in 1819; the second part, on positive theology, in 1829. The *Einleitung* was never completed. His *Christkatholische Dogmatik* was published, from his lectures, after his death by two of his students, Achterfeld and Braun (3 vols., 1831-1834).

The *Einleitung* is a remarkable work, both in itself and in its effect upon Catholic theology in Germany. Few works of modern times have excited a more keen and bitter controversy. Hermes himself was very largely under the influence of the Kantian and Fichtean ideas, and though in the philosophical portion of his *Einleitung* he criticizes both these thinkers severely, rejects their doctrine of the moral law as the sole guarantee for the existence of God, and condemns their restricted view of the possibility and nature of revelation, enough remained of purely speculative material to render his system obnoxious to his church. After his death, the contests between his followers and their opponents grew so bitter that the dispute was referred to the papal see. The judgment was adverse, and on the 25th of September 1835 a papal bull condemned both parts of the *Einleitung* and the first volume of the *Dogmatik*. Two months later the remaining volumes of the *Dogmatik* were likewise condemned. The controversy did not cease, and in 1845 a systematic attempt was made anonymously by F. X. Werner to examine and refute the Hermetian doctrines, as contrasted with the orthodox Catholic faith (*Der Hermetianismus*, 1845). In 1847 the condemnation of 1835 was confirmed by Pius IX.

See K. Werner, *Geschichte der katholischen Theologie* (1866), pp. 405-499.

HERMES TRISMEGISTUS ("the thrice greatest Hermes"), an honorific designation of the Egyptian Hermes, i.e. Thoth (*q. v.*), the god of wisdom. In late hieroglyphic the name of Thoth often has the epithet "the twice very great," sometimes "the thrice very great"; in the popular language (demotic) the corresponding epithet is "the five times very great," found as early as the 3rd century B.C. Greek translations give *ὁ μέγας καὶ μέγιστος* and *τρίμεγιστος*; *τρίμεγιστος* occurs in a late magical text. *ὁ τριμέγιστος* has not yet been found earlier than the 2nd century A.D., but there can now be no doubt of its origin in the above Egyptian epithets.

Thoth was "the scribe of the gods," "Lord of divine words," and to Hermes was attributed the authorship of all the strictly sacred books generally called by Greek authors Hermetic. These, according to Clemens Alexandrinus, our sole ancient authority (*Strom.* vi. p. 268 et seq.), were forty-two in number, and were subdivided into six divisions, of which the first, containing ten books, was in charge of the "prophet" and dealt with laws, deities and the education of priests; the second, consisting of the ten books of the *stolistes*, the official whose duty it was to dress and ornament the statues of the gods, treated of sacrifices and offerings, prayers, hymns, festive processions; the third, of the "hierogrammatist," also in ten books, was called "hieroglyphics," and was a repository of cosmographical, geographical and topographical information; the four books of the "horoscopus" were devoted to astronomy and astrology; the two books of the "chanter" contained respectively a collection of songs in honour of the gods and a description of the royal life and its duties; while the sixth and last division, consisting of the six books of the "pastophorus," was medical. Clemens's statement cannot be contradicted. Works are extant in papyri and on temple walls, treating of geography, astronomy, ritual, myths, medicine, &c. It is probable that the native priests would have been ready to ascribe the authorship or inspiration, as well as the care and protection of all their books of sacred lore to Thoth, although

there were a goddess of writing (Seshit), and the ancient deified scribes Imuthes and Amenophis, and later inspired doctors Petosiris, Nechepso, &c., to be reckoned with; there are indeed some definite traces of such an attribution extant in individual cases. Whether a canon of such books was ever established, even in the latest times, may be seriously doubted. We know, however, that the vizier of Upper Egypt (at Thebes) in the eighteenth dynasty, had 40 (not 42) parchment rolls laid before him as he sat in the hall of audience. Unfortunately we have no hint of their contents. Forty-two was the number of divine assessors at the judgment of the dead before Osiris, and was the standard number of the nomes or counties in Egypt.

The name of Hermes seems during the 3rd and following centuries to have been regarded as a convenient pseudonym to place at the head of the numerous syncretistic writings in which it was sought to combine Neo-Platonic philosophy, Philonic Judaism and cabalistic theosophy, and so provide the world with some acceptable substitute for the Christianity which had even at that time begun to give indications of the ascendancy it was destined afterwards to attain. Of these pseudepigraphic Hermetic writings some have come down to us in the original Greek; others survive in Latin or Arabic translations; but the majority appear to have perished. That which is best known and has been most frequently edited is the *Πομπάνορος* sive *De potestate et sapientia divina* (*Πομπάνορος* being the Divine Intelligence, *πομπή* *ἀνδρῶν*), which consists of fifteen chapters treating of such subjects as the nature of God, the origin of the world, the creation and fall of man, and the divine illumination which is the sole means of his deliverance. The *editio princeps* appeared in Paris in 1554; there is also an edition by G. Parthey (1854); the work has also been translated into German by D. Tiedemann (1781). Other Hermetic writings which have been preserved, and which have been for the most part collected by Patricius in the *Nova de universis philosophia* (1503), are (in Greek) *Ἱερομαθηματικά πρὸς Ἀμμωνα Αἰγύπτιον*, *Περὶ καταστάσεως νοσούντων περιγρωστικά*, *Ἐκ τῆς μαθηματικῆς ἐπιστήμης πρὸς Ἀμμωνα*; (in Latin) *Aphorismi sive Centiloquium*, *Cyranides*; (in Arabic, but doubtless from a Greek original) an address to the human soul, which has been translated by H. L. Fleischer (*An die menschliche Seele*, 1870).

The connexion of the name of Hermes with alchemy will explain what is meant by hermetic sealing, and will account for the use of the phrase "hermetic medicine" by Paracelsus, as also for the so-called "hermetic freemasonry" of the middle ages.

Besides Thoth, Anubis (*q.v.*) was constantly identified with Hermes; see also HORUS.

See Ursinus, *De Zoroastro, Hermete, &c.* (Nuremberg, 1661); Nicolas Lenglet-Dufresnoy, *L'Histoire de la philosophie hermétique* (Paris, 1742); Baumgarten-Crusius, *De librorum hermeticorum origine atque indole* (Jena, 1827); B. J. Hilgers, *De Hermetis Trismegisti Poemando* (1855); R. Ménard, *Hermès Trismégiste, traduction complète, précédée d'une étude sur l'origine des livres hermétiques* (1866); R. Pietschmann, *Hermès Trismegistus, nach ägyptischen, griechischen, und orientalischen Überlieferungen* (1875); R. Reitzenstein, *Poimandres, Studien zur griechisch-ägyptischen und frühchristlichen Literatur* (Leipzig, 1904); G. R. S. Mead, *Thrice Great Hermes* (1907), introduction and translation. (F. L. G.)

HERMESIANAX, of Colophon, elegiac poet of the Alexandrian school, flourished about 330 B.C. His chief work was a poem in three books, dedicated to his mistress Leontion. Of this poem a fragment of about one hundred lines has been preserved by Athenæus (xiii. 597). Plaintive in tone, it enumerates instances, mythological and historical, of the irresistible power of love. Hermesianax, whose style is characterized by alternate force and tenderness, was exceedingly popular in his own times, and was highly esteemed even in the Augustan period.

Many separate editions have been published of the fragment, the text of which is in a very unsatisfactory condition: by F. W. Schneidewin (1838), J. Bailey (1839, with notes, glossary, and Latin and English versions), and others; R. Schulze's *Quæstiones Hermesianacæ* (1858), contains an account of the life and writings of the poet and a section on the identity of Leontion.

HERMIAS. (1) A Greek philosopher of the Alexandrian school. A disciple of Proclus, he was known best for the lucidity of his method rather than for any original ideas. His chief works

were a study of the *Isagoge* of Porphyry and a commentary on Plato's *Phædrus*. Unlike the majority of logicians of the time, he admitted the absolute validity of the second and third figures of the syllogism.

(2) A Christian apologist and philosopher who flourished probably in the 4th and 5th centuries. Nothing is known about his life, but there has been preserved of his writings a small thesis entitled *Διασυρμὸς τῶν ἔξω φιλοσόφων*. In this work he attacked pagan philosophy for its lack of logic in dealing with the root problems of life, the soul, the cosmos and the first cause or vital principle. There is an edition by von Otto published in the *Corpus apologetarum* (Jena, 1872). It is interesting, but without any claim to profundity of reasoning.

Two minor philosophers of the same name are known. Of these, one was a disciple of Plato and a friend of Aristotle; he became tyrant of Atarneus and invited Aristotle to his court. Aristotle subsequently married Pythias, who was either niece or sister of Hermias. Another Hermias was a Phœnician philosopher of the Alexandrian school; when Justinian closed the school of Athens, he was one of the five representatives of the school who took refuge at the Persian court.

HERMIPPUS, "the one-eyed," Athenian writer of the Old Comedy, flourished during the Peloponnesian War. He is said to have written 40 plays, of which the titles and fragments of nine are preserved. He was a bitter opponent of Pericles, whom he accused (probably in the *Μοῖραι*) of being a bully and a coward, and of carousing with his boon companions while the Lacedæmonians were invading Attica. He also accused Aspasia of impiety and offences against morality, and her acquittal was only secured by the tears of Pericles (Plutarch, *Pericles*, 32). In the *Ἀπροσώλιδες* ("Bakeresses") he attacked the demagogue Hyperbolus. The *Φορμωδοῖς* (Mat-carriers) contains many parodies of Homer. Hermippus also appears to have written scurrilous iambic poems after the manner of Archilochus.

Fragments in T. Kock, *Comicorum Atticorum fragmenta*, i. (1880), and A. Meineke, *Poëtarum Græcorum comicorum fragmenta* (1855).

HERMIT, a solitary, one who withdraws from all intercourse with other human beings in order to live a life of religious contemplation, and so marked off from a "coenobite" (Gr. *κοινός*, common, and *βίος*, life), one who shares this life of withdrawal with others in a community (see ASCETICISM and MONASTICISM). The word "hermit" is an adaptation through the O. Fr. *ermite* or *hermile*, from the Lat. form, *eremite*, of the Gr. *ἐρημίτης*, a solitary, from *ἐρημία*, a desert. The English form "eremite," which was used, according to the *New English Dictionary*, quite indiscriminately with "hermit" till the middle of the 17th century, is now chiefly used in poetry or rhetorically, except with reference to the early hermits of the Libyan desert, or sometimes with such particular orders as the eremites of St Augustine (see AUGUSTINIAN HERMITS). Another synonym is "anchorite" or "anchorite." This comes through the French and Latin forms from the Gr. *ἀναχωρητής*, from *ἀναχωρεῖν*, to withdraw. A form nearer to the Greek original, "anachoret," is sometimes used of the early Christian recluses in the East.

HERMOGENES, of Tarsus, Greek rhetorician, surnamed *Ἐυρηθῆς* (the polisher), flourished in the reign of Marcus Aurelius (A.D. 161-180). His precocious ability secured him a public appointment as teacher of his art while as yet he was only a boy; but at the age of twenty-five his faculties gave way, and he spent the remainder of his long life in a state of intellectual impotence. During his early years, however, he had composed a series of rhetorical treatises, which became popular text-books, and the subject of subsequent commentaries. Of his *Ἐγχειρηματα* we still possess the sections *Περὶ τῶν στίσεων* (on legal issues), *Περὶ εὐρηθῶν* (on the invention of arguments), *Περὶ ἰδῶν* (on the various kinds of style), *Περὶ μεθόδου δευτέρου* (on the method of speaking effectively), and *Προρρηματάματα* rhetorical exercises).

Editions by C. Walz (1832), and by L. Spengel (1854), in their *Rhetores Græci*; bibliographical note on the commentaries in W. Christ, *Geschichte der griechischen Literatur* (1898).

HERMON, the highest mountain in Syria (estimated at 9050 to 9200 ft.), an outlier of the Anti-Lebanon. As the Hebrew name *הַר הַרְמוֹן*, "belonging to a sanctuary," "separate" shows, it was always a sacred mountain. The Sidonians called it *Sivion*, and the

Amortis Sævis (Deut. iii. 9). According to one theory it is the "high mountain" near Caesarea Philippi, which was the scene of the Transfiguration (Mark ix. 2). A curious reference in Enoch vi. 6, says that in the days of Jared the wicked angels descended on the summit of the mountain and named it Hermon. The modern name is *Jebel es-Sheikh*, or "mountain of the chief or elder." It is also called *Jebel el-Thelj*, "snowy mountain." The ridge of Hermon, rising into a dome-shaped summit, is 20 m. long, extending north-east and south-west. The formation of the lower part is Nubian sandstone, that of the upper part is a hard dark-grey crystalline limestone belonging to the Neocomian period, and full of fossils. The spurs consist in some cases of white chalk covering the limestone, and on the south there are several basaltic outbreaks. The view from Hermon is very extensive, embracing all Lebanon and the plains east of Damascus, with Palestine as far as Carmel and Tabor. On a clear day Jaffa also may be seen. The mountain in spring is covered with snow, but in autumn there is occasionally none left, even in the ravines. To the height of 500 ft. it is clothed with oaks, poplars and brush, while luxuriant vineyards abound. Foxes, wolves and Syrian bears are not infrequently met with, and there is a heavy dew or night mist. Above the snow-limit the mountain is bare and covered with fine limestone shingle. The summit is a plateau from which three rocky knolls rise up, that on the west being the lowest, that on the south-east the highest. On the south slope of the latter are remains of a small temple or *sacellum* described by St. Jerome. A semicircular dwarf wall of good masonry runs round this peak, and a trench excavated in the rock may perhaps indicate the site of an altar. On the plateau is a cave about 25 ft. sq. with the entrance on the east. A rock column supports the roof, and a building (possibly a Mithraeum) once stood above. Other small temples are found on the sides of Hermon, of which twelve in all have been explored. They face the east and are dated by architects about A.D. 200. The most remarkable are those of Deir el 'Ashaiyir, Hibbariyah, Hoen Niha and Tell Thatha. At the ruined town called Rukleh on the northern slopes are remains of a temple, the stones of which have been built into a church. A large medallion, 5 ft. in diameter, with a head supposed to represent the sun-god, is built into the wall. Several Greek inscriptions occur among these ruins. In the 12th century Psalm lxxxix. 12 was supposed to indicate the proximity of Hermon to Tabor. The conical hill immediately south of Tabor was thus named Little Hermon, and is still so called by some of the inhabitants of the district.

HERMSDORF, a village of Germany, in the Prussian province of Silesia. Pop. (1900) 10,975. There are coal and iron mines and lime quarries in the vicinity, and in the town there are large iron-works. Hermsdorf is known as Niederhermsdorf to distinguish it from other places of the same name. Perhaps the most noteworthy of these is a village in Silesia at the foot of the Riesengebirge, chiefly famous for the ruins of the castle of Kynast. This castle, formerly the seat of the Schaffgotsch family, was destroyed by lightning in 1675. A third Hermsdorf is a village in Saxe-Altenburg, where porcelain is made.

HERNE, JAMES A. [originally **ABERNE**] (1840-1901), American actor and playwright, was born in Troy, New York, and after theatrical experiences in various companies produced his own first play, *Hearts of Oak*, in 1878, and his great success *Shore Acres* in 1882. It was in rural drama that his humour and pathos found their proper setting, and *Shore Acres* was seen throughout the United States almost continuously for six seasons, being followed by the less successful *Sag Harbor*, 1900.

HERNE, a town of Germany, in the Prussian province of Westphalia, 15 m. by rail N.W. of Dortmund. Pop. (1905) 33,258. It has coal mines, boiler-works, gunpowder mills, &c. Herne was made a town in 1897.

HERNE BAY, a seaside resort in the St Augustine's parliamentary division of Kent, England, 8 m. N. by E. of Canterbury, on the South Eastern and Chatham railway. Pop. of urban district (1901) 6726. It has grown up since 1830, above a sandy and pebbly shore, and has a pier $\frac{1}{2}$ m. long. The church of St Martin in the village of Herne, $1\frac{1}{2}$ m. inland,

is Early English and later; the living was held by Nicholas Ridley (1538), afterwards Bishop of London. At Reculver, 3 m. E. of Herne Bay on the coast, is the site of the Roman station of *Regubium*. The fortress occupied about 8 acres, but only traces of the south and east walls remain. In Saxon times it was converted into a palace by King Ethelbert, and in 660 a monastery was founded here by Egbert. The Early English church was taken down early in the 19th century owing to the encroachment of the sea, and parts of its fabric were preserved in the modern church of St Mary. But its twin towers, known as the Sisters from the tradition that they were built by a Benedictine abbeas of Faversham in memory of her sister, were preserved by Trinity House as a conspicuous landmark.

HERNE THE HUNTER, a legendary huntsman who was alleged to haunt Windsor Great Park at night, especially around an aged tree, long known as Herne's oak, said to be nearly 700 years old. This was blown down in 1865, and a young oak was planted by Queen Victoria on the spot. Herne has his French counterpart in the *Grand Veneur* of Fontainebleau. Mention is made of Herne in *The Merry Wives of Windsor* and in Harrison Ainsworth's *Windsor Castle*. Nothing definite is known of the Herne legend. It is suggested that it originated in the life-story of some keeper of the forest; but more probably it is only a variant of the "Wild Huntsman" myth common to folk-lore, which (E. B. Tylor, *Primitive Culture*, 4th ed. pp. 361-362) is almost certainly the modern form of a prehistoric storm-myth.

HERNIA (Lat. *hernia*, perhaps from Gr. *ἔσπος*, a sprout), in surgery, the protrusion of a viscus, or part of a viscus, from its normal cavity; thus, *hernia cerebri* is a protrusion of brain-substance, *hernia pulmonum*, a protrusion of a portion of lung, and *hernia iridis*, a protrusion of some of the iris through an aperture in the cornea. But, used by itself, *hernia* implies a protrusion from the abdominal cavity, or, in common language, a "rupture." A rupture may occur at any weak point in the abdominal wall. The common situations are the groin (*inguinal hernia*), the upper part of the thigh (*femoral hernia*), and the navel (*umbilical hernia*). The more movable the viscus the greater the liability to protrusion, and therefore one commonly finds some of the small intestine, or of the fatty apron (omentum), in the hernia. The tumour may contain intestine alone (enterocele), omentum alone (epiplocele), or both intestine and omentum (entero-epiplocele). The predisposing cause of rupture is abnormal length of the suspensory membrane of the bowel (the mesentery), or of the omentum, in conjunction with some weak spot in the abdominal wall, as in an inguinal hernia, which descends along the canal in which the spermatic cord lies in the male and the round ligament of the womb in the female. A femoral hernia comes through a weak spot in the abdomen to the inner side of the great femoral vessels; a ventral hernia takes place by the yielding of the scar tissue left after an operation for appendicitis or ovarian disease. The exciting cause of hernia is generally some over-exertion, as in lifting a heavy weight, jumping off a high wall, straining (as in difficult micturition), constipation or excessive coughing. The pressure of the diaphragm above and the abdominal wall in front acting on the abdominal viscera causes a protrusion at the weakest point.

Rupture is either congenital or acquired. A child may be born with a hernia in the inguinal or umbilical region, the result of an arrest of development in these parts; or the rupture may be acquired, first appearing, perhaps, in adult life as the result of a strain or hurt. Men suffer more frequently than women, because of their physical labours, because they are more liable to accidents, and because of the passage for the spermatic cord out of the abdomen being more spacious than that for the round ligament of the womb.

At first the rupture is small, and it gradually increases in bulk. It varies from the size of a marble to a child's head. The swelling consists of three parts—the coverings, sac and contents. The "coverings" are the structures which form the abdominal wall at the part where the rupture occurs. In femoral hernia the coverings are the structures at the upper part of the thigh which are stretched, thinned and matted together as the result of

pressure; in other cases there is an increase in their thickness, the result of repeated attacks of inflammation. The "sac" is composed of the peritoneum or membrane lining the abdominal cavity; in some rare cases the sac is wanting. The neck of the sac is the narrowed portion where the peritoneum forming the sac becomes continuous with the general peritoneal cavity. The neck of the sac is often thickened, indurated and adherent to surrounding parts, the result of chronic inflammation. The "contents" are bowel, omental fat, or, in children, an ovary.

The hernia may be reducible, irreducible or strangulated. A "reducible" hernia is one in which the contents can be pushed back into the abdomen. In some cases this reduction is effected with ease, in others it is a matter of great difficulty. At any moment a reducible hernia may become "irreducible," that is to say, it cannot be pushed back into the abdominal cavity, perhaps because of inflammatory adhesions in and around the fatty contents, or because of extra fullness of the bowel in the sac. A "strangulated" hernia is one in which the circulation of the blood through the hernial contents is interfered with, by the pinching at the narrowest part of the passage. The interference is at first slight, but it quickly becomes more pronounced; the pinched bowel in the hernial sac swells as a finger does when a string is tightly wound round its base. At first there is congestion, and this may go on to inflammation, to infection by micro-organisms and to mortification. The rapidity with which the change from simple congestion to mortification takes place depends on the tightness of the constriction, and on the virulence of the bacterial infection from the bowel. As a rule, the more rapidly a hernia forms the greater the rapidity of serious change in the conditions of the bowel or omentum, and the more urgent are the symptoms. The constricting band may be one of the structures which form the boundaries of the openings through which the hernia has travelled, or it may be the neck of the sac, which has become thickened in consequence of inflammation—especially in this case in an inguinal hernia.

Reducible Hernia.—With a reducible hernia there is a soft compressible tumour (elastic when it contains intestine, doughy when it contains omentum), its size increasing in the erect, and diminishing in the horizontal posture. As a rule, it causes no trouble during the night. It gives an impulse on coughing, and when the intestinal contents are pushed back into the abdomen a gurgling sensation is perceptible by the fingers. Such a tumour may be met with in any part of the abdominal wall, but the chief situations are as follows. The inguinal region, in which the neck of the tumour lies immediately above Poupart's ligament (a cord-like ligamentous structure which can be felt stretching from the front of the hip-bone to a ridge of bone immediately above the genital organs); the femoral region, in the upper part of the thigh, in which the neck of the sac lies immediately below the inner end of Poupart's ligament; the umbilical region, in which the tumour appears at or near the navel. As the inguinal hernia increases in size it passes into the scrotum in the male, into the labium in the female; while the femoral hernia gradually pushes upwards to the abdomen.

The palliative treatment of a reducible hernia consists in pushing back the contents of the tumour into the abdomen and applying a truss or elastic bandage to prevent their again escaping. The younger the patient the more chance there is of the truss acting as a curative agent. The truss may generally be left off at night, but it should be put on in the morning before the patient leaves his bed. If, after the hernia has been once returned, it is not allowed again to come down, there is a probability of an actual cure taking place; but if it is allowed to come down occasionally, as it may do, even during the night, in consequence of a cough, or from the patient turning suddenly in bed, the weak spot is again opened out, and the improvement which might have been going on for weeks is undone. It is sometimes found impossible to keep up a hernia by means of a truss, and an operation becomes necessary. The operation is spoken of as "the radical treatment of hernia," in contradistinction to the so-called "palliative treatment" by means of a truss. It should not be spoken of as the radical cure, for

skillfully as the operation may have been performed it is not always a cure. The principles involved in the operation are the emptying of the sac and its entire removal, and the closure of the opening into the abdomen by strong sutures; and, in this way, great advance has been made by modern surgery. Without tiresome delay, and the tedious and sometimes disappointing application of trusses, the weak spot in the abdominal wall is exposed, the sac of the hernia is tied and removed, and the canal by which the rupture descended is blockaded by buried sutures, and with no material risk to life. Thus the patient's worries become a thing of the past, and he is rendered a fit and normal member of society. Experience has shown that very few ruptures are unsuited for successful treatment by operation. No boy should now be sent to school compelled to wear a truss, and so hindered in his games and rendered an object of remark.

Irreducible Hernia.—The main symptom is a tumour in one of the situations already referred to, of long standing and perhaps of large size, in which the contents of the tumour, in whole or in part, cannot be pushed back into the abdomen. The irreducibility is due either to its large size or to changes which have taken place by indurations or adhesions. Such a tumour is a constant source of danger: its contents are liable, from their exposed situation, to injury from external violence; it has a constant risk of increase; it may at any time become strangulated, or the contents may inflame, and strangulation may occur secondarily to the inflammation. It gives rise to dragging sensations (referred to the abdomen), colic, dyspepsia and constipation, which may lead to obstruction, that is to say, a stoppage may occur of the passage of the contents of that portion of the intestinal canal which lies in the hernia. When an irreducible hernia becomes painful and tender, a local peritonitis has occurred, which resembles in many of its symptoms a case of strangulation, and must be regarded with suspicion and anxiety. Indeed, the only safe treatment is by operation.

The treatment of irreducible hernia may be palliative; a "bag truss" may be worn in the hope of preventing the hernia getting larger; the bowels must be kept open, and all irregularities of diet avoided. A person with such a hernia is in constant danger, and if his general condition does not contra-indicate it he should be submitted to operative treatment. That is to say, the surgeon should cut down on the hernia, open the sac, divide any omental adhesions, tie and cut away indurated omentum, return the bowel, and complete the radical operation by closing the aperture by strong sutures.

In *Strangulated Hernia* the bowel or omentum is being nipped at the neck of the sac, and the flow of blood into and from the delicate tissues is stopped. The symptoms are—nausea, vomiting of bilious matter, and after a time of faecal-smelling matter; a twisting, burning pain generally referred to the region of the navel, intestinal obstruction; a quick, wiry pulse and pain on pressure over the tumour; the expression grows anxious, the abdomen becomes tense and drum-like, and there is no impulse in the tumour on coughing, because its contents are practically pinched off from the general abdominal cavity. Sometimes there is complete absence of pain and tenderness in the hernia itself, and in an aged person all the symptoms may be very slight. Sooner or later, from eight hours to eight days, if the strangulation is unrelieved, the tumour becomes livid, crackling with gas, mortification of the bowel at the neck of the sac takes place, followed by extravasation of the intestinal contents into the abdominal cavity; the patient has hiccough; he becomes collapsed; and dies comatose from blood-poisoning.

The treatment of a strangulated hernia admits of no delay; if the hernia does not "go back" on the surgeon trying to reduce it, it must be operated on at once, the constriction being relieved, the bowel returned and the opening closed. There should be no treatment by hot-bath or ice-bag; operation is urgently needed. An anaesthetic should be administered, and perhaps one gentle attempt to return the contents by pressure (termed " taxis") may be made, but no prolonged attempts are justifiable, because the condition of the hernial contents may be such that they cannot bear the pressure of the fingers. "Think

well of the hernia," says the aphorism, "which has been little handled."

The taxis to be successful should be made in a direction opposite to the one in which the hernia has come down. The inguinal hernia should be pressed upwards, outwards and backwards, the femoral hernia downwards, backwards and upwards. The larger the hernia the greater is the chance of success by taxis, and the smaller the hernia the greater the risk of its being injured by manipulation and delay. In every case the handling must be absolutely gentle. If taxis does not succeed the surgeon must at once cut down on the tumour, carefully dividing the different coverings until he reaches the sac. The sac is then opened, the constriction divided, care being taken not to injure the bowel. The bowel must be examined before it is returned into the abdomen, and if its lustreless appearance, its dusky colour, or its smell, suggests that it is mortified, or is on the point of mortifying, it must not be put back or perforation would give rise to septic peritonitis which would probably have a fatal ending. In such a case the damaged piece of bowel must be resected and the healthy ends of the bowel joined together by fine suturing. Matted or diseased omentum must be tied off and removed. Should peritonitis supervene after the operation on account of bacillary infection, the bowels should be quickly made to act by repeated doses of Epsom salts in hot water.

A person who is the subject of a reducible hernia should take great care to obtain an accurately fitting truss, and should remember that whenever symptoms resembling in any degree those of strangulation occur, delay in treatment may prove fatal. A surgeon should at once be communicated with, and he should come prepared to operate. (E. O.)*

HERNICI, an ancient people of Italy, whose territory was in Latium between the Fucine Lake and the Trerus, bounded by the Volscian on the S., and by the Aequian and the Marsian on the N. They long maintained their independence, and in 486 B.C. were still strong enough to conclude an equal treaty with the Latins (Dion. Hal. viii. 64 and 68). They broke away from Rome in 362 (Livy vii. 6 ff.) and in 306 (Livy ix. 42), when their chief town Anagnina (q.v.) was taken and reduced to a praefecture, but Ferentinum, Aletrium and Verulae were rewarded for their fidelity by being allowed to remain free *municipia*, a position which at that date they preferred to the *civitas*. The name of the Hernici, like that of the Volsci, is missing from the list of Italian peoples whom Polybius (ii. 24) describes as able to furnish troops in 225 B.C.; by that date, therefore, their territory cannot have been distinguished from Latium generally, and it seems probable (Beloch, *Ital. Bund.*, p. 123) that they had then received the full Roman citizenship. The oldest Latin inscriptions of the district (from Ferentinum, *C.I.L.* x. 5837-5840) are earlier than the Social War, and present no local characteristic.

For further details of their history see *C.I.L.* x. 572.

There is no evidence to show that the Hernici ever spoke a really different dialect from the Latins; but one or two glosses indicate that they had certain peculiarities of vocabulary, such as might be expected among folk who clung to their local customs. Their name, however, with its *Co*-termination, classes them along with the *Co*-tribes, like the Volsci, who would seem to have been earlier inhabitants of the west coast of Italy, rather than with the tribes whose names were formed with the *No*-suffix. On this question see **VOLSCI** and **SABINI**.

See Conway's *Italic Dialects* (Camb. Univ. Press, 1897), p. 306 ff., where the glosses and the local and personal names of the district will be found. (R. S. C.)

HERNÖSAND, a seaport of Sweden, chief town of the district (*län*) of Västernorrland on the Gulf of Bothnia. Pop. (1900) 7890. It stands on the island of Hernö (which is connected with the mainland by bridges) near the mouth of the Ängerman river, 423 m. N. of Stockholm by rail. It is the seat of a bishop and possesses a fine cathedral. There are engine-works, timber-yards and saw-mills. The harbour is good, but generally ice-bound from December to May. Timber, iron and wood-pulp are exported. There are a school of navigation and an institute for pisciculture. Hernösand was founded in 1584, and received its

first town-privileges from John III. in 1587. It was the first town in Europe to be lighted by electricity (1885). The poet Fransen (q.v.), Bishop of Hernösand, is buried here.

HERO (Gr. *ἦρως*), a term specially applied to warriors of extraordinary strength and courage, and generally to all who were distinguished from their fellows by superior moral, physical or intellectual qualities. No satisfactory derivation of the word has been suggested.

Ancient Greek Heroes.

In ancient Greece, the heroes were the object of a special cult, and as such were intimately connected with its religious life. Various theories have been put forward as to the nature of these heroes. According to some authorities, they were idealized historical personages; according to others, symbolical representations of the forces of nature. The view most commonly held is that they were degraded or "depotentiated" gods, occupying a position intermediate between gods and men. According to E. Rohde (in *Psyche*) they are souls of the dead, which after separation from the body enter upon a higher, eternal existence. But it is only a select minority who attain to the rank of heroes after death, only the distinguished men of the past. The worship of these heroes is in reality an ancestor worship, which existed in pre-Homeric times, and was preserved in local cults. Instances no doubt occur of gods being degraded to the ranks of heroes, but these are not the real heroes, the heroes who are the object of a cult. The cult-heroes were all persons who had lived the life of man on earth, and it was necessary for the degraded gods to pass through this stage. They did not at once become cult-heroes, but only after they had undergone death like other mortals. Only one who has been a man can become a hero. The heroes are spirits of the dead, not demi-gods; their position is not intermediate between gods and men, but by the side of these they exist as a separate class.

In Homer the term is applied especially to warrior princes, to kings and kings' sons, even to distinguished persons of lower rank, and free men generally. In Hesiod it is chiefly confined to those who fought before Troy and Thebes; in view of their supposed divine origin, he calls them demi-gods (*ἡμιθεοί*). This name is also given them in an interpolated passage in the *Iliad* (xii. 23), which is quite at variance with the general Homeric idea of the heroes, who are no more than men, even if of divine origin and of superior strength and prowess. But neither in Homer nor in Hesiod is there any trace of the idea that the heroes after death had any power for good or evil over the lives of those who survived them; and consequently, no cult. Nevertheless, traces of an earlier ancestor worship appear, e.g. in funeral games in honour of Patroclus and other heroes, while the Hesiodic account of the five ages of man is a reminiscence of the belief in the continued existence of souls in a higher life. This pre-historic worship and belief, for a time obscured, were subsequently revived. According to Porphyry (*De abstinentia*, iv. 22), Draco ordered the inhabitants of Attica to honour the gods and heroes of their country "in accordance with the usage of their fathers" with offerings of first fruits and sacrificial cakes every year, thereby clearly pointing to a custom of high antiquity. Solon also ordered that the tombs of the heroes should be treated with the greatest respect, and Cleisthenes (q.v.) sought to create a pan-Athenian enthusiasm by calling his new tribes after Attic heroes and setting up their statues in the Agora. Heroic honours were at first bestowed upon the founders of a colony or city, and the ancestors of families; if their name was not known, one was adopted from legend. In many cases these heroes were purely fictitious; such were the supposed ancestors of the noble and priestly families of Attica and elsewhere (Butadae at Athens, Branchidae at Miletus, Ceryces at Eleusis), of the eponymi of the tribes and demes. Again, side by side with gods of superior rank, certain heroes were worshipped as protecting spirits of the country or state; such were the Aeacidae amongst the Aeginetans, Ajax son of Oileus amongst the Epizephyrian Locrians and Hector at Thebes. Neglect of the worship of these heroes was held to be

responsible for pestilence, bad crops and other misfortunes, while, on the other hand, if duly honoured, their influence was equally beneficent. This belief was supported by the Delphic oracle, which was largely instrumental in promoting hero-worship and keeping alive its due observance. Special importance was attached to the grave of the hero and to his bodily remains, with which the spirit of the departed was inseparably connected. The grave was regarded as his place of abode, from which he could only be absent for a brief period; hence his bones were fetched from abroad (e.g. Cimon brought those of Theseus from Scyros), or if they could not be procured, at least a cenotaph was erected in his honour. Their relics also were carefully preserved: the house of Cadmus at Thebes, the hut of Orestes at Tegea, the stone on which Telamon had sat at Salamis (in Cyprus). Special shrines (ἡρώα) were also erected in their honour, usually over their graves. In these shrines a complete set of armour was kept, in accordance with the idea that the hero was essentially a warrior, who on occasion came forth from his grave and fought at the head of his countrymen, putting the enemy to flight as during his lifetime. Like the gods, the cult heroes were supposed to exercise an influence on human affairs, though not to the same extent, their sphere of action being confined to their own localities. Amongst the earliest known historical examples of the elevation of the dead to the rank of heroes are Timesius the founder of Abdera, Miltiades, son of Cypselus, Harmodius and Aristogiton and Brasidas, the victor of Amphipolis, who ousted the local Athenian hero Hagnon. In course of time admission to the rank of a hero became far more common, and was even accorded to the living, such as Lysimachus in Samothrace and the tyrant Nicias of Cos. Antiochus of Commagene instituted an order of priests to celebrate the anniversary of his birth and coronation in a special sanctuary, and the kings of Pergamum claimed divine honours for themselves and their wives during their lifetime. The birthday of Eumenes was regularly kept, and every month sacrifice was offered to him and games held in his honour. In addition to persons of high rank, poets, legendary and others (Linus, Orpheus, Homer, Aeschylus and Sophocles), legislators and physicians (Lycurgus, Hippocrates), the patrons of various trades or handicrafts (artists, cooks, bakers, potters), the heads of philosophical schools (Plato, Democritus, Epicurus) received the honours of a cult. At Teos incense was offered before the statue of a flute-player during his lifetime. In some countries the honour became so general that every man after death was described as a hero in his epitaph—in Thessaly even slaves.

The cult of the heroes exhibits points of resemblance with that of the chthonian divinities and of the dead, but differs from that of the ordinary gods, a further indication that they were not "depotentiated" gods. Thus, sacrifice was offered to them at night or in the evening; not on a high, but on a low altar (ἄρχάρα), surrounded by a trench to receive the blood of the victim, which was supposed to make its way through the ground to the occupant of the grave; the victims were black male animals, whose heads were turned downwards, not upwards; their blood was allowed to trickle on the ground to appease the departed (ἀψαμύπια); the body was entirely consumed by fire and no mortal was allowed to eat of it; the technical expression for the sacrifice was not θύειν but ἐργίλειν (less commonly ἐργέμεν). The chthonian aspect of the hero is further shown by his attribute the snake, and in many cases he appears under that form himself. On special occasions a sacrificial meal of cooked food was set out for the heroes, of which they were solemnly invited to partake. The fullest description of such a festival is the account given by Plutarch (*Aristides*, 21) of the festival celebrated by the Plataeans in honour of their countrymen who had fallen at the battle of Plataea. On the 16th of the month Maimacterion, a long procession, headed by a trumpeter playing a warlike air, set out for the graves; wagons decked with myrtle and garlands of flowers followed, young men (who must be of free birth) carried jars of wine, milk, oil and perfumes; next came the black bull destined for the sacrifice, the rear being brought up by the archon, who wore the purple robe of the general, a naked sword in one hand, in the other an urn. When he came near the tombs, he drew

some water with which he washed the gravestones, afterwards anointing them with perfume; he then sacrificed the bull on the altar calling upon Zeus Chthonios and Hermes Psychopompos, and inviting them in company with the heroes to the festival of blood. Finally, he poured a libation of wine with the words: "I drink to those who died for the freedom of the Hellenes."

See especially E. Rohde, *Psyche* (1905) and in *Rheinisches Museum*, li. (1895), 28; P. Stengel, *Die griechischen Kultusaltertümer* (Munich, 1898), p. 124; G. F. Schömann, *Griechische Altertümer*, ii. (1897), 159; J. Wassner, *De heroum apud Graecos cultu* (Kiel, 1883); article by F. Deneken in Roscher's *Lexikon der Mythologie*, in which a large amount of material is accumulated; J. A. Hild, *Étude sur les démons* (1881) and article in Daremberg and Saglio's *Dictionnaire des antiquités*.

Teutonic Legend.

Many of the chief characteristics of the ancient Greek heroes are reproduced in those of the Teutonic North, the parallel being in some cases very striking; Siegfried, for instance, like Achilles, is vulnerable only in one spot, and Wayland Smith, like Hephaestus, is lame. Superhuman qualities and powers, too, are commonly ascribed to both, an important difference, however, being that whatever worship may have been paid to the Teutonic heroes never crystallized into a cult. This applies equally to those who have a recognized historical origin and to those who are regarded as purely mythical. Of the latter the number has tended to diminish in the light of modern scholarship. The fashion during the 19th century set strongly in the other direction, and the "degraded gods" theory was applied not only to such conspicuous heroes as Siegfried, Dietrich and Beowulf, but to a host of minor characters, such as the good marquis Rüdiger of the Nibelungenlied and our own Robin Hood (both identified with Woden Hraodperakt). The reaction from one extreme has, indeed, tended to lead to another, until not only the heroes, but the very gods themselves, are being traced to very human, not to say commonplace, origins. Thus M. Henri de Tourville, in his *Histoire de la formation particulariste* (1903), basing his argument on the *Ynglinga Saga*, interpreted in the light of "Social Science," reveals Odin, "the traveller," as a great "caravan-leader" and warrior, who, driven from Asgörd—a trading city on the borders of the steppes east of the Don—by "the blows that Pompey aimed at Mithridates," brought to the north the arts and industries of the East. The argument is developed with convincing ingenuity, but it may be doubted whether it has permanently "rescued Odin from the misty dreamland of mythology and restored him to history." It is now, however, admitted that, whatever influence the one may have from time to time exercised on the other, Teutonic myth and Teutonic hero legend were developed on independent lines. The Teutonic heroes are, in the main, historical personages, never gods; though, like the Greek heroes, they are sometimes endowed with semi-divine attributes or interpreted as symbolical representations of natural forces.

The origin of Teutonic heroic saga, which may be regarded as including that of the Germans, Goths, Anglo-Saxons and Scandinavians, is to be looked for in the period of the so-called migration of nations (A.D. 350-650). It consequently rests upon a distinct basis of fact, the saga (in the older and wider sense of any story said or sung) being indeed the oldest form of historical tradition; though this of course does not exclude the probability of the accretion of mythical elements round persons and episodes from the very first. As to the origin of the heroic sagas as we now have them, Tacitus tells us that the deeds of Arminius were still celebrated in song a hundred years after his death (*Annals*, ii. 88) and in the *Germania* he speaks of "old songs" as the only kind of "annals" which the ancient Germans possessed; but, whatever relics of the old songs may be embedded in the Teutonic sagas, they have left no recognizable mark on the heroic poetry of the German peoples. The attempt to identify Arminius with Siegfried is now generally abandoned. Teutonic heroic saga, properly so-called, consists of the traditions connected with the migration period, the earliest traces of which are found in the works of historical writers such as Ammianus Marcellinus and Cassiodorus. According to Jordanes (the epitomator of

Caesiodorus's *History of the Goths* at the funeral of Attila his vassals, as they rode round the corpse, sang of his glorious deeds. The next step in the development of epic narrative was the single lay of an episodic character, sung by a single individual, who was frequently a member of a distinguished family, not merely a professional minstrel. Then, as different stories grew up round the person of a particular hero, they formed a connected cycle of legend, the centre of which was the person of the hero (e.g. Dietrich of Bern). The most important figures of these cycles are the following.

(1) Beowulf, king of the Geatas (Jutland), whose story in its present form was probably brought from the continent by the Angles. It is an amalgamation of the myth of Beowa, the slayer of the water-demon and the dragon, with the historical legend of Beowulf, nephew and successor of Hygelac (Chochilacius), king of the Geatas, who was defeated and slain (c. 520) while ravaging the Frisian coast. The water-demon Grendel and the dragon (probably), by whom Beowulf is mortally wounded, have been supposed to represent the powers of autumn and darkness, the floods which at certain seasons overflow the low-lying countries on the coast of the North Sea and sweep away all human habitations; Beowulf is the hero of spring and light who, after overcoming the spirit of the raging waters, finally succumbs to the dragon of approaching winter. Others regard him as a wind-hero, who disperses the pestilential vapours of the fens. Beowulf is also a culture-hero. His father Scaef-Scyld (i.e. Scyld Scefing, "the protector with the sheaf") lands on the Anglian or Scandinavian coast when a child, in a rudderless ship, asleep on a sheaf of grain, symbolical of the means whereby his kingdom shall become great; the son indicates the blessings of a fixed habitation, secured against the attacks of the sea. (2) Hildebrand, the hero of the oldest German epic. A loyal supporter of Theodoric, he follows his master, when threatened by Odoacer, to the court of Attila. After thirty years' absence, he returns to his home in Italy; his son Hadubrand, believing his father to be dead, suspects treachery and refuses to accept presents offered by the father in token of good-will. A fight takes place, in which the son is slain by the father. In a later version, recognition and reconciliation take place. Well-known parallels are Odysseus and Telegonis, Rustem and Sohrab. (3) Ermanaric, the king of the East Goths, who according to Ammianus Marcellinus slew himself (c. 375) in terror at the invasion of the Huns. With him is connected the old German Dioscuri myth of the Hartungen. (4) Dietrich of Bern (Verona), the legendary name of Theodoric the Great. Contrary to historical tradition, Italy is supposed to have been his ancestral inheritance, of which he has been deprived by Odoacer, or by Ermanaric, who in his altered character of a typical tyrant appears as his uncle and contemporary. He takes refuge in Hungary with Etzel (Attila), by whose aid he finally recovers his kingdom. In the later middle ages he is represented as fighting with giants, dragons and dwarfs, and finally disappears on a black horse. Some attempts have been made to identify him as a kind of Donar or god of thunder. (5) Siegfried (M.H. Ger. Sivrit), the hero of the *Nibelungenlied*, the Sigurd of the related northern sagas, is usually regarded as a purely mythical figure, a hero of light who is ultimately overcome by the powers of darkness, the mist-people (Nibelungen). He is, however, closely associated with historical characters and events, e.g. with the Burgundian king Gundahari (Gunter, Gunnar) and the overthrow of his house and nation by the Huns; the scholars have exercised considerable ingenuity in attempting to identify him with various historical figures. Theodor Abeling (*Das Nibelungenlied*, Leipzig, 1907) traces the Nibelung sagas to three groups of Burgundian legends, each based on fact: the Frankish-Burgundian tradition of the murder of Seigeric, son of the Burgundian king Sigimund, who was slain by his father at the instigation of his stepmother; the Frankish-Burgundian story, as told by Gregory of Tours (iii. 11), of the defeat of the Burgundian kings Sigimund and Godomar, and the captivity and murder of Sigimund, by the sons of Clovis, at the instigation of their mother Chrothildis, in revenge for the murder of her

father Chilperich and of her mother, by Godomar; the Rhenish-Burgundian story of the ruin of Gundahari's kingdom by Attila's Huns. Herr Abeling identifies Siegfried (Sigurd) with Seigeric, while—according to him—the heroine of the Nibelung sagas, Kriemhild (Gudrun), represents a confusion of two historical persons: Chrothildis, the wife of Clovis, and Ildico (Hilde), the wife of Attila. (See also the articles KRIEMHILD, NIBELUNGENLIED).

(6) Hugdietrich, Wolddietrich and Ortnit, whose legend, like that of Siegfried, is of Frankish origin. It is preserved in four versions, the best of which is the oldest, and has an historical foundation. Hugdietrich is the "Frankish Dietrich" (=Hugo Theodoric), king of Austrasia (d. 534), who like his son and successor Theodebert, was illegitimate; both had to fight for their inheritance with relatives. The transference of the scene to Constantinople is a reminiscence of the events of the Crusades and Theodebert's projected campaign against that city. The version in which Hugdietrich gains access to his future wife by disguising himself as a woman has also a foundation in fact. As the myth of the Hartungen is connected with Ermanaric, so another Dioscuri myth (of the Hartungen) is combined with the Ortnit-Wolddietrich legend. The Hartungen are probably identical with the divine youths (mentioned in Tacitus as worshipped by the Vandal Naharvali or Naharvali), from whom the Vandal royal family, the Asdingi, claimed descent. Asdingi (Ἀσδινγοί) would be represented in Gothic by Hæddiggo, "men with women's hair" (cf. *muliebrī ornatus* in Tacitus), and in middle high German by Hartungen. (7) Rother, king of Lombardy. Desiring to wed the daughter of Constantine, king of Constantinople, he sends twelve envoys to ask her in marriage. They are arrested and thrown into prison by the king. Rother, who appears under the name of Dietrich, sets out with an army, liberates the envoys and carries off the princess. One version places the scene in the land of the Huns. The character of Constantine in many respects resembles that of Alexius Comnenus; the slaying of a tame lion by one of the gigantic followers of Rother is founded on an incident which actually took place at the court of Alexius during the crusade of 1101 under duke Welf of Bavaria, when King Rother was composed about 1160 by a Rhenish minstrel. Rother may be the Lombard king Rothari (636-650), transferred to the period of the Crusades. (8) Walther of Aquitaine, chiefly known from the Latin poem *Waltheris*, written by Ekkehard of St Gall at the beginning of the 10th century, and fragments of an 8th-century Anglo-Saxon Epic *Waldere*. Walther is not an historical figure, although the legend undoubtedly represents typical occurrences of the migration period, such as the detention and flight of hostages of noble family from the court of the Huns, and the rescue of captive maidens by abduction. (9) Wieland (Volundr), Wayland the Smith, the only Teutonic hero (his original home was lower Saxony) who firmly established himself in England. There is absolutely no historical background for his legend. He is a fire-spirit, who is pressed into man's service, and typifies the advance from the stone age to a higher stage of civilization (working in metals). As the lame smith he reminds us of Hephaestus, and in his flight with wings of Daedalus escaping from Minos. (10) Höggi (Hagen) and Hedin (Hetel), whose personalities are overshadowed by the heroines Hilde and Gudrun (Kudrun, Kutrün). In one version occurs the incident of the never-ending battle between the forces of Hagen and Hedin. Every night Hilde revives the fallen, and "so will it continue till the twilight of the gods." The battle represents the eternal conflict between light and darkness, the alternation of day and night. Hilde here figures as a typical Valkyr delighting in battle and bloodshed, who frustrates a reconciliation. Hedin had sent a necklace as a peace-offering to Hagen, but Hilde persuades her father that it is only a ruse. This necklace occurs in the story of the goddess Freya (Frigg), who is said to have caused the battle to conciliate the wrath of Odin at her infidelity, the price paid by her for the possession of the necklace Brisingamen; again, the light god Heimdal is said to have fought with Loki for the necklace (the sun) stolen by the latter. Hence the battle has been explained as the necklace

myth in epic form. The historical background is the raids of the Teutonic maritime tribes on the coasts of England and Ireland.

Famous heroes who are specially connected with England are Alfred the Great, Richard Cœur-de-Lion, King Horn, Havelok the Dane, Guy of Warwick, Sir Bevis of Hampton (or Southampton), Robin Hood and his companions.

Celtic Heroes.

The Celtic heroic saga in the British islands may be divided into the two principal groups of Gaelic (Irish) and Brython (Welsh), the first, excluding the purely mythological, into the Ultonian (connected with Ulster) and the Ossianic. The Ultonians grouped round the names of King Conchobair and the hero Cuchulainn, "the Irish Achilles," the defender of Ulster against all Ireland, regarded by some as a solar hero. The second cycle contains the epics of Finn (Fionn, Fingal) mac Cumhail, and his son Oisín (Ossian), the bard and warrior, chiefly known from the supposed Ossianic poems of Macpherson. (See *CLT*, sec. *Celtic Literature*.)

Of Brython origin is the cycle of King Arthur (Artus), the adopted national hero of the mixed nationalities of whom the "English" people was composed. Here he appears as a chiefly mythical personality, who slays monsters, such as the giant of St Michel, the boar Trist, the demon cat, and goes down to the underworld. The original Welsh legend was spread by British refugees in Brittany, and was thus celebrated by both English and French Celts. From a literary point of view, however, it is chiefly French and forms "the matter of Brittany." Arthur, the leader (*comes Britanniæ, dux bellorum*) of the Siluri or Dumnonii against the Saxons, flourished at the beginning of the 6th century. He is first spoken of in Nennius's *History of the Britons* (9th century), and at greater length in Geoffrey of Monmouth's *History of the Kings of Britain* (12th century), at the end of which the French Breton cycle attained its fullest development in the poems of Chrétien de Troyes and others.

Speaking generally, the Celtic heroes are differentiated from the Teutonic by the extreme exaggeration of their superhuman, or rather extra-human, qualities. Teutonic legend does not lightly exaggerate, and what to us seems incredible in it may be easily conceived as credible to those by whom and for whom the tales were told; that Sigmund and his son Sinfiotli turned themselves into wolves would be but a sign of exceptional powers to those who believed in werewolves; Fafnir assuming the form of a serpent would be no more incredible to the barbarous Teuton than the similar transformation of Proteus to the Greek. But in the characterization of their heroes the Celtic imagination runs riot, and the quality of their persons and their acts becomes exaggerated beyond the bounds of any conceivable probability. Take, for instance, the description of some of Arthur's knights in the Welsh tale of *Kilkuich and Otwen* (in the *Mabinogion*). Along with Kai and Bedwyr (Bedivere), Peredur (Perceval), Gwalchmai (Gawain), and many others, we have such figures as Sgilti Yscandroed, whose way through the wood lay along the tops of the trees, and whose tread was so light that no blade of grass bent beneath his weight; Sol, who could stand all day upon one leg; Sugyn the son of Sugneddydd, who was "broad-chested" to such a degree that he could suck up the sea on which were three hundred ships and leave nothing but dry land; Gweyyl, the son of Gwestad, who when he was sad would let one of his lips drop beneath his waist and turn up the other like a cap over his head; and Uchtry Varyf Draws, who spread his red untrimmed beard over the eight-and-forty rafters of Arthur's hall. Such figures as these make no human impression, and criticism has busied itself in tracing them to one or other of the shadowy divinities of the Celtic pantheon. However this may be, remnants of their primitive superhuman qualities cling to the Celtic heroes long after they have been transfigured, under the influence of Christianity and chivalry, into the heroes of the medieval Arthurian romance, types—for the most part—of the knightly virtues as these were conceived by the middle ages; while shadowy memories of early myths live on, strangely disguised, in certain of the episodes repeated uncritically by the medieval poets. So Merlin preserves his diabolic origin; Arthur his mystic coming and

his mystic passing; while Gawain, and after him Lancelot, journey across the river, as the Irish hero Bran had done before them to the island of fair women—the Celtic vision of the realm of death.

The chief heroes of the medieval Arthurian romances are the following. Arthur himself, who tends however to become completely overshadowed by his knights, who make his court the starting-point of their adventures. Merlin (Myrddin), the famous wizard, bard and warrior, perhaps an historical figure, first introduced by Geoffrey of Monmouth, originally called Ambroise from the British leader Ambrosius Aurelianus, under whom he is said to have first served. Perceval (Parzival, Parsifal), the Welsh Peredur, "the seeker of the basin," the most intimately connected with the quest of the Grail (q.v.). Tristan (Tristram), the ideal lover of the middle ages, whose name is inseparably associated with that of Iseult. Lancelot, son of Ban king of Brittany, a creation of chivalrous romance, who only appears in Arthurian literature under French influence, known chiefly from his amour with Guinevere, perhaps in imitation of the story of Tristan and Iseult. Gawain (Welwain, Welsh Gwalchmai), Arthur's nephew, who in medieval romance remains the type of knightly courage and chivalry, until his character is degraded in order to exalt that of Lancelot. Among less important, but still conspicuous, figures may be mentioned Kay (the Kai of the *Mabinogion*), Arthur's foster-brother and senechal, the type of the bluff and boastful warrior, and Bedivere (Bedwyr), the type of brave knight and faithful retainer, who alone is with Arthur at his passing, and afterwards becomes "a hermit and a holy man." (See ARTHUR, MERLIN, PERCEVAL, TRISTAN, LANCELOT, GAWAIN.)

Heroes of Romance.

Another series of heroes, forming the central figures of stories variously derived but developed in Europe by the Latin-speaking peoples, may be conveniently grouped under the heading of "romance." Of these the most important are Alexander of Macedon and Charlemagne, while alongside of them Priam and other heroes of the Trojan war appear during the middle ages in strangely altered guise. Of all heroes of romance Alexander has been the most widely celebrated. His name, in the form of Iskander, is familiar in legend and story all over the East to this day; to the West he was introduced through a Latin translation of the original Greek romance (by the pseudo-Callisthenes) to which the innumerable Oriental versions are likewise traceable (see ALEXANDER III., KING OF MACEDON; see *The Romance of Alexander*). More important in the West, however, was the cycle of legends gathering round the figure of Charlemagne, forming what was known as "the matter of France." The romances of this cycle, of Germanic (Frankish) origin and developed probably in the north of France by the French (probably in the north of France) contain reminiscences of the heroes of the Merovingian period, and in their later development were influenced by the Arthurian cycle. Just as Arthur was eclipsed by his companions, so Charlemagne's vassal nobles, except in the *Chanson de Roland*, are exalted at the expense of the emperor, probably the result of the changed relations between the later emperors and their barons. The character of Charlemagne himself undergoes a change; in the *Chanson de Roland* he is a venerable figure, mild and dignified, while later he appears as a cruel and typical tyrant (as is also the case with Ermanaric). The basis of his legend is mainly historical, although the story of his journey to Constantinople and the East is mythical, and incidents have been transferred from the reign of Charles Martel to his. Charlemagne is chiefly venerated as the champion of Christianity against the heathen and the Saracens. (See CHARLEMAGNE, *ad fin.* "The Charlemagne Legends.")

The most famous heroes who are associated with him are Roland, prefect of the marches of Brittany, the Orlando of Ariosto, slain at Roncevaux (Roncevalles) in the Pyrenees, and his friend and rival Oliver (Olivier); Ogier the Dane, the Holger Danske of Hans Andersen, and Huon of Bordeaux, probably both introduced from the Arthurian cycle; Renaud (Rinaldo) of Montauban, one of the four sons of Aymon, to

whom the wonderful horse Bayard was presented by Charlemagne; the traitor Doon of Mayence; Ganelon, responsible for the treachery that led to the death of Roland; Archbishop Turpin, a typical specimen of muscular Christianity; William Fierabras, William a court nez, William of Toulouse, and William of Orange (all probably identical), and Vivien; the nephew of the latter and the hero of Aliscans. The late Charlemagne romances originated the legends, in English form, of *Sowdone of Babyloene*, *Sir Otnel*, *Sir Firumbras* and *Huor of Bordeaux* (in which Oberon, the king of the fairies, the son of Julius Caesar and Morgan the Fay, was first made known to England).

The chief remains of the Spanish heroic epic are some poems on the Cid, on the seven Infantes of Lara, and on Fernán Gonzalez, count of Castile. The legend of Charlemagne as told in the *Crónica general* of Alfonso X. created the desire for a national hero distinguished for his exploits against the Moors, and Roland was thus supplanted by Bernardo del Carpio. Another famous hero and centre of a 14th-century cycle of romance was Amadis of Gaul; its earliest form is Spanish, although the Portuguese have claimed it as a translation from their own language. There is no trace of a French original.

Slavonic Heroes.—The Slavonic heroic saga of Russia centres round Vladimir of Kiev (980-1015), the first Christian ruler of that country, whose personality is eclipsed by that of Ilya (Elias) of Mourmou, the son of a peasant, who was said to have saved the empire from the Tatars at the urgent request of his emperor. It is not known whether he was an historical personage; many of the achievements attributed to him border on the miraculous. A much-discussed work is the *Tale of Igor*, the oldest of the Russian medieval epics. Igor was the leader of a raid against the heathen Polovtsi in 1185; at first successful, he was afterwards defeated and taken prisoner, but finally managed to escape. Although the Finns are not Slavs, on topographical grounds mention may here be made of Wainamoinen, the great magician and hero of the Finnish epic *Kalevala* ("land of heroes"). The popular hero of the Servians and Bulgarians is Marko Kraljevič (*q.v.*), son of Vukashin, characterized by Goethe as a counterpart of the Greek Heracles and the Persian Rustem. For the Persian, Indian, &c., heroes see the articles on the literature and religions of the various countries.

AUTHORITIES.—On the subject generally, see J. G. T. Grässe, *Die grossen Sagenkreise des Mittelalters* (Dresden, 1842), forming part of his *Lehrbuch einer Literaturgeschichte der berühmtesten Völker des Mittelalters*; W. P. Ker, *Epic and Romance* (2nd ed., 1908). **TEUTONIC.**—B. Symonds, "Germanische Heldensage" in H. Paul's *Grundriss der germanischen Philologie*, iii. (Strassburg, 1900), 2nd revised edition, separately printed (*ib.*, 1905); W. Grimm, *Die deutsche Heldensage* (1829, 3rd ed., 1889), still one of the most important works; W. Müller, *Mythologie der deutschen Heldensage* (Heilbronn, 1886) and supplement, *Zur Mythologie der griechischen und deutschen Heldensage* (*ib.*, 1889); O. L. Jiriczek, *Deutsche Heldensagen*, i. (Strassburg, 1898) and *Die deutsche Heldensage* (3rd revised edition, Leipzig, 1906); Chantepie de la Saussaye, *The Religion of the Teutons* (Eng. tr., Boston, U.S.A., 1902); J. C. Robertson, *History of German Literature* (1902). See also **HELDENBUCH**.

CELTIC.—M. H. d'Arbois de Jubainville, *Cours de littérature celtique* (12 vols., 1883-1902), one vol. trans. into English by R. I. Best, *The Irish Mythological Cycle and Celtic Mythology* (1903); L. Petit de Julleville, *Hist. de la langue et de la litt. française*, i. *Moyen âge* (1896); C. Squire, *The Mythology of the British Isles: an Introduction to Celtic Myth and Romance* (1905); J. Rhys, *Celtic Britain* (3rd ed., 1904). **SLAVONIC.**—A. N. Rambaud, *La Russie épique* (1876); W. Wöllner, *Untersuchungen über die Volksepik der Grossrussen* (1879); W. R. Morfill, *Slavonic Literature* (1883).

HERO AND LEANDER, two lovers celebrated in antiquity. Hero, the beautiful priestess of Aphrodite at Sestos, was seen by Leander, a youth of Abydos, at the celebration of the festival of Aphrodite and Adonis. He became deeply enamoured of her; but, as her position as priestess and the opposition of her parents rendered their marriage impossible they agreed to carry on a clandestine intercourse. Every night Hero placed a lamp in the top of the tower where she dwelt by the sea, and Leander, guided by it, swam across the dangerous Hellespont. One stormy night the lamp was blown out and Leander perished. On finding his body next morning on the shore, Hero flung

herself into the waves. The story is referred to by Virgil (*Georg.* iii. 258); Statius (*Theb.* vi. 535) and Ovid (*Her.* xviii. and xix.). The beautiful little epic of Musaeus has been frequently translated, and is expanded in the *Hero and Leander* of C. Marlowe and G. Chapman. It is also the subject of a ballad by Schiller and a drama by F. Grillparzer.

See M. H. Jellinek, *Die Sage von Hero und Leander in der Dichtung* (1890), and G. Knaack "Hero und Leander" in *Festsche für Franz Susemihl* (1898). A careful collection of materials will be found in F. Köppler, *Die Sage von Hero und Leander in der Literatur und Kunst des Altertums* (1894).

HERO OF ALEXANDRIA, Greek geometer and writer on mechanical and physical subjects, probably flourished in the second half of the 1st century. This is the more modern view, in contrast to the earlier theory most generally accepted, according to which he flourished about 100 B.C. The earlier theory started from the superscription of one of his works, "Ἡρώων Κτησιβίου Μηχανοικῆ", from which it was inferred that Hero was a pupil of Ctesibius. Martin, Hultsch and Cantor took this Ctesibius to be a barber of that name who lived in the reign of Ptolemy Euergetes II. (d. 117 B.C.) and is credited with having invented an improved water-organ. But this identification is far from certain, as a Ctesibius *mechanicus* is mentioned by Athenaeus as having lived under Ptolemy II. Philadelphus (285-247 B.C.). Nor can the relation of master and pupil be certainly inferred from the superscription quoted (observe the omission of any article), which really asserts no more than that Hero re-edited an earlier treatise by Ctesibius, and implies nothing about his being an *immediate* predecessor. Further, it is certain that Hero used physical and mathematical writings by Posidonius, the Stoic, of Apamea, Cicero's teacher, who lived until about the middle of the 1st century B.C. The positive arguments for the more modern view of Hero's date are (1) the use by him of Latinisms from which Diels concluded that the 1st century A.D. was the earliest possible date, (2) the description in Hero's *Mechanics* iii. of a small olive-press with one screw which is alluded to by Pliny (*Nat. Hist.* viii.) as having been introduced since A.D. 55, (3) an allusion by Plutarch (who died A.D. 120) to the proposition that light is reflected from a surface at an angle equal to the angle of incidence, which Hero proved in his *Catoptrica*, the words used by Plutarch fitting well with the corresponding passage of that work (as to which see below). Thus we arrive at the latter half of the 1st century A.D. as the approximate date of Hero's activity.

The geometrical treatises which have survived (though not interpolated) in Greek are entitled respectively *Definitiones*, *Geometria*, *Geodesia*, *Stereometria* (i. and ii.), *Mensurae*, *Libri Geoponicus*, to which must now be added the *Metrica* recently discovered by R. Schöne in a MS. at Constantinople. These books, except the *Definitiones*, mostly consist of directions for obtaining, from given parts, the areas or volumes, and other parts, of plane or solid figures. A remarkable feature is the bare statement of a number of very close approximations to the square roots of numbers which are not complete squares. Others occur in the *Metrica* where also a method of finding such approximate square, and even approximate cube, roots is shown. Hero's expressions for the areas of regular polygons of from 5 to 12 sides in terms of the squares of the sides show interesting approximations to the values of trigonometrical ratios. Akin to the geometrical works is that *On the Dioptra*, a remarkable book on land-surveying, so called from the instrument described in it, which was used for the same purposes as the modern theodolite. It is in this book that Hero proves the expression for the area of a triangle in terms of its sides. The *Pneumatica* in two books is also extant in Greek as is also the *Automatopoeitica*. In the former will be found such things as siphons, "Hero's fountain," "penny-in-the-slot" machines, a fire-engine, a water-organ, and arrangements employing the force of steam. Pappus quotes from three books of *Mechanics* and from a work called *Barulcus*, both by Hero. The three books on *Mechanics* survive in an Arabic translation which, however, bears a title "On the lifting of heavy objects." This corresponds exactly to *Barulcus*, and it is probable that *Barulcus* and *Mechanics* were only alternative titles for one and the same work. It is indeed not credible that Hero wrote two

separate treatises on the subject of the mechanical powers, which are fully discussed in the *Mechanics*, ii., iii. The *Beloponica* (on engines of war) is extant in Greek, and both this and the *Mechanics* contain Hero's solution of the problem of the two mean proportionals. Hero also wrote *Catoptrica* (on reflecting surfaces), and it seems certain that we possess this in a Latin work, probably translated from the Greek by Wilhelm van Moerbeek, which was long thought to be a fragment of Ptolemy's *Optics*, because it bore the title *Ptolemaei de speculis* in the MS. But the attribution to Ptolemy was shown to be wrong as soon as it was made clear (especially by Martin) that another translation by an Admiral Eugenius Siculus (12th century) of an optical work from the Arabic was Ptolemy's *Optics*. Of other treatises by Hero only fragments remain. One was four books on *Water Clocks* (*Περί ὕδρων ἀπορροίων*), of which Proclus (*Hypotyp. astron.*, ed. Halma) has preserved a fragment, and to which Pappus also refers. Another work was a commentary on Euclid (referred to by the Arabs as "the book of the resolution of doubts in Euclid") from which quotations have survived in an-Nairizi's commentary.

The *Pneumatica*, *Automatopneutica*, *Beloponica* and *Cheiroballistra* of Hero were published in Greek and Latin in Thôvenot's *Veterum mathematicorum opera graece et latina plerisque nunc primum edita* (Paris, 1603); the first important critical researches on Hero were G. B. Venturi's *Commentari sopra la storia e la teoria dell'ottica* (Bologna, 1814) and H. Martin's "Recherches sur la vie et les ouvrages d'Héron d'Alexandrie disciple de Ctésibius et sur tous les ouvrages mathématiques grecs conservés ou perdus, publiés ou inédits, qui ont été attribués à un auteur nommé Héron" (*Mém. présentés à l'Académie des Inscriptions et Belles-Lettres*, i. série, iv., 1854). The geometrical works (except of course the *Métrica*) were edited (Greek only) by F. Hultsch (*Heronis Alexandrini geometricorum et stereometricorum reliquiae*, 1864), the *Dioptra* by Vincent (*Extraits des manuscrits relatifs à la géométrie pratique des Grecs, Notices et extraits des manuscrits de la Bibliothèque Impériale*, xix. 2, 1858), the treatises on *Engines of War* by C. Wescher (*Poliorettique des Grecs*, Paris, 1867). The *Mechanics* was first published by Carra de Vaux in the *Journal asiatique* (ix. série, ii., 1893). In 1899 began the publication in Teubner's series of *Heronis Alexandrini opera quae supersunt omnia*. Vol. i. and Supplement (by W. Schmidt) contains the *Pneumatica* and *Automata*, the fragment on *Water Clocks*, the *De ingeniis spiritualibus* of Philon of Byzantium and extracts on *Pneumatica* by Vitruvius. Vol. ii. pt. i., by L. Nix and W. Schmidt, contains the *Mechanics* in Arabic, Greek fragments of the same, the *Catoptrica* in Latin with appendices of extracts from Olympiodorus, Vitruvius, Pliny, &c. Vol. iii. (by Hermann Schöne) contains the *Métrica* (in three books) and the *Dioptra*. A German translation is added throughout. The approximation to square roots in Hero has been the subject of papers too numerous to mention. But reference should be made to the exhaustive studies on Hero's arithmetic by Paul Tannery, "L'Arithmétique des Grecs dans Héron d'Alexandrie" (*Mém. de la Soc. des sciences phys. et math. de Bordeaux*, ii. série, iv., 1882), "La Stéréométrie d'Héron d'Alexandrie" and "Études Héroniennes" (*ibid.* v., 1883), "Questions Héroniennes" (*Bulletin des sciences math.*, ii. série, viii., 1884), "Un Fragment des Métriques d'Héron" (*Zeitschrift für Math. und Physik*, xxxix., 1894); *Bulletin des sciences math.*, ii. série, xviii., 1894). A good account of Hero's works will be found in M. Cantor's *Geschichte der Mathematik*, i² (1894), chapters 18 and 19, and in G. Loria's studies, *Le Scienze esatte nell' antica Grecia*, especially libro iii. (Modena, 1900), pp. 103-128.

HERO, THE YOUNGER, the name given without any sufficient reason to a Byzantine land-surveyor who wrote (about A.D. 938) a treatise on land-surveying modelled on the works of Hero of Alexandria, especially the *Dioptra*.

See "Géodésie de Héron de Byzance" published by Vincent in *Notices et extraits des manuscrits de la Bibliothèque Impériale*, xix. 2 (Paris, 1858), and T. H. Martin in *Mémoires présentés à l'Académie des Inscriptions*, 1st série, iv. (Paris, 1854).

HEROD, the name borne by the princes of a dynasty which reigned in Judaea from 40 B.C.

HEROD (surnamed THE GREAT), the son of Antipater, who supported Hyrcanus II. against Aristobulus II. with the aid first of the Nabataean Arabs and then of Rome. The family seems to have been of Idumaean origin, so that its members were liable to the reproach of being half-Jews or even foreigners. Justin Martyr has a tradition that they were originally Philistines of Ascalon (*Dial.* c. 52), and on the other hand Nicolaus of Damascus (*apud Jos. Ant.* xiv. 1. 3) asserted that Herod, his royal patron, was descended from the Jews who first returned from the Babylonian

Captivity. The tradition and the assertion are in all probability equally fictitious and proceed respectively from the foes and the friends of the Herodian dynasty.

Antipas (or Antipater), the father of Antipater, had been governor of Idumaea under Alexander Jannaeus. His son allied himself by marriage with the Arabian nobility and became the real ruler of Palestine under Hyrcanus II. When Rome intervened in Asia in the person of Pompey, the younger Antipater realized her inevitable predominance and secured the friendship of her representative. After the capture of Jerusalem in 63 B.C. Pompey installed Hyrcanus, who was little better than a figurehead, in the high-priesthood; and when in 55 B.C. the son of Aristobulus renewed the civil war in Palestine, the Roman governor of Syria in the exercise of his jurisdiction arranged a settlement "in accordance with the wishes of Antipater" (*Jos. Ant.* xiv. 6. 4). To this policy of dependence upon Rome Antipater adhered, and he succeeded in commending himself to Mark Antony and Caesar in turn. After the battle of Pharsalia Caesar made him procurator and a Roman citizen.

At this point Herod appears on the scene as ruler of Galilee (*Jos. Ant.* xiv. 9. 2) appointed by his father at the age of fifteen or, since he died at seventy, twenty-five. In spite of his youth he soon found an opportunity of displaying his mettle; for he arrested Hezekiah the arch-brigand, who had overrun the Syrian border, and put him to death. The Jewish nobility at Jerusalem seized upon this high-handed action as a pretext for satisfying their jealousy of their Idumaean rulers. Herod was cited in the name of Hyrcanus to appear before the Sanhedrin, whose prerogative he had usurped in executing Hezekiah. He appeared with a bodyguard, and the Sanhedrin was overawed. Only Sameas, a Pharisee, dared to insist upon the legal verdict of condemnation. But the governor of Syria had sent a demand for Herod's acquittal, and so Hyrcanus adjourned the trial and persuaded the accused to abscond. Herod returned with an army, but his father prevailed upon him to depart to Galilee without wreaking his vengeance upon his enemies. About this time (47-46 B.C.) he was created *strategus* of Coele Syria by the provincial governor. The episode is important for the light which it throws upon Herod's relations with Rome and with the Jews.

In 44 B.C. Cassius arrived in Syria for the purpose of filling his war-chest: Antipater and Herod collected the sum of money at which the Jews of Palestine had been assessed. In 43 B.C. Antipater was poisoned at the instigation of one Malichus, who was perhaps a Jewish patriot animated by hatred of the Herods and their Roman patrons.

With the connivance of Cassius Herod had Malichus assassinated; but the country was in a state of anarchy, thanks to the extortions of Cassius and the encroachments of neighbouring powers. Antony, who became master of the East after Philippi, was ready to support the sons of his friend Antipater; but he was absent in Egypt when the Parthians invaded Palestine to restore Antigonus to the throne of his father Aristobulus (40 B.C.). Herod escaped to Rome: the Arabians, his mother's people, had repudiated him. Antony had made him tetrarch, and now with the assent of Octavian persuaded the Senate to declare him king of Judaea.

In 39 B.C. Herod returned to Palestine and, when the presence of Antony put the reluctant Roman troops entirely at his disposal, he was able to lay siege to Jerusalem two years later. Secure of the support of Rome he was concerned also to legitimize his position in the eyes of the Jews by taking, for love as well as policy, the Hasmonaean princess Mariamne to be his second wife. Jerusalem was taken by storm; the Roman troops withdrew to behead Antigonus the usurper at Antioch. In 37 B.C. Herod was king of Judaea, being the client of Antony and the husband of Mariamne.

The Pharisees, who dominated the bulk of the Jews, were content to accept Herod's rule as a judgment of God. Hyrcanus returned from his prison: mutilated, he could no longer hold office as high-priest; but his mutilation probably gave him the prestige of a martyr, and his influence—whatever it was worth—

seems to have been favourable to the new dynasty. On the other hand Herod's marriage with Mariamne brought some of his enemies into his own household. He had scotched the faction of Hasmonæan sympathizers by killing forty-five members of the Sanhedrin and confiscating their possessions. But so long as there were representatives of the family alive, there was always a possible pretender to the throne which he occupied; and the people had not lost their affection for their former deliverers. Mariamne's mother used her position to further her plots for the overthrow of her son-in-law; and she found an ally in Cleopatra of Egypt, who was unwilling to be spurned by him, even if she was not weary of his patron, Antony.

The events of Herod's reign indicate the temporary triumphs of his different adversaries. His high-priest, a Babylonian, was deposed in order that Aristobalus III., Mariamne's brother, might hold the place to which he had some ancestral right. But the enthusiasm with which the people received him at the Feast of Tabernacles convinced Herod of the danger; and the youth was drowned by order of the king at Jericho. Cleopatra had obtained from Antony a grant of territory adjacent to Herod's domain and even part of it. She required Herod to collect arrears of tribute. So it fell out that, when Octavian and the Senate declared war against Antony and Cleopatra, Herod was preoccupied in obedience to her commands and was thus prevented from fighting against the future emperor of Rome.

After the battle of Actium (31 B.C.) Herod executed Hyrcanus and proceeded to wait upon the victorious Octavian at Rhodes. His position was confirmed and his territories were restored. On his return he took in hand to heal with the Hasmonæans, and in 25 B.C. the old intriguers, their victims like Mariamne, and all pretenders were dead. From this time onwards Herod was free to govern Palestine, as a client-prince of the Roman Empire should govern his kingdom. In order to put down the brigands who still infested the country and to check the raids of the Arabs on the frontier, he built or rebuilt fortresses, which were of material assistance to the Jews in the great revolt against Rome. Within and without Judæa he erected magnificent buildings and founded cities. He established games in honour of the emperor after the ancient Greek model in Caesarea and Jerusalem and revived the splendour of the Olympic games. At Athens and elsewhere he was commemorated as a benefactor; and as Jew and king of the Jews he restored the temple at Jerusalem. The emperor recognized his successful government by putting the districts of Ulatba and Panias under him in 20 B.C.

But Herod found new enemies among the members of his household. His brother Pheroras and sister Salome plotted for their own advantage and against the two sons of Mariamne. The people still cherished a loyalty to the Hasmonæan lineage, although the young princes were also the sons of Herod. The enthusiasm with which they were received fed the suspicion, which their uncle instilled into their father's mind, and they were strangled at Sebaste. On his deathbed Herod discovered that his eldest son, Antipater, whom Josephus calls a "monster of iniquity," had been plotting against him. He proceeded to accuse him before the governor of Syria and obtained leave from Augustus to put him to death. The father died five days after his son in 4 B.C. He had done much for the Jews, thanks to the favour he had won and kept in spite of all from the successive heads of the Roman state; he had observed the Law publicly—in fact, as the traditional epigram of Augustus says, "it was better to be Herod's *swine* than a *son* of Herod."

Josephus, *Ant.* xv., xvi., xvii. 1-8, *B. J.* I. 18-33; Schäfer, *Gesch. d. jüd. Volk.*, 4th ed., I. pp. 360-418.

HEROD ANTIPAS, son of Herod the Great by the Samaritan Malthece, and full brother of Archelaus, received as his share of his father's dominions the provinces of Galilee and Peraea, with the title of tetrarch. Like his father, Antipas had a turn for architecture: he rebuilt and fortified the town of Sepphoris in Galilee; he also fortified Betharamphtha in Peraea, and called it Julia after the wife of the emperor. Above all he founded the important town of Tiberias on the west shore of the Sea of Galilee, with institutions of a distinctly Greek character. He reigned

4 B.C.-A.D. 39. In the gospels he is mentioned as Herod. He it was who was called a "fox" by Christ (Luke xiii. 32). He is erroneously spoken of as a king in Mark vi. 14. It was to him that Jesus was sent by Pilate to be tried. But it is in connexion with his wife Herodias that he is best known, and it was through her that his misfortunes arose. He was married first of all to a daughter of Aretas, the Arabian king; but, making the acquaintance of Herodias, the wife of his brother Philip (not the tetrarch), during a visit to Rome, he was fascinated by her and arranged to marry her. Meantime his Arabian wife discovered the plan and escaped to her father, who made war on Herod, and completely defeated his army. John the Baptist condemned his marriage with Herodias, and in consequence was put to death in the way described in the gospels and in Josephus. When Herodias's brother Agrippa was appointed king by Caligula, she was determined to see her husband attain to an equal eminence, and persuaded him, though naturally of a quiet and unambitious temperament, to make the journey to Rome to crave a crown from the emperor. Agrippa, however, managed to influence Caligula against him. Antipas was deprived of his dominions and banished to Lyons, Herodias voluntarily sharing his exile.

HEROD PHILIP, son of Herod the Great by Cleopatra of Jerusalem, received the tetrarchy of Ituræa and other districts to E. and N.E. of the Lake of Galilee, the poorest part of his father's kingdom. His subjects were mainly Greeks or Syrians, and his coins bear the image of Augustus or Tiberius. He is described as an excellent ruler, who loved peace and was careful to maintain justice, and spent his time in his own territories. He was also a builder of cities, one of which was Caesarea Philippi, and another was Bethsaida, which he called Julia. He died after a reign of thirty-seven years (4 B.C.-A.D. 34); and his dominions were incorporated in the province of Syria. (J. H. A. H.)

HERODAS (Gr. Ἡρόδας), or HERONIDAS (the name is spelt differently in the few places where he is mentioned), Greek poet, the author of short humorous dramatic scenes in verse, written under the Alexandrian empire in the 3rd century B.C. Apart from the intrinsic merit of these pieces, they are interesting in the history of Greek literature as being a new species, illustrating Alexandrian methods. They are called *Μυμηματῶν*, "Mime-iambics." Mimes were the Dorian product of South Italy and Sicily, and the most famous of them—from which Plato is said to have studied the drawing of character—were the work of Sophron. These were scenes in popular life, written in the language of the people, vigorous with racy proverbs such as we get in other reflections of that region—in Petronius and the *Pentamerone*. Two of the best known and the most vital among the *Idylls* of Theocritus, the 2nd and the 15th, we know to have been derived from mimes of Sophron. What Theocritus is doing there, Herodas, his younger contemporary, is doing in another manner—casting old material into novel form, upon a small scale, under strict conditions of technique. The method is entirely Alexandrian: Sophron had written in a peculiar kind of rhythmical prose; Theocritus uses the hexameter and Doric, Herodas the *æson* or "lame" iambic (with a dragging spondee at the end) and the old Ionic dialect with which that curious metre was associated. That, however, hardly goes beyond the choice and form of words; the structure of the sentences is close-knit Attic. But the grumbling metre and quaint language suit the tone of common life which Herodas aims at realizing; for, as Theocritus may be called idealist, Herodas is a realist unflinching. His persons talk in vehement exclamations and emphatic turns of speech, with proverbs and fixed phrases; and occasionally, where it is designed as proper to the part, with the most naked coarseness of expression.

The scene of the second and the fourth is laid at Cos, and the speaking characters in each are never more than three. In Mime I. the old nurse, now the professional go-between or bawd, calls on Metrichè, whose husband has been long away in Egypt, and endeavours to excite her interest in a most desirable young man, fallen deeply in love with her at first sight. After hearing all the arguments Metrichè declines with dignity, but consoles the old woman with an ample glass of wine, this kind being always

represented with the taste of Mrs Camp. II. is a monologue by the Πορνοβοσκός ("Whoremonger") prosecuting a merchant-trader for breaking into his establishment at night and attempting to carry off one of the inmates, who is produced in court. The vulgar blackguard, who is a stranger to any sort of shame, remarking that he has no evidence to call, proceeds to a peroration in the regular oratorical style, appealing to the Coan judges not to be unworthy of their traditional glories. In fact, the whole oration is also a burlesque in every detail of an Attic speech at law; and in this case we have the material from which to estimate the excellence of the parody. In III. a desperate mother brings to the schoolmaster a truant urchin, with whom neither she nor his incapable old father can do anything. In a valuable stream of interminable sentences she narrates his misdeeds and implores the schoolmaster to flog him. The boy accordingly is hoisted on another's back and flogged; but his spirit does not appear to be subdued, and the mother resorts to the old man after all. IV. is a visit of two poor women with an offering to the temple of Asclepius at Coa. While the humble cock is being sacrificed, they turn, like the women in the *Ion* of Euripides, to admire the works of art; among them a small boy strangling a vulpanser—doubtless the work of Boëthus that we know—and a sacrificial procession by Apelles, "the Ephesian," of whom we have an interesting piece of contemporary eulogy. The oily sacristan is admirably painted in a few slight strokes. V. brings us very close to some unpleasant facts of ancient life. The jealous woman accuses one of her slaves, whom she has made her favourite, of infidelity; has him bound and sent degraded through the town to receive 2000 lashes; no sooner is he out of sight than she recalls him to be branded "at one job." The only pleasing person in the piece is the little maidservant—permitted liberties as a *verna* brought up in the house—whose ready tact suggests to her mistress an excuse for postponing execution of a threat made in ungovernable fury. VI. is a friendly chat or a private conversation. The subject is an ugly one, but the dialogue is as clever and amusing as the rest, with some delicious touches. Our interest is engaged here in a certain Kerdon, the artistic shoemaker, to whom we are introduced in VII. (the name had already become generic for the shoemaker as the typical representative of retail trade), a little bald man with a fluent tongue, complaining of hard times, who bluffs and wheedles by turns. VII. opens with a mistress waking up her maids to listen to her dream; but we have only the beginning, and the other fragments are very short.

Within the limits of 100 lines or less Herodas presents us with a highly entertaining scene and with characters definitely drawn. Some of these had been perfected no doubt upon the Attic stage, where the tendency in the 4th century had been gradually to evolve accepted types—not individuals, but generalizations from a class, an art in which Menander's was esteemed the master-hand. The Πορνοβοσκός and the Μαστροπός we can piece together from succeeding literature, and see how skilfully the established traits are indicated here. This is achieved by true dramatic means, with touches never wasted and the more delightful often because they do not clamour for attention. The execution has the qualities of first-rate Alexandrian work in miniature, such as the epigrams of Asclepiades possess, the finish and firm outlines; and these little pictures bear the test of all artistic work—they do not lose their freshness with familiarity, and gain in interest as one learns to appreciate their subtle points.

The papyrus MS., obtained from the Fayum, is in the possession of the British Museum, and was first printed by F. G. Kenyon in 1891. Editions by O. Crusius (1905, text only, in Teubner series) and J. A. Nairn (1904), with introduction, notes and bibliography. There is an English verse translation of the mimes by H. Sharpley (1906) under the title *A Realist of the Aegean*. (W. G. H.)

HERODIANS (Ἡροδιανός), a sect or party mentioned in Scripture as having on two occasions—once in Galilee, and again in Jerusalem—manifested an unfriendly disposition towards Jesus (Mark iii. 6, xii. 13; Matt. xxii. 6; cf. also Mark viii. 15). In each of these cases their name is coupled with that of the Pharisees. According to many interpreters the courtiers or

soldiers of Herod Antipas ("Militēs Herodias," Jerome) are intended; but more probably the Herodians were a public political party, who distinguished themselves from the two great historical parties of post-exilic Judaism by the fact that they were and had been sincerely friendly to Herod the Great and to his dynasty (cf. such formations as "Caesariani," "Pompeiani"). It is possible that, to gain adherents, the Herodian party may have been in the habit of representing that the establishment of a Herodian dynasty would be favourable to the realization of the theocracy; and this in turn may account for Tertullian's (*De praescr.*) allegation that the Herodians regarded Herod himself as the Messiah. The sect was called by the Rabbis Boethusians as being friendly to the family of Boëthus, whose daughter Mariamne was one of Herod the Great's wives. (J. H. A. H.)

HERODIANUS, Greek historian, flourished during the third century A.D. He is supposed to have been a Syrian Greek. In 203 he was in Rome, where he held some minor posts. He does not appear to have attained high official rank; the statement that he was imperial procurator and legate of the Sicilian provinces rests upon conjecture only. His historical work (*Ἡροδιανου τῆς μετὰ Μάρκον βασιδίας ιστοριῶν βιβλία δεκά*) narrates the events of the fifty-eight years between the death of Marcus Aurelius and the proclamation of Gordianus III. (180-238). The narrative is of special value as supplementing Dion Cassius, whose history ends with Alexander Severus. His work has the value that attaches to a record written by one chronicling the events of his own times, gifted with ordinary powers of observation, indubitable candour and independence of view. But while he gives a lively account of external events—such as the death of Commodus and the assassination of Pertinax—the barbarian invasions, the spread of Christianity, the extension of the franchise by Caracalla are unnoticed. The dates are often wrong, and little attention is paid to geographical details, which makes the narrative of military expeditions beyond the borders of the empire difficult to understand. Herodian has been accused of prejudice against Alexander Severus. His style, modelled on that of Thucydides and unreservedly praised by Photius, is on the whole pure, though somewhat rhetorical and showing a foindness for Latinisms.

Extensive use has been made of Herodianus by later chroniclers, especially the "Scriptores historiae Augustae" and John of Antioch. His history was first translated into Latin at the end of the 15th century by Politian. The most complete edition is by G. W. Irmschir (1789-1805), with elaborate indices, but the notes are very diffuse; critical editions by I. Bekker (1855), L. Mendelssohn (1863); see also C. Dändliker.

HERODIANUS, AELIUS, called ὁ τεχνικός, Alexandrian grammarian, flourished in the 2nd century A.D. He early took up his residence at Rome, where he enjoyed the patronage of Marcus Aurelius (161-180), to whom he dedicated his great treatise on prosody. This work in twenty-one books (*Καθολικὴ προσημία*) included also an account of the etymological part of grammar. The work itself is lost, but several epitomes of it have been preserved. His *Ἐπιμετρησμοί* dealt with difficult words and peculiar forms in Homer. Herodianus also wrote numerous grammatical treatises, of which only one has come down to us in a complete form (*Περὶ μορφῶν λέξεων*, on peculiar style), articles on exceptional or anomalous words. Numerous quotations and fragments still exist, chiefly in the Homeric scholiasts and Stephanus of Byzantium. Herodianus enjoyed a great reputation as a grammarian, and Priscian styles him "maximus auctor artis grammaticae."

The best edition is by A. Lents, *Herodiani Technici reliquiae* (1867-1870); a supplementary volume is included in Uhlig's *Corpus grammaticorum Graecorum*; for further bibliographical information see W. Christ, *Geschichte der griechischen Literatur* (1898).

HERODOTUS (c. 484-425 B.C.), Greek historian, called the Father of History, was born at Halicarnassus in Asia Minor, then dependent upon the Persians, in or about the year 484 B.C. Herodotus was thus born a Persian subject, and such he continued until he was thirty or five-and-thirty years of age. At the time of his birth Halicarnassus was under the rule of a queen

Artemisia (q.v.). The year of her death is unknown; but she left her crown to her son Pisindelis (born about 498 B.C.), who was succeeded upon the throne by his son Lygdamis about the time that Herodotus grew to manhood. The family of Herodotus belonged to the upper rank of the citizens. His father was named Lyxes, and his mother Khaeo, or Dryo. He had a brother Theodore, and an uncle or cousin Panyasis (q.v.), the epic poet, a personage of so much importance that the tyrant Lygdamis, suspecting him of treasonable projects, put him to death. It is probable that Herodotus shared his relative's political opinions, and either was exiled from Halicarnassus or quitted it voluntarily at the time of his execution.

Of the education of Herodotus no more can be said than that it was thoroughly Greek, and embraced no doubt the three subjects essential to a Greek liberal education—grammar, gymnastic training and music. His studies would be regarded as completed when he attained the age of eighteen, and took rank among the *ephebi* or *eirenes* of his native city. In a free Greek state he would at once have begun his duties as a citizen, and found therein sufficient employment for his growing energies. But in a city ruled by a tyrant this outlet was wanting; no political life worthy of the name existed. Herodotus may thus have had his thoughts turned to literature as furnishing a not unsatisfactory career, and may well have been encouraged in his choice by the example of Panyasis, who had already gained a reputation by his writings when Herodotus was still an infant. At any rate it is clear from the extant work of Herodotus that he must have devoted himself early to the literary life, and commenced that extensive course of reading which renders him one of the most instructive as well as one of the most charming of ancient writers. The poetical literature of Greece was already large; the prose literature was more extensive than is generally supposed; yet Herodotus shows an intimate acquaintance with the whole of it. The *Iliad* and the *Odyssey* are as familiar to him as Shakespeare to the educated Englishman. He is acquainted with the poems of the epic cycle, the *Cypris*, the *Epigoni*, &c. He quotes or otherwise shows familiarity with the writings of Hesiod, Olen, Musaeus, Bacis, Lyaistratus, Archilochus of Paros, Alcaeus, Sappho, Solon, Aesop, Aristaeus of Proconnesus, Simonides of Ceos, Phrynichus, Aeschylus and Pindar. He quotes and criticizes Hecataeus, the best of the prose writers who had preceded him, and makes numerous allusions to other authors of the same class.

It must not, however, be supposed that he was at any time a mere student. It is probable that from an early age his inquiring disposition led him to engage in travels, both in Greece and in foreign countries. He traversed Asia Minor and European Greece probably more than once; he visited all the most important islands of the Archipelago—Rhodes, Cyprus, Delos, Paros, Thasos, Samothrace, Crete, Samos, Cythera and Aegina. He undertook the long and perilous journey from Sardis to the Persian capital Susa, visited Babylon, Colchis, and the western shores of the Black Sea as far as the estuary of the Dnieper; he travelled in Scythia and in Thrace, visited Zante and Magna Graecia, explored the antiquities of Tyre, coasted along the shores of Palestine, saw Gaza, and made a long stay in Egypt. At the most moderate estimate, his travels covered a space of thirty-one degrees of longitude, or 1700 miles, and twenty-four of latitude, or nearly the same distance. At all the more interesting sites he took up his abode for a time; he examined, he inquired, he made measurements, he accumulated materials. Having in his mind the scheme of his great work, he gave ample time to the elaboration of all its parts, and took care to obtain by personal observation a full knowledge of the various countries.

The travels of Herodotus seem to have been chiefly accomplished between his twentieth and his thirty-seventh year (464–447 B.C.).¹ It was probably in his early manhood that as a Persian subject he visited Susa and Babylon, taking advantage of the Persian system of posts which he describes in his fifth book. His residence

¹ The date of his travels is difficult to determine. E. Meyer inclines to put all the longer journeys, except the Scythian, between 440 and 430 B.C. The journey to Susa and Babylon is put by C. F. Lehmann c. 450 B.C., and by H. Stein before 450.

in Egypt must, on the other hand, have been subsequent to 460 B.C., since he saw the skulls of the Persians slain by Inarus in that year. Skulls are rarely visible on a battlefield for more than two or three seasons after the fight, and we may therefore presume that it was during the reign of Inarus (460–454 B.C.),² when the Athenians had great authority in Egypt, that he visited the country, making himself known as a learned Greek, and therefore receiving favour and attention on the part of the Egyptians, who were so much beholden to his countrymen (see ATHENS, CIMON, PERICLES). On his return from Egypt, as he proceeded along the Syrian shore, he seems to have landed at Tyre, and from thence to have gone to Thasos. His Scythian travels are thought to have taken place prior to 450 B.C.

It is a question of some interest from what centre or centres these various expeditions were made. Up to the time of the execution of Panyasis, which is placed by chronologists in or about the year 457 B.C., there is every reason to believe that Herodotus lived at Halicarnassus. His travels in Asia Minor, in European Greece, and among the islands of the Aegean, probably belong to this period, as also his journey to Susa and Babylon. We are told that when he quitted Halicarnassus on account of the tyranny of Lygdamis, in or about the year 457 B.C., he took up his abode in Samos. That island was an important member of the Athenian confederacy, and in making it his home Herodotus would have put himself under the protection of Athens. The fact that Egypt was then largely under Athenian influence (see CIMON, PERICLES) may have induced him to proceed, in 457 or 456 B.C., to that country. The stories that he had heard in Egypt of Sesostris may then have stimulated him to make voyages from Samos to Colchis, Scythia and Thrace. He was thus acquainted with almost all the regions which were to be the scene of his projected history.

After Herodotus had resided for some seven or eight years in Samos, events occurred in his native city which induced him to return thither. The tyranny of Lygdamis had gone from bad to worse, and at last he was expelled. According to Suidas, Herodotus was himself an actor, and indeed the chief actor, in the rebellion against him; but no other author confirms this statement, which is intrinsically improbable. It is certain, however, that Halicarnassus became henceforward a voluntary member of the Athenian confederacy. Herodotus would now naturally return to his native city, and enter upon the enjoyment of those rights of free citizenship on which every Greek set a high value. He would also, if he had by this time composed his history, or any considerable portion of it, begin to make it known by recitation among his friends. There is reason to believe that these first attempts were not received with much favour, and that it was in chagrin at his failure that he precipitately withdrew from his native town, and sought a refuge in Greece proper (about 447 B.C.).³ We learn that Athens was the place to which he went, and that he appealed from the verdict of his countrymen to Athenian taste and judgment. His work won such approval that in the year 445 B.C., on the proposition of a certain Anytus, he was voted a sum of ten talents (£2400) by decree of the people. At one of the recitations, it was said, the future historian Thucydides was present with his father, Olorus, and was so moved that he burst into tears, whereupon Herodotus remarked to the father—"Olorus, your son has a natural enthusiasm for letters."⁴

Athens was at this time the centre of intellectual life, and could boast an almost unique galaxy of talent—Pericles, Thucydides the son of Melesias, Aspasia, Antiphon, the musician Damon, Pheidias, Protagoras, Zeno, Cratinus, Crates, Euripides and Sophocles. Accepted into this brilliant society, on familiar terms with all probably, as he certainly was with Olorus,

² Most recent critics (e.g. Stein, Meyer, Busolt) put the visit to Egypt after the suppression of the revolt under Inarus and Amyrtæus (i.e. after 449 B.C.), on the strength of Herod. 2. 30, which implies the restoration of Persian authority.

³ Stein, Meyer, Busolt, and other recent writers attribute his departure from Halicarnassus to political causes, e.g. the ascendancy of the anti-Athenian party in the state.

⁴ This story is on chronological grounds rejected by all recent critics.

Thucydides and Sophocles, he must have been tempted, like many another foreigner, to make Athens his permanent home. It is to his credit that he did not yield to this temptation. At Athens he must have been a dilettante, an idler, without political rights or duties. As such he would have soon ceased to be respected in a society where literature was not recognized as a separate profession, where a Socrates served in the infantry, a Sophocles commanded fleets, a Thucydides was general of an army, and an Antiphon was for a time at the head of the state. Men were not men according to Greek notions unless they were citizens; and Herodotus, aware of this, probably sharing in the feeling, was anxious, having lost his political status at Halicarnassus, to obtain such status elsewhere. At Athens the franchise, jealously guarded at this period, was not to be attained without great expense and difficulty. Accordingly, in the spring of the following year he sailed from Athens with the colonists who went out to found the colony of Thurii (see PERICLES), and became a citizen of the new town.

From this point of his career, when he had reached the age of forty, we lose sight of him almost wholly. He seems to have made but few journeys, one to Crotona, one to Metapontum, and one to Athens (about 430 B.C.) being all that his work indicates.¹ No doubt he was employed mainly, as Pliny testifies, in retouching and elaborating his general history. He may also have composed at Thurii that special work on the history of Assyria to which he twice refers in his first book, and which is quoted by Aristotle. It has been supposed by many that he lived to a great age, and argued that "the never-to-be-mistaken fundamental tone of his performance is the quiet talkativeness of a highly cultivated, tolerant, intelligent, *old man*" (Dahlmann). But the indications derived from the later touches added to his work, which form the sole evidence on the subject, would rather lead to the conclusion that his life was not very prolonged. There is nothing in the nine books which may not have been written as early as 430 B.C.; there is no touch which, even probably, points to a later date than 424 B.C. As the author was evidently engaged in polishing his work to the last, and even promises touches which he does not give, we may assume that he did not much outlive the date last mentioned, or in other words, that he died at about the age of sixty. The predominant voice of antiquity tells us that he died at Thurii, where his tomb was shown in later ages.

The History.—In estimating the great work of Herodotus, and his genius as its author, it is above all things necessary to conceive aright what that work was intended to be. It has been called "a universal history," "a history of the wars between the Greeks and the barbarians," and "a history of the struggle between Greece and Persia." But these titles are all of them too comprehensive. Herodotus, who omits wholly the histories of Phœnicia, Carthage and Etruria, three of the most important among the states existing in his day, cannot have intended to compose a "universal history," the very idea of which belongs to a later age. He speaks in places as if his object was to record the wars between the Greeks and the barbarians; but as he omits the Trojan war, in which he fully believes, the expedition of the Teucrians and Mysians against Thrace and Thessaly, the wars connected with the Ionian colonization of Asia Minor and others, it is evident that he does not really aim at embracing in his narrative all the wars between Greeks and barbarians with which he was acquainted. Nor does it even seem to have been his object to give an account of the entire struggle between Greece and Persia. That struggle was not terminated by the battle of Mycale and the capture of Sestos in 479 B.C. It continued for thirty years longer, to the peace of Callias (but see CALLIAS and CIMON). The fact that Herodotus ends his history where he does shows distinctly that his intention

¹ Opinion is divided as to this visit to Athens after his settlement at Thurii. Stein, Meyer and Busolt hold that much of his work (especially the later books) was composed at Athens soon after 430 B.C. See further Wachsmuth, *Rheinisches Museum*, lvi. (1901) 215-218. Macan, *Herodotus VII.-IX.* (Introduction, pp. xlv.-lxvi.), seeks to prove that the last three books were the first part of the *Histories* to be composed. He is followed in this view by Bury.

was, not to give an account of the entire long contest between the two countries, but to write the history of a particular war—the great Persian war of invasion. His aim was as definite as that of Thucydides, or Schiller, or Napier or any other writer who has made his subject a particular war; only he determined to treat it in a certain way. Every partial history requires an "introduction"; Herodotus, untrammelled by examples, resolved to give his history a magnificent introduction. Thucydides is content with a single introductory book, forming little more than one-eighth of his work; Herodotus has six such books, forming two-thirds of the entire composition.

By this arrangement he is enabled to treat his subject in the *grand way*, which is so characteristic of him. Making it his main object in his "introduction" to set before his readers the previous history of the two nations who were the actors in the great war, he is able in tracing their history to bring into his narrative some account of almost all the nations of the known world, and has room to expatiate freely upon their geography, antiquities, manners and customs and the like, thus giving his work a "universal" character, and securing for it, without trenching upon unity, that variety, richness and fulness which are a principal charm of the best histories, and of none more than his. In tracing the growth of Persia from a petty subject kingdom to a vast dominant empire, he has occasion to set out the histories of Lydia, Media, Assyria, Babylon, Egypt, Scythia, Thrace, and to describe the countries and the peoples inhabiting them, their natural productions, climate, geographical position, monuments, &c.; while, in noting the contemporaneous changes in Greece, he is led to tell of the various migrations of the Greek race, their colonies, commerce, progress in the arts, revolutions, internal struggles, wars with one another, legislation, religious tenets and the like. The greatest variety of episodic matter is thus introduced; but the propriety of the occasion and the mode of introduction are such that no complaint can be made; the episodes never entangle, encumber or even unpleasantly interrupt the main narrative.

It has been questioned, both in ancient and in modern times, whether the history of Herodotus possesses the essential requisite of trustworthiness. Several ancient writers accuse him of intentional untruthfulness. Moderns generally acquit him of this charge; but his severer critics still urge that, from the inherent defects of his character, his credulity, his love of effect and his loose and inaccurate habits of thought, he was unfitted for the historian's office, and has produced a work of but small historical value. Perhaps it may be sufficient to remark that the defects in question certainly exist, and detract to some extent from the authority of the work, more especially of those parts of it which deal with remoter periods, and were taken by Herodotus on trust from his informants, but that they only slightly affect the portions which treat of later times and form the special subject of his history. In confirmation of this view, it may be noted that the authority of Herodotus for the circumstances of the great Persian war, and for all local and other details which come under his immediate notice, is accepted by even the most sceptical of modern historians, and forms the basis of their narratives.

Among the merits of Herodotus as an historian, the most prominent are the diligence with which he collected his materials, the candour and impartiality with which he has placed his facts before the reader, the absence of party bias and undue national vanity, and the breadth of his conception of the historian's office. On the other hand, he has no claim to rank as a critical historian; he has no conception of the philosophy of history, no insight into the real causes that underlie political changes, no power of penetrating below the surface, or even of grasping the real interconnection of the events which he describes. He belongs distinctly to the romantic school; his forte is vivid and picturesque description, the lively presentation of scenes and actions, characters and states of society, not the subtle analysis of motives, the power of detecting the undercurrents or the generalizing faculty.

But it is as a writer that the merits of Herodotus are most

conspicuous. "O that I were in a condition," says Lucian, "to resemble Herodotus, if only in some measure! I by no means say in all his gifts, but only in some single point; as, for instance, the beauty of his language, or its harmony, or the natural and peculiar grace of the Ionic dialect, or his fulness of thought, or by whatever name those thousand beauties are called which to the despair of his imitator are united in him." Cicero calls his style "copious and polished." Quintilian, "sweet, pure and flowing"; Longinus says he was "the most Homeric of historians"; Dionysius, his countryman, prefers him to Thucydides, and regards him as combining in an extraordinary degree the excellences of sublimity, beauty and the true historical method of composition. Modern writers are almost equally complimentary. "The style of Herodotus," says one, "is universally allowed to be remarkable for its harmony and sweetness." "The charm of his style," argues another, "has so dazzled men as to make them blind to his defects." Various attempts have been made to analyse the charm which is so universally felt; but it may be doubted whether any of them are very successful. All, however, seem to agree that among the qualities for which the style of Herodotus is to be admired are simplicity, freshness, naturalness and harmony of rhythm. Master of a form of language peculiarly sweet and euphonic, and possessed of a delicate ear which instinctively suggested the most musical arrangement possible, he gives his sentences, without art or effort, the most agreeable flow, is never abrupt, never too diffuse, much less prolix or wearisome, and being himself simple, fresh, *naïf* (if we may use the word), honest and somewhat quaint, he delights us by combining with this melody of sound simple, clear and fresh thoughts, perspicuously expressed, often accompanied by happy turns of phrase, and always manifestly the spontaneous growth of his own fresh and unsophisticated mind. Reminding us in some respects of the quaint medieval writers, Froissart and Philippe de Comines, he greatly excels them, at once in the beauty of his language and the art with which he has combined his heterogeneous materials into a single perfect harmonious whole. See also GREECE, section *History*, "Authorities."

BIBLIOGRAPHY.—The history of Herodotus has been translated by many persons and into many languages. About 1450, at the time of the revival of learning, a Latin version was made and published by Laurentius Valla. This was revised in 1537 by Heusbach, and accompanies the Greek text of Herodotus in many editions. The first complete translation into a modern language was the English one of Littlebury, published in 1737. This was followed in 1786 by the French translation of Larcher, a valuable work, accompanied by copious notes and essays. Before the second English translator, based his work on that of Larcher. His first edition, in 1791, was confessedly very defective; the second, in 1806, still left much to be desired. A good German translation, but without note or comment, was brought out by Friedrich Lange at Berlin in 1811. Andrea Mustoxidi, a native of Corfu, published an Italian version in 1820. In 1822 Auguste Miot endeavoured to improve on Larcher; and in 1828-1832 Dr Adolf Schöll brought out a German translation with copious notes (new ed., 1855), which has to some extent superseded the work of Lange. About the same time a new English version was made by Isaac Taylor (London, 1829). In 1858-1860, the history of Herodotus was translated by Canon G. Rawlinson, assisted in the copious notes and appendices accompanying the work by Sir Gardner Wilkinson and Sir Henry Rawlinson. More recently we have translations in English by G. C. Macaulay (2 vols., 1890), in German by Bähr (Stuttgart, 1867) and Stein (Oldenburg, 1875); in French by Giguier (1857) and Talbot (1864), in Italian by Ricci (Turin, 1871-1876), Grandi (Asti, 1872) and Bertini (Naples, 1871-1872). A Swedish translation by F. Carlstedt was published at Stockholm in 1871.

The best of the older editions of the Greek text are the following:—*Herodoti historiae*, ed. Schweighäuser (5 vols., Strasburg, 1816); *Herodoti Halicarnassensis historiarum libri IX.* (ed. Gaisford, Oxford, 1840); *Herodotus, with a Commentary*, by J. W. Blakesley (2 vols., London, 1854); *Herodoti musae* (ed. Bähr, 4 vols., Leipzig, 1856-1861, 2nd ed.); and *Herodoti historiae* (ed. Abicht, Leipzig, 1869).

The most recent editions of the text, or of portions of it, with and without commentaries are the following:—H. Stein, *Herodoti historiae* (ed. Major, 2 vols., Berlin, 1869-1871, with *apparatus criticus*; still the best edition of the text); H. Kellenberg, *Historiarum libri IX.* (2 vols., Leipzig, 1887); van Herwerden, *Herodoti* (Leiden, 1885); H. Stein, *Herodotus, erklärt* (Berlin, 1856-1861, and several editions since: the best short commentary and introduction); A. H. Sayce, *The Ancient Empires of the East, Herodotus*

J.-III., with introductions and appendices (1883; an attempt to prove the unveracity of Herodotus, especially in regard to the extent of his travels, which has found little support amongst more recent English or German writers); R. W. Macan, *Herodotus IV-VI.* (2 vols., 1895) and *Herodotus VII-IX* (2 vols., 1908), with exhaustive introduction, appendices and notes; the only scientific edition of these books in English, E. Abbott, *Herodotus V. and VI.* (Oxford, 1891); A. Wiedemann, *Herodotus zweites Buch mit sachlichen Bemerkungen* (Leipzig, 1890; the best and fullest commentary on book ii.).

Among works of value illustrative of Herodotus may be mentioned Boubier, *Recherches sur Hérodote* (Dijon, 1746); Rennell, *Geography of Herodotus* (London, 1800); Niebuhr, *Geography of Herodotus and Scythia* (Eng. trans., Oxford, 1830); Dahlmann, *Herodotus aus seinem Buche sein Leben* (Altona, 1823); Eltz, *Questiones Herodoteae* (Leipzig, 1841); Kenrick, *Egypt of Herodotus* (London, 1841); Mure, *Literature of Greece*, vol. iv. (London, 1852); Abicht, *Übersicht über den Herodoteischen Dialekt* (Leipzig, 1869, 3rd ed., 1874), and *De codicum Herodoti fide ac auctoritate* (Naumburg, 1869); Melander, *De anacolutis Herodoteis* (Lund, 1869); Matsat, "Über die Glaubenswürdigkeit der geograph. Angaben Herodots über Asien," in *Hermes*, vi.; Bödinger, *Zur ägyptischen Forschung über Asien* (Vienna, 1873, reprinted in the *Sitzungsber.* of the Vienna Acad.); Merzdorf, *Questiones grammaticae de dialecto Herodoti* (Leipzig, 1875); A. Kirchhoff, *Über die Entstehungzeit der Herodotischen Geschichtswerke* (Berlin, 1878); Adolf Bauer, *Herodoti Biographie* (Vienna, 1878); H. Delbrück, *Perser und Burgunderkriege* (Berlin, 1887; of great importance for the criticism of the Persian Wars); N. Wecklein, *Über die Tradition der Perserkriege* (Munich, 1876); A. Hauvette-Besnault, *Hérodote historien des guerres médiques* (Paris, 1894); J. A. R. Munro, *Some Observations on the Persian Wars* (in various vols. of the *Journal of Hellenic Studies*; acute and suggestive); G. B. Grundy, *The Great Persian War* (London, 1901); J. P. Mahaffy, *History of Greek Classical Literature*, ii. 16 ff. (London, 1880); E. Meyer, *Forschungen zu allen Geschichte*, i. 151 ff., and ii. 196 ff. (Halle, 1892-1899); Busolt, *Griechische Geschichte*, ii. 602 ff. (2nd ed., Gotha, 1895); J. B. Bury, *Ancient Greek Historians* (1908), lecture 2. For notices of current literature see Bursian's *Jahresbericht*. Students of the original may also consult with advantage the lexicons of Aemilius Porcius (Oxford, 1817) and of Schweighäuser (London, 1824). On Herodotus' debt to Heracleus see Wells, in *Journ. Hell. Stud.*, 1909, pt. i. (G. R.; E. M. W.)

HÉROËT, ANTOINE, surnamed LA MAISON-NEUVE (d. 1568), French poet, was born in Paris of a family connected with the famous chancellor, François Olivier. His poetry belongs to his early years, for after he had taken orders he ceased to write profane poetry, no doubt because he considered it out of keeping with his calling, in which he attained the dignity of bishop of Digue. His chief work is *La Parfaite Amye* (Lyons, 1542) in which he developed the idea of a purely spiritual love, based chiefly on the reading of the Italian Neo-Platonists. The book aroused great controversy. La Borderie replied in *L'Amie de cour* with a description of a very much more human woman, and Charles Fontaine contributed a *Conte d'amyé de cour* to the dispute. Héroët, in addition to some translations from the classics, wrote the *Complainte d'une dame nouvellement surprise d'amour*, an *Épître à François I^{er}*, and some pieces included in the now very rare *Opuscules d'amour par Héroët, La Borderie et autres divins poètes* (Lyons, 1547). Héroët belongs to the Lyonnese school of which Maurice Scève may be regarded as the leader. Clément Marot praises him, and Ronsard was careful to exempt him with one or two others from the scorn he poured on his immediate predecessors.

See H. F. Cary, *The Early French Poets* (1846).

HEROIC ROMANCES, the name by which is distinguished a class of imaginative literature which flourished in the 13th century, principally in France. The beginnings of modern fiction in that country took a pseudo-bucolic form, and the celebrated *Astrée* (1610) of Honoré d'Urfé (1568-1625), which is the earliest French novel, is properly styled a pastoral. But this ingenious and diffuse production, in which all is artificial, was the source of a vast literature, which took many and diverse forms. Although its action was, in the main, languid and sentimental, there was a side of the *Astrée* which encouraged that extravagant love of glory, that spirit of "panache," which was now rising to its height in France. That spirit it was which animated Marin le Roy, sieur de Comberville (1600-1674), who was the inventor of what have since been known as the Heroical Romances. In these there was experienced a violent recrudescence of the old medieval elements of romance, the

impossible valour devoted to a pursuit of the impossible beauty, but the whole clothed in the language and feeling and atmosphere of the age in which the books were written. In order to give point to the chivalrous actions of the heroes, it was always hinted that they were well-known public characters of the day in a romantic disguise.

In the *Astrée* of Honoré d'Urfé, which was a pure pastoral, in the religious romances of Pierre Camus (1582-1653), in the comic *Fransion* of Charles Sorel, piquancy had been given to the recital by this belief that real personages could be recognized under the disguises. But in the *Carthés* of Gomberville (1621) we have a pastoral which is already beginning to be a heroic romance, and a book in which, under a travesty of Roman history, an appeal is made to an extravagantly chivalrous enthusiasm. A further development was seen in the *Polixène* (1623) of François de Molière, and the *Endymion* (1624) of Gombault; in the latter the elderly queen, Marie de' Medici, was celebrated under the disguise of Diana, for whom a beautiful shepherd of Caria (the author himself) nourishes a hopeless passion. The earliest of the Heroic Romances, pure and simple, is, however, the celebrated *Polexandre* (1629) of Gomberville. The author began by intending his hero to represent Louis XIII., but he changed his mind, and drew a portrait of Cardinal Richelieu. In this novel, for the first time, the romantic character proper to this class of books is seen undiluted; there is no intrusion of a personage who is not celebrated for his birth, his beauty or his exploits. The story deals with the adventures of a hero who visits all the sea-coasts of the world, the most remote as well as the most fabulous, in search of an ineffable princess, Alcidiande. This absurd and pretentious, yet very original piece of invention enjoyed an immense success, and historical romances of a similar class competed for the favour of the public. There was an equal amount of geography and more of ancient history in the *Ariane* (1632) of Desmarests de Saint-Sorlin (1595-1676), a book which, long neglected, has in late years been rediscovered, and which has been greeted by M. Paul Morillot as the most readable and the least tiresome of all the Heroic Romances. The type of that class of literature, however, has always been found in the highly elaborate writings of Gauthier de Coste de la Calprenède (1609-1663), which enjoyed for a time a prodigious celebrity, and were read and imitated all over Europe. La Calprenède was a Gascon soldier, imbued with all the extravagance of his race, and in full sympathy with the audacity and violence of the aristocratic society of France in his day. His *Cassandre*, which appeared in ten volumes between 1642 and 1645, is perhaps the most characteristic of all the Heroic Romances. It deals with a highly romantic epoch of ancient history, the decline of the empire of Alexander the Great. The wars of the Persians and of the Scythians are introduced, and among the characters are discovered such personages as Artaxerxes, Roxana and Ephestion. It must not be supposed, however, that la Calprenède makes the smallest effort to deal with the subject accurately or realistically. The figures are those of his own day; they are seigneurs and great ladies of the court of Louis XIII., masquerading in Macedonian raiment. The passion of love is dominant throughout, and it is treated in the most exalted and hyperbolic spirit. The central heroes of the story, Oroondate and Lysimachus, are dignified, eloquent and amorous; they undergo unexampled privations in the quest of incomparable ladies whose beauty and whose nobility is only equalled by their magnificent loyalty. These books were written with an aim that was partly didactic. Their object was to entertain the ladies and to gratify a taste for endlessly wire-drawn sentimentality, but it was also to teach fortitude and grandeur of soul and to inculcate lessons of practical chivalry. La Calprenède followed up the success of his *Cassandre* with a *Cléopâtre* (1647) in twelve volumes, and a *Faramond* (1661) which he did not live to finish. He became more extravagant, more rhapsodical as he proceeded, and he lost all the little hold on history which he had ever held. *Cléopâtre*, nevertheless, enjoyed a prodigious popularity, and it became the fashion to emulate as far as possible the prowess of its magnificent hero, the proud Artaban.

XIII. 8

It should be said that la Calprenède objected to his books being styled romances, and insisted that they were specimens of "history embellished with certain inventions." He may, in opposition to his wishes, claim the doubtful praise of being, in reality, the creator of the modern historical novel. He was immediately imitated or accompanied by a large number of authors, of whom two have achieved a certain immortality, which, unhappily, must be confessed to be partly of ridicule. The vogue of the historical romance was carried to its height by a brother and a sister, Georges de Scudéry (1601-1667) and Madeleine de Scudéry (1608-1701), who represented in their own persons all the extravagant, tempestuous and absurd elements of the age, and whose elephantine romances remain as portents in the history of literature. These novels—there are five of them—were signed by Georges de Scudéry, but it is believed that all were in the main written by Madeleine. The earliest was *Ibrahim, ou l'Illustre Bassa* (1641); it was followed by *Le Grand Cyrus* (1648-1653) and the final, and most posterous member of the series was *Clélie* (1649-1654). The romances of Mlle de Scudéry (for to her we may safely attribute them) are much inferior in style to those of la Calprenède. They are pretentious, affected and sickly. The author abuses the element of analysis, and pushes a psychology, which was beyond the age in penetration, to a wearisome and excessive extent. Nothing, it is probable, in the whole evolution of the Historical Romances has attracted so much attention as the "Carte de Tendre" which occurs in the opening book of *Clélie*. This celebrated map, drawn by the heroine in order to show the route from New Friendship to Tender, and a geographical symbol, therefore, of the progress of love, with its city of Tender-upon-Esteem, its sea of Enmity, its river of Inclination, its rock-built citadel of Pride, its cold lake of Indifference, is a miracle of elaborate and incongruous ingenuity. But, amusing as it is, it shows into what depths of puerility the amorous casuistry of these romances had fallen. These novels formed the chief topic of conversation and of correspondence in the literary society which gathered at and around the Hotel de Rambouillet, and in the personages of Mlle de Scudéry's romances could be recognized all the famous leaders of that society. The mawkish love-making and the false heroism of these monstrous novels went rapidly out of fashion in France soon after 1660, when the epoch of the Heroic Romance came to an end. In England the Heroic Romance had a period of flourishing popularity. All the principal French examples were very promptly translated, and "he was not to be admitted into the academy of wit who had not read *Astrée* and *The Grand Cyrus*." The great vogue of these books in England lasted from about 1645 to 1660. It led, of course, to the composition of original works in imitation of the French. The most remarkable and successful of these was *Parthenissa*, published in 1654 by Roger Boyle, Lord Broghill and afterwards Earl of Orrery (1621-1679), which was greatly admired by Dorothy Osborne and her correspondents. Addison speaks in the "Spectator" of the popularity of all these huge books, "the *Grand Cyrus*, with a pin stuck in one of the middle leaves, *Clélie*, which opened of itself in the place that describes two lovers in a bower." When the drama, and in particular tragedy, was reinstated in England, sentimental readers found a field for their emotions on the stage, and the heroic romances immediately began to go out of fashion. They lingered, however, for a quarter of a century more, and M. Jusserand has analysed what may be considered the very latest of the race, *Pandion and Amphigenia*, published in 1665 by the dramatist, John Crowne.

See Gordon de Percel, *De l'usage des romans* (1734); André Le Breton, *Le Roman au XVII^e siècle* (1890); Paul Morillot, *Le Roman en France depuis 1610* (1894); J. J. Jusserand, *Le Roman anglais au XVII^e siècle* (1888).

HEROIC VERSE, a term exclusively used in English to indicate the rhymed iambic line or HEROIC COUPLET. In ancient literature, the heroic verse, ἠρωικὸν μέτρον, was synonymous with the dactylic hexameter. It was in this measure that those typically heroic poems, the *Iliad* and *Odyssey* and the *Aeneid*.

were written. In English, however, it was not enough to designate a single iambic line of five beats as heroic verse, because it was necessary to distinguish blank verse from the distich, which was formed by the heroic couplet. This had escaped the notice of Dryden, when he wrote "The English Verse, which we call Heroic, consists of no more than ten syllables." If that were the case, then *Paradise Lost* would be written in heroic verse, which is not true. What Dryden should have said is "consists of two rhymed lines, each of ten syllables." In French the alexandrine has always been regarded as the heroic measure of that language. The dactylic movement of the heroic line in ancient Greek, the famous *ῥυθμὸς ἑξαπόδιος* of Homer is expressed in modern Europe by the iambic movement. The consequence is that much of the rush and energy of the antique verse, which at vigorous moments was like the charge of a battalion, is lost. It is owing to this, in part, that the heroic couplet is so often required to give, in translation, the full value of a single Homeric hexameter. It is important to insist that it is the couplet, not the single line, which constitutes heroic verse. It is interesting to note that the Latin poet Ennius, as reported by Cicero, called the heroic metre of one line *versum longum*, to distinguish it from the brevity of lyrical measures. The current form of English heroic verse appears to be the invention of Chaucer, who used it in his *Legend of Good Women* and afterwards, with still greater freedom, in the *Canterbury Tales*. Here is an example of it in its earliest development:—

"And thus the longè day in fight they spend,
Till, at the last, as ev'rything hath end,
Anton is shent, and put him to the flight,
And all his folk to go, as best go might."

This way of writing was misunderstood and neglected by Chaucer's English disciples, but was followed nearly a century later by the Scottish poet, called Blind Harry (c. 1475), whose *Wallace* holds an important place in the history of versification as having passed on the tradition of the heroic couplet. Another Scottish poet, Gavin Douglas, selected heroic verse for his translation of the *Aeneid* (1513), and displayed, in such examples as the following, a skill which left little room for improvement at the hands of later poets:—

"One sang, 'The ship sails over the salt foam,
Will bring the merchants and my leman home';
Some other sings, 'I will be blithe and light,
Mine heart is leant upon so goodly wight."

The verse so successfully mastered was, however, not very generally used for heroic purposes in Tudor literature. The early poets of the revival, and Spenser and Shakespeare after them, greatly preferred stanzaic forms. For dramatic purposes blank verse was almost exclusively used, although the French had adopted the rhymed alexandrine for their plays. In the earlier half of the 17th century, heroic verse was often put to somewhat unheroic purposes, mainly in prologues and epilogues, or other short poems of occasion; but it was nobly redeemed by Marlowe in his *Hero and Leander* and respectfully by Browne in his *Britannia's Pastorals*. It is to be noted, however, that those Elizabethans who, like Chapman, Warner and Drayton, aimed at producing a warlike and Homeric effect, did so in shuffling fourteen-syllable couplets. The one heroic poem of that age written at considerable length in the appropriate national metre is the *Bosworth Field* of Sir John Beaumont (1582-1628). Since the middle of the 17th century, when heroic verse became the typical and for a while almost the solitary form in which serious English poetry was written, its history has known many vicissitudes. After having been the principal instrument of Dryden and Pope, it was almost entirely rejected by Wordsworth and Coleridge, but revised, with various modifications, by Byron, Shelley (in *Julian and Maddalo*) and Keats (in *Lamia*). In the second half of the 19th century its prestige was restored by the brilliant work of Swinburne in *Tristram* and elsewhere. (E. G.)

HÉROLD, LOUIS JOSEPH FERDINAND (1791-1833), French musician, the son of François Joseph Hérold, an accomplished pianist, was born in Paris, on the 28th of January 1791. It was not till after his father's death that Hérold in 1806 entered the Paris conservatoire, where he studied under Catal and Méhul.

In 1812 he gained the grand prix de Rome with the cantata *La Duchesse de la Vallière*, and started for Italy, where he remained till 1815 and composed a symphony, a cantata and several pieces of chamber music. During his stay in Italy also Hérold for the first time ventured on the stage with the opera *La Gioventù di Enrico V.*, first performed at Naples in 1815 with moderate success. During a short stay in Vienna he was much in the society of Salieri. Returning to Paris he was invited by Boieldieu to collaborate with him on an opera called *Charles de France*, performed in 1816, and soon followed by Hérold's first French opera, *Les Rosières* (1817), which was received very favourably. Hérold produced numerous dramatic works for the next fifteen years in rapid succession. Only the names of some of the more important need here be mentioned:—*La Clochette* (1817), *L'Auteur mort et vivant* (1820), *Marie* (1826), and the ballets *La Fille mal gardée* (1828) and *La Belle au bois dormant* (1829). Hérold also wrote a vast quantity of pianoforte music, in spite of his time being much occupied by his duties as accompanist at the Italian opera in Paris. In 1831 he produced the romantic opera *Zampa*, and in the following year *Le Pré aux clercs* (first performance December 15, 1832), in which French *esprit* and French chivalry find their most perfect embodiment. These two operas secured immortality for the name of the composer, who died on the 18th of January 1833, of the lung disease from which he had suffered for many years, and the effects of which he had accelerated by incessant work. Hérold's incomplete opera *Ludovic* was afterwards printed by J. F. F. Halévy.

HERON (Fr. *héron*; Ital. *aghirone*, *airone*; Lat. *ardea*; Gr. *ἁρδιός*: A.-S. *hæra*; Icelandic, *hegre*; Swed. *häger*; Dan. *heire*; Ger. *Heiger*, *Reiher*, *Heergans*; Dutch, *reiger*), a long-necked, long-winged and long-legged bird; the typical representative of the group *Ardeidae*. It is difficult or even impossible to estimate with any accuracy the number of species of *Ardeidae* which exist. Professor Hermann Schlegel in 1863 enumerated 61, besides 5 of what he terms "conspicuous," as



FIG. 1.—Heron.

contained in the collection at Leyden (*Mus. des Pays-Bas*, *Ardeae*, 64 pp.),—on the other hand, G. R. Gray in 1871 (*Handlist*, &c. iii. 26-34) admitted above 90, while Dr Anton Reichenow (*Journ. für Ornithologie*, 1877, pp. 232-275) recognizes 67 as known, besides 15 "subspecies" and 3 varieties, arranging them in 3 genera, *Nycticorax*, *Botaurus* and *Ardea*, with 17 subgenera. But it is difficult to separate the family, with any satisfactory result, into genera, if structural characters have to be found for these groups, for in many cases they run almost insensibly into each other—though in common language it is easy to speak of herons, egrets, bitterns, night-herons and

boatbills. With the exception of the last, Professor Schlegel retains all in the genus *Ardea*, dividing it into eight sections, the names of which may perhaps be Englished—great herons, small herons, egrets, semi-egrets, rail-like herons, little bitterns, bitterns and night-herons.

The common heron of Europe, *Ardea cinerea* of Linnaeus, is universally allowed to be the type of the family, and it may also be regarded as that of Professor Schlegel's first section. The species inhabits suitable localities throughout the whole of Europe, Africa and Asia, reaching Japan, many of the islands of the Indian Archipelago and even Australia. Though by no means so numerous as formerly in Britain, it is still sufficiently common,¹ and there must be few persons who have not seen it rising slowly from some river-side or marshy flat, or passing overhead in its lofty and leisurely flight on its way to or from its daily haunts; while they are many who have been entertained by watching it as it sought its food, consisting chiefly of fishes (especially eels and foundlers) and amphibians—though young birds and small mammals come not amiss—wading midleg in the shallows, swimming occasionally when out of its depth, or standing motionless to strike its prey with its formidable and sure beak. When sufficiently numerous the heron breeds in societies, known as heronries, which of old time were protected both by law and custom in nearly all European countries, on account of the sport their tenants afforded to the falconer. Of late years, partly owing to the withdrawal of the protection they had enjoyed, and still more, it would seem, from agricultural improvement, which, by draining meres, fens and marshes, has abolished the feeding-places of a great population of herons, many of the larger heronries have broken up—the birds composing them dispersing to neighbouring localities and forming smaller settlements, most of which are hardly to be dignified by the name of heronry, though commonly accounted such. Thus the number of so-called heronries in the United Kingdom, and especially in England and Wales, has become far greater than formerly, but no one can doubt that the number of herons has dwindled. The sites chosen by the heron for its nest vary greatly. It is generally built in the top of a lofty tree, but not unfrequently (and this seems to have been much more usual in former days) near or on the ground among rough vegetation, on an island in a lake, or again on a rocky cliff of the coast. It commonly consists of a huge mass of sticks, often the accumulation of years, lined with twigs, and in it are laid from four to six sea-green eggs. The young are clothed in soft flax-coloured down, and remain in the nest for a considerable time, therein differing remarkably from the "pipers" of the crane, which are able to run almost as soon as they are hatched. The first feathers assumed by young herons in a general way resemble those of the adult, but the pure white breast, the black throat-streaks and especially the long pendent plumes, which characterize only the very old birds, and are most beautiful in the cocks, are subsequently acquired. The heron measures about 3 ft. from the bill to the tail, and the expanse of its wings is sometimes not less than 6 ft., yet it weighs only between 3 and 4 lb.

Large as is the common heron of Europe, it is exceeded in size by the great blue heron of America (*Ardea herodias*), which generally resembles it in appearance and habits, and both are smaller than the *A. sumatrana* or *A. typhon* of India and the Malay Archipelago, while the *A. goliath*, of wide distribution in Africa and Asia, is the largest of all. The purple heron, *A. purpurea*, as a well-known European species having a great range over the Old World, also deserves mention here. The species included in Professor Schlegel's second section inhabit the tropical parts of Africa, Australasia and America. The egrets, forming his third group, require more notice, distinguished as they are by their pure white plumage, and, when in breeding-dress, by

¹ In many parts of England it is generally called a "herner"—being a corruption of "heronewe," which, as Professor Skeat states (*Etymol. Dictionary*, p. 264), is a perfectly distinct word from "heronshaw," commonly confounded with it. The further corruption of "herner" into "handsaw," as in the well-known proverb, was easy in the mouth of men to whom hawking the heronewe was unfamiliar.

the beautiful dorsal tufts of decomposed feathers that ordinarily droop over the tail, and are so highly esteemed as ornaments by Oriental magnates. The largest species is *A. occidentalis*, only known apparently from Florida and Cuba; but one not much less, the great egret (*A. alba*), belongs to the Old World, breeding regularly in south-eastern Europe, and occasionally straying to Britain. A third, *A. egretta*, represents it in America, while much the same may be said of two smaller species, *A. garzetta*, the little egret of English authors, and *A. candidissima*; and a sixth, *A. intermedia*, is common in India, China and Japan, besides occurring in Australia. The group of semi-egrets, containing some nine or ten forms, among which the buff-backed heron (*A. bubulcus*), is the only species that is known to have occurred in Europe, is hardly to be distinguished from the last section except by their plumage being at certain seasons varied in some species with slaty-blue and in others with rufous. The rail-like herons form Professor Schlegel's next section, but it can scarcely be satisfactorily differentiated, and the epithet is misleading, for its members have no rail-like affinities, though the typical species,



FIG. 2.—Bittern.

which inhabits the south of Europe, and occasionally finds its way to England, has long been known as *A. ralloides*.² Nearly all these birds are tropical or subtropical. Then there is the somewhat better defined group of little bitterns, containing about a dozen species—the smallest of the whole family. One of them, *A. minuta*, though very local in its distribution, is a native of the greater part of Europe, and has bred in England. It has a close counterpart in the *A. exilis* of North America, and is represented by three or four forms in other parts of the world, the *A. pusilla* of Australia especially differing very slightly from it. Rangued by Professor Schlegel with these birds, which are all remarkable for their skulking habits, but more resembling the true herons in their nature, are the common green bittern of America (*A. virescens*) and its very near ally the African *A. alicapilla*, from which last it is almost impossible to distinguish the *A. javanica*, of wide range throughout Asia and its islands, while other species, less closely related, occur elsewhere as *A. flavicollis*—one form of which, *A. gouldi*, inhabits Australia.

The true bitterns, forming the genus *Botaurus* of most authors, seem to be fairly separable, but more perhaps on account of their wholly nocturnal habits and correspondingly adapted plumage than on strictly structural grounds, though some differences of proportion are observable. The common bittern (*q.v.*) of

² It is the "Squacco-Heron" of modern British authors—the distinctive name, given "Squacco" by Willughby and Ray from *Aldrovandus*, having been misappplied by Latham.

Europe (*B. stellaris*), is widely distributed over the eastern hemisphere.¹ Australia and New Zealand have a kindred species, *B. poeciloptilus*, and North America a third, *B. mugilans*² or *B. lentiginosus*. Nine other species from various parts of the world are admitted by Professor Schlegel, but some of them should perhaps be excluded from the genus *Botaurus*.

Of the night-herons the same author recognizes six species, all of which may be reasonably placed in the genus *Nycticorax*, characterized by a shorter beak and a few other peculiarities, among which the large eyes deserve mention. The first is *N. griseus*, a bird widely spread over the Old World, and not unfrequently visiting England, where it would undoubtedly breed if permitted. Professor Schlegel unites with it the common night-heron of America; but this, though very closely allied, is generally deemed distinct, and is the *N. naevius* or *N. gardeni* of most writers. A clearly different American species, with a more southern habitat, is the *N. violaceus* or *N. cayennensis*, while others are found in South America, Australia, some of the Asiatic Islands and in West Africa. The Galapagos have a peculiar species,



FIG. 3.—Boatbill.

N. pauper, and another, so far as is known, peculiar to Rodriguez, *N. megacephalus*, existed in that island at the time of its being first colonized, but is now extinct.

The boatbill, of which only one species is known, seems to be merely a night-heron with an exaggerated bill,—so much widened as to suggest its English name,—but has always been allowed generic rank. This curious bird, the *Cancroma cochlearia* of most authors, is a native of tropical America, and what is known of its habits shows that they are essentially those of a *Nycticorax*.³

Bones of the common heron and bittern are not uncommon in the peat of the East-Anglian fens. Remains from Sansan and Langy in France have been referred by Alphonse Milne-Edwards to herons under the names of *Ardea perplexa* and *A. formosa*; a tibia from the Miocene of Steinheim am Albuch by Dr Fraas to an *A. similis*, while Sir R. Owen recognized a portion of a sternum from the London Clay as most nearly approaching this family. It remains to say that the herons form part of Huxley's section *Pelargomorphae*, belonging to his larger group *Desmognathae*, and to draw attention to the singular development of the patches of "powder-down" which in the family *Ardeidae* attain a magnitude hardly to be found elsewhere. Their use is utterly unknown. (A. N.)

¹ The last-recorded instance of the bittern breeding in England was in 1868, as mentioned by Stevenson (*Birds of Norfolk*, ii. 164).

² Richardson, a most accurate observer, asserts (*Fauna Boreali-Americana*, ii. 374) that its booming (whence the epithet) exactly resembles that of its Old-World congener, but American ornithologists seem only to have heard the croaking note it makes when disturbed.

³ The very wonderful shoe-bird (*Balaeniceps*) has been regarded by many authorities as allied to *Cancroma*; but there can be little doubt that it is more nearly related to the genus *Scopus* belonging to the storks. The sun-bittern (*Eurypyga*) forms a family of itself, allied to the rails and tranes.

HERPES (from the Gr. ἑρπῆν, to creep), an inflammation of the true skin resulting from a lesion of the underlying nerve or its ganglion, attended with the formation of isolated or grouped vesicles of various sizes upon a reddened base. They contain a clear fluid, and either rupture or dry up. Two well-marked varieties of herpes are frequently met with. (a) In *herpes labialis et nasalis* the eruption occurs about the lips and nose. It is seen in cases of certain acute febrile ailments, such as fevers, inflammation of the lungs or even in a severe cold. It soon passes off. (b) In the *herpes zoster, zona* or "shingles" the eruption occurs in the course of one or more cutaneous nerves, often on one side of the trunk, but it may be on the face, limbs or other parts. It may occur at any age, but is probably more frequently met with in elderly people. The appearance of the eruption is usually preceded by severe stinging neuralgic pains for several days, and, not only during the continuance of the herpetic spots, but long after they have dried up and disappeared, these pains sometimes continue and give rise to great suffering. The disease seldom recurs. The most that can be done for its relief is to protect the parts with cotton wool or some dusting powder, while the pain may be allayed by opiates or bromide of potassium. Quinine internally is often of service.

HERRERA, FERNANDO DE (c. 1534–1597), Spanish lyrical poet, was born at Seville. Although in minor orders, he addressed many impassioned poems to the countess of Gelves, wife of Alvaro Colon de Portugal; but it is suggested that these should be regarded as Platonic literary exercises in the manner of Petrarch. As is shown by his *Anotaciones á las obras de Garcilaso de la Vega* (1580), Herrera had a boundless admiration for the Italian poets, and continued the work of Boscán in naturalizing the Italian metrical system in Spain. His commentary on Garcilaso involved him in a series of literary polemics, and his verbal innovations laid him open to attack. But, even if his amatory sonnets are condemned as insincere in sentiment, their workmanship is admirable, while his odes on the battle of Lepanto, on Don John of Austria, and the elegy on King Sebastian of Portugal entitle him to rank as the greatest of Andalusian poets and as the most important of the followers of Garcilaso de la Vega (see VEGA). His poems were published in 1582, and reprinted with additions in 1619; they are reissued in the *Biblioteca de autores españoles*, vol. xxxii. Of Herrera's prose works only the *Vida y muerte de Tomas Moro* (1592) survives; it is a translation of the life in Thomas Stapleton's *Tres Thomae* (1588).

BIBLIOGRAPHY.—E. Bourcier, "Les Sonnets de Fernando de Herrera," *Annales de la Faculté des Lettres de Bordeaux* (1891); *Fernando de Herrera, controversia sobre sus anotaciones á las obras de Garcilaso de la Vega* (Lisette, 1870); A. Morel-Fatio, *L'Hymne sur Lépante* (Paris, 1893).

HERRERA, FRANCISCO (1576–1656), surnamed el Viejo (the old), Spanish historical and fresco painter, studied under Luis Fernandez in Seville, his native city, where he spent most of his life. Although so rough and coarse in manners that neither scholar nor child could remain with him, the great talents of Herrera, and the promptitude with which he used them, brought him abundant commissions. He was also a skillful worker in bronze, an accomplishment that led to his being charged with coining base money. From this accusation, whether true or false, he sought sanctuary in the Jesuit college of San Hermenegildo, which he adorned with a fine picture of its patron saint, Philip IV., on his visit to Seville in 1624, having seen this picture, and learned the position of the artist, pardoned him at once, warning him, however, that such powers as his should not be degraded. In 1650 Herrera removed to Madrid, where he lived in great honour till his death in 1656. Herrera was the first to relinquish the timid Italian manner of the old Spanish school of painting, and to initiate the free, vigorous touch and style which reached such perfection in Velazquez, who had been for a short time his pupil. His pictures are marked by an energy of design and freedom of execution quite in keeping with his bold, rough character. He is said to have used very long brushes in his painting; and it is also said that, when pupils failed, his servant used to dash the colours on the canvas with a broom under his directions, and that he worked them up into his designs before they dried. The drawing

in his pictures is correct, and the colouring original and skilfully managed, so that the figures stand out in striking relief. What has been considered his best easel-work, the "Last Judgment," in the church of San Bernardo at Seville, is an original and striking composition, showing in its treatment of the nude how ill-founded the common belief was that Spanish painters, through ignorance of anatomy, understood only the draped figure. Perhaps his best fresco is that on the dome of the church of San Buenaventura; but many of his frescoes have perished, some by the effects of the weather and others by the artist's own carelessness in preparing his surfaces. He has, however, preserved several of his own designs in etchings. For his easel-works Herrera often chose such humble subjects as fairs, carnivals, ale-houses and the like.

His son FRANCISCO HERRERA (1622-1685), surnamed el Mozo (the young), was also an historical and fresco painter. Unable to endure his father's cruelty, the younger Herrera, seizing what money he could find, fled from Seville to Rome. There, instead of devoting himself to the antiquities and the works of the old Italian masters, he gave himself up to the study of architecture and perspective, with the view of becoming a fresco-painter. He did not altogether neglect easel-work, but became renowned for his pictures of still-life, flowers and fruit, and from his skill in painting fish was called by the Italians *Lo Spagnuolo degli pesci*. In later life he painted portraits with great success. He returned to Seville on hearing of his father's death, and in 1660 was appointed subdirector of the new academy there under Murillo. His vanity, however, brooked the superiority of no one; and throwing up his appointment he went to Madrid. There he was employed to paint a San Hermenegildo for the barefooted Carmelites, and to decorate in fresco the roof of the choir of San Felipe el Real. The success of this last work procured for him a commission from Philip IV. to paint in fresco the roof of the Atocha church. He chose as his subject for this the Assumption of the Virgin. Soon afterwards he was rewarded with the title of painter to the king, and was appointed superintendent of the royal buildings. He died at Madrid in 1685. Herrera el Mozo was of a somewhat similar temperament to his father, and offended many people by his inordinate vanity and suspicious jealousy. His pictures are inferior to the older Herrera's both in design and in execution; but in some of them traces of the vigour of his father, who was his first teacher, are visible. He was by no means an unskilful colourist, and was especially master of the effects of chiaroscuro. As his best picture Sir Edmund Head in his *Handbook* names his "San Francisco," in Seville Cathedral. An elder brother, known as Herrera el Rubio (the ruddy), who died very young, gave great promise as a painter.

HERRERA Y TORDESILLAS, ANTONIO DE (1549-1625), Spanish historian, was born at Cuellar, in the province of Segovia in Spain. His father, Roderigo de Tordesillas, and his mother, Agnes de Herrera, were both of good family. After studying for some time in his native country, Herrera proceeded to Italy, and there became secretary to Vespasian Gonzago, with whom, on his appointment as viceroy of Navarre, he returned to Spain. Gonzago, sensible of his secretary's abilities, commended him to Philip II. of Spain; and that monarch appointed Herrera first historiographer of the Indies, and one of the historiographers of Castile. Placed thus in the enjoyment of an ample salary, Herrera devoted the rest of his life to the pursuit of literature, retaining his offices until the reign of Philip IV., by whom he was appointed secretary of state very shortly before his death, which took place at Madrid on the 29th of March 1625. Of Herrera's writings, the most valuable is his *Historia general de los hechos de los Castellanos en las islas y tierra firme del Mar Oceano* (Madrid, 1601-1615, 4 vols.), a work which relates the history of the Spanish-American colonies from 1492 to 1554. The author's official position gave him access to the state papers and to other authentic sources not attainable by other writers, while he did not scruple to borrow largely from other MSS., especially from that of Bartolomé de Las Casas. He used his facilities carefully and judiciously; and the result is a work on the whole accurate and unprejudiced, and quite indispensable to the student either of the history of the early colonies, or of the

institutions and customs of the aboriginal American peoples. Although it is written in the form of annals, mistakes are not wanting, and several glaring anachronisms have been pointed out by M. J. Quintana. "If," to quote Dr Robertson, "by attempting to relate the various occurrences in the New World in a strict chronological order, the arrangement of events in his work had not been rendered so perplexed, disconnected and obscure that it is an unpleasant task to collect from different parts of his book and piece together the detached shreds of a story, he might justly have been ranked among the most eminent historians of his country." This work was republished in 1730, and has been translated into English by J. Stevens (London, 1740), and into other European languages.

Herrera's other works are the following: *Historia de lo sucedido en Escocia e Inglaterra en quarenta y quatro años que vivió la reyna Maria Estuarda* (Madrid, 1589); *Cinco libros de la historia de Portugal, y conquista de las islas de los Açores, 1582-1583* (Madrid, 1591); *Historia de lo sucedido en Francia, 1585-1594* (Madrid, 1598); *Historia general del mundo del tiempo del rey Felipe II, desde 1559 hasta su muerte* (Madrid, 1601-1612, 3 vols.); *Tratado, relacion, y discurso historico de los movimientos de Aragon* (Madrid, 1612); *Comentarios de los hechos de los Españoles, Franceses, y Venecianos en Italia, &c., 1281-1550* (Madrid, 1624, seq.). See W. H. Prescott, *History of the Conquest of Mexico*, vol. II.

HERRICK, ROBERT (1591-1634), English poet, was born at Cheapside, London, and baptized on the 24th of August 1591. He belonged to an old Leicestershire family which had settled in London. He was the seventh child of Nicholas Herrick, goldsmith, of the city of London, who died in 1592, under suspicion of suicide. The children were brought up by their uncle, Sir William Herrick, one of the richest goldsmiths of the day, to whom in 1607 Robert was bound apprentice. He had probably been educated at Westminster school, and in 1614 he proceeded to Cambridge; and it was no doubt during his apprenticeship that the young poet was introduced to that circle of wits which he was afterwards to adorn. He seems to have been present at the first performance of *The Alchemist* in 1610, and it was probably about this time that Ben Jonson adopted him as his poetical "son." He entered the university as fellow-commoner of St John's College, and he remained there until, in 1616, upon taking his degree, he removed to Trinity Hall. A lively series of fourteen letters to his uncle, mainly begging for money, exists at Beaumanoir, and shows that Herrick suffered much from poverty at the university. He took his B.A. in 1617, and in 1620 he became master of arts. From this date until 1627 we entirely lose sight of him; it has been variously conjectured that he spent these years preparing for the ministry at Cambridge, or in much looser pursuits in London. In 1629 (September 30) he was presented by the king to the vicarage of Dean Prior, not far from Totnes in Devonshire. At Dean Prior he resided quietly until 1648, when he was ejected by the Puritans. The solitude there oppressed him at first; the village was dull and remote, and he felt very bitterly that he was cut off from all literary and social associations; but soon the quiet existence in Devonshire soothed and delighted him. He was pleased with the rural and semi-pagan customs that survived in the village, and in some of his most charming verses he has immortalized the morris-dances, wakes and quintains, the Christmas mummers and the Twelfth Night revellings, that diversified the quiet of Dean Prior. Herrick never married, but lived at the vicarage surrounded by a happy family of pets, and tended by an excellent old servant named Prudence Baldwin. His first appearance in print was in some verses he contributed to *A Description of the King and Queen of Fairies*, in 1635. In 1650 a volume of *Wit's Recreations* contained sixty-two small poems afterwards acknowledged by Herrick in the *Hesperides*, and one not reprinted until our own day. These partial appearances make it probable that he visited London from time to time. We have few hints of his life as a clergyman. Anthony Wood says that Herrick's sermons were florid and witty, and that he was "beloved by the neighbouring gentry." A very aged woman, one Dorothy King, stated that the poet once threw his sermon at his congregation, cursing them for their inattention. The same old woman recollected his favourite pig, which he taught to drink out of a tankard. He

was a devotedly loyal supporter of the king during the Civil War, and immediately upon his ejection in 1648 he published his celebrated collection of lyrical poems, entitled *Hesperides; or the Works both Human and Divine of Robert Herrick*. The "divine works" bore the title of *Noble Numbers* and the date 1647. That he was reduced to great poverty in London has been stated, but there is no evidence of the fact. In August 1662 Herrick returned to Dean Prior, supplanting his own supplanter, Dr John Syms. He died in his eighty-fourth year, and was buried at Dean Prior, October 15, 1674. A monument was erected to his memory in the parish church in 1857, by Mr Perry Herrick, a descendant of a collateral branch of the family. The *Hesperides* (and *Noble Numbers*) is the only volume which Herrick published, but he contributed poems to *Lachrymæ Musarum* (1649) and to *Wil's Recreations*.

As a pastoral lyrist Herrick stands first among English poets. His genius is limited in scope, and comparatively unambitious, but in its own field it is unrivalled. His tiny poems—and of the thirteen hundred that he has left behind him not one is long—are like jewels of various value, heaped together in a casket. Some are of the purest water, radiant with light and colour, some were originally set in false metal that has tarnished, some were rude and repulsive from the first. Out of the unarranged, heterogeneous mass the student has to select what is not worth reading, but, after he has cast aside all the rubbish, he is astonished at the amount of excellent and exquisite work that remains. Herrick has himself summed up, very correctly, the themes of his sylvan muse when he says:—

"I sing of brooks, of blossoms, birds and bowers,
Of April, May, of June and July flowers,
I sing of May-poles, hock-carts, wassails, wakes,
Of bridegrooms, brides and of their bridal-cakes."

He saw the picturesqueness of English homely life as no one before him had seen it, and he described it in his verse with a certain purple glow of Arcadian romance over it, in tones of immortal vigour and freshness. His love poems are still more beautiful; the best of them have an ardour and tender sweetness which give them a place in the forefront of modern lyrical poetry, and remind us of what was best in Horace and in the poets of the Greek anthology.

After suffering complete extinction for more than a century, the fame of Herrick was revived by John Nichols, who introduced his poems to the readers of the *Gentleman's Magazine* of 1796 and 1797. Dr Drake followed in 1798 with considerable enthusiasm. By 1810 interest had so far revived in the forgotten poet that Dr Nott ventured to print a selection from his poems, which attracted the favourable notice of the *Quarterly Review*. In 1823 the *Hesperides* and the *Noble Numbers* were for the first time edited by Mr T. Maitland, afterwards Lord Dundrennan. Since then the reprints of Herrick's have been too numerous to be mentioned here; there are few English poets of the 17th century whose writings are now more accessible. See F. W. Moorman, *Robert Herrick* (1910). (E. G.)

HERRIES, JOHN CHARLES (1778–1855), English politician, son of a London merchant, began his career as a junior clerk in the treasury, and became known for his financial abilities as private secretary to successive ministers. He was appointed commissary-in-chief (1811), and, on the abolition of that office (1816), auditor of the civil list. In 1823 he entered parliament as secretary to the treasury, and in 1827 became chancellor of the exchequer under Lord Goderich; but in consequence of internal differences, arising partly out of a slight put upon Herries, the ministry was broken up, and in 1828 he was appointed master of the mint. In 1830 he became president of the board of trade, and for the earlier months of 1835 he was secretary at war. From 1841 to 1847 he was out of parliament, but during 1852 he was president of the board of control under Lord Derby. He was a consistent and upright Tory of the old school, who carried weight as an authority on financial subjects. His eldest son, **SIR CHARLES JOHN HERRIES** (1815–1882), was chairman of the board of inland revenue.

See the *Life* by his younger son, Edward Herries (1880).

HERRIES, JOHN MAXWELL, 4TH LORD (c. 1512–1583), Scottish politician, was the second son of Robert Maxwell, 4th Lord Maxwell (d. 1546). In 1547 he married Agnes (d. 1594),

daughter of William Herries, 3rd Lord Herries (d. 1543), a grandson of Herbert Herries (d. c. 1500) of Terregles, Kirkcudbrightshire, who was created a lord of the Scottish parliament about 1490, and in 1567 he obtained the title of Lord Herries. But before this event Maxwell had become prominent among the men who rallied round Mary queen of Scots, although during the earlier part of his public life he had been associated with the religious reformers and had been imprisoned by the regent, Mary of Lorraine. He was, moreover—at least until 1563—very friendly with John Knox, who calls him "a man zealous and stout in God's cause." But the transition from one party to the other was gradually accomplished, and from March 1566, when Maxwell joined Mary at Dunbar after the murder of David Rizzio and her escape from Holyrood, he remained one of her staunchest friends, although he disliked her marriage with Bothwell. He led her cavalry at Langside, and after this battle she committed herself to his care. Herries rode with the queen into England in May 1568, and he and John Lesley, bishop of Ross, were her chief commissioners at the conferences at York. He continued to labour in Mary's cause after returning to Scotland, and was imprisoned by the regent Murray; he also incurred Elizabeth's displeasure by harbouring the rebel Leonard Dacres, but he soon made his peace with the English queen. He showed himself in general hostile to the regent Morton, but he was among the supporters of the regent Lennox until his death on the 20th of January 1583. His son William, 5th Lord Herries (d. 1604), was, like his father, warden of the west marches.

William's grandson John, 7th Lord Herries (d. 1677), became 3rd earl of Nithsdale in succession to his cousin Robert Maxwell, the 2nd earl, in 1667. John's grandson was William, 5th earl of Nithsdale, the Jacobite (see NITHSDALE). William was deprived of his honours in 1716, but in 1858 the House of Lords decided that his descendant William Constable-Maxwell (1804–1876) was rightly Lord Herries of Terregles. In 1876 William's son Marmaduke Constable-Maxwell (b. 1837) became 12th Lord Herries, and in 1884 he was created a baron of the United Kingdom.

HERRING (*Clupea harengus*, *Haring* in German, *le hareng* in French, *sill* in Swedish), a fish belonging to the genus *Clupea*, of which more than sixty different species are known in various parts of the globe. The sprat, pilchard or sardine and shad are species of the same genus. Of all sea-fishes *Clupeae* are the most abundant; for although other genera may comprise a greater variety of species, they are far surpassed by *Clupea* with regard to the number of individuals. The majority of the species of *Clupea* are of greater or less utility to man; it is only a few tropical species that acquire, probably from their food, highly poisonous properties, so as to be dangerous to persons eating them. But no other species equals the common herring in importance as an article of food or commerce. It inhabits in incredible numbers the North Sea, the northern parts of the Atlantic and the seas north of Asia. The herring inhabiting the corresponding latitudes of the North Pacific is another species, but most closely allied to that of the eastern hemisphere. Formerly it was the general belief that the herring inhabits the open ocean close to the Arctic Circle, and that it migrates at certain seasons towards the northern coasts of Europe and America. This view has been proved to be erroneous, and we know now that this fish lives throughout the year in the vicinity of our shores, but at a greater depth, and at a greater distance from the coast, than at the time when it approaches land for the purpose of spawning.

Herrings are readily recognized and distinguished from the other species of *Clupea* by having an ovate patch of very small teeth on the vomer (that is, the centre of the palate). In the dorsal fin they have from 17 to 20 rays, and in the anal fin from 16 to 18; there are from 53 to 59 scales in the lateral line and 54 to 56 vertebrae in the vertebral column. They have a smooth gill-cover, without those radiating ridges of bone which are so conspicuous in the pilchard and other *Clupeae*. The sprat cannot be confounded with the herring, as it has no teeth on the vomer and only 47 or 48 scales in the lateral line.

The spawn of the herring is adhesive, and is deposited on

rough gravelly ground at varying distances from the coast and always in comparatively shallow water. The season of spawning is different in different places, and even in the same district, e.g. the east coast of Scotland, there are herrings spawning in spring and others in autumn. These are not the same fish but different races. Those which breed in winter or spring deposit their spawn near the coast at the mouths of estuaries, and ascend the estuaries to a considerable distance at certain times, as in the Firths of Forth and Clyde, while those which spawn in summer or autumn belong more to the open sea, e.g. the great shoals that visit the North Sea annually.

Herrings grow very rapidly; according to H. A. Meyer's observations, they attain a length of from 17 to 18 mm. during the first month after hatching, 34 to 36 mm. during the second, 45 to 50 mm. during the third, 55 to 61 mm. during the fourth, and 65 to 72 mm. during the fifth. The size which they finally attain and their general condition depend chiefly on the abundance of food (which consists of crustaceans and other small marine animals), on the temperature of the water, on the season at which they have been hatched, &c. Their usual size is about 12 in., but in some particularly suitable localities they grow to a length of 15 in., and instances of specimens measuring 17 in. are on record. In the Baltic, where the water is gradually losing its saline constituents, thus becoming less adapted for the development of marine species, the herring continues to exist in large numbers, but as a dwarfed form, not growing either to the size or to the condition of the North-Sea herring. The herring of the American side of the Atlantic is specifically identical with that of Europe. A second species (*Clupea leachii*) has been supposed to exist on the British coast; but it comprises only individuals of a smaller size, the produce of an early or late spawn. Also the so-called "white-bait" is not a distinct species, but consists chiefly of the fry or the young of herrings and sprats, and is obtained "in perfection" at localities where these small fishes find an abundance of food, as in the estuary of the Thames.

Several excellent accounts of the herring have been published, as by Valenciennes in the 20th vol. of the *Histoire naturelle des poissons*, and more especially by Mr J. M. Mitchell, *The Herring, its Natural History and National Importance* (Edinburgh, 1864). Recent investigations are described in the *Reports of the Fishery Board for Scotland*, and in the reports of the German *Kommission zur Untersuchung der Deutschen Meere* (published at Kiel). (J. T. C.)

HERRING-BONE, a term in architecture applied to alternate courses of bricks or stone, which are laid diagonally with binding courses above and below: this is said to give a better bond to the wall, especially when the stone employed is stratified, such as Stonefield stone, and too thin to be laid in horizontal courses. Although it is only occasionally found in modern buildings, it was a type of construction constantly employed in Roman, Byzantine and Romanesque work, and in the latter is regarded as a test of very early date. It is frequently found in the Byzantine walls in Asia Minor, and in Byzantine churches was employed decoratively to give variety to the wall surface. Sometimes the diagonal courses are reversed one above the other. Examples in France exist in the churches at Querqueville in Normandy and St Christophe at Suèvres (Loir et Cher), both dating from the 10th century, and in England herring-bone masonry is found in the walls of castles, such as at Guildford, Colchester and Tamworth. The term is also applied to the paving of stable yards with bricks laid flat diagonally and alternating so that the head of one brick butts against the side of another; and the effect is more pleasing than when laid in parallel courses.

HERRINGS, BATTLE OF THE, the name applied to the action of Rouvray, fought in 1429 between the French (and Scots) and the English, who, under Sir John Falstolfe (or Falstaff), were convoying Lenten provisions, chiefly herrings, to the besiegers of Orleans. (See ORLEANS and HUNDRED YEARS' WAR.)

HERRNHUT, a town of Germany, in the kingdom of Saxony, 18 m. S.E. of Bautzen, and situated on the Löbau-Zittau railway. Pop. 1200. It is chiefly known as the principal seat of the Moravian or Bohemian brotherhood, the members of which

are called *Herrnhuter*. A colony of these people, fleeing from persecution in Moravia, settled at Herrnhut in 1722 on a site presented by Count Zinzendorf. The buildings of the society include a church, a school and houses for the brethren, the sisters and the widowed of both sexes, while it possesses an ethnographical museum and other collections of interest. The town is remarkable for its ordered, regular life and its scrupulous cleanliness. Linen, paper (to varieties of which Herrnhut gives its name), tobacco and various minor articles are manufactured. The Hutberg, at the foot of which the town lies, commands a pleasant view. Bertheisdorf, a village about a mile distant, has been the seat of the directorate of the community since about 1789.

HERSCHEL, CAROLINE LUCRETIA (1750-1848), English astronomer, sister of Sir William Herschel, the eighth child and fourth daughter of her parents, was born at Hanover on the 16th of March 1750. On account of the prejudices of her mother, who did not desire her to know more than was necessary for being useful in the family, she received in youth only the first elements of education. After the death of her father in 1767 she obtained permission to learn millinery and dressmaking with a view to earning her bread, but continued to assist her mother in the management of the household until the autumn of 1772, when she joined her brother William, who had established himself as a teacher of music at Bath. At once she became a valuable co-operator with him both in his professional duties and in the astronomical researches to which he had already begun to devote all his spare time. She was the principal singer at his oratorio concerts, and acquired such a reputation as a vocalist that she was offered an engagement for the Birmingham festival, which, however, she declined. When her brother accepted the office of astronomer to George III., she became his constant assistant in his observations, and also executed the laborious calculations which were connected with them. For these services she received from the king in 1787 a salary of £50 a year. Her chief amusement during her leisure hours was sweeping the heavens with a small Newtonian telescope. By this means she detected in 1783 three remarkable nebulae, and during the eleven years 1786-1797 eight comets, five of them with unquestioned priority. In 1797 she presented to the Royal Society an Index to Flamsteed's observations, together with a catalogue of 561 stars accidentally omitted from the "British Catalogue," and a list of the errata in that publication. Though she returned to Hanover in 1822 she did not abandon her astronomical studies, and in 1828 she completed the reduction, to January 1800, of 2500 nebulae discovered by her brother. In 1828 the Astronomical Society, to mark their sense of the benefits conferred on science by such a series of laborious exertions, unanimously resolved to present her with their gold medal, and in 1835 elected her an honorary member of the society. In 1846 she received a gold medal from the king of Prussia. She died on the 9th of January 1848.

See *The Memoir and Correspondence of Caroline Herschel*, by Mrs John Herschel (1876).

HERSCHEL, SIR FREDERICK WILLIAM (1738-1822), generally known as Sir William Herschel, English astronomer, was born at Hanover on the 15th of November 1738. His father was a musician employed as hautboy player in the Hanoverian guard. The family had quitted Moravia for Saxony in the early part of the 17th century on account of religious troubles, they themselves being Protestants. Herschel's earlier education was necessarily of a very limited character, chiefly owing to the warlike commotions of his country; but being at all times an indomitable student, he, by his own exertions, more than repaired this deficiency. He became a very skilful musician, both theoretical and practical; while his attainments as a self-taught mathematician were fully adequate to the prosecution of those branches of astronomy which he so eminently advanced and adorned. Whatever he did he did methodically and thoroughly; and in this methodical thoroughness lay the secret of what Arago very properly termed his astonishing scientific success.

In 1752, at the age of fourteen, he joined the band of the Hanoverian guard, and with his detachment visited England in 1755, accompanied by his father and eldest brother; in the following year he returned to his native country; but the hardships of campaigning during the Seven Years' War imperiling his health, his parents privately removed him from the regiment, and on the 26th of July 1757 despatched him to England. There, as might have been expected, the earlier part of his career was attended with formidable difficulties and much privation. We find him engaged in several towns in the north of England as organist and teacher of music, which were not lucrative occupations. But the tide of his fortunes began to flow when he obtained in 1766 the appointment of organist to the Octagon chapel in Bath, at that time the resort of the wealth and fashion of the city.

During the next five or six years he became the leading musical authority, and the director of all the chief public musical entertainments at Bath. His circumstances having thus become easier, he revisited Hanover for the purpose of bringing back with him his sister Caroline, whose services he much needed in his multifarious undertakings. She arrived in Bath in August 1772, being at that time in her twenty-third year. She thus describes her brother's life soon after her arrival: "He used to retire to bed with a bason of milk or a glass of water, with Smith's *Harmonics* and Ferguson's *Astronomy*, &c., and so went to sleep buried under his favourite authors; and his first thoughts on waking were how to obtain instruments for viewing those objects himself of which he had been reading." It is not without significance that we find him thus reading Smith's *Harmonics*; to that study loyalty to his profession would impel him; as a reward for his thoroughness this led him to Smith's *Optics*; and this, by a natural sequence, again led him to astronomy, for the purposes of which the chief optical instruments were devised. It was in this way that he was introduced to the writings of Ferguson and Keill, and subsequently to those of Lalande, whereby he educated himself to become an astronomer of undying fame. In those days telescopes were very rare, very expensive and not very efficient, for the Dollonds had not as yet perfected even their beautiful little achromatics of $2\frac{1}{2}$ in. aperture. So Herschel was obliged to content himself with hiring a small Gregorian reflector of about 2 in. aperture, which he had seen exposed for loan in a tradesman's shop. Not satisfied with this implement, he procured a small lens of about 18 ft. focal length, and set his sister to work on a pasteboard tube to match it, so as to make him a telescope. This unsatisfactory material was soon replaced by tin, and thus a sorry sort of vision was obtained of Jupiter, Saturn and the moon. He then sought in London for a reflector of much larger dimensions; but no such instrument was on sale; and the terms demanded for the construction of a reflecting telescope of 5 or 6 ft. focal length he regarded as too exorbitant even for the gratification of such desires as his own. So he was driven to the only alternative that remained; he must himself build a large telescope. His first step in this direction was to purchase the debris of an amateur's implements for grinding and polishing small mirrors; and thus, by slow degrees, and by indomitable perseverance, he in 1774 had, as he says, the satisfaction of viewing the heavens with a Newtonian telescope of 6 ft. focal length made by his own hands. But he was not contented to be a mere star-gazer; on the contrary, he had from the very first conceived the gigantic project of surveying the entire heavens, and, if possible, of ascertaining the plan of their general structure by a settled mode of procedure, if only he could provide himself with adequate instrumental means. For this purpose he, his brother and his sister toiled for many years at the grinding and polishing of hundreds of specula, always retaining the best and recasting the others, until the most perfect of the earlier products had been surpassed. This was the work of the daylight in those seasons of the year when the fashionable visitors of Bath had quitted the place, and had thus freed the family from professional duties. After 1774 every available hour of the night was devoted to the long-hoped-for scrutiny of the skies. In those days no machinery had been

invented for the construction of telescopic mirrors; the man who had the hardihood to undertake polishing them doomed himself to walk leisurely and uniformly round an upright post for many hours, without removing his hands from the mirror, until his work was done. On these occasions Herschel received his food from the hands of his faithful sister. But his reward was nigh.

In May 1780 his first two papers containing some results of his observations on the variable star "Mira" and the mountains of the moon were communicated to the Royal Society through the influential introduction of Dr William Watson. Herschel had made his acquaintance in a characteristic manner. In order to obtain a sight of the moon the astronomer had taken his telescope into the street opposite his house; the celebrated physician happening to pass at the time, and seeing his eye removed for a moment from the instrument, requested permission to take his place. The mutual courtesies and intelligent conversation which ensued soon ripened this casual acquaintance into a solid and enduring regard.

The phenomena of variable stars were examined by Herschel as a guide to what might be occurring in our own sun. The sun, he knew, rotated on its axis, and he knew that dark spots often exist on its photosphere; the questions that he put to himself were—Are there dark spots also on variable stars? Do the stars also rotate on their axes? or are they sometimes partially eclipsed by the intervention of opaque bodies? And he went on to enquire, What are these singular spots upon the sun? and have they any practical relation to the inhabitants of this planet? To these questions he applied his telescopes and his thoughts; and he communicated the results to the Royal Society in no less than six memoirs, occupying very many pages in the *Philosophical Transactions*, and extending in date from 1780 to 1801. It was in the latter year that these remarkable papers culminated in the inquiry whether any relation could be traced in the recurrence of sun-spots, regarded as evidences of solar activity, and the varying seasons of our planet, as exhibited by the varying price of corn. Herschel's reply was inconclusive; nor has a final solution of the related problems yet been obtained.

In 1781 he communicated to the Royal Society the first of a series of papers on the rotation of the planets and of their several satellites. The object which he had in view was not so much to ascertain the times of their rotation as to discover whether those rotations are strictly uniform. From the result he expected to gather, by analogy, the probability of an alteration in the length of our own day. These inquiries occupy the greater part of seven memoirs extending from 1781 to 1797. While engaged on them he noticed the curious appearance of a white spot near to each of the poles of the planet Mars. On investigating the inclination of its axis to the plane of its orbit, and finding that it differed little from that of the earth, he concluded that its changes of climate also would resemble our own, and that these white patches were probably polar snow. Modern researches have confirmed his conclusion. He also discovered that, as far as his observations extended, the times of the rotations of the various satellites round their axes conform to the analogy of our moon by equalling the times of their revolution round their primaries. Here again we perceive that his discoveries arose out of the systematic and comprehensive nature of his investigation. Nothing with such a man is accidental.

In the same year (1781) Herschel made a discovery which completely altered the character of his professional life. In the course of a methodical review of the heavens he lighted on an object which at first he supposed to be a comet, but which, by its subsequent motions and appearance, averred itself to be a new planet, moving outside the orbit of Saturna. The name of Georgium Sidus was by him assigned to it, but has by general consent been laid aside in favour of Uranus. The object was detected with a 7-ft. reflector having an aperture of 6 $\frac{1}{4}$ in.; subsequently, when he had provided himself with a much more powerful telescope, of 20 ft. focal length, he discovered, as he believed, no less than six Uranian satellites. Modern observations, while abolishing four of these supposed attendants, have added two others apparently not observed by Herschel. Seven memoirs

on the subject were communicated by him to the Royal Society, extending from the date of the discovery in 1781 to 1815. A noteworthy peculiarity in Herschel's mode of observation led to the discovery of this planet. He had observed that the spurious diameters of stars are not much affected by increasing the magnifying powers, but that the case is different with other celestial objects; hence if anything in his telescopic field struck him as unusual in aspect, he immediately varied the magnifying power in order to decide its nature. Thus Uranus was discovered; and had a similar method been applied to Neptune, that planet would have been found at Cambridge some months before it was recognized at Berlin.

We now come to the beginning of Herschel's most important series of observations, culminating in what ought probably to be regarded as his capital discovery. A material part of the task which he had set himself embraced the determination of the relative distances of the stars from our sun and from each other. Now, in the course of his scrutiny of the heavens, he had observed many stars in apparently very close contiguity, but often differing greatly in relative brightness. He concluded that, on the average, the brighter star would be the nearer to us, the smaller enormously more distant; and considering that an astronomer on the earth, in consequence of its immense orbital displacement of some 180 millions of miles every six months, would see such a pair of stars under different perspective aspects, he perceived that the measurement of these changes should lead to an approximate determination of the stars' relative distances. He therefore mapped down the places and aspects of all the double stars that he met with, and communicated in 1782 and 1785 very extensive catalogues of the results. Indeed, his very last scientific memoir, sent to the Royal Astronomical Society in the year 1822, when he was its first president and already in the eighty-fourth year of his age, related to these investigations. In the memoir of 1782 he threw out the hint that these apparently contiguous stars might be genuine pairs in mutual revolution; but he significantly added that the time had not yet arrived for settling the question. Eleven years afterwards (1793), he re-measured the relative positions of many such couples, and we may conceive what his feelings must have been at finding his prediction verified. For he ascertained that some of these stars circulated round each other, after the manner required by the laws of gravitation, and thus demonstrated the action among the distant members of the starry firmament of the same mechanical laws which bind together the harmonious motions of our solar system. This sublime discovery, announced in 1802, would of itself suffice to immortalize his memory. If only he had lived long enough to learn the approximate distances of some of these binary combinations, he would at once have been able to calculate their masses relative to that of our own sun; and the quantities being, as we now know, strictly comparable, he would have found another of his analogical conjectures realized.

In the year 1782 Herschel was invited to Windsor by George III., and accepted the king's offer to become his private astronomer, and henceforth devote himself wholly to a scientific career. His salary was fixed at £200 per annum, to which an addition of £50 per annum was subsequently made for the astronomical assistance of his sister. Dr Watson, to whom alone the amount was mentioned, made the natural remark, "Never before was honour purchased by a monarch at so cheap a rate." In this way the great astronomer removed from Bath, first to Datchet and soon afterwards permanently to Slough, within easy access of his royal patron at Windsor.

The old pursuits at Bath were soon resumed at Slough, but with renewed vigour and without the former professional interruptions. The greater part, in fact, of the papers already referred to are dated from Datchet and Slough; for the magnificent astronomical speculations in which he was engaged, though for the most part conceived in the earlier portion of his philosophical career, required years of patient observation before they could be fully examined and realized.

It was at Slough in 1783 that he wrote his first memorable paper on the "Motion of the Solar System in Space,"—a sublime

speculation, yet through his genius realized by considerations of the utmost simplicity. He returned to the same subject with fuller details in 1805. It was also after his removal to Slough that he published his first memoir on the construction of the heavens, which from the first had been the inspiring idea of his varied toils. In a long series of remarkable papers, addressed as usual to the Royal Society, and extending from the year 1784 to 1818, when he was eighty years of age, he demonstrated the fact that our sun is a star situated not far from the bifurcation of the Milky Way, and that all the stars visible to us lie more or less in clusters scattered throughout a comparatively thin, but immensely extended stratum. At one time he imagined that his powerful instruments had pierced through this stellar stratum, and that he had approximately determined the form of some of its boundaries. In the last of his memoirs, having convinced himself of his error, he admitted that to his telescopes the Milky Way was "fathomless." On either side of this assemblage of stars, presumably in ceaseless motion round their common centre of gravity, Herschel discovered a canopy of discrete nebulous masses, such as those from the condensation of which he supposed the whole stellar universe to have been formed,—a magnificent conception, pursued with a force of genius and put to the practical test of observation with an industry almost incredible.

Hitherto we have said nothing about the great reflecting telescope, of 40 ft. focal length and 4 ft. aperture, the construction of which is often, though mistakenly, regarded as his chief performance. The full description of this celebrated instrument will be found in the 85th volume of the *Transactions* of the Royal Society: On the day that it was finished (August 28, 1789) Herschel saw at the first view, in a grandeur not witnessed before, the Saturnian system with six satellites, five of which had been discovered long before by C. Huygens and G. D. Cassini, while the sixth, subsequently named Enceladus, he had, two years before, sighted by glimpses in his exquisite little telescope of 6½ in. aperture, but now saw in unmistakable brightness with the towering giant he had just completed. On the 17th of September he discovered a seventh, which proved to be the nearest to the globe of Saturn. It has since received the name of Mimas. It is somewhat remarkable that, notwithstanding his long and repeated scrutinies of this planet, the eighth satellite, Hyperion, and the crape ring should have escaped him.

Herschel married, on the 8th of May 1788, the widow of Mr John Pitt, a wealthy London merchant, by whom he had an only son, John Frederick William. The prince regent conferred a Hanoverian knighthood upon him in 1816. But a far more valued and less tardy distinction was the Copley medal assigned to him by his associates in the Royal Society in 1781.

He died at Slough on the 25th of August 1822, in the eighty-fourth year of his age, and was buried under the tower of St Laurence's Church, Upton, within a few hundred yards of the old site of the 40-ft. telescope. A mural tablet on the wall of the church bears a Latin inscription from the pen of the late Dr Goodall, provost of Eton College.

See Mrs John Herschel, *Memoir of Caroline Herschel* (1876); E. S. Holden, *Herschel, his Life and Works* (1881); A. M. Clerke, *The Herschels and Modern Astronomy* (1895); E. S. Holden and C. S. Hastings, *Synopsis of the Scientific Writings of Sir William Herschel* (Washington, 1881); Baron Laurier, *Éloge historique*, Paris Memoirs (1823), p. lxi.; F. Arago, *Analyse historique, Annuaire du Bureau des Longitudes* (1842), p. 249; Arago, *Biographies of Scientific Men*, p. 167; Madame d'Arbly's *Diary, passim*; *Public Characters* (1798-1799), p. 384 (with portrait); J. Sime, *William Herschel and his Work* (1900). Herschel's photometric Star Catalogues were discussed and reduced by E. C. Pickering in *Harvard Annals*, vols. xiv. p. 345, xxiii. p. 185, and xxiv. (C. P.; A. M. C.)

HERSCHEL, SIR JOHN FREDERICK WILLIAM, BART. (1792-1871), English astronomer, the only son of Sir William Herschel, was born at Slough, Bucks, on the 7th of March 1792. His scholastic education commenced at Eton, but maternal fears or prejudices soon removed him to the house of a private tutor. Thence, at the early age of seventeen, he was sent to St John's College, Cambridge, and the form and method of the

mathematical instruction he there received exercised a material influence on the whole complexion of his scientific career. In due time the young student won the highest academical distinction of his year, graduating as senior wrangler in 1813. It was during his undergraduateship that he and two of his fellow-students who subsequently attained to very high eminence, Dean Peacock and Charles Babbage, entered into a compact that they would "do their best to leave the world wiser than they found it,"—a compact loyally and successfully carried out by all three to the end. As a commencement of this laudable attempt we find Herschel associated with these two friends in the production of a work on the differential calculus, and on cognate branches of mathematical science, which changed the style and aspect of mathematical learning in England, and brought it up to the level of the Continental methods. Two or three memoirs communicated to the Royal Society on new applications of mathematical analysis at once placed him in the front rank of the cultivators of this branch of knowledge. Of these his father had the gratification of introducing the first, but the others were presented in his own right as a fellow.

With the intention of being called to the bar, he entered his name at Lincoln's Inn on the 24th of January 1814, and placed himself under the guidance of an eminent special pleader. Probably this temporary choice of a profession was inspired by the extraordinary success in legal pursuits which had attended the efforts of some noted Cambridge mathematicians. Be that as it may, an early acquaintance with Dr Wollaston in London soon changed the direction of his studies. He experimented in physical optics; took up astronomy in 1816; and in 1820, assisted by his father, he completed for a reflecting telescope a mirror of 18 in. diameter and 20 ft. focal length. This, subsequently improved by his own hands, became the instrument which enabled him to effect the astronomical observations forming the chief basis of his fame. In 1821–1823 we find him associated with Sir James South in the re-examination of his father's double stars, by the aid of two excellent refractors, of 7 and 5 ft. focal length respectively. For this work he was presented in 1826 with the Astronomical Society's gold medal; and with the Lalande medal of the French Institute in 1825; while the Royal Society had in 1821 bestowed upon him the Copley medal for his mathematical contributions to their *Transactions*. From 1824 to 1827 he held the responsible post of secretary to that society; and was in 1827 elected to the chair of the Astronomical Society, which office he also filled on two subsequent occasions. In the discharge of his duties to the last-named society he delivered presidential addresses and wrote obituary notices of deceased fellows, memorable for their combination of eloquence and wisdom. In 1831 the honour of knighthood was conferred on him by William IV., and two years later he again received the recognition of the Royal Society by the award of one of their medals for his memoir "On the Investigation of the Orbits of Revolving Double Stars." The award significantly commemorated his completion of his father's discovery of gravitational stellar systems by the invention of a graphical method whereby the eye could as it were see the two component stars of the binary system revolving under the prescription of the Newtonian law.

Before the end of the year 1833, being then about forty years of age, Sir John Herschel had re-examined all his father's double stars and nebulae, and had added many similar bodies to his own lists; thus accomplishing, under the conditions then prevailing, the full work of a lifetime. For it should be remembered that astronomers were not as yet provided with those valuable automatic contrivances which at present materially abridge the labour and increase the accuracy of their determinations. Equatorially mounted instruments actuated by clockwork, electrical chronographs for recording the times of the phenomena observed, were not available to Sir John Herschel; and he had no assistant.

His scientific life now entered upon another and very characteristic phase. The bias of his mind, as he subsequently was wont to declare, was towards chemistry and the phenomena

of light, rather than towards astronomy. Indeed, very shortly after taking his degree at Cambridge, he proposed himself as a candidate for the vacant chair of chemistry in that university; but, as he said with some humour, the result of the election was to leave him in a glorious minority of one. In fact Herschel had become an astronomer from a sense of duty, and it was by filial loyalty to his father's memory that he was now impelled to undertake the completion of the work nobly begun at Slough. William Herschel had searched the northern heavens; John Herschel determined to explore the southern, besides re-exploring northern skies. "I resolved," he said, "to attempt the completion of a survey of the whole surface of the heavens; and for this purpose to transport into the other hemisphere the same instrument which had been employed in this, so as to give a unity to the results of both portions of the survey, and to render them comparable with each other." In accordance with this resolution, he and his family embarked for the Cape on the 13th November 1833; they arrived in Table Bay on the 15th January 1834; and proceedings, he says, "were pushed forward with such effect that on the 22nd of February I was enabled to gratify my curiosity by a view of α Crucis, the nebula about γ Argus, and some other remarkable objects in the 20-ft. reflector, and on the night of the 4th of March to commence a regular course of sweeping."

To give an adequate description of the vast mass of labour completed during the next four busy years of his life at Feldhausen would require the transcription of a considerable portion of the *Cape Observations*, a volume of unsurpassed interest and importance; although it might perhaps be equalled by a judicious selection from Sir William's "Memoirs," now scattered through some thirty volumes of the *Philosophical Transactions*. It was published, at the sole expense of the late duke of Northumberland, but not till 1847, nine years after the author's return to England, for the cogent reason, that as he said, "The whole of the observations, as well as the entire work of reducing, arranging and preparing them for the press, have been executed by myself." There are 164 pages of catalogues of southern nebulae and clusters of stars. There are then careful and elaborate drawings of the great nebula in Orion, and of the region surrounding the remarkable star in Argo. The labour and the thought bestowed upon some of these objects are almost incredible; several months were spent upon a minute spot in the heavens containing 1216 stars, but which an ordinary spangic, held at a distance of an arm's length, would eclipse. These catalogues and charts being completed, he proceeded to discuss their significance. He confirmed his father's hypothesis that these wonderful masses of glowing vapours are not irregularly scattered over the visible heavens, but are collected in a sort of canopy, whose vertex is at the pole of that vast stratum of stars in which our solar system finds itself buried, as Herschel supposed, at a depth not greater than that of the average distance from us of an eleventh magnitude star. Then follows his catalogue of the relative positions and magnitudes of the southern double stars, to one of which, γ Virginis, he applied the beautiful method of orbital determination invented by himself, and he had the satisfaction of witnessing the fulfilment of his prediction that the components would, in the course of their revolution, appear to close up into a single star, inseparable by any telescopic power. In the next chapter he proceeded to describe his observations on the varying and relative brightness of the stars. It has been already detailed how his father began his scientific career by similar observations on stellar light-fluctuations, and how his remarks culminated years afterwards in the question whether the radiative changes of our sun, due to the presence or absence of sun-spots, affected our harvests and the price of corn. Sir John carried speculation still farther, pointing out that variations to the extent of half a magnitude in the sun's brightness would account for those strange alternations of semi-arctic and semi-tropical climates which geological researches show to have occurred in various regions of our globe.

Herschel returned to his English home in the spring of 1838. As was natural and right, he was welcomed with an enthusiastic greeting. By the queen at her coronation he was created a baronet; and, what to him was better than all such rewards, other men caught the contagion of his example, and laboured in fields similar to his own, with an adequate portion of his success.

Herschel was a highly accomplished chemist. His discovery in 1819 of the solvent power of hyposulphite of soda on the otherwise insoluble salts of silver was the prelude to its use as a fixing agent in photography; and he invented in 1839, independently of Fox Talbot, the process of photography on sensitized paper. He was the first person to apply the now well-known terms *positive* and *negative* to photographic images.

and to imprint them upon glass prepared by the deposit of a sensitive film. He also paved the way for Sir George Stokes's discovery of fluorescence, by his addition of the lavender rays to the spectrum, and by his announcement in 1845 of "epipolic dispersion," as exhibited by sulphate of quinine. Several other important researches connected with the undulatory theory of light are embodied in his treatise on "Light" published in the *Encyclopaedia metropolitana*.

Perhaps no man can become a truly great mathematician or philosopher if devoid of imaginative power. John Herschel possessed this endowment to a large extent; and he solaced his declining years with the translation of the *Iliad* into verse, having earlier executed a similar version of Schiller's *Walk*. But the main work of his later life was the collection of all his father's catalogues of nebulae and double stars combined with his own observations and those of other astronomers each into a single volume. He lived to complete the former, to present it to the Royal Society, and to see it published in a separate form in the *Philosophical Transactions*, vol. cliv). The latter work he left unfinished, bequeathing it, in its imperfect form, to the Astronomical Society. That society printed a portion of it, which serves as an index to the observations of various astronomers on double stars up to the year 1866.

A complete list of his contributions to learned societies will be found in the Royal Society's great catalogue, and from them may be gathered most of the records of his busy scientific life. Sir John Herschel met with an amount of public recognition which was unusual in the time of his illustrious father. Naturally he was a member of almost every important learned society in both hemispheres. For five years he held the same office of master of the mint, which more than a century before had belonged to Sir Isaac Newton; his friends also offered to propose him as president of the Royal Society and again as member of parliament for the university of Cambridge, but neither position was desired by him.

In private life Sir John Herschel was a firm and most active friend; he had no jealousies; he avoided all scientific feuds; he gladly lent a helping hand to those who consulted him in scientific difficulties; he never discouraged, and still less disparaged, men younger than or inferior to himself; he was pleased by appreciation of his work without being solicitous for applause; it was said of him by a discriminating critic, and without extravagance, that "his was a life full of serenity of the sage and the docile innocence of a child."

He died at Collingwood, his residence near Hawkhurst in Kent, on the 11th of May 1871, in the seventy-ninth year of his age, and his remains are interred in Westminster Abbey close to the grave of Sir Isaac Newton.

Besides the laborious *Cape Observations*, Sir John Herschel was the author of several books, one of which at least, *On the Study of Natural Philosophy* (1830), possesses an interest which no future advances of the subjects on which he wrote can obliterate. In 1849 came the *Outlines of Astronomy*, a volume still replete with charm and instruction. His articles, "Meteorology," "Physical Geography," and "Telescope," contributed to the 8th edition of the *Encyclopaedia Britannica*, were afterwards published separately. When he was at the Cape he was more than once assisted in the attempts there made to diffuse a love of knowledge among men not engaged in literary pursuits; and with the same purpose he, on his return to England, published, in *Good Words* and elsewhere, a series of papers on interesting points of natural philosophy, subsequently collected in a volume called *Familiar Lectures on Scientific Subjects*. Another less widely known volume is his *Collected Addresses*, in which he is seen in his happiest and most instructive mood.

See also Mrs John Herschel, "Memoir of Caroline Herschel," *Month. Notices Roy. Astr. Society*, xxxii. 122 (C. Pritchard); *Proceedings Roy. Society*, xx. p. xvii. (T. Romney Robinson); *Proceedings Roy. Society of Edinburgh* vii. 543 (P. G. Tait); *Nature* iv. 92; Dunkin, *Obituary Notices*, p. 47; *Report Brit. Association* (1871), p. lxxxv. (Lord Kelvin); *The Times* (May 13, 1871); R. Grant, *History of Phys. Astronomy*; A. M. Clerke, *Popular Hist. of Astronomy*; A. M. Clerke, *The Herschels and Modern Astronomy*; J. H. Mädler, *Geschichte der Himmelskunde*, Bd. ii.; *Mémoires de la Société Physique de Genève*, xxi. 586 (E. Gautier). Reductions, based on standard magnitudes of 919 southern stars, observed by Herschel in sequences of relative brightness, were published by W. Dobereck in the *Astrophysical Journal*, xi. 192, 270, and in *Harvard Annals*, vol. xli., No. viii. (C. P.; A. M. C.)

HERSCHELL, FARRER HERSCHELL, 1ST BARON (1837-1899), lord chancellor of England, was born on the 2nd of November 1837. His father was the Rev. Ridley Haim Herschell, a native of Strzelno, in Prussian Poland, who, when a young man, exchanged the Jewish faith for Christianity, took a leading part in founding the British Society for the Propagation of the Gospel among the Jews, and, after many journeyings, settled down to the charge of a Nonconformist chapel near the Edgware Road, in London, where he ministered to a large congregation. His mother was a daughter of William Mowbray, a merchant of Leith. He was educated at a private school and at University College, London. In 1857 he took his B.A. degree at the University of London. He was reckoned the best speaker in the school debating society, and he displayed there the same command of language and lucidity of thought which were his characteristics during his official life. The reputation which Herschell enjoyed during his school days was maintained after he became a law-student at Lincoln's Inn. In 1858 he entered the chambers of Thomas Chitty, the famous common law pleader, father of the late Lord Justice Chitty. His fellow pupils, amongst whom were A. L. Smith, afterwards master of the rolls, and Arthur Charles, afterwards judge of the queen's bench division, gave him the sobriquet of "the chief baron" in recognition of his superiority. He subsequently read with James Hannen, afterwards Lord Hannen. In 1860 he was called to the bar and joined the northern circuit, then in its palmy days of undividedness. For four or five years he did not obtain much work. Fortunately, he was never a poor man, and so was not forced into journalism, or other paths of literature, in order to earn a living. Two of his contemporaries, each of whom achieved great eminence, found themselves in like case. One of these, Charles Russell, became lord chief justice of England; the other, William Court Gully, speaker of the House of Commons. It is said that these three friends, dining together during a Liverpool assize some years after they had been called, agreed that their prospects were anything but cheerful. Certain it is that about this time Herschell meditated quitting England for Shanghai and practising in the consular courts there. Herschell, however, soon made himself useful to Edward James, the then leader of the northern circuit, and to John Richard Quain, the leading stuff-gownsmen. For the latter he was content to note briefs and draft opinions, and when, in 1866, Quain donned "silk," it was on Herschell that a large portion of his mantle descended.

In 1872 Herschell was made a queen's counsel. He had all the necessary qualifications for a leader—a clear, though not resonant voice; a calm, logical mind; a sound knowledge of legal principles; and (greatest gift of all) an abundance of common sense. He never wearied the judges by arguing at undue length, and he knew how to retire with dignity from a hopeless cause. His only weak point was cross-examination. In handling a hostile witness he had neither the insidious persuasiveness of a Hawkins nor the compelling, dominating power of a Russell. But he made up for all by his speech to the jury, marshalling such facts as told in his client's favour with the most consummate skill. He very seldom made use of notes, but trusted to his memory, which he had carefully trained. By this means he was able to conceal his art, and to appear less as a paid advocate than as an outsider interested in the case anxious to assist the jury in arriving at the truth. By 1874 Herschell's business had become so good that he turned his thoughts to parliament. In February of that year there was a general election, with the result that the Conservative party came into power with a majority of fifty. The usual crop of petitions followed. The two Radicals (Thompson and Henderson) who had been returned for Durham city were unseated, and an attack was then made on the seats of two other Radicals (Bell and Palmer) who had been returned for Durham county. For one of these last Herschell was briefed. He made so excellent an impression on the local Radical leaders that they asked him to stand for Durham city; and after a fortnight's electioneering, he was elected as junior member. Between 1874 and 1880 Herschell was most assiduous in his attendance in the House of Commons. He was not a frequent speaker, but a few

great efforts sufficed in his case to gain for him a reputation as a debater. The best examples of his style as a private member will be found in *Hansard* under the dates 18th February 1876, 23rd May 1878, 6th May 1879. On the last occasion he carried a resolution in favour of abolishing actions for breach of promise of marriage except when actual pecuniary loss had ensued, the damages in such cases to be measured by the amount of such loss. The grace of manner and solid reasoning with which he acquitted himself during these displays obtained for him the notice of Gladstone, who in 1880 appointed Herschell solicitor-general.

Herschell's public services from 1880 to 1885 were of great value, particularly in dealing with the "cases for opinion" submitted by the Foreign Office and other departments. He was also very helpful in speeding government measures through the House, notably the Irish Land Act 1881, the Corrupt Practices and Bankruptcy Acts 1883, the County Franchise Act 1884 and the Redistribution of Seats Act 1885. This last was a bitter pill for Herschell, since it halved the representation of Durham city, and so gave him statutory notice to quit. Reckoning on the local support of the Cavendish family, he contested the North Lonsdale division of Lancashire; but in spite of the powerful influence of Lord Hartington, he was badly beaten at the poll, though Mr Gladstone again obtained a majority in the country. Herschell now thought he saw the solicitor-generalship slipping away from him, and along with it all prospect of high promotion. Lord Selborne and Sir Henry James, however, successively declined Gladstone's offer of the Woolsack, and in 1886 Herschell, by a sudden turn of fortune's wheel, found himself in his fortieth year lord chancellor.

Herschell's chancellorship lasted barely six months, for in August 1886 Gladstone's Home Rule Bill was rejected in the Commons and his administration fell. In August 1892, when Gladstone returned to power, Herschell again became lord chancellor. In September 1893, when the second Home Rule Bill came on for second reading in the House of Lords, Herschell took advantage of the opportunity to justify the "sudden conversion" to Home Rule of himself and his colleagues in 1885 by comparing it to the duke of Wellington's conversion to Catholic Emancipation in 1829 and to that of Sir Robert Peel to Free Trade in 1846. In 1895, however, his second chancellorship came to an end with the defeat of the Rosebery ministry.

Whether sitting at the royal courts in the Strand, on the judicial committee of the privy council, or in the House of Lords, Lord Herschell's judgments were distinguished for their acute and subtle reasoning, for their grasp of legal principles, and, whenever the occasion arose, for their broad treatment of constitutional and social questions. He was not a profound lawyer, but his quickness of apprehension was such that it was an excellent substitute for great learning. In construing a real property will or any other document, his first impulse was to read it by the light of nature, and to decline to be influenced by the construction put by the judges on similar phrases occurring elsewhere. But when he discovered that certain expressions had acquired a technical meaning which could not be disturbed without fluttering the dovescotes of the conveyancers, he would yield to the established rule, even though he did not agree with it. He was perhaps seen at his judicial best in *Vagliano v. Bank of England* (1891) and *Allen v. Flood* (1898). Latterly he showed a tendency, which seems to grow on some judges, to interrupt counsel overmuch. The case last mentioned furnishes an example of this. The question involved was what constituted a molestation of a man in the pursuit of his lawful calling. At the close of the argument of counsel, whom he had frequently interrupted, one of their lordships, noted for his pretty wit, observed that although there might be a doubt as to what amounted to such molestation in point of law, the House could well understand, after that day's proceedings, what it was in actual practice. In addition to his political and judicial work, Herschell rendered many public services. In 1888 he presided over an inquiry directed by the House of Commons with regard to the Metropolitan Board of Works. He acted as chairman of two

royal commissions, one on Indian currency, the other on vaccination. He took a great interest in the National Society for the Prevention of Cruelty to Children, not only promoting the acts of 1889 and 1894, but also bestowing a good deal of time in sifting the truth of certain allegations which had been brought against the management of that society. In June 1893 he was appointed chancellor of the university of London in succession to the earl of Derby, and he entered on his new duties with the usual thoroughness. "His views of reform," according to Victor Dickins, the accomplished registrar of the university, "were always most liberal and most frankly stated, though at first they were not altogether popular with an important section of university opinion. He disarmed opposition by his intellectual power, rather than conciliated it by compromise, and sometimes was perhaps a little masterful, after a fashion of his own, in his treatment of the various burning questions that agitated the university during his tenure of office. His characteristic power of detachment was well illustrated by his treatment of the proposal to remove the university to the site of the Imperial Institute at South Kensington. Although he was at that time chairman of the Institute, the most irreconcilable opponent of the removal never questioned his absolute impartiality." With the Imperial Institute Herschell had been officially connected from its inception. He was chairman of the provisional committee appointed by the prince of Wales to formulate a scheme for its organization, and he took an active part in the preparation of its charter and constitution in conjunction with Lord Thring, Lord James, Sir Frederick Abel and Mr John Hollams. He was the first chairman of its council, and, except during his tour in India in 1888, when he brought the Institute under the notice of the Indian authorities, he was hardly absent from a single meeting. For his special services in this connexion he was made G.C.B. in 1893, this being the only instance of a lord chancellor being decorated with an order.

In 1897 he was appointed, jointly with Lord Justice Collins, to represent Great Britain on the Venezuela Boundary Commission, which assembled in Paris in the spring of 1899. So complicated a business involved a great deal of preparation and a careful study of maps and historic documents. Not content with this, he accepted in 1898 a seat on the joint high commission appointed to adjust certain boundary and other important questions pending between Great Britain and Canada on the one hand and the United States on the other hand. He started for America in July of that year, and was received most cordially at Washington. His fellow commissioners elected him their president. In February 1899, while the commission was in full swing, he had the misfortune to slip in the street and in falling to fracture a hip bone. His constitution, which at one time was a robust one, had been undermined by constant hard work, and proved unequal to sustaining the shock. On the 1st of March, only a fortnight after the accident, he died at the Shoreham Hotel, Washington, a *post-mortem* examination revealing disease of the heart. Mr Hay, secretary of state, at once telegraphed to Mr Choate, the United States ambassador in London, the "deep sorrow" felt by President McKinley; and Sir Wilfred Laurier said the next day, in the parliament chamber at Ottawa, that he regarded Herschell's death "as a misfortune to Canada and to the British Empire." A funeral service held in St John's Episcopal Church, Washington, was attended by the president and vice-president of the United States, by the cabinet ministers, the judges of the Supreme Court, the members of the joint high commission, and a large number of senators and other representative men. The body was brought to London in a British man-of-war, and a second funeral service was held in Westminster Abbey before it was conveyed to its final resting-place at Tincleton, Dorset, in the parish church of which he had been married. Herschell left a widow, granddaughter of Vice-Chancellor Kindersley; a son, Richard Farrer (b. 1878), who succeeded him as second baron; and two daughters.

A "reminiscence" of Herschell by Mr Speaker Gully (Lord Selby) will be found in *The Law Quarterly Review* for April 1899. *The Journal of the Society of Comparative Legislation* (of which he had been

president from his formation in 1893) contains, in its part for July of the same year, notices of him by Lord James of Hertford, Lord Davey, Mr Victor Williamson (his executor and intimate friend), and also by Mr Justice D. J. Brewer and Senator C. W. Fairbanks (both of the United States). (M. H. C.)

HERSENT, LOUIS (1777-1860), French painter, was born at Paris on the 10th of March 1777, and becoming a pupil of David, obtained the Prix de Rome in 1797; in the Salon of 1802 appeared his "Metamorphosis of Narcissus," and he continued to exhibit with rare interruptions up to 1831. His most considerable works under the empire were "Achilles parting from Briseis," and "Atala dying in the arms of Chactas" (both engraved in Landon's *Annales du Musée*); an "Incident of the life of Fénelon," painted in 1810, found a place at Malmaison, and "Passage of the Bridge at Landshut," which belongs to the same date, is now at Versailles. Hersent's typical works, however, belong to the period of the Restoration; "Louis XVI. relieving the Afflicted" (Versailles) and "Daphnis and Chloë" (engraved by Langier and by Gélée) were both in the Salon of 1817; at that of 1819 the "Abdication of Gustavus Vasa" brought to Hersent a medal of honour, but the picture, purchased by the duke of Orleans, was destroyed at the Palais Royal in 1848, and the engraving by Henriquel-Dupont is now its sole record. "Ruth," produced in 1822, became the property of Louis XVIII., who from the moment that Hersent rallied to the Restoration jealously patronized him, made him officer of the legion of honour, and pressed his claims at the Institute, where he replaced van Spaendonck. He continued in favour under Charles X., for whom was executed "Monks of Mount St Gotthard," exhibited in 1824. In 1831 Hersent made his last appearance at the Salon with portraits of Louis Philippe, Marie-Amélie and the duke of Montpensier; that of the king though good, is not equal to the portrait of Spontini (Berlin), which is probably Hersent's *chef-d'œuvre*. After this date Hersent ceased to exhibit at the yearly salons. Although in 1846 he sent an excellent likeness of Delphine Gay and one or two other works to the rooms of the Société d'Artistes, he could not be tempted from his usual reserve even by the international contest of 1855. He died on the 2nd of October 1860.

HERSFELD, a town of Germany, in the Prussian province of Hesse-Nassau, is pleasantly situated at the confluence of the Geis and Haun with the Fulda, on the railway from Frankfort-on-Main to Bebra, 24 m. N.N.E. of Fulda. Pop. (1905) 8688. Some of the old fortifications of the town remain, but the ramparts and ditches have been laid out as promenades. The principal buildings are the Stadt Kirche, a beautiful Gothic building, erected about 1320 and restored in 1899, with a fine tower and a large bell; the old and interesting town hall (Rathaus) and the ruins of the abbey church. This church was erected on the site of the cathedral in the beginning of the 12th century; it was built in the Byzantine style and was burnt down by the French in 1761. Outside the town are the Frauenberg and the Johannesberg, on both of which are monastic ruins. Among the public institutions are a gymnasium and a military school. The town has important manufactures of cloth, leather and machinery: it has also dye-works, worsted mills and soap-boiling works.

Hersfeld owes its existence to the Benedictine abbey (see below). It became a town in the 12th century and in 1370 the burghers, having meanwhile shaken off the authority of the abbots, placed themselves under the protection of the landgraves of Hesse. It was taken and retaken during the Thirty Years' War and later it suffered from the attacks of the French.

The Benedictine abbey of Hersfeld was founded by Lullus, afterwards archbishop of Mainz, about 769. It was richly endowed by Charlemagne and became an ecclesiastical principality in the 12th century, passing under the protection of the landgraves of Hesse in 1423. It was secularized in 1648, having been previously administered for some years by a member of the ruling family of Hesse. As a secular principality Hersfeld passed to Hesse, and with electoral Hesse was united with Prussia in 1866. In the middle ages the abbey was famous for its library.

See Vigelius, *Denkwürdigkeiten von Hersfeld* (Horsfeld, 1888); Demme, *Nachrichten und Urkunden zur Chronik von Hersfeld* (Hersfeld, 1891-1901), and P. Hafner, *Die Reichsabtei Hersfeld bis zur Mitte des 13ten Jahrhunderts* (Hersfeld, 1889).

HERSTAL, or **HERISTAL**, a town of Belgium, less than 2 m. N. of Liège and practically one of its suburbs. The name is supposed to be derived from *Heerstelle*, i.e. "Permanent Camp." The second Pippin was born here, and this mayor of the palace acquired the control of the kingdom of the Franks. His grandson, Pippin the Short, died at Herstal in A.D. 768, and it disputes with Aix la Chapelle the honour of being the birthplace of Charlemagne. It is now a very active centre of iron and steel manufactures. The Belgian national small arms factory and cannon foundry are fixed here. Pop. (1904) 20,114.

HERTFORD, EARLS AND MARQUESES OF. The English earldom of Hertford was held by members of the powerful family of Clare from about 1138, when Gilbert de Clare was created earl of Hertford, to 1314 when another earl Gilbert was killed at Bannockburn. In 1537 EDWARD SEYMOUR, viscount Beauchamp, a brother of Henry VIII.'s queen, Jane Seymour, was created earl of Hertford, being advanced ten years later to the dignity of duke of Somerset and becoming protector of England. His son EDWARD (c. 1540-1621) was styled earl of Hertford from 1547 until the protector's attainder and death in January 1552, when the title was forfeited; in 1559, however, he was created earl of Hertford. In 1560 he was secretly married to Lady Catherine Grey (c. 1538-1568), daughter of Henry Grey, duke of Suffolk, and a descendant of Henry VII. Queen Elizabeth greatly disliked this union, and both husband and wife were imprisoned, while the validity of their marriage was questioned. Catherine died on the 27th of January 1568 and Hertford on the 6th of April 1621. Their son Edward, Lord Beauchamp (1561-1612), who inherited his mother's title to the English throne, predeceased his father; and the latter was succeeded in the earldom by his grandson WILLIAM SEYMOUR (1588-1660), who was created marquess of Hertford in 1640 and was restored to his ancestor's dukedom of Somerset in 1660. The title of marquess of Hertford became extinct when JOHN, 4th duke of Somerset, died in 1675, and the earldom when ALGERNON, the 7th duke, died in February 1850.

In August 1750 FRANCIS SEYMOUR CONWAY, 2nd Baron Conway (1718-1794), who was a direct descendant of the protector Somerset, was created earl of Hertford; this nobleman was the son of Francis Seymour Conway (1679-1732), who had taken the name of Conway in addition to that of Seymour, and was the brother of Field-marshal Henry Seymour Conway. Hertford was ambassador to France from 1763 to 1765; was lieutenant of Ireland in 1765 and 1766; and lord chamberlain of the household from 1766 to 1782. Horace Walpole speaks of his "decorum and piety" and refers to him as a "perfect courtier," but says that he had "too great propensity to heap encomiums on his children." In 1793 he became earl of Yarmouth and marquess of Hertford, and he died on the 14th of June 1794. His son, FRANCIS INGRAM SEYMOUR CONWAY (1743-1822), who was known during his father's lifetime as Lord Beauchamp, took a prominent part in the debates of the House of Commons from 1766 until he succeeded to the marquessate in 1794. He was sent as ambassador to Berlin and Vienna in 1793 and from 1812 to 1821 he was lord chamberlain. His son FRANCIS CHARLES, the 3rd marquess (1777-1842), was an intimate friend of the prince regent, afterwards George IV., and is the original of the "Marquis of Steyne" in Thackeray's *Vanity Fair* and of "Lord Monmouth" in Disraeli's *Coningsby*. The 4th marquess was his son, RICHARD (1800-1870), whose mother was the great heiress, Maria Emily Fagniani, and whose brother was Lord Henry Seymour (1805-1859), the founder of the Jockey Club at Paris. When Richard died unmarried in Paris in August 1870 his title passed to his kinsman, FRANCIS HUGO GEORGE SEYMOUR (1812-1884), a descendant of the 1st marquess, whose son, HUGH DE GREY (b. 1843) became 6th marquess in 1884. The 4th marquess left his great wealth and his priceless collection of art treasures to Sir Richard Wallace (1818-1890), his reputed half-brother, and Wallace's widow, who died in 1897, bequeathed the collection to the British nation. It is now in Hertford House, formerly the London residence of the marquesses of Hertford.

HERTFORD, a market-town and municipal borough, and the county town of Hertfordshire, England, in the Hertford parliamentary division of the county, 24 m. N. from London, the terminus of branch lines of the Great Eastern and Great Northern railways. Pop. (1901) 9322. It is pleasantly situated in the valley of the river Lea. The chief buildings are the modern churches of St Andrew and of All Saints, on the sites of old ones, a town hall, corn exchange, public library, school of art and the old castle, which retains the wall and part of a tower dating from the Norman period, and is represented by a picturesque Jacobean building of brick, largely modernized. There are several educational establishments, including the preparatory school for Christ's Hospital, a picturesque building (in great part, however, rebuilt) at the east end of the town, Hale's grammar school, the Cowper Testimonial school, and a Green-coat school for boys and girls. Two miles S.E. is Haileybury College, one of the principal public schools of England, founded in 1805 by the East India Company for their civil service students, who were then temporarily housed in Hertford Castle. The school lies high above the Lea valley, towards Hoddesdon, in the midst of a stretch of finely-wooded country. Hertford has a considerable agricultural trade, and there are maltings, breweries, iron foundries, and oriental printing works. The town is governed by a mayor, 5 aldermen and 15 councillors. Area, 1134 acres.

Hertford (*Hertuford*, *Heortoford*, *Hurtford*) was the scene of a synod in 673. Its communication with London by way of the Lea and the Thames gave it strategic importance during the Danish occupation of East Anglia. In 1066 and later it was a royal garrison and burgh. It made separate payments for aids to the Norman and Angevin kings; and in 1331 was governed by a bailiff annually elected by the commonalty. A charter incorporated the bailiffs and burgesses in 1555, and was confirmed under Elizabeth and in 1606. A charter of 1680 to the mayor, aldermen and commonalty was effective until the Municipal Corporation Act. Hertford returned two burgesses to the parliament of 1298, and to others until, after 1375/6, such right became abeyant, to be restored by order of parliament in 1623/4. One representative was lost by the Representation Act in 1868, and separate representation by the Redistribution Act in 1885. A grant of fairs in 1226 probably originated or confirmed those held in 1331 on the feasts of the Assumption and of St Simon and St Jude, their vigils and morrows, which fairs were confirmed by Elizabeth and Charles II. Another on the vigil, morrow and feast of the Nativity of the Virgin was granted by Elizabeth: its date was changed to May-day under James I. Modern fairs are on the third Saturday before Easter, the 12th of May, the 5th of July and the 8th of November. Markets were held in 1331 on Wednesday and Saturday; after 1368 on Thursday and Saturday; and they returned to Wednesdays and Saturdays in 1680.

HERTFORDSHIRE [*HERTS*], a county of England, bounded N. by Cambridgeshire, N.W. by Bedfordshire, E. by Essex, S. by Middlesex, and S.W. by Buckinghamshire. The area is 634.6 sq. m., the county being the sixth smallest in England. Its aspect is always pleasant, the surface generally undulating, while in some parts, where these undulations form a quick succession of hills and valleys, the woodland scenery becomes very beautiful, as in the upper Lea valley, in the neighbourhood of Tewin near Hertford, and elsewhere. To the north-west and north considerable elevations are reached, a line of hills, facing north-westward with a sharp descent, crossing this portion of the county, and overlooking the flat lands of Bedfordshire and Cambridgeshire. They continue the line of the Chiltern Hills under the name of the East Anglian Ridge. They exceed 800 ft. near Dunstable, sinking gradually north-eastward. These uplands are generally bare, and in parts remarkably sparsely populated as compared with the home counties at large. In the greater part of the county, however, rich arable lands are intermingled with the parks and woodlands of numerous fine country seats, which impart to the county a peculiar luxuriance. Of the principal rivers, the Lea, rising beyond Luton in Bedfordshire,

enters Hertfordshire near East Hyde, flows S.E. to near Hatfield, then E. by N. to Hertford and Ware, whence it bends S. and passing along the eastern boundary of the county falls into the Thames below London. It receives in its course the Maran, or Mimram, the Beane, the Rib and the Stort, all joining on the north side; the Stort for some distance forming the county boundary with Essex. The Colne flows through the south-western part of the county, to fall into the Thames at Staines. It receives the Ver, the Bulborne and the Chess. The Ivel, rising in the N.W. soon passes into Bedfordshire to join the Great Ouse. To the south of Hatfield, near North Mimms, two streams of moderate size are lost in pot-holes, except in the highest floods. The New River, one of the water supplies of London, has its source near Ware, and runs roughly parallel with the Lea. Most of the rivers are full of fish, including trout in the upper parts (of the Lea and Colne especially), which are carefully preserved.

Geology.—The rocks of Hertfordshire belong to the shallow syncline known as the London basin, the beds dipping in a south-easterly direction. The two most important formations are the Chalk, which forms the high ground in the north and west; and the Eocene Reading beds and London Clay which occupy the remaining southern part of the county. On the northern boundary, at the foot of the chalk hills, a small strip of Gault Clay and the Upper Greensand above it falls just within the county. The lowest subdivision of the chalk is the Chalk Marl, which with the Totternhoe Stone above it, lies at the base of the Chalk escarpment, by Ashwell, Pirton and Miswell to Tring. Above these beds, the Lower Chalk, without flints, rises up sharply to form the downs which are the easterly continuation of the Chiltern Hills. Next comes the Chalk Rock, which being a hard bed, lies near the hilltops by Boxmoor, Apsley End and near Baldock. The Upper Chalk slopes southward towards the Eocene boundary previously mentioned. The Reading beds consist of mottled and yellow clays and sands, the latter are frequently hardened into masses made up of pebbles in a siliceous cement, known locally as Hertfordshire puddingstone. The London Clay, a stiff blue clay which weathers brown, rests nearly everywhere upon the Reading beds. Outliers of Eocene rocks rest on the chalk at Micklefield Green, Sarrat, Bedmont, &c. The Chalk is often covered by the Clay-with-flints, a detrital deposit, formed of the remnants of Tertiary rocks and Chalk. Glacial gravels, clays and loams cover a great deal of the whole area, and the Upper Chalk itself has been disturbed at Reed and Barley by the same agency. Chalk was formerly used for building purposes; it is now burned for lime. Reading beds and London clay are dug for brickmaking at Watford, Hertford and Hatfield. Phosphatic nodules have been excavated from the base of the Chalk Marl at several places along the outcrop; the Marl is worked for cement.

Climate and Agriculture.—The climate is mild, dry and generally healthy. On this account London physicians were formerly accustomed to recommend the county to persons in weak health, and it was so much coveted by the noble and wealthy as a place of residence that it was a common saying that "he who buys a home in Hertfordshire pays two years' purchase for the air." Of the total area about four-fifths is under cultivation, and of this more than one-third is in permanent pasture. The principal grain crop is wheat, occupying about two-fifths of the area under corn, but gradually decreasing. The varieties mostly grown are white, and they are unsurpassed by those of any English county. Wheathampstead on the upper Lea receives its name from the fine quality of the wheat grown in that district. Barley is largely used in the county for malting purposes. Vetches are grown for the London stables, and the greater part of the permanent grass is used for hay. There are some very rich pastures on the banks of the Stort, and also near Rickmansworth on the Colne. Some two-thirds of the area occupied by green crops is under turnips, swedes and mangolds, many cows being kept for the supply of milk and butter to London. The quantity of stock is generally small, but increasing except in the case of sheep, of which the numbers have greatly decreased. Of cows the most common breed is the Suffolk variety; of sheep, Southdowns, Wiltshires and a cross between Cotteswolds and Leicesters. In the south-west large quantities of cherries, apples and strawberries are grown for the London market; and on the best soils near London vegetables are forced by the aid of manure, and more than one crop is sometimes obtained in a year. A considerable industry lies in the growth of watercresses in the pure water of the upper parts of the rivers and

the smaller streams. There are a number of rose-gardens and nurseries.

Other Industries.—The manufacturing industries are slight; though the great brewing establishments at Watford may be mentioned, and straw-plaiting, paper-making, coach-building, tanning and brick-making are carried on in various towns.

Communications.—Owing to its proximity to the metropolis, Hertfordshire is particularly well served by railways. On the eastern border there is the Great Eastern (Cambridge line) with branches to Hertford and to Buntingford. The main line of the Great Northern passes through the centre by Hatfield, Stevenage and Hitchin, with branches from Hatfield to Hertford, to St Albans and to Luton and Dunstable, and from Hitchin to Baldock, Royston and so to Cambridge. The Midland passes through St Albans and Harpenden, with a branch to Hemel Hempstead. The London & North-Western traverses the south-west by Watford, Berkhamstead and Tring, with branches to Rickmansworth and to St Albans. The Metropolitan & Great Central joint line serves Rickmansworth, and suburban lines of the Great Northern the Barnet district. The existence of these communications has combined with the natural attractions of the county to cause many villages to become large residential centres. Water communications are supplied from Hertford, Ware and Bishop Stortford, southward to the Thames by the Lea and Stort Navigation; and the Grand Junction canal from London to the north-west traverses the south-western corner of the county by Rickmansworth and Berkhamstead. Three great highways from London to the north traverse the county. The Holyhead Road passes Chipping Barnet, South Mimms and St Albans, quitting the county near Dunstable. The Great North Road branches from the Holyhead Road at Barnet, and passes Potter's Bar, Hatfield, Stevenage and Baldock, with a branch from Welwyn to Hitchin and beyond. Another road follows the Lea valley to Ware, whence it runs to Royston, being here coincident with the Roman Ermine Street and known as the Old North Road.

Population and Administration.—The area of the ancient county is 406,157 acres with a population in 1891 of 220,162, and in 1901 of 250,152. The area of the administrative county is 404,518 acres. The county comprises eight hundreds. The municipal boroughs are: Hemel Hempstead (11,263), Hertford (9322), St Albans, a city (16,019). The other urban districts are: Baldock (2057), Barnet (7876), Berkhamstead (Great Berkhamstead, 5140), Bishop Stortford (7143), Bushey (4564), Cheshunt (12,292), East Barnet Valley (10,094), Harpenden (4725), Hitchin (10,072), Hoddesdon (4711), Rickmansworth (5627), Royston (3517), Sawbridgeworth (2085), Stevenage (3957), Tring (4349), Ware (5573) and Watford (29,327). The county is in the home circuit, and assizes are held at Hertford. It has two courts of quarter-sessions, and is divided into 15 petty-sessional divisions. The boroughs of Hertford and St Albans have separate commissions of the peace. The total number of civil parishes is 158. All the civil parishes within 12 m. of, or in which no portion is more than 15 m. from, Charing Cross, London, are included in the metropolitan police district. The county contains 170 ecclesiastical parishes or districts, wholly or in part; it is nearly all in the diocese of St Albans, but small parts are in the dioceses of Ely, Oxford and London. It is divided into four parliamentary divisions—Northern or Hitchin, Eastern or Hertford, Mid or St Albans, Western or Watford, each returning one member. There is no parliamentary borough within the county.

History.—Relics of Saxon occupation have been found in Hertfordshire for the most part near St Albans and Hitchin. The diocesan limits show that part of the shire was included in the West Saxon kingdom. The East Saxons, as early as the 6th century, were settled about Hertford, which in 673 was sufficiently important to be the meeting-place of a synod convened by Theodore, archbishop of Canterbury, while in 675 the Witenagemot assembled at a place which has been identified with Hatfield. In the 9th century the district was frequently visited by the Danes; and after the peace of Wedmore the country east

of the Lea was included in the Danelaw; in 911 Edward the Elder erected forts on both sides of the river at Hertford.

After the battle of Hastings William advanced on Hertfordshire and ravaged as far as Berkhamstead, where the Conquest received its formal ratification. In the sweeping confiscation of estates which followed, the church was generously endowed, the abbey of St Albans alone holding 172 hides, while Count Eustace of Boulogne, the chief lay tenant, held a vast fief in the north-east of the county. Large estates were held by Geoffrey de Mandeville, and the barony of Peter de Valognes, sheriff of the county in 1086, though extending over six counties in the east of England, was returned in 1106 as a Hertfordshire barony. Berkhamstead was the head of an honour carved from the fief of Robert of Mortain. The Hertfordshire estates, however, for the most part changed hands very frequently and the county is noticeably lacking in historic families. Edmund Langley, fifth son of Edward III., was born at King's Langley in this county.

During the war between John and his barons, William, earl of Salisbury and Falkes de Breauté had the king's orders to ravage Hertfordshire, and in 1216 Hertford Castle was captured and Berkhamstead Castle besieged by Louis of France, who had come over by invitation of the barons. At the time of the rising of 1381 the abbot's tenants broke into the abbey of St Albans and forced the abbot to grant them a charter. During the Wars of the Roses, Henry VI. was defeated at St Albans in 1455; at the second battle of St Albans the earl of Warwick was defeated by Queen Margaret; and in 1471 Edward IV. again defeated the earl at Barnet. On the outbreak of the Civil War of the 17th century, Hertfordshire joined with Bedfordshire and Essex in petitioning for peace, and St Albans again played an important part in the struggle, being at different times the headquarters of Essex and Fairfax.

As a shire Hertfordshire is of purely military origin, being the district assigned to the fortress which Edward the Elder erected at Hertford. It is first mentioned in the Saxon Chronicle in 1011. At the time of the Domesday Survey the boundaries were approximately those of the present day, but part of Meppershall in Bedfordshire formed a detached portion of the shire and is still assessed for land and income tax in Hertfordshire. Of the nine Domesday hundreds, those of Danais and Tring were consolidated about 1200 under the name of Dacorim; the modern hundred of Cashio, from being held by the abbots of St Albans, was known as Albaneston, while the remaining six hundreds correspond approximately both in name and extent with those of the present day.

Hertfordshire was originally divided between the dioceses of London and Lincoln. In 1291 that part included in the Lincoln diocese formed part of the archdeaconry of Huntingdom and comprised the deaneries of Berkhamstead, Hitchin, Hertford and Baldock, and the archdeaconry and deanery of St Albans; while that part within the London diocese formed the deanery of Braughing within the archdeaconry of Middlesex. In 1535 the jurisdiction of St Albans had been transferred to the London diocese, the division being otherwise unchanged. In 1846 the whole county was placed within the diocese of Rochester and archdeaconry of St Albans, and in the next year the deaneries of Welwyn, Bennington, Buntingford, Bishop Stortford and Ware were created, and that of Braughing abolished. In 1864 the archdeaconries of Rochester and St Albans were united under the name of the archdeaconry of Rochester and St Albans. In 1878 the county was placed in the newly created diocese of St Albans, and formed the archdeaconry of St Albans, the deaneries being unchanged.

Hertfordshire was closely associated with Essex from the time of its first settlement, and the counties paid a joint fee-farm and were united under one sheriff until 1565, the shire-court being held at Hertford. The hundred of St Albans was at an early date constituted a separate liberty, with independent courts and coroners under the control of the abbot; it preserved a separate commission of the peace until 1874, when by act of parliament the county was arranged in two divisions, the eastern division

being named Hertford, and the western the liberty of St Albans. These divisions have since been abolished.

Hertfordshire has always been an agricultural county, with few manufactures, and at the time of the Domesday Survey its wealth was derived almost entirely from its rural manors, with their water meadows, woodlands, fisheries paying rent in eels, and water-mills, the shire on its eastern side being noticeably free from waste land. In Norman times the woollen trade was considerable, and the great corn market at Royston has been famous since the reign of Elizabeth. At the time of the Civil War the malting industry was largely carried on, and saltpetre was produced in the county. In the 17th century Hertfordshire was famous for its horses, and the 18th century saw the introduction of several minor industries, such as straw-plaiting, paper-making and silk weaving.

In 1290 Hertfordshire returned two members to parliament, and in 1298 the borough of Hertford was represented. St Albans, Bishop Stortford and Berkhamstead acquired representation in the 14th century, but from 1375 to 1553 no returns were made for the boroughs. St Albans regained representation in 1553 and Hertford in 1623. Under the Reform Act of 1832 the county returned three members. St Albans was disfranchised on account of bribery in 1852. Hertford lost one member in 1868, and was disfranchised by the act of 1885.

Antiquities.—Among the objects of antiquarian interest may be mentioned the cave of Royston, doubtless once used as a hermitage; Waltham Cross, erected to mark the spot where rested the body of Eleanor, queen of Edward I., on its way to Westminster for interment; and the Great Bed of Ware referred to in Shakespeare's *Twelfth Night* and preserved at Rye House. The principal monastic buildings are the noble pile of St Albans abbey; the remains of Sopwell Benedictine nunnery near St Albans, founded in 1140; the remains of the priory of Ware, dedicated to St Francis, and originally a cell to the monastery of St Ebrulf at Utica in Normandy; and the remains of the priory at Hitchin built by Edward II. for the Carmelites. Among the more interesting churches may be mentioned those of Abbots Langley and Hemel Hempstead, both of Late Norman architecture; Baldock, a handsome mixed Gothic building supposed to have been erected by the Knights Templars in the reign of Stephen; Royston, formerly connected with the priory of canons regular; Hitchin of the 15th century; Hatfield, dating from the 13th century but in the main later; Berkhamstead, chiefly in the Perpendicular style, with a tower of the 16th century. Sandridge church shows good Norman work with the use of Roman bricks; Wheathampstead church, mainly very fine decorated, has pre-Norman remains. The remains of secular buildings of importance are those of Berkhamstead castle, Hertford castle, Hatfield palace of the bishops of Ely, the slight traces at Bishop Stortford, and the earthworks at Anstey. Among the numerous mansions of interest, Rye House, erected in the reign of Henry VI., was tenanted by Rumbold, one of the principal agents in the plot to assassinate Charles II. Moor Park, Rickmansworth, once the property of St Albans abbey, was granted by Henry VII. to John de Vere, earl of Oxford, and was afterwards the property of the duke of Monmouth, who built the present mansion, which, however, was subsequently cased with Portland stone and received various other additions. Knebworth, the seat of the Lyttons, was originally a Norman fortress, rebuilt in the time of Elizabeth in the Tudor style and restored in the 19th century. Hatfield House is the seat of the marquis of Salisbury; but its earlier history is of great interest, as is that of Theobalds near Cheshunt. Panshanger House, until recently the principal seat of the Cowpers, is a splendid mansion in Gothic style erected at the beginning of the 19th century. The manor of Cashibury House, the seat of the earls of Essex, was formerly held by the abbot of St Albans, but the mansion was rebuilt in the beginning of the 19th century from designs by Wyatt. Gorbambury House, near St Albans, the seat of the earl of Verulam, formerly the seat of the Bacons, and the residence of the great chancellor, was rebuilt at the close of the 18th century. At Kings Langley and Hunsdon were also former royal residences.

See Sir H. Chauncy, *Historical Antiquities of Hertfordshire* (London, 1700, 2nd ed., Bishop Stortford, 1826); N. Salmon, *History of Hertfordshire* (London, 1728); R. Clutterbuck, *History and Antiquities of the County of Hertford* (London, 1815-1827); W. Berry, *Pedigrees of the Hertfordshire Families* (London, 1844); J. E. Cussans, *History of Hertfordshire* (London, 1870-1881); *Victoria County History, Hertfordshire* (London, 1902, &c.); see also "Visitation of Hertfordshire, 1572-1634," in *Harleian Society's Publ.* vol. xvii., and various papers in *Middlesex and Hertfordshire Notes and Queries* (1895-1898), which in January 1899 was incorporated in the *Home Counties Magazine*.

HERTHA, or NERTHUS, in Teutonic mythology, the goddess of fertility, "Mother Earth." Tacitus states that many Teutonic tribes worshipped her with orgies and mysterious rites celebrated at night. The chief seat of her cult was an island which has not been identified. A single priest performed the service. Her veiled statue was moved from place to place by sacred cows on which none but the priest might lay hands. At the conclusion of the rites the image, its vestments and its vehicle were bathed in a lake.

HERTZ, HEINRICH RUDOLF (1857-1894), German physicist, was born at Hamburg on the 22nd of February 1857. On leaving school he determined to adopt the profession of engineering, and in the pursuance of this decision went to study in Munich in 1877. But soon coming to the conclusion that engineering was not his vocation he abandoned it in favour of physical science, and in October 1878 began to attend the lectures of G. R. Kirchhoff and H. von Helmholtz at Berlin. In preparation for these he spent the winter of 1877-1878 in reading up original treatises like those of Laplace and Lagrange on mathematics and mechanics, and in attending courses on practical physics under P. G. von Jolly and J. F. W. von Bezold; the consequence was that within a few days of his arrival in Berlin in October 1878 he was able to plunge into original research on a problem of electric inertia. For the best solution a prize was offered by the philosophical faculty of the University, and this he succeeded in winning with the paper which was published in 1880 on the "Kinetic Energy of Electricity in Motion." His next investigation, on "Induction in Rotating Spheres," he offered in 1880 as his dissertation for his doctor's degree, which he obtained with the rare distinction of *summa cum laude*. Later in the same year he became assistant to Helmholtz in the physical laboratory of the Berlin Institute. During the three years he held this position he carried out researches on the contact of elastic solids, hardness, evaporation and the electric discharge in gases, the last earning him the special commendation of Helmholtz. In 1883 he went to Kiel, becoming *Privatdozent*, and there he began the studies in Maxwell's electro-magnetic theory which a few years later resulted in the discoveries that rendered his name famous. These were actually made between 1885 and 1889, when he was professor of physics in the Carlsruhe Polytechnic. He himself recorded that their origin is to be sought in a prize problem proposed by the Berlin Academy of Sciences in 1879, having reference to the experimental establishment of some relation between electromagnetic forces and the dielectric polarization of insulators. Imagining that this would interest Hertz and be successfully attacked by him, Helmholtz specially drew his attention to it, and promised him the assistance of the Institute if he decided to work on the subject; but Hertz did not take it up seriously at that time, because he could not think of any procedure likely to prove effective. It was of course well known, as a necessity of Maxwell's mathematical theory, that the polarization and depolarization of an insulator must give rise to the same electromagnetic effects in the neighbourhood as a voltaic current in a conductor. The experimental proof, however, was still lacking, and though several experimenters had come very near its discovery, Hertz was the first who actually succeeded in supplying it, in 1887. Continuing his inquiries for the next year or two, he was able to discover the progressive propagation of electromagnetic action through space, to measure the length and velocity of electromagnetic waves, and to show that in the transverse nature of their vibration and their susceptibility to reflection, refraction and polarization they are in complete correspondence with the waves of light and heat. The result, was in Helmholtz's words, to establish beyond doubt that

ordinary light consists of electrical vibrations in an all-pervading ether which possesses the properties of an insulator and of a magnetic medium. Hertz himself gave an admirable account of the significance of his discoveries in a lecture on the relations between light and electricity, delivered before the German Society for the Advancement of Natural Science and Medicine at Heidelberg in September 1889. Since the time of these early experiments, various other modes of detecting the existence of electric waves have been found out in addition to the spark-gap which he first employed, and the results of his observations, the earliest interest of which was simply that they afforded a confirmation of an abstruse mathematical theory, have been applied to the practical purposes of signalling over considerable distances (see TELEGRAPHY, WIRELESS). In 1889 Hertz was appointed to succeed R. J. E. Clausius as ordinary professor of physics in the university of Bonn. There he continued his researches on the discharge of electricity in rarefied gases, only just missing the discovery of the X-rays described by W. C. Röntgen a few years later, and produced his treatise on the *Principles of Mechanics*. This was his last work, for after a long illness he died at Bonn on the 1st of January 1894. By his premature death science lost one of her most promising disciples. Helmholtz thought him the one of all his pupils who had penetrated farthest into his own circle of scientific thought, and looked to him with the greatest confidence for the further extension and development of his work.

Hertz's scientific papers were translated into English by Professor D. E. Jones, and published in three volumes: *Electric Waves* (1893), *Miscellaneous Papers* (1896), and *Principles of Mechanics* (1899). The preface contributed to the first of these by Lord Kelvin, and the introductions to the second and third by Professors P. E. A. Lenard and Helmholtz, contain many biographical details, together with statements of the scope and significance of his investigations.

HERTZ, HENRIK (1797-1870), Danish poet, was born of Jewish parents in Copenhagen on the 25th of August 1798. In 1817 he was sent to the university. His father died in his infancy, and the family property was destroyed in the bombardment of 1807. The boy was brought up by his relative, M. L. Nathanson, a well-known newspaper editor. Young Hertz passed his examination in law in 1825. But his taste was all for polite literature, and in 1826-1827 two plays of his were produced, *Mr Burchardt and his Family and Love and Policy*; in 1828 followed the comedy of *Flittedagen*. In 1830 he brought out what was a complete novelty in Danish literature, a comedy in rhymed verse, *Amor's Strokes of Genius*. In the same year Hertz published anonymously *Gengangerbrevene*, or Letters from a Ghost, which he pretended were written by Baggesen, who had died in 1826. The book was written in defence of J. L. Heiberg, and was full of satirical humour and fine critical insight. Its success was overwhelming; but Hertz preserved his anonymity, and the secret was not known until many years later. In 1832 he published a didactic poem, *Nature and Art*, and *Four Poetical Epistles*. *A Day on the Island of Als* was his next comedy, followed in 1835 by *The Only Fault*. Hertz passed through Germany and Switzerland into Italy in 1833; he spent the winter there, and returned the following autumn through France to Denmark. In 1836 his comedy of *The Savings Bank* enjoyed a great success. But it was not till 1837 that he gave the full measure of his genius in the romantic national drama of *Svend Dyrrings Hus*, a beautiful and original piece. His historical tragedy *Valdemar Atterdag* was not so well received in 1839; but in 1845 he achieved an immense success with his lyrical drama *Kong René's Datter* (*King René's Daughter*), which has been translated into almost every European language. To this succeeded the tragedy of *Ninon* in 1848, the romantic comedy of *Toniotta* in 1849, *A Sacrifice* in 1853, *The Youngest* in 1854. His lyrical poems appeared in successive collections, dated 1832, 1840 and 1844. From 1858 to 1859 he edited a literary journal entitled *Weekly Leaves*. His last drama, *Three Days in Padua*, was produced in 1869, and he died on the 25th of February of the next year.

Hertz is one of the first of Danish lyrical poets. His poems are full of colour and passion, his versification has more witchcraft in it than any other poet's of his age, and his style is grace itself. He has all the sensuous fire of Keats without his proclivity

to the antique. As a romantic dramatist he is scarcely less original. He has bequeathed to the Danish theatre, in *Svend Dyrrings Hus* and *King René's Daughter*, two pieces which have become classic. He is a troubadour by instinct; he has little or nothing of Scandinavian local colouring, and succeeds best when he is describing the scenery or the emotions of the glowing south.

His *Dramatic Works* (18 vols.) were published at Copenhagen in 1854-1873; and his *Poems* (4 vols.) in 1851-1862.

HERTZBERG, EWALD FRIEDRICH, COUNT VON (1725-1795), Prussian statesman, who came of a noble family which had been settled in Pomerania since the 13th century, was born at Lottin, in that province, on the 2nd of September 1725. After 1739 he studied, chiefly classics and history at the gymnasium at Stettin, and in 1742 entered the university of Halle as a student of jurisprudence, becoming in due course a doctor of laws in 1745. In addition to this principal study, he was also interested while at the university in historical and philosophical (Christian Wolff) studies. A first thesis for his doctorate, entitled *Jus publicum Brandenburgicum*, was not printed, because it contained a criticism of the existing condition of the state. Shortly afterwards Hertzberg entered the government service, in which he was first employed in the department of the state archives (of which he became director in 1750), soon after in the foreign office, and finally in 1763 as chief minister (*Cabinetminister*). In 1752 he married Baroness Marie von Knyphausen, a marriage which was happy, but childless.

For more than forty years Hertzberg played an active part in the Prussian foreign office. In this capacity he had a decisive influence on Prussian policy, both under Frederick the Great and Frederick William II. At the beginning of the Seven Years' War (1756) he took part as a political writer in the Hohenzollern-Habsburg quarrel, both in his *Ursachen, die S.K.M. in Preussen bewogen haben, sich wider die Absichten des Wienerischen Hofes zu setzen und deren Ausführung suworzukommen* ("Motives which have induced the king of Prussia to oppose the intentions of the court of Vienna, and to prevent them from being carried into effect"), and in his *Mémoire raisonné sur la conduite des cours de Vienne et de Saxe*, based on the secret papers taken by Frederick the Great from the archives of Dresden. After the defeat at Kolin (1757) he hastened to Pomerania in order to organize the national defence there and collect the necessary troops for the protection of the fortresses of Stettin and Colberg. In the same year he conducted the peace negotiations with Sweden, and was of great service in bringing about the peace of Huberturg (1763), on the conclusion of which the king received him with the words, "I congratulate you. You have made peace as I made war, one against many."

In the later years, too, of Frederick the Great's reign, Hertzberg played a considerable part in foreign policy. In 1772, in a memoir based upon comprehensive historical studies, he defended the Prussian claims to certain provinces of Poland. He also took part successfully as a publicist in the negotiations concerning the question of the Bavarian succession (1778) and those of the peace of Teschen (1779). But in 1780 he failed to uphold Prussian interests at the election of the bishop of Münster. In 1784 appeared Hertzberg's memoir containing a thorough study of the *Fürstenbund*. He championed this latest creation of Frederick the Great's mainly with a view to an energetic reform of the empire, though the idea of German unity was naturally still far from his mind. In 1785 followed "An explanation of the motives which have led the king of Prussia to propose to the other high estates of the empire an association for the maintenance of the system of the empire" (*Erklärung der Ursachen, welche S.M. in Preussen bewogen haben, ihren hohen Mäitständen des Reichs eine Association zur Erhaltung des Reichs systems antzutragen*). By upholding the *Fürstenbund* Hertzberg made many enemies, prominent among whom was the king's brother, Prince Henry. Though the *Fürstenbund* failed to effect a reform of the empire, it at any rate prevented the fulfilment of Joseph II.'s old desire for the incorporation of Bavaria with Austria. The last act of state in which Hertzberg took part under Frederick the Great

was the commercial treaty concluded in 1785 between Prussia and the United States.

With Frederick, especially in his later years, Hertzberg stood in very intimate personal relations and was often the king's guest at Sans-Souci. Under Frederick William II. his influential position at the court of Berlin was at first unshaken. The king at once received him with favour, as is clearly proved by Hertzberg's elevation to the rank of count in 1786; and Mirabeau would never have attacked him with such violence in his *Secret History of the Court of Berlin*, which appeared in 1788, if he had not seen in him the most powerful man after the king. In this attack Mirabeau seems to have been influenced by Hertzberg's personal enemies at the court. Hertzberg's political system remained on the whole the same under Frederick William II. as it had been under his predecessor. It was mainly characterized by a sharp opposition to the house of Habsburg and by a desire to win for Prussia the support of England, a policy supported by him in important memoirs of the years 1786 and 1787. His diplomacy was directed also against Austria's old ally, France. Hence it was chiefly owing to Hertzberg that in 1787, in spite of the king's unwillingness at first, Prussia intervened in Holland in support of the stadtholder William V. against the democratic French party (see HOLLAND: *History*). The success of this intervention, which was the practical realization of a plan very characteristic of Hertzberg, marks the culminating point in his career.

But the opposition between him and the new king, which had already appeared at the time of the conclusion of the triple alliance between Holland, England and Prussia, became more marked in the following years, when Hertzberg, relying upon this alliance, and in conscious imitation of Frederick II.'s policy at the time of the first partition of Poland, sought to take advantage of the entanglement of Austria with Russia in the war with Turkey to secure for Prussia an extension of territory by diplomatic intervention. According to his plan, Prussia was to offer her mediation at the proper moment, and in the territorial readjustments that the peace would bring, was to receive Danzig and Thorn as her portion. Beyond this he aimed at preventing the restoration of the hegemony of Austria in the Empire, and secretly cherished the hope of restoring Frederick the Great's Russian alliance.

With a curious obstinacy he continued to pursue these aims even when, owing to military and diplomatic events, they were already partly out of date. His personal position became increasingly difficult, as deep-rooted differences between him and the king were revealed during these diplomatic campaigns. Hertzberg wished to effect everything by peaceful means, while Frederick William II. was for a time determined on war with Austria. As regards Polish policy, too, their ideas came into conflict, Hertzberg having always been openly opposed to the total annihilation of the Polish kingdom. The same is true of the attitude of king and minister towards Great Britain. At the conferences at Reichenbach in the summer of 1790, this opposition became more and more acute, and Hertzberg was only with difficulty persuaded to come to an agreement merely on the basis of the *status quo*, as demanded by Pitt. The king's renunciation of any extension of territory was in Hertzberg's eyes impolitic, and this view of his was later endorsed by Bismarck. A letter which came to the eyes of the king, in which Hertzberg severely criticized the king's foreign policy, and especially his plans for attacking Russia, led to his dismissal on the 5th of July 1791. He afterwards made several attempts to exert an influence over foreign affairs, but in vain. The king showed himself more and more personally hostile to the ex-minister, and in later years pursued Hertzberg, now quite embittered, with every kind of petty persecution, even ordering his letters to be opened.

Even in his literary interests Hertzberg found an adversary in the ungrateful king, for Frederick William, to give one instance, made it so difficult for him to use the archives that in the end Hertzberg entirely gave up the attempt. He found, however, some recompense for all his disillusionment and discouragement

in learning, and, Wilhelm von Humboldt excepted, he was the most learned of all the Prussian ministers. As a member of the Berlin Academy especially, and, from 1786 onwards, as its curator, Hertzberg carried on a great and valuable activity in the world of learning. His yearly reports dealt with history, statistics and political science. The most interesting is that of 1784: *Sur la forme des gouvernements, et quelle est la meilleure*. This is directed exclusively against the absolute system (following Montesquieu), upholds a limited monarchy, and is in favour of extending to the peasants the right to be represented in the diet. He spoke for the last time in 1793 on Frederick the Great and the advantages of monarchy. After 1783 these discourses caused a great sensation, since Hertzberg introduced into them a review of the financial situation, which in the days of absolutism seemed an unprecedented innovation. Besides this, Hertzberg exerted himself as an academian to change the strongly French character of the Academy and make it into a truly German institution. He showed a keen interest in the old German language and literature. A special "German deputation" was set aside at the Academy and entrusted with the drawing up of a German grammar and dictionary. He also stood in very close relations with many of the German poets of the time, and especially with Daniel Schubart. Among the German historians in whom he took a great interest, he had the greatest esteem for Pufendorf. He was equally concerned in the improvement of the state of education. In 1780 he boldly took up the defence of German literature, which had been disparaged by Frederick the Great in his famous writing *De la littérature allemande*.

Hertzberg's frank and honourable nature little fitted him to be a successful diplomatist; but the course of history has justified many of his aims and ideals, and in Prussia his memory is honoured. He died at Berlin on the 22nd of May 1795.

AUTHORITIES.—(1) By Hertzberg himself: *The Mémoires de l'Académie* from 1780 on contain Hertzberg's discourses. The most noteworthy of them were printed in 1787. Here too is to be found: *Histoire de la dissertation [du roi] sur la littérature allemande*; see also *Recueil des déclarations, &c., qui ont été rédigés . . . pour la cour de Prusse par le ministre* (3 vols., 1789-1795); and an "Autobiographical Sketch" published by Hoppe in Schmidt's *Zeitschrift für Geschichtswissenschaft*, i. (1843). (2) Works dealing specially with Hertzberg: Mirabeau, *Histoire secrète de la cour de Berlin* (1788); P. F. Weddigen, *Hertzbergs Leben* (Bremen, 1797); E. L. Posselt, *Hertzbergs Leben* (Tübingen, 1798); H. Lehmann, in *Neustellener Programm* (1862); E. Fischer, in *Staatsanzeiger* (1873); M. Duncker, in *Historische Zeitschrift* (1877); Paul Baillet, in *Historische Zeitschrift* (1879); and *Allgemeine deutsche Biographie* (1880); H. Petrich, *Pommersche Lebensbilder* i. (1880); G. Dressler, *Friedrich II. und Hertzberg in ihrer Stellung zu den holländischen Wirren*, Breslauer Dissertation (1882); K. Krauel, *Hertzberg als Minister Friedrich Wilhelms II.* (Berlin, 1899); F. K. Wittichen, in *Historische Vierteljahrschrift*, 9 (1906); A. Th. Preuss, *Ernst Friedrich, Graf von Hertzberg* (Berlin, 1909). (3) General works: F. K. Wittichen, *Preussen und England, 1785-1788* (Heidelberg, 1902); F. Luckwaldt, *Die englisch-preussische Allianz von 1788 in den Forschungen zur brandenburgisch-preussischen Geschichte*, Bd. 15, and in the *Delbrückfestschrift* (Berlin, 1908); L. Sevin, *System der preussischen Geheimpolitik 1700-1791* (Heidelberger Dissertation, 1903); P. Wittichen, *Die polnische Politik Preussens 1788-1790* (Berlin, 1899); F. Andreae, *Preussische und russische Politik in Polen 1787-1789* (Berliner Dissertation, 1905); also W. Wenck, *Deutschland vor 100 Jahren* (2 vols., 1887, 1890); A. Harnack, *Geschichte der preussischen Akademie* (4 vols., 1899); *Consentia, Preussische Jahrbücher* (1904); J. Hashagen, "Hertzbergs Verhältnis zur deutschen Literatur," in *Zeitschrift für deutsche Philologie* for 1903.

HERTZEN, ALEXANDER (1812-1870), Russian author, was born at Moscow, a very short time before the occupation of that city by the French. His father, Ivan Yakovlev, after a personal interview with Napoleon, was allowed to leave, when the invaders arrived, as the bearer of a letter from the French to the Russian emperor. His family attended him to the Russian lines. Then the mother of the infant Alexander (a young German Protestant of Jewish extraction from Stuttgart, according to A. von Wurzbach), only seventeen years old, and quite unable to speak Russian, was forced to seek shelter for some time in a peasant's hut. A year later the family returned to Moscow, where Herzen passed his youth—remaining there, after completing his studies at the university, till 1834, when he was arrested and tried on a

charge of having assisted, with some other youths, at a festival during which verses by Sokolovsky, of a nature uncomplimentary to the emperor, were sung. The special commission appointed to try the youthful culprits found him guilty, and in 1835 he was banished to Viatka. There he remained till the visit to that city of the hereditary grand-duke (afterwards Alexander II.), accompanied by the poet Joukofsky, led to his being allowed to quit Viatka for Vladimir, where he was appointed editor of the official gazette of that city. In 1840 he obtained a post in the ministry of the interior at St Petersburg; but in consequence of having spoken too frankly about a death due to a police officer's violence, he was sent to Novgorod, where he led an official life, with the title of "state councillor," till 1842. In 1846 his father died, leaving him by his will a very large property. Early in 1847 he left Russia, never to return. From Italy, on hearing of the revolution of 1848, he hastened to Paris, whence he afterwards went to Switzerland. In 1852 he quitted Geneva for London, where he settled for some years. In 1864 he returned to Geneva, and after some time went to Paris, where he died on the 21st of January 1870.

His literary career began in 1842 with the publication of an essay, in Russian, on *Dilettantism in Science*, under the pseudonym of "Iskander," the Turkish form of his Christian name—convicts, even when pardoned, not being allowed in those days to publish under their own names. His second work, also in Russian, was his *Letters on the Study of Nature* (1845-1846). In 1847 appeared his novel *Kto Vinovat?* (Whose Fault?), and about the same time were published in Russian periodicals the stories which were afterwards collected and printed in London in 1854, under the title of *Prerannnie Rasskazy* (Interrupted Tales). In 1850 two works appeared, translated from the Russian manuscript, *Vom anderen Ufer* (From another Shore) and *Lettres de France et d'Italie*. In French appeared also his essay *Du Développement des idées révolutionnaires en Russie*, and his *Memoirs*, which, after being printed in Russian, were translated under the title of *Le Monde russe et la Révolution* (3 vols., 1860-1862), and were in part translated into English as *My Exile to Siberia* (2 vols., 1855). From a literary point of view his most important work is *Kto Vinovat?* a story describing how the domestic happiness of a young tutor, who marries the unacknowledged daughter of a Russian sensualist of the old type, dull, ignorant and genial, is troubled by a Russian sensualist of the new school, intelligent, accomplished and callous, without there being any possibility of saying who is most to be blamed for the tragic termination. But it was as a political writer that Hertenzen gained the vast reputation which he at one time enjoyed. Having founded in London his "Free Russian Press," of the fortunes of which, during ten years, he gave an interesting account in a book published (in Russian) in 1863, he issued from it a great number of Russian works, all levelled against the system of government prevailing in Russia. Some of these were essays, such as his *Baptized Property*, an attack on serfdom; others were periodical publications, the *Polyarnaya Zvezda* (or Polar Star), the *Kolokol* (or Bell), and the *Golos iz Rossii* (or Voices from Russia). The *Kolokol* soon obtained an immense circulation, and exercised an extraordinary influence. For three years, it is true, the founders of the "Free Press" went on printing, "not only without selling a single copy, but scarcely being able to get a single copy introduced into Russia"; so that when at last a bookseller bought ten shillings' worth of *Baptized Property*, the half-sovereign was set aside by the surprised editors in a special place of honour. But the death of the emperor Nicholas in 1855 produced an entire change. Hertenzen's writings, and the journals he edited, were smuggled wholesale into Russia, and their words resounded throughout that country, as well as all over Europe. Their influence became overwhelming. Evil deeds long hidden, evil-doers who had long prospered, were suddenly dragged into light and disgrace. His bold and vigorous language aptly expressed the thoughts which had long been secretly stirring Russian minds, and were now beginning to find a timid utterance at home. For some years his influence in Russia was a living force, the circulation of his writings was a vocation zealously

pursued. Stories tell how on one occasion a merchant, who had bought several cases of sardines at Nijni-Novgorod, found that they contained forbidden print instead of fish, and at another time a supposititious copy of the *Kolokol* was printed for the emperor's special use, in which a telling attack upon a leading statesman, which had appeared in the genuine number, was omitted. At length the sweeping changes introduced by Alexander II. greatly diminished the need for and appreciation of Hertenzen's assistance in the work of reform. The freedom he had demanded for the serfs was granted, the law-courts he had so long denounced were remodelled, trial by jury was established, liberty was to a great extent conceded to the press. It became clear that Hertenzen's occupation was gone. When the Polish insurrection of 1863 broke out, and he pleaded the insurgents' cause, his reputation in Russia received its death-blow. From that time it was only with the revolutionary party that he was in full accord.

In 1873 a collection of his works in French was commenced in Paris. A volume of posthumous works, in Russian, was published at Geneva in 1870. His *Memoirs* supply the principal information about his life, a sketch of which appears also in A. von Wurzbach's *Zeitgenossen*, pt. 7 (Vienna, 1871). See also the *Revue des deux mondes* for July 15 and Sept. 1, 1854. *Kto Vinovat?* has been translated into German under the title of *Wer ist schuld?* in Wolffsohn's *Russlands Novellendichter*, vol. iii. The title of *My Exile in Siberia* is misleading; he was never in that country. (W. R. S.-R.)

HERULI, a Teutonic tribe which figures prominently in the history of the migration period. The name does not occur in writings of the first two centuries A.D. Where the original home of the Heruli was situated is never clearly stated. Jordanes says that they had been expelled from their territories by the Danes, from which it may be inferred that they belonged either to what is now the kingdom of Denmark, or the southern portion of the Jutish peninsula. They are mentioned first in the reign of Gallienus (260-268), when we find them together with the Goths ravaging the coasts of the Black Sea and the Aegean. Shortly afterwards, in A.D. 289, they appear in the region about the mouth of the Rhine. During the 4th century they frequently served together with the Batavi in the Roman armies. In the 5th century we again hear of piratical incursions by the Heruli in the western seas. At the same time they had a kingdom in central Europe, apparently in or round the basin of the Elbe. Together with the Thuringi and Warni they were called upon by Theodoric the Ostrogoth about the beginning of the 6th century to form an alliance with him against the Frankish king Clovis, but very shortly afterwards they were completely overthrown in war by the Langobardi. A portion of them migrated to Sweden, where they settled among the Götar, while others crossed the Danube and entered the Roman service, where they are frequently mentioned later in connexion with the Gothic wars. After the middle of the 6th century, however, their name completely disappears. It is curious that in English, Frankish and Scandinavian works they are never mentioned, and there can be little doubt that they were known, especially among the western Teutonic peoples, by some other name. Probably they are identical either with the North Suabi or with the Iuti. The name Heruli itself is identified by many with the A.S. *eorlas* (nobles), O.S. *erlas* (men), the singular of which (*erilas*) frequently occurs in the earliest Northern inscriptions, apparently as a title of honour. The Heruli remained heathen until the overthrow of their kingdom, and retained many striking primitive customs. When threatened with death by disease or old age, they were required to call in an executioner, who stabbed them on the pyre. Suttice was also customary. They were entirely devoted to warfare and served not only in the Roman armies, but also in those of all the surrounding nations. They disdained the use of helmets and coats of mail, and protected themselves only with shields.

See Georgius Syncellus; Mamertinus *Paneg. Maximi*; Ammianus Marcellinus; Zosimus i. 39; Idatius, *Chronica*; Jordanes, *De origine Getarum*; Procopius, esp. *Bellum Gothicum*, ii. 14 l.; *Bellum Persicum*, ii. 25; Faustus Dicoonus, *Hist. Langobardorum*, i. 20; K. Zeuss, *Die Deutschen und die Nachbarstämme*, pp. 476 ff. (Munich, 1837). (F. G. M. B.)

HERVÁS Y PANDURO, LORENZO (1735-1809), Spanish philologist, was born at Horcajo (Cuenca) on the 10th of May 1735. He joined the Jesuits on the 20th of September 1745 and in course of time became successively professor of philosophy and humanities at the seminaries of Madrid and Murcia. When the Jesuit order was banished from Spain in 1767, Hervás settled at Forlì, and devoted himself to the first part of his *Idea dell' Universo* (22 vols., 1778-1792). Returning to Spain in 1798, he published his famous *Catálogo de las lenguas de las naciones conocidas* (6 vols., 1800-1805), in which he collected the philological peculiarities of three hundred languages and drew up grammars of forty languages. In 1802 he was appointed librarian of the Quirinal Palace in Rome, where he died on the 24th of August 1809. Max Müller credits him with having anticipated Humboldt, and with making "one of the most brilliant discoveries in the history of the science of language" by establishing the relation between the Malay and Polynesian family of speech.

HERVEY, JAMES (1714-1758), English divine, was born at Hardington, near Northampton, on the 26th of February 1714, and was educated at the grammar school of Northampton, and at Lincoln College, Oxford. Here he came under the influence of John Wesley and the Oxford methodists; ultimately, however, while retaining his regard for the men and his sympathy with their religious aims, he adopted a thoroughly Calvinistic creed, and resolved to remain in the Anglican Church. Having taken orders in 1737, he held several curacies, and in 1752 succeeded his father in the family livings of Weston Favell and Collingtree. He was never robust, but was a good parish priest and a zealous writer. His style is often bombastic, but he displays a rare appreciation of natural beauty, and his simple piety made him many friends. His earliest work, *Meditations and Contemplations*, said to have been modelled on Robert Boyle's *Occasional Reflexions on various Subjects*, within fourteen years passed through as many editions. *Theron and Aspasio, or a series of Letters upon the most important and interesting Subjects*, which appeared in 1755, and was equally well received, called forth some adverse criticism even from Calvinists, on account of tendencies which were considered to lead to antinomianism, and was strongly objected to by Wesley in his *Preservative against unsettled Notions in Religion*. Besides carrying into England the theological disputes to which the *Marrow of Modern Divinity* had given rise in Scotland, it also led to what is known as the Sandemanian controversy as to the nature of saving faith. Hervey died on the 25th of December 1758.

A "new and complete" edition of his *Works*, with a memoir, appeared in 1797. See also *Collection of the Letters of James Hervey, to which is prefixed an account of his Life and Death*, by Dr Birch (1760).

HERVEY DE SAINT DENYS, MARIE JEAN LÉON, MARQUIS (1823-1892), French Orientalist and man of letters, was born in Paris in 1823. He devoted himself to the study of Chinese, and in 1851 published his *Recherches sur l'agriculture et l'horticulture des Chinois*, in which he dealt with the plants and animals that might be acclimatized in the West. At the Paris Exhibition of 1867 he acted as commissioner for the Chinese exhibits; in 1874 he succeeded Stanislas Julien in the chair of Chinese at the Collège de France; and in 1878 he was elected a member of the Académie des Inscriptions et de Belles-Lettres. His works include *Poésies de l'époque des Tang* (1862), translated from the Chinese; *Ethnographie des peuples étrangers à la Chine*, translated from Ma-Touan-Lin (1876-1883); *Li-Sao* (1870), from the Chinese; *Mémoires sur les doctrines religieuses; de Confucius et de l'école des lettres* (1887); and translations of some Chinese stories not of classical interest but valuable for the light they throw on oriental custom. Hervey de Saint Denys also translated some works from the Spanish, and wrote a history of the Spanish drama. He died in Paris on the 2nd of November 1892.

HERVEY OF ICKWORTH, JOHN HERVEY, BARON (1696-1743), English statesman and writer, eldest son of John, 1st earl of Bristol, by his second marriage, was born on the 13th of October 1696. He was educated at Westminster school and at Clare Hall, Cambridge, where he took his M.A. degree in 1715.

In 1716 his father sent him to Paris, and thence to Hanover to pay his court to George I. He was a frequent visitor at the court of the prince and princess of Wales at Richmond, and in 1720 he married Mary Lepell, who was one of the princess's ladies-in-waiting, and a great court beauty. In 1723 he received the courtesy title of Lord Hervey on the death of his half-brother Carr, and in 1725 he was elected M.P. for Bury St Edmunds. He had been at one time on very friendly terms with Frederick, prince of Wales, but from 1731 he quarrelled with him, apparently because they were rivals in the favour of Anne Vane. These differences probably account for the scathing picture he draws of the prince's callous conduct. Hervey had been hesitating between William Pulteney (afterwards earl of Bath) and Walpole, but in 1730 he definitely took sides with Walpole, of whom he was thenceforward a faithful adherent. He was assumed by Pulteney to be the author of *Sedition and Defamation display'd with a Dedication to the patrons of The Craftsman* (1731). Pulteney, who, up to this time, had been a firm friend of Hervey, replied with *A Proper Reply to a late Scurrilous Libel*, and the quarrel resulted in a duel from which Hervey narrowly escaped with his life. Hervey is said to have denied the authorship of both the pamphlet and its dedication, but a note on the MS. at Ickworth, apparently in his own hand, states that he wrote the latter. He was able to render valuable service to Walpole from his influence over the queen. Through him the minister governed Queen Caroline and indirectly George II. Hervey was vice-chamberlain in the royal household and a member of the privy council. In 1733 he was called to the House of Lords by writ in virtue of his father's barony. In spite of repeated requests he received no further preferment until after 1740, when he became lord privy seal. After the fall of Sir Robert Walpole he was dismissed (July 1742) from his office. An excellent political pamphlet, *Miscellaneous Thoughts on the present Posture of Foreign and Domestic Affairs*, shows that he still retained his mental vigour, but he was liable to epilepsy, and his weak appearance and rigid diet were a constant source of ridicule to his enemies. He died on the 5th of August 1743. He predeceased his father, but three of his sons became successively earls of Bristol.

Hervey wrote detailed and brutally frank memoirs of the court of George II. from 1727 to 1737. He gave a most unflattering account of the king, and of Frederick, prince of Wales, and their family squabbles. For the queen and her daughter, Princess Caroline, he had a genuine respect and attachment, and the princess's affection for him was commonly said to be the reason for the close retirement in which she lived after his death. The MS. of Hervey's memoirs was preserved by the family, but his son, Augustus John, 3rd earl of Bristol, left strict injunctions that they should not be published until after the death of George III. In 1848 they were published under the editorship of J. W. Croker, but the MS. had been subjected to a certain amount of mutilation before it came into his hands. Croker also softened in some cases the plainness of the original. Hervey's bitter account of court life and intrigues resembles in many points the memoirs of Horace Walpole, and the two books corroborate one another in many statements that might otherwise have been received with suspicion.

Until the publication of the *Memoirs* Hervey was chiefly known as the object of savage satire on the part of Pope, in whose works he figured as Lord Fanny, Sporus, Adonis and Narcissus. The quarrel is generally put down to Pope's jealousy of Hervey's friendship with Lady Mary Wortley Montagu. In the first of the *Imitations of Horace*, addressed to William Fortescue, "Lord Fanny" and "Sappho" were generally identified with Hervey and Lady Mary, although Pope denied the personal intention. Hervey had already been attacked in the *Dunciad* and the *Bathos*, and he now retaliated. There is no doubt that he had a share in the *Verses to the Imitator of Horace* (1732) and it is possible that he was the sole author. In the *Letter from a nobleman at Hampton Court to a Doctor of Divinity* (1733), he scoffed at Pope's deformity and humble birth. Pope's reply was a *Letter to a Noble Lord*, dated November 1733, and the portrait of Sporus in the *Epistle to Dr Arbuthnot* (1735), which forms the prologue to

the satires. Many of the insinuations and insults contained in it are borrowed from Pulteney's libel. The malicious caricature of Sporus does Hervey great injustice, and he is not much better treated by Horace Walpole, who in reporting his death in a letter (14th of August 1743) to Horace Mann, said he had outlived his last inch of character. Nevertheless his writings prove him to have been a man of real ability, condemned by Walpole's tactics and distrust of able men to spend his life in court intrigue, the weapons of which, it must be owned, he used with the utmost adroitness. His wife Lady Hervey [Molly Lepell] (1700-1768), of whom an account is to be found in Lady Louisa Stuart's *Anecdotes*, was a warm partisan of the Stuarts. She retained her wit and charm throughout her life, and has the distinction of being the recipient of English verses by Voltaire.

See Hervey's *Memoirs of the Court of George II.*, edited by J. W. Croker (1848); and an article by G. F. Russell Barker in the *Dict. Nat. Biog.* (vol. xxvii., 1891). Besides the *Memoirs* he wrote numerous political pamphlets, and some occasional verses.

HERVIEU, PAUL (1857-), French dramatist and novelist, was born at Neuilly (Seine) on the 2nd of November 1857. He was called to the bar in 1877, and, after serving some time in the office of the president of the council, he qualified for the diplomatic service, but resigned on his nomination in 1881 to a secretaryship in the French legation in Mexico. He contributed novels, tales and essays to the chief Parisian papers and reviews, and published a series of clever novels, including *L'Inconnu* (1887), *Férit* (1890), *L'Exorciste* (1891), *Peints par eux-mêmes* (1893), an ironical study written in the form of letters, and *L'Armateur* (1895), dramatized in 1905 by Eugène Brieux. But his most important work consists of a series of plays: *Les Paroles restent* (Vaudeville, 17th of November 1892); *Les Tenailles* (Théâtre Français, 28th of September 1895); *La Loi de l'homme* (Théâtre Français, 15th of February 1897); *La Course du flambeau* (Vaudeville, 17th of April 1901); *Point de lendemain* (Odéon, 18th of October 1901), a dramatic version of a story by Vivaut Denon; *L'Énigme* (Théâtre Français, 5th of November 1901); *Théodine de Méricourt* (Théâtre Sarah Bernhardt, 23rd of September 1902); *Le Dédale* (Théâtre Français, 19th of December 1903), and *Le Récit* (Théâtre Français, 18th of December 1905). These plays are built upon a severely logical method, the mechanism of which is sometimes so evident as to destroy the necessary sense of illusion. The closing words of *La Course du flambeau*—"Pour ma fille, j'ai tué ma mère"—are an example of his selection of a plot representing an extreme theory. The riddle in *L'Énigme* (staged at Wyndham's Theatre, London, March 1st 1902, as *Cæsar's Wife*) is, however, worked out with great art, and *Le Dédale*, dealing with the obstacles to the remarriage of a divorced woman, is reckoned among the masterpieces of the modern French stage. He was elected to the French Academy in 1900.

See A. Binet, in *L'Année psychologique*, vol. x. Hervieu's *Théâtre* was published by Lemerre (3 vols., 1900-1904).

HERWARTH VON BITTENFELD, KARL EBERHARD (1796-1884), Prussian general field-marshal, came of an aristocratic family which had supplied many distinguished officers to the Prussian army. He entered the Guard infantry in 1811, and served through the War of Liberation (1813-15), distinguishing himself at Lützen and Paris. During the years of peace he rose slowly to high command. In the Berlin revolution of 1848 he was on duty at the royal palace as colonel of the 1st Guards. Major-general in 1852, and lieutenant-general in 1856, he received the grade of general of infantry and the command of the VIIIth (Westphalian) Army Corps in 1860. In the Danish War of 1864 he succeeded to the command of the Prussians when Prince Frederick Charles became commander-in-chief of the Allies, and it was under his leadership that the Prussians forced the passage into Aalen on the 29th of June. In the war of 1866 Herwarth commanded the "Army of the Elbe" which overran Saxony and invaded Bohemia by the valley of the Elbe and Iser. His troops won the actions of Hühnerwasser and Münchengrätz, and at Königgrätz formed the right wing of the Prussian army. Herwarth himself directed the battle against the Austrian left flank. In 1870 he was not employed in the field, but was in charge of the scarcely less important business of organizing

and forwarding all the reserves and material required for the armies in France. In 1871 his great services were recognized by promotion to the rank of field-marshal. The rest of his life was spent in retirement at Bonn, where he died in 1884. Since 1889 the 13th (1st Westphalian) Infantry has borne his name.

See G. F. M. Herwarth von Bittenfeld (Münster, 1896).

HERWEGH, GEORG (1817-1875), German political poet, was born at Stuttgart on the 31st of May 1817, the son of a restaurant keeper. He was educated at the gymnasium of his native city, and in 1835 proceeded to the university of Tübingen as a theological student, where, with a view to entering the ministry, he entered the protestant theological seminary. But the strict discipline was distasteful; he broke the rules and was expelled in 1836. He next studied law, but having gained the interest of August Lewald (1793-1871) by his literary ability, he returned to Stuttgart, where Lewald obtained for him a journalistic post. Called out for military service, he had hardly joined his regiment when he committed an act of flagrant insubordination, and fled to Switzerland to avoid punishment. Here he published his *Gedichte eines Lebendigen* (1841), a volume of political poems, which gave expression to the fervent aspirations of the German youth of the day. The work immediately rendered him famous, and although confiscated, it soon ran through several editions. The idea of the book was a refutation of the opinions of Prince Pückler-Muskau (q.v.) in his *Briefe eines Verstorbenen*. He next proceeded to Paris and in 1842 returned to Germany, visiting Jena, Leipzig, Dresden and Berlin—a journey which was described as being a "veritable triumphal progress." His military insubordination appears to have been forgiven and forgotten, for in Berlin King Frederick William IV. had him introduced to him and used the memorable words: "ich liebe eine gesinnungsvolle Opposition" ("I admire an opposition, when dictated by principle.") Herwegh next returned to Paris, where he published in 1844 the second volume of his *Gedichte eines Lebendigen*, which, like the first volume, was confiscated by the German police. At the head of a revolutionary column of German working men, recruited in Paris, Herwegh took an active part in the South German rising in 1848; but his raw troops were defeated on the 27th of April at Schopphelm in Baden and, after a very feeble display of heroism, he just managed to escape to Switzerland, where he lived for many years on the proceeds of his literary productions. He was later (1866) permitted to return to Germany, and died at Lichtenthal near Baden-Baden on the 7th of April 1875. A monument was erected to his memory there in 1904. Besides the above-mentioned works, Herwegh published *Einundzwanzig Bogen aus der Schweiz* (1843), and translations into German of A. de Lamartine's works and of seven of Shakespeare's plays. Posthumously appeared *Neue Gedichte* (1877).

Herwegh's correspondence was published by his son Marcel in 1898. See also Johannes Scherr, *Georg Herwegh: literarische und politische Blätter* (1843); and the article by Franz Muncker in the *Allgemeine deutsche Biographie*.

HERZBERG, a town of Germany, in the Prussian province of Hanover, situated under the south-western declivity of the Harz, on the Sieber, 25 m. N.W. from Nordhausen by the railway to Osterode-Hildesheim. Pop. (1905) 3806. It contains an Evangelical and a Roman Catholic church, and a botanical garden, and has manufactures of cloth and cigars, and weaving and dyeing works. The breeding of canaries is extensively carried on here and in the district. On a hill to the south-west of the town lies the castle of Herzberg, which in 1157 came into the possession of Henry the Lion, duke of Saxony, and afterwards was one of the residences of a branch of the house of Brunswick.

HERZBERG, a town of Germany, in the Prussian province of Saxony, on the Schwarze Elster, 25 m. S. from Jüterbog by the railway Berlin-Röderau-Dresden. It has a church (Evangelical) dating from the 13th century and a medieval town hall. Its industries include the founding and turning of metal, agricultural machinery and boot-making. Pop. (1905) 4043.

HERZL, THEODOR (1860-1904), founder of modern political Zionism (q.v.), was born in Budapest on the 2nd of May 1860,

and died at Edlach on the 3rd of July 1904. The greater part of his career was associated with Vienna, where he acquired high repute as a literary journalist. He was also a dramatist, and apart from his prominence as a Jewish Nationalist would have found a niche in the temple of fame. All his other claims to renown, however, sink into insignificance when compared with his work as the reviver of Jewish hopes for a restoration to political autonomy. Herzl was stirred by sympathy for the misery of Jews under persecution, but he was even more powerfully moved by the difficulties experienced under conditions of assimilation. Modern anti-Semitism, he felt, was both like and unlike the medieval. The old physical attacks on the Jews continued in Russia, but there was added the reluctance of several national groups in Europe to admit the Jews to social equality. Herzl believed that the humanitarian hopes which inspired men at the end of the 18th and during the larger part of the 19th centuries had failed. The walls of the ghettos had been cast down, but the Jews could find no entry into the comity of nations. The new nationalism of 1848 did not deprive the Jews of political rights, but it denied them both the amenities of friendly intercourse and the opportunity of distinction in the university, the army and the professions. Many Jews questioned this diagnosis, and refused to see in the new anti-Semitism (*q.v.*) which spread over Europe in 1881 any more than a temporary reaction against the cosmopolitanism of the French Revolution. In 1896 Herzl published his famous pamphlet "Der Judenstaat." Holding that the only alternatives for the Jews were complete merging by intermarriage or self-preservation by a national re-union, he boldly advocated the second course. He did not at first insist on Palestine as the new Jewish home, nor did he attach himself to religious sentiment. The expectation of a Messianic restoration to the Holy Land has always been strong, if often latent, in the Jewish consciousness. But Herzl approached the subject entirely on its secular side, and his solution was economic and political rather than sentimental. He was a strong advocate for the complete separation of Church and State. The influence of Herzl's pamphlet, the progress of the movement he initiated, the subsequent modifications of his plans, are told at length in the article ZIONISM.

His proposals undoubtedly roused an extraordinary enthusiasm, and though he almost completely failed to win to his cause the masses, he rallied the masses with sensational success. He unexpectedly gained the accession of many Jews by race who were indifferent to the religious aspect of Judaism, but he quite failed to convince the leaders of Jewish thought, who from first to last remained (with such conspicuous exceptions as Nordau and Zangwill) deaf to his pleading. The orthodox were at first cool because they had always dreamed of a nationalism inspired by messianic ideals, while the liberals had long come to dissociate those universalistic ideals from all national limitations. Herzl, however, succeeded in assembling several congresses at Basel (beginning in 1897), and at these congresses were enacted remarkable scenes of enthusiasm for the cause and devotion to its leader. At all these assemblies the same ideal was formulated: "the establishing for the Jewish people a publicly and legally assured home in Palestine." Herzl's personal charm was irresistible. Among his political opponents he had some close personal friends. His sincerity, his eloquence, his tact, his devotion, his power, were recognized on all hands. He spent his whole strength in the furtherance of his ideas. Diplomatic interviews, exhausting journeys, impressive mass meetings, brilliant literary propaganda—all these methods were employed by him to the utmost limit of self-denial. In 1901 he was received by the sultan; the pope and many European statesmen gave him audiences. The British government was ready to grant land for an autonomous settlement in East Africa. This last scheme was fatal to Herzl's peace of mind. Even as a temporary measure, the choice of an extra-Palestinian site for the Jewish state was bitterly opposed by many Zionists; others (with whom Herzl appears to have sympathized) thought that as Palestine was, at all events momentarily, inaccessible, it was expedient to form a settlement elsewhere. Herzl's health had been failing and he did not long

survive the initiation of the somewhat embittered "territorial" controversy. He died in the summer of 1904, amid the consternation of supporters and the deep grief of opponents of his Zionist aims.

Herzl was beyond question the most influential Jewish personality of the 19th century. He had no profound insight into the problem of Judaism, and there was no lasting validity in his view that the problem—the thousands of years' old mystery—could be solved by a retrogression to local nationality. But he brought home to Jews the perils that confronted them; he compelled many a "semi-detached" son of Israel to rejoin the camp; he forced the "assimilationists" to realize their position and to define it; his scheme gave a new impulse to "Jewish culture," including the popularization of Hebrew as a living speech; and he effectively roused Jews all the world over to an earnest and vital interest in their present and their future. Herzl thus left an indelible mark on his time, and his renown is assured whatever be the fate in store for the political Zionism which he founded and for which he gave his life. (I. A.)

HERZOG, HANS (1819-1894), Swiss general, was born at Aarau. He became a Swiss artillery lieutenant in 1840, and then spent six years in travelling (visiting England among other countries), before he became a partner in his father's business in 1846. In 1847 he saw his first active service (as artillery captain) in the short Swiss *Sonderbund* war. In 1860 he abandoned mercantile pursuits for a purely military career, becoming colonel and inspector-general of the Swiss artillery. In 1870 he was commander-in-chief of the Swiss army, which guarded the Swiss frontier, in the Jura, during the Franco-German War, and in February 1871, as such, concluded the Convention of Verrières with General Clinchant for the disarming and the interning of the remains of Bourbaki's army, when it took refuge in Switzerland. In 1875 he became the commander-in-chief of the Swiss artillery, which he did much to reorganize, helping also in the reorganization of the other branches of the Swiss army. He died in 1894 at his native town of Aarau. (W. A. B. C.)

HERZOG, JOHANN JAKOB (1805-1882), German Protestant theologian, was born at Basel on the 12th of September 1805. He studied at Basel and Berlin, and eventually (1854) settled at Erlangen as professor of church history. He died there on the 30th of September 1882, having retired in 1877. His most noteworthy achievement was the publication of the *Realencyklopädie für protestantische Theologie und Kirche* (1853-1868, 22 vols.), of which he undertook a new edition with G. L. Plitt (1836-1880) in 1877, and after Plitt's death with Albert Hauck (b. 1845). Hauck began the publication of the third edition in 1896 (completed in 22 vols., 1909).

His other works include *Joh. Calvin* (1843), *Leben Okolampads* (1843), *Die romanischen Waldenser* (1853), *Abriss der gesamten Kirchengeschichte* (3 vols., 1876-1882, 2nd ed., G. Koffmane, Leipzig, 1890-1892).

HESEKIEL, JOHANN GEORG LUDWIG (1810-1874), German author, was born on the 12th of August 1810 in Halle, where his father, distinguished as a writer of sacred poetry, was a Lutheran pastor. Hesekiel studied history and philosophy in Halle, Jena and Berlin, and devoted himself in early life to journalism and literature. In 1848 he settled in Berlin, where he lived until his death on the 26th of February 1874, achieving a considerable reputation as a writer and as editor of the *Neue Preussische Zeitung*. He attempted many different kinds of literary work, the most ambitious being perhaps his patriotic songs *Preussenlieder*, of which he published a volume during the revolutionary excitement of 1848-1849. Another collection—*Neue Preussenlieder*—appeared in 1864 after the Danish War, and a third in 1870—*Gegen die Franzosen, Preussische Kriegs- und Königslieder*. Among his novels may be mentioned *Unter dem Eisensahn* (1864) and *Der Schulheiss vom Zeyst* (1875). The best known of his works is his biography of Prince Bismarck (*Das Buch vom Fürsten Bismarck*) (3rd ed., 1873; English trans. by R. H. Mackenzie).

HESILRIGE (or **HESLEBIG**), **SIR ARTHUR**, 2nd Bart. (d. 1661), English parliamentarian, was the eldest son of Sir Thomas Hesilrige, 1st baronet (c. 1622), of Noseley, Leicestershire, a

member of a very ancient family settled in Northumberland and Leicestershire, and of Frances, daughter of Sir William Gorges, of Alderton, Northamptonshire. He early imbibed strong puritanical principles, and showed a special antagonism to Laud. He sat for Leicestershire in the Short and Long Parliaments in 1640, and took a principal part in Strafford's attainder, the Root and Branch Bill and the Militia Bill of the 7th of December 1641, and was one of the five members impeached on the 3rd of January 1642. He showed much activity in the Great Rebellion, raised a troop of horse for Essex, fought at Edgchill, commanded in the West under Waller, being nicknamed his *fidus Achates*, and distinguished himself at the head of his cuirassiers, "The Lobsters," at Lansdown on the 5th of July 1643, at Roundway Down on the 13th of July, at both of which battles he was wounded, and at Cheriton, March 29th 1644. On the occasion of the breach between the army and the parliament, Hesilrige supported the former, took Cromwell's part in his dispute with Manchester and Essex, and on the passing of the Self-denying Ordinance gave up his commission and became one of the leaders of the Independent party in parliament. On the 30th of December 1647 he was appointed governor of Newcastle, which he successfully defended, besides defeating the Royalists on the 2nd of July 1648 and regaining Tynemouth. In October he accompanied Cromwell to Scotland, and gave him valuable support in the Scottish expedition in 1650. Hesilrige, though he approved of the king's execution, had declined to act as judge on his trial. He was one of the leading men in the Commonwealth, but Cromwell's expulsion of the Long Parliament threw him into antagonism, and he opposed the Protectorate and refused to pay taxes. He was returned for Leicester to the parliaments of 1654, 1656 and 1659, but was excluded from the two former. He refused a seat in the Lords, whither Cromwell sought to relegate him, and succeeded in again obtaining admission to the Commons in January 1658. On Cromwell's death Hesilrige refused support to Richard, and was instrumental in effecting his downfall. He was now one of the most influential men in the council and in parliament. He attempted to maintain a republican parliamentary administration, "to keep the sword subservient to the civil magistrate," and opposed Lambert's schemes. On the latter succeeding in expelling the parliament, Hesilrige turned to Monk for support, and assisted his movements by securing Portsmouth on the 3rd of December 1659. He marched to London, and was appointed one of the council of state on the 2nd of January 1660, and on the 11th of February a commissioner for the army. He was completely deceived by Monk, and trusting to his assurance of fidelity to "the good old cause" consented to the retirement of his regiment from London. At the Restoration his life was saved by Monk's intervention, but he was imprisoned in the Tower, where he died on the 7th of January 1661. Clarendon describes Hesilrige as "an absurd, bold man." He was rash, "hare-brained," devoid of tact and had little claim to the title of a statesman, but his energy in the field and in parliament was often of great value to the parliamentary cause. He exposed himself to considerable obloquy by his exactions and appropriations of confiscated landed property, though the accusation brought against him by John Lilburne was examined by a parliamentary committee and adjudged to be false. Hesilrige married (1) Frances, daughter of Thomas Elmes of Lilford, Northamptonshire, by whom he had two sons and two daughters, and (2) Dorothy, sister of Robert Greville, 2nd Lord Brooke, by whom he had three sons and five daughters. The family was represented in 1907 by his descendant Sir Arthur Grey Hazlerigg of Noseley, 13th Baronet.

AUTHORITIES—Article on Hesilrige by C. H. Firth in the *Dict. of Nat. Biography*, and authorities there quoted; *Early History of the Family of Hesilrige*, by W. G. D. Fletcher; *Cal. of State Papers, Domestic*, 1631-1664, where there are a large number of important references, as also in *Hist. MSS., Comm. Series. MSS. of Earl Comper, Duke of Leeds and Duke of Parland*; *Egerton MSS.* 2618, *Harleian* 7001 f. 198, and in the *Sloane, Stowe and Additional* collections in the British Museum; also S. R. Gardiner, *Hist. of England, Hist. of the Great Civil War and Commonwealth*; Clarendon's *History, State Papers and Cal. of State Papers*, J. L. Sanford's *Studies of the*

Great Rebellion. His life is written by Noble in the *House of Cromwell*, i. 403. For his public letters and speeches in parliament see the catalogue of the British Museum.

HESIOD, the father of Greek didactic poetry, probably flourished during the 8th century B.C. His father had migrated from the Aeolic Cyme in Asia Minor to Boeotia; and Hesiod and his brother Perses were born at Ascra, near mount Helicon (*Works and Days*, 635). Here, as he fed his father's flocks, he received his commission from the Muses to be their prophet and poet—a commission which he recognized by dedicating to them a tripod won by him in a contest of song (see below) at some funeral games at Chalcis in Euboea, still in existence at Helicon in the age of Pausanias (*Theogony*, 20-34, *W. and D.*, 656; Pausanias ix. 38. 3). After the death of his father Hesiod is said to have left his native land in disgust at the result of a law-suit with his brother and to have migrated to Naupactus. There was a tradition that he was murdered by the sons of his host in the sacred enclosure of the Nemean Zeus at Oeneon in Locris (Thucydides iii. 96; Pausanias ix. 31); his remains were removed for burial by command of the Delphic oracle to Orchomenus in Boeotia, where the Ascræans settled after the destruction of their town by the Thespians, and where, according to Pausanias, his grave was to be seen.

Hesiod's earliest poem, the famous *Works and Days*, and according to Boeotian testimony the only genuine one, embodies the experiences of his daily life and work, and, interwoven with episodes of fable, allegory, and personal history, forms a sort of Boeotian shepherd's calendar. The first portion is an ethical enforcement of honest labour and dissuasive of strife and idleness (1-383); the second consists of hints and rules as to husbandry (384-764); and the third is a religious calendar of the months, with remarks on the days most lucky or the contrary for rural or nautical employments. The connecting link of the whole poem is the author's advice to his brother, who appears to have bribed the corrupt judges to deprive Hesiod of his already scantier inheritance, and to whom, as he wasted his substance lounging in the agora, the poet more than once returned good for evil, though he tells him there will be a limit to this unmerited kindness. In the *Works and Days* the episodes which rise above an even didactic level are the "Creation and Equipment of Pandora," the "Five Ages of the World" and the much-admired "Description of Winter" (by some critics judged post-Hesiodic). The poem also contains the earliest known fable in Greek literature, that of "The Hawk and the Nightingale." It is in the *Works and Days* especially that we glean indications of Hesiod's rank and condition in life, that of a stay-at-home farmer of the lower class, whose sole experience of the sea was a single voyage of 40 yds. across the Euripus, and an old-fashioned bachelor whose misogynic views and prejudice against matrimony have been conjecturally traced to his brother Perses having a wife as extravagant as himself.

The other poem attributed to Hesiod or his school which has come down in great part to modern times is *The Theogony*, a work of grander scope, inspired alike by older traditions and abundant local associations. It is an attempt to work into system, as none had essayed to do before, the floating legends of the gods and goddesses and their offspring. This task Herodotus (ii. 53) attributes to Hesiod, and he is quoted by Plato in the *Symposium* (178 B) as the author of the *Theogony*. The first to question his claim to this distinction was Pausanias, the geographer (A.D. 200). The Alexandrian grammarians had no doubt on the subject; and indications of the hand that wrote the *Works and Days* may be found in the severe strictures on women, in the high esteem for the wealth-giver Plutus and in coincidences of verbal expression. Although, no doubt, of Hesiodic origin, in its present form it is composed of different recensions and numerous later additions and interpolations. The *Theogony* consists of three divisions—(1) a cosmogony, or creation; (2) a theogony proper, recounting the history of the dynasties of Zeus and Cronus; and (3) a brief and abruptly terminated heroogony, the starting-point not improbably of the supplementary poem, the *κατάλογος*, or "Lists of Women"

who wedded immortals, of which all but a few fragments are lost.¹ The poem (1-116) addressed to the Heliconian and Pierian muses, is considered to have been variously enlarged, altered and arranged by successive rhapsodists. The poet has interwoven several episodes of rare merit, such as the contest of Zeus and the Olympian gods with the Titans, and the description of the prison-house in which the vanquished Titans are confined, with the Giants for keepers and Day and Night for janitors (735 seq.).

The only other poem which has come down to us under Hesiod's name is the *Shield of Heracles*, the opening verses of which are attributed by a nameless grammarian to the fourth book of *Eoiai*. The theme of the piece is the expedition of Heracles and Iolaus against the robber Cynus; but its main object apparently is to describe the shield of Heracles (241-317). It is clearly an imitation of the Homeric account of the shield of Achilles (*Iliad*, xviii. 479) and is now generally considered spurious. Titles and fragments of other lost poems of Hesiod have come down to us: didactic, as the *Maxims of Cheiron*; genealogical, as the *Aegimius*, describing the contest of that mythical ancestor of the Dorians with the Lapithae; and mythical, as the *Marriage of Creys* and the *Descent of Theseus to Hades*.

Recent editions of Hesiod include the *Ἄγῶν Ὀυήπου καὶ Ἡρόδου*, the contest of song between Homer and Hesiod at the funeral games held in honour of King Amphidamas at Chalcis. This little tract belongs to the time of Hadrian, who is actually mentioned as having been present during its recitation, but is founded on an earlier account by the sophist Alcidas (*q.v.*). Quotations (old and new) are made from the works of both poets, and, in spite of the sympathies of the audience, the judge decides in favour of Hesiod. Certain biographical details of Homer and Hesiod are also given.

A strong characteristic of Hesiod's style is his sententious and proverbial philology (as in *Works and Days*, 24-25, 40, 218, 345, 371). There is naturally less of this in the *Theogony*, yet there too not a few sentiments take the form of the saw or adage. He has undying fame as the first of didactic poets (see DIDACTIC POETRY), the accredited systematizer of Greek mythology and the rough but not unpoetical sketcher of the lines on which Virgil wrought out his exquisitely finished *Georgics*.

BIBLIOGRAPHY.—Complete works: *Editio princeps* (Milan, 1493); Götting-Flach (1878), with full bibliography up to date of publication; C. Sittl (1889), with introduction and critical and explanatory notes in Greek; F. A. Paley (1883); A. Rzsch (1902), including the fragments. Separate works: *Works and Days*: Van Lennep (1847); A. Kirchhoff (1889); A. Seitz, *Die Werke und Tage des Hesiodos* (1869), dealing chiefly with the composition and arrangement of the poem; G. Wlastoff, *Proömthee, Pandora, et la légende des sibylles* (1883). *Theogony*: Van Lennep (1843); F. G. Welcker (1865), valuable edition; G. F. Schömann (1868), with text, critical notes and exhaustive commentary; H. Flach, *Die Hesiodische Theogonie* (1873), with prolegomena dealing chiefly with the digamma in Hesiod, *System der Hesiodischen Kosmogonie* (1874), and *Glossen und Scholien zur Theogonie* (1876); Meyer, *De compositione Theogoniae* (1887). *Shield of Heracles*: Wolf-Ranke (1840); Van Lennep-Hullemaon (1854); F. Stegemann, *De scuti Herculis Hesiodici poetae Homeri carminum imitatore* (1904); the fragments were published by W. Marckscheffel in 1840; for the *Ἄγῶν Ὀυήπου* (ed. A. Rzsch, 1908) see F. Nietzsche in *Rheinisches Museum* (new series), xxv. p. 528. For papyrus fragments of the "Catalogue," some 50 lines on the wooing of Helen, and a shorter fragment in praise of Pelus, see Wilamowitz-Möllendorf in *Sitzungsber. der königl. preuss. Akad. der Wissenschaften*, for 26th of July 1900; for fragments relating to Melager and the suitors of Helen, *Berliner Klassikertexte*, v. (1907); of the *Theogony*, *Oxyrh. Pap.* vi. (1908).

On the subject generally, consult G. F. Schömann, *Opuscula*, ii. (1857); H. Flach, *Die Hesiodischen Gedichte* (1874); A. Rzsch, *Der Dialekt des Hesiodos* (1876); P. O. Gruppe, *Die griechischen Kulte und Mythen*, i. (1887); O. Friedel, *Die Sage vom Tode Hesiods* (1879), from *Jahrbücher für klassische Philologie* (10th suppl. Band, 1879); J. Adam, *Religious Teachers of Greece* (1908). There is a full bibliography of the publications relating to Hesiod (1884-1898) by A. Rzsch in Bursian's *Jahresbericht über die Fortschritte der klassischen Altertumswissenschaft*, xxvii. (1900).

¹Part of the poem was called *Eoiai*, because the description of each heroine began with ἐὼν, "or like aa." (See Bibliography.)

There are translations of the Hesiodic poems in English by Cooks (1728), C. A. Elton (1815), J. Banks (1856), and specially by A. W. Mair, with introduction and appendices (Oxford Library of Translations, 1908); in German (metrical version) with valuable introductions and notes by R. Peppmüller (1896) and in other modern languages. (J. Da.; J. H. F.)

HESPERIDES, in Greek mythology, maidens who guarded the golden apples which Earth gave Hera on her marriage to Zeus. According to Hesiod (*Theogony*, 215) they were the daughters of Erebus and Night; in later accounts, of Atlas and Hesperis, or of Phorcys and Ceto (schol. on Apoll. Rhod. iv. 1399; Diod. Sic. iv. 27) They were usually supposed to be three in number—Aegle, Erytheia, Hesperis (or Hesperethusa); according to some, four, or even seven. They lived far away in the west at the borders of Ocean, where the sun sets. Hence the sun (according to Mimmernus *op. Athenaeum* xi. p. 470) sails in the golden bowl made by Hephaestus from the abode of the Hesperides to the land where he rises again. According to other accounts their home was among the Hyperboreans. The golden apples grew on a tree guarded by Ladon, the ever-watchful dragon. The sun is often in German and Lithuanian legends described as the apple that hangs on the tree of the nightly heaven, while the dragon, the envious power, keeps the light back from men till some beneficent power takes it from him. Heracles is the hero who brings back the golden apples to mankind again. Like Perseus, he first applies to the Nymphs, who help him to learn where the garden is. Arrived there he slays the dragon and carries the apples to Argos; and finally, like Perseus, he gives them to Athena. The Hesperides are, like the Sirens, possessed of the gift of delightful song. The apples appear to have been the symbol of love and fruitfulness, and are introduced at the marriages of Cadmus and Harmonia and Peleus and Thetis. The golden apples, the gift of Aphrodite to Hippomenes before his race with Atalanta, were also plucked from the garden of the Hesperides.

HESPERUS (Gr. Ἑσπερος, Lat. Vesper), the evening star, son or brother of Atlas. According to Diodorus Siculus (iii. 60, iv. 27), he ascended Mount Atlas to observe the motions of the stars, and was suddenly swept away by a whirlwind. Ever afterwards he was honoured as a god, and the most brilliant star in the heavens was called by his name. Although as a mythological personality he is regarded as distinct from Phosphoros or Heosphoros (Lat. Lucifer), the morning star or bringer of light, the son of Astraeus (or Cephalus) and Eos, the two stars were early identified by the Greeks.

Diog. Laërt. viii. 1. 14; Cicero, *De nat. deorum*, ii. 20; Pliny, *Nat. Hist.* ii. 6 [8].

HESS, the name of a family of German artists.

HEINRICH MARIA HESS (1798-1863)—von Hess, after he received a patent of personal nobility—was born at Düsseldorf and brought up to the profession of art by his father, the engraver Karl Ernst Christoph Hess (1755-1828). Karl Hess had already acquired a name when in 1806 the elector of Bavaria, having been raised to a kingship by Napoleon, transferred the Düsseldorf academy and gallery to Munich. Karl Hess accompanied the academy to its new home, and there continued the education of his children. In time Heinrich Hess became sufficiently master of his art to attract the attention of King Maximilian. He was sent with a stipend to Rome, where a copy which he made of Raphael's Parnassus, and the study of great examples of monumental design, probably caused him to become a painter of ecclesiastical subjects on a large scale. In 1828 he was made professor of painting and director of all the art collections at Munich. He decorated the Aukirche, the Glyptothek and the Allerheiligencapelle at Munich with frescoes; and his cartoons were selected for glass windows in the cathedrals of Cologne and Regensburg. Then came the great cycle of frescoes in the basilica of St Boniface at Munich, and the monumental picture of the Virgin and Child enthroned between the four doctors, and receiving the homage of the four patrons of the Munich churches (now in the Pinakothek). His last work, the "Lord's Supper," was found unfinished in his atelier after his death in 1863. Before testing his strength as a composer Heinrich Hess

tried genre, an example of which is the Pilgrims entering Rome, now in the Munich gallery. He also executed portraits, and twice had sittings from Thorwaldsen (Pinakothek and Schack collections). But his fame rests on the frescoes representing scenes from the Old and New Testaments in the Allerheiligenkapelle, and the episodes from the life of St Boniface and other German apostles in the basilica of Munich. Here he holds rank second to none but Overbeck in monumental painting, being always true to nature though mindful of the traditions of Christian art, earnest and simple in feeling, yet lifelike and powerful in expression. Through him and his pupils the sentiment of religious art was preserved and extended in the Munich school.

PETER HESS (1792-1871)—afterwards von Hess—was born at Düsseldorf and accompanied his younger brother Heinrich Maria to Munich in 1806. Being of an age to receive vivid impressions, he felt the stirring impulses of the time and became a painter of skirmishes and battles. In 1813-1815 he was allowed to join the staff of General Wrede, who commanded the Bavarians in the military operations which led to the abdication of Napoleon; and there he gained novel experiences of war and a taste for extensive travel. In the course of years he successively visited Austria, Switzerland and Italy. On Prince Otho's election to the Greek throne King Louis sent Peter Hess to Athens to gather materials for pictures of the war of liberation. The sketches which he then made were placed, forty in number, in the Pinakothek, after being copied in wax on a large scale (and little to the edification of German feeling) by Nilsen, in the northern arcades of the Hofgarten at Munich. King Otho's entrance into Nauplia was the subject of a large and crowded canvas now in the Pinakothek, which Hess executed in person. From these, and from battlepieces on a scale of great size in the Royal Palace, as well as from military episodes executed for the czar Nicholas, and the battle of Waterloo now in the Munich Gallery, we gather that Hess was a clever painter of horses. His conception of subject was lifelike, and his drawing invariably correct, but his style is not so congenial to modern taste as that of the painters of touch. He finished almost too carefully with thin medium and pointed tools; and on that account he lacked to a certain extent the boldness of Horace Vernet, to whom he was not unaptly compared. He died suddenly, full of honours, at Munich, in April 1871. Several of his genre pictures, horse hunts, and brigand scenes may be found in the gallery of Munich.

KARL HESS (1801-1874), the third son of Karl Christoph Hess, born at Düsseldorf, was also taught by his father, who hoped that he would obtain distinction as an engraver. Karl, however, after engraving one plate after Adrian Ostade, turned to painting under the guidance of Wagenbauer of Munich, and then studied under his elder brother Peter. But historical composition proved to be as contrary to his taste as engraving, and he gave himself exclusively at last to illustrations of peasant life in the hill country of Bavaria. He became clever alike in representing the people, the animals and the landscape of the Alps, and with constant means of reference to nature in the neighbourhood of Reichenhall, where he at last resided, he never produced anything that was not impressed with the true stamp of a kindly realism. Some of his pictures in the museum of Munich will serve as examples of his manner. He died at Reichenhall on the 16th of November 1874.

HESSE, HEINRICH HERMANN JOSEF, FREIHERR VON (1788-1870), Austrian soldier, entered the army in 1805 and was soon employed as a staff officer on survey work. He distinguished himself as a subaltern at Aspern and Wagram, and in 1813, as a captain, again served on the staff. In 1815 he was with Schwarzenberg. He had in the interval between the two wars been employed as a military commissioner in Piedmont, and at the peace resumed this post, gaining knowledge which later proved invaluable to the Austrian army. In 1831, when Radetzky became commander-in-chief in Austrian Italy, he took Hess as his chief-of-staff, and thus began the connexion between two famous soldiers which, like that of Blücher and Gneisenau, is a classical example of harmonious co-operation of commander and chief-of-staff. Hess put into shape Radetzky's military ideas, in

the form of new drill for each arm, and, under their guidance, the Austrian army in North Italy, always on a war footing, became the best in Europe. From 1834 to 1848 Hess was employed in Moravia, at Vienna, &c., but, on the outbreak of revolution and war in the latter year, was at once sent out to Radetzky as chief-of-staff. In the two campaigns against King Charles Albert which followed, culminating in the victory of Novara, Hess's assistance to his chief was made still more valuable by his knowledge of the enemy, and the old field-marshal acknowledged his services in general orders. Lieut.-Fieldmarshal Hess was at once promoted *Feldzeugmeister*, made a member of the emperor's council, and *Freiherr*, assuming at the same time the duties of the quartermaster-general. Next year he became chief of the staff to the emperor. He was often employed in missions to various capitals, and he appeared in the field in 1854 at the head of the Austrian army which intervened so effectually in the Crimean war. In 1859 he was sent to Italy after the early defeats. He became field-marshal in 1860, and a year later, on resigning his position as chief-of-staff, he was made captain of the Trabant guard. He died in Vienna in 1870.

See "General Hess" in *Lebensgeschichtlichen Hilarissen* (Vienna, 1855).

HESSE (Lat. *Hessia*, Ger. *Hessen*), a grand duchy forming a state of the German empire. It was known until 1806 as Hesse-Darmstadt, the history of which is given under a separate heading below. It consists of two main parts, separated from each other by a narrow strip of Prussian territory. The northern part is the province of Oberhessen; the southern consists of the contiguous provinces of Starkenburg and Rheinhausen. There are also eleven very small exclaves, mostly grouped about Homburg to the south-west of Oberhessen; but the largest is Wimpfen on the north-west frontier of Württemberg. Oberhessen is hilly; though of no great elevation it extends over the water-parting between the basins of the Rhine and the Weser, and in the Vogelsberg it has as its culminating point the Taufstein (2533 ft.). In the north-west it includes spurs of the Taunus. Between these two systems of hills lies the fertile undulating tract known as the Wetterau, watered by the Wetter, a tributary of the Main. Starkenburg occupies the angle between the Main and the Rhine, and in its south-eastern part includes some of the ranges of the Odenwald, the highest part being the Seidenbucher Höhe (1065 ft.). Rheinhausen is separated from Starkenburg by the Rhine, and has that river as its northern as well as its eastern frontier, though it extends across it at the north-east corner, where the Rhine, on receiving the Main, changes its course abruptly from south to west. The territory consists of a fertile tract of low hills, rising towards the south-west into the northern extremity of the Hardt range, but at no point reaching a height of more than 1050 ft.

The area and population of the three provinces of Hesse are as follows:

	Area.		Population.	
	sq. m.	1895.	1905.	
Oberhessen	1267	271,524	296,755	
Starkenburg	1169	444,562	542,996	
Rheinhausen	530	322,934	369,424	
Total	2966	1,039,020	1,209,175	

The chief towns of the grand duchy are Darmstadt (the capital) and Offenbach in Starkenburg, Mainz and Worms in Rheinhausen and Giessen in Oberhessen. More than two-thirds of the inhabitants are Protestants; the majority of the remainder are Roman Catholics, and there are about 25,000 Jews. The grand duke is head of the Protestant church. Education is compulsory, the elementary schools being communal, assisted by state grants. There are a university at Giessen and a technical high school at Darmstadt. Agriculture is important, more than three-fifths of the total area being under cultivation. The largest grain crops are rye and barley, and nearly 40,000 acres are under vines. Minerals, in which Oberhessen is much richer

than the two other provinces, include iron, manganese, salt and some coal.

The constitution dates from 1820, but was modified in 1856, 1862, 1872 and 1900. There are two legislative chambers. The upper consists of princes of the grand-ducal family, heads of mediatised houses, the head of the Roman Catholic and the superintendent of the Protestant church, the chancellor of the university, two elected representatives of the land-owning nobility, and twelve members nominated by the grand duke. The lower chamber consists of ten deputies from large towns and forty from small towns and rural districts. They are indirectly elected, by deputy electors (*Wahlmänner*) nominated by the electors, who must be Hessians over twenty-five years old, paying direct taxes. The executive ministry of state is divided into the departments of the interior, justice and finance. The three provinces are divided for local administration into 18 circles and 989 communes. The ordinary revenue and expenditure amount each to about £4,000,000 annually, the chief taxes being an income-tax, succession duties and stamp tax. The public debt, practically the whole of which is on railways, amounted to £19,007,468 in 1907.

History.—The name of Hesse, now used principally for the grand duchy formerly known as Hesse-Darmstadt, refers to a country which has had different boundaries and areas at different times. The name is derived from that of a Frankish tribe, the Hessi. The earliest known inhabitants of the country were the Chatti, who lived here during the 1st century A.D. (Tacitus, *Germania*, c. 30), and whose capital, Mattium on the Eder, was burned by the Romans about A.D. 15. "Alike both in race and language," says Walther Schultze, "the Chatti and the Hessi are identical." During the period of the *Völkerverwanderung* many of these people moved westward, but some remained behind to give their name to the country, although it was not until the 8th century that the word Hesse came into use. Early Hesse was the district around the Fulda, the Werra, the Eder and the Lahn, and was part of the Frankish kingdom both during Merovingian and during Carolingian times. Soon *Hessegau* is mentioned, and this district was the headquarters of Charlemagne during his campaigns against the Saxons. By the treaty of Verdun in 843 it fell to Louis the German, and later it seems to have been partly in the duchy of Saxony and partly in that of Franconia. The Hessians were converted to Christianity mainly through the efforts of St Boniface; their land was included in the archbishopric of Mainz; and religion and culture were kept alive among them largely owing to the foundation of the Benedictine abbeys of Fulda and Hersfeld. Like other parts of Germany during the 9th century Hesse felt the absence of a strong central power, and, before the time of the emperor Otto the Great, several counts, among whom were Giso and Werner, had made themselves practically independent, but after the accession of Otto in 936 the land quietly accepted the yoke of the medieval emperors. About 1120 another Giso, count of Gudensberg, secured possession of the lands of the Werners; on his death in 1137 his daughter and heiress, Hedwig, married Louis, landgrave of Thuringia; and from this date until 1247, when the Thuringian ruling family became extinct, Hesse formed part of Thuringia. The death of Henry Raspe, the last landgrave of Thuringia, in 1247, caused a long war over the disposal of his lands, and this dispute was not settled until 1264 when Hesse, separated again from Thuringia, was secured by his niece Sophia (d. 1284), widow of Henry II., duke of Brabant. In the following year Sophia handed over Hesse to her son Henry (1244-1308), who, remembering the connexion of Hesse and Thuringia, took the title of landgrave, and is the ancestor of all the subsequent rulers of the country. In 1292 Henry was made a prince of the Empire, and with him the history of Hesse properly begins.

For nearly 300 years the history of Hesse is comparatively uneventful. The land, which fell into two main portions, upper Hesse round Marburg, and lower Hesse round Cassel, was twice divided between two members of the ruling family, but no permanent partition took place before the Reformation. A *Londtag* was first called together in 1387, and the landgraves were con-

stantly at variance with the electors of Mainz, who had large temporal possessions in the country. They found time, however, to increase the area of Hesse. Giessen, part of Schmalkalden, Ziegenhain, Nidda and, after a long struggle, Katzenelnbogen were acquired, while in 1432 the abbey of Hersfeld placed itself under the protection of Hesse. The most noteworthy of the landgraves were perhaps Louis I. (d. 1458), a candidate for the German throne in 1440, and William II. (d. 1509), a comrade of the German king, Maximilian I. In 1509 William's young son, Philip (q.v.), became landgrave, and by his vigorous personality brought his country into prominence during the religious troubles of the 16th century. Following the example of his ancestors Philip cared for education and the general welfare of his land, and the Protestant university of Marburg, founded in 1527, owes to him its origin. When he died in 1567 Hesse was divided between his four sons into Hesse-Cassel, Hesse-Darmstadt, Hesse-Marburg and Hesse-Rheinfels. The lines ruling in Hesse-Rheinfels and Hesse-Marburg, or upper Hesse, became extinct in 1583 and 1604 respectively, and these lands passed to the two remaining branches of the family. The small landgraviate of Hesse-Homburg was formed in 1622 from Hesse-Darmstadt. After the annexation of Hesse-Cassel and Hesse-Homburg by Prussia in 1866 Hesse-Darmstadt remained the only independent part of Hesse, and it generally receives the common name.

Hesse-Philippsthal is an offshoot of Hesse-Cassel, and was founded in 1685 by Philip (d. 1721), son of the Landgrave William VI. In 1909 the representative of this family was the Landgrave Ernest (b. 1846). Hesse-Barchfeld was founded in 1721 by Philip's son, William (d. 1761), and in 1909 its representative was the Landgrave Clovis (b. 1876). The lands of both these princes are now mediatised. Hesse-Nassau is a province of Prussia formed in 1866 from part of Hesse-Cassel and part of the duchy of Nassau.

See H. B. Wenck, *Hessische Landesgeschichte* (Frankfurt, 1783-1803); C. von Rommel, *Geschichte von Hesse* (Cassel, 1820-1858); F. Münscher, *Geschichte von Hesse* (Marburg, 1894); F. Gundlach, *Hesse und die Mainzer Stiftsfehde* (Marburg, 1899); Walther, *Literarisches Handbuch für Geschichte und Landeskunde von Hesse* (Darmstadt, 1841; Supplement, 1850-1869); K. Ackermann, *Bibliotheca Hessica* (Cassel, 1884-1899); Hoffmeister, *Historisch-genealogisches Handbuch über alle Linien des Regierenden Hauses Hesse* (Marburg, 1874), and the *Zeitschrift des Vereins für hessische Geschichte* (1837-1904).

HESSE-CASSEL (in German *Kurhessen*, i.e. Electoral Hesse), now the government district of Cassel in the Prussian province of Hesse-Nassau. It was till 1866 a landgraviate and electorate of Germany, consisting of several detached masses of territory, to the N.E. of Frankfurt-on-the-Main. It contained a superficial area of 3699 sq. m., and its population in 1864 was 745,063.

History.—The line of Hesse-Cassel was founded by William IV., surnamed the Wise, eldest son of Philip the Magnanimous. On his father's death in 1567 he received one half of Hesse, with Cassel as his capital, and this formed the landgraviate of Hesse-Cassel. Additions were made to it by inheritance from his brother's possessions. His son, Maurice the Learned (1592-1627), turned Protestant in 1605, became involved later in the Thirty Years' War, and, after being forced to cede some of his territories to the Darmstadt line, abdicated in favour of his son William V. (1627-1637), his younger sons receiving apanages which created several cadet lines of the house, of which that of Hesse-Rheinfels-Rotenburg survived till 1834. On the death of William V., whose territories had been conquered by the Imperialists, his widow Amalie Elizabeth, as regent for her son William VI. (1637-1663), reconquered the country and, with the aid of the French and Swedes, held it, together with part of Westphalia. At the peace of Westphalia (1648), accordingly, Hesse-Cassel was augmented by the larger part of the countship of Schaumburg and by the abbey of Hersfeld, secularized as a principality of the Empire. The Landgravine Amalie Elizabeth introduced the rule of primogeniture. William VI., who came of age in 1650, was an enlightened patron of learning and the arts. He was succeeded by his son William VII., an infant, who died in 1670, and was succeeded by his brother Charles (1670-1730). Charles's chief claim to remembrance is that he was the first ruler to adopt

the system of hiring his soldiers out to foreign powers as mercenaries, as a means of improving the national finances. Frederick I., the next landgrave (1730-1751), had become by marriage king of Sweden, and on his death was succeeded in the landgraviate by his brother William VIII. (1751-1760), who fought as an ally of England during the Seven Years' War. From his successor Frederick II (1760-1785), who had become a Roman Catholic, 22,000 Hessian troops were hired by England for about £3,191,000, to assist in the war against the North American colonies. This action, often bitterly criticized, has of late years found apologists (cf. v. Werthern, *Die hessischen Hilfstruppen im nordamerikanischen Unabhängigkeitskriege*, Cassel, 1895). It is argued that the troops were in any case mercenaries, and that the practice was quite common. Whatever opinion may be held as to this, it is certain that Frederick spent the money well: he did much for the development of the economic and intellectual improvement of the country. The reign of the next landgrave, William IX. (1785-1821), was an important epoch in the history of Hesse-Cassel. Ascending the throne in 1785, he took part in the war against France a few years later, but in 1795 peace was arranged by the treaty of Basel. For the loss in 1801 of his possessions on the left bank of the Rhine he was in 1803 compensated by some of the former French territory round Mainz, and at the same time was raised to the dignity of Elector (*Kurfürst*) as William I. In 1806 he made a treaty of neutrality with Napoleon, but after the battle of Jena the latter, suspecting William's designs, occupied his country, and expelled him. Hesse-Cassel was then added to Jerome Bonaparte's new kingdom of Westphalia, but after the battle of Leipzig in 1813 the French were driven out and on the 21st of November the elector returned in triumph to his capital. A treaty concluded by him with the Allies (Dec. 2) stipulated that he was to receive back all his former territories, or their equivalent, and at the same time to restore the ancient constitution of his country. This treaty, so far as the territories were concerned, was carried out by the powers at the congress of Vienna. They refused, however, the elector's request to be recognized as "King of the Chatti" (*König der Chatten*), a request which was again rejected at the conference of Aix-la-Chapelle (1818). He therefore retained the now meaningless title of elector, with the predicate of "royal highness."

The elector had signalized his restoration by abolishing with a stroke of the pen all the reforms introduced under the French régime, repudiating the Westphalian debt and declaring null and void the sale of the crown domains. Everything was set back to its condition on the 1st of November 1806; even the officials had to descend to their former rank, and the army to revert to the old uniforms and powdered pigtails. The estates, indeed, were summoned in March 1815, but the attempt to devise a constitution broke down; their appeal to the federal diet at Frankfort to call the elector to order in the matter of the debt and the domains came to nothing owing to the intervention of Metternich; and in May 1816 they were dissolved, never to meet again. William I. died on the 27th of February 1821, and was succeeded by his son, William II. Under him the constitutional crisis in Hesse-Cassel came to a head. He was arbitrary and avaricious like his father, and moreover shocked public sentiment by his treatment of his wife, a popular Prussian princess, and his relations with his mistress, one Emilie Ortlöpp, created countess of Reichenbach, whom he loaded with wealth. The July revolution in Paris gave the signal for disturbances; the elector was forced to summon the estates; and on the 5th of January 1831 a constitution on the ordinary Liberal basis was signed. The elector now retired to Hanau, appointed his son Frederick William regent, and took no further part in public affairs.

The regent, without his father's coarseness, had a full share of his arbitrary and avaricious temper. Constitutional restrictions were intolerable to him; and the consequent friction with the diet was aggravated when, in 1832, Hassenpflug (*q.v.*) was placed at the head of the administration. The whole efforts of the elector and his minister were directed to nullifying the

constitutional control vested in the diet; and the Opposition was fought by manipulating the elections, packing the judicial bench, and a vexatious and petty persecution of political "suspects," and this policy continued after the retirement of Hassenpflug in 1837. The situation that resulted issued in the revolutionary year 1848 in a general manifestation of public discontent; and Frederick William, who had become elector on his father's death (November 20, 1847), was forced to dismiss his reactionary ministry and to agree to a comprehensive programme of democratic reform. This, however, was but short-lived. After the breakdown of the Frankfort National Parliament, Frederick William joined the Prussian Northern Union, and deputies from Hesse-Cassel were sent to the Erfurt parliament. But as Austria recovered strength, the elector's policy changed. On the 23rd of February 1850 Hassenpflug was again placed at the head of the administration and threw himself with renewed zeal into the struggle against the constitution and into opposition to Prussia. On the 2nd of September the diet was dissolved, the taxes were continued by electoral ordinance; and the country was placed under martial law. It was at once clear, however, that the elector could not depend on his officers or troops, who remained faithful to their oath to the constitution. Hassenpflug persuaded the elector to leave Cassel secretly with him, and on the 15th of October appealed for aid to the reconstituted federal diet, which willingly passed a decree of "intervention." On the 1st of November an Austrian and Bavarian force marched into the electorate.

This was a direct challenge to Prussia, which under conventions with the elector had the right to the use of the military roads through Hesse that were her sole means of communication with her Rhine provinces. War seemed imminent, Prussian troops also entered the country, and shots were actually exchanged between the outposts. But Prussia was in no condition to take up the challenge; and the diplomatic contest that followed issued in the Austrian triumph at Olmütz (1851). Hesse was surrendered to the federal diet; the taxes were collected by the federal forces, and all officials who refused to recognize the new order were dismissed. In March 1852 the federal diet abolished the constitution of 1831, together with the reforms of 1848, and in April issued a new provisional constitution. The new diet had, under this, very narrow powers; and the elector was free to carry out his policy of amassing money, forbidding the construction of railways and manufactories, and imposing strict orthodoxy on churches and schools. In 1855, however, Hassenpflug—who had returned with the elector—was dismissed; and five years later, after a period of growing agitation, a new constitution was granted with the consent of the federal diet (May 30, 1860). The new chambers, however, demanded the constitution of 1831; and, after several dissolutions which always resulted in the return of the same members, the federal diet decided to restore the constitution of 1831 (May 24, 1862). This had been due to a threat of Prussian occupation; and it needed another such threat to persuade the elector to reassemble the chambers, which he had dismissed at the first sign of opposition; and he revenged himself by refusing to transact any public business. In 1866 the end came. The elector, full of grievances against Prussia, threw in his lot with Austria; the electorate was at once overrun with Prussian troops, Cassel was occupied (June 20); and the elector was carried a prisoner to Stettin. By the treaty of Prague Hesse-Cassel was annexed to Prussia. The elector Frederick William (d. 1875) had been, by the terms of the treaty of cession, guaranteed the entailed property of his house. This was, however, sequestered in 1868 owing to his intrigues against Prussia; part of the income was paid, however, to the eldest agnate, the landgrave Frederick (d. 1884), and part, together with certain castles and palaces, was assigned to the cadet lines of Philippsthal and Philippsthal-Barchfeld.

See K. W. Wippermann, *Kurhessen seit den Freiheitskriegen* (Cassel, 1890); Röth, *Geschichte von Hessen-Kassel* (Cassel, 1856; 2nd ed. continued by Stamford, 1883-1885); H. Gräfe, *Der Verfassungskampf in Kurhessen* (Leipzig, 1851) and works under Hesse.

HESSE-DARMSTADT, a grand-duchy in Germany, the history of which begins with the partition of Hesse in 1567. George I. (1547-1597), the youngest son of the landgrave Phillip, received the upper county of Katzenelnbogen, and, selecting Darmstadt as his residence, became the founder of the Hesse-Darmstadt line. Additions to the landgraviate were made both in the reigns of George and of his son and successor, Louis V. (1577-1626), but in 1622 Hesse-Homburg was cut off to form an apanage for George's youngest son, Frederick (d. 1638). Although Louis V., who founded the university of Giessen in 1607, was a Lutheran, he and his son, George II. (1605-1661), sided with the imperialists in the Thirty Years' War, during which Hesse-Darmstadt suffered very severely from the ravages of the Swedes. In this struggle Hesse-Cassel took the other side, and the rivalry between the two landgraviates was increased by a dispute over Hesse-Marburg, the ruling family of which had become extinct in 1604. This quarrel was interwoven with the general thread of the Thirty Years' War, and was not finally settled until 1648, when the disputed territory was divided between the two claimants. Louis VI. (d. 1678), a careful and patriotic prince, followed the policy of the three previous landgraves, but the anxiety of his son, Ernest Louis (d. 1730), to emulate the French court under Louis XIV. led his country into debt. Under Ernest Louis and his son and successor, Louis VIII. (d. 1768), another dispute occurred between Darmstadt and Cassel; this time it was over the succession to the county of Hanau, which was eventually divided, Hesse-Darmstadt receiving Lichtenberg. During the 18th century the War of the Austrian Succession and the Seven Years' War dealt heavy blows at the prosperity of the landgraviate, which was always loyal to the house of Austria. Louis IX. (1719-1790), who served in the Prussian army under Frederick the Great, is chiefly famous as the husband of Caroline (1721-1774), "the great landgravine," who counted Goethe, Herder and Grimm among her friends and was described by Frederick the Great as *femina sexu, ingenio vir*. In April 1790, just after the outbreak of the French Revolution, Louis X. (1753-1830), an educated prince who shared the tastes and friendships of his mother, Caroline, became landgrave. In 1792 he joined the allies against France, but in 1799 he was compelled to sign a treaty of neutrality. In 1803, having formally surrendered the part of Hesse on the left bank of the Rhine which had been taken from him in the early days of the Revolution, Louis received in return a much larger district which had formerly belonged to the duchy of Westphalia, the electorate of Mainz and the bishopric of Worms. In 1806, being a member of the confederation of the Rhine, he took the title of Louis I., grand-duke of Hesse; he supported Napoleon with troops from 1805 to 1813, but after the battle of Leipzig he joined the allies. In 1815 the congress of Vienna made another change in the area and boundaries of Hesse-Darmstadt. Louis secured again a district on the left bank of the Rhine, including the cities of Mainz and Worms, but he made cessions of territory to Prussia and to Bavaria and he recognized the independence of Hesse-Homburg, which had recently been incorporated with his lands. However, his title of grand-duke was confirmed, and as grand-duke of Hesse and of the Rhine he entered the Germanic confederation. Soon the growing desire for liberty made itself felt in Hesse, and in 1820 Louis gave a constitution to the land, various forms were carried through, the system of government was reorganized, and in 1828 Hesse-Darmstadt joined the Prussian *Zollverein*. Louis I., who did a great deal for the welfare of his country, died on the 6th of April 1830, and was followed on the throne by his son, Louis II. (1777-1848). This grand-duke had some trouble with his *Landtag*, but, dying on the 16th of June 1848, he left his son, Louis III. (1806-1877), to meet the fury of the revolutionary year 1848. Many concessions were made to the popular will, but during the subsequent reaction these were withdrawn, and the period between 1850 and 1871, when Karl Friedrich Reinhard, Freiherr von Dalwigk (1802-1880), was chiefly responsible for the government of Hesse-Darmstadt, was one of repression, although some benefits were conferred upon the people. Dalwigk was one of Prussia's

enemies, and during the war of 1866 the grand-duke fought on the Austrian side, the result being that he was compelled to pay a heavy indemnity and to cede certain districts, including Hesse-Homburg, which he had only just acquired, to Prussia. In 1867 Louis entered the North German Confederation, but only for his lands north of the Main, and in 1871 Hesse-Darmstadt became one of the states of the new German empire. After the withdrawal of Dalwigk from public life at this time a more liberal policy was adopted in Hesse. Many reforms in ecclesiastical, educational, financial and administrative matters were introduced, and in general the grand-duchy may be said to have passed largely under the influence of Prussia, which, by an arrangement made in 1866, controls the Hessian railway system. The constitution of 1820, subject to four subsequent modifications, is still the law of the land, the legislative power being vested in two chambers and the executive power being exercised by the three departments of the ministry of state. Since the annexation of Hesse-Cassel by Prussia in 1866 the grand-duchy has been known simply as Hesse. Louis III. died on the 13th of June 1877, and was succeeded by his nephew, Louis IV. (1837-1892), a son-in-law of Queen Victoria; he died on the 13th of March 1892, and was succeeded by his son, Ernest Louis (b. 1868). This grand-duke's marriage with Victoria (b. 1876), daughter of Alfred, duke of Saxe-Coburg and Gotha, was dissolved in 1901. The union was childless, and consequently in 1902 a law regulating the succession was passed. By this the landgrave Alexander Frederick (b. 1863), the representative of the family which ruled Hesse-Cassel until 1866, was declared the heir to Hesse in case the grand-duke died without sons. However, in 1905 Ernest Louis married Elenore, princess of Solms-Hohensolms-Lich (b. 1871), by whom he had a son George (b. 1906).

See L. Baur, *Urkunden zur hessischen Landes-, Orts- und Familien-geschichte* (Darmstadt, 1846-1873); Steiner, *Geschichte des Grossherzogtums Hessen* (Darmstadt, 1833-1854); Klein, *Das Grossherzogtum Hessen* (Mainz, 1861); Ewald, *Historische Übersicht der Territorialveränderungen der Landgrafschaft Hessen und des Grossherzogtums Hessen* (Darmstadt, 1872); F. Soldan, *Geschichte des Grossherzogtums Hessen* (Giessen, 1896); H. Heppel, *Kirchengeschichte beider Hessen* (Marburg, 1876-1878); C. Hessler, *Geschichte vom Hessen* (Cassel, 1891), and *Hessische Landes- und Volkskunde* (Marburg, 1904-1906); F. Kähler, A. E. Braun and A. K. Weber, *Verfassungs- und Verwaltungsrecht des Grossherzogtums Hessen* (Darmstadt, 1894-1897); H. Künzel, *Grossherzogtum Hessen* (Giessen, 1893); and W. Zeller, *Handbuch der Verfassung und Verwaltung im Grossherzogtum Hessen* (Darmstadt, 1885-1893). See also *Archiv für hessische Geschichte und Altertumskunde* (Darmstadt, 1894 fol.) and *Hessisches Urkundenbuch* (Leipzig, 1879 fol.).

HESSE-HOMBURG, formerly a small landgraviate in Germany. It consisted of two parts, the district of Homburg on the right side of the Rhine, and the district of Meisenheim, which was added in 1815, on the left side of the same river. Its area was about 100 sq. m., and its population in 1864 was 27,374. Homburg now forms part of the Prussian province of Hesse-Nassau, and Meisenheim of the province of the Rhine. Hesse-Homburg was formed into a separate landgraviate in 1622 by Frederick I. (d. 1638), son of George I., landgrave of Hesse-Darmstadt, although it did not become independent of Hesse-Darmstadt until 1768. By two of Frederick's sons it was divided into Hesse-Homburg and Hesse-Homburg-Bingenheim; but these parts were again united in 1681 under the rule of Frederick's third son, Frederick II. (d. 1708). In 1806, during the long reign of the landgrave Frederick V., which extended from 1751 to 1820, Hesse-Homburg was mediatised, and incorporated with Hesse-Darmstadt; but in 1815 by the congress of Vienna the latter state was compelled to recognize the independence of Hesse-Homburg, which was increased by the addition of Meisenheim. Frederick V. joined the German confederation as a sovereign prince in 1817, and after his death his five sons in succession filled the throne. The last of these, Ferdinand, who succeeded in 1848, granted a liberal constitution to his people, but cancelled it during the reaction of 1852. When he died on the 24th of March 1866, Hesse-Homburg was inherited by Louis III., grand-duke of Hesse-Darmstadt, while Meisenheim fell to Prussia. In the following September, however, Louis

was forced to cede his new possession to Prussia, as he had supported Austria during the war between these two powers.

See R. Schwartz, *Landgraf Friedrich V. von Hessen-Homburg und seine Familie* (1878); and von Herget, *Das landgräfliche Haus Homburg* (Homburg, 1903).

HESSE-NASSAU (Ger. *Hessen-Nassau*), a province of Prussia, bounded, from N. to E., S. and W., successively by Westphalia, Waldeck, Hanover, the province of Saxony, the Thuringian States, Bavaria, Hesse and the Rhine Province. There are small detached portions in Waldeck, Thuringia, &c.; on the other hand the province enclaves the province of Oberhessen belonging to the grand-duchy of Hesse, and the circle of Wetzlar belonging to the Rhine Province. Hesse-Nassau was formed in 1867-1868 out of the territories which accrued to Prussia after the war of 1866, namely, the landgraviate of Hesse-Cassel and the duchy of Nassau, in addition to the greater part of the territory of Frankfort-on-Main, parts of the grand-duchy of Hesse, the territory of Homburg and the countship of Hesse-Homburg, together with certain small districts which belonged to Bavaria. It is now divided into the governments of Cassel and Wiesbaden, the second of which consists mainly of the former territory of Nassau (*q.v.*).

The province has an area of 6062 sq. m., and had a population in 1905 of 2,070,052, being the fourth most densely populated province in Prussia, after Berlin, the Rhine Province and Westphalia. The east and north parts lie in the basin of the river Fulda, which near the north-eastern boundary joins with the Werra to form the Weser. The Main forms part of the southern boundary, and the Rhine the south-western; the western part of the province lies mostly in the basin of the Lahn, a tributary of the Rhine. The province is generally hilly, the highest hills occurring in the east and west. The Fulda rises in the Wasserkupe (3117 ft.), an eminence of the Rhöngebirge, the highest in the province. In the south-west are the Taunus, bordering the Main, and the Westerwald, west of the Lahn, in which the highest points respectively are the Grosser Feldberg (2887 ft.) and the Fuchskauten (2155 ft.). The congeries of small groups of lower hills in the north are known as the Hessische Bergland.

The province is not notably well suited to agriculture, but in forests it is the richest in Prussia, and the timber trade is large. The chief trees are beech, oak and conifers. Cattle-breeding is extensively practised. The vine is cultivated chiefly on the slopes of the Taunus, in the south-west, where the names of several towns are well known for their wines—Schierstein, Erbach (Marcobrunner), Johannisberg, Geisenheim, Rüdesheim, Assmannshausen. Iron, coal, copper and manganese are mined. The mineral springs are important, including those at Wiesbaden, Homburg, Langenschwalbach, Nenndorf, Schlangenbad and Soden. The chief manufacturing centres are Cassel, Diez, Eschwege, Frankfort, Fulda, Gross Almerode, Hanau and Hersfeld. The province is divided for administration into 42 circles (*Kreise*), 24 in the government of Cassel and 18 in that of Wiesbaden. It returns 14 representatives to the Reichstag. Marburg is the seat of a university.

HESSE-ROTEBURG, a German landgraviate which was broken up in 1834. In 1627 Ernest (1623-1693), a younger son of Maurice, landgrave of Hesse-Cassel (d. 1632), received Rheinfels and lower Katzenelnbogen as his inheritance, and some years later, on the deaths of two of his brothers, he added Eschwege, Rotenburg, Wanfried and other districts to his possessions. Ernest, who was a convert to the Roman Catholic Church, was a great traveller and a voluminous writer. About 1700 his two sons, William (d. 1725) and Charles (d. 1711), divided their territories, and founded the families of Hesse-Rotenburg and Hesse-Wanfried. The latter family died out in 1755, when William's grandson, Constantine (d. 1778), reunited the lands except Rheinfels, which had been acquired by Hesse-Cassel in 1735, and ruled them as landgrave of Hesse-Rotenburg. At the peace of Lunéville in 1801 the part of the landgraviate on the left bank of the Rhine was surrendered to France, and in 1815 other parts were ceded to Prussia, the landgrave Victor

Amadeus being compensated by the abbey of Corvey and the Silesian duchy of Ratibor. Victor was the last male member of his family, so, with the consent of Prussia, he bequeathed his allodial estates to his nephews the princes Victor and Chlodwig of Hohenlohe-Waldenburg-Schillingsfürst (see HOHENLOHE). When the landgrave died on the 12th of November 1834 the remaining parts of Hesse-Rotenburg were united with Hesse-Cassel according to the arrangement of 1627. It may be noted that Hesse-Rotenburg was never completely independent of Hesse-Cassel. Perhaps the most celebrated member of this family was Charles Constantine (1752-1821), a younger son of the landgrave Constantine, who was called "citoyen Hesse," and who took part in the French Revolution.

HESSIAN, the name of a jute fabric made as a plain cloth, in various degrees of fineness, width and quality. The common, or standard, hessian is 40 in. wide, weighs 10½ oz. per yd., and in the finished state contains about 12 threads and 12½ picks per in. The name is probably of German origin, and the fabric was originally made from flax and tow. Small quantities of cloth are still made from yarns of these fibres, but the jute fibre, owing to its comparative cheapness, has now almost supplanted all others.

This useful cloth is employed in countless ways, especially for packing all kinds of dry goods, while large quantities, of different qualities, are made up into bags for sugar, flour, coffee, grain, ore, manure, sand, potatoes, onions, &c. Indeed, bags made from one or other quality of this cloth, or from sacking, bagging or tarpaulin, form the most convenient, and at the same time the cheapest covering for any kind of goods which are not damaged by being crushed.

Certain types are specially treated, dyed black, tan or other colour, or left in their natural colour, stiffened and used for paddings and linings for cheap clothing, boots, shoes, bags and other articles. When dyed in art shades the cloth forms an attractive decoration for stages and platforms, and generally for any temporary erection, and in many cases it is stencilled and then used for wall decoration.

The great linoleum industry depends upon certain types of this fabric for the foundation of its products, while large quantities are used for the backs of fringe rugs, spring mattresses and the upholstery of furniture.

The great centres for the manufacture of this fabric are Dundee and Calcutta, and every variety of the cloth, and all kinds of hand- and machine-sewn, as well as seamless bags, are made in the former city. The American name for hessian is burlap; this particular kind is 40 in. wide, and is now largely made in Calcutta as well as in Dundee and other places.

HESSUS, HELIUS BOBANUS (1488-1540), German Latin poet, was born at Halghehausen in Hesse-Cassel, on the 6th of January 1488. His family name is said to have been Koch; Eoban was the name of a local saint; Hesus indicates the land of his birth, Helius the fact that he was born on Sunday. In 1504 he entered the university of Erfurt, and soon after his graduation was appointed rector of the school of St Severus. This post he soon lost, and spent the years 1509-1513 at the court of the bishop of Riesenburg. Returning to Erfurt, he was reduced to great straits owing to his drunken and irregular habits. At length (in 1517) he was appointed professor of Latin in the university. He was prominently associated with the distinguished men of the time (Johann Reuchlin, Conrad Peutinger, Ulrich von Hutten, Conrad Mutianus), and took part in the political, religious and literary quarrels of the period, finally declaring in favour of Luther and the Reformation, although his subsequent conduct showed that he was actuated by selfish motives. The university was seriously weakened by the growing popularity of the new university of Wittenberg, and Hesus endeavoured (but without success) to gain a living by the practice of medicine. Through the influence of Camerarius and Melanchthon, he obtained a post at Nuremberg (1526), but, finding a regular life distasteful, he again went back to Erfurt (1533). But it was not the Erfurt he had known; his old friends were dead or had left the place; the university was deserted. A lengthy poem gained him the favour

of the landgrave of Hesse, by whom he was summoned in 1536 as professor of poetry and history to Marburg, where he died on the 5th of October 1540. Hesusus, who was considered the foremost Latin poet of his age, was a facile verse-maker, but not a true poet. He wrote what he thought was likely to pay or secure him the favour of some important person. He wrote local, historical and military poems, idylls, epigrams and occasional pieces, collected under the title of *Sylvae*. His most popular works were translations of the Psalms into Latin distichs (which reached forty editions) and of the *Iliad* into hexameters. His most original poem was the *Heroides* in imitation of Ovid, consisting of letters from holy women, from the Virgin Mary down to Kunigunde, wife of the emperor Henry II.

His *Epistolae* were edited by his friend Camerarius, who also wrote his life (1553). There are later accounts of him by M. Hertz (1860), G. Schwertzel (1874) and C. Krause (1879); see also D. F. Strauss, *Ulrich von Hutten* (Eng. trans., 1874). His poems on Nuremberg and other towns have been edited with commentaries and 16th-century illustrations by J. Neff and V. von Loga in M. Herrmann and S. Szamatolski's *Lateinische Litteraturdenkmäler des XV. u. XVI. Jahrhunderts* (Berlin, 1896).

HESTIA, in Greek mythology, the "fire-goddess," daughter of Cronus and Rhea, the goddess of hearth and home. She is not mentioned in Homer, although the hearth is recognized as a place of refuge for suppliants; this seems to show that her worship was not universally acknowledged at the time of the Homeric poems. In post-Homeric religion she is one of the twelve Olympian deities, but, as the abiding goddess of the household, she never leaves Olympus. When Apollo and Poseidon became suitors for her hand, she swore to remain a maiden for ever; whereupon Zeus bestowed upon her the honour of presiding over all sacrifices. To her the opening sacrifice was offered; to her at the sacrificial meal the first and last libations were poured. The fire of Hestia was always kept burning, and, if by any accident it became extinct, only sacred fire produced by friction, or by burning glasses drawing fire from the sun, might be used to rekindle it. Hestia is the goddess of the family union, the personification of the idea of home; and as the city union is only the family union on a large scale, she was regarded as the goddess of the state. In this character her special sanctuary was in the prytaneum, where the common hearth-fire round which the magistrates meet is ever burning, and where the sacred rites that sanctify the concord of city life are performed. From this fire, as the representative of the life of the city, intending colonists took the fire which was to be kindled on the hearth of the new colony. Hestia was closely connected with Zeus, the god of the family both in its external relation of hospitality and its internal unity round its own hearth; in the *Odyssey* a form of oath is by Zeus, the table and the hearth. Again, Hestia is often associated with Hermes, the two representing home and domestic life on the one hand, and business and outdoor life on the other; or, according to others, the association is local—that of the god of boundaries with the goddess of the house. In later philosophy Hestia became the hearth of the universe—the personification of the earth as the centre of the universe, identified with Cybele and Demeter. As Hestia had her home in the prytaneum, special temples dedicated to her are of rare occurrence. She is seldom represented in works of art, and plays no important part in legend. It is not certain that any really Greek statues of Hestia are in existence, although the Giustiniani Vesta in the Torlonia Museum is usually accepted as such. In this she is represented standing upright, simply robed, a hood over her head, the left hand raised and pointing upwards. The Roman deity corresponding to the Greek Hestia is VESTA (q.v.).

See A. Preuner, *Hestia-Vesta* (1864), the standard treatise on the subject, and his article in Roscher's *Lexikon der Mythologie*; J. C. Frazier, "The Prytaneum," &c., in *Journal of Philology*, xiv. (1885); G. Hagemann, *De Graecorum prytaneis* (1881), with bibliography and notes; *Homeric Hymns*, xxix., ed. T. W. Allen and E. E. Sikes (1904); Farnell, *Cults, the Greek States*, v. (1909).

HESYCHASTS (*ἡσυχασταί* or *ἡσυχάζοντες*, from *ἡσυχος*, quiet, also called *ὀμφολόβηχοι*, Umbilicani, and sometimes referred to as Euchites, Massalians or Palamites), a quietistic sect which arose, during the later period of the Byzantine

empire, among the monks of the Greek church, especially at Mount Athos, then at the height of its fame and influence under the reign of Andronicus the younger and the abbacy of Symeon. Owing to various adventitious circumstances the sect came into great prominence politically and ecclesiastically for a few years about the middle of the 14th century. Their opinion and practice will be best represented in the words of one of their early teachers (quoted by Gibbon, *Decline and Fall*, c. 63): "When thou art alone in thy cell shut thy door, and seat thyself in a corner; raise thy mind above all things vain and transitory; recline thy beard and chin on thy breast; turn thine eyes and thy thought towards the middle of thy belly, the region of the navel (*ὀμφαλός*); and search the place of the heart, the seat of the soul. At first all will be dark and comfortless; but if thou persevere day and night, thou wilt feel an ineffable joy; and no sooner has the soul discovered the place of the heart than it is involved in a mystic and ethereal light." About the year 1337 this hesychasm, which is obviously related to certain well-known forms of Oriental mysticism, attracted the attention of the learned and versatile Barlaam, a Calabrian monk, who at that time held the office of abbot in the Basilian monastery of St Saviour's in Constantinople, and who had visited the fraternities of Mount Athos on a tour of inspection. Amid much that he disapproved, what he specially took exception to as heretical and blasphemous was the doctrine entertained as to the nature of this divine light, the fruition of which was the supposed reward of hesychastic contemplation. It was maintained to be the pure and perfect essence of God Himself, that eternal light which had been manifested to the disciples on Mount Tabor at the transfiguration. This Barlaam held to be polytheistic, inasmuch as it postulated two eternal substances, a visible and an invisible God. On the hesychastic side the controversy was taken up by Gregory Palamas, afterwards archbishop of Thessalonica, who laboured to establish a distinction between eternal *ὁσία* and eternal *ἐπίγεια*. In 1341 the dispute came before a synod held at Constantinople and presided over by the emperor Andronicus; the assembly, influenced by the veneration in which the writings of the pseudo-Dionysius were held in the Eastern Church, overruled Barlaam, who recanted and returned to Calabria, afterwards becoming bishop of Hierace in the Latin communion. One of his friends, Gregory Acindynus, continued the controversy, and three other synods on the subject were held, at the second of which the Barlaamites gained a brief victory. But in 1351 under the presidency of the emperor John Cantacuzenus, the uncreated light of Mount Tabor was established as an article of faith for the Greeks, who ever since have been ready to recognize it as an additional ground of separation from the Roman Church. The contemporary historians Cantacuzenus and Nicephorus Gregoras deal very copiously with this subject, taking the Hesychast and Barlaamite sides respectively. It may be mentioned that in the time of Justinian the word hesychast was applied to monks in general simply as descriptive of the quiet and contemplative character of their pursuits.

See article "Hesychasten" in Herzog-Hauck, *Realencyklopädie* (3rd ed., 1900), where further references are given.

HESYCHIUS, grammarian of Alexandria, probably flourished in the 5th century A.D. He was probably a pagan; and the explanations of words from Gregory of Nazianzus and other Christian writers (*glossae sacrae*) are interpolations of a later time. He has left a Greek dictionary, containing a copious list of peculiar words, forms and phrases, with an explanation of their meaning, and often with a reference to the author who used them or to the district of Greece where they were current. Hence the book is of great value to the student of the Greek dialects; while in the restoration of the text of the classical authors generally, and particularly of such writers as Aeschylus and Theocritus, who used many unusual words, its value can hardly be exaggerated. The explanations of many epithets and phrases reveal many important facts about the religion and social life of the ancients. In a preface to Diogenianus (itself extracted from an earlier work by Pamphilus),

but that he has also used similar works by Aristarchus, Apion, Heliodorus and others.

The text is very corrupt, and the order of the words has often been disturbed. There is no doubt that many interpolations, besides the Christian glosses, have been made. The work has come down to us from a single MS., now in the library at Venice, from which the editio princeps was published. The best edition is by M. Schmidt (1858-1868); in a smaller edition (1867) he attempts to distinguish the additions made by Hesychius to the work of Diogenianus.

HESYCHIUS OF MILETUS, Greek chronicler and biographer, surnamed *Illustrius*, son of an advocate, flourished at Constantinople in the 5th century A.D. during the reign of Justinian. According to Photius (cod. 69) he was the author of three important works. (1) *A Compendium of Universal History* in six books, from Belus, the reputed founder of the Assyrian empire, to Anastasius I. (d. 518). A considerable fragment has been preserved from the sixth book, entitled *Ἰστορία Κωνσταντινουπόλεως*, a history of Byzantium from its earliest beginnings till the time of Constantine the Great. (2) *A Biographical Dictionary* (*Ὀνομασολόγιον* or *Ἰστορίαι*) of *Learned Men*, arranged according to classes (poets, philosophers), the chief sources of which were the *Μουσική Ἱστορία* of Aelius Dionysius and the works of Herennius Philo. Much of it has been incorporated in the lexicon of Suidas, as we learn from that author. It is disputed, however, whether the words in Suidas ("of which this book is an epitome") mean that Suidas himself epitomized the work of Hesychius, or whether they are part of the title of an already epitomized Hesychius used by Suidas. The second view is more generally held. The epitome referred to, in which alphabetical order was substituted for arrangement in classes and some articles on Christian writers added as a concession to the times, is assigned from internal indications to the years 829-837. Both it and the original work are lost, with the exception of the excerpts in Photius and Suidas. A smaller compilation, chiefly from Diogenes Laërtius and Suidas, with a similar title, is the work of an unknown author of the 11th or 12th century. (3) *A History of the Reign of Justin I.* (518-527) and the early years of Justinian, completely lost. Photius praises the style of Hesychius, and credits him with being a veracious historian.

Editions: J. C. Orelli (1820) and J. Flach (1882); fragments in C. W. Müller, *Frag. hist. Graec.* iv. 143 and in T. Preger's *Scriptores originis Constantinopolitanae*, i. (1901); *Pseudo-Hesychius* by J. Flach (1880); see generally C. Krumbacher, *Geschichte der byzantinischen Literatur* (1897).

HETAERISM (Gr. *ἑταίρα* a mistress), the term employed by anthropologists to express the primitive condition of man in his sexual relations. The earliest social organization of the human race was characterized by the absence of the institution of marriage in any form. Women were the common property of their tribe, and the children never knew their fathers.

HETEROKARYOTA, a zoological name proposed by S. J. Hickson for the Infusoria (*q.v.*) on the ground of the differentiation of their nuclear apparatus into meganucleus and micronucleus (or nuclei).

See Lankester's *Treatise of Zoology*, vol. i. fasc. 1 (1903).

HETERONOMY (from Gr. *ἕτερος* and *νόμος*, the rule of another), the state of being under the rule of another person. In ethics the term is specially used as the antithesis of "autonomy," which, especially in Kantian terminology, treats of the true self as will, determining itself by its own law, the moral law. "Heteronomy" is therefore applied by Kant to all other ethical systems, inasmuch as they place the individual in subjection to external laws of conduct.

HETMAN (a Polish word, probably derived from the Ger. *Hauptmann*, head-man or captain; the Russian form is *ataman*), a military title formerly in use in Poland; the *Hetman Wielki*, or Great Hetman, was the chief of the armed forces of the nation, and commanded in the field, except when the king was present in person. The office was abolished in 1792. From Poland the word was introduced into Russia, in the form *ataman*, and was adopted by the Cossacks, as a title for their head, who was practically an independent prince, when under the suzerainty of Poland. After the acceptance of Russian rule

by the Cossacks in 1654, the post was shorn of its power. The title of "ataman" or "hetman of all the Cossacks" is held by the Cesarevitch. "Ataman" or "hetman" is also the name of the elected elder of the *stanitsa*, the unit of Cossack administration. (See **COSSACKS**.)

HETTNER, HERMANN THEODOR (1821-1882), German literary historian and writer on the history of art, was born at Leisersdorf, near Goldberg, in Silesia, on the 12th of March 1821. At the universities of Berlin, Halle and Heidelberg he devoted himself chiefly to the study of philosophy, but in 1843 turned his attention to aesthetics, art and literature. With a view to furthering these studies, he spent three years in Italy, and, on his return, published a *Vorschule zur bildenden Kunst der Alten* (1848) and an essay on *Die neapolitanischen Malerschulen*. He became *Privatdozent* for aesthetics and the history of art at Heidelberg and, after the publication of his suggestive volume on *Die romantische Schule in ihrem Zusammenhang mit Goethe und Schiller* (1850), accepted a call as professor to Jena where he lectured on the history of both art and literature. In 1855 he was appointed director of the royal collections of antiquities and the museum of plaster casts at Dresden, to which posts were subsequently added that of director of the historical museum and a professorship at the royal *Polytechnikum*. He died in Dresden on the 20th of May 1882. Hettner's chief work is his *Literaturgeschichte des 18ten Jahrhunderts*, which appeared in three parts, devoted respectively to English, French and German literature, between 1856 and 1870 (5th ed. of I. and II., revised by A. Brandl and H. Morf, 1894; 4th of III., revised by O. Harnack, 1894). Although to some extent influenced by the political and literary theories of the Hegelian school, which, since Hettner's day have fallen into discredit, and at times losing sight of the main issues of literary development over questions of social evolution, this work belongs to the best histories that the 19th century produced. Hettner's judgment is sound and his point of view always original and stimulating. His other works include *Griechische Reiseskizzen* (1853), *Das moderne Drama* (1852)—a book that arose from a correspondence with Gottfried Keller—*Italienische Studien* (1879), and several works descriptive of the Dresden art collections. His *Kleine Schriften* were collected and published in 1884.

See A. Stern, *Hermann Hettner, ein Lebensbild* (1883); H. Spitzer, *H. Hettners kunstphilosophische Anfänge und Literaturästhetik* (1903).

HETTSTEDT, a town of Germany, in Prussian Saxony, on the Wipper, and at the junction of the railways Berlin-Blankenheim and Hettstedt-Halle, 23 m. N.W. of the last town. Pop. (1905), 9230. It has a Roman Catholic and four Evangelical churches, and has manufactures of machinery, pianofortes and artificial manure. In the neighbourhood are mines of argentiferous copper, and the surrounding district and villages are occupied with smelting and similar works. Silver and sulphuric acid are the other chief products; nickel and gold are also found in small quantities. In the Kaiser Friedrich mine close by, the first steam-engine in Germany was erected on the 23rd of August 1785. Hettstedt is mentioned as early as 1046; in 1220 it possessed a castle; and in 1380 it received civic privileges. When the countyship of Mansfeld was sequestrated, Hettstedt came into the possession of Saxony, passing to Prussia in 1815.

HEUGLIN, THEODOR VON (1824-1876), German traveller in north-east Africa, was born on the 20th of March 1824 at Hirschlanden near Leonberg in Württemberg. His father was a Protestant pastor, and he was trained to be a mining engineer. He was ambitious, however, to become a scientific investigator of unknown regions, and with that object studied the natural sciences, especially zoology. In 1850 he went to Egypt where he learnt Arabic, afterwards visiting Arabia Petraea. In 1852 he accompanied Dr Reitz, Austrian consul at Khartum, on a journey to Abyssinia, and in the next year was appointed Dr Reitz's successor in the consulate. While he held this post he travelled in Abyssinia and Kordofan, making a valuable collection of natural history specimens. In 1857 he journeyed through the coast lands of the African side of the Red Sea, and along the Somali coast. In 1860 he was chosen

of varying merit and the metre suits the German language distinctly better than the English. The customary form of hexameter in English verse is exemplified by Coleridge's descriptive line:—

"In the hex | ameter | rises the | fountain's | silvery | column."

Several modern poets, and in particular Robert Browning, and Lord Bowen (1835-1894) have used with effect a truncated hexameter consisting of the usual verse deprived of its last syllable. Thus Browning:—

"Well, it is | gone at | last, the | palace of | music I | reared."

It is not sufficiently observed that even the classic Greek poets introduced considerable variations into their treatment of the hexameter. These have been treated with erudition in G. Hermann's *De aelate scriptoris Argonauticorum*. The differences in the hexameters of the Latin poets were not so remarkable, but even these varied, in various epochs, their treatment of the separate feet, and the position of the caesura. The satirists in particular allowed themselves an extraordinary licence: these hexameters, from Persius, are as far removed from the rhythm of Homer, or even of Virgil, as possible, if they are to remain hexameters:—

"Mane piger stertis. 'Surge!' inquit Avaritia, 'heia
Surge!' negas; instat 'Surge!' inquit 'Non queo.' 'Surge!'
'Et quid agam?' 'Rogitas? en sperdam advehe Ponto."

It is also to be noted that various prosodial liberties, due originally to the extreme antiquity of the hexameter, and long reformed and repressed by the culture of poets, were apt to be revived in later ages, by writers who slavishly copied the most antique examples of the art of verse.

See Wilhelm Christ, *Metrik der Griechen und Römer*, 2te Aufl. (1879).

HEXAPLA (Gr. for "sixfold"), the term for an edition of the Bible in six versions, and especially the edition of the Old Testament compiled by Origen, which placed side by side (1) Hebrew, (2) Hebrew in Greek character, (3) Aquila, (4) Symmachus, (5) Septuagint, (6) Theodotion. See **BIBLE: Old Testament, Texts and Versions**.

HEXAPODA (Gr. ἕξ, six, and πούς, foot), a term used in systematic zoology for that class of the **ARTHROPODA**, popularly known as insects. Linnæus in his *Systema naturæ* (1735) grouped under the class *Insecta* all segmented animals with firm exoskeleton and jointed limbs—that is to say, the insects, centipedes, millipedes, crustaceans, spiders, scorpions and their allies. This assemblage is now generally regarded as a great division (phylum or sub-phylum) of the animal kingdom and known by K. T. E. von Siebold's (1848) name of *Arthropoda*. For the class of the true insects included in this phylum, Linnæus's old term *Insecta*, first used in a restricted sense by M. J. Brisson (1756), is still adopted by many zoologists, while others prefer the name *Hexapoda*, first used systematically in its modern sense by P. A. Latreille in 1825 (*Familles naturelles du règne animal*), since it has the advantage of expressing, in a single word, an important characteristic of the group. The terms "*Hexapoda*" and "*hexapod*" had already been used by F. Willughby, J. Ray and others in the late 17th century to include the active larvae of beetles, as well as bugs, lice, fleas and other insects with undeveloped wings.

Characters.

A true insect, or member of the class *Hexapoda*, may be known by the grouping of its body-segments in three distinct regions—a head, a thorax and an abdomen—each of which consists of a definite number of segments. In the terminology proposed by E. R. Lankester the arrangement is "nomomeristic" and "nomotagmic." The head of an insect carries usually four pairs of conspicuous appendages—feelers, mandibles and two pairs of maxillæ, so that the presence of four primitive somites is immediately evident. The compound eyes of insects resemble so closely the similar organs in *Crustaceans* that there can hardly be reasonable doubt of their homology, and the primitively appendicular nature of the eyes in the latter class suggests that in the *Hexapoda* also they represent the

appendages of an anterior (protocerebral) segment. Behind the antennal (or deutocerebral) segment an "intercalary" or tritocerebral segment has been demonstrated by W. M. Wheeler (1893) and others in various insect embryos, while in the lowest insect order—the *Aptera*—a pair of minute jaws—the maxillulæ—in close association with the tongue are present, as has been shown by H. J. Hansen (1893) and J. W. Folsom (1900). Distinct vestiges of the maxillulæ exist also in the earwigs and booklice, according to G. Enderlein and C. Börner (1904), and they are very evident in larval may-flies. The number of limb-bearing somites in the insectan head is thus seen to be seven. All of these are to be regarded as primitively post-oral, but in the course of development the mouth moves back to the mandibular segment, so that the first three somites—ocular, antennal and intercalary—lie in front of it. In Lankester's terminology, therefore, the head of an insect is "triprothomerous." The maxillæ of the hinder pair become more or less fused together to form a "lower lip" or labium, and the segment of these appendages is, in some insects, only imperfectly united with the head-capsule.

The thorax is composed of three segments; each bears a pair of jointed legs, and in the vast majority of insects the two hindmost bear each a pair of wings. From these three pairs of thoracic legs comes the name—*Hexapoda*—which distinguishes the class. And the wings, though not always present, are highly characteristic of the *Hexapoda*, since no other group of the *Arthropoda* has acquired the power of flight. In the more generalized insects the abdomen evidently consists of ten segments, the hindmost of which often carries a pair of tail-feelers, (cerci or cercopods) and a terminal anal segment. In some cases, however, it can be shown that the cerci really belong to an eleventh abdominal segment which usually becomes fused with the tenth. With very few exceptions the abdomen is without locomotor limbs. Paired processes on the eighth and ninth abdominal segments may be specialized as external organs of reproduction, but these are probably not appendages. The female genital opening usually lies in front of the eighth abdominal segment, the male duct opens on the ninth.

In all main points of their internal structure the *Hexapoda* agree with other *Arthropoda*. Specially characteristic of the class, however, is the presence of a complex system of air-tubes (tracheæ) for respiration, usually opening to the exterior by a series of paired spiracles on certain of the body segments. The possession of a variable number of excretory tubes (Malpighian tubes), which are developed as outgrowths of the hind-gut and pour their excretion into the intestine, is also a distinctive character of the *Hexapoda*.

The wings of insects are, in all cases, developed after hatching, the younger stages being wingless, and often unlike the parent in other respects. In such cases the development of wings and the attainment of the adult form depend upon a more or less profound transformation or metamorphosis.

With this brief summary of the essential characters of the *Hexapoda*, we may pass to a more detailed account of their structure.

EXOSKELETON

The outer cellular layer (ectoderm or "hypodermis") of insects as of other *Arthropods*, secretes a chitinous cuticle which has to be periodically shed and renewed during the growth of the animal. The regions of this cuticle have a markedly segmental arrangement, and the definite hardened pieces (sclerites) of the exoskeleton are in close contact with one another along linear sutures, or are united by regions of the cuticle which are less chitinous and more membranous, so as to permit freedom of movement.

Head.—The head-capsule of an insect (figs. 1, 2) is composed of a number of sclerites firmly sutured together, so that the primitive segmentation is masked. Above is the crown (*vertex* or *epicranium*), on which or on the "front" may be seated three simple eyes (ocelli). Below this comes the front, and then the face or clypeus, to which a very distinct upper lip (*labrum*) is usually jointed. Behind the labrum arises a process—the *epipharynx*—which in some blood-sucking insects becomes a formidable piercing-organ. On either side a variable amount of convex area is occupied by the compound eye; in many insects of acute sense and accurate flight these eyes are very large and sub-globular, almost meeting on the middle line of the

head. Below each eye is a cheek area (*gena*), often divided into an anterior and a posterior part, while a distinct chin-sclerite (*gula*) is often developed behind the mouth.

Feelers.—Most conspicuous among the appendages of the head are the feelers or antennae, which correspond to the anterior feelers

jointed limb or palp (fig. 1, C, *pa*). Such maxillae are found in most biting insects. In insects whose mouths are adapted for sucking and piercing, remarkable modifications may occur. In many blood-sucking flies, for example, the galea is absent, while the lacinia becomes a strong knife-like piercer and the palp is well developed.

In bugs and aphids the lacinia is a slender needle-like piercer (fig. 2, III), while the palp is wanting. In butterflies and moths the lacinia is absent while the galea becomes a flexible process, grooved on its inner face, so as to make with its fellow a hollow sucking-trunk, and the palp is usually very small.

The second pair of maxillae are more or less completely fused together to form what is known as the *labium* or "lower lip." In generalized biting insects, such as cockroaches and locusts (Orthoptera), the parts of a typical maxilla can be easily recognized in the labium. The fused cardines form a broad basal plate (*sub-mentum*) and the stipes a smaller plate (*mentum*)—see fig. 1, C, *sm*, *m*—joined on to the sub-mentum, while the galeae, laciniae and palps remain distinct. In specialized biting insects, such as beetles (Coleoptera), the labium tends to become a hard transverse plate bearing the pair of palps, a median structure—known as the *ligula*—formed of the conjoined laciniae, and a pair of small rounded processes—the reduced galeae—often called the "paraglossae," a term better avoided since it has been applied also

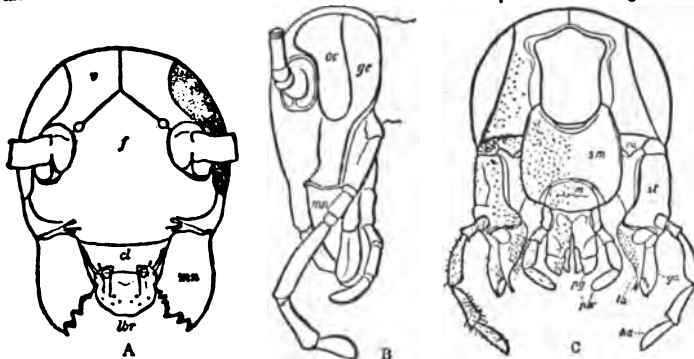

From Mill and Deary, *The Cockroach*, Lovell Reeve & Co.

FIG. 1.—Head and Jaws of Cockroach (*Blattella*). Magnified 10 times. A, Front; B, side; C, back; *v*, vertex; *f*, fronts; *d*, clypeus; *lbr*, labrum; *ac*, compound eye; *gc*, gena; *mn*, mandible; *ca*, *st*, *pa*, *ga*, *la*, cardo, stipes, palp, galea, lacinia of first maxilla; *sm*, *m*, *pa*, *gc*, submentum, mentum, palp, galea of 2nd maxilla.

(antennules) of Crustacea. In their simpler condition they are long and many-jointed, the segments bearing numerous olfactory and tactile nerve-endings. Elaboration in the form of the feelers, often a secondary sexual character in male insects, may result from a distal broadening of the segments, so that the appendage becomes serrate, or from the development of processes bearing sensory organs, so that the structure is pinnate or feather-like. On the other hand, the number of segments may be reduced, certain of them often becoming highly modified in form.

Jaws.—The mandibles of the Hexapoda are usually strong jaws with one or more teeth at the apex (fig. 1, A, B, *mn*), articulating at their bases with the head-capsule by sub-globular condyles, and provided with abductor and adductor muscles by means of which they can be separated or drawn together so as to bite solid food, or seize objects which have to be carried about. They never bear segmented limbs (palps) and only exceptionally (as in the chafers) is the skeleton composed of more than one sclerite. The mandibles often furnish a good example of "secondary sexual characters," being more strongly developed in the male than in the female of the same species. In most insects that feed by suction the mandibles are modified. In bugs (Heteroptera) and many flies, for example, they are changed into needle-like piercers (fig. 2, II), while in moths and caddis-flies they are reduced to mere vestiges or altogether suppressed.

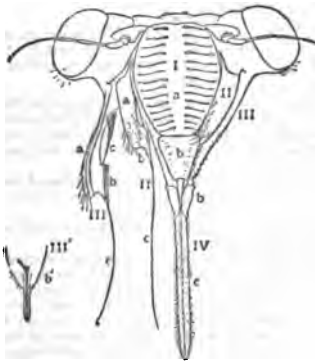

After Mariatt *Entom. Bull.* 14, n. 8. (U.S. Dept. Agric.)

FIG. 2.—Head of Cicada, front view. *la*, frons; *b*, clypeus (the pointed labrum beneath it); *II*, mandible; *III*, first maxilla; (*a*, base; *b*, sheath; *c*, piercer); *III'*, inner view of sheath; *IV*, second maxillae forming rostrum (*b*, mentum; *c*, ligula).

lobe arising from a basal piece, which bears also in some genera a small palp (see **APTERA**).

In their typical state of development, the first maxillae offer a striking contrast to the mandibles, being composed of a two-segmented basal piece (*cardo* and *stipes*, fig. 1, C, *ca*, *st*) bearing a distinct inner and outer lobe (*lacinia* and *galea*, fig. 1, C, *la*, *ga*) and externally a

to the maxillulae of Aptera, entirely different structures. The long sucking "tongue" of bees is probably a modification of the ligula. In bugs and aphids (Hemiptera), the fused second maxillae form a jointed grooved beak or rostrum (fig. 2, IV) in which the slender piercers (mandibles and first maxillae) work to and fro.

This second pair of maxillae (or labium) form then the hinder or lower boundary of the mouth. In front or above the mouth is bounded by the labrum, while the mandibles and first maxillae lie on either side of it. A median process, known as the *hypopharynx* or tongue, arises from the floor of the mouth in front of the labium, and becomes most variously developed or specialized in different insects. The salivary duct opens on its hinder surface. It does not appear to represent a pair of appendages, but the maxillulae of the Aptera become closely associated with it. According to the view of R. Heymons, the hypopharynx represents the sterna of all the jaw-bearing somites, but other students consider that it belongs to the mandibular and first maxillary segments, or entirely to the segment of the first maxillae.

Neck.—The head is usually connected with the thorax by a distinct membranous neck, strengthened in the more generalized orders with small chitinous plates (*cervical sclerites*). These have been interpreted as indicating one or more primitive segments between the head and thorax. Probably, however, as suggested by T. H. Huxley (*Anat. Insect. Animals*, 1877), they really belong to the labial segment which has not become completely fused with the head-capsule. It has been shown by C. Janet (1889), from careful studies of the musculature, that the greater part of the head-capsule is built up of the four anterior head-segments, the hindmost of which has the mandibles for its appendages, and this conclusion is in the main supported by the recent work on the head skeleton of J. H. Comstock and C. Kochi (1902) and W. A. Riley (1904).

Thorax.—The three segments which make up the thorax or fore-trunk are known as the *prothorax*, *mesothorax* and *metathorax* (see fig. 3). The dorsal area of the prothorax is occupied by a single sclerite, the *pronotum* (fig. 3, *d*), which is large and conspicuous in those insects, such as cockroaches, bugs (Heteroptera) and beetles, which have the prothorax free—i.e. readily movable on the segment (mesothorax) immediately behind—smaller and of less importance where the prothorax is fixed to the mesothorax, as in bees and flies. The dorsal area of the mesothorax, and also of the metathorax, may be made up of a series of sclerites arranged one behind the other—*prescutum*, *scutum*, *scutellum* and *post-scutellum* (fig. 3, *e*, *f*, *g*, *h*), the scutellum of the mesothorax being often especially conspicuous. Ventrally, each segment of the thorax has a *sternum* with which a median *pre-sternum* and paired *episterna* and *epimeria* are often associated (see figs. 3, 4). The recent suggestion of K. W. Verhoeff (1904) that the hexapodan thorax in reality contains six primitive segments is entirely without embryological support.

Legs.—Each segment of the thorax carries a pair of legs. In most insects the leg is built up of nine segments: (1) a broad triangular, sub-globular, conical or cylindrical haunch (*coxa*); (2) a small *trochanter*; (3) an elongate stout thigh (*femur*); (4) a more slender shin (*tibia*); and (5-9) a foot consisting of five tarsal segments. The fifth (distal) tarsal segment carries a median adhesive pad—the *pulvillus*—on either side of which is a claw. The pulvillus is

leader of an expedition to search for Eduard Vogel, his companions including Werner Munzinger, Gottlob Kinzelbach, and Dr Hermann Steudner. In June 1861 the party landed at Massawa, having instructions to go direct to Khartum and thence to Wadai, where Vogel was thought to be detained. Heuglin, accompanied by Dr Steudner, turned aside and made a wide detour through Abyssinia and the Galla country, and in consequence the leadership of the expedition was taken from him. He and Steudner reached Khartum in 1862 and there joined the party organized by Miss Tinné. With her or on their own account, they travelled up the White Nile to Gondokoro and explored a great part of the Bahr-el-Ghazal, where Steudner died of fever on the 10th of April 1863. Heuglin returned to Europe at the end of 1864. In 1870 and 1871 he made a valuable series of explorations in Spitsbergen and Novaya Zemlya; but 1875 found him again in north-east Africa, in the country of the Beni Amer and northern Abyssinia. He was preparing for an exploration of the island of Sokotra, when he died, at Stuttgart, on the 5th of November 1876. It is principally by his zoological, and more especially his ornithological, labours that Heuglin has taken rank as an independent authority.

His chief works are *Systematische Übersicht der Vögel Nordost-Afrikas* (1855); *Reisen in Nordost-Afrika, 1852-1853* (Gotha, 1857); *Syst. Übersicht der Säugetiere Nordost-Afrikas* (Vienna, 1867); *Reise nach Abessinien, den Galla-Ländern, &c., 1861-1862* (Jena, 1868); *Reise in das Gebiet des Weissen Nil, &c., 1862-1864* (Leipzig, 1866); *Reisen nach dem Nordpolarmeer, 1870-1871* (Brunswick, 1872-1874); *Ornithologie von Nordost-Afrika* (Cassel, 1869-1875); *Reise in Nordost-Afrika* (Brunswick, 1877, 2 vols.). A list of the more important of his numerous contributions to *Petermann's Mitteilungen* will be found in that serial for 1877 at the close of the necrological notice.

HEULANDITE, a mineral of the zeolite group, consisting of hydrous calcium and aluminium silicate, $H_2CaAl_2(SiO_3)_6 + 3H_2O$. Small amounts of sodium and potassium are usually present replacing part of the calcium. Crystals are monoclinic, and have a characteristic coffin-shaped habit. They have a perfect cleavage parallel to the plane of symmetry (*M* in the figure), on which the lustre is markedly pearly; on other faces the lustre is of the vitreous type. The mineral is usually colourless or white, sometimes brick-red, and varies from transparent to translucent. The hardness is 3½-4, and the specific gravity 2.2.

Heulandite closely resembles stilbite (*q.v.*) in appearance, and differs from it chemically only in containing rather less water of crystallization. The two minerals may, however, be readily distinguished by the fact that in heulandite the acute positive bisectrix of the optic axes emerges perpendicular to the cleavage. Heulandite was

first separated from stilbite by A. Breithaupt in 1818, and named by him euzoelite (meaning beautiful zeolite); independently, in 1822, H. J. Brooke arrived at the same result, giving the name heulandite, after the mineral collector, Henry Heuland.

Heulandite occurs with stilbite and other zeolites in the amygdaloidal cavities of basaltic volcanic rocks, and occasionally in gneiss and metalliferous veins. The best specimens are from the basalts of Berufjord, near Djupivogur, in Iceland and the Faroe Islands, and the Deccan traps of the Sahyadri mountains near Bombay. Crystals of a brick-red colour are from Campsie Fells in Stirlingshire and the Fassathal in Tirol. A variety known as beaumontite occurs as small yellow crystals on ayeenitic schist near Baltimore in Maryland.

Isomorphous with heulandite is the strontium and barium zeolite brewsterite, named after Sir David Brewster. The greyish monoclinic crystals have the composition $H_2(Sr, Ba, Ca)Al_2(SiO_3)_6 + 3H_2O$, and are found in the basalt of the Giant's Causeway in Co. Antrim, and with harmotome in the lead mines at Strontian in Argyllshire. (L. J. S.)

HEUSCH, WILLEM, or **GUILLEMIAM DE**, a Dutch landscape painter in the 17th century at Utrecht. The dates of this artist's birth and death are unknown. Nothing certain is recorded of him except that he presided over the guild of Utrecht, whilst Cornelis Poolemburg, Jan Both and Jan Weenix formed the

council of that body, in 1649. According to the majority of historians, Heusch was born in 1638, and was taught by Jan Both. But each of these statements seems open to doubt; and although it is obvious that the style of Heusch is identical with that of Both, it may be that the two masters during their travels in Italy fell under the influence of Claude Lorraine, whose "Arcadian" art they imitated. Heusch certainly painted the same effects of evening in wide expanses of country varied by rock formations and lofty thin-leaved arborescence as Both. There is little to distinguish one master from the other, except that of the two Both is perhaps the more delicate colourist. The guild of Utrecht in the middle of the 17th century was composed of artists who clung faithfully to each other. Poolemburg, who painted figures for Jan Both, did the same duty for Heusch. Sometimes Heusch sketched landscapes for the battlepieces of Molenær. The most important examples of Heusch are in the galleries of the Hague and Rotterdam, in the Belvedere at Vienna, the Südel at Frankfurt and the Louvre. His pictures are signed with the full name, beginning with a monogram combining a G (for Guillemiam), D and H. Heusch's etchings, of which thirteen are known, are also in the character of those of Both.

After Guillemiam there also flourished at Utrecht his nephew, Jacob de Heusch, who signs like his uncle, substituting an initial J for the initial G. He was born at Utrecht in 1657, learnt drawing from his uncle, and travelled early to Rome, where he acquired friends and patrons for whom he executed pictures after his return. He settled for a time at Berlin, but finally retired to Utrecht, where he died in 1701. Jacob was an "Arcadian," like his relative, and an imitator of Both, and he chiefly painted Italian harbour views. But his pictures are now scarce. Two of his canvases, the "Ponte Rotto" at Rome, in the Brunswick Gallery, and a lake harbour with shipping in the Lichtenstein collection at Vienna, are dated 1696. A harbour with a tower and distant mountains, in the Belvedere at Vienna, was executed in 1699. Other examples may be found in English private galleries, in the Hermitage of St Petersburg and the museums of Rouen and Montpellier.

HEVELIUS [HEVEL or HÖWELCKE], **JOHANN** (1611-1687), German astronomer, was born at Danzig on the 28th of January 1611. He studied jurisprudence at Leiden in 1630; travelled in England and France; and in 1634 settled in his native town as a brewer and town councillor. From 1639 his chief interest became centred in astronomy, though he took, throughout his life, a leading part in municipal affairs. In 1641 he built an observatory in his house, provided with a splendid instrumental outfit, including ultimately a tubeless telescope of 150 ft. focal length, constructed by himself. It was visited, on the 29th of January 1660, by John II. and Maria Gonzaga, king and queen of Poland. Hevelius made observations of sunspots, 1642-1645, devoted four years to charting the lunar surface, discovered the moon's libration in longitude, and published his results in *Selenographia* (1647), a work which entitles him to be called the founder of lunar topography. He discovered four comets in the several years 1652, 1661, 1672 and 1677, and suggested the revolution of such bodies in parabolic tracks round the sun. On the 26th of September 1679, his observatory, instruments and books were maliciously destroyed by fire, the catastrophe being described in the preface to his *Annus climactericus* (1685). He promptly repaired the damage, so far as to enable him to observe the great comet of December 1680; but his health suffered from the shock, and he died on the 28th of January 1687. Among his works were: *Prodromus cometicus* (1665); *Cometographia* (1668); *Machina coelestis* (first part, 1673), containing a description of his instruments; the second part (1679) is extremely rare, nearly the whole issue having perished in the conflagration of 1679. The observations made by Hevelius on the variable star named by him "Mira" are included in *Annus climactericus*. His catalogue of 1564 stars appeared posthumously in *Prodromus astronomiae* (1690). Its value was much impaired by his preference of the antique "pinnules" to telescopic sights on quadrants. This led to an acrimonious

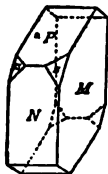

controversy with Robert Hooke. In an *Atlas* of 50 sheets, corresponding to his catalogue, and entitled *Firmamentum Sobiescianum* (1690), he delineated seven new constellations, still in use. Hevelius had his book printed in his own house, at lavish expense, and himself not only designed but engraved many of the plates.

See J. H. Westphal, *Leben, Studien, und Schriften des Astronomen Johann Hevelius* (1820); C. B. Lengnich, *Anekdoten und Nachrichten* (1786); *Allgemeine deutsche Biographie* (C. Bruhns); J. B. J. Delambre, *Histoire de l'astronomie moderne*, ii. 471; J. F. Weidler, *Historia astronomiae*, p. 486; F. Baily's edition of the *Catalogue of Hevelius*, *Memoirs Roy. Astr. Society*, xiii. (1843); R. Wolf, *Geschichte der Astronomie*, p. 396; J. C. Poggenдорff, *Biog.-lit. Handwörterbuch*. For an account of the epistolary remains of Hevelius, see C. G. Hecker, *Monatl. Correspondenz*, viii. 30; also *Astr. Nachrichten*, vols. xxiii., xxv. (A. M. C.)

HEWETT, SIR PRESCOTT GARDNER, Bart. (1812-1891), British surgeon, was born on the 3rd of July 1812, being the son of a Yorkshire country gentleman. He lived for some years in early life in Paris, and started on a career as an artist, but abandoned it for surgery. He entered St George's Hospital, London (where his half-brother, Dr Cornwallis Hewett, was physician from 1825 to 1833) becoming demonstrator of anatomy and curator of the museum. He was the pupil and intimate friend of Sir B. C. Brodie, and helped him in much of his work. Eventually he rose to be anatomical lecturer, assistant-surgeon and surgeon to the hospital. In 1876 he was president of the College of Surgeons; in 1877 he was made serjeant-surgeon extraordinary to Queen Victoria, in 1888 serjeant-surgeon, and in 1883 he was created a baronet. He was a very good lecturer, but shrank from authorship; his lectures on *Surgical Affections of the Head* were, however, embodied in his treatise on the subject in Holmes's *System of Surgery*. As a surgeon he was always extremely conservative, but hesitated at no operation, however severe, when convinced of its expediency. He was a perfect operator, and one of the most trustworthy of counsellors. He died on the 19th of June 1891.

HEWITT, ABRAM STEVENS (1822-1903), American manufacturer and political leader, was born in Haverstraw, New York, on the 31st of July 1822. His father, John, a Staffordshire man, was one of a party of four mechanics who were sent by Boulton and Watt to Philadelphia about 1790 to set up a steam engine for the city water-works and who in 1793-1794 built at Belleville, N.J., the first steam engine constructed wholly in America; he made a fortune in the manufacture of furniture, but lost it by the burning of his factories. The boy's mother was of Huguenot descent. He graduated with high rank from Columbia College in 1842, having supported himself through his course. He taught mathematics at Columbia, and in 1845 was admitted to the bar, but, owing to defective eyesight, never practised. With Edward Cooper (son of Peter Cooper, whom Hewitt greatly assisted in organizing Cooper Union, and whose daughter he married) he went into the manufacture of iron girders and beams under the firm name of Cooper, Hewitt & Co. His study of the making of gun-barrel iron in England enabled him to be of great assistance to the United States government during the Civil War, when he refused any profit on such orders. The men in his works never struck—indeed in 1873-1878 his plant was run at an annual loss of \$100,000. In politics he was a Democrat. In 1871 he was prominent in the re-organization of Tammany after the fall of the "Tweed Ring"; from 1875 until the end of 1886 (except in 1879-1881) he was a representative in Congress; in 1876 he left Tammany for the County Democracy; in the Hayes-Tilden campaign of that year he was chairman of the Democratic National Committee, and in Congress he was one of the House members of the joint committee which drew up the famous Electoral Count Act providing for the Electoral Commission. In 1886 he was elected mayor of New York City, his nomination having been forced upon the Democratic Party by the strength of the other nominees, Henry George and Theodore Roosevelt; his administration (1887-1888) was thoroughly efficient and creditable, but he broke with Tammany, was not renominated, and independently for re-election, and was defeated. In 1896

and 1900 he voted the Republican ticket, but did not ally himself with the organization. He died in New York City on the 18th of January 1903. In Congress he was a consistent defender of sound money and civil service reform; in municipal politics he was in favour of business administrations and opposed to partisan nominations. He was a leader of those who contended for reform in municipal government, was conspicuous for his public spirit, and exerted a great influence for good not only in New York City but in the state and nation. His most famous speech was that made at the opening of the Brooklyn Bridge in 1883. He was a terse, able and lucid speaker, master of wit and sarcasm, and a fearless critic. He gave liberally to Cooper Union, of which he was trustee and secretary, and which owes much of its success to him; was a trustee of Columbia University from 1901 until his death, chairman of the board of trustees of Barnard College, and was one of the original trustees, first chairman of the board of trustees, and a member of the executive committee of the Carnegie Institution.

HEWLETT, MAURICE HENRY (1861-), English novelist, was born on the 22nd of January 1861, the eldest son of Henry Gay Hewlett, of Shaw Hall, Addington, Kent. He was educated at the London International College, Spring Grove, Isleworth, and was called to the bar in 1891. From 1896 to 1900 he was keeper of the land revenue records and enrolments. He published in 1895 two books on Italy, *Earthwork out of Tuscany*, and (in verse) *The Masque of Dead Florentines*. *Songs and Meditations* followed in 1897, and in 1898 he won an immediate reputation by his *Forest Lovers*, a romance of medieval England, full of rapid movement and passion. In the same year he printed the pastoral and pagan drama of *Pan and the Young Shepherd*, shortened for purposes of representation and produced at the Court Theatre in March 1905, when it was followed by the *Youngest of the Angels*, dramatized from a chapter in his *Fool Errant*. In *Little Novels of Italy* (1899), a collection of brilliant short stories, he showed again his power of literary expression together with a close knowledge of medieval Italy. The new and vivid portraits of Richard Cœur de Lion in his *Richard Yea-and-Nay* (1900), and of Mary, queen of Scots, in *The Queen's Quair* (1904) showed the combination of fiction with real history at its best. *The New Canterbury Tales* (1901) was another volume of stories of English life, but he returned to Italian subjects with *The Road in Tuscany* (1904); in *Fond Adventures*, *Tales of the Youth of the World* (1905), two are Italian tales, and *The Fool Errant* (1905) purports to be the memoirs of Francis Antony Stretley, citizen of Lucca. Later works were the novel *The Sleeping Lady* (1907), and a volume of poems, *Artemision* (1909).

HEXAMETER, the name of the earliest and most important form of classical verse in dactylic rhythm. The word is due to each line containing six feet or measures (*ἑξάπα*), the last of which must be a spondee and the penultimate a dactyl, though occasionally, for some special effect, a spondee may be allowed in the fifth foot, when the line is said to be spondaic. The four other feet may be either spondees or dactyls. All the great heroic and epic verse of the Greek and Roman poets is in this metre, of which the finest examples are to be found in Homer and in Virgil. Varied cadences and varied caesura are essential to this form of verse, otherwise the monotony is wearying to the ear. The most usual places for the caesura are at the middle of the third, or the middle of the fourth foot: the former is known as the penthemimeral and the latter as hepthemimeral caesura. There are several more or less successful examples of English poems in this metre, for example Longfellow's *Evangeline*, Kingsley's *Andromeda* and Clough's *Bohio of Tober-na-Vuolich*, but it does not really suit the genius of the English language. In English the lack of true spondees is severely felt, even though the English metre depends, not, as in Greek and Latin, on the distinction between long and short syllables, but on that between accented and unaccented syllables. The accent must always (or it sounds very ugly) fall on the first syllable, whatever may have been the case in Greek and Latin—Voss, Klopstock and Goethe have written hexameter poems

Muscular System.—The muscles in the Hexapoda are striated, as in Arthropoda generally, the large fibres being associated in bundles which are attached from point to point of the cuticle, so as to move adjacent sclerites with respect to one another (see figs. 8, 10). For example, the contraction of the tergo-sternal muscles, connecting the dorsal with the ventral sclerites of the abdomen, lessens the capacity of the abdominal region, while the contraction of the powerful muscles arising from the thoracic walls, and inserted into the proximal ends of the thighs, flexes or extends the legs.



After Mill and Denny, *The Cockroach*, Lovell Reeve & Co.
FIG. 10.—Dorsal Muscles, Heart and Pericardial Tendons of Cockroach.

cardial sinus through fine perforations of its floor, and so makes its way into the heart again. Some water-bugs, e.g. of the families *Belostomatidae*, *Nepidae*, *Corixidae* and *Hydrometridae* have a pulsating sac at each knee-joint to assist the flow of blood through the legs, while in dragon-flies and locusts (*Acrididae*) there is a ventral pulsating diaphragm, which forms the roof of a sinus enclosing the nerve-cords.

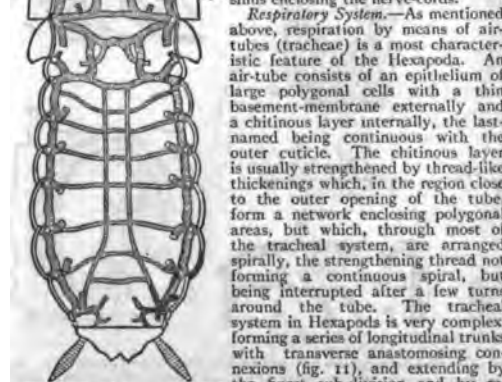

FIG. 11.—Ventral Portion of Air-Tubes in Cockroach.

Atmospheric air gains access to the air-tubes through paired spiracles or stigmata, which usually occur laterally on most of the

body-segments. These spiracles have firm chitinous edges, and can be closed by valves moved by special muscles. When the spiracles are open and the body contracts, air is expired. The subsequent expansion of the body causes fresh air to enter the tracheal system, and if the spiracles be then closed and the body again contracted, this air is driven to the finest branches of the air-tubes, where a direct oxygenation of the tissues takes place. The physiology of respiration has been carefully studied by F. Plateau (1884). In aquatic insects various devices for obtaining or entangling air are found; these modifications are described in the special articles on the various orders of insects (COLEOPTERA, HEMIPTERA, &c.). Many insects have aquatic larvae, some of which take in atmospheric air at intervals, while others breathe dissolved air by means of tracheal gills. These modifications are mentioned below in the section on metamorphosis.

Circulatory System.—Insects afford an excellent illustration of the remarkable type of blood-system characterizing the Arthropoda. The dorsal vessel is an elongate tube, whose abdominal portion is usually chambered, forming a contractile heart (fig. 10). At the constrictions between the chambers are paired slits, through which the blood passes from the surrounding pericardial sinus. The dorsal vessel is prolonged anteriorly into an aorta, through which the blood is propelled into the great body-cavity or haemocoel. After bathing the various tissues and organs, the blood returns dorsalwards into the pericardial sinus through fine perforations of its floor, and so makes its way into the heart again. Some water-bugs, e.g. of the families *Belostomatidae*, *Nepidae*, *Corixidae* and *Hydrometridae* have a pulsating sac at each knee-joint to assist the flow of blood through the legs, while in dragon-flies and locusts (*Acrididae*) there is a ventral pulsating diaphragm, which forms the roof of a sinus enclosing the nerve-cords.

Respiratory System.—As mentioned above, respiration by means of air-tubes (tracheae) is a most characteristic feature of the Hexapoda. An air-tube consists of an epithelium of large polygonal cells with a thin basement-membrane externally and a chitinous layer internally, the last-named being continuous with the outer cuticle. The chitinous layer is usually strengthened by thread-like thickenings which, in the region close to the outer opening of the tube, form a network enclosing polygonal areas, but which, through most of the tracheal system, are arranged spirally, the strengthening thread not forming a continuous spiral, but being interrupted after a few turns around the tube. The tracheal system in Hexapoda is very complex, forming a series of longitudinal trunks with transverse anastomosing connections (fig. 11), and extending by the finest sub-division and by repeated branching into all parts of the body. In insects of active flight the tubes swell out into numerous air-sacs, by which the breathing capacity is much increased.

Digestive System.—A striking feature in the food-canal of the Arthropoda, is the great extent of the "fore-gut" and "hind-gut" lined with a chitinous cuticle, continuous with the exoskeleton. The fore-gut is composed of a tubular gullet, a large sac-like crop (fig. 12, c) and a proventriculus or "gizzard," whose function is to strain the food-substances before they pass on into the tubular stomach, which has no chitinous lining. This organ, usually regarded as a "mid-gut," gives off a number of secretory caecal tubes (fig. 12, coe). At its hinder end it is continuous with the hind-gut, which is usually differentiated into a tubular coiled intestine (fig. 12, i) and a rectum (fig. 12, r). From the fore-end of the hind-gut arise the slender Malpighian tubes (fig. 12, h), which have a renal function.

On either side of the gullet are from one to ten pairs of salivary glands (fig. 12, s) whose ducts open into the mouth. Some of these glands may be modified for special purposes—as silk-producing glands in caterpillars or as poison-glands in blood-sucking flies and bugs. The food passing into the crop is there acted on by the saliva and also by an acid gastric juice which passes forwards from the stomach through the proventriculus. As the various portions of the food undergo digestion, they are allowed to pass through the proventriculus into the stomach, where the nutrient substances are absorbed.

Excretory System.—Nitrogenous waste-matter is removed from the body by the Malpighian tubes which open into the food-canal, usually where the hind-gut joins the stomach. These tubes vary in number from four to over a hundred in different orders of insects. The cells which line them and also the cavities of the tubes contain urates, which are excreted from the blood in the surrounding body-cavity. This cavity contains an irregular mass of whitish tissue, the fat-body, consisting of fat-cells which undergo degradation and become more or less filled with urates. When the worn-out cells are broken down, the urates are carried dissolved in the blood to the Malpighian tubes for excretion. The fat-body is therefore the seat of important metabolic processes in the hexapod body.

Reproductive System.—All the Hexapoda are of separate sexes. The ovaries (fig. 13) in the female are paired, each ovary consisting of a variable number of tubes (one in the bristle-tail *Camponotus* and fifteen hundred in a queen termite) in which the eggs are developed. From each ovary an oviduct (fig. 13, od) leads, and in some of the more primitive insects (bristle-tails, earwigs, may-flies) the two oviducts open separately direct to the exterior. Usually they open into a median vagina, formed by an ectodermal inpushing and lined with chitin. The vagina usually opens in front of the eighth abdominal sternite. Behind it is situated a spermatheca (fig. 14, sp)

Digestive System.—A striking feature in the food-canal of the Arthropoda, is the great extent of the "fore-gut" and "hind-gut" lined with a chitinous cuticle, continuous with the exoskeleton. The fore-gut is composed of a tubular gullet, a large sac-like crop (fig. 12, c) and a proventriculus or "gizzard," whose function is to strain the food-substances before they pass on into the tubular stomach, which has no chitinous lining. This organ, usually regarded as a "mid-gut," gives off a number of secretory caecal tubes (fig. 12, coe). At its hinder end it is continuous with the hind-gut, which is usually differentiated into a tubular coiled intestine (fig. 12, i) and a rectum (fig. 12, r). From the fore-end of the hind-gut arise the slender Malpighian tubes (fig. 12, h), which have a renal function.

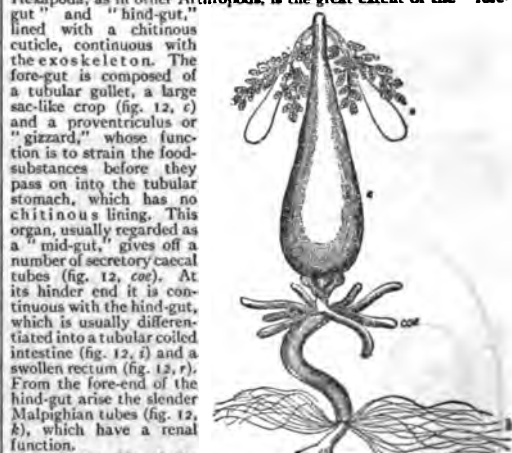

From Mill and Denny, *The Cockroach*, Lovell Reeve & Co.
FIG. 12.—Food Canal of Cockroach.

- s, Salivary glands and reservoir.
- c, Crop (the gizzard below it).
- coe, Caecal tubes (below them the stomach).
- h, Kidney tubes.
- i, Intestine.
- r, Rectum.

stomach, where the nutrient substances are absorbed.

Excretory System.—Nitrogenous waste-matter is removed from the body by the Malpighian tubes which open into the food-canal, usually where the hind-gut joins the stomach. These tubes vary in number from four to over a hundred in different orders of insects. The cells which line them and also the cavities of the tubes contain urates, which are excreted from the blood in the surrounding body-cavity. This cavity contains an irregular mass of whitish tissue, the fat-body, consisting of fat-cells which undergo degradation and become more or less filled with urates. When the worn-out cells are broken down, the urates are carried dissolved in the blood to the Malpighian tubes for excretion. The fat-body is therefore the seat of important metabolic processes in the hexapod body.

Reproductive System.—All the Hexapoda are of separate sexes. The ovaries (fig. 13) in the female are paired, each ovary consisting of a variable number of tubes (one in the bristle-tail *Camponotus* and fifteen hundred in a queen termite) in which the eggs are developed. From each ovary an oviduct (fig. 13, od) leads, and in some of the more primitive insects (bristle-tails, earwigs, may-flies) the two oviducts open separately direct to the exterior. Usually they open into a median vagina, formed by an ectodermal inpushing and lined with chitin. The vagina usually opens in front of the eighth abdominal sternite. Behind it is situated a spermatheca (fig. 14, sp)

and the ovipositor previously mentioned, with its three pairs of processes (Fig. 14, G, g).

The paired testes of the male consist of a variable number of seminal



From Miall and Denny, *The Cockroach*, Lovell Reeve & Co.
FIG. 13.—Ovaries of Cockroach, with Oviducts *Od* and Colleterial Glands *CG*.

tubes, those of each testis opening into a *vas deferens*. In some bristle-tails and may-flies, the two *vasa deferentia* open separately, but usually they lead into a sperm-reservoir, whence issues a median

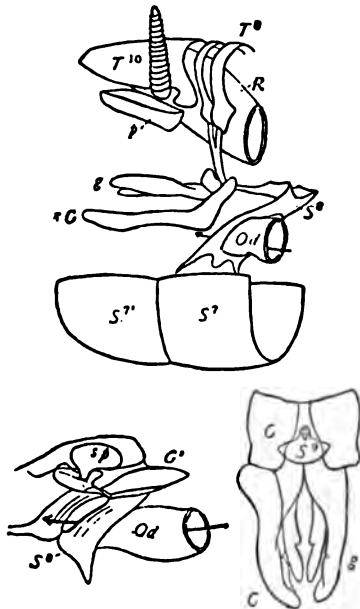

From Miall and Denny, *The Cockroach*, Lovell Reeve & Co.
FIG. 14.—Hinder Abdominal Segment and Ovipositor of Female Cockroach. Magnified.

T¹⁰ &c. Tergites.
S⁷, 7th Sternite.
S⁸, Sclerite between 7th and 8th
S⁹, 8th Sclerite.
Od, Vagina.
Sp, Spermatheca.
G, Anterior, and g, posterior gonapophyses

ejaculatory duct. The male opening is on the ninth abdominal segment, to which belong the processes that form the claspers or genital armature. Accessory glands are commonly present in connexion both with the male and the female reproductive organs. The poison-glands of the sting in wasps and bees are well-known examples of these.

EMBRYOLOGY

The Egg.—Among the Hexapoda, as in Arthropods generally, the egg is large, containing an accumulation of yolk for the nourishment of the growing embryo. Most insect eggs are of an elongate oval shape; some are globular, others flattened, while others again are flask-shaped, and the outer envelope (*chorion*) is often beautifully sculptured (figs. 20, d; 21, a, b). Various devices are adopted for the protection of the eggs from mechanical injury or from the attacks of enemies, and for fixing them in appropriate situations. For example, the egg may be raised above the surface on which it is laid by an elongate stalk; the eggs may be protected by a secretion, which in some cases forms a hard protective capsule or "purse"; or they may be covered with shed hairs of the mother, while among water-insects a gelatinous envelope, often of rope-like form, is common. In various groups of the Hexapoda—aphids and some flesh-flies (*Sarcophaga*), for example—the egg undergoes development within the body of the mother, and the young insect is born in an active state; such insects are said to be "viviparous."

Parthenogenesis.—A number of cases are known among the Hexapoda of the development of young from the eggs of virgin females. In insects so widely separated as bristle-tails and moths this occurs occasionally. In certain gall-flies (*Cynipidae*) no males are known to exist at all, and the species seems to be preserved entirely by successive parthenogenetic generations. In other gall-flies and in aphids we find that a sexual generation alternates with one or with many virgin generations. The offspring of the virgin females are in most of these instances females; but among the bees and wasps parthenogenesis occurs normally and always results in the development of males, the "queen" insect laying either a fertilized or unfertilized egg at will.

Maturation, Fertilization and Segmentation.—Polar bodies were first observed in the eggs of Hexapoda by F. Blochmann in 1887. The two nuclei are successively divided from the egg nucleus in the usual way, but they frequently become absorbed in the peripheral protoplasm instead of being extruded from the egg-cell altogether. It appears that in parthenogenetic eggs two polar nuclei are formed. According to A. Petrunkevich (1901-1903), the second polar nucleus uniting with one daughter-nucleus of the first polar body gives rise to the germ-cells of the parthenogenetically-produced male. There is no reunion of the second polar nucleus with the female pronucleus, but, according to the recent work of L. Doncaster (1906-1907) on the eggs of sawflies, the number of chromosomes is not reduced in parthenogenetic egg-nuclei, while, in eggs capable of fertilization, the usual reduction-divisions occur. Fertilization takes place as the egg is laid, the spermatozoa being ejected from the spermatheca of the female and making their way to the protoplasm of the egg through openings (micropyles) in its firm envelope. The segmentation of the fertilized nucleus results in the formation of a number of nuclei which arrange themselves around the periphery of the egg and, the protoplasm surrounding them becoming constricted, a blastoderm or layer of cells, enclosing the central yolk, is formed. Within the yolk the nuclei of some "yolk cells" can be distinguished.

Germinal Layers and Food-Canal.—The embryo begins to develop as an elongate, thickened, ventral region of the blastoderm which is known as the ventral plate or germ band.

Along this band a median furrow appears, and a mass of cells sinks within, the one-layered germ band thus becoming transformed into a band of two cell-layers (fig. 15). In some cases the inner layer is formed not by invagination but by proliferation or by delamination. The outer of these two layers (fig. 15, E) is the ectoderm. With regard to the inner layer (*endoblast* of some authors, fig. 15, M) much difference of opinion has prevailed. It has usually been regarded as representing both endoderm and mesoderm, and the groove which usually leads to its formation has been compared to the abnormally elongated blastopore of a typical gastrula. No doubt can be entertained that the greater part of the inner layer corresponds to the mesoderm of more ordinary embryos, for the coelomic pouches, the germ-cells, the musculature and the vascular system all arise from it. Further, there is general agreement that the chitin-lined fore-gut and hind-gut, which form

From Nussbaum in Miall and Denny's, *Cockroach*, Lovell Reeve & Co.

FIG. 15.—Diagram showing Formation of Germinal Layers. E, ectoderm; M, inner layer. Magnified.

the greater part of the digestive tract, arise from ectodermal invaginations (stomodaeum and proctodaeum respectively) at the positions of the future mouth and anus. The origin of the mid-gut (mesenteron), that has no chitinous lining in the developed insect, is the disputed point. According to the classical researches of A. Kowalevsky (1871 and 1887) on the embryology of the water-beetle *Hydrophilus* and of the muscid flies, an anterior and a posterior endoderm-rudiment both derived from the "endoblast" become apparent at an early stage, in close association with the stomodaeum and the proctodaeum respectively. These two endoderm-rudiments ultimately grow together and give rise to the epithelium of the mid-gut. These results were confirmed by the observations of K. Heider and W. M. Wheeler (1889) on the embryos of two beetles—*Hydrophilus* and *Doryphora* respectively. V. Graber, however (1884), stated that in the *Muscidae*, while the anterior endoderm-rudiment arises as Kowalevsky had observed, the posterior part of the "mid-gut" has its origin as a direct outgrowth from the proctodaeum. The recent researches of R. Heymons (1895) on the Orthoptera, and of A. Lécaillon (1898) on various leaf beetles, tend to show that the whole of the "mid-gut" arises from the proliferation of cells at the extremity of the stomodaeum and of the proctodaeum. On this view the entire food-canal in most Hexapoda must be regarded as of ectodermal origin, the "endoblast" represents mesoderm only, and the median furrow whence it arises can be no longer compared with the blastopore. According to Heymons, the yolk-cells must be regarded as the true endoderm in the hexapod embryo, for he states (1897) that in the bristle-tail *Lepisma* and in dragon-flies they give rise to the mid-gut. These views are not, however, supported by other recent observers. J. Carrière's researches (1897) on the embryology of the mason bee (*Chalicodoma*) agree entirely with the interpretations of Kowalevsky and Heider, and so on the whole do those of F. Schwangur, who has studied (1904) the embryonic development of Lepidoptera. He finds that the endoderm arises from an anterior and a posterior rudiment derived from the "endoblast," that many of the cells of these rudiments wander into the yolk, and that the mesenteric epithelium becomes reinforced by cells that migrate from the yolk. K. Escherich (1901), after a new research on the embryology of the muscid Diptera, claims that the fore and hind endodermal rudiments arise from the blastoderm by invagination, and are from their origin distinct from the mesoderm. On the whole it seems likely that the endoderm is represented in part by the yolk, and in part by those anterior and posterior rudiments which usually form the mesenteron, but that in some Hexapoda the whole digestive tract may be ectodermal. It must be admitted that some of the later work on insect embryology has justified the growing scepticism in the universal applicability of the "germ-layer theory." Heider has suggested, however, that the apparent origin of the mid-gut from the stomodaeum and proctodaeum may be explained by the presence of a "latent endoderm-group" in those invaginations.

Embryonic Membranes.—A remarkable feature in the embryonic development of most Hexapoda is the formation of a protective

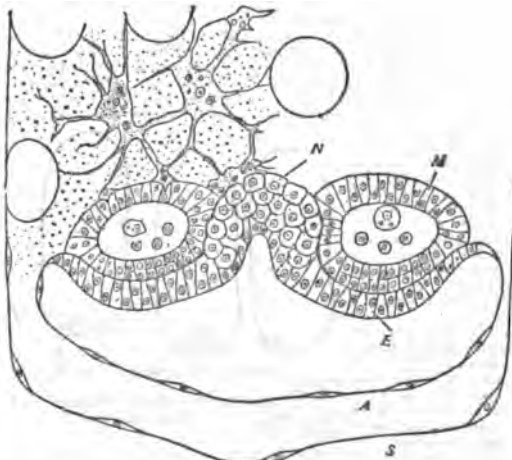

FIG. 16.—Cross section of Embryo of German Cockroach, Lovell Reeve et Co.

FIG. 16.—Cross section of Embryo of German Cockroach (*Phyllodromia*). S, serosa; A, amnion; E, ectoderm; N, rudiment of nerve cord; M, mesodermal pouches.

membrane analogous to the amnion of higher Vertebrates and known by the same term. Usually there arises around the edge

of the germ band a double fold in the undifferentiated blastoderm, which grows over the surface of the embryo, so that its inner and outer layers become continuous, forming respectively the *amnion* and the *serosa* (fig. 16, A, S). The embryo of a moth, a dragon-fly or a bug is invaginated into the yolk at the head end, the portion of the blastoderm necessarily pushed in with it forming the amnion. The embryo thus becomes transferred to the dorsal face of the egg, but at a later stage it undergoes reversion to its original ventral position. In some parasitic Hymenoptera there is only a single embryonic membrane formed by delamination from the blastoderm, while in a few insects, including the wingless spring-tails, the embryonic membranes are vestigial or entirely wanting. In the bristle-tails *Lepisma* and *Machilis*, an interesting transitional condition of the embryonic membranes has lately been shown by Heymons. The embryo is invaginated into the yolk, but the surface edges of the blastoderm do not close over, so that a groove or pore puts the insunken space that represents the amniotic cavity into communication with the outside. Heymons believes that the "dorsal organ" in the embryos of the lower Arthropoda corresponds with the region invaginated to form the serosa of the hexapod embryo. Wheeler, however, compares with the "dorsal organ" the peculiar extra embryonic membrane or indusium which he has observed between serosa and amnion in the embryo of the grasshopper *Xiphidium*.

Melameric Segmentation.—The segments are perceptible at a very early stage of the development as a number of transverse bands arranged in a linear sequence. The first segmentation of the ventral plate is not, however, very definite, and the segmentation does not make its appearance simultaneously throughout the whole length of the plate; the anterior parts are segmented before the posterior. In Orthoptera and Thysanura, as well as some others of the lower insects, twenty-one of these divisions—not, however, all similar—may be readily distinguished, six of which subsequently enter into the formation of the head, three going to the thorax and twelve to the abdomen. In Hemiptera only eleven and in Collembola only six abdominal segments have been detected. The first and last of these twenty-one divisions are so different from the others that they can scarcely be considered true segments.

Head Segments.—In the adult insect the head is insignificant in size compared with the thorax or abdomen, but in the embryo it forms a much larger portion of the body than it does in the adult. Its composition has been the subject of prolonged difference of opinion. Formerly it was said that the head consisted of four divisions, viz. three segments and the procephalic or pre-oral lobes. It is now ascertained that the procephalic lobes consist of three divisions, so that the head must certainly be formed from at least six segments. The first of these, according to the nomenclature of Heymons (see fig. 17), is the mouth or oral piece; the second, the antennal segment; the third, the intercalary or pre-mandibular segment; while the fourth, fifth, and sixth are respectively the segments of the mandibles and of the first and second maxillae. These six divisions of the head are diverse in kind, and subsequently undergo so much change that the part each of them takes in the formation of the head-capsule is not finally determined. The labrum and clypeus are developed as a single prolongation of the oral piece, not as a pair of appendages. The antennal segment apparently entirely disappears, with the exception of a pair of appendages it bears; these become the antennae; it is possible that the original segment, or some part of it, may even become a portion of the actual antennae. The intercalary segment has no appendages, nor rudiments thereof, except, according to H. Uzel (1897), in the thysanuran *Campodea*, and probably entirely disappears, though J. H. Comstock and C. Kochi believe that the labrum belongs to it. The appendages of the posterior three or trophal segments become the parts of the mouth. The appendages of the two maxillary segments arise as treble instead of single projections, thus differing from other appendages. From these facts it appears that the anterior three divisions of the head differ strongly from the posterior three, which greatly resemble thoracic segments; hence it has been thought possible that the anterior divisions may represent a primitive head, to which three segments and their leg-like appendages were subsequently added to form the head as it now exists. This is, however, very doubtful, and an entirely different inference is possible. Besides the five limb-bearing somites just enumerated, two others must now be recognized in the head. One of these is the ocular segment, in front of the antennal, and behind the primitive pre-oral segment. The other is the segment of the maxillulae (see above, under *Jaws*), behind the mandibular somite; the presence of this in the embryo of the collembolan *Anurida* has been lately shown (1900) by J. W. Folsom (fig. 18, v, 5), who terms the maxillulae "superlinguae" on account of their close association with the hypopharynx or lingua. In reference to the structure of the head-capsule in the imago, it appears that the clypeus and labrum represent, as already said, an unpaired median outgrowth of the oral piece. According to W. A. Riley (1904) the epicranium or "vertex," the compound eyes and the front divisions of the genae are formed by the cephalic lobes of the embryo (belonging to the ocular segment), while the mandibular and maxillary segments form the hinder parts of the genae and the hypopharynx.

Great difference of opinion exists as to the hypopharynx, which has even been thought to represent a distinct segment, or the pair of appendages of a distinct segment. Heymons considers that it represents the sternites of the three trophal segments, and that the gula is merely a secondary development. Folsom looks on the hypopharynx as a secondary development. Riley holds that the hypopharynx belongs to the mandibular and maxillary segments, while the cervical sclerites or gula represent the sternum of the labial segment. The ganglia of the nervous system offer some important evidence as to the morphology of the head, and are alluded to below.

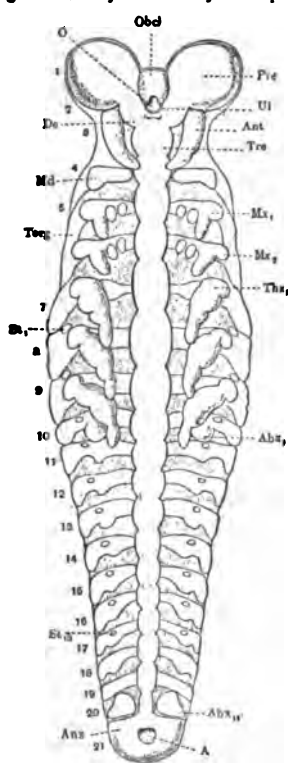

After Heymons.

FIG. 17.—Morphology of an Insect: the embryo of *Grylotalpa*, somewhat diagrammatic. The longitudinal segmented band along the middle line represents the early segmentation of the nervous system and the subsequent median field of each sternite; the lateral transverse unshaded bands are the lateral fields of each segment; the shaded areas indicate the more internally placed mesoderm layer. The segments are numbered 1-21; 1-6 will form the head, 7-9 the thorax, 10-21 the abdomen. A, anus; Abx, Abxi, appendage of 1st and of 11th abdominal segments; Anx, anal piece = telson or 12th abdominal segment; Ant, antenna; Ds, deuterecephalon; Md, mandible; Mxi, first maxilla; Mxii, second maxilla or labium; O, mouth; Obd, rudimentary labrum and clypeus; Pre, protencephalon; St, Stii, stigmata 1 and 10; Terg, tergite; Tks, appendage of first thoracic segment; Tre, tritencephalon; Ul, a thickening at hinder margin of the mouth.

according to Heymons they are really appendages of the eleventh segment, their connexion with the tenth being secondary and the result of considerable changes that take place in the terminal segments. It has been disputed whether any true cerci exist in the higher insects, but they are probably represented in the Diptera and in the scorpionflies (Mecoptera). In those insects in which a median terminal appendage exists between the two cerci this is considered to be a

prolongation of the eleventh tergite. The styleta, when present, are placed on the ninth segment, and in some *Thysanura* exist also on the eighth segment; their development takes place later in life than that of the cerci. The gonapophyses are the projections near the extremity of the body that surround the sexual orifices, and vary extremely according to the kind of insect. They have chiefly been studied in the female, and form the sting and ovipositor, organs peculiar to this sex. They are developed on the ventral surface of the body and are six in number, one pair arising from the eighth ventral plate and two pairs from the ninth. This has been found to be the case in insects so widely different as Orthoptera and Aculeate Hymenoptera. The genital armature of the male is formed to a considerable extent by modifications of the segments themselves. The development of the armature has been little studied, and the question whether there may be present gonapophyses homologous with those of the female is open.

Thoracic Segments.—These are always three in number. The three pairs of legs appear very early as rudiments. Though the thoracic segments bear the wings, no trace of these appendages exists till the close of the embryonic life, nor even, in many cases, till much later. The thoracic segments, as seen in an early stage of the ventral plate, display in a well-marked manner the essential elements of the insect segment. These elements are a central piece or sternite, and a lateral field on each side bearing the leg-rudiment. The external part of the lateral field subsequently grows up, and by coalescence with its fellow forms the tergite or dorsal part of the segment.

Abdominal Segments and Appendages.—We have already seen that in numerous lower insects the abdomen is formed from twelve divisions placed in linear fashion. Eleven of these may perhaps be considered as true segments, but the twelfth or terminal one is different, and is called by Heymons a telson; in it is placed the anal orifice, and the mass subsequently becomes the upper and lower laminae anales. In Hemiptera this telson is absent, and the anal orifice is placed quite at the termination of the eleventh segment. Moreover, in this order the abdomen shows at first a division into only nine segments and a terminal mass, which last subsequently becomes divided into two. The appendages of the abdomen are called cerci, stylets and gonapophyses. They differ much according to the kind of insect, and in the adult according to sex. Difference of opinion as to the nature of the abdominal appendages prevails. The cerci, when present, appear in the mature insect to be attached to the tenth segment, but

they are always attached to the thorax; in many *Thysanura* there are, however, processes on the abdomen that, as to their position, are similar to legs. In the embryos of many insects there are projections from the segments of the abdomen similar, to a considerable extent, to the rudimentary thoracic legs. The question whether these projections can be considered an indication of former polydopy in insects has been raised. They do not long persist in the embryo, but disappear, and the area each one occupied becomes part of the sternite. In some embryos there is but a single pair of these rudiments (or vestiges) situate on the first abdominal segment, and in some cases they become invaginations of a glandular nature. Whether cerci, stylets and gonapophyses are developed from these rudiments has been much debated. It appears that it is possible to accept cerci and stylets as modifications of the temporary pseudopods, but it is more difficult to believe that this is the case with the gonapophyses, for they apparently commence their development considerably later than cerci and stylets and only after the apparently complete disappearance of the embryonic pseudopods. The fact that there are two pairs of gonapophyses on the ninth abdominal segment would be fatal to the view that they are in any way homologous with legs, were it not that there is some evidence that the division into two pairs is secondary and incomplete. But another and apparently insuperable objection may be raised—that the appendages of the ninth segment are the stylets, and that the gonapophyses cannot therefore be appendicular. The pseudopods that exist on the abdomen of numerous caterpillars may possibly arise from the embryonic pseudopods, but this also is far from being established.

Nervous System.—The nervous system is ectodermal in origin, and is developed and segmented to a large extent in connexion with the outer part of the body, so that it affords important evidence as to the segmentation thereof. The continuous layer of cells from which the nervous system is developed undergoes a segmentation analogous with that we have described as occurring in the ventral plate; there is thus formed a pair of contiguous ganglia for each segment of the body, but there is no ganglion for the telson. The ganglia become greatly changed in position during the later life, and it is usually said that there are only ten pairs of abdominal ganglia even in the embryo. In Orthoptera, Heymons has demonstrated the existence of eleven pairs, the terminal pair becoming, however, soon united with the tenth. The nervous system of the embryonic head exhibits three ganglionic masses, anterior to the thoracic ganglionic masses; these three masses subsequently amalgamate and form the sub-oesophageal ganglion, which supplies the trophal segments. In front of the three masses that will form the sub-oesophageal ganglion the mass of cells that is to form the nervous system is very large, and projects on each side; this anterior or "brain" mass consists of three lobes (the prot-, deut-, and tritencephalon of Viallanes and others), each of which might be thought to represent a segmental ganglion. But the protocerebrum contains the ganglia of the ocular segment in addition to those of the procephalic lobes. These three divisions subsequently form the supra-oesophageal ganglion or brain proper. There are other ganglia in addition to those of the ventral chain, and Janet supposes that the ganglia of the sympathetic system indicate the existence of three anterior head-segments; the remains of the segments themselves are, in accordance with this view, to be sought in the



FIG. 18.—Embryos of Springtail (*Anuridamaritima*). Magnified. A, Head-region of germ band. B, Section through head and thorax. The neuromeres are shown in Roman numerals.

A. After Wheeler, Journ. Morph. vol. viii., and Folsom, Bull. Mus. Zool., xxvi.
B. After Folsom.

- 1, Ocular segment.
- 2, Antennal.
- 3, Trito-cerebral.
- 4, Mandibular.
- 5, Maxillary.
- 6, Labial.
- 7, Prothoracic.
- 8, Mesothoracic.
- 9, Metathoracic.

segmented to a large extent in connexion with the outer part of the body, so that it affords important evidence as to the segmentation thereof. The continuous layer of cells from which the nervous system is developed undergoes a segmentation analogous with that we have described as occurring in the ventral plate; there is thus formed a pair of contiguous ganglia for each segment of the body, but there is no ganglion for the telson. The ganglia become greatly changed in position during the later life, and it is usually said that there are only ten pairs of abdominal ganglia even in the embryo. In Orthoptera, Heymons has demonstrated the existence of eleven pairs, the terminal pair becoming, however, soon united with the tenth. The nervous system of the embryonic head exhibits three ganglionic masses, anterior to the thoracic ganglionic masses; these three masses subsequently amalgamate and form the sub-oesophageal ganglion, which supplies the trophal segments. In front of the three masses that will form the sub-oesophageal ganglion the mass of cells that is to form the nervous system is very large, and projects on each side; this anterior or "brain" mass consists of three lobes (the prot-, deut-, and tritencephalon of Viallanes and others), each of which might be thought to represent a segmental ganglion. But the protocerebrum contains the ganglia of the ocular segment in addition to those of the procephalic lobes. These three divisions subsequently form the supra-oesophageal ganglion or brain proper. There are other ganglia in addition to those of the ventral chain, and Janet supposes that the ganglia of the sympathetic system indicate the existence of three anterior head-segments; the remains of the segments themselves are, in accordance with this view, to be sought in the

stomodaeum. Folsom has detected in the embryo of *Anurida* a pair of ganglia (fig. 18, 5) belonging to the maxillary (or suprilingual) segment, thus establishing seven sets of cephalic ganglia, and supporting his view as to the composition of the head.

Air-tubes.—The air-tubes, like the food-canal are formed by invaginations of the ectoderm, which arise close to the developing appendages, the rudimentary spiracles appearing soon after the budding limbs. The pits leading from these lengthen into tubes, and undergo repeated branching as development proceeds.

Dorsal Closure.—The germ band evidently marks the ventral aspect of the developing insect, whose body must be completed by the extension of the embryo so as to enclose the yolk dorsally. The method of this dorsal closure varies in different insects. In the Colorado beetle (*Doryphora*), whose development has been studied by W. M. Wheeler, the amnion is ruptured and turned back from covering the germ band, enclosing the yolk dorsally and becoming finally absorbed, as the ectoderm of the germ band itself spreads to form the dorsal wall. In some midges and in caddis-flies the serosa becomes ruptured and absorbed, while the germ band, still clothed with the amnion, grows around the yolk. In moths and certain saw-flies there is no rupture of the membranes; the Russian zoologists Tichomirov and Kovalevsky have described the growth of both amnion and embryonic ectoderm around the yolk, the embryo being thus completely enclosed until hatching time by both amnion and serosa. V. Graber has described a similar method of dorsal closure in the saw-fly *Hylotoma*.

Mesoderm, Coelom and Blood-System.—From the mesoderm most of the organs of the body—muscular, circulatory, reproductive—

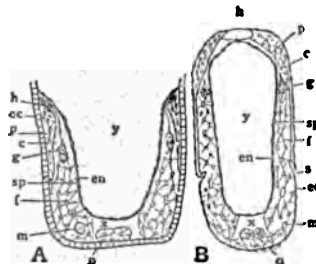

After Heymons, *Zool. Wiss. Zoolog.*, vol. 53.

FIG. 19.—Cross sections through Abdomen of German Cockroach Embryo. A (later than fig. 16) magnified. B (still more advanced, dorsal closure complete) magnified.

- ec, Ectoderm.
- en, Endoderm.
- sp, Splanchnic layer of mesoderm.
- y, Yolk.
- h, Heart.
- p, Pericardial septum.
- c, Coelom.
- g, Germ-cells surrounded by rudiment-cells of ovarian tubes.
- m, Muscle-rudiment.
- n, Nerve-chain.
- f, Fat body.
- a, Inpushing of ectoderm to form air-tubes.
- s, Secondary body-cavity.

the cavities of the genital glands and their ducts.

Reproductive Organs.—In the cockroach embryo, before the segmentation of the germ-band has begun, the primitive germ-cells can be recognized at the hinder end of the mesoderm, from whose ordinary cells they can be distinguished by their larger size. At a later stage further germ-cells arise from the epithelium of the coelomic pouches from the second to the seventh abdominal segments, and become surrounded by other mesoderm cells which form the ovarian or testicular tubes and ducts (fig. 19, g). In the male of *Phyllo-dromia* the rudiment of a vestigial ovary becomes separated from the developing testis, indicating perhaps an originally hermaphrodite condition. An exceedingly early differentiation of the primitive germ-cells occurs in certain Diptera. E. Metchnikoff observed (1866) in the development of the parthenogenetic eggs produced by the precocious larva of the gall-midge *Cecidomyia* that a large "polar-cell" appeared at one extremity during the primitive cell-segmentation. This by successive divisions forms a group of four to eight cells, which subsequently pass through the blastoderm, and dividing into two groups become symmetrically arranged and surrounded by the rudiments of the ovarian tubes. E. C. Balbiani and R. Ritter (1896) have since observed a similar early origin for the germ-cells in the midge *Chironomus* and in the *Aphidae*.

The paired oviducts and vasa deferentia are, as we have seen,

mesodermal in origin. The median vagina, spermatheca and ejaculatory duct are, on the other hand, formed by ectodermal inpushings. The classical researches of J. A. Palmén (1884) on these ducts have shown that in may-flies and in female earwigs the paired mesodermal ducts open directly to the exterior, while in male earwigs there is a single mesodermal duct, due either to the coalescence of the two or to the suppression of one. In the absence of the external ectodermal ducts usual in winged insects, these two groups resemble therefore the primitive Aptera. The presence of rudiments of the genital ducts of both sexes in the embryo of either sex is interesting and suggestive. The ejaculatory duct which opens on the ninth abdominal sternum in the adult male arises in the tenth abdominal embryonic segment and subsequently moves forward.

GROWTH AND METAMORPHOSIS

After hatching or birth an insect undergoes a process of growth and change until the adult condition is reached. The varied

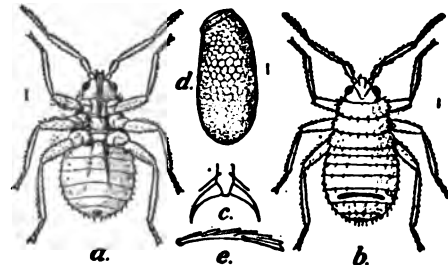

After Marshall, *Ent. Bull.* 4, n. 2. (U.S. Dept. Agr.).

FIG. 20.—a, Bed-bug (*Cimex lectularius*, Linn.); newly hatched young from beneath; b, from above; d, egg, magnified; c, foot with claws; e, serrate spine, more highly magnified.

details of this post-embryonic development furnish some of the most interesting facts and problems to the students of the Hexapoda. Wingless insects, such as spring-tails and lice, make their appearance in the form of miniature adults. Some winged insects—cockroaches, bugs (fig. 20) and earwigs, for example—when young closely resemble their parents, except for the absence of wings. On the other hand, we find in the vast majority of the Hexapoda a very marked difference between the perfect insect (imago) and the young animal when newly hatched and for some time after hatching. From the moth's egg comes a crawling caterpillar (fig. 21, c), from the fly's a legless maggot (fig. 25, a).

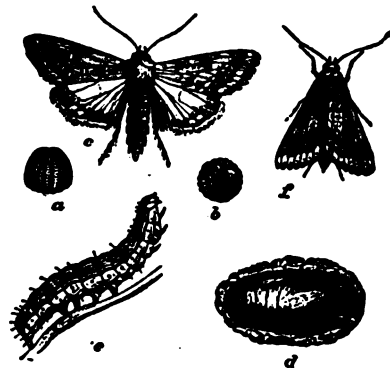

From Mally, *Ent. Bull.* 24 (U.S. Dept. Agr.).

FIG. 21.—a, b, Owl moth (*Heliothis armigera*); a, b, egg, highly magnified; c, larva or caterpillar; d, pupa in earthen cell.

Such a young insect is a *larva*—a term used by zoologists for young animals generally that are decidedly unlike their parents. It is obvious that the hatching of the young as a larva necessitates

a more or less profound transformation or metamorphosis before the perfect state is attained. Usually this transformation comes with apparent suddenness, at the penultimate stage of the insect's life-history, when the passive pupa (fig. 21, *d*) is revealed, exhibiting the wings and other imaginal structures, which have been developed unseen beneath the cuticle of the larva. Hexapoda with this resting pupal stage in their life-history are said to undergo "a complete transformation," to be metabolic, or holometabolic, whereas those insects in which the young form resembles the parent are said to be ametabolic. Such insects as dragon-flies and may-flies, whose young, though unlike the parent, develop into the adult form without a resting pupal stage are said to undergo an "incomplete transformation" or to be hemimetabolic. The absence of the pupal stage depends upon the fact that in the ametabolic and hemimetabolic Hexapoda the wing-rudiments appear as lateral outgrowths (fig. 22) of the two hinder thoracic segments and are visible externally throughout the life-history, becoming larger after each moult or casting of the cuticle. Hence, as has been pointed out by D. Sharp (1898), the marked divergence among the Hexapoda, as regards life-history, is between insects whose wings develop outside the cuticle (Exopterygota) and those whose wings develop inside the cuticle (Endopterygota), becoming visible only when the casting of the last larval cuticle reveals the pupa. Metamorphosis among the Hexapoda depends upon the universal acquisition of wings

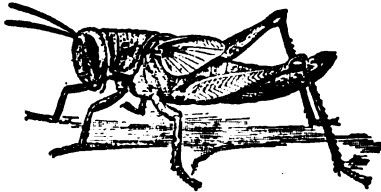

After Howard, *Insect Life*, vol. vii.

FIG. 22.—Nymph of Locust (*Schistocerca americana*), showing wing-rudiments.

during post-embryonic development—no insect being hatched with the smallest external rudiments of those organs—and on the necessity for successive castings or "moult" ("ecdyses") of the cuticle.

Ecdysis.—The embryonic ectoderm of an insect consists of a layer of cells forming a continuous structure, the orifices in—mouth, spiracles, anus and terminal portions of the genital ducts—being invaginations of the outer wall. This cellular layer is called the hypodermis; it is protected externally by a cuticle, a layer of matter it itself excretes, or in the excretion of which it plays, at any rate, an important part. The cuticle is a dead substance, and is composed in large part of chitin. The cuticle contrasts strongly in its nature with the hypodermis it protects. It is different in its details in different insects and in different stages of the life of the same insect. The "sclerites" that make up the skeleton of the insect (which skeleton, it should be remembered, is entirely external) are composed of this chitinous excretion. The growth of an insect is usually rapid, and as the cuticle does not share therein, it is from time to time cast off by moulting or ecdysis. Before a moult actually occurs the cuticle becomes separated from its connexion with the underlying hypodermis. Concomitant with this separation there is commencement of the formation of a new cuticle within the old one, so that when the latter is cast off the insect appears with a partly completed new cuticle. The new instar—or temporary form—is often very different from the old one, and this is the essential fact of metamorphosis. Metamorphosis is, from this point of view, the sum of the changes that take place under the cuticle of an insect between the ecdyses, which changes only become externally displayed when the cuticle is cast off. The hypodermis is the immediate agent in effecting the external changes.

The study of the physiology of ecdysis in its simpler forms has unfortunately been somewhat neglected, investigators having directed their attention chiefly to the cases that are most striking, such as the transformation of a maggot into a fly, or of a caterpillar into a butterfly. The changes have been found to be made up of two sets of processes: histolysis, by which the whole or part of a structure disappears; and histogenesis, or the formation of the new structure. By histolysis certain parts of the hypodermis are destroyed, while other portions of it develop into the new structures. The hypodermis is composed of parts of two different kinds, viz. (1) the larger part of the hypodermis that exists in the maggot or caterpillar and is dissolved at the metamorphosis; (2) parts that remain comparatively quiescent previously, and that grow and develop when the other parts degenerate. These centres of renovation are called imaginal disks or folds. The adult caterpillar may be described as a creature the hypodermis of which is studded with buds that expand and form the butterfly, while the parts around them degenerate. In some insects (e.g. the maggots of the blowfly, *Calliphora vomitoria*) the imaginal disks are to all appearance completely separated from the hypodermis, with which they are, however, really organically connected by strings or pedicels. This connexion was not at first recognized and the true nature of imaginal disks was not at first perceived, even by Weismann, to whom their discovery in Diptera is due. In other insects the imaginal disks are less completely disconnected from the superficies of the larval hypodermis, and may indeed be merely patches thereof. The number of imaginal disks in an individual is large, upwards of sixty having been discovered to take part in the formation of the outer body of a fly. With regard to the internal organs, we need only say that transformation occurs in an essentially similar manner, by means of a development from centres distributed in the various organs. The imaginal disks for the outer wall of the body, some of them, at any rate, include mesodermal rudiments (from which the muscles are developed) as well as hypodermis. The imaginal disks make their appearance (that is, have been first detected) at very different epochs in the life; their absolute origin has been but little investigated. Pratt has traced them in the sheep-tick (*Melophagus*) to an early stage of the embryonic life.

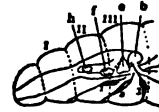

Adapted from Koenigsbeek and Bender, and Loew.

FIG. 23.—Diagram showing position of imaginal buds in larva of fly. I, II, III, the three thoracic segments of the larva; *f*, *2*, *3*, buds of the legs of the imago; *h*, bud of head-lobes; *f*, of by strings or pedicels. This connexion was not at first recognized and the true nature of imaginal disks was not at first perceived, even by Weismann, to whom their discovery in Diptera is due. In other insects the imaginal disks are less completely disconnected from the superficies of the larval hypodermis, and may indeed be merely patches thereof. The number of imaginal disks in an individual is large, upwards of sixty having been discovered to take part in the formation of the outer body of a fly. With regard to the internal organs, we need only say that transformation occurs in an essentially similar manner, by means of a development from centres distributed in the various organs. The imaginal disks for the outer wall of the body, some of them, at any rate, include mesodermal rudiments (from which the muscles are developed) as well as hypodermis. The imaginal disks make their appearance (that is, have been first detected) at very different epochs in the life; their absolute origin has been but little investigated. Pratt has traced them in the sheep-tick (*Melophagus*) to an early stage of the embryonic life.

Histolysis and Histogenesis.—The process of destruction of the larval tissues was first studied in the forms where metamorphosis is larval and most abrupt, viz. in the Muscicid Diptera. It was found that the tissues were attacked by phagocytic cells that became enlarged and carried away fragments of the tissue; the cells were subsequently identified as leucocytes or blood-cells. Hence the opinion arose that histolysis is a process of phagocytosis. It has, however, since been found that in other kinds of insects the tissues degenerate and break down without the intervention of phagocytes. It has, moreover, been noticed that even in cases where phagocytosis exists a greater or less extent of degeneration of the tissue may be observed before phagocytosis occurs. This process can therefore only be looked on as a secondary one that hastens and perfects the destruction necessary to permit of the accompanying histogenesis. This view is confirmed by the fate of the phagocytic cells. These do not take a direct part in the formation of the new tissue, but it is believed merely yield their surplus acquisitions, becoming ordinary blood-cells or disappearing altogether. As to the nature of histogenesis, nothing more can be said than that it appears to be a phenomenon similar to embryonic growth, though limited to certain spots. Hence we are inclined to look on the imaginal disks as cellular areas that possess in a latent condition the powers of growth and development that exist in the embryo, powers that only become evident in certain special conditions of the organism. What the more essential of these conditions may be is a question on which very little light has been thrown, though it has been widely discussed.

Much consideration has been given to the nature of metamorphosis in insects, to its value to the creatures and to the mode of its origin. Insect metamorphosis may be briefly described as phenomena of development characterized by abrupt changes of appearance and of structure, occurring during the period subsequent to embryonic development and antecedent to the reproductive state. It is, in short, a peculiar mode of growth and adolescence. The differences in appearance between the caterpillar and the butterfly, striking as they are to the eye, do not sufficiently represent the phenomena of metamorphosis to the intelligence. The changes that take place involve a revolution in the being, and may be summarized under three headings: (1) The food-relations of the individual are profoundly changed, an entirely different set of mouth-organs appears and the kind and

quantity of the food taken is often radically different. (2) A wingless, sedentary creature is turned into a winged one with superlative powers of aerial movement. (3) An individual in which the reproductive organs and powers are functionally absent becomes one in which these structures and powers are the only reason for existence, for the great majority of insects die after a brief period of reproduction. These changes are in the higher insects so extreme that it is difficult to imagine how they could be increased. In the case of the common drone-fly, *Eristalis tenax*, the individual, from a sedentary maggot living in filth, without any relations of sex, and with only unimportant organs for the ingestion of its foul nutriment, changes to a creature of extreme alertness, with magnificent powers of flight, living on the products of the flowers it frequents, and endowed with highly complex sexual structures.

Forms of Larva.—The unlikeness of the young insect to its parent is one of the factors that necessitates metamorphosis.

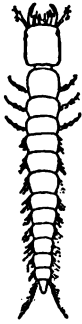

After Westwood, *Modern Classification*.
FIG. 24.—Campodeiform Larva of a Ground-Beetle (*Aepus marinus*).

It is instructive, further, to trace among metabolic insects an increase in the degree of this dissimilarity. An adult Hexapod is provided with a firm, well-chitinized cuticle and six conspicuous jointed legs. Many larval Hexapods might be defined in similar general terms, unlike as they are to their parents in most points of detail. Examples of such are to be seen in the grubs of may-flies, dragon-flies, lacewing-flies and ground-beetles (fig. 24). This type of active, armoured larva—often bearing conspicuous feelers on the head and long jointed cercopods on the tenth abdominal segment—was styled *campodeiform* by F. Brauer (1869), on account of its likeness in shape to the bristle-tail *Campodea*.

As an extreme contrast to this campodeiform type, we take the maggot of the house-fly (fig. 25)—a vermiform larva, with soft, white, feebly-chitinized cuticle and without either head-capsule or legs. Between these two extremes, numerous intermediate forms can be traced: the grub (wireworm) of a click-beetle, with narrow elongate well-armoured body, but with the legs very short; the grub of a chafer, with the legs fairly developed, but with the cuticle of all the trunk-segments soft and feebly chitinized; the well-known caterpillar of a moth (fig. 21, e) or saw-fly, with its long cylindrical body, bearing the six shortened thoracic legs and a variable number of pairs of "pro-legs" on the abdomen (this being the eruciform type of larva); the soft, white, wood-

among which the larva finds itself after hatching; the active, armoured grub has to seek food for itself and to fight its own battles, while the soft, defenceless maggot is provided with abundant nourishment. But in general we find that elaboration of imaginal structure is associated with degradation in the nature of the larva, eruciform and vermiform larvae being characteristic of the highest orders of the Hexapoda, so that unlikeness between parent and offspring has increased with the evolution of the class.

Hypermetamorphosis.—Among a few of the beetles or Coleoptera (*q.v.*), and also in the neuropterous genus *Mastispa*, are found life-histories in which the earliest instar is campodeiform and the succeeding larval stages eruciform. These later stages, comprising the greater part of the larval history, are adapted for an inquiline or a parasitic life, where shelter is assured and food abundant, while the short-lived, active condition enables the newly-hatched insect to make its way to the spot favourable for its future development, clinging, for example, in the case of an oil-beetle's larva, to the hairs of a bee as she flies towards her nest. The presence of the two successive larval forms in the life-history constitutes what is called hypermetamorphosis. Most significant is the precedence of the eruciform by the campodeiform type. In conjunction with the association mentioned above of the most highly developed imaginal with the most degraded larval structure, it indicates clearly that the active, armoured grub preceded the sluggish soft-skinned caterpillar or maggot in the evolution of the Hexapoda.

Nymph.—The term nymph is applied by many writers on the Hexapoda to all young forms of insects that are not sufficiently unlike their parents to be called larvae. Other writers apply the term to a "free" pupa (see *infra*). It is in well-nigh universal use for those instars of ametabolous and hemimetabolous insects in which the external wing-rudiments have become conspicuous (fig. 27). The mature dragon-fly nymph, for example, makes its way out of the water in which the early stages have been passed and, clinging to some water-plant, undergoes the final ecdysis that the imago may emerge into the air. Like most ametabolous and hemimetabolous Hexapoda, such nymphs continue to move and feed throughout their lives. But examples are not wanting of a more or less complete resting habit during the latest nymphal instar. In some cicadas the mature nymph ceases to feed and remains quiescent within a pillar-shaped earthen chamber. The nymph of a thrips-insect (*Thysanoptera*) is sluggish, its legs and wings being sheathed by a delicate membrane, while the nymph of the male scale-insect rests enclosed beneath a waxy covering.

Sub-imago.—Among the Hexapoda generally there is no subsequent ecdysis nor any further growth after the assumption of the winged state. The may-flies, however, offer a remarkable exception to this rule. After a prolonged aquatic larval and nymphal life-history, the winged insect appears as a sub-imago, whence, after the casting of a delicate cuticle, the true imago emerges.

Pupa.—In the metabolic Hexapoda the resting pupal instar shows externally the wings and other characteristic imaginal organs which have been gradually elaborated beneath the larval cuticle. It is usual to distinguish between the free pupae (fig. 26, b) of Coleoptera and Hymenoptera, for example—in which the wings, legs and other appendages are not fixed to the trunk, and the obtect pupae (fig. 21, d)—such as may be noticed in the majority of the Lepidoptera—whose appendages are closely and immovably pressed to the body by a general hardening and fusion of the cuticle. In the degree of mobility there is great diversity among pupae. A gnat pupa swims through the water by powerful strokes of its abdomen, while the caddis-fly pupa, in preparation for its final ecdysis, bites its way out of its subaqueous protective case and rises through the water, so that the fly may emerge into the air. Some pupae are thus more active than some nymphs; the essential character of a pupa is not therefore its passivity, but that it is the instar in which the wings first become evident externally.

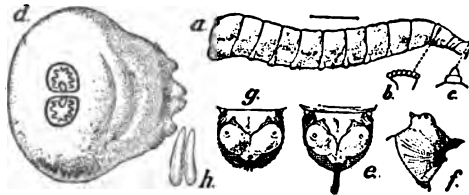

After Howard, *Ent. Bull.* 4, n. 2. (U.S. Dept. Agr.).

FIG. 25.—Vermiform Larva (maggot) of House-fly (*Musca domestica*). Magnified: b, spiracle on prothorax; c, protruded head region; d, tail-end with functional spiracles; e, f, head region with mouth hooks protruded; g, hooks retracted; h, eggs. All magnified.

boring grub of a longhorn-beetle or of the saw-fly *Sirex*, with its stumpy vestiges of thoracic legs; the large-headed but entirely legless, fleshy grub of a weevil; and the legless larva, with greatly reduced head, of a bee. The various larvae of the above series, however, have all a distinct head-capsule, which is altogether wanting in the degraded fly maggot. These differences in larval form depend in part on the surroundings

The division of the winged Hexapoda into Eopteryga and Endopteryga is thus again justified.

If we admit that the larva has, in the phylogeny of insects, gradually diverged from the imago, and if we recollect that in the ontogeny the larva has always to become the imago (and of course still does so) notwithstanding the increased difficulty of the transformation, we cannot but recognize that a period of helplessness in which the transformation may take place is to be expected. It is generally considered that this is sufficient as an explanation of the existence of the pupa. This, however, is not the case, because the greater part of the transformation precedes the disclosure of the pupa, which, as L. C. Miall remarks, is structurally little other "than the fly enclosed in a temporary skin." Moreover, in many insects with imperfect metamorphosis the change from larva or (as the later stage of the larva is called in these cases) nymph to imago is about as great as the corresponding change in the Holometabola, as the student will recognize if he recalls the histories of *Ephemeroidea*, Odonata and male *Coccidae*. But in none of these latter cases have the wings to be changed from a position inside the body to become external and actively functional organs. The difference between the nymph or false pupa and the true pupa is that in the latter a whole stage is devoted to the perfecting of the wings and body-wall after the wings have become external organs; the stage is one in which no food is or can be taken, however prolonged may be its existence. Amongst insects with imperfect metamorphosis the nearest approximations to the true pupa of the Holometabola are to be found in the subimago



From Chittenden, Bull. 4 (n.s.) Div. Ent. U.S. Dept. Agr.
FIG. 26.—a, Saw-toothed Grain-Beele (*Silonotus surinamensis*); b, pupa; c, larva, magnified—; d, feeler of larva.

of *Ephemeroidea* and in the quiescent or resting stages of Thysanoptera, *Aleuroidea* and *Coccidae*. A much more thorough appreciation than we yet possess of the phenomena in these cases is necessary in order completely to demonstrate the special characteristics of the holometabolous transformation. But even at present we can correctly state that the true pupa is invariably connected with the transference of the wings from the interior to the exterior of the body. It cannot but suggest itself that this transference was induced by some peculiarity as to formation of cuticle, causing the growth of the wings to be directed inwards instead of outwards. We may remark that fleas possess no wings, but are understood to possess a true pupa. This is a most remarkable case, but unfortunately very little information exists as to the details of metamorphosis in this group.

Life-Relations.—Only a brief reference can be made here to the fascinating subject of the life-relations of the larva, nymph and pupa, as compared with those of the imago. For details, the reader may consult the special articles on the various orders and groups of insects. A common result of metamorphosis is that the larva and imago differ markedly in their habitat and mode of feeding. The larva may be aquatic, or subterranean, or a burrower in wood, while the imago is aerial. It may bite and devour solid food, while the imago sucks liquids. It may eat roots or refuse, while the imago lives on leaves and flowers. The aquatic habit of many larvae is associated with endless beautiful adaptations for respiration. The series of paired spiracles on most of the trunk-segments is well displayed, as a rule, in terrestrial larvae—caterpillars and the grubs of most beetles, for example. In many aquatic larvae we find that all the spiracles are closed up, or become functionless, except a pair at the hinder end which are associated with some arrangement—such as the valvular flaps of the gnat larva or the telescopic "tail" of the drone-fly larva—for piercing the surface film and drawing periodical supplies of atmospheric air. A similar restriction of the functional spiracles to the tail-end

(fig. 25, d) is seen in many larvae of flies (Diptera) that live and feed buried in carrion or excrement. Other aquatic larvae have the tracheal system entirely closed, and are able to breathe dissolved air by means of tubular or leaf-like gills. Such are the grubs of stone-flies, may-flies (fig. 27) and some dragon-flies and midges. An interesting feature is the difference often to be observed between an aquatic larva and pupa of the same insect in the matter of breathing. The gnat larva, for example, breathes at the tail-end, hanging head-downwards from the surface-film. But the pupa hangs from the surface by means of paired respiratory trumpets on the prothorax, the dorsal thoracic surface, where the cuticle splits to allow the emergence of the fly, being thus directed towards the upper air.

A marked disproportion between the life-term of larva and imago is common; the former often lives for months or years, while the latter only survives for weeks or days or hours. Generally the larval is the feeding, the imaginal the breeding, stage of the life-cycle. The extreme of this "division of labour" is seen in those insects whose jaws are vestigial in the winged state, when the need for feeding all behind them, they have but to pair, to lay eggs and to die. The acquisition of wings is the sign of developed reproductive power.

Paedogenesis.—Nevertheless, the function of reproduction is occasionally exercised by larvae. In 1865 N. Wagner made his classical observations on the production of larvae from unfertilized eggs developed in the precociously-nursed. (The feelers formed ovaries of a larval gall-midge (Cecidomyid), and subsequent observers have confirmed his results by studies on insects of the same family and of the related *Chironomidae*. The larvae produced by this remarkable method (paedogenesis) of virgin-reproduction are hatched within the parent larva, and in some cases escape by the rupture of its body.

Polyembryony.—Occasionally the power of reproduction is thrown still farther back in the life-history, and it is found that from a single egg a large number of embryos may be formed. P. Marchal has (1904) described this power in two small parasitic Hymenoptera—a Chalcid (*Encyrtus*) which lays eggs in the developing eggs of the small moth *Hyponomeuta*, and a Proctotrypid (*Polygnotus*) which infests a gall-midge (Cecidomyid) larva. In the egg of these insects a small number of nuclei are formed by the division of the nucleus, and each of these nuclei originates by division the cell-layers of a separate embryo. Thus a mass or chain of embryos is produced, lying in a common cyst, and developing as their larval host develops. In this way over a hundred embryos may result from a single egg. Marchal points out the analogy of this phenomenon to the artificial polyembryony that has been induced in Echinoderm and other eggs by separating the blastomeres, and suggests that the abundant food-supply afforded by the host-larva is favourable for this multiplication of embryos, which may be, in the first instance, incited by the abnormal osmotic pressure on the egg.

Duration of Life.—The flour-moth (*Ephesia kuehniella*) sometimes passes through five or six generations in a single year. Although one of the characteristics of insects is the brevity of their adult lives, a considerable number of exceptions to the general rule have been discovered. These exceptions may be briefly summarized as follows: (1) Certain larvae, provided with food that may be adequate in quantity but deficient in nutriment, may live and go on feeding for many



From Miall and Denay (after Veyrier), *The Coccinella*, Lovell Reave & Co.

FIG. 27.—Nymph of May-fly (*Chloean dip-terum*), with wing rudiments (a) and tracheal gill-plates (b, b). Mag-eggs developed in the precociously-nursed.— (The feelers formed ovaries of a larval gall-midge and legs are cut short.)

years; (2) certain stages of the life that are naturally "resting stages" may be in exceptional cases prolonged, and that to a very great extent; in this case no food is taken, and the activity of the individual is almost nil, (3) the life of certain insects in the adult state may be much prolonged if celibacy be maintained; a female of *Cybister roeselii* (a large water-beetle) has lived five and a half years in the adult state in captivity. In addition to these abnormal cases, the life of certain insects is naturally more prolonged than usual. The females of some social insects have been known to live for many years. In *Tibicen septemdecim* the life of the larva extends over from thirteen to seventeen years. The eggs of locusts may remain for years in the ground before hatching; and there may thus arise the peculiar phenomenon of some species of insect appearing in vast numbers in a locality where it has not been seen for several years.

CLASSIFICATION

Number of Species.—It is now considered that 2,000,000 is a moderate estimate of the species of insects actually existing. Some authorities consider this total to be too small, and extend the number to 10,000,000. Upwards of 300,000 species have been collected and described, and at present the number of named forms increases at the rate of about 8000 species per annum. The greater part by far of the insects existing in the world is still quite unknown to science. Many of the species are in process of extinction, owing to the extensive changes that are taking place in the natural conditions of the world by the extension of human population and of cultivation, and by the destruction of forests; hence it is probable that a considerable proportion of the species at present existing will disappear from the face of the earth before we have discovered or preserved any specimens of them. Nevertheless, the constant increase of our knowledge of insect forms renders classification increasingly difficult, for gaps in the series become filled, and while the number of genera and families increases, the distinctions between these groups become dependent on characters that must seem trivial to the naturalist who is not a specialist.

Orders of Hexapoda.—In the present article it is only possible to treat of the division of the Hexapoda into orders and sub-orders and of the relations of these orders to each other. For further classificatory details, reference must be made to the special articles on the various orders. As regards the vast majority of insects, the orders proposed by Linnaeus are acknowledged by modern zoologists. His classification was founded mainly on the nature of the wings, and five of his orders—the Hymenoptera (bees, ants, wasps, &c.), Coleoptera (beetles), Diptera (two-winged flies), Lepidoptera (moths and butterflies), and Hemiptera (bugs, cicads, &c.)—are recognized to-day with nearly the same limits as he laid down. His order of wingless insects (Aptera) included Crustacea, spiders, centipedes and other creatures that now form classes of the Arthropoda distinct from the Hexapoda; it also included Hexapoda of parasitic and evidently degraded structure, that are now regarded as allied more or less closely to various winged insects. Consequently the modern order Aptera comprises only a very small proportion of Linnaeus's "Aptera"—the spring-tails and bristle-tails, wingless Hexapoda that stand evidently at a lower grade of development than the bulk of the class. The earwigs, cockroaches and locusts, which Linnaeus included among the Coleoptera, were early grouped into a distinct order, the Orthoptera. The great advance in modern zoology as regards the classification of the Hexapoda lies in the treatment of a heterogeneous assembly which formed Linnaeus's order Neuroptera. The characters of the wings are doubtless important as indications of relationship, but the nature of the jaws and the course of the life-history must be considered of greater value. Linnaeus's Neuroptera exhibit great diversity in these respects, and the insects included in it are now therefore distributed into a number of distinct orders. The many different arrangements that have been proposed can hardly be referred to in this article. Of special importance in the history of systematic entomology was the scheme of F. Brauer (1885), who separated the spring-

tails and bristle-tails as a sub-class Apterygogenia from all the other Hexapoda, these forming the sub-class Pterygogenia distributed into sixteen orders. Brauer in his arrangement of these orders laid special stress on the nature of the metamorphosis, and was the first to draw attention to the number of Malpighian tubes as of importance in classification. Subsequent writers have, for the most part, increased the number of recognized orders; and during the last few years several schemes of classification have been published, in the most revolutionary of which—that of A. Handlirsch (1903-1904)—the Hexapoda are divided into four classes and thirty-four orders! Such excessive multiplication of the larger taxonomic divisions shows an imperfect sense of proportion, for if the term "class" be allowed its usual zoological value, no student can fail to recognize that the Hexapoda form a single well-defined class, from which few entomologists would wish to exclude even the Apterygogenia. In several recent attempts to group the orders into sub-classes, stress has been laid upon a few characters in the imago. C. Börner (1904), for example, considers the presence or absence of cerci of great importance, while F. Klapalek (1904) lays stress on a supposed distinction between appendicular and non-appendicular genital processes. A natural system must take into account the nature of the larva and of the metamorphosis in conjunction with the general characters of the imago. Hence the grouping of the orders of winged Hexapoda into the divisions Exopterygota and Endopterygota, as suggested by D. Sharp, is unlikely to be superseded by the result of any researches into minute imaginal structure. Sharp's proposed association of the parasitic wingless insects in a group Anapterygota cannot, however, be defended as natural; and recent researches into the structure of these forms enables us to associate them confidently with related winged orders. The classification here adopted is based on Sharp's scheme, with the addition of suggestions from some of the most recent authors—especially Börner and Enderlein.

Class: HEXAPODA.

Sub-class: APTERYGOTA.

Primitively (?) wingless Hexapoda with cumacean mandibles, distinct maxillulae, and locomotor abdominal appendages. Without ectodermal genital ducts. Young closely resemble adults.

The sub-class contains a single

Order: Aptera,

which is divided into two sub-orders:—

1. *Thysanura* (Bristle-tails): with ten abdominal segments; number of abdominal appendages variable. Cerci prominent. Developed tracheal system.

2. *Collembola* (Spring-tails): with six abdominal segments; appendages of the first, forming an adherent ventral tube, those of the third a minute "catch," those of the fourth (fused basally) a "spring." Tracheal system reduced or absent.

Sub-class: EXOPTERYGOTA.

Hexapoda mostly with wings, the wingless forms clearly degraded. Maxillulae rarely distinct. No locomotor abdominal appendages. The wing-rudiments develop visibly outside the cuticle. Young like or unlike parents.

Order: Dermaptera.

Biting mandibles; minute but distinct maxillulae; second maxillulae incompletely fused. When wings are present, the fore-wings are small firm elytra, beneath which the delicate hind-wings are completely folded. Many forms wingless. Genital ducts entirely mesodermal. Cerci always present; usually modified into unjointed forceps. Numerous (30 or more) Malpighian tubes. Young resembling parents.

Includes two families—the *Forficulidae* or earwigs (*g.v.*) and the *Hemimeridae*.

Order: Orthoptera.

Biting mandibles; vestigial maxillulae; second maxillulae incompletely fused. Wings usually well developed, net-veined; the fore-wings of firmer texture than the hind-wings, whose anal area folds fanwise beneath them. Jointed cerci always present; ovipositor well developed. Malpighian tubes numerous (100-150). Young resemble parents.

Includes stick and leaf insects, cockroaches, mantids, grasshoppers, locusts and crickets (see ORTHOPTERA).

Order: Plecoptera.

Biting mandibles; second maxillulae incompletely fused. Fore-wings similar in texture to hind-wings, whose anal area folds fanwise. Jointed, often elongate, cerci. Numerous (50-60) Malpighian tubes.

Young resembling parents, but aquatic in habit, breathing dissolved air by thoracic tracheal gills
Includes the single family of the *Perididae* (Stone-flies), formerly grouped with the Neuroptera.

Order: *Isoptera*.

Biting mandibles; second maxillae incompletely fused. Fore-wings similar in shape and texture to hind-wings, which do not fold. In most species the majority of individuals are wingless. Short, jointed cerci. Six or eight Malpighian tubae. Young resembling adults; terrestrial throughout life.

Includes two families, formerly reckoned among the Neuroptera—the *Embiidae* and the *Termitidae* or "White Ants" (see TERMITES).

Order: *Corrodentia*.

Biting mandibles; second maxillae incompletely fused; maxillulae often distinct. Cerci absent. Four Malpighian tubae.

Includes two sub-orders, formerly regarded as Neuroptera:—
1. *Cepsognatha*: Corrodentia with delicate cuticle. Wings usually developed; the fore-wings much larger than the hind-wings. One family, the *Psocidae* (Book-lice). These minute insects are found amongst old books and furniture.
2. *Mallophaga*: Parasitic wingless Corrodentia (Bird-lice).

Order: *Ephemeroptera*.

Jaws vestigial. Fore wings much larger than hind-wings. Elongate, jointed cerci. Genital ducts paired and entirely mesodermal. Malpighian tubae numerous (40). Aquatic larvae with distinct maxillulae, breathing dissolved air by abdominal tracheal gills. Penultimate instar a flying sub-imago. [Includes the single family of the *Ephemeridae* or may-flies. See also NEUROPTERA, in which this order was formerly comprised.]

Order: *Odonata*.

Biting mandibles. Wings of both pairs closely alike; firm and glassy in texture. Prominent, unjointed cerci, male with genital armature on second abdominal segment. Malpighian tubae numerous (50-60). Aquatic larvae with caudal leaf-gills or with rectal tracheal system.

Includes the three families of dragon-flies. Formerly comprised among the Neuroptera.

Order: *Thysanoptera*.

Piercing mandibles, retracted within the head-capsule. First maxillae also modified as piercers; maxillae of both pairs with distinct palps. Both pairs of wings similar, narrow and fringed. Four Malpighian tubae. Cerci absent. Ovipositor usually present. Young resembling parents, but penultimate instar passive and enclosed in a filmy pellicle.

Includes three families of Thrips (see THYSANOPTERA).

Order: *Hemiptera*.

Mandibles and first maxillae modified as piercers; second maxillae fused to form a jointed, grooved rostrum. Wings usually present. Four Malpighian tubae. Cerci absent. Ovipositor developed.

Includes two sub-orders:—
1. *Heteroptera*: Rostrum not in contact with haunches of fore-legs. Fore-wings partly coriaceous. Young resembling adults. Includes the bugs, terrestrial and aquatic.
2. *Homoptera*: Rostrum in contact with haunches of fore-legs. Fore-wings uniform in texture. Young often larvae. Penultimate instar passive in some cases.

Includes the cicada, aphids and scale-insects (see HEMIPTERA).

Order: *Anoplura*.

Piercing jaws modified and reduced, a tubular, protrusible sucking-trunk being developed; mouth with hooks. Wingless, parasitic form. Cerci absent. Four Malpighian tubae. Young resembling adults.

Includes the family of the Lice (*Pediculidae*), often reckoned as Hemiptera (g.s.). See also LOUSE.

Sub-class: ENDOPTERYGOTA.

Hexapoda mostly with wings; the wingless forms clearly degraded or modified. Maxillulae vestigial or absent. No locomotor abdominal appendages (except in certain larvae). Young animals always unlike parents, the wing-rudiments developing beneath the larval cuticle and only appearing in a penultimate pupal instar, which takes no food and is usually passive.

Order: *Neuroptera*.

Biting mandibles; second maxillae completely fused. Prothorax large and free. Membranous, net-veined wings, those of the two pairs closely alike. Six or eight Malpighian tubae. Cerci absent. Larva camodeiform, usually feeding by suction (exceptionally hypermetamorphic with subsequent eruciform instars). Pupa free.

Includes the alder-flies, ant-lions and lacewing-flies. See NEUROPTERA.

Order: *Coleoptera*.

Biting mandibles; second maxillae very intimately fused. Prothorax large and free. Fore-wings modified into firm elytra, beneath which the membranous hind-wings (when present) can be folded. Cerci absent. Four or six Malpighian tubae. Larva camodeiform or eruciform. Pupa free.

Includes the beetles and the parasitic *Stylopidae*, often regarded as a distinct order (*Strepsiptera*). (See COLLEOPTERA.)

Order: *Mecoptera*.

Biting mandibles; first maxillae elongate; second maxillae completely fused. Prothorax small. Two pairs of similar, membranous wings, with predominantly longitudinal neurulation. Six Malpighian tubae. Larva eruciform. Pupa free. Cerci present.

Includes the single family of *Panorpidae* (scorpion-flies), often comprised among the Neuroptera.

Order: *Trichoptera*.

Mandibles present in pupa, vestigial in imago; maxillae suctorial without specialization; first maxillae with lacinia, galea and palp. Prothorax small. Two pairs of membranous, hair-covered wings, with predominantly longitudinal neurulation. Larvae aquatic and eruciform. Pupa free. Six Malpighian tubae. Cerci absent.

Includes the caddis-flies. See NEUROPTERA, among which these insects were formerly comprised.

Order: *Lepidoptera*.

Mandibles absent in imago, very exceptionally present in pupa; first maxillae nearly always without laciniae and often without palps, or only with vestigial palps, their galeae elongated and grooved inwardly so as to form a sucking trunk. Prothorax small. Wings with predominantly longitudinal neurulation, covered with flattened scales. Fore-wings larger than hind-wings. Cerci absent. Four (rarely 6 or 8) Malpighian tubae. Larvae eruciform, with rarely more than five pairs of abdominal prolegs. Pupa free in the lowest families, in most cases incompletely or completely obtect.

Includes the moths and butterflies. See LEPIDOPTERA.

Order: *Diptera*.

Mandibles rarely present, adapted for piercing; first maxillae with palps; second maxillae forming with hypopharynx a suctorial proboscis. Prothorax small, intimately united to mesothorax. Fore-wings well developed; hind-wings reduced to stalked knobs ("halteres"). Cerci present but usually reduced. Four Malpighian tubae. Larvae eruciform without thoracic legs, or vermiform without head-capsule. Pupa incompletely obtect or free, and enclosed in the hardened cuticle of the last larval instar (puparium).

Includes the two-winged flies (see DIPTERA), which may be divided into two sub-orders:—

1. *Orthorrhapha*: Larva eruciform. Cuticle of pupa or puparium splitting longitudinally down the back, to allow escape of imago. Comprises the midges, gnats, crane-flies, gad-flies, &c.
2. *Cyclorrhapha*: Larva vermiform (no head-capsule). Puparium opening by an anterior "lid." Comprises the hover-flies, flesh-flies, bot-flies, &c.

Order: *Siphonoptera*.

Mandibles fused into a piercer; first maxillae developed as piercers; palps of both pairs of maxillae present; hypopharynx wanting. Prothorax large. Wings absent or vestigial. Larva eruciform, limbless.

Includes the fleas.

Order: *Hymenoptera*.

Biting mandibles; second maxillae incompletely or completely fused; often forming a suctorial proboscis. Prothorax small, and united to mesothorax. First abdominal segment united to mesothorax. Wings membranous, fore-wings larger than hind-wings. Ovipositor always well developed, and often modified into a sting. Numerous (20-150) Malpighian tubae (in rare cases, 6-12 only). Larva eruciform, with seven or eight pairs of abdominal prolegs, or entirely legless. Pupa free.

Includes two sub-orders:—
1. *Symphyla*: Abdomen not basally constricted. Larvae caterpillars with thoracic legs and abdominal prolegs.

2. *Apocrita*: Abdomen markedly constricted at second segment. Larvae legless grubs. Comprises gall-flies, ichneumon-flies, ants, wasps, bees. See HYMENOPTERA.

GEOLOGICAL HISTORY

The classification just given has been drawn up with reference to existing insects, but the great majority of the extinct forms that have been discovered can be referred with some confidence to the same orders, and in many cases to recent families. The Hexapoda, being aerial, terrestrial and fresh-water animals, are but occasionally preserved in stratified rocks, and our knowledge of extinct members of the class is therefore fragmentary, while the description, as insects, of various obscure fossils, which are perhaps not even Arthropods, has not tended to the advancement of this branch of zoology. Nevertheless, much progress has been made. Several Silurian fossils have been identified as insects, including a *Thysanuran* from North America, but upon these considerable doubt has been cast.

The Devonian rocks of Canada (New Brunswick) have yielded several fossils which are undoubtedly wings of Hexapods. These have been described by S. H. Scudder, and include gigantic forms related to the Ephemeroptera.

In the Carboniferous strata (Coal measures) remains of Hexapods become numerous and quite indisputable. Many European forms of this age have been described by C. Brongniart, and American by S. H. Scudder. The latter has established, for all the Palaeozoic insects, an order Palaeodictyoptera, there being a closer similarity between the fore-wings and the hind-wings than is to be seen in most living orders of Hexapoda, while affinities are shown to several of these orders—notably the Orthoptera, Ephemeroptera, Odonata and Hemiptera. It is probable that many of these Carboniferous insects might be referred to the Isoptera, while others would fall into the existing orders to which they are allied, with some modification of our present diagnoses. Of special interest are cockroach-like forms, with two pairs of similar membranous wings and a long ovipositor, and gigantic insects allied to the Odonata, that measured 2 ft. across the outspread wings. A remarkable fossil from the Scottish Coal-measures (*Lithomantis*) had apparently small wing-like structures on the prothorax, and in allied genera small veined outgrowths—like tracheal gills—occurred on the abdominal segments. To the Permian period belongs a remarkable genus *Eugereon*, that combines hemipteroid jaws with orthopteroid wing-neuration. With the dawn of the Mesozoic epoch we reach Hexapods that can be unhesitatingly referred to existing orders. From the Trias of Colorado, Scudder has described cockroaches intermediate between their Carboniferous precursors and their present-day descendants, while the existence of endopterygotid Hexapods is shown by the remains of Coleoptera of several families. In the Jurassic rocks are found Ephemeroptera and Odonata, as well as Hemiptera, referable to existing families, some representatives of which had already appeared in the oldest of the Jurassic ages—the Lias. To the Lias also can be traced back the Neuroptera, the Trichoptera, the orthorrhaphous Diptera and, according to the determination of certain obscure fossils, also the Hymenoptera (ants). The Lithographic stone of Kimmeridgian age, at Solenhofen in Bavaria, is especially rich in insect remains, cyclorrhaphous Diptera appearing here for the first time. In Tertiary times the higher Diptera, besides Lepidoptera and Hymenoptera, referable to existing families, become fairly abundant. Numerous fossil insects preserved in the amber of the Baltic Oligocene have been described by G. L. Mayr and others, while Scudder has studied the rich Oligocene faunas of Colorado (Florissant) and Wyoming (Green River). The Oeningen beds of Baden, of Miocene age, have also yielded an extensive insect fauna, described fifty years ago by O. Heer. Further details of the geological history of the Hexapoda will be found in the special articles on the various orders. Fragmentary as the records are, they show that the Exopterygota preceded the Endopterygota in the evolution of the class, and that among the Endopterygota those orders in which the greatest difference exists between imago and larva—the Lepidoptera, Diptera and Hymenoptera—were the latest to take their rise.

GEOGRAPHICAL DISTRIBUTION

The class Hexapoda has a world-wide range, and so have most of its component orders. The Aptera have perhaps the most extensive distribution of all animals, being found in Franz Josef Land and South Victoria Land, on the snows of Alpine glaciers, and in the depths of the most extensive caves. Most of the families and a large proportion of the genera of insects are exceedingly widespread, but a study of the genera and species in any of the more important families shows that faunas can be distinguished whose headquarters agree fairly with the regions that have been proposed to express the distribution of the higher vertebrates. Many insects, however, can readily extend their range, and a careful study of their distribution leads us to discriminate between faunas rather than definitely to map regions.

A large and dominant Holarctic fauna, with numerous subdivisions, ranges over the great northern continents, and is characterized by the abundance of certain families like the *Carabidae* and *Staphylinidae* among the Coleoptera and the *Tenthredinidae* among the Hymenoptera. The southern territory held by this fauna is invaded by genera and species distinctly tropical. Oriental types range far northwards into China and Japan. Ethiopian forms invade the Mediterranean area. Neotropical and distinctively Sonoran insects mingle with members of the Holarctic fauna across a wide "transition zone" in North America. "Wallace's line" dividing the Indo-Malayan and Austro-Malayan sub-regions is frequently transgressed in the range of Malayan insects. The Australian fauna is rich in characteristic and peculiar genera, and New Zealand, while possessing some remarkable insects of its own, lacks entirely several families with an almost world-wide range—for example, the *Notodontidae*, *Lasiocampidae*, and other families of Lepidoptera. Interesting relationships between the Ethiopian and Oriental, the Neotropical and West African, the Patagonian and New Zealand faunas suggest great changes in the distribution of land and water, and throw doubt on the doctrine of the permanence of continental areas and oceanic basins. Holarctic types reappear on the Andes and in South Africa, and even in New Zealand. The study of the Hexapoda of oceanic islands is full of interest. After the determination of a number of cosmopolitan insects that may well have been artificially introduced, there remains a large proportion of endemic species—sometimes referable to distinct genera—which suggest a high antiquity for the truly insular faunas.

RELATIONSHIPS AND PHYLOGENY

The Hexapoda form a very clearly defined class of the Arthropoda, and many recent writers have suggested that they must have arisen independently of other Arthropods from annelid worms, and that the Arthropoda must, therefore, be regarded as an "unnatural," polyphyletic assemblage. The cogent arguments against this view are set forth in the article on Arthropoda. A near relationship between the Apterygota and the Crustacea has been ably advocated by H. J. Hansen (1893). It is admitted on all hands that the Hexapoda are akin to the Chilopoda. Verhoeff has lately (1904) put forward the view that there are really six segments in the hexapodan thorax and twenty in the abdomen—the cerci belonging to the seventeenth abdominal segment thus showing a close agreement with the centipede *Scolopendra*. On the other hand, G. H. Carpenter (1899, 1902-1904) has lately endeavoured to show an exact numerical correspondence in segmentation between the Hexapoda, the Crustacea, the Arachnida, and the most primitive of the Diplopoda. On either view it may be believed that the Hexapoda arose with the allied classes from a primitive arthropod stock, while the relationships of the class are with the Crustacea, the Chilopoda and the Diplopoda, rather than with the Arachnida.

Nature of Primitive Hexapoda.—Two divergent views have been held as to the nature of the original hexapod stock. Some of those zoologists who look to *Peripatus*, or a similar worm-like form, as representing the direct ancestors of the Hexapoda have laid stress on a larva like the caterpillar of a moth or saw-fly as representing a primitive stage. On the other hand, the view of F. Müller and F. Brauer, that the Thysanura represent more nearly than any other existing insects the ancestors of the class, has been accepted by the great majority of students. And there can be little doubt that this belief is justified. The caterpillar, or the maggot, is a specialized larval form characteristic of the most highly developed orders, while the campodeiform larva is the starting-point for the more primitive insects. The occurrence in the hypermetamorphic Coleoptera (see *supra*) of a campodeiform preceding an eruciform stage in the life-history is most suggestive. Taken in connexion with the likeness of the young among the more generalized orders to the adults, it indicates clearly a thysanuroid starting-point for the evolution of the hexapod orders. And we must infer further that the specialization of the higher orders has been accompanied by an increase in

the extent of the metamorphosis—a very exceptional condition among animals generally, as has been ably pointed out by L. C. Miall (1895).

Origin of Wings.—The post-embryonic growth of Hexapods with or without metamorphosis is accompanied in most cases by the acquisition of wings. These organs, thus acquired during the lifetime of the individual, must have been in some way acquired during the evolution of the class. Many students of the group, following Brauer, have regarded the Apterygota as representing the original wingless progenitors of the Pterygota, and the many primitive characters shown by the former group lend support to this view. On the other hand, it has been argued that the presence of wings in a vast majority of the Hexapoda suggests their presence in the ancestors of the whole class. It is most unlikely that wings have been acquired independently by various orders of Hexapoda, and if we regard the Thysanura as the slightly modified representatives of a primitively wingless stock, we must postulate the acquisition of wings by some early offshoot of that stock, an offshoot whence the whole group of the Pterygota took its rise. How wings were acquired by these primitive Pterygota must remain for the present a subject for speculation. Insect wings are specialized outgrowths of certain thoracic segments, and are quite unrepresented in any other class of Arthropods. They are not, therefore, like the wings of birds, modified from some pre-existing structures (the fore-limbs) common to their phylum; they are new and peculiar structures. Comparison of the tracheated wings with the paired tracheated outgrowths on the abdominal segments of the aquatic copepodiform larva of may-flies (see fig. 27) led C. Gegenbaur to the brilliant suggestion that wings might be regarded as specialized and transformed gills. But a survey of the Hexapoda as a whole, and especially a comparative study of the tracheal system, can hardly leave room for doubt that this system is primitively adapted for atmospheric breathing, and that the presence of tracheal gills in larvae must be regarded as a special adaptation for temporary aquatic life. The origin of insect wings remains, therefore, a mystery, deepened by the difficulty of imagining any probable use for thoracic outgrowths, comparable to the wingrudiments of the Exopterygota, in the early stages of their evolution.

Origin of Metamorphosis.—In connexion with the question whether metamorphosis has been gradually acquired, we have to consider two aspects, viz. the bionomic nature of metamorphosis, and to what extent it existed in primitive insects. Bionomically, metamorphosis may be defined as the sum of adaptations that have gradually fitted the larva (caterpillar or maggot) for one kind of life, the fly for another. So that we may conclude that the factors of evolution would favour its development. With regard to its occurrence in primitive insects, our knowledge of the geological record is most imperfect, but so far as it goes it supports the conclusion that holometabolism (*i.e.* extreme metamorphosis) is a comparatively recent phenomenon of insect life. None of the groups of existing Endopterygota have been traced with certainty farther back than the Mesozoic epoch, and all the numerous Palaeozoic insect-fossils seem to belong to forms that possessed only imperfect metamorphosis. The only doubt arises from the existence of insect remains, referred to the order Coleoptera, in the Silesian Culm of Steinkunzendorf near Reichenbach. The oldest larva known, *Mormolucoides articulatus*, is from the New Red Sandstone of Connecticut; it belongs to the *Stalidae*, one of the lowest forms of Holometabola. It is now, in fact, generally admitted that metamorphosis has been acquired comparatively recently, and Scudder in his review of the earliest fossil insects states that "their metamorphoses were simple and incomplete, the young leaving the egg with the form of the parent, but without wings, the assumption of which required no quiescent stage before maturity."

It has been previously remarked that the phenomena of holometabolism are connected with the development of wings inside the body (except in the case of the fleas, where there are no wings in the perfect insect). Of existing insects 90% belong to the Endopterygota. At the same time we have no

evidence that any Endopterygota existed amongst Palaeozoic insects, so that the phenomena of endopterygotism are comparatively recent, and we are led to infer that the Endopterygota owe their origin to the older Exopterygota. In Endopterygota the wings commence their development as invaginations of the hypodermis, while in Exopterygota the wings begin—and always remain—as external folds or evaginations. The two modes of growth are directly opposed, and at first sight it appears that this fact negatives the view that Endopterygota have been derived from Exopterygota.

Only three hypotheses as to the origin of Endopterygota can be suggested as possible, viz.:—(1) That some of the Palaeozoic insects, though we infer them to have been exopterygotous, were really endopterygotous, and were the actual ancestors of the existing Endopterygota; (2) that Endopterygota are not descended from Exopterygota, but were derived directly from ancestors that were never winged; (3) that the predominant division—*i.e.* Endopterygota—of insects of the present epoch are descended from the predominant—if not the sole—group that existed in the Palaeozoic epoch, viz. the Exopterygota. The first hypothesis is not negated by direct evidence, for we do not actually know the ontogeny of any of the Palaeozoic insects; it is, however, rendered highly improbable by the modern views as to the nature and origin of wings in insects, and by the fact that the Endopterygota include none of the lower existing forms of insects. The second hypothesis—to the effect that Endopterygota are the descendants of apterous insects that had never possessed wings (*i.e.* the Apterygogenea of Brauer and others, though we prefer the shorter term Apterygota)—is rendered improbable from the fact that existing Apterygota are related to Exopterygota, not to Endopterygota, and by the knowledge that has been gained as to the morphology and development of wings, which suggest that—if we may so phrase it—were an apterygotous insect gradually to develop wings, it would be on the exopterygotous system. From all points of view it appears, therefore, probable that Endopterygota are descended from Exopterygota, and we are brought to the question as to the way in which this has occurred.

It is almost impossible to believe that any species of insect that has for a long period developed the wings outside the body could change this mode of growth suddenly for an internal mode of development of the organs in question, for, as we have already explained, the two modes of growth are directly opposed. The explanation has to be sought in another direction. Now there are many forms of Exopterygota in which the creatures are almost or quite destitute of wings. This phenomenon occurs among species found at high elevations, among others found in arid or desert regions, and in some cases in the female sex only, the male being winged and the female wingless. This last state is very frequent in *Blattidae*, which were amongst the most abundant of Palaeozoic insects. The wingless forms in question are always allied to winged forms, and there is every reason to believe that they have been really derived from winged forms. There are also insects (fleas, &c.) in which metamorphosis of a "complete" character exists, though the insects never develop wings. These cases render it highly probable that insects may in some circumstances become wingless, though their ancestors were winged. Such insects have been styled anapterygotous. In these facts we have one possible clue to the change from exopterygotism to endopterygotism, namely, by an intermediate period of anapterygotism.

Although we cannot yet define the conditions under which exopterygotous wings are suppressed or unusually developed, yet we know that such fluctuations occur. There are, in fact, existing forms of Exopterygota that are usually wingless, and that nevertheless appear in certain seasons or localities with wings. We are therefore entitled to assume that the suppressed wings of Exopterygota tend to reappear; and, speaking of the past, we may say that if after a period of suppression the wings began to reappear as hypodermal buds while a more rigid pressure was exerted by the cuticle, the growth of the buds would necessarily be inwards, and we should have incipient endopterygotism.

The change that is required to transform Exopterygota into Endopterygota is merely that a cell of hypodermis should proliferate inwards instead of outwards, or that a minute hypodermal evaginated bud should be forced to the interior of the body by the pressure of a contracted cuticle.

If it should be objected that the wings so developed would be rudimentary, and that there would be nothing to encourage their development into perfect functional organs, we may remind the reader that we have already pointed out that imperfect wings of Exopterygota do, even at the present time under certain conditions, become perfect organs; and we may also add that there are, even among existing Endopterygota, species in which the wings are usually vestiges and yet sometimes become perfectly developed. In fact, almost every condition that is required for the change from exopterygotism to endopterygotism exists among the insects that surround us.

But it may perhaps be considered improbable that organs like the wings, having once been lost, should have been re-acquired on the large scale suggested by the theory just put forward. If so, there is an alternative method by which the endopterygotous may have arisen from the exopterygotous condition. The sub-imago of the Ephemeroptera suggests that a moult, after the wings had become functional, was at one time general among the Hexapoda, and that the resting nymph of the Thysanoptera or the pupa of the Endopterygota represents a formerly active stage in the life-history. Further, although the wing-rudiments appear externally in an early instar of an exopterygotous insect, the earliest instars are wingless and wing-rudiments have been previously developing beneath the cuticle, growing however outwards, not inwards as in the larva of an endopterygote. The change from an exopterygote to an endopterygote development could, therefore, be brought about by the gradual postponement to a later and later instar of the appearance of the wing-rudiments outside the body, and their correlated growth inwards as imaginal disks. For in the post-embryonic development of the ancestors of the Endopterygota we may imagine two or three instars with wing-rudiments to have existed, the last represented by the sub-imago of the may-flies. As the life-conditions and feeding-habits of the larva and imago become constantly more divergent, the appearance of the wing-rudiments would be postponed to the pre-imaginal instar, and that instar would become predominantly passive.

Relationships of the Orders.—Reasons have been given for regarding the Thysanura as representing, more nearly than any other living group, the primitive stock of the Hexapoda. It is believed that insects of this group are represented among Silurian fossils. We may conclude, therefore, that they were preceded, in Cambrian times or earlier, by Arthropods possessing well developed appendages on all the trunk-segments. Of such Arthropods the living Symphyla—of which the delicate little *Scutigera* is a fairly well-known example—give us some representation.

No indications beyond those furnished by comparative anatomy help us to unravel the phylogeny of the Collembola. In most respects, the shortened abdomen, for example, they are more specialized than the Thysanura, and most of the features in which they appear to be simple, such as the absence of a tracheal system and of compound eyes, can be explained as the result of degradation. In their insunken mouth and their jaws retracted within the head-capule, the Collembola resemble the entotrophic division of the Thysanura (see *APTERA*), from which they are probably descended.

From the thysanuroid stock of the Apterygota, the Exopterygota took their rise. We have undoubted fossil evidence that winged insects lived in the Devonian and became numerous in the Carboniferous period. These ancient Exopterygota were synthetic in type, and included insects that may, with probability, be regarded as ancestral to most of the existing orders. It is hard to arrange the Exopterygota in a linear series, for some of the orders that are remarkably primitive in some respects are rather highly specialized in others. As regards wing-structure, the Isoptera with the two pairs closely

similar are the most primitive of all winged insects; while in the paired mesodermal genital ducts, the elongate cerci and the conspicuous maxillulae of their larvae the Ephemeroptera retain notable ancestral characters. But the vestigial jaws, numerous Malpighian tubes, and specialized wings of may-flies forbid us to consider the order as on the whole primitive. So the Dermaptera, which retain distinct maxillulae and have no ectodermal genital ducts, have either specialized or aborted wings and a large number of Malpighian tubes. The Corrodentia retain vestigial maxillulae and two pairs of Malpighian tubes, but the wings are somewhat specialized in the Copeognatha and absent in the degraded and parasitic Mallophaga. The Plecoptera and Orthoptera agree in their numerous Malpighian tubes and in the development of a folding anal area in the hind-wing. As shown by the number and variety of species, the Orthoptera are the most dominant order of this group. Eminently terrestrial in habit, the differentiation of their fore-wings and hind-wings can be traced from Carboniferous, isopteroïd ancestors through intermediate Mesozoic forms. The Plecoptera resemble the Ephemeroptera and Odonata in the aquatic habits of their larvae, and by the occasional presence of tufted thoracic gills in the imago exhibit an aquatic character unknown in any other winged insects. The Odonata are in many imaginal and larval characters highly specialized; yet they probably arose with the Ephemeroptera as a divergent offshoot of the same primitive isopteroïd stock which developed more directly into the living Isoptera, Plecoptera, Dermaptera and Orthoptera.

All these orders agree in the possession of biting mandibles, while their second maxillae have the inner and outer lobes usually distinct. The Hemiptera, with their piercing mandibles and first maxillae and with their second maxillae fused to form a jointed beak, stand far apart from them. This order can be traced with certainty back to the early Jurassic epoch, while the Permian fossil *Eugereon*, and the living order—specially modified in many respects—of the Thysanoptera indicate steps by which the aberrant suctorial and piercing mouth of the Hemiptera may have been developed from the biting mouth of primitive Isopteroïds, by the elongation of some parts and the suppression of others. The Anoplura may probably be regarded as a degraded offshoot of the Hemiptera.

The importance of great cardinal features of the life-history as indicative of relationship leads us to consider the Endopterygota as a natural assemblage of orders. The occurrence of weevils—among the most specialized of the Coleoptera—in Triassic rocks shows us that this great order of metabolous insects had become differentiated into its leading families at the dawn of the Mesozoic era, and that we must go far back into the Palaeozoic for the origin of the Endopterygota. In this view we are confirmed by the impossibility of deriving the Endopterygota from any living order of Exopterygota. We conclude, therefore, that the primitive stock of the former subclass became early differentiated from that of the latter. So widely have most of the higher orders of the Hexapoda now diverged from each other, that it is exceedingly difficult in most cases to trace their relationships with any confidence. The Neuroptera, with their similar fore- and hind-wings and their campodeiform larvae, seem to stand nearest to the presumed isopteroïd ancestry, but the imago and larva are often specialized. The campodeiform larvae of many Coleoptera are indeed far more primitive than the neuropteran larvae, and suggest to us that the Coleoptera—modified as their wing-structure has become—arose very early from the primitive metabolous stock. The antiquity of the Coleoptera is further shown by the great diversity of larval form and habit that has arisen in the order, and the proof afforded by the hypermetamorphic beetles that the campodeiform preceded the eruciform larva has already been emphasized.

In all the remaining orders of the Endopterygota the larva is eruciform or vermiform. The Mecoptera, with their predominantly longitudinal wing-nervuration, serve as a link between the Neuroptera and the Trichoptera, their retention of small cerci being an archaic character which stamps them as

synthetic in type, but does not necessarily remove them from orders which agree with them in most points of structure but which have lost the cerci. The standing of the Trichoptera in a position almost ancestral to the Lepidoptera is one of the assured results of recent morphological study, the mobile mandibulate pupa and the imperfectly suctorial maxillae of the Trichoptera reappearing in the lowest families of the Lepidoptera. This latter order, which is not certainly known to have existed before Tertiary times, has become the most highly specialized of all insects in the structure of the pupa. Diptera of the sub-order Orthorrhapha occur in the Lias and Cyclorrhapha in the Kimmeridgian. The order must therefore be ancient, and as no evidence is forthcoming as to the mode of reduction of the hind-wings, nor as to the stages by which the suctorial mouth-organs became specialized, it is difficult to trace the exact relationship of the group, but the presence of cerci and a degree of correspondence in the nervation of the forewings suggest the Mecoptera as possible allies. There seems no doubt that the suctorial mouth-organs of the Diptera have arisen quite independently from those of the Lepidoptera, for in the former order the sucker is formed from the second maxillae, in the latter from the first. The cruciform larva of the Orthorrhapha leads on to the headless vermiform maggot of the Cyclorrhapha, and in the latter sub-order we find metamorphosis carried to its extreme point, the muscid flies being the most highly specialized of all the Hexapoda as regards structure, while their maggots are the most degraded of all insect larvae. The Siphonaptera appear by the form of the larva and the nature of the metamorphosis to be akin to the Orthorrhapha—in which division they have indeed been included by many students. They differ from the Diptera, however, in the general presence of palps to both pairs of maxillae, and in the absence of a hypopharynx, so it is possible that their relationship to the Diptera is less close than has been supposed. The affinities of the Hymenoptera afford another problem of much difficulty. They differ from other Endopterygota in the multiplication of their Malpighian tubes, and from all other Hexapoda in the union of the first abdominal segment with the thorax. Specialized as they are in form, development and habit, they retain mandibles for biting, and in their lower sub-order—the Symphyta—the maxillae are hardly more modified than those of the Orthoptera. From the evidence of fossils it seems that the higher sub-order—Apo-crita—can be traced back to the Lias, so that we believe the Hymenoptera to be more ancient than the Diptera, and far more ancient than the Lepidoptera. They afford an example—paralleled in other classes of the animal kingdom—of an order which, though specialized in some respects, retains many primitive characters, and has won its way to dominance rather by perfection of behaviour, and specially by the development of family life and helpful socialism, than by excessive elaboration of structure. We would trace the Hymenoptera back therefore to the primitive endopterygote stock. The specialization of form in the constricted abdomen and in the suctorial "tongue" that characterizes the higher families of the order is correlated with the habit of careful egg-laying and provision of food for the young. In some way it is assured among the highest of the Hexapoda—the Lepidoptera, Diptera and Hymenoptera—that the larva finds itself amid a rich food-supply. And thus perfection of structure and instinct in the imago has been accompanied by degradation in the larva, and by an increase in the extent of transformation and in the degree of reconstruction before and during the pupal stage. The fascinating difficulties presented to the student by the metamorphosis of the Hexapoda are to some extent explained, as he ponders over the evolution of the class.

BIBLIOGRAPHY.—References to the older classical writings on the Hexapoda are given in the article on Entomology. At present about a thousand works and papers are published annually, and in this place it is possible to enumerate only a few of the most important among (mostly) recent memoirs that bear upon the Hexapoda generally. Further references will be found appended to the special articles on the orders (APTERA, COLLEPTERA, &c.).

General Works.—A. S. Packard, *Text-book of Entomology* (London, 1898); V. Graber, *Die Insekten* (Munich, 1877-1879); D. Sharp, *Cambridge Natural History*, vols. v, vi (London, 1895-1899); L. C. Miall and A. Denny, *Structure and Life-history of the Cockroach* (London, 1886); B. T. Lowne, *The Anatomy, Physiology, Morphology and Development of the Blow-fly* (2 vols., London, 1890-1895); G. H. Carpenter, *Insects: their Structure and Life* (London, 1899); L. F. Henneguy, *Les Insectes* (Paris, 1904); J. W. Folsom, *Entomology* (New York and London, 1906); A. Berlese, *Gli Insetti* (Milan, 1906), &c. (Extensive bibliographies will be found in several of the above.)

Head and Appendages.—J. C. Savigny, *Mémoires sur les animaux sans vertèbres* (Paris, 1816); C. Janet, *Essai sur la constitution morphologique de la tête de l'insecte* (Paris, 1899); J. H. Comstock and C. Kochi (*American Naturalist*, xxxvi, 1902); V. L. Kellogg (*ibid.*); W. A. Riley (*American Naturalist*, xxxviii, 1904); F. Meinert (*Entom. Tidsskr.*, i, 1880); H. J. Hansen (*Zool. Anz.*, xvi, 1893); J. B. Smith (*Trans. Amer. Phil. Soc.*, xix, 1896); H. Holmgren (*Zeitsch. wiss. Zool.*, lxxvi, 1904); K. W. Verhoeff (*Abhandl. K. Leop.-Carol. Akad.*, lxxxiv, 1905).

Thorax, Legs and Wings.—K. W. Verhoeff (*Abhandl. K. Leop.-Carol. Akad.*, lxxxii, 1903); F. Voss (*Zeits. wiss. Zool.*, lxxviii, 1905); F. Dahl (*Arch. J. Naturgesch.*, i, 1884); J. Demoor (*Arch. de biol.*, x, 1890); J. Redtenbacher (*Ann. Kais. naturhist. Museum, Wien*, i, 1886); R. von Lendenfeld (*S. B. Akad. Wissensch., Wien*, lxxviii, 1881); J. H. Comstock and J. G. Needham (*Amer. Nat.*, xxxii, xxxiii, 1898-1899); C. W. Woodworth (*Univ. California Zool. Bull.*, i, 1906).

Abdomen and Appendages.—E. Haase (*Morph. Jahrb.*, xv, 1880); R. Heymons (*Morph. Jahrb.*, xxxiv, 1896); *Abhandl. K. Leop.-Carol. Akad.*, lxxvii, 1899); K. W. Verhoeff (*Zool. Anz.*, xix, xx, 1896-1897); S. A. Peytoureau, *Contributions à l'étude de la morphologie de l'armure génitale des insectes* (Bordeaux, 1895); H. Dewitz (*Zeits. wiss. Zool.*, xxv, xxviii, 1874, 1877); E. Zander (*ibid.*, lxxvi, lxxvii, 1899-1900).

Nervous System.—H. Viallanes (*Ann. Sci. Nat. Zool.*, [6], xvii, xviii, xix, [7] ii, iv, 1884-1887); S. J. Hickson (*Quart. Journ. Microsc. Sci.*, xxv, 1885); W. Patten (*Journ. Morph.*, i, ii, 1887-1888); F. Plateau (*Mém. Acad. Belg.*, xliii, 1888); V. Graber (*Arch. mikr. Anat.*, xx, xxi, 1882).

Respiratory System.—J. A. Palmén, *Zur Morphologie des Tracheensystems* (Leipzig, 1877); F. Plateau (*Mém. Acad. Belg.*, xiv, 1884); L. C. Miall, *Natural History of Aquatic Insects* (London, 1895).

Digestive System, &c.—L. Dufour (*Ann. Sci. Nat.*, 1824-1860); V. Faussek (*Zeits. wiss. Zool.*, xiv, 1887).

Malpighian Tubes.—E. Schindler (*Zeits. wiss. Zool.*, xxx, 1878); W. M. Wheeler (*Psyche*, vi, 1893); L. Cufnot (*Arch. de biol.*, xiv, 1895).

Reproductive Organs.—H. V. Wielowiejaki (*Zool. Anz.*, ix, 1886); J. A. Palmén, *Über paarige Ausführungsgänge der Geschlechtsorgane bei Insekten* (Helsingfors, 1884); H. Henking (*Zeits. wiss. Zool.*, xix, ii, liv, 1890-1892); F. Leydig (*Zool. Jahrb. Anat.*, iii, 1889).

Embryology.—F. Blochmann (*Morph. Jahrb.*, xii, 1887); A. Kovalevsky (*Mém. Acad. St.-Petersbourg*, xvi, 1871; *Zeits. wiss. Zool.*, xiv, 1887); V. Graber (*Denksch. Akad. Wissensch., Wien*, lvi, 1880); K. Heider, *Die Embryonalentwicklung von Hydrophilus piceus* (Jena, 1889); W. M. Wheeler (*Journ. Morph.*, vii, 1889-1893); E. Korschelt and K. Heider, *Handbook of the Comparative Embryology of Invertebrates* (trans. M. Bernard), (vol. iii., London, 1899); R. Heymons, *Die Embryonalentwicklung von Dermapteren und Orthopteren* (Jena, 1895) (also *Zeits. wiss. Zool.*, liii, 1891, liii, 1897; *Anhang zu den Abhandl. K. Akad. d. Wissensch., Berlin*, 1896); A. Lécaillon (*Arch. Énat. micr.*, ii, 1898); J. Carrière and O. Burger (*Abhandl. K. Leop.-Carol. Akad.*, lxxix, 1897); K. Escherich (*ibid.*, lxxvii, 1901); F. Schwaninger (*Zeits. wiss. Zool.*, lxxvi, 1904); R. Ritter (*ib.*, li, 1890); E. Metchnikoff (*ib.*, xvi, 1866); H. Uzel (*Zool. Anz.*, xx, 1897); J. W. Folsom (*Bull. Mus. Comp. Zool. Harvard.*, xxxvi, 1900).

Parthenogenesis and Paedogenesis.—T. H. Huxley (*Trans. Linn. Soc.*, xxii, 1858); R. Leuckart, *Zur Kenntnis des Generationswechsels und der Parthogenese bei den Insekten* (Frankfurt, 1858); N. Wagner (*Zeits. wiss. Zool.*, xv, 1865); L. F. Henneguy (*Bull. Soc. Philomath.*, [9], i, 1899); A. Petrunkevich (*Zool. Jahrb. Anat.*, xiv, xvii, 1901-1903); P. Marchal (*Arch. zool. exp. et gén.*, [4], ii, 1904); L. Doncaster (*Quart. Journ. Microsc. Sci.*, xix, li, 1906-1907).

Growth and Metamorphosis.—A. Weismann (*Zeits. wiss. Zool.*, xiii, xiv, 1865-1864); F. Brauer (*Verh. zool.-bot. Gesellsch., Wien*, xix, 1869); Sir J. Lubbock (*Lord Avebury*), *Origin and Metamorphosis of Insects* (London, 1874); L. C. Miall (*Nature*, liii, 1895); L. C. Miall and A. R. Hammond, *Structure and Life-history of the Harlequin-fly* (Oxford, 1900); J. Gonin (*Bull. Soc. Vaudo. Sci. Nat.*, xxx, 1894); C. de Bruyne (*Arch. de biol.*, xi, (1898)); D. Sharp (*Proc. Inter. Zool. Congress*, 1898); E. B. Foulton (*Trans. Linn. Soc.*, v, 1891); T. A. Chapman (*Trans. Ent. Soc.*, 1893).

Classification.—F. Brauer (*S. B. Akad. Wiss., Wien*, xci, 1885); A. S. Packard (*Amer. Nat.*, xx, 1886); C. Börner, *A. Handlirach*; F. Klappalek (*Zool. Anz.*, xxvii, 1904); G. Enderlein (*Zool. Anz.*, xxvi, 1903).

Palaeontology.—S. H. Scudder, in *Zittel's Palaeontology* (French

trans., vol. ii., Paris, 1887, and Eng. trans., vol. i., London, 1900); C. Brongniart, *Insectes fossiles des temps primaires* (St. Étienne, 1894); A. Handlirsch, *Die fossilen Insekten und die Phylogenie der rezenten Formen* (Leipzig, 1906).
Phylogeny.—Brauer, Lubbock, Sharp, Börner, &c. (*opp. cit.*); P. Mayer *Jena, Zeits. Naturw.* x., 1876; B. Grassi (*Atti R. Accad. dei Lincei, Roma* [4], iv., 1888, and *Archiv ital. biol.* xi., 1889). F. Müller, *Facts and Arguments for Darwin* (trans. W. S. Dallas, London, 1869); N. Zograf (*Congr. Zool. Int.*, 1892); E. R. Lankester (*Quart. Journ. Micr. Sci.* xlvii., 1904); G. H. Carpenter (*Proc. R. Irish Acad.* xxiv., 1903; *Quart. Journ. Micr. Sci.* xlix., 1905) (D.S.; G.H.C.)

HEXASTYLE (Gr. ἕξ, six, and στήλη, column), an architectural term given to a temple in the portico of which there are six columns in front.

HEXATEUCH, the name given to the first six books of the Old Testament (the Pentateuch and Joshua), to mark the fact that these form one literary whole, describing the early traditional history of the Israelites from the creation of the world to the conquest of Palestine and the origin of their national institutions. These books are the result of an intricate literary process, on which see **BIBLE** (Old Testament: Canon), and the articles on the separate books (**GENESIS**, **EXODUS**, **LEVITICUS**, **NUMBERS**, **DEUTERONOMY** and **JOSHUA**).

HEXHAM, a market town in the Hexham parliamentary division of Northumberland, England, 21 m. W. from Newcastle by the Carlisle branch of the North-Eastern railway, served also from Scotland by a branch of the North British railway. Pop. of urban district (1901) 7107. It is pleasantly situated beneath the hills on the S. bank of the Tyne, and its market square and narrow streets bear many marks of antiquity. It is famous for its great abbey church of St Andrew. This building, as renovated in the 12th century, was to consist of nave and transepts, choir and aisles, and massive central tower. The Scots are believed to have destroyed the nave in 1296, but it may be doubted if it was ever completed. In 1536 the last prior was hanged for being concerned in the insurrection called the Pilgrimage of Grace. The church as it stands is a fine monument of Early English work, with Transitional details. Within, although it suffered much loss during a restoration c. 1858, there are several objects of interest. Among these are a Roman slab, carved with figures of a horseman trampling upon an enemy, several fine tombs and stones of the 13th and 14th centuries, the frith or fridstool of stone, believed to be the original bishop's throne, and the fine Perpendicular roodscreen of oak, retaining its loft. The crypt, discovered in 1726, is part of the Saxon church, and a noteworthy example of architecture of the period. Its material is Roman, some of the stones having Roman inscriptions. These were brought from the Roman settlement at Corbridge, 4 m. E. of Hexham on the N. bank of the Tyne; for Hexham itself was not a Roman station. In 1832 a vessel containing about 8000 Saxon coins was discovered in the churchyard. Fragments of the monastic buildings remain, and west of the churchyard is the monks' park, known as the Seal, and now a promenade, commanding beautiful views. In the town are two strong castellated towers of the 14th century, known as the Moot Hall and the Manor Office. Their names explain their use, but they were doubtless also intended as defensive works. In the interesting and beautiful neighbourhood of Hexham there should be noticed Aydon castle near Corbridge, a fortified house of the late 13th century; and Dilston or Dyvilston, a typical border fortress dating from Norman times, of which only a tower and small chapel remain. It is replete with memories of the last earl of Derwentwater, who was beheaded in 1716 for his part in the Stuart rising of the previous year, and was buried in the chapel. There is an Elizabethan grammar school. Hexham and Newcastle form a Roman Catholic bishopric, with the cathedral at Newcastle. There are manufactures of leather gloves and other goods, and in the neighbourhood barytes and coal mines and extensive market gardens.

The church and monastery at Hexham (Hextoldesham) were founded about 673 by Wilfrid, archbishop of York, who is said to have received a grant of the whole of Hexhamshire from Æthelþryth, queen of Northumbria, and a grant of sanctuary in his

church from the king. The church in 678 became the head of the new see of Bernicia, which was united to that of Lindisfarne about 821, when the bishop of Lindisfarne appears to have taken possession of the lordship which he and his successors held until it was restored to the archbishop of York by Henry II. The archbishops appear to have had almost royal power throughout the liberty, including the rights of trying all pleas of the crown in their court, of taking inquisitions and of taxation. In 1545 the archbishop exchanged Hexhamshire with the king for other property, and in 1572 all the separate privileges which had belonged to him were taken away, and the liberty was annexed to the county of Northumberland. Hexham was a borough by prescription, and governed by a bailiff at least as early as 1276, and the same form of government continued until 1853. In 1343 the men of Hexham were accused of pretending to be Scots and imprisoning many people of Northumberland and Cumberland, killing some and extorting ransoms for others. The Lancastrians were defeated in 1464 near Hexham, and legend says that it was in the woods round the town that Queen Margaret and her son hid until their escape to Flanders. In 1522 the bishop of Carlisle complained to Cardinal Wolsey, then archbishop of York, that the English thieves committed more thefts than "all the Scots of Scotland," the men of Hexham being worst of all, and appearing 100 strong at the markets held in Hexham, so that the men whom they had robbed dared not complain or "say one word to them." This state of affairs appears to have continued until the accession of James I., and in 1595 the bailiff and constables of Hexham were removed as being "infected with combination and toleration of thieves." Hexham was at one time the market town of a large agricultural district. In 1227 a market on Monday and a fair on the vigil and day of St Luke the Evangelist were granted to the archbishop, and in 1320 Archbishop Melton obtained the right of holding two new fairs on the feasts of St James the Apostle lasting five days and of SS. Simon and Jude lasting six days. The market day was altered to Tuesday in 1662, and Sir William Fenwick, then lord of the manor, received a grant of a cattle market on the Tuesday after the feast of St Cuthbert in March and every Tuesday fortnight until the feast of St Martin. The market rights were purchased from Wentworth B. Beaumont, lord of the manor, in 1886. During the 17th and 18th centuries Hexham was noted for the leather trade, especially for the manufacture of gloves, but in the 19th century the trade began to decline. Coal mines which had belonged to the archbishop, were sold to Sir John Fenwick, Kt., in 1628. Hexham has never been represented in parliament, but gives its name to one of the four parliamentary divisions of the county.

See Edward Bateson and A. B. Hinds, *A History of Northumberland* vol. iii. (1893-1896); A. B. Wright, *An Essay towards the History of Hexham* (1823); James Hewitt, *A Handbook to Hexham and its Antiquities* (1879).

HEYDEN, JAN VAN DER (1637-1712), Dutch painter, was born at Gorcum in 1637, and died at Amsterdam on the 12th of September 1712. He was an architectural landscape painter, a contemporary of Hobbema and Jacob Ruysdael, with the advantage, which they lacked, of a certain professional versatility; for, whilst they painted admirable pictures and starved, he varied the practice of art with the study of mechanics, improved the fire engine, and died superintendent of the lighting and director of the firemen's company at Amsterdam. Till 1672 he painted in partnership with Adrian van der Velde. After Adrian's death, and probably because of the loss which that event entailed upon him, he accepted the offices to which allusion has just been made. At no period of artistic activity had the system of division of labour been more fully or more constantly applied to art than it was in Holland towards the close of the 17th century. Van der Heyden, who was perfect as an architectural draughtsman in so far as he painted the outside of buildings and thoroughly mastered linear perspective, seldom turned his hand to the delineation of anything but brick houses and churches in streets and squares, or rows along canals, or "moated granges," common in his native country. He was a travelled man, had seen The Hague, Ghent and Brussels, and had ascended the Rhine past Xanten to

Cologne, where he copied over and over again the tower and crane of the great cathedral. But he cared nothing for bill or vale, or stream or wood. He could reproduce the rows of bricks in a square of Dutch houses sparkling in the sun, or stunted trees and lines of dwellings varied by steeples, all in light or thrown into passing shadow by moving cloud. He had the art of painting microscopically without loss of breadth or keeping. But he could draw neither man nor beast, nor ships nor carts; and this was his disadvantage. His good genius under these circumstances was Adrian van der Velde, who enlivened his compositions with spirited figures; and the joint labour of both is a delicate, minute, transparent work, radiant with glow and atmosphere.

HEYLYN (or HEYLIN), PETER (1600-1662), English historian and controversialist, was born at Burford in Oxfordshire. Having made great progress in his studies, he entered Hart Hall, Oxford, in 1613, afterwards joining Magdalen College; and in 1618 he began to lecture on cosmography, being made fellow of Magdalen in the same year. His lectures, under the title of *Μικροσκοπος*, were published in 1621, and many editions of this useful book, each somewhat enlarged, subsequently appeared. Having been ordained in 1624 Heylyn attracted the notice of William Laud, then bishop of Bath and Wells; and in 1628 he married Laetitia, daughter of Thomas Highgate, or Heygate, of Hayes, Middlesex; but he appears to have kept his marriage secret and did not resign his fellowship. After serving as chaplain to Danby in the Channel Islands, he became chaplain to Charles I. in 1630, and was appointed by the king to the rectory of Hemingford, Huntingdonshire. John Williams, bishop of Lincoln, however, refused to institute Heylyn to this living, owing to his friendship with Laud; and in return Charles appointed him a prebendary of Westminster, where he made himself very objectionable to Williams, who held the deanery in commendam. In 1633 he became rector of Alresford, soon afterwards vicar of South Warnborough, and he became treasurer of Westminster Abbey in 1637; but before this date he was widely known as one of the most prominent and able controversialists among the high-church party. Entering with great ardour into the religious controversies of the time he disputed with John Prideaux, regius professor of divinity at Oxford, replied to the arguments of Williams in his pamphlets, "A Coal from the Altar" and "Antidotum Lincolnense," and was hostile to the Puritan element both within and without the Church of England. He assisted William Noy to prepare the case against Prynne for the publication of his *Histriomastix*, and made himself useful to the Royalist party in other ways. However, when the Long Parliament met he was allowed to retire to Alresford, where he remained until he was disturbed by Sir William Waller's army in 1642, when he joined the king at Oxford. At Oxford Heylyn edited *Mercurius Aulicus*, a vivacious but virulent news-sheet, which greatly annoyed the Parliamentarians; and consequently his house at Alresford was plundered and his library dispersed. Subsequently he led for some years a wandering life of poverty, afterwards settling at Winchester and then at Minster Lovel in Oxfordshire; and he refers to his hardships in his pamphlet "Extraneus Vapulans," the cleverest of his controversial writings, which was written in answer to Hamon l'Estrange. In 1653 he settled at Lacy's Court, Abingdon, where he resided undisturbed by the government of the Commonwealth, and where he wrote several books and pamphlets, both against those of his own communion, like Thomas Fuller, whose opinions were less unyielding than his own, and against the Presbyterians and others, like Richard Baxter.

His works, all of which are marred by political or theological rancour, number over fifty. Among the most important are: a legendary and learned *History of St. George of Cappadocia*, written in 1631; *Cyprianus Anglicus, or the history of the Life and Death of William Laud*, a defence of Laud and a valuable authority for his life; *Ecclesia restaurata, or the History of the Reformation of the Church of England* (1661; ed. J. C. Robertson, Cambridge, 1849); *Ecclesia vindicata, or the Church of England*

justified: Atrius redibundus, or History of the Presbyterians; and Help to English History, an edition of which, with additions by P. Wright, was published in 1773. In 1636 he wrote a *History of the Sabbath*, by order of Charles I. to answer the Puritans; and in consequence of a journey through France in 1625 he wrote *A Survey of France*, a work, frequently reprinted, which was termed by Southey "one of the liveliest books of travel in its lighter parts, and one of the wisest and most replete with information that was ever written by a young man." Some verses of merit also came from his active pen, and his poetical memorial of William of Waynflete was published by the Carlton Society in 1851.

Heylyn was a diligent writer and investigator, a good ecclesiastical lawyer, and had always learning at his command. His principles, to which he was honestly attached, were defended with ability; but his efforts to uphold the church passed unrecognized at the Restoration, probably owing to his physical infirmities. His sight had been very bad for several years; yet he rejoiced that his "bad old eyes" had seen the king's return, and upon this event he preached before a large audience in Westminster Abbey on the 29th of May 1661. He died on the 8th of May 1662 and was buried in Westminster Abbey, where he had been sub-dean for some years.

Lives of Heylyn were written by his son-in-law Dr John Bernard or Bernard, and by George Vernon (1682). Bernard's work was reprinted with Robertson's edition of Heylyn's *History of the Reformation* in 1849.

HEYN, PIETER PIETERZOOON [commonly abbreviated to PIET] (1578-1629), Dutch admiral, was born at Delfshaven in 1578, the son of Pieter Hein, who was engaged in the herring fishery. The son went early to sea. In his youth he was taken prisoner by the Spaniards, and was forced to row in the galleys during four years. Having recovered his freedom by an exchange of prisoners, he worked for several years as a merchant skipper with success. The then dangerous state of the seas at all times, and the continuous war with Spain, gave him ample opportunity to gain a reputation as a resolute fighting man. Wills which he made before 1623 show that he had been able to acquire considerable property. When the Dutch West India Company was formed he was Director on the Rotterdam Board, and in 1624 he served as second in command of the fleet which took San Salvador in Bahia de Todos os Santos in Brazil. Till 1628 he continued to serve the Company, both on the coast of Brazil, and in the West Indies. In the month of September of that year he made himself famous, gained immense advantage for the Company, and inflicted ruinous loss on the Spaniards, by the capture of the fleet which was bringing the bullion from the American mines home to Spain. The Spanish ships were outnumbered chiefly because the convoy had become scattered by bad management and bad seamanship. The more valuable part of it, consisting of the four galleons, and eleven trading ships in which the king's share of the treasure was being carried, became separated from the rest, and on being chased by the superior force of Heyn endeavoured to take refuge at Matanzas in the island of Cuba, hoping to be able to land the bullion in the bush before the Dutchman could come up with them. But Juan de Benavides, the Spanish commander, failed to act with decision, was overtaken, and his ships captured in the harbour before the silver could be discharged. The total loss was estimated by the Spaniards at four millions of ducats. Piet Heyn now returned home, and bought himself a house at Delft with the intention of retiring from the sea. In the following year, however, he was chosen at a crisis to take command of the naval force of the Republic, with the rank of Lieutenant-Admiral of Holland, in order to clear the North Sea and Channel of the Dunkirkers, who acted for the king of Spain in his possessions in the Netherlands. In June of 1629 he brought the Dunkirkers to action, and they were severely beaten, but Piet Heyn did not live to enjoy his victory. He was struck early in the battle by a cannon shot on the shoulder and fell dead on the spot. His memory has been preserved by his capture of the Treasure

Galleons, which had never been taken so far, but he is also the traditional representative of the Dutch "sea dogs" of the 17th century.

See de Jonge, *Geschiedenis van het Nederlandsche Zeeweenen*; I. Duro, *Armada española*, iv. der Aa, *Biograph. Woordenboek der Nederlanden*. (D. H.)

HEYNE, CHRISTIAN GOTTLÖB (1729-1812), German classical scholar and archaeologist, was born on the 25th of September 1729, at Chemnitz in Saxony. His father was a poor weaver, and the expenses of his early education were paid by one of his godfathers. In 1748 he entered the university of Leipzig, where he was frequently in want of the necessaries of life. His distress had almost amounted to despair, when he procured the situation of tutor in the family of a French merchant in Leipzig, which enabled him to continue his studies. After he had completed his university course, he was for many years in very straitened circumstances. An elegy written by him in Latin on the death of a friend attracted the attention of Count von Brühl, the prime minister, who expressed a desire to see the author. Accordingly, in April 1752, Heyne journeyed to Dresden, believing that his fortune was made. He was, well received, promised a secretaryship and a good salary, but nothing came of it. Another period of want followed, and it was only by persistent solicitation that Heyne was able to obtain the post of under-clerk in the count's library, with a salary of somewhat less than twenty pounds sterling. He increased his scanty pittance by translation; in addition to some French novels, he rendered into German the *Chaereas and Callirrhoe* of Chariton, the Greek romance writer. He published his first edition of *Tibullus* in 1755, and in 1756 his *Epictetus*. In the latter year the Seven Years' War broke out, and Heyne was once more in a state of destitution. In 1757 he was offered a tutorship in the household of Frau von Schönberg, where he met his future wife. In January 1759 he accompanied his pupil to the university of Wittenberg, from which he was driven in 1760 by the Prussian cannon. The bombardment of Dresden (to which city he had meanwhile returned) on the 18th of July 1760, destroyed all his possessions, including an almost finished edition of Lucian, based on a valuable codex of the Dresden Library. In the summer of 1761, although still without any fixed income, he married, and for some time he found it necessary to devote himself to the duties of land-steward to the Baron von Löben in Lusatia. At the end of 1762, however, he was enabled to return to Dresden, where he was commissioned by P. D. Lippert to prepare the Latin text of the third volume of his *Dactylotheica* (an account of a collection of gems). On the death of Johann Matthias Gesner at Göttingen in 1761, the vacant chair was refused first by Ernesti and then by Ruhken, who persuaded Münchhausen, the Hanoverian minister and principal curator of the university, to bestow it on Heyne (1763). His emoluments were gradually augmented, and his growing celebrity brought him most advantageous offers from other German governments, which he persistently refused. After a long and useful career, he died on the 14th of July 1812. Unlike Gottfried Hermann, Heyne regarded the study of grammar and language only as the means to an end, not as the chief object of philology. But, although not a critical scholar, he was the first to attempt a scientific treatment of Greek mythology, and he gave an undoubted impulse to philological studies.

Of Heyne's numerous writings, the following may be mentioned. Editions, with copious commentaries, of Tibullus (ed. E. C. Wunderlich, 1817), Virgil (ed. G. P. Wagner, 1830-1841), Pindar (3rd ed. by G. H. Schäfer, 1817), Apollodorus, *Bibliotheca Graeca* (1803), Homer, *Iliad* (1802); *Opuscula academica* (1785-1812), containing more than a hundred academical dissertations, of which the most valuable are those relating to the colonies of Greece and the antiquities of Etruscan art and history. His *Antiquarische Aufsätze* (1778-1779) is a valuable collection of essays connected with the history of ancient art. His contributions to the *Göttingische gelehrte Anzeigen* are said to have been between 7000 and 8000 in number. See biography by A. H. Heeren (1813) which forms the basis of the interesting essay by Carlyle (*Misc. Essays*, ii.); H. Sauppe, *Göttinger Professoren* (1872); C. Bursian in *Allgemeine deutsche Biographie*, xiii.; J. E. Sandys, *Hist. Class. Schol.* iii. 36-44.

HEYSE, PAUL JOHANN LUDWIG (1830-), German novelist, dramatist and poet, was born at Berlin on the 15th of March 1830, the son of the distinguished philologist Karl Wilhelm Ludwig Heyse (1797-1855). After attending the Friedrich Wilhelm Gymnasium in Berlin, he went, in 1849, to Bonn University as a student of the Romance languages, and in 1852 took his doctor's degree. He had already given proof of great literary ability in the production in 1850 of *Der Jungbrunnen*, *Märchen eines fahrenden Schülers* and of the tragedy *Francesca von Rimini*, when after a year's stay in Italy, he was summoned, early in 1854, by King Maximilian II. to Munich, where he subsequently lived. Here he turned his attention to novel-writing. He published at Munich in 1855 four short stories in one volume, one of which, at least, *L'Arrabbiato*, was a masterpiece of its kind. These were the precursors of a series of similar volumes, necessarily unequal at times, but on the whole constituting such a mass of highly complex miniature fiction as seldom before had proceeded from the pen of a single writer. Heyse works in the spirit of a sculptor; he seizes upon some picturesque incident or situation, and chisels and polishes until all the effect which it is capable of producing has been extracted from it. The success of the story usually depends upon the theme, for the artist's skill is generally much the same, and the situation usually leaves a deeper impression than the characters. Heyse is also the author of several novels on a larger scale, all of which have gained success and provoked abundant discussion. The more important are *Kinder der Welt* (1873), *Im Paradiese* (1875)—the one dealing with the religious and social problems of its time, the other with artist-life in Munich—*Der Roman der Stijtsdame* (1888), and *Merlin* (1892), a novel directed against the modern realistic movement of which Heyse had been the leading opponent in Germany. He has also been a prolific dramatist, but his plays are deficient in theatrical qualities and are rarely seen on the stage. Among the best of them are *Die Sabinerinnen* (1859); *Hans Lange* (1866), *Kolberg* (1868), *Die Weisheit Salomos* (1886), and *Maria von Magdala* (1903). There are masterly translations by him of Leopardi, Giusti, and other Italian poets (*Italienische Dichter seit der Mitte des 18ten Jahrhunderts*) (4 vols., 1889-1890).

Heyse's *Gesammelte Werke* appeared in 29 vols. (1897-1899); there is also a popular edition of his *Romane* (8 vols., 1902-1904) and *Novellen* (10 vols., 1904-1906). See his autobiography, *Jugenderinnerungen und Bekennnisse* (1901); also O. Kraus, *Paul Heyse's Novellen und Romane* (1888); E. Petzert, *Paul Heyse als Dramatiker* (1904), and the essays by T. Ziegler (in *Studien und Studienköpfe*, 1877), and G. Brandes (in *Moderne Geister*, 1887).

HEYSHAM, a seaport in the Lancaster parliamentary division of Lancashire, England, on the south shore of Morecambe Bay, served by the Midland railway. Pop. (1901) 3381. Under powers obtained from parliament in 1896, the Midland Railway Company constructed, and opened in 1904, a harbour, enclosed by breakwaters, for the development of traffic with Belfast and other Irish ports, a daily passenger-service of the first class being established to Belfast. The harbour has a depth at low tide of 17 ft., and extensive accommodation for live-stock and goods of all kinds is provided. Heysham is in some favour as a watering-place. The church of St Peter is mainly Norman, and has fragments of even earlier date. Ruins of a very ancient oratory stand near it. This was dedicated to St Patrick, and is traditionally said to have been erected as a place of prayer for those at sea.

HEYWOOD, JOHN (b. 1497), English dramatist and epigrammatist, is generally said to have been a native of North Mimms, near St Albans, Hertfordshire, though Bale says he was born in London. A letter from a John Heywood, who may fairly be identified with him, is dated from Malines in 1575, when he called himself an old man of seventy-eight, which would fix his birth in 1497. He was a chorister of the Chapel Royal, and is said to have been educated at Broadgates Hall (Pembroke College), Oxford. From 1521 onwards his name appears in the king's accounts as the recipient of an annuity of ten marks as player of the virginals, and in 1538 he received forty shillings for

"playing an interlude with his children" before the Princess Mary. He is said to have owed his introduction to her to Sir Thomas More, at whose seat at Gobions near St Albans he wrote his Epigrams, according to Henry Peacham. More took a keen interest in the drama, and is represented by tradition as stepping on to the stage and taking an impromptu part in the dialogue. William Rastell, the printer of four of Heywood's plays, was the son of More's brother-in-law, John Rastell, who organized dramatic representations, and possibly wrote plays himself. Mr A. W. Pollard sees in Heywood's firm adherence to Catholicism and his free satire of legal and social abuses a reflection of the ideas of More and his friends, which counts for much in his dramatic development. His skill in music and his inexhaustible wit made him a favourite both with Henry VIII. and Mary. Under Edward VI. he was accused of denying the king's supremacy over the church, and had to make a public recantation in 1554; but with the accession of Mary his prospects brightened. He made a Latin speech to her in St Paul's Churchyard at her coronation, and wrote a poem to celebrate her marriage. Shortly before her death she granted him the lease of a manor and lands in Yorkshire. When Elizabeth succeeded to the throne he fled to Malines, and is said to have returned in 1577. In 1587 he is spoken of as "dead and gone" in Thomas Newton's epilogue to his works.

John Heywood is important in the history of English drama as the first writer to turn the abstract characters of the morality plays into real persons. His interludes link the morality plays to the modern drama, and were very popular in their day. They represent ludicrous incidents of a homely kind in a style of the broadest farce, and approximate to the French dramatic renderings of the subjects of the *fabliaux*. The fun in them still survives in spite of the long arguments between the characters and what one of their editors calls his "humour of filth." Heywood's name was actually attached to four interludes. *The Playe called the foure PP; a newe and a very mery interlude of a palmer, a pardoner, a potycary, a pedler* (not dated) is a contest in lying, easily won by Palmer, who said he had never known a woman out of patience. *The Play of the Wether, a new and a very mery interlude of all maner of Wethers* (printed 1533) describes the chaotic results of Jupiter's attempts to suit the weather to the desires of a number of different people. *The Play of Love* (printed 1533) is an extreme instance of the author's love of wire-drawn argument. It is a double dispute between "Loving not Loved" and "Loved not Loving" as to which is the more wretched, and between "Both Loved and Loving" and "Neither Loving nor Loved" to decide which is the happier. The only action in this piece is indicated by the stage direction marking the entrance of "Neither loved nor loving," who is to run about the audience with a huge copper tank on his head full of lighted squibs, and is to cry "Water, water! Fire, fire!" *The Dialogue of Wit and Folly* is more of an academic dispute than a play. But two pieces universally assigned to Heywood, although they were printed by Rastell without any author's name, combine action with dialogue, and are much more dramatic. In *The Mery Play between the Pardoner and the Frere, the Curate and Neybour Pratte* (printed 1533, but probably written much earlier) the Pardoner and the Friar both try to preach at the same time, and, coming at last to blows, are separated by the other two personages of the piece. *The Mery Play betwene Johan Johan the Husbunde, Tyb the Wyfe, and Syr Jhan the Preest* (printed 1533) is the best constructed of all his pieces. Tyb and Syr Jhan eat the "Pye" which is the central "property" of the piece, while Johan Johan is made to chafe wax at the fire to stop a hole in a pail. This incident occurs in a French *Farce nouvelle très bonne et fort joyeuse de Pernel qui va au vin*. Heywood has sometimes been credited with the authorship of the dialogue of *Gentylines and Nobylite* printed by Rastell without date, and Mr Pollard adduces some ground for attributing to him the anonymous *New Enterlude called Thersytes* (played 1538). Heywood's other works are a collection of proverbs and epigrams, the earliest extant edition of which is dated 1562; some ballads, one of them being the "Willow Garland," known to Desdemona;

and a long verse allegory of over 7000 lines entitled *The Spider and the Flie* (1556). A contemporary writer in Holinshed's *Chronicle* said that neither its author nor any one else could "reach unto the meaning thereof." But the flies are generally taken to represent the Roman Catholics and the spiders the Protestants, while Queen Mary is represented by the housemaid who with her broom (the sword) executes the commands of her master (Christ) and her mistress (the church). Dr A. W. Ward speaks of its "general lucidity and relative variety of treatment." Heywood says that he laid it aside for twenty years before he finished it, and, whatever may be the final interpretation put upon it, it contains a very energetic statement of the social evils of the time, and especially of the deficiencies of English law.

The proverbs and epigrams were reprinted by the Spenser Society in 1867, the *Dialogue on Wit and Folly* by the Percy Society from an MS. in the British Museum in 1846, with an account of Heywood by F. W. Fairholt, and there are modern reprints of *Johan Johan* (Chiswick Press, 1819), *The Foure PP.* (Dodsley's *Old Plays*, 1825, 1874), and *The Pardoner and the Frere* (Dodsley's *Old Plays*, 1874). *The Spider and the Flie* was edited by A. W. Ward for the Spenser Society in 1894. For notes and strictures on that edition see J. Haber in *Litterärhistorische Forschungen*, vol. xv. (1900). See also A. W. Pollard's introduction to the reprint of the *Play of the Wether and Johan Johan in Representative English Comedies* (1903), and *The Dramatic Writings of John Heywood*, edited by John S. Farmer for the Early English Drama Society (1905).

His son, JASPER HEYWOOD (1535-1598), who translated into English three plays of Seneca, the *Troas* (1559), the *Thyestes* (1560) and *Hercules Furens* (1561), was a fellow of Merton College, Oxford, but was compelled to resign from that society in 1558. In the same year he was elected a fellow of All Souls College, but, refusing to conform to the changes in religion at the beginning of the reign of Elizabeth, he gave up his fellowship and went to Rome, where he was received into the Society of Jesus. For seventeen years he was professor of moral theology and controversy in the Jesuit College at Dillingen, Bavaria. In 1581 he was sent to England as superior of the Jesuit mission, but his leniency in that position led to his recall. He was on his way back to the Continent when a violent storm drove him back to the English coast. He was arrested on the charge of being a priest, but, although extraordinary efforts were made to induce him to abjure his opinions, he remained firm. He was condemned to perpetual exile on pain of death, and died at Naples on the 9th of January 1598. His translations of Seneca were supplemented by other plays contributed by Alexander Neville, Thomas Nuce, John Studley and Thomas Newton. Newton collected these translations in one volume, *Seneca, his tenne tragedies translated into Englysh* (1581). The importance of this work in the development of English drama can hardly be over-estimated.

See Dr J. W. Cunliffe, *On the Influence of Seneca upon Elizabethan Tragedy* (1893).

HEYWOOD, THOMAS (d. c. 1650), English dramatist and miscellaneous author, was a native of Lincolnshire, born about 1575, and said to have been educated at Cambridge and to have become a fellow of Peterhouse. Heywood is mentioned by Philip Henslowe as having written a book or play for the Lord Admiral's company of actors in October 1596; and in 1598 he was regularly engaged as a player in the company, in which he presumably had a share, as no wages are mentioned. He was also a member of other companies, of Lord Southampton's, of the earl of Derby's and of the earl of Worcester's players, afterwards known as the Queen's Servants. In his preface to the *English Traveller* (1633) he describes himself as having had "an entire hand or at least a main finger in two hundred and twenty plays." Of this number, probably considerably increased before the close of his dramatic career, only twenty-three survive. He wrote for the stage, not for the press, and protested against the printing of his works, which he said he had no time to revise. He was, said Tieck, the "model of a light and rapid talent," and his plays, as might be expected from his rate of production, bear little trace of artistic elaboration. Charles

Lamb called him a "prose Shakespeare"; Professor Ward, one of Heywood's most sympathetic editors, points out that this epigrammatic statement can only be accepted with reservations. Heywood had a keen eye for dramatic situations and great constructive skill, but his powers of characterization were not on a par with his stagecraft. He delighted in what he called "merry accidents," that is, in coarse, broad farce; his fancy and invention were inexhaustible. It was in the domestic drama of sentiment that he won his most distinctive success. For this he was especially fitted by his genuine tenderness and his freedom from affectation, by the sweetness and gentleness for which Lamb praised him. His masterpiece, *A Woman killed with kindness* (acted 1603; printed 1607), is a type of the *comédie larmoyante*, and *The English Traveller* (1633) is a domestic tragedy scarcely inferior to it in pathos and in the elevation of its moral tone. His first play was probably *The Four Prentises of London: With the Conquest of Jerusalem* (printed 1615, but acted some fifteen years earlier). This may have been intended as a burlesque of the old romances, but it is more likely that it was meant seriously to attract the apprentice public to whom it was dedicated, and its popularity was no doubt aimed at in Beaumont and Fletcher's travesty of the City taste in drama in their *Knight of the Burning Pestle*. The two parts of *King Edward the Fourth* (printed 1600), and of *If you know not me, you know no bodie; Or, The Troubles of Queene Elizabeth* (1605 and 1606) are chronicle histories. His other comedies include: *The Royall King, and the Loyall subject* (acted c. 1600; printed 1637); the two parts of *The Fair Maid of the West; Or, A Girl worth Gold* (two parts, printed 1631); *The Foyre Maid of the Exchange* (printed anonymously 1607); *The Late Lancashire Witches* (1634), written with Richard Brome, and prompted by an actual trial in the preceding year; *A Pleasant Comedy, called A Maiden-Head well lost* (1634); *A Challenge for Beautie* (1636); *The Wise-Woman of Hogsdon* (printed 1638), the witchcraft in this case being matter for comedy, not seriously treated as in the Lancashire play; and *Fortune by Land and Sea* (printed 1655), with William Rowley. The five plays called respectively *The Golden, The Silver, The Brasen and The Iron Age* (the last in two parts), dated 1611, 1613, 1613, 1632, are series of classical stories strung together with no particular connexion except that "old Homer" introduces the performers of each act in turn. *Loves Mistress; Or, The Queens Masque* (printed 1636) is on the story of Cupid and Psyche as told by Apuleius; and the tragedy of the *Rape of Lucrece* (1608) is varied by a "merry lord," Valerius, who lightens the gloom of the situation by singing comic songs. A series of pageants, most of them devised for the City of London, or its guilds, by Heywood, were printed in 1637. In vol. iv. of his *Collection of Old English Plays* (1885), Mr A. H. Bullen printed for the first time a comedy by Heywood, *The Captives, or The Lost Recovered* (licensed 1624), and in vol. ii. of the same series, *Dicke of Devonshire*, which he tentatively assigns to the same hand.

Besides his dramatic works, twelve of which were reprinted by the "Shakespeare Society," and were published by Mr John Pearson in a complete edition of six vols. with notes and illustrations in 1874, he was the author of *Troia Britannica, or Great Britain's Troy* (1609), a poem in seventeen cantos "intermixed with many pleasant poetical tales" and "concluding with an universal chronicle from the creation until the present time"; *An Apology for Actors, containing three brief treatises* (1612) edited for the Shakespeare Society in 1841; *Tyvauxikov or nine books of various history concerning women* (1624); *England's Elizabeth, her Life and Troubles during her minority from the Cradle to the Crown* (1631); *The Hierarchy of the Blessed Angels* (1635), a didactic poem in nine books; *Pleasant Dialogue, and Dramas selected out of Lucian, &c.* (1637; ed. W. Bang, Louvain, 1903); and *The Life of Merlin surnamed Ambrosius* (1641).

See A. W. Ward, *History of English Dram. Lit.* ii. 550 seq. (1899); the same author's Introduction to *A woman killed with kindness* ("Temple Dramatists," 1897); J. A. Symonds in the Introduction to *Thomas Heywood* in the "Mermaid" series (new issue, 1903).

HEYWOOD, a municipal borough in the Heywood parliamentary division of Lancashire, England, 9 m. N. of Manchester on the Lancashire and Yorkshire railway. Pop. (1901) 25,458. It is of modern growth and possesses several handsome churches, chapels and public buildings. The Queen's Park, purchased and laid out at a cost of £11,000 with money which devolved to Queen Victoria in right of her duchy and county palatine of Lancaster, was opened in 1879. Heywood Hall in the neighbourhood of the town was the residence of Peter Heywood, who contributed to the discovery of the Gunpowder Plot. Heywood owes its rise to the enterprise of the Peels, its first manufactures having been introduced by the father of the first Sir Robert Peel. It is an important seat of the cotton manufacture, and there are power-loom factories, iron foundries, chemical works, boiler-works and railway wagon works. Coal is worked extensively in the neighbourhood. Heywood was incorporated in 1881, and the corporation consists of a mayor, 6 aldermen and 18 councillors. Area, 3,660 acres.

HEZEKIAH (Heb. for "[my] strength is [of] Yah"), in the Bible son of Ahaz, one of the greatest of the kings of Judah. He flourished at the end of the 8th and beginning of the 7th century B.C., when Palestine passed through one of the most eventful periods of its history. There is much that is uncertain in his reign, and with the exception of the great crisis of 701 B.C. its chronology has not been unanimously fixed. Whether he came to the throne before or after the fall of Samaria (722-721 B.C.) is disputed; nor is it clear what share Judah took in the Assyrian conflicts down to 702.¹ Shortly before this date the whole of western Asia was in a ferment; Sargon had died and Sennacherib had come to the throne (in 705); vassal kings plotted to recover their independence and Assyrian puppets were removed by their opponents. Judah was in touch with a general rising in S.W. Palestine, in which Ekron, Lachish, Ascalon (Ashkelon) and other towns of the Philistines were supported by the kings of Musri and Meluhha.² Sennacherib completely routed them at Eltekeh (a Danite city), and thence turned against Hezekiah, who had been in league with Ekron and had imprisoned its king Padi, an Assyrian vassal. In this invasion of Judah the Assyrian claims entire success; 46 towns of Judah were captured, 200,150 men and many herds of cattle were carried off among the spoil, and Jerusalem itself was closely invested. Hezekiah was imprisoned "like a bird in a cage"³—to quote Sennacherib, and the Urbi (Arabian?) troops in Jerusalem laid down their arms. Thirty talents of gold, eight hundred of silver, precious stones, couches and seats of ivory—"all kinds of valuable treasure"—the ladies of the court, male and female attendants (perhaps "singers") were carried away to Nineveh. Here the Assyrian record ends somewhat abruptly, for, in the meanwhile, Babylonia had again revolted (700 B.C.) and Sennacherib's presence was urgently needed nearer home.

At what precise period the Babylonian Merodach (i.e. Marduk)-Baladan sent his embassy to Hezekiah is disputed. Although ostensibly to congratulate the king upon his recovery from a sickness, it was really sent in the hope of enlisting his support, and the excessive courtesy and complaisance with which it was received suggest that it found a ready ally in Judah (2 Kings xx. 12 sqq.; Isa. xxxix.). Merodach-Baladan was overthrown by Sargon in 710 B.C., but succeeded in making a fresh revolt some years later (704-703 B.C.), and opinion is much divided whether his embassy was to secure the friendship of the

¹ See W. R. Smith, *Prophets of Israel*, 415 sqq.; O. C. Whitehouse, *Isaiah*, pp. 20 sqq., 372; J. Skinner, *Kings*, p. 43 sqq.; T. K. Cheyne, *Ency. Bib.* col. 2058, n. 1, and references.

² The chief dates are: 720, defeat of a coalition (Hamath, Gaza and Musri) at Karlar in north Syria and Raphia (S. Palestine); 715, a rising of Musri and Arabian tribes; 713-711, revolt and capture of Ashdod (cp. Isa. xx.). That Judah was invaded on this latter occasion is not improbable.

³ Meluhha is held by many critics to be N.W. Arabia; the identification of Musri is uncertain, see below.

⁴ The phrase was a favourite one of Rib-Addi, king of Gebal (Byblus), in the 15th century B.C.; *Tell-el-Amarna Letters* (ed. Knudtzon), Nos. 74, 79, &c. Jeremiah (v. 27) uses the simile in a different way. For a discussion of Sennacherib's record, see Wilke, *Jesaja u. Assur* (Leipzig, 1905), pp. 97 sqq.

youthful Hezekiah at his succession of is to be associated with the later widespread attempt to remove the Assyrian yoke.¹

The brief account of the Assyrian invasion, Hezekiah's submission, and the payment of tribute in 2 Kings xviii. 14-16, supplements the Assyrian record by the statement that Sennacherib besieged Lachish, a fact which is confirmed by a bas-relief (now in the British Museum) depicting the king in the act of besieging that town.² This thoroughly historical fragment is followed by two narratives which tell how the king sent an official from Lachish to demand the submission of Hezekiah and conclude with the unexpected deliverance of Jerusalem. Both these stories appear to belong to a biography of Isaiah, and, like the similar biographies of Elijah and Elisha, are open to the suspicion that historical facts have been subordinated to idealize the work of the prophet. See **KINGS, BOOKS OF**.

The narratives are (a) 2 Kings xviii. 13, 17-xix. 8; cf. Isa. xxxvii. 1-xxxviii. 8, and (b) xix. 28-35; cp. Isa. xxxvii. 9-36 (2 Chron. xxxii. 9 sqq. is based on both), and Jerusalem's deliverance is attributed to a certain rumour (xix. 7), to the advance of Tirhakah, king of Ethiopia (v. 9), and to a remarkable pestilence (v. 35) which finds an echo in a famous story related, not without some confusion of essential facts, by Herodotus (ii. 141; cf. Josephus *Antiq.* x. i. 5).³ It is difficult to decide whether xix. 28 belongs to the first or second of these narratives; and whether the "rumour" refers to the approach of Tirhakah, or rather to the serious troubles which had arisen in Babylonia. It is equally difficult to determine whether Tirhakah actually appeared on the scene in 701, and the precise application of the term *Musri* (*Mizraim*) is much debated. Unless the two narratives are duplicates of the same event, it may be urged that Sennacherib's attack upon Arabia (apparently about 689) involved an invasion of Judah, by which time Egypt was in a position to be of material assistance (cf. Isa. xxx. 1-5, xxxi. 1-37). This theory of a second campaign (first suggested by Sir Henry Rawlinson) has been contested, although it is pointed out that Sennacherib at all events did not invade Egypt, and that 2 Kings xix. 24 (Isa. xxxvii. 25) can only refer to his successor. The allusion to the murder of Sennacherib (xix. 36 sq.)⁴ points to the year 681, but it is uncertain to which of the above narratives it belongs. On the whole, the question must be left open, and with it both the problem of the extension of the name *Musri* and *Mizraim* outside Egypt in the Assyrian and Hebrew records of this period and the true historical background of a number of the Isaianic prophecies. It is quite possible that later events which belong to the time of the Egyptian supremacy and the wars of Esarhaddon have been confused with the history of Sennacherib's invasion.

It is not certain whether Hezekiah's conflict with the Philistines as far as Gaza or his preparations to secure for Jerusalem a good water supply (xviii. 8, xx. 20; 2 Chron. xxxii. 30; Eccles. xviii. 17 sq.)⁵ should precede or follow the events which have been discussed. On the other hand, the reforms which the compiler of the book has attributed to the early part of the reign were doubtless much later (2 Kings xviii. 1-8). Not the fall of Samaria, but the crisis of 701, is the earliest date that could safely be chosen, and the extent of these reforms must not be overestimated. They are related in terms that imply an acquaintance with the great "Deuteronomic" movement (see **DEUTERONOMY**), and are magnified further with characteristic detail by the chronicler (2 Chron. xxix.-xxxi.). The most remarkable was the destruction of a brazen serpent, the cult of which was traditionally traced back to the time of Moses (Num. xxi. 9).⁶ This persistence of serpent-cult, and the

¹ For the early date (between 720 and 710). Winckler, *Allzeit Unt* 139 sqq.; Burney, *Kings*, 350 sq.; Driver; Köchler, &c.; for the later, Whitehouse, *Isaiah*, 29 sq., in agreement with Schrader, Wellhausen, W. R. Smith, Cheyne, McCurdy, Paton, &c.

² Isa. x. 28-32 may perhaps refer to this invasion. Allusions to the Assyrian oppression are found in Isa. x. 5-15, xiv. 24-27, xvii. 12-14; and to internal Judaean intrigues perhaps in Isa. xxii. 15-18, xxxix. 15. For a picture of the ruins in Jerusalem, see Isa. xxii. 9-11. But see further **ISAIAH (BOOK)**.

³ See, on the story, Griffith, in D. Hogarth's *Authority and Archaeology*, p. 167, n. 1.

⁴ The house of *Nisroch* should probably be that of the god *Nusku*; see also Driver in Hogarth, *op. cit.* p. 109; Winckler, *op. cit.* p. 84.

⁵ It is commonly believed that Hezekiah constructed the conduit of Siloam, famous for its Hebrew inscription (see **INSCRIPTIONS, JERUSALEM**). But Isa. viii. 6, would seem to show that the pool was already in existence, and, for palaeographical details, see *Pal. Explor. Fund. Quart. Stat.* (1909), pp. 289, 305 sqq.

⁶ The name *Nehushtan* (2 Kings xviii. 4, cp. *nāhāsh*, "serpent") is obscure; see the commentaries.

idolatry (necromancy, tree-worship) which the contemporary prophets denounce, do not support the view that the apparently radical reforms of Hezekiah were extensive or permanent, and Jer. xxvi. 17-19 (which suggests that Micah had a greater influence than Isaiah) throws another light upon the conditions during his reign. Hezekiah was succeeded by his son **MANASSEH** (q.v.).

See further W. R. Smith, *Prophets*, 359-364, and **HEBREW RELIGION**. According to Prov. xxv. 1, Hezekiah was a patron of literature (see **PROVERBS**). The hymn which is ascribed to the king (Isa. xxxviii. 9-20, wanting in 2 Kings) is of post-exilic origin (see Cheyne, *Introd. to Isaiah*, 222 sq.), but is further proof of the manner in which the Judaean king was idealized in subsequent ages, partly, perhaps, in the belief that the deliverance of Jerusalem was the reward for his piety. For special discussions, see Stade, *Zetts. d. allzeit. Wissenschaft*, 1886, pp. 173 sqq.; Winckler, *Allzeit. Untersuch.*, 26 sqq.; Schrader, *Cuneiform Inscri. and Old Test.* (on 2 Kings, 1. c.); Driver, *Isaiah, his Life and Times*, pp. 43-83; A. Jeremias, *Alt. Test.* 304-310; Nagel, *Zug d. Sannherib gegen Jerus.* (Leipzig, 1903, conservative); and especially Práček, *Sannherib's Feldzüge gegen Juda* (*Mitteil. d. vorderasiat. Gesell.*, 1903, pp. 113-158), K. Fullerton, *Bibliotheca sacra*, 1906, pp. 577-634, A. Alt, *Israel u. Ägypten* (Leipzig, 1909); also the bibliography to **ISAIAH**. (S. A. C.)

HIATUS (Lat. for gaping, or gap), a break in continuity, whether in speech, thought or events, a lacuna. In anatomy the term is used for an opening or foramen, as the *hiatus Fallopii*, a foramen of the temporal bone. In logic a hiatus occurs when a step or link in reasoning is wanting; and in grammar it is the pause made for the sake of euphony in pronouncing two successive vowels, which are not separated by a consonant.

HIAWATHA ("he makes rivers"), a legendary chief (c. 1450) of the Onondaga tribe of North American Indians. The formation of the League of Six Nations, known as the Iroquois, is attributed to him by Indian tradition. In his miraculous character Hiawatha is the incarnation of human progress and civilization. He teaches agriculture, navigation, medicine and the arts, conquering by his magic all the powers of nature which war against man.

See J. N. B. Hewitt, in *Amer. Anthrop.* for April 1892.

HIBBING, a village of St Louis county, Minnesota, U.S.A., 75 m. N.W. of Duluth. Pop. (1900) 2481; (1905 state census) 6566, of whom 3537 were foreign-born (1169 Finns, 516 Swedes, 498 Canadians, 323 Austrians and 314 Norwegians); (1910) 8832. Hibbing is served by the Great Northern and the Duluth, Missabe & Northern railways. It lies in the midst of the great Mesabi iron-ore deposits of the state; in 1907 forty iron mines were in operation within 10 m. of the village. Lumbering and farming are also important industries. The village owns and operates the water-works and electric-lighting plant. Hibbing was settled in 1892 and was incorporated in 1893.

HIBERNACULUM (Lat. for winter quarters), in botany a term for a winter bud; in botanic gardens, the winter quarters for plants, in zoology, the winter bud of a polyzoan.

HIBERNATION (winter sleep), the dormant condition in which certain animals pass the winter in cold latitudes. Aestivation (summer sleep) is the similar condition in which other species pass periods of heat or drought in warm latitudes. The origins of these kindred phenomena are probably to be sought in the regularly recurrent failure of food supply or of other factors essential to existence due to the seasonal onset of cold in the one case and of excessively dry hot weather in the other. They are means whereby certain non-migratory species are enabled to live through unfavourable climatic conditions which would end fatally in starvation or desiccation were the animals to maintain their normal state of activity.

I. *The Physiology of Hibernation.* *Hibernation and Aestivation.*—The physiology of hibernation, as exemplified in mammalia, has been worked out in detail by several observers in the case of some European species, notably bats, hedgehogs, dormice and marmots. Of the physiology of aestivation nothing definite appears to have been ascertained. It seems probable, however, from observations upon the dormant animals that the physiological accompaniments of winter and summer sleep are to all intents and purposes the same. The state of hibernation,

for example, in the European hedgehog (*Erinaceus europaeus*) is not distinguished by external signs from the state of aestivation of the allied Mascarene genus, the tenrec (*Centeles caudatus*). The lethargy in both cases appears to be directly due to fall in the temperature of the organisms; and the fall in temperature proceeds *pari passu* with the slowing down and weakening of the respiration and with retardation in the circulation of the blood. Similarity, moreover, between hibernation and aestivation is shown not only in their physiological accompaniments but also in the species of animals which become seasonally dormant. Birds neither hibernate nor aestivate. The tenrec (*Centeles*) of Madagascar, which aestivates, closely resembles the hedgehog (*Erinaceus*) in habits and belongs to the same order of mammalia. In the case of reptiles and batrachians, snakes, lizards, tortoises, frogs and toads sleep the winter through in cold countries; and some species of these groups habitually bury themselves in the sand or mud in tropical latitudes where drought is of periodical occurrence. Terrestrial molluscs lie dormant in the winter in cold and temperate latitudes and their tropical allies aestivate in districts where conditions enforce the habit. Some fresh-water molluscs bury themselves in the mud at the bottom of ponds when the surface is covered with ice; others take refuge in the same way when pools and tanks become exhausted during the dry season in the tropics. In temperate and north temperate countries insects and arachnida either die or retire to winter quarters during the cold weather, and in the tropics they similarly disappear during times of drought.

Predisposing Causes of Hibernation.—The likeness between hibernation and aestivation and the coincidence of the one with cold and of the other with heat arrest the conclusion that the temperature of the surrounding medium, whether atmospheric or aquatic, is the prime, much less the sole, cause of either. The effect of extreme cold is to rouse the hibernating animal from its slumber; and its continuance thereafter brings about a state of torpor which proves fatal. This at least appears to be the case with mammals, where actual freezing of the tissues is followed by death because the gases are expelled from the fluids as bubbles and the salts separate in the form of crystals. Some cold-blooded animals, however, may be cooled to 0° C. Fish have been resuscitated after solidification in blocks of ice, and frogs have been known to recover when ice has been formed in the blood and in the lymph of the peritoneal cavity (Landois).

For the reasons given, all hibernating mammals take precautions against exposure to extreme cold. They either bury themselves in the soil or under the snow or seek the shelter of hollow trees or of caves, not infrequently congregating in the same spot so that the temperature is kept up by corporeal contact. Again the hibernating instinct may be suspended unless the conditions are favourable for safely entering upon winter sleep. It is alleged that bears in Scandinavia do not hibernate unless food has been sufficiently plentiful during the summer and autumn to fatten them for their winter fast, and hedgehogs and dormice in captivity have been known to remain active in the cold until warm sleeping-quarters were insured by placing hay and cotton-wool in their cages. Finally the wood-chucks (*Arctomys monax*) in the Adirondacks retire to winter quarters at about the time of the autumnal equinox, when the weather is warm and pleasant, and emerge at the vernal equinox before the snows of winter have vanished from the ground. These and other facts justify Marshall Hall's conclusion that cold is merely a predisposing cause of hibernation in the sense that it is a predisposing cause of ordinary sleep. It has also been shown that the state of hibernation cannot be forced upon snails in summer by submitting them to artificial cold even almost to freezing point; but that at the proper season they prepare for winter quarters at temperatures varying from 37° to 77° Fahr. Again insects sometimes retire to winter quarters in the autumn when the temperature of the atmosphere is higher than that of preceding days during which they retain their activity.

Thus the oncoming and ceasing both of winter and summer sleep depend to a considerable extent upon conditions of existence

other than those of temperature. Darwin saw scarcely a sign of a living thing on his arrival at Bahia Blanca, Argentina, on the 7th of Sept., although by digging several insects, large spiders and lizards were found in a half-torpid state. During the days of his visit when nature was dormant the mean temperature was 51°, the thermometer seldom rising above 55° at mid-day. But during the succeeding days when the mean temperature was 58° and that of the middle of the day between 60° and 70° both insect and reptilian life was in a state of activity. Nevertheless at Montevideo, lying only four degrees further north, between the 26th of July and the 10th of August when the mean temperature was 58.4° and the mean highest temperature of mid-day 65.5° almost every beetle, several genera of spiders, land molluscs, toads and lizards were all lying dormant beneath stones. Thus the animal-life at Montevideo remained dormant at a temperature which roused that at Bahia Blanca from its torpidity. Darwin unfortunately does not record whether the species observed were identical in the two localities.

The temperature of animals in a profound state of hibernation is approximately the same as that of the surrounding medium or at most a degree or two higher. If, however, the temperature of the chosen hibernaculum (winter quarters) falls as low as freezing point, life is endangered at least in the case of mammals.

In most cold-blooded animals, like reptiles, the temperature is normally only a little above that of the atmosphere, the two rising and falling together. But, setting aside the young, especially of those species in which the offspring are born or hatched at a comparatively early stage of development, the majority of warm-blooded animals are able to maintain a high and approximately level temperature irrespective of decline in the temperature of the surrounding medium. This faculty of temperature adjustment, however, appears to be absent or weakened in most if not in all hibernating mammals both in their normal nocturnal or diurnal sleep and in their winter sleep. In the case of European bats it has been shown that the ordinary day sleep in summer differs only in the matter of duration from the prolonged slumber of the same animals in winter. The temperature falls with that of the atmosphere, respiration practically ceases and immersion in water for as many as eleven minutes has been known to prove innocuous. At moderate temperatures ranging from 45° to 50° F., dormice (*Muscardinus avellanarius*) and hedgehogs (*Erinaceus europaeus*) alternately wake to feed and sink into slumber. Dormice awake once in every twenty-four hours; the sleep of the hedgehogs may last for two or three days. The temperature of the hedgehog, when awake and active, rises to about 87° F., that of the dormouse to 92° or 94° F.; but during sleep the temperature of both species falls to about that of the atmosphere. In other words, all the phenomena characteristic of hibernation are exhibited in these animals during the periods of sleep interrupting their periods of wakeful activity. Sleep of this nature, for which the term "diurnation" has been proposed, because it has only been observed in nocturnal animals, lies phenomenally midway between the normal sleep of non-hibernating mammals and the dormant condition in winter of hibernating species. The stimulus of hunger appears to be the prime cause of its periodic cessation. Since then the faculty of temperature adjustment is in abeyance during the ordinary diurnal summer sleep in hibernating mammals, which in this physiological particular resemble reptiles, it seems probable that hibernation can only be practised by those species in which the power to maintain, when sleeping, a permanent average high temperature has been lost or perhaps never acquired. That there is no broad line of demarcation between the ordinary sleep of these hibernating mammals in which the temperature is known to drop considerably and that of non-hibernating species is indicated by the fact that the temperature of human beings and possibly of all non-hibernating species falls to a certain, though to a limited, extent in ordinary sleep.

The relation between the internal body-temperature and the respiratory movements has been worked out in hibernating dormice, hedgehogs, marmots and bats. When the temperature

is below 12° C., the torpid animal exhibits long periods of apnoea of several minutes' duration and interrupted by a few respirations. With the temperature rising above 13° C., the periods of apnoea in the still inactive animal become shorter, the respiration suddenly commencing and ceasing (Biot's type), or gradually waxing and waning (Cheyne-Stokes' type). When the temperature is at about 16° C., the periods of apnoea in the gradually awaking animal are very short and infrequent. When the temperature is about 20° and rising apace, respiration becomes continuous and rapid and the animal is awake. These stages have been especially recorded in the case of dormice. In the last stage the respiration of hedgehogs and marmots is somewhat different, there being a series of rapid respirations, often followed by a single deep sighing respiration.

Respiration appears to be totally suspended in animals in a complete state of hibernation, if left undisturbed. It may however, be readily re-excited by the slightest stimulus, and to this fact may perhaps be attributed the belief that breathing does not actually cease. If a hibernating hedgehog be lightly touched it draws a deep breath, and breathing is maintained for a longer or shorter time before again ceasing, but if at the same time the temperature of the atmosphere be raised, respiration becomes continuous and lethargy is succeeded by activity (Marshall Hall). The opinion that respiration is totally suspended is supported by a number of facts. Hibernating marmots and bats, for example, have been known to live four hours in carbon dioxide, a gas which proves almost instantly fatal to mammals in a state of normal activity (Spallanzani). A hedgehog which may be drowned in about three minutes when awake and active, has been removed from water uninjured when in deep winter sleep after twenty-two and a half minutes' submergence. A hibernating noctule bat, when similarly treated, survived sixteen minutes' immersion. Further proof of the suspension of respiration has been furnished by experiments upon a bat which while in a deep and undisturbed state of lethargy was kept in a pneumatometer for ten hours without appreciably affecting the percentage of oxygen in the air. The same animal, when active, removed over 5 cub. in. of oxygen in the space of one hour from the instrument.

As in the case of respiration, *alimentation* and *excretion* are suspended during hibernation.

The *circulation of the blood*, on the other hand, continues without interruption, though its rapidity is greatly retarded. This fact may be observed by microscopic examination of the wings of bats in a state of winter sleep. Moreover, in the case of a hedgehog lethargic from hibernation, it was experimentally shown that when the spinal cord was severed behind the occipital foramen, the brain removed and the entire spinal cord gently destroyed, the heart continued to beat strongly and regularly for several hours, the contraction of the auricles and ventricles being quite perceptible, though feeble, even after the lapse of ten hours. After eleven hours the organ was motionless, but resumed its activity when stimulated by a knife-point. Even after twelve hours both auricles responded to the same stimulus, though the ventricles remained motionless. Shortly afterwards the auricles gave no response. On the other hand, when the spinal cord of a hedgehog in a normal state of activity was severed at the occiput, the left ventricle ceased to beat almost at once, and the left auricle in less than fifteen minutes; the right auricle was the next to cease, whereas the right ventricle continued its contraction for about two hours. Experiments upon marmots have yielded very similar results. The heart of a marmot decapitated in a state of lethargy continued to beat for over three hours. The pulsations, at first strong and frequent and varying from 16 to 18 per minute, became gradually weaker and less frequent, until at the end of the third hour only 3 were recorded in the same length of time. Excised pieces of voluntary muscular tissue contracted vigorously three hours after death under electric stimulus. Only at the end of four hours did they cease to respond. The heart of an active marmot killed in the same way contracted about 28 times a minute at first, the number of pulsations falling to about 12 at the end of fifteen

minutes, to 8 at the end of thirty minutes, and ceasing altogether at the end of fifty minutes. Similarly the response of the muscles to galvanic shock failed at a correspondingly rapid rate. It is evident, therefore, that during hibernation the irritability of the heart is augmented in a marked degree, and that the irritability of the left side of the organ is scarcely less pronounced than that of the right side. Similar reduction in the rate of the circulation has been demonstrated in certain hibernating mollusca, Mr C. Ashford having proved experimentally that the number of pulsations of the heart per minute gradually lessens with a falling temperature. At a temperature of 52° F. the number was 22 in the common garden snail (*Helix hortensis*), and 21 in the cellar slug (*Hyalinia cellaria*). At a temperature of 30° F. the pulsation fell to 4 in the former and to 3 in the latter animal.

The nature of hibernation, and probably also of aestivation, and the principal physiological phenomena connected with them, may be briefly summarized as follows:—

1. During hibernation death from starvation and wasting of the tissues is prevented by the absorption of fat, which, at least in the case of mammalia, is stored in considerable quantities, sometimes in definite parts of the body, during the weeks of activity immediately preceding the period of winter sleep.

2. Every gradation seems to exist between ordinary sleep and hibernation; the differences between the ordinary diurnal or nocturnal sleep in summer of hibernating animals and their prolonged and lethargic quiescence in winter are merely differences of degree, differences, that is to say, of intensity and duration.

3. The physiological accompaniments of hibernation are: (a) Cessation of all activities associated with alimentation and excretion; (b) lowering of the body temperature to that of the surrounding medium or to within a few degrees of it; (c) total or almost total cessation of respiration, accompanied by power to survive immersion for a considerable time in water or asphyxiating gases, which prove rapidly fatal to the same animals when normally active; (d) marked increase in the irritability of the muscles, especially of those of the left side of the heart, whereby the pulsations of that organ, although retarded, are uninterruptedly maintained; (e) a slight exchange of gases in the lungs is kept up by the cardiopneumatic movement.

4. Amongst cold-blooded animals, both vertebrate and invertebrate, devoid of the faculty of temperature adjustment, the phenomenon of hibernation or aestivation is of general occurrence wherever the conditions of existence accompanying the onset of cold or drought are inimical to active life. In hot-blooded vertebrates, on the contrary, the phenomena are non-existent so far as birds are concerned; aestivation is of very rare occurrence in mammalia, while hibernation is practised by a comparatively small number of species; and in these the faculty of temperature adjustment appears to be temporarily at all events in abeyance.

II *The Zoology of Hibernation and Aestivation*.—Owing to the extreme difficulty of keeping wild animals under observation in their natural haunts for any lengthened time, it is almost impossible to get accurate knowledge of the details of this state of existence. In a general way it is known, or assumed from their disappearance, that certain species retire to winter quarters in particular districts, but on such important points as whether the winter sleep is continuous or interrupted, light or profound, assured information is for the most part not forthcoming. This is true even of familiar species inhabiting Europe and North America, which have been objects of study for many years. It is still more true of species occurring in countries uninhabited and rarely visited, especially in winter, by naturalists interested in such questions. The Chiroptera (bats) furnish an illustration of this truth. It was formerly assumed that the winter sleep of these animals in north and temperate Europe was complete and uninterrupted. Marshall Hall, for example, remarked that "perhaps the bat may be the only animal which sleeps profoundly the winter through without awaking to take food." It was known, it is true, that in countries where gnats and other winged insects disappear with the first frosts of winter, bats which feed upon them retire to winter quarters in hollow trees, caves, sheds or other places likely to afford them sufficient shelter. Here they hang suspended, solitary or in companies according to the species. But a mild spell of weather in mid-winter will sometimes entice a few to take wing while it lasts, although they never appear in any numbers until crepuscular and nocturnal insects are plentiful. But Mr T. A. Coward has

recently shown in the case of the greater and lesser horseshoe bats (*Rhinolophus ferrum-equinum* and *R. hipposiderus*), that during the early period of their occupation of the winter retreat, hibernation, in the strict sense of the word, does not take place, and that even later in the season the sleep is constantly interrupted, especially when the temperature of the air rises above 46° F. and that during their wakeful intervals they crawl about and feed apparently upon the insects which live throughout the year in the caves. This is also true of the long-eared bat (*Plecotus auritus*), and probably of other species of this group. At Mussoorie in the Himalayas, and in other parts of northern India, insectivorous bats, such as *Rhinolophus luctus* and *Rh. affinis*, pass the winter in a semi-torpid state, and are rarely seen abroad during the cold season. The fruit-eating bats, on the contrary (*Pteropidae*), which are more southern in their distribution and are restricted in the Himalayas to the warmer valleys and lower slopes of the mountains, are as active in the winter as at other times of the year (Blanford).

Although almost as exclusively insectivorous as bats, moles and shrews do not, so far as is known, hibernate. This distinction between two groups so nearly alike in diet, no doubt depends upon the difference in their habitats and in those of the creatures they live upon. By tunnelling deeper in winter than in summer, moles are still able to find worms and various insects buried in the earth beyond the reach of frost; and shrews hunt out spiders, centipedes and insects which in their larval, pupal or sexual stages have taken shelter and lie dormant in holes and crannies of the soil, beneath the leaves of ground plants or under stones and logs of wood. In view of the perennially active life of the two insectivora just mentioned, it is a singular fact that the common hedgehog (*Erinaceus europaeus*)—the only member of this order besides genera referable to the moles (*Talpidae*) and shrews (*Soricidae*) that inhabits temperate and north-temperate latitudes in Europe and Asia—passes the winter in a state of torpor unsurpassed in profundity by that of any species of mammal so far as is known. Possibly the explanation of this seeming anomaly may be found in the binomial differences between the three animals. The subterranean feeding habits of the mole render hibernation unnecessary on his part. Therefore the shrew and the hedgehog, both surface feeders for the most part, need only be considered in this connexion. As compared with shrews, amongst the smallest of palaearctic mammals, the hedgehog is of considerable size. Moreover, in point of vivacious energy it would be difficult to find two mammals of the same order more utterly unlike. Hence in winter when insects are scarce and demand active and diligent search, it is quite intelligible that the shrews, in virtue of their smallness and rapidity of movement, are able to procure sufficient food for their needs; whereas the hedgehogs, requiring a far larger quantity and handicapped by lack of activity, would probably starve under the same conditions. Like the common hedgehog of Europe, the long-eared hedgehog (*Erinaceus megalotis*) hibernates in Afghanistan from November till February. The tenrec (*Centetes caudatus*), a large insectivore from Madagascar, aestivates during the hottest weeks of the year; and specimens exhibited in the Zoological Gardens in London preserved the habit although kept at a uniform temperature and regularly supplied with food.

Amongst the Rodentia, no members of the Lagomorpha (hares, rabbits and picas) are known to hibernate, although some of the species, like the mountain hare (*Lepus timidus*), extend far to the north in the palaearctic region, and the picas (*Ochotona*) live at high altitudes in the Himalayas and Central Asia, where the cold of winter is excessive, and where the snow lies deep for many months. It is probable that the picas live in fissures and burrows beneath the snow, and feed on stores of food accumulated during the summer and autumn. The Hystrico-morpha also are non-hibernators. It is true that the common porcupine (*Hystrix cristata*) of south Europe and north Africa is alleged to hibernate; the statement cannot, however, be accepted without confirmation, because the cold is

seldom excessive in the countries it frequents, and specimens exhibited in the Zoological Gardens in London remain active throughout the year, although kept in enclosures without artificial heat of any kind. Even the most northerly representative of this group, the Canadian porcupine (*Erethizon dorsatus*), which inhabits forest-covered tracts in the United States and Canada, may be trapped and shot in the winter. Some members of this group, like capybaras (*Hydrochoerus capybara*) and coypus (*Myocastor coypus*) which live in tropical America, are unaffected by the winter cold of temperate countries, and live in the open all the year round in parks and zoological gardens in England. Several of the genera of Myomorpha contain species inhabiting the northern hemisphere, which habitually hibernate. The three European genera of dormice (*Myoxidae*), namely *Muscardinus*, *Eliomys* and *Glis*, sleep soundly practically throughout the winter; and examples of the South African genus *Graphiurus* practise the same habit when imported to Europe. If a warm spell in the winter rouses dormice from their slumbers, they feed upon nuts or other food accumulated during the autumn, but do not as a rule leave the nests constructed for shelter during the winter. According to the weather, the sleep lasts from about five to seven months. In the family *Muridae*, the true mice and rats (*Murinae*) and the voles and lemmings (*Arvicolinae*) seem to remain active through the winter, although some species, like the lemmings, range far to the north in Europe and Asia; but the white-footed mice (*Hesperomys*) of North America, belonging to the *Cricetinae*, spend the winter sleeping in underground burrows, where food is laid up for consumption in the early spring. The Canadian jumping mouse (*Zapus hudsonianus*), one of the *Jaculidae*, also hibernates, although the sleep is frequently interrupted by milder days. Some of the most northerly species of jerboas (*Jaculidae*), namely *Alactaga decumana* of the Kirghiz Steppes and *A. indica* of Afghanistan, sleep from September or October till April; and the Egyptian species (*Jaculus jaculus*) and the Cape jumping hare (*Pedetes caper*), one of the *Hystricomorpha*, remain in their burrows during the wet season in a state analogous to winter sleep. The sub-order Sciuromorpha also contains many hibernating species. None of the true squirrels, however, appear to sleep throughout the winter. Even the red squirrel (*Sciurus hudsonianus*) of North America retains its activity in spite of the sub-arctic conditions that prevail. The same is true of its European ally *Sc. vulgaris*. The North American grey squirrel (*Sc. cinereus*), although more southerly in its distribution than the red squirrel of that country, hibernates partially. Specimens running wild in the Zoological Gardens in London disappear for a day or two when the cold is exceptionally keen, but for the most part they may be seen abroad throughout the season. On the other hand, ground squirrels like the chipmunks (*Tamias*) and the susliks or gophers (*Spermophilus*) of North America and Central Asia, at all events in the more northern districts of their range, sleep from the late autumn till the spring in their subterranean burrows, where they accumulate food for use in early spring and for spells of warmer weather in the winter which may rouse them from their slumbers. The North American flying squirrel (*Sciuropterus volucella*) and its ally *Pteromys inornatus* are believed to hibernate in hollow trees. All the true marmots (*Arctomys*), a genus of which the species live at tolerably high altitudes in Central Europe, Asia and North America, appear to spend the winter in uninterrupted slumber buried deep in their burrows. They apparently lay up no store of food, but accumulate a quantity of fat as the summer and autumn advance, and frequently, as in the case of the woodchuck (*A. monax*) of the Adirondacks, retire to winter quarters in the autumn long before the onset of the winter cold. The prairie marmots or prairie dogs (*Cynomys ludovicianus*) of North America, which live in the plains, do not hibernate to the same extent as the true marmots, although they appear to remain in their burrows during the coldest portions of the winter. Beavers (*Castor*), although formerly at all events extending in North America from the tropic of Cancer up to the Arctic circle, do not hibernate. When the ground

is deep in snow and the river frozen over, they are still able to feed on aquatic plants beneath the ice.

Amongst the terrestrial carnivora hibernation appears to be practised, with one possible exception, only by species belonging to the group Arctoidea. In north temperate latitudes both in Europe and Asia, as well as in the Himalayas, brown bears (*Ursus arctos*) hibernate, so also does the North American grizzly bear (*U. horribilis*), at least in the more northern districts of its range. The smaller black bear of the Himalayas (*U. tibetanus*) appears to lapse into a state of semi-torpor during the winter, only emerging from his retreat to hunt for food when occasional breaks in the weather occur. In the case of the American black bear (*U. americanus*) the female seeks winter quarters comparatively early in the season in preparation for the birth of her progeny soon after the turn of the year; but the males remain active so long as plenty of food is to be found. In the case of all bears, except the Polar bear (*U. maritimus*), the site chosen as the hibernaculum is either a cave or hole or some sheltered spot beneath a ledge of rock, or the roots of large trees, more or less overgrown with brushwood which holds the snow until it freezes into a solid roof over the hollow where the sleeping animal lies. In the hibernating brown and black bears the intestine is blocked by a plug commonly called "tappen" and composed principally of pine leaves, which is usually not evacuated until the spring. There is much diversity of opinion on the subject of the hibernation of Polar bears. Their absence during the winter from particular spots in the Arctic regions where ice-bound ships have spent the winter, and the occasional discovery of specimens buried beneath the snow, have led to the belief that these animals habitually retire to winter quarters through the cold sunless months of the year. This may possibly be the true explanation at least for certain districts. But it has been alleged that bears, both adult and half-grown, may be seen throughout the winter; and it is known that pregnant females bury themselves in the autumn under the snow, where they remain without feeding with their newly-born young until the spring of the following year. Hence the absence of bears in the winter from the neighbourhood of ice-bound ships may be explained on the supposition that the adult females alone hibernate for breeding purposes, while the full-grown males and half-grown specimens of both sexes migrate in the winter to the edges of the ice-floes and to coast lines, where the water is open. Before retiring to winter quarters the pregnant females store up sufficient quantity of fat in their tissues not only to sustain themselves but also to supply milk for their cubs. In the Adirondack region and probably in other districts of the same or more northern latitudes in North America, raccoons (*Procyon lotor*) retire in the winter to some sheltered place, such as a hollow tree-trunk, and pass the severest part of the season in sleep, emerging in February or March when the snow has begun to disappear. In the same country, the skunks (*Mephitis mephitis*), a member of the weasel family, also seek shelter during the coldest portion of the winter. Merriam believes that the hibernation of this animal is determined by cold, and not by failure of food-supply, for he observes that skunks may frequently be seen in numbers on snow lying 5 ft. deep at a time of the year when they feed almost entirely upon mice and shrews which do not hibernate even when the thermometer registers over twelve degrees of frost. In British North America the badger (*Taxidea americana*) is said to hibernate from October till April; but the duration of the period probably depends, as in the case of its European ally (*Meles meles*), upon the length and severity of the inclement season. In the last-named species the winter repose is not as a rule sufficiently profound to prevent a break in the weather rousing the animal from sleep to sally forth in search of food. This interrupted hibernation takes place at least in England and even in Scandinavia; but in countries where frost is continuous throughout the winter it is probable that the badger's sleep is unbroken.

The one exception to the general rule that hibernation in the carnivora is restricted to the Arctoidea, is supplied by the raccoon dog (*Nyctereutes procyonoides*) of Japan and north-eastern Asia, which is said by Radde to hibernate in burrows in Amur-

land if food has been sufficiently plentiful in late summer and autumn to enable the animal to lay on enough fat to resist the cold and sustain a long period of fast. If, however, food has been scarce, this dog is compelled to remain active all through the winter. The Arctic fox (*Vulpes lagopus*), although considerably more northern in range than the raccoon dog, does not hibernate. It was long a mystery how these animals obtained food in winter, but it has been ascertained that in some districts they migrate southwards in large numbers in the late autumn, whereas in other districts apparently they lay up stores of dead lemmings or hares, for food during the winter months. In Australia the porcupine ant-eater (*Echidna aculeata*) hibernates; and the habit is retained by specimens imported to Europe if exposed to the cold in outdoor cages.

Instances of quasi-hibernation have been recorded in the case of man. For example, in the government of Pakov in Russia, where food is scarce throughout the year and in danger of exhaustion during the winter, the peasants are said to resort to a practice closely akin to hibernation, spending at least one-half of the cold weather in sleep. From time immemorial it has been the custom when the first snows fall for families to shut themselves up in their huts, huddle round the stove and lapse into slumber, each member taking his turn to keep the fire alight. Once a day only do the inmates rouse themselves from sleep to eat a little dry bread.

Reptiles in which the body-temperature falls with that of the surrounding medium pass the winter in temperate countries in a state of lethargy; and specimens exported from the tropics into northern latitudes become dormant when exposed to cold in virtue of their inability to maintain their temperature at a higher level than that of the atmosphere. The common land tortoise (*Testudo graeca*) of South Europe buries itself in the soil during the winter in its natural habitat, and even when imported to England is able, in some cases at least, to withstand the more rigorous winter by practising the same habit, as Gilbert White originally recorded. In Pennsylvania the box-tortoise (*Cistuda carolina*) passes the winter in a burrow; and *Testudo elegans*, which inhabits dry hilly districts in north India, takes shelter beneath tufts of grass or bushes as the cold weather approaches and remains in a semi-lethargic state until the return of the warmth. The European pond tortoise (*Emys orbicularis*) also hibernates buried in the soil; and the North American salt-water terrapin (*Malacodermys concentrica*), abundant in the salt-marshes round Charleston, S. Carolina, retires into the muddy banks to spend the cold months of the year. In certain parts of the tropics tortoises protect themselves from the excessive heat by burrowing into the soil which afterwards becomes indurated. When drought sets in with the dry season and the tanks become exhausted and food unobtainable, crocodiles and alligators sometimes wander across country in search of water, but more commonly bury themselves in the mud and remain in a state of quiescence until the return of the rains; and according to Humboldt, large snakes, anacondas or boa constrictors are often found by the Indians in South America buried in the same lethargic state. Snakes and lizards in all countries where there is any considerable seasonal variation in temperature become dormant or semi-dormant during the colder months.

Batrachians, like reptiles, hibernate in Europe and other countries situated in temperate latitudes. Frogs bury themselves in the mud at the bottom of tanks and ponds, often congregating in numbers in the same spot. Toads retire to burrows or other secluded places on the land, and newts either bury themselves in the mud of ponds, like frogs, or lie up beneath stones and pieces of wood on the land. According to Mr G. A. Boulenger, however, European frogs and toads do not pass the winter in profound torpor, but merely in a state of sluggish quiescence. In tropical countries, where wet and dry seasons alternate, frogs which, like the rest of the batrachians, are for the most part intolerant of great heat, especially when accompanied by dryness of atmosphere, bury themselves deep in the soil during the time of drought and emerge from their retreats in numbers with the breaking of the rains.

This habit of passing the dry season in the hardened mud forming the bottom of exhausted pools and rivers is practised by several species of tropical freshwater fishes, belonging principally to the family *Siluridae*. The members of this group are able to exist and thrive in moist mud, and can even support life for a comparatively long time out of water altogether. The instinct is exhibited by species occurring both in the eastern and western hemispheres, as is shown by its record in the case of species of *Callichthys* and *Loricaria* in Guiana and by *Clarias lazera* in Senegambia. It is also met with, according to Tennent, in a species of climbing perch (*Anabas oligolepis*) found in Ceylon and belonging to the family *Anabantidae*, all the species of which are able to live for a certain length of time out of water, and may sometimes be found crawling across land in search of fresh pools. The habit is also common to some species of mud fishes of the order Dipneusti, in which the air bladder plays the part of lungs. *Protopterus*, from tropical Africa, for instance, burrows into the mud and remains for nearly half the year coiled up at the bottom in a slightly enlarged chamber. The walls of this are lined with a layer of slime secreted from the fish's skin, and the orifice is closed with a lid the centre of which is perforated and forms an intumed tube by means of which air is conducted to the fish's mouth. The aestivating burrow of the Brazilian mudfish (*Lepidosiren*) is similar, except that the lid is perforated with several apertures. The Australian mudfish (*Ceratodus*) is not known to hibernate or aestivate.

In countries where winter frosts arrest the growth of vegetation terrestrial mollusca seek hibernacula beneath stones or fallen tree trunks, in rock crannies, holes in walls, in heaps of dead leaves, in moss or under the soil, and remain quiescent until the coming of spring. Amongst pulmonate gastropods, most species of snails (*Helix*, *Clausilia*) close the mouth of the shell at this period with a membranous or calcified plate, the epiphragm. Slugs (*Limax*, *Arion*), on the contrary, lie buried in the earth encysted in a coating of slime. Similarly in the tropics members of this group, such as *Achatina* in tropical Africa and *Orthalicus* in Brazil, aestivate during the dry season, the epiphragm preserving them against desiccation; and examples of two species of *Achatina* from east and west Africa exhibited in the Zoological Gardens in London remained concealed in their shells during the winter, although kept in an artificially warmed house, and resumed their activity in the summer.

Freshwater Pulmonata do not appear to hibernate, such forms as *Limnaea* and *Planorbis* having been frequently seen crawling about beneath the ice of frozen ponds. During periods of drought in England, however, they commonly bury themselves in the mud, a habit which is also practised during the dry season in the tropics by species of Prosobranchiate Gastropods belonging to the genera *Ampullaria*, *Melania* and others, which lie dormant until the first rains rouse them from their lethargy. Freshwater Pelecypoda (*Anodonta*, *Unio*) spend the European winter buried deep in the muddy bottom of ponds and streams.

In cold and temperate latitudes a great majority of insects pass the winter in a dormant state, either in the larval, pupal or imaginal (reproductive) stages. In some the state of hibernation is complete in the sense that although the insects may be roused from their lethargy to the extent of movement by spells of warm weather, they do not leave their hibernacula to feed; in others it is incomplete in the sense that the insects emerge to feed, as in the case of the caterpillar of *Euprepia fuliginosa*, or to take the wing as in the case of the midge *Trichocera hiemalis*. Others again, like *Podura nivalis* and *Boreus hiemalis*, never appear to hibernate, at least in England. The insects which hibernate as larvae belong to those species which pass more than one season in that stage, such as the goat-moth (*Cossus ligniperda*), cockchafer (*Melolontha*), stagbeetles (*Lucanus*) and dragon-flies (*Libellula*), &c.; and to some species which, although they only live a few months in this immature state, are hatched in the autumn or summer and only reach the final stage of growth in the following spring, like the butterflies of the genus *Argynnis* (*paphia*, *aglaia*, &c.) in England. As an

instance of species which survive the winter in the pupal or chrysalis stage may be cited the swallow-tailed butterfly of Europe (*Papilio machaon*); while to the category of species which hibernate as perfect insects belong many of the Coleoptera (Rhynchophora, *Coccinellidae*), &c., as well as some Hemiptera, Hymenoptera, Diptera and Lepidoptera (*Vanessa io*, *urticae*, &c.). In the case of the social Hymenoptera it is only the fertilized queen wasp out of the nest that survives the frost of winter, all the workers dying with the onset of cold in the autumn; the common hive bees (*Apis mellifica*), although they retire to the hive, do not hibernate, the numbers and activity of the individuals within the hive being sufficient to keep up the temperature above soporific point. Ants also remain actively at work underground unless the temperature falls several degrees below zero.

Spiders, like nearly all insects, hibernate in cold temperate latitudes. Burrowing species like trap-door spiders of the family *Ctenizidae* and some species of *Lycosidae* seal the doors of their burrows with silk or close up the orifice with a sheet of that material. Other non-burrowing species, like some species of *Clubionidae* and *Drassidae*, lie up in silken cases attached to the underside of stones or of pieces of loose bark, or buried under dead leaves or concealed in the cracks of walls. Other species, on the contrary, pass the winter in an immature state protected from the cold by the silken cocoon spun by the mother for her eggs before she dies in the late autumn, as in the "garden spider" (*Aranea diadema*). Commonly, however, when the cocoons are later in the making, or the cold weather sets in early, the eggs of this and of allied species do not hatch until the spring; but in either case the young emerge in the warm weather, become adult during the summer and die in the autumn after pairing and oviposition. Some members of this family, nevertheless, like *Zilla x-notata*, which live in the corners of windows, or in outhouses where the habitat affords a certain degree of protection from the cold, may survive the winter in the adult stage and be roused from lethargy by breaks in the weather and tempted by the warmth to spin new webs. Typical members of the Opiliones or harvest spiders, belonging to the family *Phalangidae*, do not hibernate in temperate and more northern latitudes in Europe and America, but perish in the autumn, leaving their eggs buried in the soil to hatch in the succeeding spring. During the early summer, therefore, only immature individuals are found. Other species of this order, belonging to the family *Trogulidae*, spend the winter in a dormant state under stones or buried in the soil. False scorpions (*Pseudoscorpiones*) also hibernate in temperate latitudes, passing the cold months, like many spiders, enclosed in silken cases attached to the underside of stones or loosened pieces of bark. Centipedes and millipedes bury themselves in the earth, or lie up in some secluded shelter such as stones or fallen tree trunks afford during the winter; and in the tropics millipedes lie dormant during seasons of drought.

What is true of the dormant condition of arthropod life in the winter of the northern hemisphere is also true in a general way of that of the southern hemisphere at the same season of the year. This is proved—to mention no other cases—by the observations of Darwin on the hibernation of insects and spiders at Montevideo and Bahia Blanca in South America, and by Distant's account of the paucity of insect life in the winter in South Africa; by his discovery under stones of hibernating semi-torpid Coleoptera and Hemiptera at the end of August in the Transvaal, and of the gradual increase in the numbers of individuals and species of insects in that country as the spring advanced and the dry season came to an end.

BIBLIOGRAPHY.—T. Bell, *A History of British Reptiles (and Amphibians)* (1849); W. T. Blanford, *Fauna of British India: Mammalia* (1889-1891); G. A. Boulenger, *Monograph of the Tailless Batrachians of Europe*, edited by the Ray Society; "Teleostei" in *Cambridge Natural History*, vii. 541-727 (1904); T. W. Bridge, "Dipneusti" in *Cambridge Natural History*, vii. 505-520 (1904); A. H. Cooke, "Mollusca" in *Cambridge Natural History*, iii. 25-27 (1895); T. A. Coward, *P.Z.S.* pp. 829-855 (1906), and pp. 312-324 (1907); C. Darwin, *A Newwashed's*

Voyage Round the World, pp. 97-98 (1907 ed.); W. L. Distant, *A Naturalist in the Transvaal*, ch. iii. (1892); Marshall Hall, "Hibernation," in *Todd's Cyclopaedia of Anatomy and Physiology*, pp. 764-776 (1839) (Bibliography); *Phil. Trans. Roy. Soc.* (1832); John Hunter, *Observations on parts of the Animal Economy* (1837); *Index Catalogue of the Library of the Surgeon-General's Office of the U.S. Army*, vii. (1902), Bibliography relating to physiology of Hibernation; W. Kirby and W. Spence, *An Introduction to Entomology*, ed. 17, pp. 517-533 (1856); L. Landois, *A Text-book of Human Physiology*, translated by W. Stirling, i. 410 (1904); V. Laporte, "Suspension of Vitality in Animals," *Pop. Sci. Monthly*, xxxvi. 257-259 (New York, 1889-1890); Mangili, "Essai sur la lithargie périodique," *Annales du Muséum*, x. 453-456 (1807); C. Hart Merriam, *North American Pocket Mice* (Washington, 1889); W. Miller, "Hibernation and Allied States in Animals," *Trans. Pan-Amer. Med. Congr.* (1893), pt. ii. pp. 1274-1285 (Washington, 1895); M. S. Pembrey and A. G. Pitts, "The Relation between the Internal Temperature and the Respiratory Movements of Hibernating Animals," *Journ. Physiol.* (London, 1899), pp. 305-316; Prunelle, "Recherches sur les phénomènes et sur les causes du sommeil hivernal," *Annales du Muséum*, xviii.; J. A. Saisay, *Recherches sur les animaux hivernans* (1808); L. Spallanzani, *Mémoires sur la respiration* (1803); J. Emerson Tennent, *Sketches of the Natural History of Ceylon*, pp. 351-358 (1861); Volkov, "Le Sommeil hivernal chez les paysans russes," *Bull. Mem. Soc. Anthropol.* (Paris, 1900), i. 67; abstract in *Brit. Med. Journ.* (1900), i. 1554. (R. I. P.)

HIBERNIA, in ancient geography, one of the names by which Ireland was known to Greek and Roman writers. Other names were Ierne, Iuverna, Iberio. All these are adaptations of a stem from which also Erin is descended. The island was well known to the Romans through the reports of traders, so far at least as its coasts. But it never became part of the Roman empire. Agricola (about A.D. 80) planned its conquest, which he judged an easy task, but the Roman government vetoed the enterprise. During the Roman occupation of Britain, Irish pirates seem to have been an intermittent nuisance, and Irish emigrants may have settled occasionally in Wales; the best attested emigration is that of the Scots into Caledonia. It was only in post-Roman days that Roman civilization, brought perhaps by Christian missionaries like Patrick, entered the island.

HICKERINGILL (or **HICKORNGILL**), **EDMUND** (1631-1708), English divine, lived an eventful life in the days of the Commonwealth and the Restoration. After graduating at Caius College, Cambridge, where he was junior fellow in 1651-1652, he joined Lilburne's regiment as chaplain, and afterwards served in the ranks in Scotland and in the Swedish service, ultimately becoming a captain in Fleetwood's regiment. He then lived for a time in Jamaica, of which he published an account in 1661. In the same year he was ordained by Robert Sanderson, bishop of Lincoln, having already passed through such shades of belief as are connoted by the terms Baptist, Quaker and Deist. From 1662 until his death in 1708 he was vicar of All Saints', Colchester. He was a vigorous pamphleteer, and came into collision with Henry Compton, bishop of London, to whom he had to pay heavy damages for slander in 1682. He made a public recantation in 1684, was excluded from his living in 1685-1688, and ended his career by being convicted for forgery in 1707.

HICKES, **GEORGE** (1642-1715), English divine and scholar, was born at Newsham near Thirsk, Yorkshire, on the 20th of June 1642. In 1659 he entered St John's College, Oxford, whence after the Restoration he removed to Magdalen College and then to Magdalen Hall. In 1664 he was elected fellow of Lincoln College, and in the following year proceeded M.A. In 1673 he graduated in divinity, and in 1675 he was appointed rector of St Ebbe's, Oxford. In 1676, as private chaplain, he accompanied the duke of Lauderdale, the royal commissioner, to Scotland, and shortly afterwards received the degree of D.D. from St Andrews. In 1680 he became vicar of All Hallows, Barking, London; and after having been made chaplain to the king in 1681, he was in 1683 promoted to the deanery of Worcester. He opposed both James II.'s declaration of indulgence and Monmouth's rising, and he tried in vain to save from death his nonconformist brother John Hickes (1633-1685), one of the Sedgemoor refugees harboured by Alice Lisle. At the revolution of 1688, having declined to take the oath of allegiance, Hickes was first suspended and afterwards deprived of his

deanery. When he heard of the appointment of a successor he affixed to the cathedral doors a "protestation and claim of right." After remaining some time in concealment in London, he was sent by Sancroft and the other nonjurors to James II. in France on matters connected with the continuance of their episcopal succession; upon his return in 1694 he was himself consecrated suffragan bishop of Thetford. His later years were largely occupied in controversies and in writing, while in 1713 he persuaded two Scottish bishops, James Gadderar and Archibald Campbell, to assist him in consecrating Jeremy Collier, Samuel Hawes and Nathaniel Spinckes as bishops among the nonjurors. He died on the 15th of December 1715.

The chief writings of Hickes are the *Institutiones Grammaticae Anglo-Saxonicae ad Moeso-Gothicae* (1689), and *Linguarum veterum Septentrionalium Thesaurus grammatico-criticus et archaeologicus* (1703-1705), a work of great learning and industry.

Apart from these two works Hickes was a voluminous and laborious author. His earliest writings, which were anonymous, were suggested by contemporary events in Scotland that gave him great satisfaction—the execution of James Mitchell on a charge of having attempted to murder Archbishop Sharp, and that of John Kid and John King, Presbyterian ministers, "for high treason and rebellion" (*Ravillac Redivivus*, 1678; *The Spirit of Popery speaking out of the Mouths of Phanatical Protestants*, 1680). In his *Jovian* (an answer to S. Johnson's *Julian the Apostate*, 1683), he endeavoured to show that the Roman empire was not hereditary, and that the Christians under Julian had recognized the duty of passive obedience. His two treatises, one *Of the Christian Priesthood* and the other *Of the Dignity of the Episcopal Order*, originally published in 1707, have been more than once reprinted, and form three volumes of the *Library of Anglo-Catholic Theology* (1847). In 1705 and 1710 were published *Collections of Controversial Letters*, in 1711 a collection of *Sermons*, and in 1726 a volume of *Posthumous Discourses*. Other treatises, such as the *Apologetical Vindication of the Church of England*, are to be met with in Edmund Gibson's *Preservative against Popery*. There is a manuscript in the Bodleian Library which sketches his life to the year 1689, and many of his letters are extant in various collections. A posthumous publication of his *The Constitution of the Catholic Church and the Nature and Consequences of Schism* (1716) gave rise to the celebrated Bangorian controversy.

See the article by the Rev. W. D. Macray in the *Dictionary of National Biography*, vol. xxvi. (1891); and J. H. Overton, *The Nonjurors* (1902).

HICKOK, **LAURENS PERSEUS** (1798-1888), American philosopher and divine, was born at Bethel, Connecticut, on the 29th of December 1798. He took his degree at Union College in 1820. Until 1836 he was occupied in active pastoral work, and was then appointed professor of theology at the Western Reserve College, Ohio, and later (1844-1852) at the Auburn (N.Y.) Theological Seminary. From this post he was elected vice-president of Union College and professor of mental and moral science. In 1866 he succeeded Dr E. Nott as president, but in July 1868 retired to Amherst, Massachusetts, where he devoted himself to writing and study. A collected edition of his principal works was published at Boston in 1875. He died at Amherst on the 7th of May 1888. He wrote *Rational Psychology* (1848), *System of Moral Science* (1853), *Empirical Psychology* (1854), *Rational Cosmology* (1858), *Creator and Creation, or the Knowledge in the Reason of God and His Work* (1872), *Humanity Immortal* (1872), *Logic of Reason* (1874).

HICKORY, a shortened form of the American Indian name *pohickery*. Hickory trees are natives of North America, and belong to the genus *Carya*. They are closely allied to the walnuts (*Juglans*), the chief or at least one very obvious difference being that, whilst in *Carya* the husk which covers the shell of the nut separates into four valves, in *Juglans* it consists of but one piece, which bursts irregularly. The timber is both strong and heavy, and remarkable for its extreme elasticity, but it decays rapidly when exposed to heat and moisture, and is peculiarly subject to the attacks of worms. It is very extensively employed in manufacturing musket stocks, axle-trees, screws, rake teeth, the bows of yokes, the wooden rings used on the rigging of vessels, chair-backs, axe-handles, whip-handles and other purposes requiring great strength and elasticity. Its principal use in America is for hoop-making; and it is the only American wood found perfectly fit for that purpose.

The wood of the hickory is of great value as fuel, on account of the brilliancy with which it burns and the ardent heat which it

gives out, the charcoal being heavy, compact and long-lived. The species which furnish the best wood are *Carya alba* (shell-bark hickory), *C. tomentosa* (mockernut), *C. olivaeformis* (pecan or pacane nut), and *C. porcina* (pig-nut), that of the last named, on account of its extreme tenacity, being preferred for axle-trees



FIG. 1.—Shell-bark Hickory (*Carya alba*) in flower.

and axle-handles. The wood of *C. alba* splits very easily and is very elastic, so that it is much used for making whip-handles and baskets. The wood of this species is also used in the neighbourhood of New York and Philadelphia for making the back bows of Windsor chairs. The timber of *C. amara* and *C. aquatica* is considered of inferior quality.

Most of the hickories form fine-looking noble trees of from 60 to 90 ft. in height, with straight, symmetrical trunks, well-balanced ample heads, and bold, handsome, pinnated foliage. When confined in the forest they shoot up 50 to 60 ft. without branches, but when standing alone they expand into a fine head, and produce a lofty round-headed pyramid of foliage. They have all the qualities necessary to constitute fine graceful park trees. The most ornamental of the species are *C. olivaeformis*, *C. alba* and *C. porcina*, the last two also producing delicious nuts, and being worthy of cultivation for their fruit alone.

The husk of the hickory nut, as already stated, breaks up into four equal valves or separates into four equal portions in the upper part, while the nut itself is tolerably even on the surface, but has four or more blunt angles in its transverse outline. The

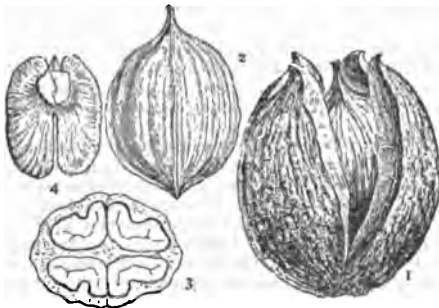

FIG. 2.—1, Fruit of *Carya alba*; 2, Hickory Nut; 3, Cross Section of Nut; 4, Vertical Section of the Seed.

hickory nuts of the American markets are the produce of *C. alba*, called the shell-bark hickory because of the roughness of its bark, which becomes loosened from the trunk in long scales bending outwards at the extremities and adhering only by the middle. The nuts are much esteemed in all parts of the States, and are exported in considerable quantities to Europe. The pecan-nuts,

which come from the Western States, are from 1 in. to 1½ in. long, smooth, cylindrical, pointed at the ends and thin-shelled, with the kernels full, not like those of most of the hickories divided by partitions, and of delicate and agreeable flavour. The thick-shelled fruits of the pig-nut are generally left on the ground for swine, squirrels, &c., to devour. In *C. amara* the kernel is so bitter that even squirrels refuse to eat it.

HICKS, ELIAS (1748-1830), American Quaker, was born in Hempstead township, Long Island, on the 19th of March 1748. His parents were Friends, but he took little interest in religion until he was about twenty; soon after that time he gave up the carpenter's trade, to which he had been apprenticed when seventeen, and became a farmer. By 1775 he had "openings leading to the ministry" and was "deeply engaged for the right administration of discipline and order in the church," and in 1779 he first set out on his itinerant preaching tours between Vermont and Maryland. He attacked slavery, even when preaching in Maryland; wrote *Observations on the Slavery of the Africans and their Descendants* (1811); and was influential in procuring the passage (in 1817) of the act declaring free after 1827 all negroes born in New York and not freed by the Act of 1799. He died at Jericho, Long Island, on the 27th of February 1830. His preaching was practical rather than doctrinal and he was heartily opposed to any set creed; hence his successful opposition at the Baltimore yearly meeting of 1817 to the proposed creed which would make the Society in America approach the position of the English Friends by definite doctrinal statements. His *Doctrinal Epistle* (1824) stated his position, and a break ensued in 1827-1828, Hicks's followers, who call themselves the "Liberal Branch," being called "Hicksites" by the "Orthodox" party, which they for a time outnumbered. The village of Hicksville, in Nassau County, New York, 15 m. E. of Jamaica, lies in the centre of the Quaker district of Long Island and was named in honour of Elias Hicks.

See *A Series of Extemporaneous Discourses . . . by Elias Hicks* (Philadelphia, 1825); *The Journal of the Life and Labors of Elias Hicks* (Philadelphia, 1828), and his *Letters* (Philadelphia, 1834).

HICKS, HENRY (1837-1899), British physician and geologist, was born on the 26th of May 1837 at St David's, in Pembrokeshire, where his father, Thomas Hicks, was a surgeon. He studied medicine at Guy's Hospital, London, qualifying as M.R.C.S. in 1862. Returning to his native place he commenced a practice which he continued until 1871, when he removed to Hendon. He then devoted special attention to mental diseases, took the degree of M.D. at St Andrews in 1878, and continued his medical work until the close of his life. In Wales he had been attracted to geology by J. W. Salter (then palaeontologist to the Geological Survey), and his leisure time was given to the study of the older rocks and fossils of South Wales. In conjunction with Salter, he established in 1865 the Menevian group (Middle Cambrian) characterized by the trilobite *Paradoxides*. Subsequently Hicks contributed a series of important papers on the Cambrian and Lower Silurian rocks, and figured and described many new species of fossils. Later he worked at the Pre-Cambrian rocks of St David's, describing the Dimetias (granitoid rock) and the Pebidian (volcanic series), and his views, though contested, have been generally accepted. At Hendon Dr Hicks gave much attention to the local geology and also to the Pleistocene deposits of the Denbighshire caves. For a few years before his death he had laboured at the Devonian rocks. With his keen eye for fossils he detected organic remains in the Morte slates, previously regarded as unfossiliferous, and these he regarded as including representatives of Lower Devonian and Silurian. His papers were mostly published in the *Geol. Mag.* and *Quart. Journ. Geol. Soc.* He was elected F.R.S. in 1885, and president of the Geological Society of London 1896-1898. He died at Hendon on the 16th of November 1899.

HICKS, WILLIAM (1830-1883), British soldier, entered the Bombay army in 1849, and served through the Indian mutiny, being mentioned in despatches for good conduct at the action of Sitka Ghaut in 1859. In 1861 he became captain, and in the

Abyssinian expedition of 1807-68 was a brigade major, being again mentioned in despatches and given a brevet majority. He retired with the honorary rank of colonel in 1880. After the close of the Egyptian war of 1882, he entered the khedive's service and was made a pasha. Early in 1883 he went to Khartum as chief of the staff of the army there, then commanded by Suliman Niazî Pasha. Camp was formed at Omdurman and a new force of some 8000 fighting men collected—mostly recruited from the fellahin of Arabi's disbanded troops, sent in chains from Egypt. After a month's vigorous drilling Hicks led 5000 of his men against an equal force of dervishes in Sennar, whom he defeated, and cleared the country between the towns of Sennar and Khartum of rebels. Relieved of the fear of an immediate attack by the mahdists the Egyptian officials at Khartum intrigued against Hicks, who in July tendered his resignation. This resulted in the dismissal of Suliman Niazî and the appointment of Hicks as commander-in-chief of an expeditionary force to Kordofan with orders to crush the mahdi, who in January 1883 had captured El Obeid, the capital of that province. Hicks, aware of the worthlessness of his force for the purpose contemplated, stated his opinion that it would be best to "wait for Kordofan to settle itself" (telegram of the 9th of August). The Egyptian ministry, however, did not then believe in the power of the mahdi, and the expedition started from Khartum on the 9th of September. It was made up of 7000 infantry, 1000 cavalry and 2000 camp followers and included thirteen Europeans. On the 20th the force left the Nile at Duem and struck inland across the almost waterless wastes of Kordofan for Obeid. On the 5th of November the army, misled by treacherous guides and thirst-stricken, was ambuscaded in dense forest at Kashgil, 30 m. south of Obeid. With the exception of some 300 men the whole force was killed. According to the story of Hicks's cook, one of the survivors, the general was the last officer to fall, pierced by the spear of the khalifa Mahammed Sherif. After emptying his revolver the pasha kept his assailants at bay for some time with his sword, a body of Baggara who fled before him being known afterwards as "Baggara Hicks" (the cows driven by Hicks), a play on the words *baggara* and *baggar*, the former being the herdsmen and the latter the cows. Hicks's head was cut off and taken to the mahdi.

See *Mahdism and the Egyptian Sudan*, book iv., by Sir F. R. Wingate (London, 1891), and *With Hicks Pasha in the Sudan*, by J. Colborne (London, 1884). Also *Egypt: Military Operations*.

HIDALGO, an inland state of Mexico, bounded N. by San Luis Potosi and Vera Cruz, E. by Vera Cruz and Puebla, S. by Tlaxcala and Mexico (state), and W. by Querétaro. Pop. (1895) 551,817, (1900) 605,051. Area, 8917 sq. m. The northern and eastern parts are elevated and mountainous, culminating in the Cerro de Navajas (10,528 ft.). A considerable area of this region on the eastern side of the state is arid and semibarren, being part of the elevated tableland of Apam where the *maguey* (American aloe) has been grown for centuries. The southern and western parts of the state consist of rolling plains, in the midst of which is the large lake of Metziltlan. Hidalgo produces cereals in the more elevated districts, sugar, maguey, coffee, beans, cotton and tobacco. Maguey is cultivated for the production of *pulque*, the national drink. The chief industry; however, is mining, the mineral districts of Pachuca, El Chico, Real del Monte, San José del Oro, and Zimapán being among the richest in Mexico. The mineral products include silver, gold, mercury, copper, iron, lead, zinc, antimony, manganese and plumbago. Coal, marble and opals are also found. Railway facilities are afforded by a branch of the Vera Cruz and Mexico line, which runs from Ometusco to Pachuca, the capital of the state, and by the Mexican Central. Among the principal towns are Tulancingo (pop. 9037), a rich mining centre 24 m. E. of Pachuca, Ixmiquilpán (about 9000) with silver mines 80 m. N. by W. of the Federal Capital, and Actópan (2666), the chief town of the district N.N.W. of Pachuca, inhabited principally by Indians of the Otomian nation.

HIDALGO (a Spanish word, contracted from *hijo de algo* or *hijo de algo*, son of something, or somewhat), originally a Spanish title of the lower nobility; the *hidalgo* being the lowest grade of nobility which was entitled to use the prefix "don." The term is now used generally to denote one of gentle birth. The Portuguese *fidalgos* has a similar history and meaning.

HIDALGO Y COSTILLA, MIGUEL (1753-1811), Mexican patriot, was born on the 8th of May 1753, on a farm at Corralcjos, near Guanajuato. His mother's maiden name was Gallaga, but contrary to the usual custom of the Spaniards he used only the surname of his father, Cristóbal Hidalgo y Costilla. He was educated at Valladolid in Mexico, and was ordained priest in 1779. Until 1809 he was known only as a man of pious life who exerted himself to introduce various forms of industry, including the cultivation of silk, among his parishioners at Dolores. But Napoleon's invasion of Spain in 1808 caused a widespread commotion. The colonists were indisposed to accept a French ruler and showed great zeal in proclaiming Ferdinand VII. as king. The societies they formed for their professedly loyal purpose were regarded, however, by the Spanish authorities with suspicion as being designed to prepare the independence of Mexico. Hidalgo and several of his friends, among whom was Miguel Domínguez, mayor of Querétaro, engaged in consultation and preparations which the authorities considered treasonable. Domínguez was arrested, but Hidalgo was warned in time. He collected some hundred of his parishioners, and on the 16th of September 1810 they seized the prison at Dolores. This action began what was in fact a revolt against the Spanish and Creole elements of the population. With what is known as the "*grito*" or cry of Dolores as their rallying shout, a multitude gathered round Hidalgo, who took for his banner a wonder-working picture of the Virgin belonging to a popular shrine. At first he met with some success. A regiment of dragoons of the militia joined him, and some small posts were stormed. The whole tumultuous host moved on the city of Mexico. But here the Spaniards and Creoles were concentrated. Hidalgo lost heart and retreated. Many of his followers deserted; and on the march to Querétaro he was attacked at Aculco by General Félix Calleja on the 7th of November 1810, and routed. He endeavoured to continue the struggle, and did succeed in collecting a mob estimated at 100,000 about Guadaluajara. With this ill-armed and undisciplined crowd he took up a position on the bridge of Calderon on the river Santiago. On the 17th of January 1811 he was completely beaten by Calleja and a small force of soldiers. Hidalgo was deposed by the other leaders, and soon afterwards all of them were betrayed to the Spaniards. They were tried at Chihuahua, and condemned. Hidalgo was first degraded from the priesthood and then shot as a rebel, on the 31st of July or the 1st of August 1811.

See H. H. Bancroft, *The Pacific States*, vol. vii., which contains a copious bibliography.

HIDDENITE, a green transparent variety of spodumene, (*g.v.*) used as a gem-stone. It was discovered by William E. Hidden (b. 1853) about 1879 at Stonypoint, Alexander county, North Carolina, and was at first taken for diopside. In 1881 J. Lawrence Smith proved it to be spodumene, and named it. Hiddenite occurs in small slender monoclinic crystals of prismatic habit, often pitted on the surface. A well-marked prismatic cleavage renders the mineral rather difficult to cut. Its colour passes from an emerald green to a greenish-yellow, and is often unevenly distributed through the stone. The mineral is dichroic in a marked degree, and shows much "fire" when properly cut. The composition of the mineral is represented by the formula $\text{LiAl}(\text{SiO}_3)_2$, the green colour being probably due to the presence of a small proportion of chromium. The presence of lithium in this green mineral suggested the inappropriate name of lithia emerald, by which it is sometimes known. Hiddenite was originally found as loose crystals in the soil, but was afterwards worked in a veinstone, where it occurred in association with beryl, quartz, garnet, mica, rutile, &c.

HIDE¹ (Lat. *hida*, A.-S. *higd*, *hid* or *hwiisc*, members of a household), a measure of land. The word was in general use in England in Anglo-Saxon and early English times, although its meaning seems to have varied somewhat from time to time. Among its Latin equivalents are *terra unius familiae*, *terra unius cassati* and *mansio*; the first of these forms is used by Bede, who, like all early writers, gives to it no definite area. In its earliest form the hide was the typical holding of the typical family. Gradually, this typical holding came to be regarded as containing 120 "acres" (not 120 acres of 4840 sq. yds. each, but 120 times the amount of land which a ploughteam of eight oxen could plough in a single day). This definition appears to have been very general in England before the Norman Conquest, and in Domesday Book 30, 40, 50 and 80 acres are repeatedly mentioned as fractions of a hide. Some historians, however, have thought that the hide only contained 30 acres or thereabouts.

"The question about the hide," says Professor Maitland in *Domesday Book and Beyond*, "is pre-judicial to all the great questions of early English history." The main argument employed by J. M. Kemble (*The Saxons in England*) in favour of the "small" hide is that the number of hides stated to have existed in the various parts of England gives an acreage far in excess of the total acreage of these parts, making due allowance for pasture and for woodland, an allowance necessary because the hide was only that part of the land which came under the plough, and each hide must have carried with it a certain amount of pasture. Two illustrations in support of Kemble's theory must suffice. Bede says the Isle of Wight contained 1200 hides. Now 1200 hides of 120 acres each gives a total acreage of 144,000 acres, while the total acreage of the island to-day is only 93,000 acres. Again a document called *The Tribal Hidage* puts the number of hides in the whole of England at nearly a quarter of a million. This gives in acres a figure about equal to the total acreage of England at the present time, but it leaves no room for pasture and for the great proportion of land which was still woodland. On these grounds Kemble regarded the hide as containing 30 or 33, certainly not more than 40 acres, and thought that each acre contained about 4000 sq. yds., i.e. that it was roughly equal to the modern acre. Another argument brought forward is that 30 or 40 acres was enough land for the support of the average family. In other words that it was the *terra unius familiae* of Bede. Another Domesday student, R. W. Eytton, puts down the hide at 48 acres.

But formidable arguments have been advanced against the "small" hide. There is no doubt that at the time of Domesday the hide was equated with 120 and not with 30 acres. Then, taking the word *familia* in its proper sense, a household with many dependent members, and making an allowance for primitive methods of agriculture, it is questionable whether 30 or 40 acres were sufficient for its support; and again if the equation 1 hide = 120 acres is rejected there is no serious evidence in favour of any other. A possible explanation is that, although in early Anglo-Saxon times the hide consisted of 30 acres or thereabouts, it had come before the time of Domesday to contain 120 acres. But no trace of such change can be found; there is no break in the continuity of the land-charters which refer to hides and manseas. Reviewing the whole question Professor Maitland accepts the view that the hide contained 120 acres. The difficulties are serious but they are not insuperable. Bede, writing in a primitive age and speaking for the most part of lands far away from Northumbria, uses figures in a vague and general fashion; then the hide of 120 acres does not mean 120 times 4840 yds., it means much less; and lastly at the time of Domesday the hide was not a unit of measurement, it was a unit for purposes of taxation. On the other hand, Mr. H. M. Chadwick (*Studies on Anglo-Saxon Institutions*) says there is no evidence that the hide contained 120 acres before the 10th century. He suggests that possibly the size of the hide in Mercia may have been fixed at 40 acres, while in Wessex it was regarded as containing 120 acres. Dr. Stubbs (*Const. Hist.* i.) suggests that the confusion may have arisen because the word was used "to express the whole share of one man in all the fields of the village." Thus it might refer to 30 acres, his share in one field, or to 120 acres, his share in the four fields. He adds, however, that this explanation is not adequate for all cases. But these differences about the size of the hide are not peculiar to modern times. Henry of Huntingdon says, *Hida Anglica vocatur terra unius aratri culturae sufficiens per annum*, while the

Dialogus de scaccario puts its size at 100 acres, though this may be the long hundred, or 120. Perhaps, therefore, Selden is wisest when he says, "hides were of an uncertain quantity." Certainly he gives a very good description of the early hide when he says (*Tiles of Honour*): "Now a hide of land regularly is and was (as I think) as much land as might be well manured with one plough, together with pasture, meadow and wood competent for the maintenance of that plough, and the servants of the family." The view that the size of the hide varied from district to district is borne out by Professor Vinogradoff's more recent researches. In his *English Society in the Eleventh Century* he mentions that there was a hide of 48 acres in Wiltshire and one of 40 acres in Dorset. In addition some authorities distinguish between English hides and Welsh hides, and in Sussex the hide often contained 8 virgates. Sometimes again in the 11th century hides were not merely fiscal units; they were shares in the land itself.

The fact that the hide was a unit of assessment, has been established by Mr. J. H. Round in his *Feudal England*, and is regarded as throwing a most valuable light upon the many problems which present themselves to the student of Domesday. The process which converted the hide from a unit of measurement to a unit for assessment purposes is probably as follows. Being in general use to denote a large piece of land, and such pieces of land being roughly equal all over England, the hide was a useful unit on which to levy taxation, a use which dates doubtless from the time of the Danegeld. For some time the two meanings were used side by side, but before the Norman Conquest the hide, a unit for taxation, had quite supplanted the hide, a measure of land, and this was the state of affairs when in 1086 William I. ordered his great inquest to be made. The formula used in Domesday varies from county to county, but a single illustration may be given. *Huntingdon Burg defendentes so ad geldum regis pro quarta parte de Hyrtingestan hundred pro L. hidis*. This does not mean that the town of Huntingdon contained a certain fixed number of square yards multiplied by 50, but that for purposes of taxation Huntingdon was regarded as worth 50 times a certain fiscal unit.

This view of the nature of the hide was hinted at by R. W. Eytton in *A Key to Domesday* and was accepted by Maitland. Its proof rests primarily upon the prevalence of the five-hide unit. By collating various documents which formed part of the Domesday inquest Mr. Round has brought together for certain parts of England, especially for Cambridgeshire and Bedfordshire, the holdings of the various lords in the different villas, and vill after vill shows a total of 5 hides or 10 hides or only a slight discrepancy therefrom. A similar result is shown for the hundreds where multiples of 5 are almost universal, and the total hidage for the county of Worcester is very near the round figure of 1200. This arrangement is obviously artificial; it must have been imposed upon the counties or the hundreds by the central authority and then divided among the villas. Another proof is found in what is called "beneficial hidage." It is shown that in certain cases the number of hides in a hundred has been reduced since the time of Edward the Confessor, and that this reduction had been transferred *pro rata* to the villas in the hundred. Thus Mr. Round concludes that the hide was fixed "independently of area or value." Some slight criticism has been directed against the idea of "artificial hidage," but the most that can be said against it is that its proof rests upon isolated cases, a reproach which further research will doubtless remove. However, Professor Vinogradoff accepts the hide primarily as a fiscal unit "which corresponds only in a very rough way to the agrarian reality," and Maitland says the fiscal hide is "at its best a lame compromise between a unit of area and a unit of value."

What is the origin of the five-hide unit? Various conjectures have been hazarded, and the unit is undoubtedly older than the Danegeld. Rejecting the idea that it is of Roman or of British origin, and pointing to the serious difference in the rates at which the various counties were assessed, Mr. Round thinks that it dates from the time when the various Anglo-Saxon kingdoms were independent. Possibly it was the unit of assessment for military service, possibly it was the recognized endowment of a Saxon thegn. In Anglo-Saxon times a man's standing in society was dependent to a great extent upon the number of hides which he possessed; this statement is fully proved from the laws. Moreover, in the laws of the Wessex king, Ine, the value of a man's oath is expressed in hides, the oath for a king's thegn being probably worth 60 hides and that of a ceorl 5 hides.

The usual division of the hide was into virgates, a virgate being, after the Conquest at least, the normal holding of the

¹The homonym "hide," meaning to conceal, is in O. Eng. *hidan*; the word appears in various forms in Old Teutonic languages. The root is probably seen in Gr. *kathidion* to hide, or may be the same as in "hide," skin. O. Eng. *hgd*, which is also seen in Ger. *haut*, Dutch *huid*; the root appears in Lat. *cutis*, Gr. *skoron*; The Indo-European root *ks-*, weakened form of *skw-*, seen in "sky," and meaning "to cover," may be the ultimate source of both words. The slang use of "to hide," to flog or whip, means "to take the skin off, to flay."

villen with two osea. Mr Round holds that in Domesday at all events the hide always consisted of four virgates; Mr F. Seebohm in *The English Village Community*, although thinking that the normal hide "consisted as a rule of four virgates of 30 acres each," says that the Hundred Rolls for Huntingdonshire show that "the hide did not always contain the same number of virgates." The virgate, it may be noted, consisted of a strip of land in each acre of the hide, and there is undoubtedly a strong case in favour of the equation 1 hide = 4 virgates.

Mr Seebohm, propounding his theory that English institutions are rooted in those of Rome, argues for some resemblance between the methods of taxation of land in Rome and in England; he sees some connexion between the Roman *centuria* and the hide, and between the Roman system of taxation called *jugatio* and the English hidage. Professor Vinogradoff (*Villainage in England*) summarizes the views of those who hold a contrary opinion thus: "The curious fact that the normal holding, the hide, was equal all over England can be explained only by its origin; it came full-formed from Germany and remained unchanged in spite of all diversities of geographical and economical conditions."

In the Danish parts of England, or rather in the district of the "Five Boroughs," the carucate takes the place of the hide as the unit of value, and six supplants five, six carucates being the unit of assessment. In Leicestershire and in part of Lancashire the hide is quite different from what it is elsewhere in England. According to Mr Round the Leicestershire hide consisted of 18 carucates; Mr W. H. Stevenson (*English Historical Review*, vol. v.) argues that it contained only 12 and that it was a hundred and not a hide. Mr Seebohm thinks there was a *solanda* or double hide of 240 acres in Essex and other southern counties, but Mr Round does not think that this word refers to a measure or unit of assessment at all. For Kent, however, the word *sullung* or *solin*, is used in *Domesday Book* and in the charters instead of hide and carucate as elsewhere, and Vinogradoff thinks that this contained from 180 to 200 acres.

Under the Norman and early Plantagenet kings a levy of two or more shillings on each hide of land was a usual and recognized method of raising money, royal and some other estates, however, as is seen from Domesday, not being hidated and not paying the tax. This geld, or tax, received several names, one of the most general being *hidage* (Lat. *hidagium*). "Hidage," says Vinogradoff, "is historically connected with the old English Danegeld system," and as Danegeld and then hidage it was levied long after its original purpose was forgotten, and was during the 11th century "the most sweeping and the heaviest of all the taxes." Henry of Huntingdon says its usual rate was 2s. on each hide of land, and this was evidently the rate at the time of the famous dispute between Henry II. and Becket at Woodstock in 1163, but it was not always kept at this figure, as in 1084 William I. had levied a tax of 6s. on each hide, an unusual extortion. The feudal aids were levied on the hide. Thus in 1109 Henry I. raised one at the rate of 3s. per hide for the marriage of his daughter Matilda with the emperor Henry V., and in 1194, when money was collected for the ransom of Richard I., some of the taxation for this purpose seems to have been assessed according to the hidage given in Domesday Book.

By this time the word hidage as the designation of the tax was disappearing, its place being taken by the word *carucage*. The carucate (Lat. *caruca*, a plough) was a measure of land which prevailed in the north of England, the district inhabited by people of Danish descent. Some authorities regard it as equivalent to the hide, others deny this identity. In 1198, however, when Richard I. imposed a tax of 5s. on each *carucata terrae sive hyda*, the two words were obviously interchangeable, and about the same time the size of the carucate was fixed at 100 acres. The word *carucage* remained in use for some time longer, and then other names were given to the various taxes on land.

One or two other questions with regard to the hide still remain unsolved. What is the connexion, if any, between the hundred and a hundred hides? Again, was the size of the hide fixed at 120 acres to make the work of reckoning the amount of Danegeld, or hidage, a simple process? 120 acres to the hide, 240 pence to the pound, makes calculations easy. Lastly, is the English hide derived from the German *hufe* or *huba*? (A. W. H.)

HIEL, EMMANUEL (1834-1890), Belgian-Dutch poet and prose writer, was born at Dendermonde, in Flanders, in May 1834. He acted in various functions, from teacher and government official to journalist and bookseller, busily writing all the time both for the theatre and the magazines of North and South Netherlands. His last posts were those of librarian at the Industrial Museum and professor of declamation at the Conservatoire in Brussels. Among his better-known poetic works may be cited *Looverkens* ("Leaflets," 1857); *Nieuwe Liedekens* ("New Poems," 1861); *Gedichten* ("Poems," 1863); *Psalmen, Zangen, en Oratorios* ("Psalms, Songs, and Oratorios," 1869); *De Wind* (1869), an inspiring cantata, which had a large measure of success and was crowned; *De Liefde in 't Leven* ("Love in Life," 1870); *Elle and Isa* (two musical dramas; 1874); *Liederen voor Groote en Kleine Kinderen* ("Songs for Big and Small Folk," 1879); *Jakoba van Beveren* ("Jacquettein of Bavaria," a poetic drama, 1880); *Mathilda van Denemarcken* (a lyrical drama, 1890). His collected poetical works were published in three volumes at Rousselaere in 1885. Hiel took an active and prominent part in the so-called "Flemish movement" in Belgium, and his name is constantly associated with those of Jan van Beers, the Willems and Peter Benoit. The last wrote some of his compositions to Hiel's verses, notably his oratorios *Lucifer* (performed in London at the Royal Albert Hall and elsewhere) and *De Schelde* ("The Scheldt"); whilst the Dutch composer, Richard Hol (of Utrecht), composed the music to Hiel's "Ode to Liberty," and van Gheluwe to the poet's "Songs for Big and Small Folk" (second edition, much enlarged, 1879), which has greatly contributed to their popularity in schools and among Belgian choral societies. Hiel also translated several foreign lyrics. His rendering of Tennyson's *Dora* appeared at Antwerp in 1871. For the national festival of 1880 at Brussels, to commemorate the fiftieth anniversary of Belgian independence, Hiel composed two cantatas, *Belgenland* ("The Land of the Belgians") and *Eer Belgenland* ("Honour to Belgium"), which, set to music, were much appreciated. He died at Schaarbeek, near Brussels, on the 27th of August 1890. Hiel's efforts to counteract Walloon influences and bring about a rapprochement between the Netherlanders in the north and the Teutonic racial sympathizers across the Rhine made him very popular with both, and a volume of his best poems was in 1874 the first in a collection of Dutch authors published at Leipzig.

HIEMPSAL, the name of the two kings of Numidia. For Hiempsal I. see under JUGURTHA. Hiempsal II. was the son of Gauda, the half-brother of Jugurtha. In 83 B.C., after the triumph of Sulla, when the younger Marius fled from Rome to Africa, Hiempsal received him with apparent friendliness, his real intention being to detain him as a prisoner. Marius discovered this intention in time and made good his escape with the assistance of the king's daughter. In 81 Hiempsal was driven from his throne by the Numidians themselves, or by Hiabarus, ruler of part of the kingdom, supported by Cn. Domitius Ahenobarbus, the leader of the Marian party in Africa. Soon afterwards Pompey was sent to Africa by Sulla to reinstate Hiempsal, whose territory was subsequently increased by the addition of some land on the coast in accordance with a treaty concluded with L. Aurelius Cotta. When the tribune P. Servilius Rullus introduced his agrarian law (63), these lands, which had been originally assigned to the Roman people by Scipio Africanus, were expressly exempted from sale, which roused the indignation of Cicero (*De lege agraria*, i. 4, ii. 22). From Suetonius (*Caesar*, 71) it is evident that Hiempsal was alive in 62. According to Sallust (*Jugurtha*, 17), he was the author of an historical work in the Punic language.

Plutarch, *Marius*, 40, *Pompey*, 12; Appian, *Bell. civ.*, i. 60, 80; Dio Cassius xli. 41.

HIERAPOLIS. 1. (Arabic *Manbij* or *Mumbij*) an ancient Syrian town occupying one of the finest sites in Northern Syria, in a fertile district about 16 m. S.W. of the confluence of the Sajur and Euphrates. There is abundant water supply from large springs. In 1879, after the Russo-Turkish war, a colony of

Circassians from Vidin (Widdin) was planted in the ruins, and the result has been the constant discovery of antiquities, which find their way into the bazaars of Aleppo and Aintab. The place first appears in Greek as *Bambyce*, but Pliny (v. 23) tells us its Syrian name was *Mabog*. It was doubtless an ancient Commagenian sanctuary; but history knows it first under the Seleucids, who made it the chief station on their main road between Antioch and Seleucia-on-Tigris; and as a centre of the worship of the Syrian Nature Goddess, *Atargatis* (q.v.), it became known to the Greeks as the city of the sanctuary *Ἱερόπολις*, and finally as the Holy City *Ἱερόπολις*. Lucian, a native of Commagene (or some anonymous writer) has immortalized this worship in the tract *De Dea Syria*, wherein are described the orgiastic luxury of the shrine and the tank of sacred fish, of which Aelian also relates marvels. According to the *De Dea Syria*, the worship was of a phallic character, votaries offering little male figures of wood and bronze. There were also huge *phallii* set up like obelisks before the temple, which were climbed once a year with certain ceremonies, and decorated. For the rest the temple was of Ionic character with golden plated doors and roof and much gilt decoration. Inside was a holy chamber into which priests only were allowed to enter. Here were statues of a goddess and a god in gold, but the first seems to have been the more richly decorated with gems and other ornaments. Between them stood a gilt *xoanon*, which seems to have been carried outside in sacred processions. Other rich furniture is described, and a mode of divination by movements of a *xoanon* of Apollo. A great bronze altar stood in front, set about with statues, and in the forecourt lived numerous sacred animals and birds (but not swine) used for sacrifice. Some three hundred priests served the shrine and there were numerous minor ministrants. The lake was the centre of sacred festivities and it was customary for votaries to swim out and decorate an altar standing in the middle of the water. Self-mutilation and other orgies went on in the temple precinct, and there was an elaborate ritual on entering the city and first visiting the shrine under the conduct of local guides, which reminds one of the Meccan Pilgrimage.

The temple was sacked by Crassus on his way to meet the Parthians (53 B. C.); but in the 3rd century of the empire the city was the capital of the Euphratensian province and one of the great cities of Syria. Procopius called it the greatest in that part of the world. It was, however, ruinous when Julian collected his troops there ere marching to his defeat and death in Mesopotamia, and Chosroes I. held it to ransom after Justinian had failed to put it in a state of defence. Harun restored it at the end of the 8th century and it became a bone of contention between Byzantines, Arabs and Turks. The crusaders captured it from the Seljuks in the 12th century, but Saladin retook it (1175), and later it became the headquarters of Hulagu and his Mongols, who completed its ruin. The remains are extensive, but almost wholly of late date, as is to be expected in the case of a city which survived into Moslem times. The walls are Arab, and no ruins of the great temple survive. The most noteworthy relic of antiquity is the sacred lake, on two sides of which can still be seen stepped quays and water-stairs. The first modern account of the site is in a short narrative appended by H. Maundrell to his *Journey from Aleppo to Jerusalem*. He was at Mumbij in 1699.

The coinage of the city begins in the 4th century B.C. with an Aramaic series, showing the goddess, either as a bust with mural crown or as riding on a lion. She continues to supply the chief type even during imperial times, being generally shown seated with the *symposium* in her hand. Other coins substitute the legend *Θεῶς Ζυφίας Ἱερόπολις*, within a wreath. It is interesting to note that from *Bambyce* (near which much silk was produced) were derived the *bombycina vestis* of the Romans and, through the crusaders, the bombazine of modern commerce.

See F. R. Cheaney, *Euphrates Expedition* (1850); W. F. Ainsworth, *Personal Narratives of the Euphrates Expedition* (1858); E. Sachau, *Reise in Syrien*, &c. (1883); D. G. Hogarth in *Journal of Hellenic Studies* (1909).

2. A Phrygian city, altitude 1200 ft. on the right bank of the Chiruk Su (Lycus), about 8 m. above its junction with the

Menderes (Maeander), situated on a broad terrace, 200 ft. above the valley and 6 m. N. of Laodicea. On the terrace rise calcareous springs, that have deposited vast incrustations of snowy whiteness. To these springs, which are warm and slightly sulphurous, and to the "Plutonium"—a hole reaching deep into the earth, from which issued a nephritic vapour—the place owed its celebrity and sanctity. Here, at an early date, a religious establishment (*hieron*) existed in connexion with the old Phrygian Kydrara, a settlement of the tribe Hydrellaiæ; and the town which grew round it became one of the greatest centres of Phrygian native life but of non-political importance. The chief religious festival was the Letoia, named after the goddess Leto, a local variety of the Mother Goddess (Cybele), who was honoured with orgiastic rites in which elements of the original Anatolian matriarchate and Nature-cult survived: there was also a worship of Apollo Lairbenos. Hierapolis was the seat of an early church (Col. iv. 13), with which tradition closely connects the apostle Philip. Epictetus, the philosopher, and Papias, a disciple of St John and author of a lost work on the Sayings of Jesus, were born there. Hierapolis is now easily reached from Gonjeli, a station on the Dincir railway about 7 m. distant. A village of Yuraks has gradually grown below the site. The native name for the place is apparently *Pambuk Kale* (though doubt has been thrown on the statement), and this has always been explained by the cotton-like appearance of the white incrustations. It should be noted, however, that this name, if genuine, is curiously like that given by the Syrians to the Commagenian Hierapolis (above), *Bambyc*, the origin of which it has been suggested was a native name of the goddess Pambë or Mambë (whence *Mabog*). Considering that cotton is a comparatively modern phenomenon in Anatolia, it is worth suggesting that *Pambuk* in this case may be a survival of a primitive name, derived from the same goddess, Pambë. The goddesses of the two Hierapolis were in any case closely akin. If an old native name has reappeared here after the decline of Greek influence, and been given a meaning in modern Turkish, it affords another instance of a very common feature of west Asian nomenclature. Combined with the petrified terraces, the ruins of Hierapolis present the most attractive of the easily accessible spectacles in Asia Minor. They are remarkable for the long avenue of tombs, mostly inscribed sarcophagi on plinths, by which the city is approached from the W., and for a very perfect theatre partly excavated in the hill at the N. side of the site. Stage buildings as well as auditorium are well preserved. On the S., just above the white terraces and largely blocked with petrified deposit, stand large baths, into which the natural warm spring was once conducted. Behind these is a fine triumphal arch, whence runs a colonnade. Ruins of several churches survive, and also of a large basilica. There is a sulphureous pool which may represent the "Plutonium," but it has no such deadly power as was ascribed to that pond. Ramsay thinks that the "Plutonium" was obliterated by Christians in the 4th century. Over 300 inscriptions have been collected, mostly sepulchral, whence Ramsay has deduced interesting facts about the very early Christian community which existed here. The site has been often visited and described, and was systematically examined in 1887 by parties under W. M. Ramsay and K. Humann respectively.

See K. Humann, *Altortümer v. Hierapolis* (1888); Sir W. M. Ramsay, *Cities and Bishoppers of Phrygia*, vol. i. (1895). (C. W. W.; D. G. H.)

HIERARCHY (Gr. *ἱερός*, holy, and *ἀρχή*, to rule), the office of a steward or guardian of holy things, not a "ruler of priests" or "priestly ruler" (see Boeckh, *Corp. inscr. Gr.* No. 1570), a term commonly used in ecclesiastical language to denote the aggregate of those persons who exercise authority within the Christian Church, the patriarchate, episcopate or entire three-fold order of the clergy. The word *ἱεραρχία*, which does not occur in any classical Greek writer, owes its present extensive currency to the celebrated writings of Dionysius Areopagiticus. Of these the most important are the two which treat of the celestial and of the ecclesiastical hierarchy respectively. Defining hierarchy as the "function which comprises all sacred things," or, more fully, as "a sacred order and science and

activity, assimilated as far as possible to the godlike, and elevated to the imitation of God proportionately to the Divine illuminations conceded to it," the author proceeds to enumerate the nine orders of the heavenly host, which are subdivided again into hierarchies or triads, in descending order, thus: Seraphim, Cherubim, Thrones; Dominations, Virtues, Powers; Principalities, Archangels, Angels. These all exist for the common object of raising men through ascending stages of purification and illumination to perfection. The ecclesiastical or earthly hierarchy is the counterpart of the other. In it the first or highest triad is formed by baptism, communion and eucharism. The second triad consists of the three orders of the ministry, bishop or hierarch, priest and minister or deacon (*ἐπίσκοπος, ἱερέας, ἁγιοσύνης*); this is the earliest known instance in which the title hierarch is applied to a bishop. The third or lowest triad is made up of monks, "initiated" and catechumens. To Dionysius may be traced, through Thomas Aquinas and other Catholic writers of the intervening period, the definition of the term, usually given by Roman Catholic writers—"cœtus sui ordō præsidium et sacrorum ministrorum ad regendam ecclesiam gignendamque in hominibus sanctitatem divinitus institutus"¹—although it immediately rests upon the authority of the sixth canon of the twenty-third session of the council of Trent, in which anathema is pronounced upon all who deny the existence within the Catholic Church of a hierarchy instituted by divine appointment, and consisting of bishops, priests and ministers.² (See ORDER, HOLY).

HIERATIC, priestly or sacred (Gr. *ἱερατικός, ἱερός*, sacred), a term particularly applied to a style of ancient Egyptian writing, which is a simplified cursive form of hieroglyphic. The name was first given by Champollion (see EGYPT, § Language).

HIERAX, or **HIERACAS**, a learned ascetic who flourished about the end of the 3rd century at Leontopolis in Egypt, where he lived to the age of ninety, supporting himself by calligraphy and devoting his leisure to scientific and literary pursuits, especially to the study of the Bible. He was the author of Biblical commentaries both in Greek and Coptic, and is said to have composed many hymns. He became leader of the so-called sect of the Hieracites, an ascetic society from which married persons were excluded, and of which one of the leading tenets was that only the celibate could enter the kingdom of heaven. He asserted that the suppression of the sexual impulse was emphatically the new revelation brought by the Logos, and appealed to 1 Cor. vii., Heb. xii. 14, and Matt. xix. 12, xxv. 21. Hierax may be called the connecting link between Origen and the Coptic monks. A man of deep learning and prodigious memory, he seems to have developed Origen's Christology in the direction of Athanasius. He held that the Son was a torch lighted at the torch of the Father, that Father and Son are a bipartite light. He repudiated the ideas of a bodily resurrection and a material paradise, and on the ground of 2 Tim. ii. 5 questioned the salvation of even baptized infants, "for without knowledge no conduct, without conduct no reward." In his insistence on virginity as the specifically Christian virtue he set up the great theme of the church of the 4th and 5th centuries.

HIERO (strictly **HIERON**), the name of two rulers of Syracuse.

HIERO I. was the brother of Gelo, and tyrant of Syracuse from 478 to 467/6 B.C. During his reign he greatly increased the power of Syracuse. He removed the inhabitants of Naxos and Catania to Leontini, peopled Catania (which he renamed Aetna) with Dorians, concluded an alliance with Acragas (Agrigantum), and espoused the cause of the Locrians against Anaxilaus, tyrant of Rhegium. His most important achievement was the defeat of the Etruscans at Cumæ (474), by which he saved the Greeks of Campania. A bronze helmet (now in the British Museum), with an inscription commemorating

the event, was dedicated at Olympia. Though despotic in his rule Hiero was a liberal patron of literature. He died at Catania in 467.

See Diod. Sic. xi. 38-67; Xenophon, *Hiero*, 6. 2; E. Lübber, *Syracus sur Zeit des Gelo und Hieron* (1875); for his coins see NUMISMATICS (section Sicily).

HIERO II., tyrant of Syracuse from 270 to 216 B.C., was the illegitimate son of a Syracusan noble, Hierocles, who claimed descent from Gelo. On the departure of Pyrrhus from Sicily (275) the Syracusan army and citizens appointed him commander of the troops. He materially strengthened his position by marrying the daughter of Leptines, the leading citizen. In the meantime, the Mamertines, a body of Campanian mercenaries who had been employed by Agathocles, had seized the stronghold of Messana, whence they harassed the Syracusans. They were finally defeated in a pitched battle near Mylae by Hiero, who was only prevented from capturing Messana by Carthaginian interference. His grateful countrymen then chose him king (270). In 264 he again returned to the attack, and the Mamertines called in the aid of Rome. Hiero at once joined the Punic leader Hanno, who had recently landed in Sicily; but being defeated by the consul Appius Claudius, he withdrew to Syracuse. Pressed by the Roman forces, in 263 he was compelled to conclude a treaty with Rome, by which he was to rule over the south-east of Sicily and the eastern coast as far as Tauromenium (Polybius i. 8-16; Zonaras viii. 9). From this time till his death in 216 he remained loyal to the Romans, and frequently assisted them with men and provisions during the Punic wars (Livy xxi. 49-51, xxiii. 37, xxiii. 21). He kept up a powerful fleet for defensive purposes, and employed his famous kinsman Archimedes in the construction of those engines that, at a later date, played so important a part during the siege of Syracuse by the Romans.

A picture of the prosperity of Syracuse during his rule is given in the sixteenth idyll of Theocritus, his favourite poet. See Diod. Sic. xxii. 24-xxvi. 24; Polybius i. 8-vii. 7; Justin xxiii. 4.

HIEROCLES, proconsul of Bithynia and Alexandria, lived during the reign of Diocletian (A.D. 284-305). He is said to have been the instigator of the fierce persecution of the Christians under Galerius in 303. He was the author of a work (not extant) entitled *Λόγοι φιλαλήθεις πρὸς τοὺς Χριστιανούς* in two books, in which he endeavoured to persuade the Christians that their sacred books were full of contradictions, and that in moral influence and miraculous power Christ was inferior to Apollonius of Tyana. Our knowledge of this treatise is derived from Lactantius (*Instit. div.* v. 2) and Eusebius, who wrote a refutation entitled *Ἀντιρρητικός πρὸς τὰ Ἱεροκλέους*.

HIEROCLES OF ALEXANDRIA, Neoplatonist writer, flourished c. A.D. 430. He studied under the celebrated Neoplatonist Plutarch at Athens, and taught for some years in his native city. He seems to have been banished from Alexandria and to have taken up his abode in Constantinople, where he gave such offence by his religious opinions that he was thrown into prison and cruelly flogged. The only complete work of his which has been preserved is the commentary on the *Carmina Aurea* of Pythagoras. It enjoyed a great reputation in middle age and Renaissance times, and there are numerous translations in various European languages. Several other writings, especially one on providence and fate, a consolatory treatise dedicated to his patron Olympiodorus of Thebes, author of *ἱστορικὸν Λόγος*, are quoted or referred to by Photius and Stobæus. The collection of some 260 vitiocisms (*ἀσρέτα*) called *Φηλόγος* (ed. A. Eberhard, Berlin, 1866), attributed to Hierocles and Philagrius, has no connexion with Hierocles of Alexandria, but is probably a compilation of later date, founded on two older collections. It is now agreed that the fragments of the *Elements of Ethics* (*Ἠθικὴ στοιχειώσις*) preserved in Stobæus are from a work by a Stoic named Hierocles, contemporary of Epictetus, who has been identified with the "Hierocles Stoicus vir sanctus et gravis" in Aulus Gellius (ix. 5. 8). This theory is confirmed by the discovery of a papyrus (ed. H. von Arnim in *Berliner Klassikerlexikon*, iv. 1906; see also C. Prächter, *Hierocles der Stoiker*, 1901).

¹ Ferrone, *De locis theologicis*, pt. i., sec. i. cap. 2.

² *Sic quis dixerit in ecclesia catholica non esse hierarchiam divina ordinatione institutam, quae constat ex episcopis, presbyteris, et ministris: anathema sit.*

There is an edition of the commentary by F. W. Mullach in *Fragmenta philosophorum Graecorum* (1860), I. 408, including full information concerning Hierocles, the poem and the commentary; see also E. Zeller, *Philosophie der Griechen* (2nd ed.), iii. 2, pp. 681-687; W. Christ, *Geschichte der griechischen Literatur* (1898), pp. 834, 849.

Another Hierocles, who flourished during the reign of Justinian, was the author of a list of provinces and towns in the Eastern Empire, called *Zwölftausend* ("fellow-traveller"; ed. A. Burckhardt, 1893); it was one of the chief authorities used by Constantine Porphyrogenitus in his work on the "themes" of the Roman Empire (see C. Krumbacher, *Geschichte der byzantinischen Literatur*, 1897, p. 417). In Fabricius's *Bibliotheca Graeca* (ed. Harles), I. 791, sixteen persons named Hierocles, chiefly literary, are mentioned.

HIEROGLYPHICS (Gr. *ἱερός*, sacred, and *γλυφή*, carving), the term used by Greek and Latin writers to describe the sacred characters of the ancient Egyptian language in its classical phase. It is now also used for various systems of writing in which figures of objects take the place of conventional signs. Such characters which symbolize the idea of a thing without expressing the name of it are generally styled "ideographs" (Gr. *ἰδέα*, idea, and *γράφω*, to write), e. g. the Chinese characters.

See **EGYPT, LANGUAGE; CUNEIFORM; INSCRIPTIONS AND WRITING.**

HIERONYMITES, a common name for three or four congregations of hermits living according to the rule of St. Augustine with supplementary regulations taken from St. Jerome's writings. Their habit was white, with a black cloak. (1) The Spanish Hieronymites, established near Toledo in 1374. The order soon became popular in Spain and Portugal, and in 1415 it numbered 25 houses. It possessed some of the most famous monasteries in the Peninsula, including the royal monastery of Belem near Lisbon, and the magnificent monastery built by Philip II. at the Escorial. Though the manner of life was very austere the Hieronymites devoted themselves to studies and to the active work of the ministry, and they possessed great influence both at the Spanish and the Portuguese courts. They went to Spanish and Portuguese America and played a considerable part in Christianizing and civilizing the Indians. There were Hieronymite nuns founded in 1375, who became very numerous. The order decayed during the 18th century and was completely suppressed in 1835. (2) Hieronymites of the Observance, or of Lombardy: a reform of (1) effected by the third general in 1424; it embraced seven houses in Spain and seventeen in Italy, mostly in Lombardy. It is now extinct. (3) Poor Hermits of St. Jerome, established near Pisa in 1377; it came to embrace nearly fifty houses whereof only one in Rome and one in Viterbo survive. (4) Hermits of St. Jerome of the congregation of Fiesole, established in 1406; they had forty houses but in 1668 they were united to (3).

See Helyot, *Histoire des ordres religieux* (1714), iii. cc. 57-60, iv. cc. 1-3; Max Heimbucher, *Orden und Kongregationen* (1896), i. § 70; and art. "Hieronymiten" in Herzog-Hauck, *Realencyklopädie* (ed. 3), and in Welte and Wetzler, *Kirchenlexikon* (ed. 2). (E. C. B.)

HIERONYMUS OF CARDIA, Greek general and historian, contemporary of Alexander the Great. After the death of the king he followed the fortunes of his friend and fellow-countryman Eumenes. He was wounded and taken prisoner by Antigonus, who pardoned him and appointed him superintendent of the asphalt beds in the Dead Sea. He was treated with equal friendliness by Antigonus's son Demetrius, who made him polemarch of Thespie, and by Antigonus Gonatas, at whose court he died at the age of 104. He wrote a history of the Diadochi and their descendants, embracing the period from the death of Alexander to the war with Pyrrhus (323-272 B.C.), which is one of the chief authorities used by Diodorus Siculus (xviii.-xx.) and also by Plutarch in his life of Pyrrhus. He made use of official papers and was careful in his investigation of facts. The simplicity of his style rendered his work unpopular, but it is probable that it was on a high level as compared with that of his contemporaries. In the last part of his work he made a praiseworthy attempt to acquaint the Greeks with the character and early history of the Romans. He is reproached by Pausanias (I. 9. 8) with unfairness towards all rulers with the exception of Antigonus Gonatas.

See Lucian, *Macrobii*, 22; Plutarch, *Demetrius*, 39; Diog. Sic. xviii. 42, 44, 50, xix. 100; Dion. Halic. *Antiq. Rom.* I. 6; F. Brückner, "De vita et scriptis Hieronymi Cardii," in *Zeitschrift für die Alterthumswissenschaft* (1842); F. Reuss, *Hieronymos von Kardis* (Berlin, 1876); C. Wachsmuth, *Einführung in das Studium der alten Geschichte* (1895); fragments in C. W. Müller, *Frug. hist. Graec.* II. 450-461.

HIERRO, or FERRO, an island in the Atlantic Ocean, forming part of the Spanish archipelago of the Canary Islands (q.v.). Pop. (1900) 6508; area 107 sq. m. Hierro, the most westerly and the smallest island of the group, is somewhat crescent-shaped. Its length is about 18 m., its greatest breadth about 15 m., and its circumference 50 m. It lies 92 m. W.S.W. of Tenerife. Its coast is bound by high, steep rocks, which only admit of one harbour, but the interior is tolerably level. Its hill-tops in winter are sometimes wrapped in snow. Better and more abundant grass grows here than on any of the other islands. Hierro is exposed to westerly gales which frequently inflict great damage. Fresh water is scarce, but there is a sulphurous spring, with a temperature of 109° Fahr. The ocell celebrated and almost sacred Til tree, which was reputed to be always distilling water in great abundance from its leaves, no longer exists. Only a small part of the cultivable land is under tillage, the inhabitants being principally employed in pasturage. Valverde (pop. about 3000) is the principal town. Geographers were formerly in the habit of measuring all longitudes from Ferro, the most westerly land known to them. The longitude assigned at first has, however, turned out to be erroneous; and the so-called "Longitude of Ferro" does not coincide with the actual longitude of the island.

HIGDON (or HIGDEN), RANULF (c. 1299-c. 1363), English chronicler, was a Benedictine monk of the monastery of St. Werburg in Chester, in which he lived, it is said, for sixty-four years, and died "in a good old age," probably in 1363. Higdon was the author of a long chronicle, one of several such works based on a plan taken from Scripture, and written for the amusement and instruction of his society. It closes the long series of general chronicles, which were soon superseded by the invention of printing. It is commonly styled the *Polychronicon*, from the longer title *Ranulphi Caestrensis, cognomine Higdon, Polychronicon (sive Historia Polycratica) ab initio mundi usque ad mortem regis Edwardi III. in septem libros dispositum*. The work is divided into seven books, in humble imitation of the seven days of Genesis, and, with exception of the last book, is a summary of general history, a compilation made with considerable style and taste. It seems to have enjoyed no little popularity in the 15th century. It was the standard work on general history, and more than a hundred MSS. of it are known to exist. The Christ Church MS. says that Higdon wrote it down to the year 1342; the fine MS. at Christ's College, Cambridge, states that he wrote to the year 1344, after which date, with the omission of two years, John of Malvern, a monk of Worcester, carried the history on to 1357, at which date it ends. According, however, to its latest editor, Higdon's part of the work goes no further than 1326 or 1327 at latest, after which time it was carried on by two continuators to the end. Thomas Gale, in his *Hist. Brit. Eccl., scriptores*, xv. (Oxon., 1691), published that portion of it, in the original Latin, which comes down to 1066. Three early translations of the *Polychronicon* exist. The first was made by John of Trevisa, chaplain to Lord Berkeley, in 1387, and was printed by Caxton in 1482; the second by an anonymous writer, was written between 1432 and 1439; the third, based on Trevisa's version, with the addition of an eighth book, was prepared by Caxton. These versions are especially valuable as illustrating the change of the English language during the period they cover.

The *Polychronicon*, with the continuations and the English versions, was edited for the Rolls Series (No. 41) by Churchill Babington (vols. I. and II.) and Joseph Rawson Lumby (1865-1866). This edition was adversely criticized by Mandell Creighton in the *Eng. Hist. Rev.* for October 1888.

HIGGINS, MATTHEW JAMES (1810-1868), British writer over the nom-de-plume "Jacob Omnium," which was the title of his first magazine article, was born in County Meath, Ireland.

on the 4th of December 1810. His letters in *The Times* were instrumental in exposing many abuses. He was a frequent contributor to the *Cornhill*, and was a friend of Thackeray, who dedicated to him *The Adventures of Philip*, and one of his ballads, "Jacob Omnium's Hoss," deals with an incident in Higgins's career. He died on the 14th of August 1868. Some of his articles were published in 1875 as *Essays on Social Subjects*.

HIGGINSON, THOMAS WENTWORTH (1823-), American author and soldier, was born in Cambridge, Massachusetts, on the 22nd of December 1823. He was a descendant of Francis Higginson (1588-1630), who emigrated from Leicestershire to the colony of Massachusetts Bay and was a minister of the church of Salem, Mass., in 1620-1630; and a grandson of Stephen Higginson (1743-1828), a Boston merchant, who was a member of the Continental Congress in 1783, took an active part in suppressing Shay's Rebellion, was the author of the "Laco" letters (1789), and rendered valuable services to the United States government as navy agent from the 11th of May to the 22nd of June 1798. Graduating from Harvard in 1841, he was a schoolmaster for two years, studied theology at the Harvard Divinity School, and was pastor in 1847-1850 of the First Religious Society (Unitarian) of Newburyport, Massachusetts, and of the Free Church at Worcester in 1852-1858. He was a Free Soil candidate for Congress (1850), but was defeated; was indicted with Wendell Phillips and Theodore Parker for participation in the attempt to release the fugitive slave, Anthony Burns, in Boston (1853); was engaged in the effort to make Kansas a free state after the passage of the Kansas-Nebraska Bill of 1854; and during the Civil War was captain in the 51st Massachusetts Volunteers, and from November 1862 to October 1864, when he was retired because of a wound received in the preceding August, was colonel of the First South Carolina Volunteers, the first regiment recruited from former slaves for the Federal service. He described his experiences in *Army Life in a Black Regiment* (1870). In politics Higginson was successively a Republican, an Independent and a Democrat. His writings show a deep love of nature, art and humanity, and are marked by vigour of thought, sincerity of feeling, and grace and finish of style. In his *Common Sense About Women* (1881) and his *Women and Men* (1888) he advocated equality of opportunity and equality of rights for the two sexes.

Among his numerous books are *Outdoor Papers* (1863); *Malbone: an Oldport Romance* (1869); *Life of Margaret Fuller Ossoli* (in "American Men of Letters" series, 1884); *A Larger History of the United States of America to the Close of President Jackson's Administration* (1885); *The Monarch of Dreams* (1886); *Travellers and Outlaws* (1889); *The Afternoon Landscape* (1889), poems and translations; *Life of Francis Higginson* (in "Makers of America," 1891); *Concerning All of Us* (1892); *The Procession of the Flowers and Kindred Papers* (1897); *Henry Wadsworth Longfellow* (in "American Men of Letters" series, 1902); *John Greenleaf Whittier* (in "English Men of Letters" series, 1902); *A Reader's History of American Literature* (1903), the Lowell Institute lectures for 1903, edited by Henry W. Boynton; and *Life and Times of Stephen Higginson* (1907). His volumes of reminiscence, *Cheerful Yesterdays* (1848), *Old Cambridge* (1899), *Contemporaries* (1899), and *Part of a Man's Life* (1905), are characteristic and charming works. His collected works were published in seven vols. (1900).

HIGHAM FERRERS, a market town and municipal borough in the Eastern parliamentary division of Northamptonshire, England, 63 m. N.N.W. from London, on branches of the London & North-Western and Midland railways. Pop. (1907), 2540. It is pleasantly situated on high ground above the south bank of the river Nene. The church of St Mary is among the most beautiful of the many fine churches in Northamptonshire. To the Early English chancel a very wide north aisle, resembling a second nave, was added in the Decorated period, and the general appearance of the chancel, with its north aisle and Lady-chapel, is Decorated. The tower with its fine spire and west front was partially but carefully rebuilt in the 17th century. Close to the church, but detached from it, stands a beautiful Perpendicular building, the school-house, founded by Archbishop Chichele in 1422. The Bede House, a somewhat similar structure by the same founder, completes a striking group of buildings. In the town are remains of Chichele's college. Higham Ferrers shares

in the widespread local industry of shoemaking. The town is governed by a mayor, 4 aldermen and 12 councillors, Area, 1945 acres.

Higham (Hecham, Heccam, Heggam Ferrers) was evidently a large village before the Domesday Survey. It was then held by William Feverel of the king, but on the forfeiture of the lordship by his son it was granted in 1199 to William Ferrers, earl of Derby. On the outlawry of Robert his grandson it passed to Edmund, earl of Lancaster, and, reverting to the crown in 1322, was granted to Aymer de Valence, earl of Pembroke, but resented to the crown in 1327, and was granted to Henry, earl of Lancaster. The castle, which may have been built before Henry III. visited Higham in 1229, is mentioned in 1322, but had been destroyed by 1540. It appears by the confirmation of Henry III. in 1251 that the borough originated in the previous year when William de Ferrers, earl of Derby, manumitted by charter ninety-two persons, granting they should have a free borough. A mayor was elected from the beginning of the reign of Richard II., while a town hall is mentioned in 1395. The revenues of Chichele's college were given to the corporation by the charter of 1566, whereby the borough returned one representative to parliament, a privilege enjoyed until 1832. James I. in 1604 gave the mayor the commission of the peace with other privileges which were confirmed by Charles II. in 1664. The old charters were suspended in 1684 and a new grant obtained; a further charter was granted in 1887.

HIGHGATE, a northern district of London, England, partly in the metropolitan borough of St Pancras, but extending into Middlesex. It is a high-lying district, the greatest elevation being 426 ft. The Great North Road passes through Highgate, which is supposed to have received its name from the toll-gate erected by the bishop of London when the road was formed through his demesne in the 14th century. It is possible, however, that "gate" is used here in its old signification, and that the name means simply high-road. The road rose so steeply here that in 1812 an effort was made to lessen the slope for coaches by means of an archway, and a new way was completed in 1900. In the time of stage-coaches a custom was introduced of making ignorant persons believe that they required to be sworn and admitted to the freedom of the Highgate before being allowed to pass the gate, the fine of admission being a bottle of wine. Not a few famous names occur among the former residents of Highgate. Bacon died here in 1626; Coleridge and Andrew Marvell, the poets, were residents. Cromwell House, now a convalescent home, was presented by Oliver Cromwell to his eldest daughter Bridget on her marriage with Henry Ireton (January 15, 1646/7). Lauderdale House, now attached to the public grounds of Waterlow Park, belonged to the Duke of Lauderdale, one of the "Cabal" of Charles II. Among various institutions may be mentioned Whittington's almshouses, near Whittington Stone, at the foot of Highgate Hill, on which the future mayor of London is reputed to have been resting when he heard the peal of Bow bells and "turned again." Highgate grammar school was founded (1562-1565) by Sir Roger Cholmley, chief-justice. St Joseph's Retreat is the mother-house of the Passionist Fathers in England. There is an extensive and beautiful cemetery on the slope below the church of St Michael.

HIGHLANDS, THE, that part of Scotland north-west of a line drawn from Dumbarton to Stonehaven, including the Inner and Outer Hebrides and the county of Bute, but excluding the Orkneys and Shetlands, Caithness, the flat coastal land of the shires of Nairn, Elgin and Banff, and all East Aberdeenshire (see SCOTLAND). This area is to be distinguished from the Lowlands by language and race, the preservation of the Gaelic speech being characteristic. Even in a historical sense the Highlanders were a separate people from the Lowlanders, with whom, during many centuries, they shared nothing in common. The town of Inverness is usually regarded as the capital of the Highlands. The Highlands consist of an old dissected plateau, or block, of ancient crystalline rocks with incised valleys and lochs carved by the action of mountain streams and by ice, the resulting topography being a wide area of irregularly distributed

to highway may be caused by encroachment, by interfering with the soil of the highway, by attracting crowds, by creating danger or inconvenience on or near the highway, by placing obstacles on the highway, by unreasonable user, by offences against decency and good order, &c.

The use of locomotives, motor cars and other vehicles on highways is regulated by acts of 1861-1903.

Formerly under the Turnpike Acts many of the more important highways were placed under the management of boards of commissioners or trustees. The trustees were required and empowered to maintain, repair and improve the roads committed to their charge, and the expenses of the trust were met by tolls levied on persons using the road. The various grounds of exemption from toll on turnpike roads were all of a public character, e.g. horses and carriages attending the sovereign or royal family, or used by soldiers or volunteers in uniform, were free from toll. In general horses and carriages used in agricultural work were free from toll. By the Highways and Locomotives Act of 1878 disturnpiked roads became "main roads." Ordinary highways might be declared to be "main roads," and "main roads" be reduced to the status of ordinary highways.

In Scotland the highway system is regulated by the Roads and Bridges Act 1878 and amending acts. The management and maintenance of the highways and bridges is vested in county road trustees, viz. the commissioners of supply, certain elected trustees representing ratepayers in parishes and others. One of the consequences of the act was the abolition of tolls, statute-labour, causeway mail and other exactions for the maintenance of bridges and highways, and all turnpike roads became highways, and all highways became open to the public free of tolls and other exactions. The county is divided into districts under district committees, and county and district officers are appointed. The expenses of highway management in each district (or parish), together with a proportion of the general expenses of the act, are levied by the trustees by an assessment on the lands and heritages within the district (or parish).

Highway, in the law of the states of the American Union, generally means a lawful public road, over which all citizens are allowed to pass and repass on foot, on horseback, in carriages and waggons. Sometimes it is held to be restricted to county roads as opposed to town-ways. In statutes dealing with offences connected with the highway, such as gaming, negligence of carriers, &c., "highway" includes navigable rivers. But in a statute punishing with death robbery on the highway, railways were held not to be included in the term. In one case it has been held that any way is a highway which has been used as such for fifty years.

See *Glen, Law Relating to Highways*; *Pratt, Law of Highways, Main Roads and Bridges*.

HIGINBOTHAM, GEORGE (1827-1893), chief-justice of Victoria, Australia, sixth son of T. Higinbotham of Dublin, was born on the 19th of April 1827, and educated at the Royal School, Dungannon, and at Trinity College, Dublin. After entering as a law student at Lincoln's Inn, and being engaged as reporter on the *Morning Chronicle* in 1846, he emigrated to Victoria, where he contributed to the *Melbourne Herald* and practised at the bar (having been "called" in 1853) with much success. In 1850 he became editor of the *Melbourne Argus*, but resigned in 1859 and returned to the bar. He was elected to the legislative assembly in 1861 for Brighton as an independent Liberal, was rejected at the general election of the same year, but was returned nine months later. In 1863 he became attorney-general. Under his influence measures were passed through the legislative assembly of a somewhat extreme character, completely ignoring the rights of the legislative council, and the government was carried on without any Appropriation Act for more than a year. Mr Higinbotham, by his eloquence and earnestness, obtained great influence amongst the members of the legislative assembly, but his colleagues were not prepared to follow him as far as he desired to go. He contended that in a constitutional colony like Victoria the secretary of state for the colonies had no right to fetter the discretion of the queen's representative. Mr Higin-

botham did not return to power with his chief, Sir James M'Culloch, after the defeat of the short-lived Sladen administration; and being defeated for Brighton at the next general election by a comparatively unknown man, he devoted himself to his practice at the bar. Amongst his other labours as attorney-general he had codified all the statutes which were in force throughout the colony. In 1874 he was returned to the legislative assembly for Brunswick, but after a few months he resigned his seat. In 1880 he was appointed a puisne judge of the supreme court, and in 1886, on the retirement of Sir William Stawell, he was promoted to the office of chief justice. Mr Higinbotham was appointed president of the International Exhibition held at Melbourne in 1888-1889, but did not take any active part in its management. One of his latest public acts was to subscribe a sum of £10, 10s. a week towards the funds of the strikers in the great Australian labour dispute of 1890, an act which did not meet with general approval. He died in 1893.

HILARIUM, ST (c. 290-371), abbot, the first to introduce the monastic system into Palestine. The chief source of information is a life written by St Jerome; it was based upon a letter, no longer extant, written by St Epiphanius, who had known Hilarion. The accounts in *Sozomen* are mainly based on Jerome's *Vita*; but Otto Zöcker has shown that *Sozomen* also had at his disposal authentic local traditions (see "Hilarion von Gaza" in the *Neue Jahrbücher für deutsche Theologie*, 1894), the most important study on Hilarion, which is written against the hypercritical school of Weingarten and shows that Hilarion must be accepted as an historical personage and the *Vita* as a substantially correct account of his career. He was born of heathen parents at Tabatha near Gaza about 290; he was sent to Alexandria for his education and there became a convert to Christianity; about 306 he visited St Anthony and became his disciple, embracing the eremitical life. He returned to his native place and for many years lived as a hermit in the desert by the marshes on the Egyptian border. Many disciples put themselves under his guidance; but his influence must have been limited to south Palestine, for there is no mention of him in Palladius or Cassian. In 356 he left Palestine and went again to Egypt; but the accounts given in the *Vita* of his travels during the last fifteen years of his life must be taken with extreme caution. It is there said that he went from Egypt to Sicily, and thence to Epidaurus, and finally to Cyprus where he met Epiphanius and died in 371.

An abridged story of his life will be found in Alban Butler's *Lives of the Saints*, on the 21st of October, and a critical sketch with full references in Herzog-Hauck, *Realencyklopädie* (ed. 3). (E. C. B.)

HILARIUS (HILARY), ST (c. 300-367), bishop of Pictavius (Poitiers), an eminent "doctor" of the Western Church, sometimes referred to as the "malleus Arianorum" and the "Athanasius of the West," was born at Poitiers about the end of the 3rd century A.D. His parents were pagans of distinction. He received a good education, including what had even then become somewhat rare in the West, some knowledge of Greek. He studied, later on, the Old and New Testament writings, with the result that he abandoned his neo-platonism for Christianity, and with his wife and his daughter received the sacrament of baptism. So great was the respect in which he was held by the citizens of Poitiers that about 353, although still a married man, he was unanimously elected bishop. At that time Arianism was threatening to overrun the Western Church; to repel the irruption was the great task which Hilary undertook. One of his first steps was to secure the excommunication, by those of the Gallican hierarchy who still remained orthodox, of Saturninus, the Arian bishop of Arles and of Ursacius and Valens, two of his prominent supporters. About the same time he wrote to the emperor Constantius a remonstrance against the persecutions by which the Arians had sought to crush their opponents (*Ad Constantium Augustum liber primus*, of which the most probable date is 355). His efforts were not at first successful, for at the synod of Biterræ (Beziers), summoned in 356 by

¹ The name is derived from Gr. *ἡλέος*, gay, cheerful, whence *hilarious*, *hilarity*.

Constantius with the professed purpose of settling the long-standing disputes, Hilary was by an imperial rescript banished with Rhodanus of Toulouse to Phrygia, in which exile he spent nearly four years. Thence, however, he continued to govern his diocese; while he found leisure for the preparation of two of the most important of his contributions to dogmatic and polemical theology, the *De synodis* or *De fide Orientalium*, an epistle addressed in 358 to the Semi-Arian bishops in Gaul, Germany and Britain, expounding the true views (sometimes veiled in ambiguous words (of the Oriental bishops on the Nicene controversy, and the *De trinitate libri xii.*,¹ composed in 359 and 360, in which, for the first time, a successful attempt was made to express in Latin the theological subtleties elaborated in the original Greek. The former of these works was not entirely approved by some members of his own party, who thought he had shown too great forbearance towards the Arians; to their criticisms he replied in the *Apologice et reprehensores libri de synodis responsa*. In 359 Hilary attended the convocation of bishops at Seleucia in Isauria, where, with the Egyptian Athanasians, he joined the Homoiousian majority against the Arianizing party headed by Acacius of Caesarea; thence he went to Constantinople, and, in a petition (*Ad Constantium Augustum liber secundus*) personally presented to the emperor in 360, repudiated the calumnies of his enemies and sought to vindicate his trinitarian principles. His urgent and repeated request for a public discussion with his opponents, especially with Ursacius and Valens, proved at last so inconvenient that he was sent back to his diocese, which he appears to have reached about 361, within a very short time of the accession of Julian. He was occupied for two or three years in combating Arianism within his diocese; but in 364, extending his efforts once more beyond Gaul, he impeached Auxentius, bishop of Milan, and a man high in the imperial favour, as heterodox. Summoned to appear before the emperor (Valentinian) at Milan and there maintain his charges, Hilary had the mortification of hearing the supposed heretic give satisfactory answers to all the questions proposed; nor did his (doubtless sincere) denunciation of the metropolitan as a hypocrite save himself from an ignominious expulsion from Milan. In 365 he published the *Contra Arianos vel Auxentium Mediolanensem liber*, in connexion with the controversy; and also (but perhaps at a somewhat earlier date) the *Contra Constantium Augustum liber*, in which he pronounced that lately deceased emperor to have been Antichrist, a rebel against God, "a tyrant whose sole object had been to make a gift to the devil of that world for which Christ had suffered." Hilary is sometimes regarded as the first Latin Christian hymn-writer, but none of the compositions assigned to him is indisputable. The later years of his life were spent in comparative quiet, devoted in part to the preparation of his expositions of the Psalms (*Tractatus super Psalmos*), for which he was largely indebted to Origen; of his *Commentarius in Evangelium Matthei*, a work on allegorical lines of no exegetical value; and of his no longer extant translation of Origen's commentary on Job. While he thus closely followed the two great Alexandrians, Origen and Athanasius, in exegesis and Christology respectively, his work shows many traces of vigorous independent thought. He died in 367; no more exact date is trustworthy. He holds the highest rank among the Latin writers of his century. Designated already by Augustine as "the illustrious doctor of the churches," he by his works exerted an increasing influence in later centuries; and by Pius IX. he was formally recognized as "universae ecclesiae doctor" at the synod of Bordeaux in 1851. Hilary's day in the Roman calendar is the 13th of January.²

¹ Hilary's own title was *De fide contra Arianos*. It really deals less with the doctrine of the Trinity than with that of the Incarnation. That it is not an easy work to read is due partly to the nature of the subject, partly to the fact that it was issued in detached portions.

² "Hilary" was the name of one of the four terms of the English legal year. These terms were abolished by the Judicature Act, 1873, s. 26, and "sittings" substituted. It is now the name of the sitting of the Supreme Court of Judicature which commences on the 11th of January and terminates on the Wednesday before

EDITIONS.—ERASMUS (Basel, 1523, 1526, 1528); P. Constant (Benedictine, Paris, 1693); Migne (*Patrol. Lat.* ix., x.). The *Tractatus de mysteriis*, ed. J. F. Camurrini (Rome, 1887); and the *Tractatus super Psalmos*, ed. A. Zingerle in the *Vienna Corpus scrip. eccl. Lat.* xxii. Translation by E. W. Watson in *Nicene and Post-Nicene Fathers*, ix.

LITERATURE.—The life by (Venantius) Fortunatus c. 550 is almost worthless. More trustworthy are the notices in Jerome (*De vir. illis.* 100), Sulpicius Severus (*Chron.* li. 39-45) and in Hilary's own writings. H. Reinkens, *Hilarius von Poitiers* (1864); O. Hardenhewer, *Patrologie*; A. Harnack, *Hist. of Dogma*, esp. vol. iv.; F. Looft, in Herzog-Hauck's *Realencyk.* viii.

HILARIUS, or HILARUS (HILARY), bishop of Rome from 461 to 468, is known to have been a deacon and to have acted as legate of Leo the Great at the "robber" synod of Ephesus in 449. There he so vigorously defended the conduct of Flavian in deposing Eutyches that he was thrown into prison, whence he had great difficulty in making his escape to Rome. He was chosen to succeed Leo on the 19th of November 461. In 465 he held at Rome a council which put a stop to some abuses, particularly to that of bishops appointing their own successors. His pontificate was also marked by a successful encroachment of the papal authority on the metropolitan rights of the French and Spanish hierarchy, and by a resistance to the toleration edict of Anthemius, which ultimately caused it to be recalled. Hilarius died on the 17th of November 467, and was succeeded by Simplicius.

HILARIUS (fl. 7125), a Latin poet who is supposed to have been an Englishman. He was one of the pupils of Abelard at his oratory of Paraclete, and addressed to him a copy of verses with its refrain in the vulgar tongue, "*Tori oves si vestre*," Abelard having threatened to discontinue his teaching because of certain reports made by his servant about the conduct of the scholars. Later Hilarius made his way to Angers. His poems are contained in MS. supp. lat. 1008 of the Bibliothèque Nationale, Paris, purchased in 1837 at the sale of M. de Rosny. Quotations from this MS. had appeared before, but in 1838 it was edited by Champollion Figéac as *Hilarii versus ad Iudi*. His works consist chiefly of light verses of the gollardic type. There are verses addressed to an English nun named Eva, lines to Rosa, "*Aus splendor puellarum, generosa domina*," and another poem describes the beauties of the priory of Chaloutre la Petite, in the diocese of Sens, of which the writer was then an inmate. One copy of satirical verses seems to aim at the pope himself. He also wrote three miracle plays in rhymed Latin with an admixture of French. Two of them, *Suscipitio Lazari* and *Historia de Daniel representanda*, are of purely liturgical type. At the end of *Lazarus* is a stage direction to the effect that if the performance has been given at matins, Lazarus should proceed with the *Te Deum*, if at vespers, with the *Magnificat*. The third, *Ludus super iconia Sancti Nicolai*, is founded on a sufficiently foolish legend. Petit de Julleville sees in the play a satirical intention and a veiled incredulity that put the piece outside the category of liturgical drama.

A rhymed Latin account of a dispute in which the nuns of Ronceray at Angers were concerned, contained in a cartulary of Ronceray, is also ascribed to the poet, who there calls himself Hilarius Canonicus. The poem is printed in the *Bibliothèque de l'École des Chartes* (vol. xxxvii, 1876), and is dated by P. Marchegay from 1121. See also a notice in *Hist. lit. de la France* (xii, 251-254), supplemented (in xx, 627-630), s.v. Jean Bodel, by Paulin Paris; also Wright, *Biographia Britannica literaria, Anglo-Norman Period* (1846); and Petit de Julleville, *Les Mystères* (vol. I, 1860).

HILARIUS (HILARY), ST (c. 403-449), bishop of Arles, was born about 403. In early youth he entered the abbey of Lérins, then presided over by his kinsman Honoratus (St Honoré), and succeeded Honoratus in the bishopric of Arles in 429. Following the example of St Augustine, he is said to have organized his cathedral clergy into a "congregation," devoting a great part of their time to social exercises of ascetic religion. He held the rank of metropolitan of Vienne and Narbonne, and attempted to realize the sort of primacy over the church of south Gaul. In the luns of Court, Hilary is one of the four dining terms; it begins on the 11th of January and ends on the 1st of February. It is also the name of one of the terms at the universities of Oxford (more usually "Lent term") and Dublin.

which seemed implied in the vicariate granted to his predecessor Patroclus (417). Hilarius deposed the bishop of Besançon (Chelidonus), for ignoring his primacy, and for claiming a metropolitan dignity for Besançon. An appeal was made to Rome, and Leo I. used it to extinguish the Gallican vicariate (A.D. 444). Hilarius was deprived of his rights as metropolitan to consecrate bishops, call synods, or exercise ecclesiastical oversight in the province, and the pope secured the edict of Valentinian III., so important in the history of the Gallican church, "ut episcopis Gallicanis omnibusque pro lege esset quiddam apostolicæ sedis auctoritas sanxisset." The papal claims were made imperial law, and violation of them subject to legal penalties (*Novellæ Valent.* iii. tit. 16). Hilarius died in 449, and his name was afterwards introduced into the Roman martyrology for commemoration on the 5th of May. He enjoyed during his lifetime a high reputation for learning and eloquence as well as for piety; his extant works (*Vita S. Honorati Arelatensis episcopi* and *Melrum in Genesis*) compare favourably with any similar literary productions of that period.

A poem, *De providentia*, usually included among the writings of Prosper, is sometimes attributed to Hilary of Arles.

HILDA, ST. strictly HILD (614-680), was the daughter of Hereric, a nephew of Edwin, king of Northumbria. She was converted to Christianity before 633 by the preaching of Paulinus. According to Bede she took the veil in 614, when Oswio was king of Northumbria and Aidan bishop of Lindisfarne, and spent a year in East Anglia, where her sister Hereswith had married Æthelhere, who was to succeed his brother Anna, the reigning king. In 648 or 649 Hilda was recalled to Northumbria by Aidan, and lived for a year in a small monastic community north of the Wear. She then succeeded Heiu, the foundress, as abbess of Hartlepool, where she remained several years. From Hartlepool Hilda moved to Whitby, where in 657 she founded the famous double monastery which in the time of the first abbess included among its members five future bishops, Bosa, Ætta, Otfor, John and Wilfrid II. as well as the poet Cædmon. Hilda exercised great influence in Northumbria, and ecclesiastics from all over Christian England and from Strathclyde and Dalriada visited her monastery. In 655 after the battle of Winwæd Oswio entrusted his daughter Ælfled to Hilda, with whom she went to Whitby. At the synod of Whitby in 664 Hilda sided with Colman and Cedd against Wilfrid. In spite of the defeat of the Celtic party she remained hostile to Wilfrid until 679 at any rate. Hilda died in 680 after a painful illness lasting for seven years.

See Bede, *Hist. eccl.* (ed. C. Plummer, Oxford, 1869), iii. 24, 25, iv. 23; Eddius, *Vita Wilfridi* (Raine, *Historians of Church of York*, Rolls Series, vol. 1., 1879), c. liv.

HILDBURGHUSEN, a town of Germany, in the duchy of Saxe-Meiningen, situated in a wide and fruitful valley on the river Werra, 19 m. S.E. of Meiningen, on the railway Eisenach-Lichtenfels. Pop. (1905) 7456. The principal buildings are a ducal palace, erected 1685-1695, now used as barracks, with a park in which there is a monument to Queen Louisa of Prussia, the old town hall, two Evangelical and a Roman Catholic church and a theatre. A technical college occupies the premises in which Meyer's Bibliographisches Institut carried on business from 1828, when it removed hither from Gotha, until 1874, when it was transferred to Leipzig. A monument has been erected to those citizens who died in the Franco-Prussian War of 1870-71. The manufactures include linen fabrics, cloth, toys, buttons, optical instruments, agricultural machines, knives, mineral waters, condensed soups and condensed milk. Hilburghausen (in records *Hilpershusia* and *Villa Hilperiti*) belonged in the 13th century to the counts of Henneberg, from whom it passed to the landgraves of Thuringia and then to the dukes of Saxony. In 1683 it became the capital of a principality which in 1836 was united to Saxe-Meiningen.

See R. A. Human, *Chronik der Stadt Hilburghausen* (Hilburghausen, 1888).

HILDEBERT, HYDALBERT, GILDEBERT or ALDEBERT (c. 1055-1133), French writer and ecclesiastic, was born of poor parents at Lavardin, near Vendôme, and was intended for the

church. He was probably a pupil of Berengarius of Tours, and became master (*scholasticus*) of the school at Le Mans; in 1091 he was made archdeacon and in 1096 bishop of Le Mans. He had to face the hostility of a section of his clergy and also of the English king, William II., who captured Le Mans and carried the bishop with him to England for about a year. Hildebert then travelled to Rome and sought permission to resign his bishopric, which Pope Paschal II. refused. In 1116 his diocese was thrown into great confusion owing to the preaching of Henry of Lausanne, who was denouncing the higher clergy, especially the bishop. Hildebert compelled him to leave the neighbourhood of Le Mans, but the effects of his preaching remained. In 1123 Hildebert was translated very unwillingly to the archbishopric of Tours, and there he came into conflict with the French king Louis VI. about the rights of ecclesiastical patronage and with the bishop of Dol about the authority of his see in Brittany. He presided over the synod of Nantes, and died at Tours probably on the 18th of December 1133. Hildebert, who built part of the cathedral at Le Mans, has received from some writers the title of saint, but there appears to be no authority for this. He was not a man of very strict life; his contemporaries, however, had a very high opinion of him and he was called *egregius versificator*.

The extant writings of Hildebert consist of letters, poems, a few sermons, two lives and one or two treatises. An edition of his works prepared by the Maurist, Antoine Beaugendre, and entitled *Venerabilis Hildeberti, primo Cenomannensis episcopi, deinde Turonensis archiepiscopi, opera tam edita quam inedita*, was published in Paris in 1708 and was reprinted with additions by J. J. Bourassé in 1854. These editions, however, are very faulty. They credit Hildebert with numerous writings which are the work of others, while some genuine writings are omitted. The revelation of this fact has affected Hildebert's position in the history of medieval thought. His standing as a philosopher rested upon his supposed authorship of the important *Tractatus theologicus*; but this is now regarded as the work of Hugh of St Victor, and consequently Hildebert can hardly be counted among the philosophers. His genuine writings include many letters. These *Epistolæ* enjoyed great popularity in the 12th and 13th centuries, and were frequently used as classics in the schools of France and Italy. Those which concern the struggle between the emperor Henry V. and Pope Paschal II. have been edited by E. Sacur and printed in the *Monumenta Germaniæ historica. Libelli de lite ii.* (1893). His poems, which deal with various subjects, are disfigured by many defects of style and metre, but they too were very popular. Hildebert attained celebrity also as a preacher both in French and Latin, but only a few of his sermons are in existence, most of the 144 attributed to him by his editors being the work of Peter Lombard and others. The *Vitæ* written by Hildebert are the lives of Hugo, abbot of Cluny, and of St Radegunda. Undoubtedly genuine is also his *Libre de querimonia et confictio carnis et spiritus seu animæ*. Hildebert was an excellent Latin scholar, being acquainted with Cicero, Ovid and other authors, and his spirit is rather that of a pagan than of a Christian writer.

See B. Hauréau, *Les Mélanges poétiques d'Hildebert de Lavardin* (Paris, 1882), and *Notices et extraits de quelques manuscrits latins de la Bibliothèque nationale* (Paris, 1890-1893); Comte P. de Desvillers, *Un Evêque au XII^e siècle, Hildebert et son temps* (Paris, 1876); E. A. Freeman, *The Reign of Rufus*, vol. ii. (Oxford, 1882); tome xi. of the *Histoire littéraire de la France*, and H. Böhmér in Band viii. of Herzog-Hauck's *Realencyclopædie* (1900). The most important work, however, to be consulted is L. Dieudonné's *Hildebert de Lavardin, évêque du Mans, archevêque de Tours... Sa vie, ses lettres* (Paris, 1898).

HILDEBRAND, LAY OF (*Das Hildebrandslied*), a unique example of Old German alliterative poetry, written about the year 800 on the first and last pages of a theological manuscript, by two monks of the monastery of Fulda. The fragment, or rather fragments, only extend to sixty-eight lines, and the conclusion of the poem is wanting. The theory propounded by Karl Lachmann, that the poem had been written in its present form from memory, has been discredited by later philological investigation; it is clearly a transcript of an older original,

which the copyists—or more probably the writer to whom we owe the older version—imperfectly understood. The language of the poem shows a curious mixture of Low and High German forms; as the High German elements point to the dialect of Fulda, the inference is that the copyists were reproducing an originally Low German lay in the form in which it was sung in Franconia.

The fragment is mainly taken up with a dialogue between Hildebrand and his son Hadubrand. When Hildebrand followed his master, Theodoric the Great, who was fleeing eastwards before Odoacer, he left his young wife and an infant child behind him. At his return to his old home, after thirty years' absence among the Huns, he is met by a young warrior and challenged to single combat. Before the fight begins, Hildebrand asks for the name of his opponent, and discovering his own son in him, tries to avert the fight, but in vain; Hadubrand only regards the old man's words as the excuse of cowardice. "In sharp showers the ashen spears fall on the shields, and then the warriors seize their swords and hew vigorously at the white shields until these are beaten to pieces. . . ." With these words the fragment breaks off abruptly, giving no clue as to the issue of the combat. There is little doubt, however, that, as in the Old Norse *Asmundar saga*, where the tale is alluded to, the fight must have been fatal to Hadubrand. But in the later traditions, both of the Old Norse *Thidreks saga* (13th century), and the so-called *Jüngere Hildebrandslied*—a German popular lay, preserved in several versions from the 15th to the 17th century—Hadubrand is simply represented as defeated, and obliged to recognize his father. The Old High German *Hildebrandslied* is dramatically conceived, and written in a terse, vigorous style; it is the only remnant that has come down from early Germanic times of an undoubtedly extensive ballad literature, dealing with the national sagas.

The MS. of the *Hildebrandslied*, originally in Fulda, is now preserved in the Landesbibliothek at Cassel. The literature on the poem will be found most conveniently in K. Müllenhoff and W. Scherer, *Denkmäler deutscher Poesie und Prosa aus dem VIII. bis XI. Jahrh.*, 3rd ed. (1892), and in W. Braune, *Althochdeutsches Lezbuch*, 5th ed. (1902), to which authorities the reader is referred for a critical text. The poem was discovered and first printed (as prose) by J. G. von Eckhart, *Commentarii de rebus Francie orientalis* (1729), i. 864 ff.; the first scholarly edition was that of the brothers Grimm (1812). Facsimile reproductions of the MS. have been published by W. Grimm (1830), E. Sievers (1872), G. Könnicke in his *Bilderatlas* (1887; 2nd ed., 1895) and M. Ennenecerus (1897). See also K. Lachmann, *Über das Hildebrandslied* (1833) in *Kleine Schriften*, i. 407 ff.; C. W. M. Grein, *Das Hildebrandslied* (1858; 2nd ed., 1880); O. Schröder, *Bemerkungen zum Hildebrandslied* (1859); H. Möller, *Zur althochdeutschen Alliterationspoesie* (1888); R. Heinel, *Über die ostgotische Heldensage* (1889); B. Busse, "Sagenreiches zum Hildebrandslied," in Paul und Braune's *Beiträge*, xxvi. (1901), pp. 1 ff.; R. Koegel, *Geschichte der deutschen Literatur bis zum Ausbruch des Mittelalters*, i. (1894), pp. 210 ff.; and R. Koegel and W. Brückner, in Paul's *Grundriss der germanischen Philologie*, 2nd ed., ii. (1901), pp. 71 ff. (J. G. R.)

HILDEBRANDT, EDUARD (1818-1868), German painter, was born in 1818, and served as apprentice to his father, a house-painter at Danzig. He was not twenty when he came to Berlin, where he was taken in hand by Wilhelm Krause, a painter of sea-pieces. Several early pieces exhibited after his death—a breakwater, dated 1838, ships in a breeze off Swinemünde (1840), and other canvases of this and the following year—show Hildebrandt to have been a careful student of nature, with inborn talents kept down by the conventionalisms of the formal school to which Krause belonged. Accident made him acquainted with masterpieces of French art displayed at the Berlin Academy, and these awakened his curiosity and envy. He went to Paris, where, about 1842, he entered the atelier of Isabey and became the companion of Lepoittevin. In a short time he sent home pictures which might have been taken for copies from these artists. Gradually he mastered the mysteries of touch and the secrets of effect in which the French at this period excelled. He also acquired the necessary skill in painting figures, and returned to Germany, skilled in the rendering of many kinds of landscape forms. His pictures of French street life, done about 1843, while impressed with the stamp of the

Paris school, reveal a spirit eager for novelty, quick at grasping, equally quick at rendering, momentary changes of tone and atmosphere. After 1843 Hildebrandt, under the influence of Humboldt, extended his travels, and in 1864-1865 he went round the world. Whilst his experience became enlarged his powers of concentration broke down. He lost the taste for detail in seeking for scenic breadth, and a fatal facility of hand diminished the value of his works for all those who look for composition and harmony of hue as necessary concomitants of tone and touch. In oil he gradually produced less, in water colours more, than at first, and his fame must rest on the sketches which he made in the latter form, many of them represented by chromo-lithography. Fantasies in red, yellow and opal, sunset, sunrise and moonshine, distances of hundreds of miles like those of the Andes and the Himalaya, narrow streets in the bazaars of Cairo or Suez, panoramas as seen from mastheads, wide cities like Bombay or Peking, narrow strips of desert with measureless expanses of sky—all alike display his quality of *bravura*. Hildebrandt died at Berlin on the 25th of October 1868.

HILDEBRANDT, THEODOR (1804-1874), German painter, was born at Stettin. He was a disciple of the painter Schadow, and, on Schadow's appointment to the presidency of a new academy in the Rhenish provinces in 1838, followed that master to Düsseldorf. Hildebrandt began by painting pictures illustrative of Goethe and Shakespeare; but in this form he followed the traditions of the stage rather than the laws of nature. He produced rapidly "Faust and Mephistopheles" (1824), "Faust and Margaret" (1825), and "Lear and Cordelia" (1828). He visited the Netherlands with Schadow in 1829, and wandered alone in 1830 to Italy; but travel did not alter his style, though it led him to cultivate alternately eclecticism and realism. At Düsseldorf, about 1830, he produced "Romeo and Juliet," "Tancred and Clorinda," and other works which deserved to be classed with earlier paintings; but during the same period he exhibited (1829) the "Robber" and (1832) the "Captain and his Infant Son," examples of an affected but kindly realism which captivated the public, and marked to a certain extent an epoch in Prussian art. The picture which made Hildebrandt's fame is the "Murder of the Children of King Edward" (1836), of which the original, afterwards frequently copied, still belongs to the Spiegel collection at Halberstadt. Comparatively late in life Hildebrandt tried his powers as an historical painter in pictures representing Wolsey and Henry VIII., but he lapsed again into the romantic in "Othello and Desdemona." After 1847 Hildebrandt gave himself up to portrait-painting, and in that branch succeeded in obtaining a large practice. He died at Düsseldorf in 1874.

HILDEGARD, ST (1098-1179), German abbess and mystic, was born of noble parents at Böckelheim, in the county of Sponheim, in 1098, and from her eighth year was educated at the Benedictine cloister of Disibodenberg by Jutta, sister of the count of Sponheim, whom she succeeded as abbess in 1136. From earliest childhood she was accustomed to see visions, which increased in frequency and vividness as she approached the age of womanhood; these, however, she for many years kept almost secret, nor was it until she had reached her forty-third year (1141) that she felt constrained to divulge them. Committed to writing by her intimate friend the monk Godefridus, they now form the first and most important of her printed works, entitled *Scivias* (probably an abbreviation for "sciens vias" or "nosce vias Domini") s. *visionum et revelationum libri vii.*, and completed in 1151. In 1147 St Bernard of Clairvaux, while at Bingen preaching the new crusade, heard of Hildegard's revelations, and became so convinced of their reality that he not only wrote to her a letter cordially acknowledging her as a prophetess of God, but also successfully advocated her recognition as such by his friend and former pupil Pope Eugenius III. in the synod of Trèves (1148). In the same year Hildegard migrated along with eighteen of her nuns to a new convent on the Rupertsberg near Bingen, over which she presided during the remainder of her life. By means of voluminous correspondence, as well as by extensive journeys,

in the course of which she was unwearied in the exercise of her gift of prophecy, she wielded for many years an increasing influence upon her contemporaries—an influence doubtless due to the fact that she was imbued with the most widely diffused feelings and beliefs, fears and hopes, of her time. Amongst her correspondents were Popes Anastasius IV. and Adrian IV., the emperors Conrad III. and Frederick I., and also the theologian Guibert of Gembloux, who submitted numerous questions in dogmatic theology for her determination. She died in 1179, but has never been canonized; her name, however, was received into the Roman martyrology in the 15th century, September 17th being the day fixed for her commemoration.

Her biography, which was written by two contemporaries, Godefridus and Theodoricus, was first printed at Cologne in 1566. Hildegard's writings, besides the *Scritias* already mentioned and first printed in Paris in 1513, include the *Liber divinorum operum*, *Explanatio regule S. Benedicti*, *Physica* and the Letters, &c., are contained in Migne, *Patr. Lat. t. cxcvii.*, and in Cardinal Pitra's *Analecra sacro spicilegio Solesmensi parata; Nova S. Hildegardis opera* (Paris, 1882).

For a modern study of the saint's writings, see *Sainte Hildegardis* by Pal Franche, "Les Saints" series (Paris, 1903); and U. Chevalier, *Répertoire des sources historiques, bio.-bibl.* 2153.

HILDEN, a town in the Prussian Rhine province on the Itter, 9 m. S.E. of Düsseldorf by rail. Pop. (1905) 13,946. It possesses an Evangelical and a Roman Catholic church and a monument to the emperor William I. Its manufactures include silks, velvets, carpets, calico-printing, machinery and brick-making.

HILDESHEIM, a town and episcopal see of Germany, in the Prussian province of Hanover, beautifully situated at the north foot of the Harz Mountains, on the right bank of the Innerste, 18 m. S.E. of Hanover by railway, and on the main line from Berlin, via Magdeburg to Cologne. Pop. (1885) 20,386, (1905) 47,060. The town consists of an old and a new part, and is surrounded by ramparts which have been converted into promenades. Its streets are for the most part narrow and irregular, and contain many old houses with overhanging upper storeys and richly and curiously adorned wooden façades. Its religious edifices are five Roman Catholic and four Evangelical churches and a synagogue. The most interesting is the Roman Catholic cathedral, which dates from the middle of the 11th century and occupies the site of a building founded by the emperor Louis the Pious early in the 9th century. It is famous for its antiquities and works of art. These include the bronze doors executed by Bishop Bernard, with reliefs from the history of Adam and of Jesus Christ; a brazen font of the 13th century; two large candelabra of the 11th century; the sarcophagus of St Godehard; and the tomb of St Epiphanius. In the cathedral also there is a bronze column 15 ft. high, adorned with reliefs from the life of Christ and dating from 1022, and another column, at one time thought to be an Irminsule erected in honour of the Saxon idol Irmin, but now regarded as belonging to a Roman aqueduct. On the wall of the Romanesque crypt, which was restored in 1896, is a rose-bush, alleged to be a thousand years old; this sends its branches to a height of 24 ft. and a breadth of 30 ft., and they are trained to interlace one of the windows. Before the cathedral is the pretty cloister garth, with the chapel of St Anne, erected in 1321 and restored in 1888. The Romanesque church of St Godehard was built in the 12th century and restored in the 19th. The church of St Michael, founded by Bishop Bernard early in the 11th century and restored after injury by fire in 1186, contains a unique painted ceiling of the 12th century, the sarcophagus and monument of Bishop Bernard, and a bronze font; it is now a Protestant parish church, but the crypt is used by the Roman Catholics. The church of the Magdalene possesses two candelabra, a gold cross, and various other works in metal by Bishop Bernard; and the Lutheran church of St Andrew has a choir dating from 1389 and a tower 385 ft. high. In the suburb of Moritzberg there is an abbey church founded in 1040, the only pure columnar basilica in north Germany.

The chief secular buildings are the town-hall (Rathaus), which dates from the 15th century and was restored in 1889-1892, adorned with frescoes illustrating the history of the city; the Tempelherrenhaus, in Late Gothic erroneously said to have been built by the Knights Templars; the Knochenhaueramthaus, formerly the guild-house of the butchers, which was restored after being damaged by fire in 1884, and is probably the finest specimen of a wooden building in Germany; the Michaelis monastery, used as a lunatic asylum; and the old Carthusian monastery. The Römer museum of antiquities and natural history is housed in the former church of St Martin; the building of Trinity hospital, partly dating from the 14th century, are now a factory; and the Wedekindhaus (1598) is now a savings-bank. The educational establishments include a Roman Catholic and a Lutheran gymnasium, a Roman Catholic school and college and two technical institutions, the Georgstitte for daughters of state servants and a conservatoire of music. Hildesheim is the seat of considerable industry. Its chief productions are sugar, tobacco and cigars, stoves, machines, vehicles, agricultural implements and bricks. Other trades are brewing and tanning. It is connected with Hanover by an electric tram line, 19 m. in length.

Hildesheim owes its rise and prosperity to the fact that in 822 it was made the seat of the bishopric which Charlemagne had founded at Elze a few years before. Its importance was greatly increased by St Bernard, who was bishop from 993 to 1022 and walled the town. By his example and patronage the art of working in metals was greatly stimulated. In the 13th century Hildesheim became a free city of the Empire; in 1249 it received municipal rights and about the same time it joined the Hanseatic league. Several of its bishops belonged to one or other of the great families of Germany; and gradually they became practically independent. The citizens were frequently quarrelling with the bishops, who also carried on wars with neighbouring princes, especially with the house of Brunswick-Lüneburg, under whose protection Hildesheim placed itself several times. The most celebrated of these struggles is the one known as the *Hildesheimer Stiftsfehde*, which broke out early in the 16th century when John, duke of Saxe-Lauenburg, was bishop. At first the bishop and his allies were successful, but in 1521 the king of Denmark and the duke of Brunswick overran his lands and in 1523 he made peace, surrendering nearly all his possessions. Much, however, was restored when Ferdinand, prince of Bavaria, was bishop (1612-1650), as this warlike prelate took advantage of the disturbances caused by the Thirty Years' War to seize the lost lands, and at the beginning of the 19th century the extent of the prince bishopric was 682 sq. m. In 1801 the bishopric was secularized and in 1803 was granted to Prussia; in 1807 it was incorporated with the kingdom of Westphalia and in 1813 was transferred to Hanover. In 1866, along with Hanover, it was annexed by Prussia. In 1803 a new bishopric of Hildesheim, a spiritual organization only, was established, and this has jurisdiction over all the Roman Catholic churches in the centre of north Germany.

In October 1868 a unique collection of ancient Augustan silver plate was discovered on the Galgenberg near Hildesheim by some soldiers who were throwing up earthworks. This *Hildesheimer Silberfund* excited great interest among classical archaeologists. Some authorities think that it is the actual plate which belonged to Drusus himself. The most noteworthy pieces are a crater richly ornamented with arabesques and figures of children, a platter with a representation of Minerva, another with one of the boy Hercules and another with one of Cybele. The collection is in the Kunstgewerbemuseum in Berlin. See the *Urkundenbuch der Stadt Hildesheim*, edited by R. Döbner (Hildesheim, 1881-1901); the *Urkundenbuch der Hochstifts Hildesheim*, edited by K. Janicke and H. Hoogeweg (Leipzig and Hanover, 1896-1903); C. Bauer, *Geschichte von Hildesheim* (Hildesheim, 1892); A. Bertram, *Geschichte des Bistums Hildesheim* (Hildesheim, 1899 fol.); C. Euling, *Hildesheimer Land und Leute des 16ten Jahrhunderts* (Hildesheim, 1892); O. Fischer, *Die Stadt Hildesheim während des dreissigjährigen Krieges* (Hildesheim, 1897); A. Crebe, *Auf Hildesheimern Boden* (Hildesheim, 1884); H. Cuno, *Hildesheims Künstler im Mittelalter* (Hildesheim, 1888);

W. Wachsmuth, *Geschichte von Hochstift und Stadt Hildesheim* (Hildesheim, 1863); R. Döbner, *Studien zur Hildesheimischen Geschichte* (Hildesheim, 1901); Lachner, *Die Holzarchitektur Hildesheims* (Hildesheim, 1882); Seifart, *Sagen, Märchen, Schwänke und Gebräuche aus Stadt und Stift Hildesheims* (Hildesheim, 1889). For the *Hildesheimer Stiftsfehde*, see H. Delius, *Die Hildesheimische Stiftsfehde 1510* (Leipzig, 1803). For the *Hildesheimer Silberfund*, see Wieseler, *Der Hildesheimer Silberfund* (Göttingen, 1869); Holzer, *Der Hildesheimer antike Silberfund* (Hildesheim, 1871); and E. Pernice and F. Winter, *Der Hildesheimer Silberfund der königlichen Museen zu Berlin* (Berlin, 1901).

HILDRETH, RICHARD (1807-1865), American journalist and author, was born at Deerfield, Massachusetts, on the 28th of June 1807, the son of Hosea Hildreth (1782-1835), a teacher of mathematics and later a Congregational minister. Richard graduated at Harvard in 1826, and, after studying law at Newburyport, was admitted to the bar at Boston in 1830. He had already taken to journalism, and in 1832 he became joint founder and editor of a daily newspaper, the *Boston Atlas*. Having in 1834 gone to the South for the benefit of his health, he was led by what he witnessed of the evils of slavery (chiefly in Florida) to write the anti-slavery novel *The Slave; or Memoir of Archy Moore* (1836; enlarged edition, 1852, *The White Slave*). In 1837 he wrote for the *Atlas* a series of articles vigorously opposing the annexation of Texas. In the same year he published *Banks, Banking, and Paper Currencies*, a work which helped to promote the growth of the free banking system in America. In 1838 he resumed his editorial duties on the *Atlas*, but in 1840 removed, on account of his health, to British Guiana, where he lived for three years and was editor of two weekly newspapers in succession at Georgetown. He published in this year (1840) a volume in opposition to slavery, *Despotism in America* (2nd ed., 1854). In 1840 he published the first three volumes of his *History of the United States*, two more volumes of which were published in 1851 and the sixth and last in 1852. The first three volumes of this history, his most important work, deal with the period 1492-1789, and the second three with the period 1789-1821. The history is notable for its painstaking accuracy and candour, but the later volumes have a strong Federalist bias. Hildreth's *Japan as It Was and Is* (1855) was at the time a valuable digest of the information contained in other works on that country (new ed., 1906). He also wrote a campaign biography of William Henry Harrison (1839); *Theory of Morals* (1844); and *Theory of Politics* (1853), as well as *Lives of Atrocious Judges* (1856), compiled from Lord Campbell's two works. In 1861 he was appointed United States consul at Trieste, but ill-health compelled him to resign and remove to Florence, where he died on the 11th of July 1865.

HILGENFELD, ADOLF BERNHARD CHRISTOPH (1822-1907), German Protestant divine, was born at Stappenbeck near Salzwedel in Prussian Saxony on the 2nd of June 1822. He studied at Berlin and Halle, and in 1850 became professor ordinarius of theology at Jena. He belonged to the Tübingen school. "Fond of emphasizing his independence of Baur, he still, in all important points, followed in the footsteps of his master; his method, which he is wont to contrast as *Literarkritik* with Baur's *Tendenzkritik*, is nevertheless essentially the same as Baur's" (Otto Pfeleiderer). On the whole, however, he modified the positions of the founder of the Tübingen school, going beyond him only in his investigations into the Fourth Gospel. In 1858 he became editor of the *Zeitschrift für wissenschaftliche Theologie*. He died on the 12th of January 1907.

His works include: *Die elementarischen Recognitionen und Homilien* (1848); *Die Evangelien und die Briefe des Johannes nach ihrem Lehrbegriff* (1849); *Das Markusevangelium* (1850); *Die Epistolen nach ihrer Entstehung und geschichtlichen Bedeutung* (1854); *Das Unchristentum* (1855); *Jüd. Apokalypthik* (1857); *Novum Testamentum extra canonem receptum* (4 parts, 1866; 2nd ed., 1876-1884); *Histor. kritische Einleitung in das Neue Testament* (1875); *Acta Apostolorum graece et latine secundum antiquissimos testes* (1899); the first complete edition of the *Shepherd of Hermas* (1887); *Ignatio et Polycarpi epistolae* (1902).

HILL, AARON (1685-1750), English author, was born in London on the 10th of February 1685. He was the son of George Hill of Malmesbury Abbey, Wiltshire, who contrived to sell an estate entailed on his son. In his fourteenth year he

left Westminster School to go to Constanthorpe, where William, Lord Paget de Beaudesert (1637-1713), a relative of his mother, was ambassador. Paget sent him, under care of a tutor, to travel in Palestine and Egypt, and he returned to England in 1703. He was estranged from his patron by the "envious fears and malice of a certain female," and again went abroad as companion to Sir William Wentworth. On his return home in 1709 he published *A Full and Just Account of the Present State of the Ottoman Empire*, a production of which he was afterwards much ashamed, and he addressed his poem of *Camillus* to Charles Mordaunt, earl of Peterborough. In the same year he is said to have been manager of Drury Lane theatre and in 1710 of the Haymarket. His first play, *Elfrid; or The Fair Inconstant* (afterwards revised as *Althowald*), was produced at Drury Lane in 1709. His connexion with the theatre was of short duration, and the rest of his life was spent in ingenious commercial enterprises, none of which were successful, and in literary pursuits. He formed a company to extract oil from beechmast, another for the colonization of the district to be known later as Georgia, a third to supply wood for naval construction from Scotland, and a fourth for the manufacture of potash. In 1730 he wrote *The Progress of Wit, being a caveat for the use of an Eminent Writer*. The "eminent writer" was Pope, who had introduced him into *The Duaciad* as one of the competitors for the prize offered by the goddess of Dullness, though the satire was qualified by an oblique compliment. A note in the edition of 1729 on the obnoxious passage, in which, however, the original initial was replaced by asterisks, gave Hill great offence. He wrote to Pope complaining of his treatment, and received a reply in which Pope denied responsibility for the notes. Hill appears to have been a persistent correspondent, and inflicted on Pope a series of letters, which are printed in Elwin & Courthope's edition (x. 1-78). Hill died on the 8th of February 1750, and was buried in Westminster Abbey. The best of his plays were *Zara* (acted 1735) and *Merope* (1749), both adaptations from Voltaire. He also published two series of periodical essays, *The Prompter* (1735) and, with William Bond, *The Plaindealer* (1724). He was generous to fellow-men of letters, and his letters to Richard Savage, whom he helped considerably, show his character in a very amiable light.

The Works of the late Aaron Hill, consisting of letters . . . original poems . . . With an essay on the Art of Acting appeared in 1753, and his *Dramatic Works* in 1760. His *Poetical Works* are included in Anderson's and other editions of the British poets. A full account of his life is provided by an anonymous writer in Theophilus Cibber's *Lives of the Poets*, vol. v.

HILL, AMBROSE POWELL (1825-1865), American Confederate soldier, was born in Culpeper county, Virginia, on the 9th of November 1825, and graduated from West Point in 1847, being appointed to the 1st U.S. artillery. He served in the Mexican and Seminole Wars, was promoted first lieutenant in September 1851, and in 1855-1860 was employed on the United States' coast survey. In March 1861, just before the outbreak of the Civil War, he resigned his commission, and when his state seceded he was made colonel of a Virginian infantry regiment, winning promotion to the rank of brigadier-general on the field of Bull Run. In the Peninsular campaign of 1862 he gained further promotion, and as a major-general Hill was one of the most prominent and successful divisional commanders of Lee's army in the Seven Days', Second Bull Run, Antietam and Fredericksburg campaigns. His division formed part of "Stonewall" Jackson's corps, and he was severely wounded in the flank attack of Chancellorsville in May 1863. After Jackson's death Hill was made a lieutenant-general and placed in command of the 3rd corps of Lee's army, which he led in the Gettysburg campaign of 1863, the autumn campaign of the same year, and the Wilderness and Petersburg operations of 1864-65. He was killed in front of the Petersburg lines on the 2nd of April 1865. His reputation as a troop leader in battle was one of the highest amongst the generals of both sides, and both Lee and Jackson, when on their death-beds their thoughts wandered in despondency to the battlefield, called for "A. P. Hill" to deliver the decisive blow.

HILL, DANIEL HARVEY (1801-1886), American Confederate soldier, was born in York district, South Carolina, on the 12th of July 1821, and graduated at the United States Military Academy in 1842, being appointed to the 1st United States artillery. He distinguished himself in the Mexican War, being breveted captain and major for bravery at Contreras and Churubusco and at Chapultepec respectively. In February 1849 he resigned his commission and became a professor of mathematics at Washington College (now Washington and Lee University), Lexington, Virginia. In 1854 he joined the faculty of Davidson College, North Carolina, and was in 1859 made superintendent of the North Carolina Military Institute of Charlotte. At the outbreak of the Civil War, D. H. Hill was made colonel of a Confederate infantry regiment, at the head of which he won the action of Big Bethel, near Fortress Monroe, Va., on the 10th of June 1861. Shortly after this he was made a brigadier-general. He took part in the Yorktown and Williamsburg operations in the spring of 1862, and as a major-general led a division with great distinction in the battle of Fair Oaks and the Seven Days. He took part in the Second Bull Run campaign in August-September 1862, and in the Antietam campaign the stubborn resistance of D. H. Hill's division in the passes of South Mountain enabled Lee to concentrate for battle. The division bore a conspicuous part in the battles of the Antietam and Fredericksburg. On the reorganization of the army of Northern Virginia after Jackson's death, D. H. Hill was not appointed to a corps command, but somewhat later in 1863 he was sent to the west as a lieutenant-general and commanded one of Bragg's corps in the brilliant victory of Chickamauga. D. H. Hill surrendered with Gen. J. E. Johnston on the 26th of April 1865. In 1866-1869 he edited a magazine, *The Land we Love*, at Charlotte, N.C., which dealt with social and historical subjects and had a great influence in the South. In 1877 he became president of the university of Arkansas, a post which he held until 1884, and in 1885 president of the Military and Agricultural College of Milledgeville, Georgia. General Hill died at Charlotte, N.C., on the 24th of September 1889.

HILL, DAVID BENNETT (1843-1910), American politician, was born at Havana, New York, on the 29th of August 1843. In 1862 he removed to Elmira, New York, where in 1864 he was admitted to the bar. He at once became active in the affairs of the Democratic party, attracting the attention of Samuel J. Tilden, one of whose shrewdest and ablest lieutenants he became. In 1871 and 1872 he was a member of the New York State Assembly, and in 1877 and again in 1881 presided over the Democratic State Convention. In 1882 he was elected mayor of Elmira, and in the same year was chosen lieutenant-governor of the state, having been defeated for nomination as governor by Grover Cleveland. In January 1885, however, Cleveland having resigned to become president, Hill became governor, and in November was elected for a three-year term, and subsequently re-elected. In 1891-1897 he was a member of the United States Senate. During these years, and in 1892, when he tried to get the presidential nomination, he was prominent in working against Cleveland. In 1896 he opposed the free silver plank in the platform adopted by the Democratic National Convention which nominated W. J. Bryan; in the National Convention of 1900, however, the free-silver issue having been subordinated to anti-imperialism, he seconded Bryan's nomination. After 1897 he devoted himself to his law practice, and in 1905 retired from politics. He died in Albany on the 30th of October 1910.

HILL, GEORGE BIRKBECK NORMAN (1835-1903), English author, son of Arthur Hill, head master of Bruce Castle school, was born at Tottenham, Middlesex, on the 7th of June 1835. Arthur Hill, with his brothers Rowland Hill, the postal reformer, and Matthew Davenport Hill, afterwards recorder of Birmingham, had worked out a system of education which was to exclude compulsion of any kind. The school at Bruce Castle, of which Arthur Hill was head master, was founded to carry into execution their theories, known as the Hazelwood system. George Birkbeck Hill was educated in his father's school and at Pembroke College, Oxford. In 1858 he began to teach at Bruce Castle school, and

from 1868 to 1877 was head master. In 1869 he became a regular contributor to the *Saturday Review*, with which he remained in connexion until 1884. On his retirement from teaching he devoted himself to the study of English 18th-century literature, and established his reputation as the most learned commentator on the works of Samuel Johnson. He settled at Oxford in 1837, but from 1891 onwards his winters were usually spent abroad. He died at Hampstead, London, on the 27th of February 1903. His works include: *Dr Johnson, his Friends and his Critics* (1878); an edition of Boswell's *Correspondence* (1879); a laborious edition of *Boswell's Life of Johnson, including Boswell's Journal of a Tour to the Hebrides, and Johnson's Diary of a Journey into North Wales* (Clarendon Press, 6 vols., 1887); *Wisdom and Wisdom of Samuel Johnson* (1888); *Select Essays of Dr Johnson* (1889); *Footsteps of Dr Johnson in Scotland* (1890); *Letters of Johnson* (1892); *Johnsonian Miscellanies* (2 vols., 1897); an edition (1900) of Edward Gibbon's *Autobiography*; Johnson's *Lives of the Poets* (3 vols., 1905), and other works on the 18th-century topics. Dr Birkbeck Hill's elaborate edition of Boswell's *Life* is a monumental work, invaluable to the student.

See a memoir by his nephew, Harold Spencer Scott, in the edition of *The Lives of the English Poets* (1905), and the *Letters* edited by his daughter, Lucy Crump, in 1903.

HILL, JAMES J. (1838-), American railway capitalist, was born near Guelph, Ontario, Canada, on the 16th of September 1838, and was educated at Rockwood (Ont.) Academy, a Quaker institution. In 1856 he settled in St Paul, Minnesota. Abandoning, because of his father's death, his plans to study medicine, he became a clerk in the office of a firm of river steamboat agents and shippers, and later the agent for a line of river packets; he established about 1870 transportation lines on the Mississippi and on the Red River (of the North). He effected a traffic arrangement between the St Paul Pacific Railroad and his steamboat lines; and when the railway failed in 1873 for \$27,000,000, Hill interested Sir Donald A. Smith (Lord Strathcona), George Stephen (Lord Mount Stephen), and other Canadian capitalists, in the road and in the wheat country of the Red River Valley; he got control of the bonds (1878), foreclosed the mortgage, reorganized the road as the St Paul, Minneapolis & Manitoba, and began to extend the line, then only 380 m. long, toward the Pacific; and in 1883 he became its president. He was president of the Great Northern Railway (comprehending all his secondary lines) from 1893 to April 1907, when he became chairman of its board of directors. In the extension (1883-1893) of this railway westward to Puget Sound (whence it has direct steamship connexions with China and Japan), the line was built by the company itself, none of the work being handled by contractors. Subsequently his financial interests in American railways caused constant sensations in the stock-markets. The Hill interests obtained control not only of the Great-Northern system, but of the Northern Pacific and the Chicago, Burlington & Quincy, and proposed the construction of another northern line to the Pacific coast. Hill was the president of the Northern Securities Company, which in 1904 was declared by the United States Supreme Court to be in conflict with the Sherman Anti-Trust Law. (See Vol. 27, p. 733.) Among Hill's gifts to public institutions was one of \$500,000 to the St. Paul Theological Seminary (Roman Catholic).

HILL, JOHN (c. 1716-1775), called from his Swedish honours, "Sir" John Hill, English author, son of the Rev. Theophilus Hill, is said to have been born in Peterborough in 1716. He was apprenticed to an apothecary and on the completion of his apprenticeship he set up in a small shop in St Martin's Lane, Westminster. He also travelled over the country in search of rare herbs, with a view to publishing a *hortus sicus*, but the plan failed. His first publication was a translation of Theophrastus's *History of Stones* (1746). From this time forward he was an indefatigable writer. He edited the *British Magazine* (1746-1750), and for two years (1751-1753) he wrote a daily letter, "The Inspector," for the *London Advertiser and Literary Gazette*. He also produced novels, plays and scientific works, and was a large contributor to the supplement of Ephraim

Chambers's *Cyclopaedia*. His personal and scurrilous writings involved him in many quarrels. Henry Fielding attacked him in the *Covent Garden Journal*, Christopher Smart wrote a mock-epic, *The Hiliad*, against him, and David Garrick replied to his strictures against him by two epigrams, one of which runs—

"For physics and farces, his equal there scarce is;
His farces are physic, his physic a farce is."

He had other literary passages-at-arms with John Rich, who accused him of plagiarising his *Orpheus*, also with Samuel Foote and Henry Woodward. From 1759 to 1775 he was engaged on a huge botanical work—*The Vegetable System* (36 vols. fol.)—adorned by 1600 copperplate engravings. Hill's botanical labours were undertaken at the request of his patron, Lord Bute, and he was rewarded by the order of Vasa from the king of Sweden in 1774. He had a medical degree from Edinburgh, and he now practised as a quack doctor, making considerable sums by the preparation of vegetable medicines. He died in London on the 21st of November 1775.

Of the seventy-six separate works with which he is credited in the *Dictionary of National Biography*, the most valuable are those that deal with botany. He is said to have been the author of the second part of *The Oeconomy of Human Life* (1751), the first part of which is by Lord Chesterfield, and Hannah Glasse's famous manual of cookery was generally ascribed to him (see Boswell, ed. Hill, iii. 285). Dr Johnson said of him that he was "an ingenious man, but had no veracity."

See a *Short Account of the Life, Writings and Character of the late Sir John Hill* (1779), which is chiefly occupied with a descriptive catalogue of his works; also *Temple Bar* (1872, xxxv. 261-266).

HILL, MATTHEW DAVENPORT (1792-1872), English lawyer and penologist, was born on the 6th of August 1792, at Birmingham, where his father, T. W. Hill, for long conducted a private-school. He was a brother of Sir Rowland Hill. He early acted as assistant in his father's school, but in 1819 was called to the bar at Lincoln's Inn. He went the midland circuit. In 1832 he was elected one of the Liberal members for Kingston-upon-Hull, but he lost his seat at the next election in 1834. On the incorporation of Birmingham in 1839 he was chosen recorder; and in 1851 he was appointed commissioner in bankruptcy for the Bristol district. Having had his interest excited in questions relating to the treatment of criminal offenders, he ventilated in his charges to the grand juries, as well as in special pamphlets, opinions which were the means of introducing many important reforms in the methods of dealing with crime. One of his principal coadjutors in these reforms was his brother Frederick Hill (1803-1896), whose *Amount, Causes and Remedies of Crime*, the result of his experience as inspector of prisons for Scotland, marked an era in the methods of prison discipline. Hill was one of the chief promoters of the Society for the Diffusion of Useful Knowledge, and the originator of the *Penny Magazine*. He died at Stapleton, near Bristol, on the 7th of June 1872.

His principal works are *Practical Suggestions to the Founders of Reformatory Schools* (1855); *Suggestions for the Reformation of Crime* (1857), consisting of charges addressed to the grand juries of Birmingham; *Mellray* (1855); *Papers on the Penal Servitude Acts* (1864); *Journal of a Third Visit to the Convict Gaols, Refuges and Reformatories of Dublin* (1865); *Addresses delivered at the Birmingham and Midland Institute* (1867). See *Memoir of Matthew Davenport Hill*, by his daughters Rosamond and Florence Davenport Hill (1878).

HILL, OCTAVIA (1838-) and **MIRANDA** (1836-1910), English philanthropic workers, were born in London, being daughters of Mr. James Hill and granddaughters of Dr Southwood Smith, the pioneer of sanitary reform. Miss Octavia Hill's attention was early drawn to the evils of London housing, and the habits of indolence and lethargy induced in many of the lower classes by their degrading surroundings. She conceived the idea of trying to free a few poor people from such influences, and Mr. Ruskin, who sympathized with her plans, supplied the money for starting the work. For £750 Miss Hill purchased the 56 years' lease of three houses in one of the poorest courts of Marylebone. Another £78 was spent in building a large room at the back of her own house where she could meet the tenants. The houses were put in repair, and let out in sets of two rooms. At the end of eighteen months

it was possible to pay 5% interest, to repay £48 of the capital, as well as meet all expenses for taxes, ground rent and insurance. What specially distinguished this scheme was that Miss Hill herself collected the rents, thus coming into contact with the tenants and helping to enforce regular and self-respecting habits. The success of her first attempt encouraged her to continue. Six more houses were bought and treated in a similar manner. A yearly sum was set aside for the repairs of each house, and whatever remained over was spent on such additional appliances as the tenants themselves desired. This encouraged them to keep their tenements in good repair. By the help of friends Miss Hill was now enabled to enlarge the scope of her work. In 1869 eleven more houses were bought. The plan was to set a visitor over a small court or block of buildings to do whatever work in the way of rent-collecting, visiting for the School Board, &c., was required. As years went on Miss Octavia Hill's work was largely increased. Numbers of her friends bought and placed under her care small groups of houses, over which she fulfilled the duties of a conscientious landlord. Several able owners of tenement houses, notably the Ecclesiastical Commissioners, entrusted to her the management of such property, and consulted her about plans of rebuilding; and a number of fellow-workers were trained by her in the management of houses for the poor. The results in Southwark (where Red Cross Hall was established) and elsewhere were very beneficial. Both Miss Miranda and Miss Octavia Hill took an interest in the movement for bringing beauty into the homes of the poor, and the former was practically the founder of the Kyrle Society, the first suggestion of which was contained in a paper read to a small circle of friends. Both sisters worked for the preservation of open spaces, and helped to promote the work of the Charity Organisation Society, and for several years Miss Miranda Hill (who died on the 31st of May 1910) did admirable work in Marylebone as a member of the Board of Guardians.

HILL, ROWLAND (1744-1833), English preacher, sixth son of Sir Rowland Hill, Bart. (d. 1783), was born at Hawkstone, Shropshire, on the 23rd of August 1744. He was educated at Shrewsbury, Eton and St John's College, Cambridge. Stimulated by George Whitefield's example, he scandalized the university authorities and his own friends by preaching and visiting the sick before he had taken orders. In 1773 he was appointed to the parish of Kingston, Somersetshire, where he soon attracted great crowds to his open-air services. Having inherited considerable property, he built for his own use Surrey Chapel, in the Blackfriars Road, London (1783). Hill conducted his services in accordance with the forms of the Church of England, in whose communion he always remained. Both at Surrey Chapel and in his provincial "gospel tours" he had great success. His oratory was specially adapted for rude and uncultivated audiences. He possessed a voice of great power, and according to Southey "his manner" was "that of a performer as great in his own line as Kean or Kemble." His earnest and pure purposes more than made up for his occasional lapses from good taste and the eccentricity of his wit. He helped to found the Religious Tract Society, the British and Foreign Bible Society, and the London Missionary Society, and was a stout advocate of vaccination. His best-known work is the *Village Dialogues*, which first appeared in 1810, and reached a 34th edition in 1839. He died on the 11th of April 1833.

See *Life* by E. Sidney (1833); *Memoirs*, by William Jones (1834); and *Memoirs*, by Jsa. Sherman (1857).

HILL, SIR ROWLAND (1795-1879), English administrator, author of the penny postal system, a younger brother of Matthew Davenport Hill, and third son of T. W. Hill, who named him after Rowland Hill the preacher, was born on the 3rd of December 1795 at Kidderminster. As a young child he had, on account of an affection of the spine, to maintain a recumbent position, and his principal method of relieving the irksomeness of his situation was to repeat figures aloud consecutively until he had reached very high totals. A similar bent of mind was manifested when he entered school in 1802, his aptitude for mathematics

being quite exceptional. But he was indebted for the direction of his abilities in no small degree to the guidance of his father, a man of advanced political and social views, which were qualified and balanced by the strong practical tendency of his mind. At the age of twelve Rowland began to assist in teaching mathematics in his father's school at Hilltop, Birmingham, and latterly he had the chief management of the school. On his suggestion the establishment was removed in 1819 to Hazelwood, a more commodious building in the Hagley Road, in order to have the advantages of a large body of boys, for the purpose of properly carrying out an improved system of education. That system, which was devised principally by Rowland, was expounded in a pamphlet entitled *Plans for the Government and Education of Boys in Large Numbers*, the first edition of which appeared in 1822, and a second with additions in 1827. The principal feature of the system was "to leave as much as possible all power in the hands of the boys themselves"; and it was so successful that, in a circular issued six years after the experiment had been in operation, it was announced that "the head master had never once exercised his right of veto on their proceedings." It may be said that Rowland Hill, as an educationist, is entitled to a place side by side with Arnold of Rugby; and was equally successful with him in making moral influence of the highest kind the predominant power in school discipline. After his marriage in 1827 Hill removed to a new school at Bruce Castle, Tottenham, which he conducted until failing health compelled him to retire in 1833. About this time he became secretary of Gibbon Wakefield's scheme for colonizing South Australia, the objects of which he explained in 1832 in a pamphlet on *Home Colonies*, afterwards partly reprinted during the Irish famine under the title *Home Colonies for Ireland*. It was in 1835 that his zeal as an administrative reformer was first directed to the postal system. The discovery which resulted from these investigations is when stated so easy of comprehension that there is great danger of losing sight of its originality and thoroughness. A fact which enhances its merit was that he was not a post-office official, and possessed no practical experience of the details of the old system. After a laborious collection of statistics, he succeeded in demonstrating that the principal expense of letter carriage was in receiving and distributing, and that the cost of conveyance differed so little with the distance that a uniform rate of postage was in reality the fairest to all parties that could be adopted. Trusting also that the deficiency in the postal rate would be made up by the immense increase of correspondence, and by the saving which would be obtained from prepayment, from improved methods of keeping accounts, and from lessening the expense of distribution, he in his famous pamphlet published in 1837 recommended that within the United Kingdom the rate for letters not exceeding half an ounce in weight should be only one penny. The employment of postage stamps is mentioned only as a suggestion, and in the following words: "Perhaps the difficulties might be obviated by using a bit of paper just large enough to bear the stamp, and covered at the back with a glutinous wash which by applying a little moisture might be attached to the back of the letter." Proposals so striking and novel in regard to a subject in which every one had a personal interest commanded immediate and general attention. So great became the pressure of public opinion against the opposition offered to the measure by official prepossessions and prejudices that in 1838 the House of Commons appointed a committee to examine the subject. The committee having reported favourably, a bill to carry out Hill's recommendations was brought in by the government. The act received the royal assent in 1839, and after an intermediate rate of fourpence had been in operation from the 31st of December of that year, the penny rate commenced on the 10th of January 1840. Hill received an appointment in the Treasury in order to superintend the introduction of his reforms, but he was compelled to retire when the Liberal government resigned office in 1841. In consideration of the loss he thus sustained, and to mark the public appreciation of his services, he was in 1846 presented with the sum of £13,360. On the Liberals returning to office

in the same year he was appointed secretary to the postmaster-general and in 1854 he was made chief secretary. His ability as a practical administrator enabled him to supplement his original discovery by measures realizing its benefits in a degree commensurate with continually improving facilities of communication, and in a manner best combining cheapness with efficiency. In 1860 his services were rewarded with the honour of knighthood; and when failing health compelled him to resign his office in 1864, he received from parliament a grant of £20,000 and was also allowed to retain his full salary of £2000 a year as retiring pension. In 1864 the university of Oxford conferred on him the degree of D.C.L., and on the 6th of June 1870 he was presented with the freedom of the city of London. The presentation, on account of his infirm health, took place at his residence at Hampstead, and he died on the 27th of August following. He was buried in Westminster Abbey.

He wrote, in conjunction with his brother, Arthur Hill, a *History of Penny Postage*, published in 1880, with an introductory memoir by his nephew, G. Birkbeck Hill. See also *Sir Rowland Hill, the Story of a Great Reform*, told by his daughter (1907). To commemorate his memory the Rowland Hill Memorial and Benevolent Fund was founded shortly after his death for the purpose of relieving distressed persons connected with the post office who were outside the scope of the Superannuation Act. See also POST AND POSTAL SERVICE.

HILL, ROWLAND HILL, 1ST VISCOUNT (1772-1842), British general, was the second son of (Sir) John Hill, of Hawkstone, Shropshire, and nephew of the Rev. Rowland Hill (1744-1833), was born at Prees Hall near Hawkstone on the 11th of August 1772. He was gazetted to the 38th regiment in 1790, obtaining permission at the same time to study in a military academy at Strassburg, where he continued after removing into the 53rd regiment with the rank of lieutenant in 1791. In the beginning of 1793 he raised a company, and was promoted to the rank of captain. The same year he acted as assistant secretary to the British minister at Genoa, and served with distinction as a staff officer in the siege of Toulon. Hill took part in many minor expeditions in the following years. In 1800, when only twenty-eight, he was made a brevet colonel, and in 1801 he served with distinction in Sir Ralph Abercromby's expedition to Egypt, and was wounded at the battle of Alexandria. He continued to command his regiment, the 90th, until 1803, when he became a brigadier-general. During his regimental command he introduced a regimental school and a sergeants' mess. He held various commands as brigadier, and after 1805 as major-general, in Ireland. In 1805 he commanded a brigade in the abortive Hanover expedition. In 1808 he was appointed to a brigade in the force sent to Portugal, and from Vimeira to Vittoria, in advance or retreat, he proved himself Wellington's ablest and most indefatigable coadjutor. He led a brigade at Vimeira, at Corunna and at Oporto, and a division at Talavera (see PENINSULAR WAR). His capacity for independent command was fully demonstrated in the campaigns of 1810, 1811 and 1812. In 1811 he annihilated a French detachment under Girard at Arroyo-dos-Molinos, and early in 1812, having now attained a rank of lieutenant-general (January 1812) and become a K.B. (March), he carried by assault the important works of Almaraz on the Tagus. Hill led the right wing of Wellington's army in the Salamanca campaign in 1812 and at the battle of Vittoria in 1813. Later in this year he conducted the investment of Pampeluna and fought with the greatest distinction at the Nivelle and the Nive. In the invasion of France in 1814 his corps was victoriously engaged both at Orthez and at Toulouse. Hill was one of the general officers rewarded for their services by peerages, his title being at first Baron Hill of Almaraz and Hawkstone, and he received a pension, the thanks of parliament and the freedom of the city of London. For about two years previous to his elevation to the peerage, he had been M.P. for Shrewsbury. In 1815 the news of Napoleon's return from Elba was followed by the assembly of an Anglo-Allied army (see WATERLOO CAMPAIGN) in the Netherlands, and Hill was appointed to one of the two corps commands in this army. At Waterloo he led the famous charge of Sir Frederick Adams's brigade against the Imperial Guard, and for some time it was thought that he

had fallen in the middle. He escaped, however, without a wound, and continued with the army in France until its withdrawal in 1818. Hill lived in retirement for some years at his estate of Hardwicke Grange. He carried the royal standard at the coronation of George IV. and became general in 1825. When Wellington became premier in 1828, he received the appointment of general commanding-in-chief, and on resigning this office in 1842 he was created a viscount. He died on the 10th of December of the same year. Lord Hill was, next to Wellington, the most popular and able soldier of his time in the British service, and was so much beloved by the troops, especially those under his immediate command, that he gained from them the title of "the soldier's friend." He was a G.C.B. and G.C.H., and held the grand crosses of various foreign orders, amongst them the Russian St. George and the Austrian Maria Theresia.

The *Life of Lord Hill, G.C.B.*, by Rev. Edwin Sidney, appeared in 1845.

HILL (O. Eng. *hyl*; cf. Low Ger *hull*, Mid. Dutch *hul*, allied to Lat. *collis*, high, *collis*, hill, &c.), a natural elevation of the earth's surface. The term is now usually confined to elevations lower than a mountain, but formerly was used for all such elevations, high or low.

HILLAH, a town of Asiatic Turkey, in the pashalik of Bagdad, 60 m. S. of the city of Bagdad, in 32° 28' 35" N., 44° 48' 40" E., formerly the capital of a sanjak and the residence of a mutasserif, who in 1803 was transferred to Diwanieh. It is situated on both banks of the Euphrates, the two parts of the town being connected by a floating bridge, 450 ft. in length, in the midst of a very fertile district. The estimated population, which includes a large number of Jews, varies from 6000 to 12,000. The town has suffered much from the periodical breaking of the Hindieh dam and the consequent deflection of the waters of the Euphrates to the westward, as a result of which at times the Euphrates at this point has been entirely dry. This deflection of water has also seriously interfered with the palm groves, the cultivation of which constitutes a large part of the industry of the surrounding country along the river. The bazaars of Hillah are relatively large and well supplied. Many of the houses in the town are built of brick, not a few bearing an inscription of Nebuchadrezzar, obtained from the ruins of Babylon, which lie less than an hour away to the north.

BIBLIOGRAPHY.—C. J. Rich, *Babylon and Persepolis* (1839); J. R. Peters, *Nippur* (1857); H. Rassam, *Asshur and the Land of Nimrod* (1897); H. V. Geere, *By Nile and Euphrates* (1904). (J. P. Pr.)

HILLARD, GEORGE STILLMAN (1808-1879), American lawyer and author, was born at Machias, Maine, on the 22nd of September 1808. After graduating at Harvard College in 1828, he taught in the Round Hill School at Northampton, Massachusetts. He graduated at the Harvard Law School in 1832, and in 1833 he was admitted to the bar in Boston, where he entered into partnership with Charles Sumner. He was a member of the state House of Representatives in 1836, of the state Senate in 1850, and of the state constitutional convention of 1853, and in 1866-70 was United States district attorney for Massachusetts. He devoted a large portion of his time to literature. He became a member of the editorial staff of the *Christian Register*, a Unitarian weekly, in 1833; in 1834 he became editor of *The American Jurist* (1839-1843), a legal journal to which Sumner, Simon Greenleaf and Theron Metcalf contributed; and from 1856 to 1861 he was an associate editor of the *Boston Courier*. His publications include an edition of Edmund Spenser's works (in 3 vols., 1839); *Selections from the Writings of Walter Savage Landor* (1856); *Six Months in Italy* (2 vols., 1853); *Life and Campaigns of George E. McClellan* (1864); a part of the *Life, Letters, and Journals of George Ticknor* (1846); besides a series of school readers and many articles in periodicals and encyclopaedias. He died in Boston on the 21st of January 1879.

HILLEBRAND, KARL (1829-1884), German author, was born at Giessen on the 17th of September 1829, his father Joseph Hillebrand (1788-1871) being a literary historian and writer on philosophic subjects. Karl Hillebrand became involved, as a student in Heidelberg, in the Baden revolutionary move-

ment, and was imprisoned in Rastatt. He succeeded in escaping and lived for a time in Straasburg, Paris—where for several months he was Heine's secretary—and Bordeaux. He continued his studies, and after obtaining the doctor's degree at the Sorbonne, he was appointed teacher of German in the *École militaire* at St. Cyr, and shortly afterwards, professor of foreign literatures at Douai. On the outbreak of the Franco-German War he resigned his professorship and acted for a time as correspondent to *The Times* in Italy. He then settled in Florence, where he died on the 19th of October 1884. Hillebrand wrote with facility and elegance in French, English and Italian, besides his own language. His essays, collected under the title *Zeiten, Völker und Menschen* (Berlin, 1874-1885), show clear discernment, a finely balanced cosmopolitan judgment and grace of style. He undertook to write the *Geschichte Frankreichs von der Thronbesteigung Ludwig Philipps bis zum Fall Napoleons III.*, but only two volumes were completed (to 1848) (2nd ed., 1881-1882). In French he published *Des conditions de la bonne comédie* (1863), *La France contemporaine* (1867), *Études italiennes* (1868), and a translation of O. Müller's *Griechische Literaturgeschichte* (3rd ed., 1883). In English he published his Royal Institution Lectures on *German Thought during the Last Two Hundred Years* (1880). He also edited a collection of essays dealing with Italy, under the title *Italia* (4 vols., Leipzig, 1874-1877).

See H. Homberger, *Karl Hillebrand* (Berlin, 1884).

HILLEL, Jewish rabbi, of Babylonian origin, lived at Jerusalem in the time of King Herod. Though hard pressed by poverty, he applied himself to study in the schools of Shemaiah and Abtalion (Sameas and Pollion in Josephus). On account of his comprehensive learning and his rare qualities he was numbered among the recognized leaders of the Pharisaic scribes. Tradition assigns him the highest dignity of the Sanhedrin, under the title of *nasi* ("prince"), about a hundred years before the destruction of Jerusalem, i.e. about 30 B.C. The date at least can be recognized as historic; the fact that Hillel took a leading position in the council can also be established. The epithet *ha-zeken* ("the elder"), which usually accompanies his name, proves him to have been a member of the Sanhedrin, and according to a trustworthy authority Hillel filled his leading position for forty years, dying, therefore, about A.D. 20. His descendants remained, with few exceptions, at the head of Judaism in Palestine until the beginning of the 5th century, two of them, his grandson Gamaliel I. and the latter's son Simon, during the time when the Temple was still standing. The fact that Josephus (*Vita* 38) ascribes to Simon descent from a very distinguished stock (*γένεως σφόδρα λαμπρῆς*), shows in what degree of estimation Hillel's descendants stood. When the dignity of *nasi* became afterwards hereditary among them, Hillel's ancestry, perhaps on the ground of old family traditions, was traced back to David. Hillel is especially noted for the fact that he gave a definite form to the Jewish traditional learning, as it had been developed and made into the ruling and conserving factor of Judaism in the latter days of the second Temple, and particularly in the centuries following the destruction of the Temple. He laid down seven rules for the interpretation of the Scriptures, and these became the foundation of rabbinical hermeneutics; and the ordering of the traditional doctrines into a whole, effected in the Mishna by his successor Judah I. two hundred years after Hillel's death, was probably likewise due to his instigation. The tendency of his theory and practice in matters pertaining to the Law is evidenced by the fact that in general he advanced milder and more lenient views in opposition to his colleague Shammai, a contrast which after the death of the two masters, but not until after the destruction of the Temple, was maintained in the strife kept up between the two schools named the House of Hillel and the House of Shammai. The well-known institution of the *Prosbol* (*προσβολή*), introduced by Hillel, was intended to avert the evil consequences of the scriptural law of release in the seventh year (Deut. xv. 1). He was led to this, as is expressly set forth (*M. Gittin*, iv. 3), by a regard for the welfare of the community. Hillel lived in the

memory of posterity chiefly as the great teacher who enjoined and practised the virtues of charity, humility and true piety. His proverbial sayings, in particular, a great number of which were written down partly in Aramaic, partly in Hebrew, strongly affected the spirit both of his contemporaries and of the succeeding generations. In his *Maxims* (*Aboth*, i. 12) he recommends the love of peace and the love of mankind beyond all else, and his own love of peace sprang from the tenderness and deep humility which were essential features in his character, as has been illustrated by many anecdotes. Hillel's patience has become proverbial. One of his sayings commends humility in the following paradox: "My abasement is my exaltation." His charity towards men is given its finest expression in the answer which he made to a proselyte who asked to be taught the commandments of the Torah in the shortest possible form: "What is unpleasant to thyself that do not to thy neighbour; this is the whole Law, all else is but its exposition." This allusion to the scriptural injunction to love one's neighbour (*Lev. xix. 18*) as the fundamental law of religious morals, became in a certain sense a commonplace of Pharisaic scholasticism. For the Pharisee who accepts the answer of Jesus regarding that fundamental doctrine which ranks the love of one's neighbour as the highest duty after the love of God (*Mark xii. 33*), does so because as a disciple of Hillel the idea is familiar to him. St Paul also (*Gal. v. 14*) doubtless learned this in the school of Gamaliel. Hillel emphasized the connexion between duty towards one's neighbour and duty towards oneself in the epigrammatic saying: "If I am not for myself, who is for me? And if I am for myself alone, what then am I? And if not now, then when?" (*Aboth*, i. 14). The duty of working both with and for men he teaches in the sentence: "Separate not thyself from the congregation" (*ib.* ii. 4). The duty of considering oneself part of common humanity, of not differing from others by any peculiarity of behaviour, he sums up in the words: "Appear neither naked nor clothed, neither sitting nor standing, neither laughing nor weeping" (*Tosef. Ber. c. ii.*). The command to love one's neighbour inspired also Hillel's injunction (*Aboth*, ii. 4): "Judge not thy neighbour until thou art in his place" (*cf. Matt. vii. 1*). The disinterested pursuit of learning, study for study's sake, is commended in many of Hillel's sayings as being what is best in life: "He who wishes to make a name for himself loses his name; he who does not increase [his knowledge] decreases it; he who does not learn is worthy of death; he who works for the sake of a crown is lost" (*Aboth*, i. 13). "He who occupies himself much with learning makes his life" (*ib.* ii. 7). "He who has acquired the words of doctrine has acquired the life of the world to come" (*ib.*). "Say not: When I am free from other occupations I shall study; for may be thou shalt never at all be free" (*ib.* 4). One of his strings of proverbs runs as follows: "The uncultivated man is not innocent; the ignorant man is not devout; the bashful man learns not; the wrathful man teaches not; he who is much absorbed in trade cannot become wise; where no men are, there strive thyself to be a man" (*ib.* 5). The almost mystical profundity of Hillel's consciousness of God is shown in the words spoken by him on the occasion of a feast in the Temple—words alluding to the throng of people gathered there which he puts into the mouth of God Himself: "If I am here every one is here; if I am not here no one is here" (*Sukkah* 53a). In like manner Hillel makes God say to Israel, referring to Exodus xx. 24: "Whither I please, thither will I go; if thou come into my house I come into thy house; if thou come not into my house, I come not into thine" (*ib.*).

It is noteworthy that no miraculous legends are connected with Hillel's life. A scholastic tradition, however, tells of a voice from heaven which made itself heard when the wise men had assembled in Jericho, saying: "Among those here present is one who would have deserved the Holy Spirit to rest upon him, if his time had been worthy of it." And all eyes turned towards Hillel (*Tos. Sofah*, xiii. 3). When he died lamentation was made for him as follows: "Woe for the humble, woe for the pious, woe for the disciple of Ezra!" (*ib.*)

HILLEL II., one of the patriarchs belonging to the family of Hillel I., lived in Tiberias about the middle of the 4th century, and introduced the arrangement of the calendar through which the Jews of the Diaspora became independent of Palestine in the uniform fixation of the new moons and feasts.

The Rabbi HILLEL, who in the 4th century made the remarkable declaration that Israel need not expect a Messiah, because the promise of a Messiah had already been fulfilled in the days of King Hezekiah (*Babli, Sanhedrin*, 99a), is probably Hillel, the son of Samuel ben Nahman, a well-known expounder of the scriptures. (W. B.)

HILLER, FERDINAND (1811-1885), German composer, was born at Frankfort-on-Main, on the 24th of October 1811. His first master was Aloys Schmitt, and when he was ten years of age his compositions and talent led his father, a well-to-do man, to send him to Hummel in Weimar. There he devoted himself to composition, among his work being the entr'actes to *Marie Stuart*, through which he made Goethe's acquaintance. Under Hummel, Hiller made great strides as a pianist, so much so that early in 1827 he went on a tour to Vienna, where he met Beethoven and produced his first quartet. After a brief visit home Hiller went to Paris in 1829, where he lived till 1836. His father's death necessitated his return to Frankfort for a time, but on the 8th of January 1839 he produced at Milan his opera *La Romilda*, and began to write his oratorio *Die Zerstörung Jerusalems*, one of his best works. Then he went to Leipzig, to his friend Mendelssohn, where in 1843-1844 he conducted a number of the Gewandhaus concerts and produced his oratorio. After a further visit to Italy to study sacred music, Hiller produced two operas, *Ein Traum* and *Conradin*, at Dresden in 1845 and 1847 respectively; he went as conductor to Düsseldorf in 1847 and Cologne in 1850, and conducted at the Opéra Italien in Paris in 1851 and 1852. At Cologne he became a power as conductor of the Gürzenich concerts and head of the Conservatorium. In 1884 he retired, and died on the 12th of May in the following year. Hiller frequently visited England. He composed a work for the opening of the Royal Albert Hall, his *Nala and Damayanti* was performed at Birmingham, and he gave a series of pianoforte recitals of his own compositions at the Hanover Square Rooms in 1871. He had a perfect mastery over technique and form in musical composition, but his works are generally dry. He was a sound pianist and teacher, and occasionally a brilliant writer on musical matters. His compositions, numbering about two hundred, include six operas, two oratorios, six or seven cantatas, much chamber music and a once-popular pianoforte concerto.

HILLER, JOHANN ADAM (1728-1804), German musical composer, was born at Wendisch-Ossig near Görlitz in Silesia on the 25th of December 1728. By the death of his father in 1734 he was left dependent to a large extent on the charity of friends. Entering in 1747 the Kreuzschule in Dresden, the school attended many years afterwards by Richard Wagner, he subsequently went to the university of Leipzig, where he studied jurisprudence, supporting himself by giving music lessons, and also by performing at concerts both on the flute and as a vocalist. Gradually he adopted music as his sole profession, and devoted himself more especially to the permanent establishment of a concert institute at Leipzig. It was he who in 1781 originated the celebrated Gewandhaus concerts which still flourish at Leipzig. In 1789 he became "cantor" of the Thomas school there, a position previously held by John Sebastian Bach. He died in Leipzig on the 16th of June 1804. Two of his pupils placed a monument to his memory in front of the Thomas school. Hiller's compositions comprise almost every kind of church music, from the cantata to the simple choral. But much more important are his operettas, 14 in number, which for a long time retained their place on the boards, and had considerable influence on the development of light dramatic music in Germany. The *Jolly Cobbler*, *Love in the Country* and the *Village Barber* were amongst the most popular of his works. Hiller also excelled in sentimental songs and ballads. With great simplicity of structure his music combines a considerable amount of genuine melodic invention. Although an admirer and imitator of the Italian school, Hiller fully appreciated the greatness of Handel, and did much for the appreciation of his music in Germany. It was under his direction that the *Messiah*

was for the first time given at Berlin, more than forty years after the composition of that great work. Hiller was also a writer on music, and for some years (1766-1770) edited a musical weekly periodical named *Wöchentliche Nachrichten und Anmerkungen die Musik betreffend*.

HILLIARD, LAWRENCE (d. 1640), English miniature painter. The date of his birth is not known, but he died in 1640. He was the son of Nicholas Hilliard, and evidently derived his Christian name from that of his grandmother. He adopted his father's profession and worked out the unexpired time of his licence after Nicholas Hilliard died. It was from Lawrence Hilliard that Charles I. received the portrait of Queen Elizabeth now at Montagu House, since van der Dort's catalogue describes it as "done by old Hilliard, and bought by the king of young Hilliard." In 1624 he was paid £42 from the treasury for five pictures, but the warrant does not specify whom they represented. His portraits are of great rarity, two of the most beautiful being those in the collections of Earl Beauchamp and Mr J. Pierpont Morgan. They are as a rule signed L.H., but are also to be distinguished by the beauty of the calligraphy in which the inscriptions round the portraits are written. The writing is as a rule very florid, full of exquisite curves and flourishes, and more elaborate than the more formal handwriting of Nicholas Hilliard. The colour scheme adopted by the son is richer and more varied than that used by the father, and Lawrence Hilliard's miniatures are not so hard as are those of Nicholas, and are marked by more shade and a greater effect of atmosphere. (G. C. W.)

HILLIARD, NICHOLAS (c. 1537-1619), the first true English miniature painter, is said to have been the son of Richard Hilliard of Exeter, high sheriff of the city and county in 1560, by Lawrence, daughter of John Wall, goldsmith, of London, and was born probably about 1537. He was appointed goldsmith, carver and portrait painter to Queen Elizabeth, and engraved the Great Seal of England in 1586. He was in high favour with James I. as well as with Elizabeth, and from the king received a special patent of appointment, dated the 5th of May 1617, and granting him a sole licence for the royal work for twelve years. He is believed to have been the author of an important treatise on miniature painting, now preserved in the Bodleian Library, but it seems more probable that the author of that treatise was John de Critz, Serjeant Painter to James I. It is probable, however, that the treatise was taken down from the instructions of Hilliard, for the benefit of one of his pupils, perhaps Isaac Oliver.

The esteem of his countrymen for Hilliard is testified to by Dr Donne, who in a poem called "The Storm" (1597) praises the work of this artist. He painted a portrait of himself at the age of thirteen, and is said to have executed one of Mary queen of Scots when he was eighteen years old. He died on the 7th of January 1619, and was buried in St Martin's-in-the-Fields, Westminster, leaving by his will twenty shillings to the poor of the parish, £30 between his two sisters, some goods to his maid-servant, and all the rest of his effects to his son, Lawrence Hilliard, his sole executor.

It seems to be pretty certain that he visited France, and that he is the artist alluded to in the papers of the duc d'Alençon under the name of "Nicholas Belliard, peintre anglois" who was painter to this prince in 1577, receiving a stipend of 200 livres. The miniature of Mademoiselle de Sourdis, in the collection of Mr J. Pierpont Morgan, is certainly the work of Hilliard, and is dated 1577, in which year she was a maid of honour at the French Court; and other portraits which are his work are believed to represent Gabrielle d'Estrées, niece of Madame de Sourdis, la Princesse de Condé and Madame de Montgomery.

For further information respecting Hilliard's sojourn in France, see the privately printed catalogue of the collection of miniatures belonging to Mr J. Pierpont Morgan, compiled by Dr G. C. Williamson. (G. C. W.)

HILLSDALE, a city and the county-seat of Hillsdale county, Michigan, U.S.A., about 87 m. W. by S. of Detroit. Pop. (1900) 4151, of whom 300 were foreign-born; (1904) 4800; (1910) 5001. Hillsdale is served by the Lake Shore & Michigan Southern railway. It has a public library, and is the seat of

Hillsdale College (co-educational; Free Baptist), which was opened as Michigan Central College, at Spring Arbor, Michigan, in 1844, was removed to Hillsdale and received its present name in 1853 and was re-opened here in 1855. The college in 1907-1908 had 22 instructors and 345 students. The city is a centre for a rich farming region; among its manufactures are gasoline and gas engines, screen doors, wagons, barrels, shoes, fur-coats and flour. Hillsdale was first settled in 1837, was incorporated as a village in 1847, and was chartered as a city in 1860.

HILL TIPPERA, or TRIPURA, a native state of India, adjoining the British district of Tippera, in Eastern Bengal and Assam. Area, 4086 sq. m.; pop (1901) 173,325; estimated revenue, £55,000. Six parallel ranges of hill cross it from north to south, at an average distance of 12 m. apart. The hills are covered for the most part with bamboo jungle, while the low ground abounds with trees of various kinds, canebrakes and swamps. The principal crop and food staple is rice. The other articles of produce are cotton, chillies and vegetables. The chief exports are cotton, timber, oilseeds, bamboo canes, thatching-grass and firewood, on all of which tolls are levied. The chief rivers are the Gumti, Haora, Khoyai, Dulai, Manu and Fenny (Pheni). During the heavy rains the people in the plains use boats as almost the sole means of conveyance.

The history of the state includes two distinct periods—the traditional period described in the *Rajmala*, or "Chronicles of the Kings of Tippera," and the period since A.D. 1407. The *Rajmala* is a history in Bengali verse, compiled by the Brahmans of the court of Tripura. In the early history of the state, the rajas were in a state of chronic feud with all the neighbouring countries. The worship of Siva was here, as elsewhere in India, associated with the practice of human sacrifice, and in no part of India were more victims offered. It was not until the beginning of the 17th century that the Moguls obtained any footing in this country. When the East India Company obtained the *diwani* or financial administration of Bengal in 1765, so much of Tippera as had been placed on the Mahomedana rent-roll came under British rule. Since 1808, each successive ruler has received investiture from the British government. In October 1905 the state was attached to the new province of Eastern Bengal and Assam. It has a chronological era of its own, adopted by Raja Birraj, from whom the present raja is 93rd in descent. The year 1875 corresponded with 1285 of the Tippera era.

Besides being the ruler of Hill Tippera, the raja holds an estate in the British district of Tippera, called *chakla* Roshnabad, which is far the most valuable of his possessions. The capital is Agartala (pop. 9513), where there is an Arts College. The raja's palace and other public buildings were seriously damaged by the earthquake of the 12th of June 1897. The late raja, who died from the result of a motor-car accident in 1909, succeeded his father in 1896, but he had taken a large share in the administration of the state for some years previously. The principle of succession, which had often caused serious disputes, was defined in 1904, to the effect that the chief may nominate any male descendant through males from himself or from any male ancestor, but failing such nomination, then the rule of primogeniture applies.

HILTON, JOHN (1804-1878), British surgeon, was born at Castle Hedingham, in Essex, in 1804. He entered Guy's Hospital in 1824. He was appointed demonstrator of anatomy in 1828, assistant-surgeon in 1845, surgeon 1849. In 1862 he was president of the Royal College of Surgeons, of which he became member in 1827 and fellow in 1843, and he also delivered the Hunterian oration in 1867. As Arris and Gale professor (1859-1862) he delivered a course of lectures on "Rest and Pain," which have become classics. He was also surgeon-extraordinary to Queen Victoria. Hilton was the greatest anatomist of his time, and was nick named "Anatomical John." It was he who, with Joseph Towne the artist, enriched Guy's Hospital with its unique collection of models. In his grasp of the structure and functions of the brain and

spinal cord he was far in advance of his contemporaries. As an operator he was more cautious than brilliant. This was doubtless due partly to his living in the pre-anaesthetics period, and partly to his own consummate anatomical knowledge, as is indicated by the method for opening deep abscesses which is known by his name. But he could be bold when necessary; he was the first to reduce a case of obturator hernia by abdominal section, and one of the first to practise lumbar colostomy. He died at Clapham on the 14th of September 1878.

HILTON, WILLIAM (1786-1839), English painter, was born in Lincoln on the 3rd of June 1786, son of a portrait-painter. In 1800 he was placed with the engraver J. R. Smith, and about the same time began studying in the Royal Academy school. He first exhibited in this institution in 1803, sending a "Group of Banditti"; and he soon established a reputation for choice of subject, and qualities of design and colour superior to the great mass of his contemporaries. He made a tour in Italy with Thomas Phillips, the portrait-painter. In 1813, having exhibited "Miranda and Ferdinand with the Logs of Wood," he was elected an associate of the Academy, and in 1820 a full academian, his diploma-picture representing "Ganymede." In 1823 he produced "Christ crowned with Thorns," a large and important work, subsequently bought out of the Chantrey Fund; this may be regarded as his masterpiece. In 1827 he succeeded Henry Thomson as keeper of the Academy. He died in London on the 30th of December 1839. Some of his best pictures remained on his hands at his decease—such as the "Angel releasing Peter from Prison" (life-size), painted in 1831, "Una with the Lion entering Corceca's Cave" (1832), the "Murder of the Innocents," his last exhibited work (1838), "Comus," and "Amphitrite." The National Gallery now owns "Edith finding the Body of Harold" (1834), "Cupid Disarmed," "Rebecca and Abraham's Servant" (1839), "Nature blowing Bubbles for her Children" (1821), and "Sir Calepine rescuing Serena" (from the *Faerie Queen*) (1831). In the National Portrait Gallery is his likeness of John Keats, with whom he was acquainted. In a great school or period Hilton could not count as more than a respectable subordinate; but in the British school of the earlier part of the 19th century he had sufficient elevation of aim and width of attainment to stand conspicuous.

HILVERSUM, a town in the province of North Holland, 18 m. by rail S.E. of Amsterdam. It is connected with Amsterdam by a steam tramway, passing by way of the small fortified towns of Naarden and Muiden on the Zuider Zee. Pop. (1900) 20,238. It is situated in the middle of the Gooi, a stretch of hilly country extending from the Zuider Zee to about 5 m. south of Hilversum, and composed of pine woods and sandy heaths. A convalescent home, the Trompenberg, was established here in 1874, and there are a town hall, middle-class and technical schools, and various places of worship, including a synagogue. Hilversum manufactures large quantities of floor-cloths and horse-blankets.

HIMALAYA, the name given to the mountains which form the northern boundary of India. The word is Sanskrit and literally signifies "snow-abode," from *him*, snow, and *aya*, abode, and might be translated "snowy-range," although that expression is perhaps more nearly the equivalent of *Himachal*, another Sanskrit word derived from *him*, snow, and *achal*, mountain, which is practically synonymous with Himalaya and is often used by natives of northern India. The name was converted by the Greeks into *Emodas* and *Imaas*.

Modern geographers restrict the term Himalaya to that portion of the mountain region between India and Tibet enclosed within the arms of the Indus and the Brahmaputra. From the bend of the Indus southwards towards the plains of the Punjab to the bend of the Brahmaputra southwards towards the plains of Assam, through a length of 1500 m., is Himachal or Himalaya. Beyond the Indus, to the north-west, the region of mountain ranges which stretches to a junction with the Hindu Kush south of the Pamirs, is usually known as Trans-Himalaya. Thus the *Himalaya* represents the southern face of the great central

upheaval—the plateau of Tibet—the northern face of which is buttressed by the Kuen Lun.

Throughout this vast space of elevated plateau and mountain face geologists now trace a system of main chains, or axes, extending from the Hindu Kush to Assam, arranged in approximately parallel lines, and traversed at intervals by main lines of drainage obliquely. Godwin-Austen indicates six of these geological axes as follows:

1. The main Central Asian axis, the Kuen Lun forming the northern edge or ridge of the Tibetan plateau.
2. The Trans-Himalayan chain of Muztagh (or Karakoram), which is lost in the Tibetan uplands, passing to the north of the sources of the Indus.
3. The Ladakh chain, partly north and partly south of the Indus—for that river breaks across it about 100 m. above Leh. This chain continues south of the Tsanpo (or Upper Brahmaputra), and becomes part of the Himalayan system.
4. The Zaskar, or main chain of the Himalaya, *i.e.* the "snowy range" *par excellence* which is indicated by Nanga Parbat (overlooking the Indus), and passes in a south-east direction to the southern side of the Deosai plains. Thence, bending slightly south, it extends in the line of snowy peaks which are seen from Simla to the famous peaks of Gangotri and Nanda Devi. This is the best known range of the Himalaya.
5. The outer Himalaya or Pir Panjal-Dhauladhar ridge
6. The Sub-Himalaya, which is "easily defined by the fringing line of hills, more or less broad, and in places very distinctly marked off from the main chain by open valleys (dhūns) or narrow valleys, parallel to the main axis of the chain." These include the Siwaliks.

Interspersed between these main geological axes are many other minor ridges, on some of which are peaks of great elevation. In fact, the geological axis seldom coincides with the line of highest elevation, nor must it be confused with the main lines of water-divide of the Himalaya.

On the north and north-west of Kashmir the great water-divide which separates the Indus drainage area from that of the Yarkand and other rivers of Chinese Turkestan has been explored by Sir F. Younghusband, and subsequently by H. H. P. Deasy. The general result of their investigations has been to prove that the Muztagh range, as it trends south-eastwards and finally forms a continuous mountain barrier together with the Karakoram, is the true water-divide west of the Tibetan plateau. Shutting off the sources of the Indus affluents from those of the Central Asian system of hydrography, this great water-parting is distinguished by a group of peaks of which the altitude is hardly less than that of the Eastern Himalaya. Mount Godwin-Austen (28,250 ft. high), only 750 ft. lower than Everest, affords an excellent example in Asiatic geography of a dominating, peak-crowned water-parting or divide. From Kailas on the far west to the extreme north-eastern sources of the Brahmaputra, the great northern water-parting of the Indo-Tibetan highlands has only been occasionally touched. Littledale, du Rhins and Bonvalot may have stood on it as they looked southwards towards Lhasa, but for some 500 or 600 m. east of Kailas it appears to be lost in the mazes of the minor ranges and ridges of the Tibetan plateau. Nor can it be said to be as yet well defined to the east of Lhasa.

The Tibetan plateau, or Chang, breaks up about the meridian of 92° E., and to the east of this meridian the affluents of the Tsanpo (the same river as the Dihong and subsequently as the Brahmaputra) drain no longer from the elevated plateau, but from the rugged slopes of a wild region of mountains which assumes a systematic conformation where its successive ridges are arranged in concentric curves around the great bend of the Brahmaputra, wherein are hidden the sources of all the great rivers of Burma and China. Neither immediately beyond this great bend, nor within it in the Himalayan regions lying north of Assam and east of Bhutan, have scientific investigations yet been systematically carried out; but it is known that the largest of the Himalayan affluents of the Brahmaputra west of the bend derive their sources from the Tibetan plateau, and break down through the containing bands of hills, carrying deposits of gold from their sources to the plains, as do all the rivers of Tibet.

Although the northern limits of the Tsanpo basin are not sufficiently well known to locate the Indo-Tibetan watershed even approximately, there exists some scattered evidence of the nature of that strip of Northern Himalaya on the Tibeto-Nepalese border which lies between the line of greatest elevation and the trough of the Tsanpo. Recent investigations show that all the chief rivers of Nepal flowing southwards to the Tarai take their rise north of the line of highest crests, the "main range" of the Himalaya; and that some of them drain long lateral high-level valleys enclosed between minor ridges whose strike is parallel to the axis of the Himalaya and, occasionally, almost at right angles to the course of the main drainage channels breaking down to the plains. This formation brings the southern edge of the Tsanpo basin to the immediate neighbourhood of the banks of that river, which runs at its foot like a drain flanking a wall. It also affords material evidence of that wrinkling or folding action which accompanied the process of upheaval, when the Central Asian highlands were raised, which is more or less marked throughout the whole of the north-west Indian borderland. North of Bhutan, between the Himalayan crest and Lhasa, this formation is approximately maintained; farther east, although the same natural forces first resulted in the same effect of successive folds of the earth's crust, forming extensive curves of ridge and furrow, the abundant rainfall and the totally distinct climatic conditions which govern the processes of denudation subsequently led to the erosion of deeper valleys enclosed between forest-covered ranges which rise steeply from the river banks.

Although suggestions have been made of the existence of higher peaks north of the Himalaya than that which dominates the Everest group, no evidence has been adduced to support such a contention. On the other hand the observations of Major Ryder and other surveyors who explored from Lhasa to the sources of the Brahmaputra and Indus, at the conclusion of the Tibetan mission in 1904, conclusively prove that Mount Everest, which appears from the Tibetan plateau as a single dominating peak, has no rival amongst Himalayan altitudes, whilst the very remarkable investigations made by permission of the Nepal durbar from peaks near Kathmandu in 1903, by Captain Wood, R.E., not only place the Everest group apart from other peaks with which they have been confused by scientists, isolating them in the topographical system of Nepal, but clearly show that there is no one dominating and continuous range indicating a main Himalayan chain which includes both Everest and Kinchinjunga. The main features of Nepalese topography are now fairly well defined. So much controversy has been aroused on the subject of Himalayan altitudes that the present position of scientific analysis in relation to them may be shortly stated. The heights of peaks determined by exact processes of trigonometrical observation are bound to be more or less in error for three reasons: (1) the extraordinary geoidal deformation of the level surface at the observing stations in submontane regions; (2) ignorance of the laws of refraction when rays traverse rarefied air in snow-covered regions; (3) ignorance of the variations in the actual height of peaks due to the increase, or decrease, of snow. The value of the heights attached to the three highest mountains in the world are, for these reasons, adjudged by Colonel S. G. Burrard, the Supt. Trigonometrical Surveys in India, to be in probable error to the following extent:

	Present Survey Value of Height	Most probable Value.
Mount Everest	29,002	29,141
K ₂ (Godwin Austen)	28,250	28,191
Kinchinjunga	28,146	28,235

These determinations have the effect of placing Kinchinjunga second and K₂ third on the list. (T. H. H.*)

Geology.—The Himalaya have been formed by violent crumpling of the earth's crust along the southern margin of the great tableland of Central Asia. Outside the arc of the mountain chain no sign of

this crumpling is to be detected except in the Salt Range, and the Peninsula of India has been entirely free from folding of any importance since early Palaeozoic times, if not since the Archean period itself. But the contrast between the Himalaya and the Peninsula is not confined to their structure: the difference in the rocks themselves is equally striking. In the Himalaya the geological sequence, from the Ordovician to the Eocene, is almost entirely marine; there are indeed occasional breaks in the series, but during nearly the whole of this long period the Himalayan region, or at least its northern part, must have been beneath the sea—the Central Mediterranean Sea of Neumayr or Tethys of Suess. In the peninsula, however, no marine fossils have yet been found of earlier date than Jurassic and Cretaceous, and these are confined to the neighbourhood of the coasts; the principal fossiliferous deposits are the plant-bearing beds of the Gondwana series, and there can be no doubt that, at least since the Carboniferous period, nearly the whole of the Peninsula has been land. Between the folded marine beds of the Himalaya and the nearly horizontal strata of the peninsula lies the Indo-Gangetic plain, covered by an enormous thickness of alluvial and wind-blown deposits of recent date. The deep boring at Lucknow passed through 1336 ft. of sands—reaching nearly to 1000 ft. below sea-level—without any sign of approaching the base of the alluvial series. It is clear, then, that in front of the Himalaya there is a great depression, but as yet there is no indication that this depression was ever beneath the sea.

In the light thrown by recent researches on the structure and origin of mountain chains the explanation of these facts is no longer difficult. From early Palaeozoic times the peninsula of India has been dry land, a part, indeed, of a great continent which in Mesozoic times extended across the Indian Ocean towards South Africa. Its northern shores were washed by the Sea of Tethys, which, at least in Jurassic and Cretaceous times, stretched across the Old World from west to east, and in this sea were laid down the marine deposits of the Himalaya. The tangential pressures which are known to be set up in the earth's crust—either by the contraction of the interior or in some other way—caused the deposits of this sea to be crushed up against the rigid granites and other old rocks of the peninsula and finally led to the whole mass being pushed forward over the edge of the part which did not crumple. The Indo-Gangetic depression was formed by the weight of the over-riding mass bending down the edge over which it rode, or else it is the lower limb of the S-shaped fold which would necessarily result if there were no fracture—the Himalaya representing the upper limb of the S.

Geologically, the Himalaya may be divided into three zones which correspond more or less with orographical divisions. The northern zone is the Tibetan, in which fossiliferous beds of Palaeozoic and Mesozoic age are largely developed—excepting in the north-west no such rocks are known on the southern flanks. The second is the zone of the snowy peaks and of the lower Himalaya, and is composed chiefly of crystalline and metamorphic rocks together with unfossiliferous sedimentary beds supposed to be of Palaeozoic age. The southern zone comprises the Sub-Himalaya and consists entirely of Tertiary beds, and especially of the upper Tertiaries. The oldest beds which have hitherto yielded fossils, belong to the Ordovician system, but it is highly probable that the underlying "Haimantas" of the central Himalaya are of Cambrian age. From these beds up to the top of the Carboniferous there appears to be no break; but the Carboniferous beds were in some places eroded before the deposition of the *Productus* shales, which belong to the Permian period. It is, however, possible that this erosion was merely local, for in other places there seems to be a complete passage from the Carboniferous to the Permian. From the Permian to the Lias the sequence in the central Himalaya shows no sign of a break, nor has any unconformity been proved between the Liasic beds and the overlying Spiti shales, which contain fossils of Middle and Upper Jurassic age. The Spiti shales are succeeded conformably by Cretaceous beds (Gieumal sandstone below and Chikim limestone above), and these are followed without a break by Nummulitic beds of Eocene age, much disturbed and altered by intrusions of gabbro and syenite. Thus, in the Spiti area at least, there appears to have been continuous deposition of marine beds from the Permian *Productus* shales to the Eocene Nummulitic formation. The next succeeding deposit is a sandstone, often highly inclined, which rests unconformably upon the Nummulitic beds and resembles the Lower Siwaliks of the Sub-Himalaya (Pliocene) but which as yet has yielded no fossils of any kind. The whole is overlaid unconformably by the younger Tertiaries of Hundes, which are perfectly horizontal and have been quite unaffected by any of the folds.

From the absence of any well-marked unconformity it is evident that in the northern part of the Himalayan belt, at least in the Spiti area, there can have been no post-Archaean folding of any magnitude until after the deposition of the Nummulitic beds, and that the folding was completed before the later Tertiaries of Hundes were laid down. It was, therefore, during the Miocene period that the elevation of this part of the chain began, while the disturbance of the Siwalik-like sandstone indicates that the folding continued into the Pliocene period. Along the southern flanks of the Himalaya the history of the chain is still more clearly shown. The sub-Himalaya are formed of Tertiary beds, chiefly Siwalik or upper Tertiary, while the lower Himalaya proper consist mainly of pre-Tertiary rocks

without fossils. Throughout the whole length of the chain, wherever the junction of the Siwaliks with the pre-Tertiary rocks has been seen, it is a great reversed fault. West of the Blas river a similar reversed fault forms the boundary between the lower Tertiaries and the pre-Tertiary rocks of the Himalaya, while between the Sutlej and the Jumna rivers, where the lower Tertiaries help to form the lower Himalaya, the fault lies between them and the Siwaliks. The hade of the fault is constantly inwards, towards the centre of the chain, and the older rocks which form the Himalaya proper, have been pushed forward over the later beds of the sub-Himalaya. But the fault is more than an ordinary reversed fault: it was, nearly everywhere, the northern boundary of deposition of the Siwalik beds, and only in a few instances do any of the Siwalik deposits extend even to a short distance beyond it. The fault in fact was being formed during the deposition of the Siwalik beds, and as the beds were laid down, the Himalaya were pushed forward over them, the Siwaliks themselves being folded and upturned during the process. Accordingly, in some places the Siwaliks now form a continuous and conformable series from base to summit, in other places the middle beds are absent and the upper beds of the series rest upon the upturned and denuded edges of the lower beds. The Siwaliks are fluviatile and torrential deposits similar to those which are now being formed at the foot of the mountains, in the Indo-Gangetic plain; and their relations to the older rocks of the Himalaya proper were very similar to those which now exist between the deposits of the plain and the Siwaliks themselves. But the great fault just described is not the only one of this character. There is a series of such faults, approximately parallel to one another, and although they have not been traced throughout the whole chain, yet wherever they occur they seem to have formed the northern boundary of deposition of the deposits immediately to the south of them. It appears, therefore, that the Himalaya grew southwards in a series of stages. A reversed fault was formed at the foot of the chain, and

arranged between the same parallel system of folds as we see on the western frontier, connected by short transverse gaps where the rivers cross the folds, frequently to resume a course parallel to that originally held. An instance of this occurs where the Indus suddenly breaks through the well-defined Ladakh range in the North-west Himalaya to resume its north-westerly course after passing from the northern to the southern side of the range. The reason assigned for these extraordinary diversions of the drainage right across the general strike of the ridges is that it is antecedent—i.e. that the lines of drainage were formed ere the folds or anticlines were raised; and that the drainage has merely maintained the course originally held, by the power of erosion during the gradual process of upheaval.

In the outer valleys of the Himalaya the sides are generally steep, so steep as to be liable to landslip, whilst the streams are still cutting down the river beds and have not yet reached the stage of equilibrium. Here and there a valley has become filled with alluvial detritus owing to some local impediment in the drainage, and when this occurs there is usually to be found a fertile and productive field for agriculture. The straits of the Jhelum, below Baramulla, probably account for the lovely vale of Kashmir, which is in form (if not in principles of construction) a repetition on grand scale of the Maidan of the Afridi Tirah, where the drainage from the slopes of a great amphitheatre of hills is collected and then arrested by the gorge which marks the outlet to the Bara.

Other rivers besides the Indus and the Brahmaputra begin by draining a considerable area north of the snowy range—the Sutlej, the Kosi, the Gandak and the Subansiri, for example. ^{General Himalayan drainage is typical.} All these rivers break through the main snowy range ere they twist their way through the southern hills to the plains of India. Here the "antecedent" theory will not suffice, for there is no sufficient catchment area north of the snows to support it. Their formation is explained by a process of "cutting back," by which the heads of these streams are gradually

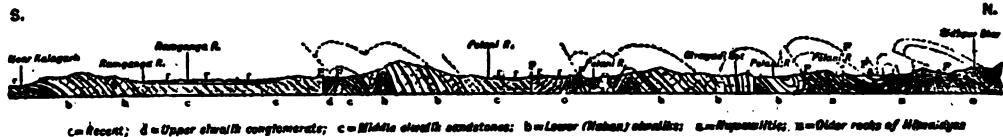

Fig. 10. Sub-Himalayan zone.

Section across the sub-Himalayan zone.

upon this fault the mountains were pushed forward over the beds deposited at their base, crumpling and folding them in the process, and forming a sub-Himalayan ridge in front of the main chain. After a time a new fault originated at the foot of the sub-Himalayan zone thus raised, which now became part of the Himalaya themselves, and a new sub-Himalayan chain was formed in front of the previous one. The earthquakes of the present day show that the process is still in operation, and in time the deposits of the present Indo-Gangetic plain will be involved in the folds.

The regular form of the Himalaya, constituting an arc of a true circle, appears to indicate that the whole chain has been pushed forward as one mass upon a gigantic thrust-plane; but, if so, the dip of the plane must be low, for a line drawn along the southern foot of the Himalaya would coincide with the outcrop of a plane inclined to the surface at an angle of about 14° . The thrust-plane, then, does not coincide with any of the boundary faults already mentioned, which are usually inclined at angles of 50° or 60° . The latter are due to the fact that, although, perhaps, the whole mass above the thrust-plane may move, yet the pressure which pushes it forwards necessarily proceeds from behind. The back, accordingly, moves faster than the front, and the whole is packed together; as when an ice-floe drives against the shore, the ice breaks and the outer fragments ride over those within. The great thrust-plane which is thus imagined to exist at the base of the Himalaya, corresponds with the "major thrusts" of the N.W. Highlands of Scotland, and the reversed faults which appear at the surface with the "minor thrusts." (P. L.A.)

Such is the general outline of Himalayan evolution as now understood, and the process of it has led to certain marked features of scenery and topography. Within the area of the trans-Indus mountains we have beds of hard limestone or sandstone, alternating with soft shales, which leads to the scooping out by erosion of long narrow valleys where the shales occur, and the passage of the streams through deep rifts or gorges across the hard limestone anticlines, which stand in irregular series of parallel ridges with the eroded valleys between. The great mass of the Himalaya exhibits the same structure, due to the same conditions acting for longer periods and on a much larger scale; but the structure is varied in the eastern portions of the mountains by the effect of different climatic conditions, and especially by the greater rainfall. Instead of wide, barren, wind-swept valleys, here are found fertile alluvial plains—such as Manipur—but for the most part the erosive action of the river has been able to keep pace with the rise of the river bed, and we have deep, steep-sided valleys

eating their way northwards owing to the greater rainfall on the southern than on the northern slopes. The result of this process is well exhibited in the relative steepness of slope on the Indian and Tibetan sides of the passes to the Indus plateau. On the southern or Indian side the routes to Tibet and Ladakh follow the levels of Himalayan valleys with no remarkably steep gradients till they near the approach to the water-divide. The slope then steepens with the ascending curve to the summit of the pass, from which point it falls with a comparatively gentle gradient to the general level of the plateau. The Zoji La, the Kashmir water-divide between the Jhelum and the Indus, is a prominent case in point, and all the passes from the Kumaon and Garhwal hills into Tibet exhibit this formation in a marked degree. Taking the average elevation of the central axial line of snowy peaks as 19,000 ft., the average height of the passes is not more than 10,000 owing to this process of cutting down by erosion and gradual encroachment into the northern basin.

Meteorology.—Independently of the enormous variety of topographical conformation contained in the Himalayan system, the vast altitude of the mountains alone is sufficient to cause modifications of climate in ascending over their slopes such as are not surpassed by those observed in moving from the equator to the poles. One half of the total mass of the atmosphere and three-fourths of the water suspended in it in the form of vapour lie below the average altitude of the Himalaya; and of the residue, one-half of the air and virtually almost all the vapour come within the influence of the highest peaks. The regular variations in pressure of the air indicated by the barometer and the annual and diurnal oscillations are as well marked in the Himalaya as elsewhere, but the amount of vapour held in suspension diminishes so rapidly with the altitude that not more than one-sixth (sometimes only one-tenth) of that observed at the foot of the mountains is found at the greatest heights. This is dependent on the temperature of the air which rapidly decreases with altitude. On the mountains every altitude has its corresponding temperature, an elevation of 1000 ft. producing a fall of $3\frac{1}{2}^\circ$ or about 1° to each 300 ft. The mean winter temperature at 7000 ft. (which is about the average height of Himalayan "hill stations") is 44° F. and the summer mean about 65° F. At 9000 ft. the mean temperature of the coldest month is 32° F. At 12,000 ft. the thermometer never falls below freezing-point from the end of May to the middle of October, and at 15,000 ft. it is seldom above that point even in the height of summer. It should be noted that the thermometrical conditions of Tibet vary considerably from those of the Himalaya. At 12,000 ft. in Tibet the mean of the hottest month is about 60° F. and of the coldest about 10° F. whilst, at 15,000 ft. the frost is only permanent

from the end of October to the end of April. The distribution of vegetation and topographical conformation largely influence the question of local temperature. For instance it may be found that the difference of temperature between forest-clad ranges and the Indian plains is twice as much in April and May as in December or January; and the difference between the temperature of a well-wooded hill top and the open valley below may vary from 9 to 24° within twenty-four hours. The general relations of temperature to altitude as determined by Himalayan observations are as follows: (1) The decrease of temperature with altitude is most rapid in summer. (2) The annual range diminishes with the elevation. (3) The diurnal range diminishes with the elevation. Comparisons are, however, apt to become anomalous when applied to elevated zones with a dense covering of forest and a great quantity of cloud and open and uncloudy regions both above and below the forest-clad tracts.

The chief rainfall occurs in the summer months between May and October (i.e. the period of the monsoon rains of India) the remainder of the year being comparatively dry. The fall of rain

Rainfall. over the great plain of northern India gradually diminishes in quantity, and begins later, as we pass from east to west. At the same time the rain is heavier as we approach the Himalaya and the greatest falls are measured in its outer ranges; but the quantity again diminishes as we pass onward across the chain, and on arriving at the border of Tibet, behind the great line of snowy peaks, the rain falls in such small quantities as to be hardly susceptible of measurement. Diurnal currents of wind, which are established from the plains to the mountains during the day, and from the hills to the plains during the night, are important agents in distributing the rainfall. The condensation of vapour from the ascending currents and their gradual exhaustion as they are precipitated on successive ranges is very obvious in the cloud effects produced during the monsoon, the southern or windward face of each range being clothed day after day with a white crest of cloud whilst the northern slopes are often left entirely free. This shows how large a proportion of the vapour is arrested and how it is that only by drifting through the deeper gorges can any moisture find its way to the Tibetan table-land.

The yearly rainfall, which amounts to between 60 and 70 in. in the delta of the Ganges, is reduced to about 40 in. when that river issues from the mountains, and diminishes to 30 in. at the debouchment of the Indus into the plains. At Darjeeling (7000 ft. altitude) on the outer ranges of the eastern Himalaya it amounts to about 120 in. At Naini Tal north of the United Provinces it is about 90 in.; at Simla about 80 in., diminishing still further as one approaches the north-western hills. All these stations are about the same altitude.

In the eastern Himalaya the ordinary winter limit of snow is 6000 ft. and it never lies for many days even at 7000 ft. In Kumaon, **Snowfall.** on the west, it usually reaches down to the 5000 ft. level and occasionally to 2500 ft. Snow has been known to fall at Peshawar. At Leh, in western Tibet, hardly 2 ft. of snow are usually registered and the fall on the passes between 17,000 and 19,000 ft. is not generally more than 3 in., but on the Himalayan passes farther east the falls are much heavier. Even in September these passes may be quite blocked and they are not usually open till the middle of June. The snow-line, or the level to which snow recedes in the course of the year, ranges from 15,000 to 16,000 ft. on the southern exposures of the Himalaya that carry perpetual snow, along all that part of the system that lies between Sikkim and the Indus. It is not till December that the snow begins to descend for the winter, although after September light falls occur which cover the mountain sides down to 12,000 ft., but these soon disappear. On the snowy range the snow-line is not lower than 13,500 ft. and on the summit of the table-land it reaches to 20,000 ft. On all the passes, into Tibet vegetation reaches to about 17,500 ft., and in August they may be crossed in ordinary years up to 18,400 ft. without finding any snow upon them; and it is as impossible to find snow in the summer in Tibet at 15,500 ft. above the sea as on the plains of India.

Glaciers.—The level to which the Himalayan glaciers extend is greatly dependent on local conditions, principally the extent and elevation of the snow basins which feed them, and the slope and position of the mountain on which they are formed. Glaciers on the outer slopes of the Himalaya descend much lower than is commonly the case in Tibet, or in the most elevated valleys near the snowy range. The glaciers of Sikkim and the eastern mountains are believed not to reach a lower level than 13,500 or 14,000 ft. In Kumaon many of them descend to between 11,500 and 12,500 ft. In the higher valleys and Tibet 15,000 and 16,000 ft. is the ordinary level at which they end, but there are exceptions which descend far lower. In Europe the glaciers descend between 3000 and 5000 ft. below the snow-line, and in the Himalaya and Tibet about the same holds good. The summer temperatures of the points where the glaciers end on the Himalaya also correspond fairly with those of the corresponding positions in European glaciers, viz. for July a little below 60° F., August 58° and September 55°.

Measurements of the movement of Himalayan glaciers give results according closely with those obtained under analogous conditions in the Alps, viz. rates from 93 to 143 in. in twenty-four hours. The motion of one glacier from the middle of May to the middle of October

averaged 8 in. in the twenty-four hours. The dimensions of the glaciers on the outer Himalaya, where, as before remarked, the valleys descend rapidly to lower levels, are fairly comparable with those of Alpine glaciers, though frequently much exceeding them in length—8 or 10 m. not being unusual. In the elevated valleys of northern Tibet, where the destructive action of the summer heat is far less, the development of the glaciers is enormous. At one locality in north-western Ladakh there is a continuous mass of snow and ice extending across a snowy ridge, measuring 64 m. between the extremities of the two glaciers at its opposite ends. Another single glacier has been surveyed 36 m. long.

The northern tributaries of the Gligit river, which joins the Indus near its south-westerly bend towards the Punjab, take their rise from a glacier system which is probably unequalled in the world for its extent and magnificent proportions. Chief amongst them are the glaciers which have formed on the southern slopes of the Murtagh mountains below the group of gigantic peaks dominated by Mount Godwin-Austen (28,250 ft. high). The Biafo glacier system, which lies in a long narrow trough extending south-west from Nagar on the Hunza to near the base of the Murtagh peaks, may be traced for 90 m. between mountain walls which tower to a height of from 20,000 to 25,000 ft. above sea-level on either side.

In connexion with almost all the Himalayan glaciers of which precise accounts are forthcoming are ancient moraines indicating some previous condition in which their extent was much larger than now. In the east these moraines are very remarkable, extending 8 or 10 m. In the west they seem not to go beyond 2 or 3 m. reach. They have been observed on the summit of the table-land as well as on the Himalayan slope. The explanation suggested to account for the former great extension of glaciers in Norway would seem applicable here. Any modification of the coast-line which should submerge the area now occupied by the North Indian plain, or any considerable part of it, would be accompanied by a much wetter and more equable climate on the Himalaya; more snow would fall on the highest ranges, and less summer heat would be brought to bear on the destruction of the glaciers, which would receive larger supplies and descend lower.

Botany.—Speaking broadly, the general type of the flora of the lower, hotter and wetter regions, which extend along the great plain at the foot of the Himalaya, and include the valleys of the larger rivers which penetrate far into the mountains, does not differ from that of the contiguous peninsula and islands, though the tropical and insular character gradually becomes less marked going from east to west, where, with a greater elevation and distance from the sea and higher latitude, the rainfall and humidity diminish and the winter cold increases. The vegetation of the western part of the plain and of the hottest zone of the western mountains thus becomes closely allied to, or almost identical with, that of the drier parts of the Indian peninsula, more especially of its hilly portions; and, while a general tropical character is preserved, forms are observed which indicate the addition of an Afghan as well as of an African element, of which last the gay lily *Gloriosa superba* is an example, pointing to some previous connexion with Africa.

The European flora, which is diffused from the Mediterranean along the high lands of Asia, extends to the Himalaya; many European species reach the central parts of the chain, though few reach its eastern end, while genera common to Europe and the Himalaya are abundant throughout and at all elevations. From the opposite quarter an influx of Japanese and Chinese forms, such as the rhododendrons, the tea plant, *Aucuba*, *Helwingia*, *Skinimia*, *Adonia*, *Gouardia* and others, has taken place, these being more numerous in the east and gradually disappearing in the west. On the higher and therefore cooler and less rainy ranges of the Himalaya the conditions of temperature requisite for the preservation of the various species are readily found by ascending or descending the mountain slopes, and therefore a greater uniformity of character in the vegetation is maintained along the whole chain. At the greater elevations the species identical with those of Europe become more frequent, and in the alpine regions many plants are found identical with species of the Arctic zone. On the Tibetan plateau, with the increased dryness, a Siberian type is established, with many true Siberian species and more genera; and some of the Siberian forms are further disseminated, even to the plains of Upper India. The total absence of a few of the more common forms of northern Europe and Asia should also be noticed, among which may be named *Filix*, *Fagus*, *Arbutus*, *Erica*, *Azalea* and *Cistaceae*.

In the more humid regions of the east the mountains are almost everywhere covered with a dense forest which reaches up to 12,000 or 13,000 ft. Many tropical types here ascend to 7000 ft. or more. To the west the upper limit of forest is somewhat lower, from 11,500 to 12,000 ft. and the tropical forms usually cease at 5000 ft.

In Sikkim the mountains are covered with dense forest of tall umbrageous trees, commonly accompanied by a luxuriant growth of under shrubs, and adorned with climbing and epiphytal plants in wonderful profusion. In the tropical zone large figs abound, *Terminalia*, *Shorea* (sál), Laurels, many *Leguminosae*, *Bombax*, *Artocarpus*; bamboos and several palms, among which species of *Calamus* are remarkable, climbing over the largest trees; and this is the western limit of *Cycas* and *Myristica* (nutmeg). Plantains ascend to 7000 ft. *Pandanus* and tree-ferns abound. Other ferns, *Saxifragaceae*, orchids

and climbing *Aroidae* are very numerous, the last named profusely adorning the forests with their splendid dark-green foliage. Various oaks descend within a few hundred feet of the sea-level, increasing in numbers at greater altitudes, and becoming very frequent at 4000 ft., at which elevation also appear *Acubia*, *Magnolia*, cherries, *Pyrus*, maple, alder and birch, with many *Araliaceae*, *Hollbelleae*, *Stimmiæ*, *Daphne*, *Myrsine*, *Symplocos* and *Rubus*. Rhododendrons begin at about 6000 ft. and become abundant at 8000 ft., from 10,000 to 14,000 ft. forming in many places the mass of the shrubby vegetation which extends some 2000 ft. above the forest. Epiphytal orchids are extremely numerous between 6000 and 8000 ft. Of the Coniferae, *Podocarpus* and *Pinus longifolia* alone descend to the tropical zone; *Abies Brunniana* and *Smilixiana* and the larch (a genus not seen in the western mountains) are found at 8000, and the yew and *Picea Webbiana* at 10,000 ft. *Pinus excelsa*, which occurs in Bhutan, is absent in the wetter climate of Sikkim.

On the drier and higher mountains of the interior of the chain, the forests become more open, and are spread less uniformly over the hill-sides, a luxuriant herbaceous vegetation appears, and the number of shrubby *Lepiminosae*, such as *Desmodium* and *Indigofera*, increases, as well as *Ranunculaceae*, *Rosaceae*, *Umbelliferae*, *Labiatae*, *Gramineae*, *Cyperaceae* and other European genera.

Passing to the westward, and viewing the flora of Kumaon, which province holds a central position on the chain, on the 80th meridian, we find that the gradual decrease of moisture and increase of high summer heat are accompanied by a marked change of the vegetation. The tropical forest is characterized by the trees of the hotter and drier parts of southern India, combined with a few European type. Ferns are more rare, and the tree-ferns have disappeared. The species of palm are also reduced to two or three, and bamboos, though abundant, are confined to a few species.

The outer ranges of mountains are mainly covered with forests of *Pinus longifolia*, rhododendron, oak and *Pteris*. At Naini Tal cypress is abundant. The shrubby vegetation comprises *Rosa*, *Rubus*, *Indigofera*, *Desmodium*, *Berberis*, *Boehmeria*, *Viburnum*, *Clematis*, with an *Arundinaria*. Of herbaceous plants species of *Ranunculus*, *Potentilla*, *Geranium*, *Thalictrum*, *Primula*, *Gentiana* and many other European forms are common. In the less exposed localities, on northern slopes and sheltered valleys, the European forms become more numerous, and we find species of alder, birch, ash, elm, maple, holly, hornbeam, *Pyrus*, &c. At greater elevations in the interior, besides the above are met *Corylus*, the common walnut, found wild throughout the range, horse chestnut, yew, also *Picea Webbiana*, *Pinus excelsa*, *Abies Smilixiana*, *Cedrus Deodara* (which tree does not grow spontaneously east of Kumaon), and several junipers. The denser forests are commonly found on the northern faces of the higher ranges, or in the deeper valleys, between 8000 and 10,500 ft. The woods on the outer ranges from 3000 up to 7000 ft. are more open, and consist mainly of evergreen trees.

The herbaceous vegetation does not differ greatly, generically, from that of the east, and many species of *Primulaceae*, *Ranunculaceae*, *Cruciferae*, *Labiatae* and *Scrophulariaceae* occur; balsams abound, also beautiful forms of *Campanulaceae*, *Gentiana*, *Meconopsis*, *Saxifraga* and many others.

Cultivation hardly extends above 7000 ft., except in the valleys behind the great snowy peaks, where a few fields of buckwheat and Tibetan barley are sown up to 11,000 or 12,000 ft. At the lower elevations rice, maize and millets are common, wheat and barley at a somewhat higher level, and buckwheat and amaranth usually on the poorer lands, or those recently reclaimed from forest. Besides these, most of the ordinary vegetables of the plains are reared, and potatoes have been introduced in the neighbourhood of all the British stations.

As we pass to the west the species of rhododendron, oak and *Magnolia* are much reduced in number as compared to the eastern region, and both the Malayan and Japanese forms are much less common. The herbaceous tropical and semi-tropical vegetation likewise by degrees disappears, the *Scitamineae*, epiphytal and terrestrial *Orchidæae*, *Araceae*, *Cyrtandraceae* and *Begoniæ* only occur in small numbers in Kumaon, and scarcely extend west of the Sutlej. In like manner several of the western forms suited to drier climates and Lombardy poplar flourish, though hardly seen farther east, the cherry is cultivated in orchards, and the vegetation presents an eminently European cast. The alpine flora is slower in changing its character as we pass from east to west, but in Kashmir the vegetation of the higher mountains hardly differs from that of the mountains of Afghanistan, Persia and Siberia, even in species.

The total number of flowering plants inhabiting the range amounts probably to 5000 or 6000 species, among which may be reckoned several hundred common English plants chiefly from the temperate and alpine regions; and the characteristic of the flora as a whole is that it contains a general and tolerably complete illustration of almost all the chief natural families of all parts of the world, and has comparatively few distinctive features of its own.

The timber trees of the Himalaya are very numerous, but few of them are known to be of much value. The "Sâl" is one of the most valuable of the trees; with the "Toon" and "Sissoo," it grows in the outer ranges most accessible from the plains. The "Deodar" is also much used, but the other pines produce timber that is not durable. Bamboos grow everywhere along the outer ranges, and

ratians to the eastward, and are largely exported for use in the plains of India.

Though one species of coffee is indigenous in the hotter Himalayan forests, the climate does not appear suitable for the growth of the plant which supplies the coffee of commerce. The cultivation of tea, however, is carried on successfully on a large scale, both in the east and west of the mountains. In the western Himalaya the cultivated variety of the tea plant of China succeeds well; on the east the indigenous tea of Assam, which is not specifically different, and is perhaps the original parent of the Chinese variety, is now almost everywhere preferred. The produce of the Chinese variety in the hot and wet climate of the eastern Himalaya, Assam and eastern Bengal is neither so abundant nor so highly favoured as that of the indigenous plant.

The cultivation of the cinchona, several species of which have been introduced from South America and naturalized in the Sikkim Himalaya, promises to yield at a comparatively small cost an ample supply of the febrifuge extracted from its bark. At present the manufacture is almost wholly in the hands of the Government, and the drug prepared is all disposed of in India.

Zoology.—The general distribution of animal life is determined by much the same conditions that have controlled the vegetation. The connexion with Europe on the north-west, with China on the north-east, with Africa on the south-west, and with the Malayan region on the south-east is manifest; and the greater or less prevalence of the European and Eastern forms varies according to more western or eastern position on the chain. So far as is known these remarks will apply to the extinct as well as to the existing fauna. The Palaeozoic forms found in the Himalaya are very close to those of Europe, and in some cases identical. The Triassic fossils are still more closely allied, more than a third of the species being identical. Among the Jurassic Mollusca, also, are many species that are common in Europe. The Siwalik fossils contain 84 species of mammals of 45 genera, the whole bearing a marked resemblance to the Miocene fauna of Europe, but containing a larger number of genera still existing, especially of ruminants, and now held to be of Pliocene age.

The fauna of the Tibetan Himalaya is essentially European or rather that of the northern half of the old continent, which region has by zoologists been termed Palaearctic. Among the characteristic animals may be named the yak, from which is reared a cross breed with the ordinary horned cattle of India, many wild sheep, and two antelopes, as well as the musk-deer; several hares and some burrowing animals, including pikas (*Lagomys*) and two or three species of marmot; certain arctic forms of carnivora—fox, wolf, lynx, ounce, marten and ermine; also wild asses. Among birds are found bustard and species of sand-grouse and partridge; water-fowl in great variety, which breed on the lakes in summer and migrate to the plains of India in winter; the raven, hawk, eagle and owl a magpie, and two kinds of chough; and many smaller birds of the passerine order, amongst which are several finches. Reptiles, as might be anticipated, are far from numerous, but a few lizards are found, belonging for the most part to types, such as *Phrynoscephalus* characteristic of the Central-Asiatic area. The fishes from the head waters of the Indus also belong, for the most part, to Central-Asiatic types, with a small admixture of purely Himalayan forms. Amongst the former are several peculiar small-scaled carps, belonging to the genus *Schizothorax* and its allies.

The ranges of the Himalaya, from the border of Tibet to the plains, form a zoological region which is one of the richest of the world, particularly in respect to birds, to which the forest-clad mountains offer almost every range of temperature.

Only two or three forms of monkey enter the mountains, the langur, a species of *Semnopithecus*, ranging up to 12,000 ft. No lemur occur, although a species is found in Assam, and another in southern India. Bats are numerous; but the species are for the most part not peculiar to the area; several European forms are found at the higher elevations. Moles, which are unknown in the Indian peninsula, abound in the forest regions of the eastern Himalaya at a moderate altitude, and shrews of several species are found almost everywhere; amongst them are two very remarkable forms of water-shrew, one of which, however, *Neotogale*, is probably Tibetan rather than Himalayan. Bears are common, and so are a marten, several weasels and otters, and cats of various kinds and sizes, from the little spotted *Felis bengalensis*, smaller than a domestic cat, to animals like the clouded leopard rivaling a leopard in size. Leopards are common, and the tiger wanders to a considerable elevation, but can hardly be considered a permanent inhabitant, except in the lower valleys. Civets, the mungoose (*Herpestis*), and toddy cats (*Paradoxurus*) are only found at the lower elevations. Wild dogs (*Cyon*) are common, but neither foxes nor wolves occur in the forest area. Besides these carnivora some very peculiar forms are found, the most remarkable of which is *Aelurus*, sometimes called the cat-bear, a type akin to the American racoon. Two other genera, *Helictis*, an aberrant badger, and *Insang*, an aberrant civet, are representatives of Malayan types. Amongst the rodents squirrels abound, and the so-called flying squirrels are represented by several species. Rats and mice swarm, both kinds and individuals being numerous, but few present much peculiarity, a bamboo rat (*Rhizomys*) from the base of the eastern Himalaya being perhaps most worthy of notice. Two or three species of vole (*Arvicola*) have been detected, and porcupines are

common. The elephant is found in the outer forests as far as the Jumna, and the rhinoceros as far as the Sarda; the spread of both of these animals as far as the Indus and into the plains of India, far beyond their present limits, is authenticated by historical records; they have probably retreated before the advance of cultivation and fire-arms. Wild pigs are common in the lower ranges, and one peculiar species of pigmy-hog (*Sus sabsanitis*) of very small size inhabits the forests at the base of the mountains in Nepal and Sikim. Deer of several kinds are met with, but do not ascend very high on the hillsides, and belong exclusively to Indian forms. The musk deer keeps to the greater elevations. The chevrotains of India and the Malay countries are unrepresented. The gaur or wild ox is found at the base of the hills. Three very characteristic ruminants, having some affinities with goats, inhabit the Himalaya; these are the "serow" (*Nemorhaedus*), "goral" (*Cemas*) and "tahr" (*Hemitragus*), the last-named ranging to rather high elevations. Lastly, the pangolia (*Manis*) is represented by two species in the eastern Himalaya. A dolphin (*Platanista*) living in the Ganges ascends that river and its affluents to their issue from the mountains.

Almost all the orders of birds are well represented, and the marvellous variety of forms found in the eastern Himalaya is only rivaled in Central and South America. Eagles, vultures and other birds of prey are seen soaring high over the highest of the forest-clad ranges. Owls are numerous, and a small species, *Glaucidium*, is conspicuous, breaking the stillness of the night by its monotonous though musical cry of two notes. Several kinds of swifts and night-jars are found, and gorgeously-coloured trogons, bee-eaters, rollers, and beautiful kingfishers and barbets are common. Several large hornbills inhabit the highest trees in the forest. The parrots are restricted to parakeets, of which there are several species, and a single small lory. The number of woodpeckers is very great and the variety of plumage remarkable, and the voice of the cuckoo, of which there are numerous species, resounds in the spring as in Europe. The number of passerine birds is immense. Amongst them the sun-birds resemble in appearance and almost rival in beauty the humming-birds of the New Continent. Crows, nuthatches, shrikes, and their allied forms, flycatchers and swallows, thrushes, dippers and habbiers (about fifty species), bulbuls and orioles, peculiar types of redstart, various sylviaids, wrens, tits, crows, jays and magpies, weaver-birds, avadavats, sparrows, crossbills and many finches, including the exquisitely coloured rosefinches, may also be mentioned. The pigeons are represented by several wood-pigeons, doves and green pigeons. The gallinaceous birds include the peacock, which everywhere adorns the forest bordering on the plains, jungle fowl and several pheasants; partridges, of which the chikor may be named as most abundant, and snow-pheasants and partridges, found only at the greatest elevations. Waders and waterfowl are far less abundant, and those occurring are nearly all migratory forms which visit the peninsula of India—the only important exception being two kinds of solitary snipe and the red-billed curlew.

Of the reptiles found in these mountains many are peculiar. Some of the snakes of India are to be seen in the hotter regions, including the python and some of the venomous species, the cobra being found as high up as 8000 or 9000 ft., though not common. Lizards are numerous, and as well as frogs are found at all elevations from the plains to the upper Himalayan valleys, and even extend to Tibet.

The fishes found in the rivers of the Himalaya show the same general connexion with the three neighbouring regions, the Palaearctic, the African and the Malayan. Of the principal families, the *Acanthopterygii*, which are abundant in the hotter parts of India, hardly enter the mountains, two genera only being found, of which one is the peculiar amphibious genus *Ophiocephalus*. None of these fishes are found in Tibet. The *Siluridae*, or scaleless fishes, and the *Cyprinidae*, or carp and loach, form the bulk of the mountain fish, and the genera and species appear to be organized for a mountain-torrent life, being almost all furnished with suckers to enable them to maintain their positions in the rapid streams which they inhabit. A few *Siluridae* have been found in Tibet, but the carps constitute the larger part of the species. Many of the Himalayan forms are Indian fish which appear to go up to the higher streams to deposit their ova, and the Tibetan species as a rule are confined to the rivers on the table-land or to the streams at the greatest elevations, the characteristics of which are Tibetan rather than Himalayan. The *Salmonidae* are entirely absent from the waters of the Himalaya proper, of Tibet and of Turkestan east of the Teréktag.

The Himalayan butterflies are very numerous and brilliant, for the most part belonging to groups that extend both into the Malayan and European regions, while African forms also appear. There are large and gorgeous species of *Papilio*, *Nymphalidae*, *Morphidae* and *Danaidae*, and the more favoured localities are described as being only second to South America in the display of this form of beauty and variety in insect life. Moths, also, of strange forms and of great size are common. The cicada's song resounds among the woods in the autumn; flights of locusts frequently appear after the summer, and they are carried by the prevailing winds even among the glaciers and eternal snows. Ants, bees and wasps of many species, and flies and gnats abound, particularly during the summer rainy season, and at all elevations.

Mountain Scenery.—Much has been written about the impressive-

ness of Himalayan scenery. It is but lately, however, that any adequate conception of the magnitude and majesty of the most stupendous of the mountain groups which mass themselves about the upper tributaries and reaches of the Indus has been presented to us in the works of Sir F. Younghusband, Sir W. M. Conway, H. C. B. Tanner and D. Freshfield. It is not in comparison with the picturesque beauty of European Alpine scenery that the Himalaya appeals to the imagination, for amongst the hills of the outer Himalaya—the hills which are known to the majority of European residents and visitors—there is often a striking absence of those varied incidents and sharp contrasts which are essential to picturesqueness in mountain landscape. Too often the brown, barren, sun-scorched ridges are obscured in the yellow dust haze which drifts upwards from the plains; too often the whole perspective of hill and vale is blotted out in the grey mists that sweep in soft, resistless columns against these southern slopes, to be condensed and precipitated in ceaseless, monotonous rainfall. Few Europeans really see the Himalaya; fewer still are capable of translating their impressions into language which is neither exaggerated nor inadequate.

Some idea of the magnitude of Himalayan mountain construction—a magnitude which the eye totally fails to appreciate—may, however, be gathered from the following table of comparison of the absolute height of some peaks above sea-level with the actual amount of their slopes exposed to view:—

Relative Extent of Snow Slopes Visible.

Name of Mountain.	Place of Observation.	Height above sea.	Amount of Slope exposed.
Everest	Dewanganj	29,002	8,000
K ₂ or Godwin-Austen	Sandakphu	"	12,000
	Between Gilgit and Gor, 16,000 ft.	28,250	"
Pk. XIII. or Makalu	Purnea, 200 ft.	27,800	8,000
	Sandakphu, 12,000 ft.	"	8,000
Nanga Parbat	Gor, 16,000 ft.	26,656	23,000
Tirach Mir	Between Gilgit and Chitral, 8000 ft.	25,400	17-18,000
Rakapushi	Chaprot (Gilgit), 13,000 ft.	25,560	18,000
Kinchinjunga	Darjeeling, 7000 ft.	28,146	16,000
Mont Blanc	Above Chamoniix, 7000 ft.	15,781	11,500

It will be observed from this table that it is not often that a greater slope of snow-covered mountain side is observable in the Himalaya than that which is afforded by the familiar view of Mont Blanc from Chamoniix. (T. H. H. *)

AUTHORITIES.—Drew, *Jammu and Kashmir* (London, 1875); G. W. Leitner, *Dardistan* (1887); J. Biddulph, *Tribes of the Hindu Kush* (Calcutta, 1880); H. H. Godwin-Austen, "Mountain Systems of the Himalaya," vols. v. and vi. *Proc. R. G. S.* (1883-1884); C. Ujfalvy, *Aus dem westlichen Himalaya* (Leipzig, 1884); H. C. B. Tanner, "Our Present Knowledge of the Himalaya," vol. xiii. *Proc. R. G. S.* (1891); R. D. Oldham, "The Evolution of Indian Geography," vol. iii. *our. R. G. S.*; W. Lawrence, *Kashmir* (Oxford, 1895); Sir W. M. Conway, *Climbing and Exploring in the Karakoram* (London, 1898); F. Bullock Workman, *In the Ice World of Himalaya* (1900); F. B. and W. H. Workman, *Ice-bound Heights of the Mustang* (1908); D. W. Freshfield, *Round Kangchenjunga* (1903).

For geology see R. Lydekker, "The Geology of Kashmir," *Sci. Mem. Geol. Surv. India*, vol. xxii. (1881); C. S. Middlemiss, "Physical Geology of the Sub-Himalaya of Gahrwal and Kumaon," *ibid.*, vol. xxiv. pt. 2 (1890); C. L. Griestrich, *Geology of the Central Hindlayas*, vol. xxiii. (1891); R. D. Oldham, *Manual of the Geology of India*, chap. xviii. (2nd ed., 1893). Descriptions of the fossils, with some notes on stratigraphical questions, will be found in several of the volumes of the *Palaontologia Indica*, published by the Geological Survey of India, Calcutta.

HIMERA, a city on the north coast of Sicily, on a hill above the east bank of the Himera Septentrionalis. It was founded in 648 B.C. by the Chalcidian inhabitants of Zancle, in company with many Syracusan exiles. Early in the 5th century the tyrant Terillas, son-in-law of Anaxilas of Rhegium and Zancle, appealed to the Carthaginians, who came to his assistance, but were utterly defeated by Gelon of Syracuse in 480 B.C.—on the same day, it is said, as the battle of Salamis. Thrasydæus, son of Theron of Agrigentum, seems to have ruled the city oppressively, but an appeal made to Hiero of Syracuse, Gelon's brother, was betrayed by him to Theron; the latter massacred all his enemies and in the following year resettled the town. In 415 it refused to admit the Athenian fleet and remained an ally of Syracuse. In 408 the Carthaginian invading army under Hannibal, after capturing Selinus, invested and took Himera

and razed the city to the ground, founding a new town close to the hot springs (Thermae Himerææ), 8 m. to the west. The only relic of the ancient town now visible above ground is a small portion (four columns, lower diameter 7 ft.) of a Doric temple, the date of which (whether before or after 480 B.C.) is uncertain.

HIMERIUS (c. A.D. 315–386), Greek sophist and rhetorician, was born at Prusa in Bithynia. He completed his education at Athens, whence he was summoned to Antioch in 362 by the emperor Julian to act as his private secretary. After the death of Julian in the following year Himerius returned to Athens, where he established a school of rhetoric, which he compared with that of Isocrates and the Delphic oracle, owing to the number of those who flocked from all parts of the world to hear him. Amongst his pupils were Gregory of Nazianzus and Basil the Great, bishop of Caesarea. In recognition of his merits, civic rights and the membership of the Areopagus were conferred upon him. The death of his son Rufinus (his lament for whom, called *μυρσῖδα*, is extant) and that of a favourite daughter greatly affected his health; in his later years he became blind and he died of epilepsy. Although a heathen, who had been initiated into the mysteries of Mithra by Julian, he shows no prejudice against the Christians. Himerius is a typical representative of the later rhetorical schools. Photius (cod. 165, 243 Bekker) had read 71 speeches by him, of 36 of which he has given an epitome; 24 have come down to us complete and fragments of 10 or 12 others. They consist of epideictic or "display" speeches after the style of Aristides, the majority of them having been delivered on special occasions, such as the arrival of a new governor, visits to different cities (Thessalonica, Constantinople), or the death of friends or well-known personages. The *Polemarchicus*, like the *Menesæus* of Plato and the *Épitaφῖος Λόγος* of Hyperides, is a panegyric of those who had given their lives for their country; it is so called because it was originally the duty of the polemarch to arrange the funeral games in honour of those who had fallen in battle. Other declamations, only known from the excerpts in Photius, were imaginary orations put into the mouth of famous persons—Demosthenes advocating the recall of Aeschines from banishment, Hyperides supporting the policy of Demosthenes, Themistocles inveighing against the king of Persia, an orator unnamed attacking Epicurus for atheism before Julian at Constantinople. Himerius is more of a poet than a rhetorician, and his declamations are valuable as giving prose versions or even the actual words of lost poems by Greek lyric writers. The prose poem on the marriage of Severus and his greeting to Basil at the beginning of spring are quite in the spirit of the old lyric. Himerius possesses vigour of language, and descriptive powers, though his productions are spoilt by too frequent use of imagery, allegorical and metaphorical obscurities, mannerism and ostentatious learning. But they are valuable for the history and social conditions of the time, although lacking the sincerity characteristic of Libanius.

See Eunapius, *Vitæ sophistarum*; Suidas, s.v.; editions by G. Wernsdorf (1790), with valuable introduction and commentaries, and by F. Dübner (1849) in the *Didot series*; C. Teuber, *Quæstiones Himerianæ* (Breslau, 1882); on the style, E. Norden, *Die antike Kunstprosa* (1898).

HIMLY (LOUIS), AUGUSTE (1823–1906), French historian and geographer, was born at Strassburg on the 28th of March 1823. After studying in his native town and taking the university course in Berlin (1842–1843) he went to Paris, and passed first in the examination for fellowship (*agrégation*) of the *lycées* (1845), first in the examinations on leaving the *École des Chartes*, and first in the examination for fellowship of the faculties (1849). In 1849 he took the degree of doctor of letters with two theses, one of which, *Wala et Louis le Débonnaire* (published in Paris in 1849), placed him in the front rank of French scholars in the province of Carolingian history. Soon, however, he turned his attention to the study of geography. In 1858 he obtained an appointment as teacher of geography at the Sorbonne, and henceforth devoted himself to that subject. It was not till 1876 that he published, in two volumes, his remarkable *Histoire de la formation territoriale des états de l'Europe centrale*, in which he showed with a firm, but sometimes slightly heavy touch,

the reciprocal influence exerted by geography and history. While the work gives evidence throughout of wide and well-directed research, he preferred to write it in the form of a student's manual; but it was a manual so original that it gained him admission to the Institute in 1881. In that year he was appointed dean of the faculty of letters, and for ten years he directed the intellectual life of that great educational centre during its development into a great scientific body. He died at Sèvres on the 6th of October 1906.

HIMMEL, FREDERICK HENRY (1765–1814), German composer, was born on the 20th of November 1765 at Treuenbrietzen in Brandenburg, Prussia, and originally studied theology at Halle. During a temporary stay at Potsdam he had an opportunity of showing his self-acquired skill as a pianist before King Frederick William II., who thereupon made him a yearly allowance to enable him to complete his musical studies. This he did under Naumann, a German composer of the Italian school, and the style of that school Himmel himself adopted in his serious operas. The first of these, a pastoral opera, *Il Primo Navigatore*, was produced at Venice in 1794 with great success. In 1792 he went to Berlin, where his oratorio *Isaaco* was produced, in consequence of which he was made court Kapellmeister to the king of Prussia, and in that capacity wrote a great deal of official music, including cantatas, and a coronation *Te Deum*. His Italian operas, successively composed for Stockholm, St Petersburg and Berlin, were all received with great favour in their day. Of much greater importance than these is an operetta to German words by Kotzebue, called *Faschon*, an admirable specimen of the primitive form of the musical drama known in Germany as the *Singspiel*. Himmel's gift of writing genuine simple melody is also observable in his songs, amongst which one called "To Alexis" is the best. He died in Berlin on the 8th of June 1814.

HINCKLEY, a market town in the Bosworth parliamentary division of Leicestershire, England, 14½ m. S.W. from Leicester on the Nuneaton-Leicester branch of the London & North-Western railway, and near the Ashby-de-la-Zouch canal. Pop. of urban district (1901), 11,304. The town is well situated on a considerable eminence. Among the principal buildings are the church of St Mary, a Decorated and Perpendicular structure, with lofty tower and spire; the Roman Catholic academy named St Peter's Priory, and a grammar school. The ditch of a castle erected by Hugh de Grentemeyn in the time of William Rufus is still to be traced. Hinckley is the centre of a stocking-weaving district, and its speciality is circular hose. It also possesses a boot-making industry, brick and tile works, and lime works. There are mineral springs in the neighbourhood.

HINCKS, EDWARD (1792–1866), British assyriologist, was born at Cork, Ireland, and educated at Trinity College, Dublin. He took orders in the Protestant Church of Ireland, and was rector of Killyleagh, Down, from 1825 till his death on the 3rd of December 1866. Hincks devoted his spare time to the study of hieroglyphics, and to the deciphering of the cuneiform script (see CUNEIFORM), in which he was a pioneer, working out contemporaneously with Sir H. Rawlinson, and independently of him, the ancient Persian vowel system. He published a number of original and scholarly papers on assyriological questions of the highest value, chiefly in the *Transactions* of the Royal Irish Academy.

HINCKS, SIR FRANCIS (1807–1885), Canadian statesman, was born at Cork, Ireland, the son of an Irish Presbyterian minister. In 1832 he engaged in business in Toronto, became a friend of Robert Baldwin, and in 1835 was chosen to examine the accounts of the Welland Canal, the management of which was being attacked by W. L. Mackenzie. This turned his attention to political life, and in 1838 he founded the *Examiner*, a weekly paper in the Liberal interest. In 1841 he was elected M.P. for the county of Oxford, and in the following year was appointed inspector-general, the title then borne by the finance minister, but in 1843 resigned with Baldwin and the other ministers on the question of responsible government. In 1848 he again became inspector-general in the Baldwin-Lafontaine

ministry, and on their retirement in 1851 became premier of Canada, his chief colleague being A. N. Morin (1803-1865). While premier he was prominent in the negotiations which led to the construction of the Grand Trunk railway, and in co-operation with Lord Elgin negotiated with the United States the reciprocity treaty of 1854. In the same year the bitter hostility of the "Clear Grits" under George Brown compelled his resignation, and he was prominent in the formation of the Liberal-Conservative Party. In 1855 he was chosen governor of Barbados and the Windward Islands, and subsequently governor of British Guiana. In 1860 he was created K.C.M.G. and returned to Canada, becoming till 1873 finance minister in the cabinet of Sir John Macdonald. In February of that year he resigned, but continued to take an active part in public life. In 1879 the failure of the Consolidated Bank of Canada, of which he was president, led to his being tried for issuing false statements. Though found guilty on a technicality (see *Journal of the Canadian Bankers' Association*, April 1906) judgment was suspended, his personal credit remained unimpaired, and he continued to take part in the discussion of public questions till his death on the 16th of August 1885.

His writings include: *The Political History of Canada between 1840 and 1855* (1877); *The Political Destiny of Canada* (1878), and his *Reminiscences* (1884).

HINCMAR (c. 805-882), archbishop of Reims, one of the most remarkable figures in the ecclesiastical history of France, belonged to a noble family of the north or north-east of Gaul. Destined, doubtless, to the monastic life, he was brought up at St. Denis under the direction of the abbot Hilduin (d. 844), who brought him in 822 to the court of the emperor Louis the Pious. When Hilduin was disgraced in 830 for having joined the party of Lothair, Hincmar accompanied him into exile at Corvey in Saxony, but returned with him to St. Denis when the abbot was reconciled with the emperor, and remained faithful to the emperor during his struggle with his sons. After the death of Louis the Pious (840) Hincmar supported Charles the Bald, and received from him the abbacies of Notre-Dame at Compiègne and St. Germer de Fly. In 845 he obtained through the king's support the archbishopric of Reims, and this choice was confirmed at the synod of Beauvais (April 845). Archbishop Ebbo, whom he replaced, had been deposed in 835 at the synod of Thionville (Diedenhofen) for having broken his oath of fidelity to the emperor Louis, whom he had deserted to join the party of Lothair. After the death of Louis, Ebbo succeeded in regaining possession of his see for some years (840-844), but in 844 Pope Sergius II. confirmed his deposition. It was in these circumstances that Hincmar succeeded, and in 847 Pope Leo IV. sent him the pallium.

One of the first cares of the new prelate was the restitution to his metropolitan see of the domains that had been alienated under Ebbo and given as benefices to laymen. From the beginning of his episcopate Hincmar was in constant conflict with the clerks who had been ordained by Ebbo during his reappearance. These clerks, whose ordination was regarded as invalid by Hincmar and his adherents, were condemned in 853 at the council of Soissons, and the decisions of that council were confirmed in 855 by Pope Benedict III. This conflict, however, bred an antagonism of which Hincmar was later to feel the effects. During the next thirty years the archbishop of Reims played a very prominent part in church and state. His authoritative and energetic will inspired, and in great measure directed, the policy of the west Frankish kingdom until his death. He took an active part in all the great political and religious affairs of his time, and was especially energetic in defending and extending the rights of the church and of the metropolitans in general, and of the metropolitan of the church of Reims in particular. In the resulting conflicts, in which his personal interest was in question, he displayed great activity and a wide knowledge of canon law, but did not scruple to resort to disingenuous interpretation of texts. His first encounter was with the heresiarch Gottschalk, whose predestinarian doctrines claimed to be modelled on those of St. Augustine. Hincmar placed himself at the head of the party

that regarded Gottschalk's doctrines as heretical, and succeeded in procuring the arrest and imprisonment of his adversary (849). For a part at least of his doctrines Gottschalk found ardent defenders, such as Lupus of Ferrières, the deacon Florus and Amolo of Lyons. Through the energy and activity of Hincmar the theories of Gottschalk were condemned at Quierzy (853) and Valence (855), and the decisions of these two synods were confirmed at the synods of Langres and Savonnières, near Toul (859). To refute the predestinarian heresy Hincmar composed his *De predestinatione Dei et libero arbitrio*, and against certain propositions advanced by Gottschalk on the Trinity he wrote a treatise called *De uno et non trino deitate*. Gottschalk died in prison in 868. The question of the divorce of Lothair II., king of Lorraine, who had repudiated his wife Theutberga to marry his concubine Waldrada, engaged Hincmar's literary activities in another direction. At the request of a number of great personages in Lorraine he composed in 860 his *De divorcio Lotharii et Teutbergæ*, in which he vigorously attacked, both from the moral and the legal standpoints, the condemnation pronounced against the queen by the synod of Aix-la-Chapelle (February 860). Hincmar energetically supported the policy of Charles the Bald in Lorraine, less perhaps from devotion to the king's interests than from a desire to see the whole of the ecclesiastical province of Reims united under the authority of a single sovereign, and in 860 it was he who consecrated Charles at Metz as king of Lorraine.

In the middle of the 9th century there appeared in Gaul the collection of false decretals commonly known as the Pseudo-Isidorian Decretals. The exact date and the circumstances of the composition of the collection are still an open question, but it is certain that Hincmar was one of the first to know of their existence, and apparently he was not aware that the documents were forged. The importance assigned by these decretals to the bishops and the provincial councils, as well as to the direct intervention of the Holy See, tended to curtail the rights of the metropolitans, of which Hincmar was so jealous. Rothad, bishop of Soissons, one of the most active members of the party in favour of the pseudo-Isidorian theories, immediately came into collision with his archbishop. Deposed in 863 at the council of Soissons, presided over by Hincmar, Rothad appealed to Rome. Pope Nicholas I. supported him zealously, and in 865, in spite of the protests of the archbishop of Reims, Arsenius, bishop of Orta and legate of the Holy See, was instructed to restore Rothad to his episcopal see. Hincmar experienced another check when he endeavoured to prevent Wulfad, one of the clerks deposed by Ebbo, from obtaining the archbishopric of Bourges with the support of Charles the Bald. After a synod held at Soissons, Nicholas I. pronounced himself in favour of the deposed clerks, and Hincmar was constrained to make submission (866). He was more successful in his contest with his nephew Hincmar, bishop of Laon, who was at first supported both by the king and by his uncle, the archbishop of Reims, but soon quarrelled with both. Hincmar of Laon refused to recognize the authority of his metropolitan, and entered into an open struggle with his uncle, who exposed his errors in a treatise called *Opusculum LV. capitulorum*, and procured his condemnation and deposition at the synod of Douzy (871). The bishop of Laon was sent into exile, probably to Aquitaine, where his eyes were put out by order of Count Boso. Pope Adrian protested against his deposition, but it was confirmed in 876 by Pope John VIII., and it was not until 878, at the council of Troyes, that the unfortunate prelate was reconciled with the Church. A serious conflict arose between Hincmar on the one side and Charles and the pope on the other in 876, when Pope John VIII., at the king's request, entrusted Ansegisus, archbishop of Sens, with the primacy of the Gauls and of Germany, and created him vicar apostolic. In Hincmar's eyes this was an encroachment on the jurisdiction of the archbishops, and it was against this primacy that he directed his treatise *De jure metropolitano*. At the same time he wrote a life of St. Remigius, in which he endeavoured by audacious falsifications to prove the supremacy of the church of Reims over the other churches. Charles the Bald, however, upheld the rights of

Ansegisus at the synod of Ponthion. Although Hincmar had been very hostile to Charles's expedition into Italy, he figured among his testamentary executors and helped to secure the submission of the nobles to Louis the Stammerer, whom he crowned at Compiègne (8th of December 877).

During the reign of Louis, Hincmar played an obscure part. He supported the accession of Louis III. and Carloman, but had a dispute with Louis, who wished to instal a candidate in the episcopal see of Beauvais without the archbishop's assent. To Carloman, on his accession in 882, Hincmar addressed his *De ordine palatii*, partly based on a treatise (now lost) by Adalard, abbot of Corbie (c. 814), in which he set forth his system of government and his opinion of the duties of a sovereign, a subject he had already touched in his *De regis persona et regno ministerio*, dedicated to Charles the Bald at an unknown date, and in his *Instructio ad Ludovicum regem*, addressed to Louis the Stammerer on his accession in 877. In the autumn of 882 an irruption of the Normans forced the old archbishop to take refuge at Epernay, where he died on the 21st of December 882. Hincmar was a prolific writer. Besides the works already mentioned, he was the author of several theological tracts; of the *De villa Novitiaco*, concerning the claiming of a domain of his church; and he continued from 86r the *Annales Bertiniani*, of which the first part was written by Prudentius, bishop of Troyes, the best source for the history of Charles the Bald. He also wrote a great number of letters, some of which are extant, and others embodied in the chronicles of Flodoard.

Hincmar's works, which are the principal source for the history of his life, were collected by Jacques Sirmond (Paris, 1645), and reprinted by Migne, *Patrol. Latina*, vol. cxxv. and cxxvi. See also C. von Noorden, *Hincmar, Erzbischof von Reims* (Bonn, 1863), and, especially, H. Schrörs, *Hincmar, Erzbischof von Reims* (Freiburg-im-Breisgau, 1884). For Hincmar's political and ecclesiastical theories see preface to Maurice Prou's edition of the *De ordine palatii* (Paris, 1885), and the abbé Lesne, *La Hiérarchie épiscopale en Gaule et en Germanie* (Paris, 1905). (R. Po.)

HIND, the female of the red-deer, usually taken as being three years old and over, the male being known as a "hart." It is sometimes also applied to the female of other species of deer. The word appears in several Teutonic languages, cf. Dutch and Ger. *Hinde*, and has been connected with the Goth. *hinþan* (*hinþan*), to seize, which may be connected ultimately with "hand" and "hunt." "Hart," from the O.E. *heort*, may be in origin connected with the root of Gr. *ἄρως*, horn. "Hind" (O.E. *hine*, probably from the O.E. *hīnan*, members of a family or household), meaning a servant, especially a labourer on a farm, is another word. In Scotland the "hind" is a farm servant, with a cottage on the farm, and duties and responsibilities that make him superior to the rest of the labourers. Similarly "hind" is used in certain parts of northern England as equivalent to "bailiff."

HINDERSIN, GUSTAV EDUARD VON (1804-1872), Prussian general, was born at Wernigerode near Halberstadt on the 18th of July 1804. He was the son of a priest and received a good education. His earlier life was spent in great poverty, and the struggle for existence developed in him an iron strength of character. Entering the Prussian artillery in 1820 he became an officer in 1825. From 1830 to 1837 he attended the Allgemeine Kriegsakademie at Berlin, and in 1847, while still a subaltern, he was posted to the great General Staff, in which he afterwards directed the topographical section. In 1849 he served with the rank of major on the staff of General Peucker, who commanded a federal corps in the suppression of the Baden insurrection. He fell into the hands of the insurgents at the action of Ladenburg, but was released just before the fall of Rastadt. In the Danish war of 1864 Hindersin, now lieutenant-general, directed the artillery operations against the lines of Düppel, and for his services was ennobled by the king of Prussia. Soon afterwards he became inspector-general of artillery. His experience at Düppel had convinced him that the days of the smooth-bore gun were past, and he now devoted himself with unremitting zeal to the rearmament and reorganization of the Prussian artillery. The available funds were small, and grudgingly

voted by the parliament. There was a strong feeling moreover that the smooth-bore was still tactically superior to its rival (see ARTILLERY, § 19). There was no practical training for war in either the field or the fortress artillery units. The latter had made scarcely any progress since the days of Frederick the Great, and before von Hindersin's appointment had practised with the same guns in the same bastion year after year. All this was altered, the whole "foot-artillery" was reorganized, manœuvres were instituted, and the smooth-bores were, except for ditch defence, eliminated from the armament of the Prussian fortresses. But far more important was his work in connection with the field and horse batteries. In 1864 only one battery in four had rifled guns, but by the unrelenting energy of von Hindersin the outbreak of war with Austria one and a half years later found the Prussians with ten in every sixteen batteries armed with the new weapon. But the battles of 1866 showed, besides the superiority of the rifled gun, a very marked absence of tactical efficiency in the Prussian artillery, which was almost always outmatched by that of the enemy. Von Hindersin had pleaded, in season and out of season, for the establishment of a school of gunnery; and in spite of want of funds, such a school had already been established. After 1866, however, more support was obtained, and the improvement in the Prussian field artillery between 1866 and 1870 was extraordinary, even though there had not been time for the work of the school to leaven the whole arm. Indeed, the German artillery played by far the most important part in the victories of the Franco-German war. Von Hindersin accompanied the king's headquarters as chief of artillery, as he had done in 1866, and was present at Gravelotte, Sedan, and the siege of Paris. But his work, which was now accomplished, had worn out his physical powers, and he died on the 23rd of January 1872 at Berlin.

See Bartholomæus, *Der General der Infanterie von Hindersin* (Berlin, 1895), and Prince Kraft zu Hohenlohe-Ingelfingen, *Letters on Artillery* (translated by Major Wallford, R.A.), No. xi.

HINDI, EASTERN, one of the "intermediate" Indo-Aryan languages (see HINDOSTANI). It is spoken in Oudh, Baghelkhand and Chhattisgarh by over 22,000,000 people. It is derived from the Apabhraṃśa form of Ardhamāgadhī Prakrit (see PRAKRIT), and possesses a large and important literature. Its most famous writer was Tulsi Dās, the poet and reformer, who died early in the 17th century, and since his time it has been the North-Indian language employed for epic poetry.

HINDI, WESTERN, the Indo-Aryan language of the middle and upper Gangetic Doab, and of the country to the north and south. It is the vernacular of over 40,000,000 people. Its standard dialect is Braj Bhāshā, spoken near Muttra, which has a considerable literature mainly devoted to the religion founded on devotion to Kṛishna. Another dialect spoken near Delhi and in the upper Gangetic Doab is the original from which Hindostani, the great *lingua franca* of India, has developed (see HINDOSTANI). Western Hindi, like Punjabi, its neighbour to the west, is descended from the Apabhraṃśa form of Śaurasēṇī Prakrit (see PRAKRIT), and represents the language of the Madhyadeśa or Midland, as distinct from the intermediate and outer Indo-Aryan languages.

HINDKI, the name given to the Hindus who inhabit Afghanistan. They are of the Khatri class, and are found all over the country even amongst the wildest tribes. Bellow in his *Races of Afghanistan* estimates their number at about 300,000. The name Hindki is also loosely used on the upper Indus, in Dir, Bajour, &c., to denote the speakers of Punjabi or any of its dialects. It is sometimes applied in a historical sense to the Buddhist inhabitants of the Peshawar Valley north of the Kabul river, who were driven thence about the 5th or 6th century and settled in the neighbourhood of Kandahar.

HINDLEY, an urban district in the Ince parliamentary division of Lancashire, England, 2 m. E.S.E. of Wigan, on the Lancashire & Yorkshire and Great Central railways. Pop. (1901) 23,504. Cotton spinning and the manufacture of cotton goods are the principal industries, and there are extensive coal-mines in the neighbourhood. It is recorded that in the time of the

Puritan revolution Hindley church was entered by the Cavaliers, who played at cards in the pews, pulled down the pulpit and tore the Bible in pieces.

HINDOSTANI (properly *Hindostāni*, of or belonging to Hindostan¹), the name given by Europeans to an Indo-Aryan dialect (whose home is in the upper Gangetic Doab and near the city of Delhi), which, owing to political causes, has become the great *lingua franca* of modern India. The name is not employed by natives of India, except as an imitation of the English nomenclature. Hindostani is by origin a dialect of Western Hindi, and it is first of all necessary to explain what we mean by the term "Hindi" as applied to language. Modern Indo-Aryan languages fall into three groups,—an outer band, the language of the Midland and an intermediate band. The Midland consists of the Gangetic Doab and of the country to its immediate north and south, extending, roughly speaking, from the Eastern Punjab on the west, to Cawnpore on its east. The language of this tract is called "Western Hindi"; to its west we have Panjabi (of the Central Punjab), and to the east, reaching as far as Benares, Eastern Hindi, both Intermediate languages. These three will all be dealt with in the present article. Panjabi and Western Hindi are derived from Saurasēni, and Eastern Hindi from Ardham gadhā Prakrit, through the corresponding Apabhraṃśas (see PRAKRIT). Eastern Hindi differs in many respects from the two others, but it is customary to consider it together with the language of the Midland, and this will be followed on the present occasion. In 1901 the speakers of these three languages numbered: Panjabi, 17,070,961; Western Hindi, 40,714,925; Eastern Hindi, 22,136,358.

Linguistic Boundaries.—Taking the tract covered by these three forms of speech, it has to its west, in the western Punjab, Lahndā (see SINDEI), a language of the Outer band. The parent of Lahndā once no doubt covered the whole of the Punjab, but, in the process of expansion of the tribes of the Midland described in the article INDO-ARYAN LANGUAGES, it was gradually driven back, leaving traces of its former existence which grow stronger as we proceed westwards, until at about the 74th degree of east longitude there is a mixed, transition dialect. To the west of that degree Lahndā may be said to be established, the deserts of the west-central Punjab forming a barrier and protecting it, just as, farther south, a continuation of the same desert has protected Sindhi from Rajasthani. It is the old traces of Lahndā which mainly differentiate Panjabi from Hindostani. To the south of Panjabi and Western Hindi lies Rajasthani. This language arose in much the same way as Panjabi. The expanding Midland language was stopped by the desert from reaching Sindhi, but to the south-west it found an unobstructed way into Gujarat, where, under the form of Gujarati, "Hindostān" is a Persian word, and in modern Persian is pronounced "Hindostān." It means the country of the Hindūs. In medieval Persian the word was "Hindostān," with an *ō*, but in the modern language the distinctions between *ē* and *ī* and between *ō* and *ā* have been lost. Indian languages have borrowed Persian words in their medieval form. Thus in India we have *shōr*, a tiger, as compared with modern Persian *shir*; *gō*, but modern Pers. *gū*; *bōstān*, but modern Pers. *bāstān*. The word "Hindu" is in medieval Persian "Hindō" representing the ancient Avesta *hmdava* (Sanskrit, *śrindhava*), a dweller on the *Sindhu* or Indus. Owing to the influence of scholars in modern Persian the word "Hindū" is now established in English and, through English, in the Indian literary languages; but "Hindō" is also often heard in India. "Hindostan" with *o* is much more common both in English and in Indian languages, although "Hindustan" is also employed. Up to the days of Persian supremacy inaugurated in Calcutta by Gilchrist and his friends, every traveller in India spoke of "Indostan" or some such word, thus bearing testimony to the current pronunciation. Gilchrist introduced "Hindostan," which became "Hindustan" in modern spelling. The word is not an Indian one, and both pronunciations, with *ō* and with *u*, are current in India at the present day, but that with *ō* is unquestionably the one demanded by the history of the word and of the form which other Persian words take on Indian soil. On the other hand "Hindu" is too firmly established in English for us to suggest the spelling "Hindo." The word "Hindi" has another derivation, being formed from the Persian *Hind*, India (Avesta *hindu*, Sanskrit *śindhu*, the Indus). "Hindi" means "of or belonging to India," while "Hindu" now means "a person of the Hindu religion." (Cf. Sir C. J. Lyall, *A Sketch of the Hindustani Language*, p. 1).

it broke the continuity of the Outer band. Eastern Hindi, as an intermediate form of speech, is of much older lineage. It has been an intermediate language since, at least, the institution of Jainism (say, 500 B.C.), and is much less subject to the influence of the Midland than is Panjabi. To its east it has Biharī, and, stretching far to the south, it has Marathi as its neighbour in that direction, both of these being Outer languages.

Dialects.—The only important dialect of Eastern Hindi is Awadhī, spoken in Oudh, and possessing a large literature of great excellence. Chhattāgarhī and Baghēlī, the other dialects, have scanty literatures of small value. Western Hindi has four main dialects, Bundēlī of Bundelkhand, Braj Bhasha (properly "Braj Bhāṣā") of the country round Mathura (Muttra), Kanaujī of the central Doab and the country to its north, and vernacular Hindostani of Delhi and the Upper Doab. West of the Upper Doab, across the Jumna, another dialect, Bāngarī, is also found. It possesses no literature. Kanaujī is very closely allied to Braj Bhasha, and these two share with Awadhī the honour of being the great literary speeches of northern India. Nearly all the classical literature of India is religious in character, and we may say that, as a broad rule, Awadhī literature is devoted to the Rāmāite religion and the epic poetry connected with it, while that of Braj Bhasha is concerned with the religion of Krishna. Vernacular Hindostani has no literature of its own, but as the *lingua franca* now to be described it has a large one. Panjabi has one dialect, Dōgrī, spoken in the Himalayas.

Hindostani as a Lingua Franca.—It has often been said that Hindostani is a mongrel "pigeon" form of speech made up of contributions from the various languages which met in Delhi bazaar, but this theory has now been proved to be unfounded, owing to the discovery of the fact that it is an actual living dialect of Western Hindi, existing for centuries in its present habitat, and the direct descendant of Saurasēni Prakrit. It is not a typical dialect of that language, for, situated where it is, it represents Western Hindi merging into Panjabi (Braj Bhasha being admittedly the standard of the language), but to say that it is a mongrel tongue thrown together in the market is to reverse the order of events. It was the natural language of the people in the neighbourhood of Delhi, who formed the bulk of those who resorted to the bazaar, and hence it became the bazaar language. From here it became the *lingua franca* of the Mogul camp and was carried everywhere in India by the lieutenants of the empire. It has several recognized varieties, amongst which we may mention Dakhni, Urdū, Rēkhta and Hindi. Dakhni or "southern" is the form current in the south of India, and was the first to be employed for literature. It contains many archaic expressions now extinct in the standard dialect. Urdu, or *Urūs zabān*, "the language of the camp," is the name usually employed for Hindostani by natives, and is now the standard form of speech used by Mussulmans. All the early Hindostani literature was in poetry, and this literary form of speech was named "Rēkhta," or "scattered," from the way in which words borrowed from Persian were "scattered" through it. The name is now reserved for the dialect used in poetry, Urdu being the dialect of prose and of conversation. The introduction of these borrowed words, which has been carried to even a greater extent in Urdu, was facilitated by the facts that the latter was by origin a "camp" language, and that Persian was the official language of the Mogul court. In this way Persian (and, with Persian, Arabic) words came into current use, and, though the language remained Indo-Aryan in its grammar and essential characteristics, it soon became unintelligible to any one who had not at least a moderate acquaintance with the vocabulary of Iran. This extreme Persianization of Urdu was due rather to Hindu than to Persian influence. Although Urdu literature was Mussulman in its origin, the Persian element was first introduced in excess by the pliant Hindu officials employed in the Mogul administration, and acquainted with Persian, rather than by Persians and Persianized Moguls, who for many centuries used only their own languages for literary purposes.² Prose Urdu literature took its

¹ Sir C. J. Lyall, *op. cit.* p. 9.

origin in the English occupation of India and the need for text-books for the college of Fort William. It has had a prosperous career since the commencement of the 19th century, but some writers, especially those of Lucknow, have so overloaded it with Persian and Arabic that little of the original Indo-Aryan character remains, except, perhaps, an occasional pronoun or auxiliary verb. The Hindi form of Hindostani was invented simultaneously with Urdu prose by the teachers at Fort William. It was intended to be a Hindostani for the use of Hindus, and was derived from Urdu by ejecting all words of Persian or Arabic birth, and substituting for them words either borrowed from Sanskrit (*śaśamas*) or derived from the old primary Prakrit (*śadbhavas*) (see INDO-ARYAN LANGUAGES). Owing to the popularity of the first book written in it, and to its supplying the need for a *lingua franca* which could be used by the most patriotic Hindus without offending their religious prejudices, it became widely adopted, and is now the recognized vehicle for writing prose by those inhabitants of northern India who do not employ Urdu. This Hindi, which is an altogether artificial product of the English, is hardly ever used for poetry. For this the indigenous dialects (usually Awadhi or Braj Bhasha) are nearly always employed by Hindus. Urdu, on the other hand, having had a natural growth, has a vigorous poetical literature. Modern Hindi prose is often disfigured by that too free borrowing of Sanskrit words instead of using home-born *śadbhavas*, which has been the ruin of Bengali, and it is rapidly becoming a Hindu counterpart of the Persianized Urdu, neither of which is intelligible except to persons of high education.

Not only has Urdu adopted a Persian vocabulary, but even a few peculiarities of Persian construction, such as reversing the positions of the governing and the governed word (e.g. *śāp śāśrā* for *śāśrā śāp*), or of the adjective and the substantive it qualifies, or such as the use of Persian phrases with the preposition *śa* instead of the native postposition of the ablative case (e.g. *śa-śhushī* for *śhushī-śa*, or *śa-śhukm-śa* instead of *śarkār-śa śhukm-śa*) are to be met with in many writings; and these, perhaps, combined with the too free indulgence on the part of some authors in the use of high-flown and pedantic Persian and Arabic words in place of common and yet chaste Indian words, and the general use of the Persian instead of the Nāgarī character, have induced some to regard Hindostani or Urdu as a language distinct from Hindi. But such a view betrays a radical misunderstanding of the whole question. We must define Urdu as the Persianized Hindostani of educated Mussulmans, while Hindi is the Sanskritized Hindostani of educated Hindus. As for the written character, Urdu, from the number of Persian words which it contains, can only be written conveniently in the Persian character, while Hindi, for a parallel reason, can only be written in the Nāgarī or one of its related alphabets (see SANSKRIT). On the other hand, "Hindostani" implies the great *lingua franca* of India, capable of being written in either character, and, without purism, avoiding the excessive use of either Persian or Sanskrit words when employed for literature. It is easy to write this Hindostani, for it has an opulent vocabulary of *śadbhava* words understood everywhere by both Mussulmans and Hindus. While "Hindostani," "Urdu" and "Hindi" are thus names of dialects, it should be remembered that the terms "Western Hindi" and "Eastern Hindi" connote, not dialects, but languages.

The epoch of Akbar, which first saw a regular revenue system established, with toleration and the free use of their religion to the Hindus, was, there can be little doubt, the period of the formation of the language. But its final consolidation did not take place till the reign of Shah Jahān. After the date of this monarch the changes are comparatively immaterial until we come to the time when European sources began to mingle with those of the East. Of the contributions from these sources there is little to say. Like the greater part of those from Arabic and Persian, they are chiefly nouns, and may be regarded rather as excrescences which have sprung up casually and have attached themselves to the original trunk than as ingredients duly incorporated in the body. In the case of the Persian and Arabic

element, indeed, we do find not a few instances in which nouns have been furnished with a Hindi termination, e.g. *śhāśrāśā*, *śādāśnā*, *śuśārāśā*, *dāśhāśnā*, *śāśhīśnā*, *śāśmīśnā*, &c.; but the European element cannot be said to have at all woven itself into the grammar of the language. It consists, as has been observed, solely of nouns, principally substantivē nouns, which on their admission into the language are spelt phonetically, or according to the corrupt pronunciation they receive in the mouths of the natives, and are declined like the indigenous nouns by means of the usual postpositions or case-affixes. A few examples will suffice. The Portuguese, the first in order of seniority, contributes a few words, as *śāśārāś* or *śāśārāś* (camera), a room; *śāśārāś* (martello), a hammer; *śāśārāś* (leilāo), an auction, &c. &c. Of French and Dutch influence scarcely a trace exists. English has contributed a number of words, some of which have even found a place in the literature of the language; e.g. *śāśāśāśār* (commissioner); *śāś* (judge); *śāśār* (doctor); *śāśār*, "the science of medicine" or "the profession of physicians"; *śāśārāśār* (inspector); *śāśārāśār* (assistant); *śāśārāśār* (society); *śāśār* (appeal); *śāśār* (to appeal); *śāśār* or *śāśār* (decree); *śāśār* (degree); *śāśār* (inch); *śāśār* (foot); and many more, are now words commonly used. Some borrowed words are distorted into the shape of genuine Hindostani words familiar to the speakers; e.g. the English railway term "signal" has become *śāśārāśār*, the native name for Alexander the Great, and "signal-man" is *śāśārāśār-śāśār*, or "the pride of Alexander." How far the free use of Anglicisms will be adopted as the language progresses is a question upon which it would be hazardous to pronounce an opinion, but of late years it has greatly increased in the language of the educated, especially in the case of technical terms. A native veterinary surgeon once said to the present writer, "*śāśār-śāśār śāśār śāśār antiseptic śāśār*" for "a dog's saliva is very antiseptic," and this is not an extravagant example.¹

The vocabulary of Panjabi and Eastern Hindi is very similar to that of Western Hindi. Panjabi has no literature to speak of and is free from the burden of words borrowed from Persian or Sanskrit, only the commonest and simplest of such being found in it. Its vocabulary is thus almost entirely *śadbhava*, and, while capable of expressing all ideas, it has a charming rustic flavour, like the Lowland Scotch of Burns, indicative of the national character of the sturdy peasantry that employs it. Eastern Hindi is very like Panjabi in this respect, but for a different reason. In it were written the works of Tulśī Dās, one of the greatest writers that India has produced, and his influence on the language has been as great as that of Shakespeare on English. The peasantry are continually quoting him without knowing it, and his style, simple and yet vigorous, thoroughly Indian and yet free from purism, has set a model which is everywhere followed except in the large towns where Urdu or Sanskritized Hindi prevails. Eastern Hindi is written in the Nāgarī alphabet, or in the current character related to it called "Kaithī" (see BĪRĀR). The indigenous alphabet of the Punjab is called *Śāśārāśār* or "clipped." It is related to Nāgarī, but is hardly legible to any one except the original writer, and sometimes not even to him. To remedy this defect an improved form of the alphabet was devised in the 16th century by Angad, the fifth Sikh Guru, for the purpose of recording the Sikh scriptures. It was named *Gurmukhī*, "proceeding from the mouth of the Guru," and is now generally used for writing the language.

Grammar.—In the following account we use these contractions: Skr. = Sanskrit; Pr. = Prakrit; Ap. = Apabhraṅśā; W.H. = Western Hindi; E.H. = Eastern Hindi; H. = Hindostani; Br. = Braj Bhasha; P. = Panjabi.

(A) *Phonetics.*—The phonetic system of all three languages is nearly the same as that of the Apabhraṅśās from which they are derived. With a few exceptions, to be noted below, the letters of the alphabets of the three languages are the same as in Sanskrit. Panjabi, and the western dialects of Western Hindi, have preserved the old Vedic cerebral *l*. There is a tendency for concurrent vowels to run into each other, and for the semi-vowels *y* and *ś* to become vowels. Thus, Skr. *śāśārāśār*, Ap. *śāśārāśār*, a leather-worker,

¹ This and the preceding paragraph are partly taken from Mr. Platts's article in vol. xi. of the 9th edition of this encyclopaedia.

becomes *H. camdri*; Skr. *rajasi*, Ap. *ra(y)asi*, *H. raix*, night; Skr. *dhavalas*, Ap. *dhavalas*, *H. dhaval*, white. Sometimes the semi-vowel is retained, as in Skr. *hitaras*, Ap. *hd(y)aras*, *H. hdyar*, a coward. Almost the only compound consonants which survived in the Pr. stage were double letters, and in W.H. and E.H. these are usually simplified, the preceding vowel being lengthened and sometimes nasalized, in compensation. P., on the other hand, prefers to retain the double consonant. Thus, Skr. *karma*, Ap. *kamma*, W.H. and E.H. *kam*, but P. *kamm*, a work; Skr. *satyas*, Ap. *sacca*, W.H. and E.H. *sac*, but P. *sacc*, true (Pl., being the W.H. dialect which lies nearest to P., often follows that language, and in this instance has *sacc*, usually written *sac*); Skr. *hasas*, Ap. *hathas*, W.H. and E.H. *hath*, but P. *hathh*, a hand. The nasalization of vowels is very frequent in all three languages, and is here represented by the sign - over the vowel. Sometimes it is compensatory, as in *shca*, but it often represents an original *m*, as in *kanvdi* from Skr. *kanvalas*, a lotus. Final short vowels quiesce in prose pronunciation, and are usually not written in transliteration; thus the final *a*, *i* or *u* has been lost in all the examples given above, and other *atsama* examples are Skr. *mati-* which becomes *mat*, mind, and Skr. *vastu-*, which becomes *vast*, a thing. In all poetry, however (except in the Urdu poetry formed on Persian models, and under the rules of Persian prosody), they reappear and are necessary for the scansion.

In *taddhava* words an original long vowel in any syllable earlier than the penultimate is shortened. In P. and H. when the long vowel is *i* or *o* it is shortened to *i* or *o* respectively, but in other W.H. dialects and in E.H. it is shortened to *e* or *o*; thus, *bhṛi*, daughter, long form H. *bhṛiyā*, E.H. *bhṛiyā*; *ghōri*, mare, long form H. *ghōriyā*, E.H. *ghōriyā*. The short vowels *e* and *o* are very rare in P. and H., but are not uncommon (though ignored by most grammars) in E.H. and the other W.H. dialects. A medial *ḍ* is pronounced as a strongly burred cerebral *ṛ*, and is then written as shown, with a superscripted dot. All these changes and various contractions of Prakrit syllables have caused considerable variations in the forms of words, but generally not so as to obscure the origin.

(B) *Declension*.—The nominative form of a *taddhava* word is derived from the nominative form in Sanskrit and Prakrit, but *atsama* words are usually borrowed in the form of the Skr. crude base; thus, Skr. *hastin-*, nom. *hasti*, Ap. nom. *hathi*, H. *hathi*, an elephant; Skr. base *mati-*, nom. *matiḥ*, H. (*atsama*) *mati*, or, with elision of the final short vowel, *mat*. Some *atsama*s are, however, borrowed in the nominative form, as in Skr. *dhāniḥ*, nom. *dhānā*, H. *dhani*, a rich man. As another example of a *taddhava* word, we may take the Skr. nom. *ghōṭas*, Ap. *ghōṭu*, H. *ghōr*, a horse. Here again the final short vowel has been elided, but in old poetry we should find *ghōṭu*, and corresponding forms in *u* are occasionally met with at the present day.

In the article PRAKRIT attention is drawn to the frequent use of

pleonastic suffixes, especially *-ka-* (fern.-(i)ḥā).

With such a suffix we have the Skr. *ghōṭa-kas*, Ap. *ghōṭa-s*, Western Hindi *ghorau*, or in P. and H. (which is the W.H. dialect nearest in locality to P.) *ghōṭā*, a horse; Skr. *ghōṭi-kā*, Ap. *ghōṭi-kā*, W.H. and P. *ghōṭi-kā*, a mare. Such modern forms made with one pleonastic suffix are called "strong forms," while those made without it are called "weak forms." All strong forms end in *au* (or *ā*) in the masculine, and in *i* in the feminine, whereas, in Skr., and hence in *atsama*s, both *ā* and *i* are generally typical of feminine words, though sometimes employed for the masculine. It is shown in the article PRAKRIT that these pleonastic suffixes can be doubled, or even trebled, and in this way we have a new series of *taddhava* forms. Let us take the imaginary Skr. *ghōṭa-ka-kas* with a double suffix. From this we have the Ap. *ghōṭa-a-s*, and modern *ghorawā* (with euphonic *w* inserted), a horse. Similarly for the feminine we have Skr. *ghōṭi-ka-kā*, Ap. *ghōṭi-ā-kā*, modern *ghoriyā* (with euphonic *y* inserted), a mare. Such forms, made with two suffixes, are called "long forms," and are heard in familiar conversation, the feminine also serving as diminutives. There is a further stage, built upon three suffixes, and called the "redundant form," which is mainly used by the vulgar. As a rule masculine long forms end in *-awā*, *-iyā* or *-ā*, and feminines in *-iyā*, although the matter is complicated by the occasional use of pleonastic suffixes other than the *-ka-* which we have taken for our example, and is the most common. Strong forms are rarely met with in E.H., but on the other hand long forms are more common in that language.

There are a few feminine terminations of weak nouns which may be noted. These are *-ini*, *-in*, *-an*, *-ni* (Skr. *-ini*, Pr. *-ini*); and *-āni*, *-āni*, *-āni* (Skr. *-āni*, Pr. *-āni*). These are found not only in words derived from Prakrit, but are added to Persian and even Arabic words; thus, *kathīni*, *hathīni*, *hathīni* (Skr. *hastini*, Pr. *hathīni*), a she-elephant; *sunāni*, *sunāni*, a female goldsmith (*sōnār*); *shērni*, a tigress (Persian *shēr*, a tiger); *Nāshāni*, a proper name (Arabic *nāshā*); *paṇḍitāni*, the wife of a *paṇḍit*; *caudhrāni*, the

wife of a *caudhri* or head man; *mehtrāni*, the wife of a sweeper (Pres. *mehtr*, a sweeper). With these exceptions weak forms rarely have any terminations distinctive of gender.

The synthetic declension of Sanskrit and Prakrit has disappeared. We see it in the actual stage of disappearance in Apabhraṃśa (see PRAKRIT), in which the case terminations had become worn down to *-hu*, *-hā*, *-hi*, *-hī* and *-hā*, of which *-hi* and *-hī* were employed for several cases, both singular and plural. There was also a marked tendency for these terminations to be confused, and in the earliest stages of the modern vernaculars we find *-hi* freely employed for any oblique case of the singular, and *-hī* for any oblique case of the plural, but more especially for the genitive and the locative. In the case of modern weak nouns these terminations have disappeared altogether in W.H. and P. except in sporadic forms of the locative such as *ghāṭ* (for *ghāṭhī*) in the village. In E.H. they are still heard as the termination of a form which can stand for any oblique case, and is called the "oblique form" or the "oblique case." Thus, from *ghar*, a house (a weak noun), we have W.H. and P. oblique form *ghar*, E.H. *gharāhi*, *gharē* or *ghar*. In the plural, the oblique form is sometimes founded on the Ap. terminations *-hā* and *-hū*, and sometimes on the Skr. termination of the genitive plural *-ānam* (Pr. *-āna*, *-āghāni*), as in P. *gharā*, W.H. *gharā*, *gharā*, *gharāni*, E.H. *gharan*. In the case of masculine weak forms, the plural nominative has dropped the old termination, except in E.H., where it has adopted the oblique plural form for this case also, thus *gharan*. The nominative plural of feminine weak forms follows the example of the masculine in E.H. In P. it also takes the oblique plural form, while in W.H. it takes the old singular oblique form in *-āhi*, which it weakens to *ai* or (H.) *ē*; thus *bāi* (fern.), a word, nom. plur. E.H. *bāi-ai*, P. *bāi-ā*, W.H. *bāi-ai* or (H.) *bāi-ē*.

Strong masculine bases in Ap. ended in *-a-a* (nom. *-a-a*); thus *ghōṭa-a* (nom. *ghōṭa-u*), and adding *-hi* we get *ghōṭa-a-hi*, which becomes contracted *ghōṭāhi* and finally to *ghōṭi*. The nominative plural is the same as the oblique singular, except in E.H. where it follows the oblique plural. The oblique plural of all closely follows in principle the weak forms. Feminine strong forms in Ap. ended in *-i-ā*, contracted to *i* in the modern languages. Except in E.H. the *-hi* of the original oblique form singular disappears, so that we have E.H. *ghōṭi-ki* or *ghōṭi*, others only *ghōṭi*. The nominative plural of feminine strong forms exhibits some irregularities. In E.H., as usual, it follows the plural oblique forms. In W.H. (except Hindostani) it simply nasalizes the oblique form singular (i.e. adds *-hi* instead of *-hi*), as in *ghōṭi*. P. and H. adopt the oblique long form for the plural and nasalize it, thus, P. *ghōṭiā*, H. *ghōṭiyā*. The oblique plurals call for no further remarks. We thus get the following summary, illustrating the way in which these nominative and oblique forms are made.

	Panjabi.	Hindostani.	Braj Bhasha.	Eastern Hindi.
Weak Noun Masc.—				
Nom. Sing.	<i>ghar</i>	<i>ghar</i>	<i>ghar</i>	<i>ghar</i>
Obl. Sing.	<i>ghar</i>	<i>ghar</i>	<i>ghar</i>	<i>ghar, gharahi</i>
Nom. Plur.	<i>ghar</i>	<i>ghar</i>	<i>gharā</i>	<i>gharan</i>
Obl. Plur.	<i>gharā</i>	<i>gharā</i>	<i>gharā</i> , <i>gharani</i>	<i>gharan</i>
Strong Noun Masc.—				
Nom. Sing.	<i>ghōṭā</i>	<i>ghōṭā</i>	<i>ghōṭan</i>	<i>ghōṭā</i>
Obl. Sing.	<i>ghōṭē</i>	<i>ghōṭē</i>	<i>ghōṭē</i> , <i>ghōṭai</i>	<i>ghōṭā</i> , <i>ghōṭē</i>
Nom. Plur.	<i>ghōṭē</i>	<i>ghōṭē</i>	<i>ghōṭē</i>	<i>ghōṭan</i>
Obl. Plur.	<i>ghōṭiā</i>	<i>ghōṭā</i>	<i>ghōṭā</i> , <i>ghōṭani</i>	<i>ghōṭan</i>
Weak Noun Fem.—				
Nom. Sing.	<i>bāi</i>	<i>bāi</i>	<i>bāi</i>	<i>bāi</i>
Obl. Sing.	<i>bāi</i>	<i>bāi</i>	<i>bāi</i>	<i>bāi</i>
Nom. Plur.	<i>bāi</i>	<i>bāi</i>	<i>bāi</i>	<i>bāian</i>
Obl. Plur.	<i>bāi</i>	<i>bāi</i>	<i>bāi-ai</i> , <i>bāiani</i>	<i>bāian</i>
Strong Noun Fem.—				
Nom. Sing.	<i>ghōṭi</i>	<i>ghōṭi</i>	<i>ghōṭi</i>	<i>ghōṭi</i>
Obl. Sing.	<i>ghōṭi</i>	<i>ghōṭi</i>	<i>ghōṭi</i>	<i>ghōṭi</i> , <i>ghōṭi-ki</i>
Nom. Plur.	<i>ghōṭiā</i>	<i>ghōṭiyā</i>	<i>ghōṭi</i>	<i>ghōṭin</i>
Obl. Plur.	<i>ghōṭiā</i>	<i>ghōṭiyā</i>	<i>ghōṭiyā</i> , <i>ghōṭiyāni</i>	<i>ghōṭin</i>

We have seen that the oblique form is the resultant of a general melting down of all the oblique cases of Sanskrit and Prakrit, and that in consequence it can be used for any oblique case. It is obvious that if it were so employed it would often give rise to great confusion. Hence, when it is necessary to show clearly what particular case is intended, it is usual to add defining particles corresponding to the English prepositions "of," "to," "from," "by," &c. which, as in all Indo-Aryan languages they follow the main word, are here called "postpositions." The following are the postpositions commonly employed to form cases in our three languages:—

¹ In some dialects of W.H. weak forms have masculines ending in *u* and corresponding feminines in *i*, but these are nowadays rarely met in the literary forms of speech. In old poetry they are common. In Braj Bhasha they have survived in the present participle.

	Agent.	Genitive.	Dative.	Ablative.	Locative.
Panjabi	mai	dā	nū	iz	vicc
Hindustani	nā	kā	kō	sā	mā
Braj Bhasha	nā	kau	kaū	iz, saū	maū
Eastern Hindi	None	ker, k	kā	sē	mā, bikhī

The agent case is the case which a noun takes when it is the subject of a transitive verb in a tense formed from the past participle. This participle is passive in origin, and must be construed passively. In the Prakrit stage the subject was in such cases put into the instrumental case (see PRAKRIT), as in the phrase *aham āpa mārīā*, I by-him (was) struck, i.e. he struck me. In Eastern Hindi this is still the case, the old instrumental being represented by the oblique form without any suffix. The other two languages define the fact that the subject is in the instrumental (or agent) case by the addition of the postposition *nā*, &c., an old form employed elsewhere to define the dative. It is really the oblique form (by origin a locative) of *nā* or *nō*, which is employed in Gujarati (g.v.) for the genitive. As this suffix is never employed to indicate a material instrument but here only to indicate the agent or subject of a verb, it is called the postposition of the "agent" case.

The genitive postpositions have an interesting origin. In Buddhist Sanskrit the words *kṛtyas*, done, and *kṛtyas*, to be done, were added to a noun to form a kind of genitive. A synonym of *kṛtyas* was *kṛtyas*. These three words were all adjectives, and agreed with the thing possessed in gender, number, and case; thus, *māla-kṛtyā karaṇḍā*, in the basket of the garland, literally, in the garland-made basket. In the various dialects of Apabhraṃśa Prakrit *kṛtyas* became (strong form) *kṛta-u* or *kṛta-u*, *kṛtyas* became *kṛta-u*, and *kṛtyas* became *kṛta-u* or *kṛta-u*, the initial *k* of which is liable to elision after a vowel. With the exception of Gujarati (and perhaps Marathi, g.v.) every Indo-Aryan language has genitive postpositions derived from one or other of these forms. Thus from (*kṛta*)*u* we have Panjabi *dā*; from *kṛta-u* we have H. *kā*, Br. *kau*, E.H. and

Bihari *k* and Naipali *kā*; from (*kṛta*)*u* we have perhaps Marathi *dā*; from *kṛta-u*, E.H. and Bihari *kā*, *kar*, Bengali Oriya and Assamese *-r*, and Rajasthani *-rō*; while from (*kṛta*)*u* we have the Sindhi *jō*. It will be observed that while *k*, *kṛ*, *kar*, and *r* are weak forms, the rest are strong. As already stated, the genitive is an adjective. *Bāp* means "father," and *bāp-kā ghōṛā* is literally "the paternal horse." Hence (while the weak forms as usual do not change) these genitives agree with the thing possessed in gender, number, and case. Thus, *bāp-kā ghōṛā*, the horse of the father, but *bāp-kṛ ghōṛā*, the mare of the father, and *bāp-kṛ ghōṛā-kō*, to the horse of the father, the *kō* being put into the oblique case masculine *kō*, to agree with *ghōṛā*, which is itself in an oblique case. The details of the agreement vary slightly in P. and W.H., and must be learnt from the grammars. The E.H. weak forms do not change in the modern language. Finally, in Prakrit it was customary to add these postpositions (*kṛta-u*, &c.) to the genitive, as in *mama* or *mama kṛta-u*, of me. Similarly these postpositions are, in the modern languages, added to the oblique form.

The locative of the Sanskrit *kṛtyas*, *kṛt*, was used in that language as a dative postposition, and it can be shown that all the dative postpositions given above are by origin old oblique forms of some genitive postposition. Thus H. *kā*, Br. *kāū*, is a contraction of *kāhū*, an old oblique form of *kṛta-u*. Similarly for the others. The origin of the ablative postpositions is obscure. To the present writer they all seem (like the Bengal *kaizē*) to be connected with the verb substantive, but their derivation has not been definitely fixed. The locative postpositions *mā* and *maū* are derived from the Skr. *madyā*, in, through *mājhi*, *māhi*, and so on. The derivation of *vicc* and *bikhī* is obscure.

The pronouns closely follow the Prakrit originals. This will be evident from the preceding table of the first two personal pronouns compared with Apabhraṃśa.

It will be observed that in most of the nominatives of the first person, and in the E.H. nominative of the second person, the old nominative has disappeared, and its place has been supplied by an oblique form, exactly as we have observed in the nominative plural of nouns substantive. The P. *ai*, *tuā*, &c., are survivals from the old Lahndā (see *Linguistic Boundaries*, above). The genitives of these two pronouns are rarely used, possessive pronouns (in H. *mā*, my; *hamārā*, our; *tārā*, thy; *tumhārā*, your) being employed instead. They can all (except P. *asiddā*, our; *tusiddā*, your, which are Lahndā) be referred to corresponding Ap. forms.

There is no pronoun of the third person, the demonstrative pronouns being used instead. The following table shows the principal remaining pronominal forms, with their derivation from Ap.:

	Apabhraṃśa.	Panjabi.	Hindustani.	Braj Bhasha.	Eastern Hindi.
THAT, HE, Nom.	?	nā	woh	wō	ā.
Obl.	?	nā	us	wō	ō
THOSE, THEY, Nom.	ōi	ōh	wō	wai	wāh
Obl.	?	umhā	wāh	wāh	wāh
THIS, HE, Nom.	ēhu	ih	yeh	yah	i
Obl.	ēharu, ēhako	ih	is	yā	ē
THESE, THEY, Nom.	ēi	ēh	yē	yai	ih
Obl.	ēhāpa	ihā	ih	ihā	ih
THAT, Nom.	sō	sō	sō	sō	sē
Obl.	tasu, taho	tih	his	tā	sē
THOSE, Nom.	sē	sō	sō	sō	sē
Obl.	tāpa	tihā	tih	tihā	tesh
WHO, Nom.	jō	jō	jō	jō	jō
Obl.	jasu, jaho	jih	jis	jō	jō
WHO (pl.), Nom.	jō	jō	jō	jō	jō
Obl.	jāna	jinhā	jinh	jinhā	jinh
WHO? Nom.	kō, kovanu	kau	kau	kā	kā
Obl.	kasu, kaho	kih	kis	kā	kā
WHO? (pl.), Nom.	kō	kau	kis	kā	kā
Obl.	khāpa	kinhā	kinh	kinhā	tesh
WHAT? (Neut.), Nom.	kīm	kī	kyē	khā	kā
Obl.	kāha, kāsu	kāh, kās	kāhē	kāhē	kāhē

The origin of the first pronoun given above (that, he; those, they) cannot be referred to Sanskrit. It is derived from an Indo-Aryan base which was not admitted to the classical literary language, but of which we find sporadic traces in Apabhraṃśa. The existence of this base is further vouched for by its occurrence in the Iranian language of the Avesta under the form *ava-*. The base of the second pronoun is the same as the base of the first syllable in the Skr. *ē-jas*, this, and other connected pronouns, and also occurs in the Avesta. Ap. *ēhu* is directly derived from *ē-jas*.

There are other pronominal forms upon which, except perhaps *kō* (Pr. *kō-ōi*, Skr. *kō-ōi*), any one, it is unnecessary to dwell. The phrase *kōi hai?* "Is any one (there)?" is the usual formula for calling a servant in upper India, and is the origin of the Anglo-Indian word "Qui-hi." The reflexive pronoun is *ap* (Ap. *apōpa*, Skr. *ātma*), self, which, something like the Latin *suus* (Skr. *svas*), always refers to the subject of the sentence, but to all persons, not only to the third. Thus *maī apnē* (not *mērē*) *dāp-kō dēkhū-kā*, "I see my father."

C. Conjugation.—The synthetic conjugation was already commencing to disappear in Prakrit, and in the modern languages the only original tenses which remain are the present, the imperative, and here and there the future. The first is now generally employed as a present subjunctive. In the accompanying table we have the conjugation of this tense, and also the three participles, present active, and past and future passive, compared with Apabhraṃśa, the verb selected being the intransitive root *cal* or *cal*, go. In Ap. the word may be spelt with one or with two *ā*, which accounts for the variations of spelling in the modern languages.

The imperative closely resembles the old present, except that it drops all terminations in the 2nd person singular; thus, *cal*, go thou.

In P. and H. a future is formed by adding the syllable *gā* (tem. *gā*) to the simple present. Thus, H. *cal-gā*, I shall go. The *gā* is commonly said to be derived from the Skr. *gata* (Pr. *gā*), gone, but this suggestion is not altogether acceptable to the present writer, although he is not now able to propose a better. Under the form of *-gā* the same termination is used in Br., but in that dialect the old future has also survived, as in *calihā* (Ap. *calihā*, Skr. *calisyami*). I shall go, which is conjugated like the simple present. The E.H. formation of the future is closely analogous to what we find in Bihar (g.v.). The third person is formed as in Braj Bhasha, but the first and second persons are formed by adding pronominal suffixes, meaning "by me," "by thee," &c., to the future-passive participle.

	Apabhraṃśa.	Panjabi.	Hindustani.	Braj Bhasha.	Eastern Hindi.
I, Nom.	kaī	maī	maī	kaī	maī
Obl.	maī, maīhu, majjhu	maī	mujh	mohi	mō
WE, Nom.	amhē	asī	ham	ham	ham
Obl.	amahā	asā	hamō	hamā, hamani	ham
THOU, Nom.	tuhā	tā	tā	tā	taī
Obl.	taī, tuha, tujjhu	taī	tujh	lohi	tō
YOU, Nom.	tumhē	tusī	tum	tum	tum
Obl.	tumhahā	tusō	tumhā	tumhā	tum

	Apabrahmā.	Panjabi.	Hindustani.	Braj Bhāsha.	Eastern Hindi.
Old Present—					
Singular 1.	callāḥ	callā	callū	calāḥ	calāḥ
" 2.	callāsi	callā	calā	calāsi	calāsi
" 3.	callāhi	callā	calā	calāsi	calāsi
Plural 1.	callāsi	callā	calā	calāsi	calāsi
" 2.	callāhi	callā	calā	calāsi	calāsi
" 3.	callāhi	callā	calā	calāsi	calāsi
Present Participle . . .	callānti-u	callā	calā	calāsi	calāsi
Past Part. Passive . . .	callānti	callā	calā	calāsi	calāsi
Future Part. Passive . .	callānti	callā	calā	calāsi	calāsi

Thus, *calab-ā*, it-is-to-be-gone-by-me, I shall go. We thus get the following forms. It will be observed that, as in many other Indo-Aryan languages, the first person plural has no suffix:—

Sing.	Plur.
1. <i>calabā</i>	<i>calab</i>
2. <i>calabāsi</i>	<i>calab</i>
3. <i>calabāhi</i>	<i>calab</i>

In old E.H. the future participle passive, *calab*, takes no suffix for any person, and is used for all persons.

The last remark leads us to a class of tenses in P. and W.H., in which a participle, by itself, can be employed for any person of a finite tense. A few examples of the use of the present and past participles will show the construction. They are all taken from Hindostani. *Wah callā*, he goes; *wah callā*, she goes; *maḥ callā*, I went; *wah callā*, she went; *wah callā*, they went. The present participle in this construction, though it may be used to signify the present, is more commonly employed to signify a past conditional ("if) he had gone." It will have been observed that in the above examples, in all of which the verb is intransitive, the past as well as the present participle agrees with the subject in gender and number; but, if the verb be transitive, the passive meaning of the past participle comes into force. The subject must be put into the case of the agent, and the participle inflects to agree with the object. If the object be not expressed, or, as sometimes happens, be expressed in the dative case, the participle is construed impersonally, and takes the masculine (for want of a neuter) form. Thus, *maḥ-nā kahā*, by-me it-was-said, i.e. I said; *us-nā ciffhi likhā*, by-him a-letter (fem.) was-written, he wrote a letter; *rājā-nā śikrānī-kō mārā*, the king killed the tigress, lit., by-the-king, with-reference-to-the-tigress, it (impersonal) was-killed. In the article PRAKRIT it is shown that the same construction obtained in that language.

In E.H. the construction is the same, but is obscured by the fact that (as in the future) pronominal suffixes are added to the participle to indicate the person of the subject or of the agent, as in *calab-ā*, (if) I had gone; *cal-ā*, I went; *mā-ā* (transitive), I struck, lit., struck-by-me; *mā-ā*, struck-by-him, he struck. If the participle has to be feminine, it (although a weak form) takes the feminine termination *ī*, as in *mā-ī*, I struck her; *calab-ī*, (if) I (fem.) had gone; *cal-ī*, I (fem.) went.

Further tenses are formed by adding the verb substantive to these participles, as in H. *maḥ callā-hā*, I am going; *maḥ callā-ihā*, I was going; *maḥ callā-hā*, I have gone; *maḥ callā-ihā*, I had gone. These and other auxiliary verbs need not detain us long. They differ in the various languages. For "I am" we have P. *hā*, H. *hā*, Br. *hā*, E.H. *bāḥ* or *ahā*. For "I was" we have P. *ā* or *ā*, H. *ihā*, Br. *hau* or *hau*, E.H. *rahā*. The H. *hā* is thus conjugated:—

Sing.	Plur.
1. <i>hā</i>	<i>hā</i>
2. <i>hāsi</i>	<i>hā</i>
3. <i>hāhi</i>	<i>hā</i>

The derivation of *hā*, *hā*, *hā*, and *ahā* is uncertain. They are usually derived from the Skr. *asmī*, I am; but this presents many difficulties. An old form of the third person singular is *hāvāsi*, and this points to the Pr. *hāvāsi*, he is, equivalent to the Skr. *bhāvāsi*, he becomes. On the other hand this does not account for the initial *ā* of *ahā*. This last word is in the form of a past tense, and it may be a secondary formation from *asmī*. The P. *ā* is not a feminine of *ā*, as usually stated, but is a survival of the Skr. *āsī*, Pr. *āsī*, was. As in the Prakrit form, *ā* is employed for both genders, both numbers and all persons. *ā* is a secondary formation from this, on the analogy of the H. *ihā*, which is from the Skr. *śikṣā*, Pr. *śikṣā*, stood, and is a participial form like *calā*; thus, *wah ihā*, he was; *wah ihā*, she was. The Br. *hau* is a modern past of *hā*, while *hau* is probably by origin a present participle of the Skr. *bhāvā*, become, Pr. *hāvā*. The E.H. *bāḥ*, is the Skr. *varā*, Ap. *vāḥ*. *Rahā* is the past tense of the root *rah*, remain.

The future participle passive is everywhere freely used as an infinitive or verbal noun; thus, H. *calā*, E.H. *calab*, the act of going, to go. There is a whole series of derivative verbal forms,

making potential passives and transitives from intransitives, and causals (and even double causals) from transitives. Thus *dikhā*, to be seen; potential passive, *dikhānā*, to be visible; transitive, *dikhānā*, to see; causal, *dikhānā*, to show.

D. Literature.—The literatures of Western and Eastern Hindi form the subject of a separate article (see HINDOSTANI LITERATURE). Panjabi has no formal literature. Even the *Granth*, the sacred book of the Sikhs, is mainly in archaic Western Hindi, only a small portion being in Panjabi. On the other hand, the language is peculiarly rich in folk-songs and ballads, some of considerable length and great poetic beauty. The most famous is the ballad of *Hir and Rānjit* by Wārīs Shāh, which is considered to be a model of pure Panjabi. Colonel Sir Richard Temple has published an important collection of these songs under the title of *The Legends of the Punjab* (3 vols., Bombay and London, 1884-1906), in which both texts and translations of nearly all the favourite ones are to be found.

AUTHORITIES.—(a) General: The two standard authorities are the comparative grammars of J. Beames (1872-1879) and A. F. R. Hoernle (1880), mentioned in the article INDO-ARYAN LANGUAGES. To these may be added G. A. Grierson, "On the Radical and Participial Tenses of the Modern Indo-Aryan Languages" in the *Journal of the Asiatic Society of Bengal*, vol. lxiv. (1895), part i. pp. 352 et seq.; and "On Certain Suffixes in the Modern Indo-Aryan Vernaculars" in the *Zeitschrift für vergleichende Sprachforschung auf dem Gebiete der indogermanischen Sprachen* for 1903, pp. 473 et seq.

(b) For the separate languages, see C. J. Lyall, *A Sketch of the Hindustani Language* (Edinburgh, 1880); S. H. Kellogg, *A Grammar of the Hindi Language* (for both Western and Eastern Hindi), (2nd ed., London, 1893); J. T. Platts, *A Grammar of the Hindustani or Urdu Language* (London, 1874); and *A Dictionary of Urdu, Classical Hindi and English* (London, 1884); E. P. Newton, *Panjabi Grammar: with Exercises and Vocabulary* (Ludhiana, 1898); and Bhai Maya Singh, *The Panjabi Dictionary* (Lahore, 1896). *The Linguistic Survey of India*, vol. vi., describes Eastern Hindi, and vol. ix., Hindostani and Panjabi, in each instance in great detail.

(G. A. Gr.)

HINDŪSTĀNĪ LITERATURE. The writings dealt with in this article are those composed in the vernacular of that part of India which is properly called Hindostān,—that is, the valleys of the Jumna and Ganges rivers as far east as the river Kōs, and the tract to the south including Rajpūtānā, Central India (Bundēlkhaṇḍ and Baghelkhaṇḍ), the Narmadā (Nerbudda) valley as far west as Khandwā, and the northern half of the Central Provinces. It does not include the Punjab proper (though the town population there speak Hindostāni), nor does it extend to Lower Bengal.

In this region several different dialects prevail. The people of the towns everywhere use chiefly the form of the language called *Urdū* or *Rēkhā*,¹ stocked with Persian words and phrases, and ordinarily written in a modification of the Persian character. The country folk (who form the immense majority) speak different varieties of *Hindi*, of which the word-stock derives from the Prakrits and literary Sanskrit, and which are written in the Dēvanāgarī or Kaiṭhī character. Of these the most important from a literary point of view, proceeding from west to east, are *Mārwāri* and *Jaipuri* (the languages of Rajpūtānā), *Brajbhāshā* (the language of the country about Mathurā and Agra), *Kanaujī* (the language of the lower Ganges-Jumna Doab and western Rohilkhaṇḍ), *Eastern Hindi*, also called *Awadhi* and *Baiswāri* (the language of Eastern Rohilkhaṇḍ, Oudh and the Benares division of the United Provinces) and *Bihāri* (the language of Biḥār or Mithilā, comprising several distinct dialects). What is called *High Hindi* is a modern development, for literary purposes, of the dialect of Western Hindi spoken in the neighbourhood of Delhi and thence northwards to the Himalāya, which has formed the vernacular basis of Urdū; the Persian words in the latter have been eliminated and replaced by words of Sanskrit origin, and the order of words in the sentence which is proper to

¹ *Urdū* is a Turkish word meaning a camp or army with its followers, and is the origin of the European word *horda*; *Rēkhā* means "scattered, strewn," referring to the way in which Persian words are intermixed with those of Indian origin; it is used chiefly for the literary form of Urdū.

the indigénous speech is more strictly adhered to than in Urdu, which under the influence of Persian constructions has admitted many inversions.

As in many other countries, nearly all the early vernacular literature of HindŪstān is in verse, and works in prose are a modern growth.¹ Both Hindī and Urdu are, in their application to literary purposes, at first intruders upon the ground already occupied by the learned languages Sanskrit and Persian, the former representing Hindū and the latter Musalmān culture. But there is this difference between them, that, whereas Hindī has been raised to the dignity of a literary speech chiefly by impulses of revolt against the monopoly of the Brahmans, Urdu has been cultivated with goodwill by authors who have themselves highly valued and dexterously used the polished Persian. Both Sanskrit and Persian continue to be employed occasionally for composition by Indian writers, though much fallen from their former estate; but for popular purposes it may be said that their vernacular rivals are now almost in sole possession of the field.

The subject may be conveniently divided as follows:—

1. Early Hindī, of the period during which the language was being fashioned as a literary medium out of the ancient Prākṛit, represented by the old heroic poems of Rājputānā and the literature of the early Bhagats or Vaishnava reformers, and extending from about A.D. 1100 to 1550;
2. Middle Hindī, representing the best age of Hindī poetry, and reaching from about 1550 to the end of the 18th century;
3. The rise and development of literary Urdu, beginning about the end of the 16th century, and reaching its height during the 18th;
4. The modern period, marked by the growth of a prose literature in both dialects, and dating from the beginning of the 19th century.

1. *Early Hindī*.—Our knowledge of the ancient metrical chronicles of Rājputānā is still very imperfect, and is chiefly derived from the monumental work of Colonel James Tod, called *The Annals and Antiquities of Rājasthān* (published in 1829-1832), which is founded on them. It is in the nature of compositions of this character to be subjected to perpetual revision and recasting; they are the production of the family bards of the dynasties whose fortunes they record, and from generation to generation they are added to, and their language constantly modified to make it intelligible to the people of the time. Round an original nucleus of historical fact a rich growth of legend accumulates; later redactors endeavour to systematize and to assign dates, but the result is not often such as to inspire confidence; and the mass has more the character of ballad literature than of serious history. The materials used by Tod are nearly all still unprinted; his manuscripts are now deposited in the library of the Royal Asiatic Society in London; and one of the tasks which, on linguistic and historical grounds, should first be undertaken by the investigator of early Hindī literature is the examination and sifting, and the publication in their original form, of these important texts.

Omitting a few fragments of more ancient bards given by compilers of accounts of Hindī literature, the earliest author of whom any portion has as yet been published in the original text is Chand Bardāi, the court bard of Prithwi-Rāj, the last Hindū sovereign of Delhi. His poem, entitled *Prithi-Rāj Rāsau* (or *Rāysa*), is a vast chronicle in 69 books or cantos, comprising a general history of the period when he wrote. Of this a small portion has been printed, partly under the editorship of the late Mr. John Beames and partly under that of Dr Rudolf Hoernle; by the Asiatic Society of Bengal; but the excessively difficult nature of the task prevented both scholars from making much progress.² Chand, who came of a family of bards, was a native of Lahore, which had for nearly 170 years (since 1023) been under Muslim rule when he flourished, and the language of the poem exhibits a considerable leaven of Persian words. In its present form the work is a redaction made by Amar Singh of Mēwār, about the beginning of the 17th century, and therefore more

¹ The only known exceptions are a work in Hindī called the *Chaurāsī Vārā* (mentioned below) and a few commentaries on poems; the latter can scarcely be called literature.

² A fresh critical edition of the text by Pandit Mōhan Lal Vishnu Lal Pandia at Benares, under the auspices of the *Nāgarī Prochārini Sabha*, had reached canto xxiv. in 1907.

than 400 years after Chand's death, with his patron Prithwi-Rāj, in 1193. There is, therefore, considerable reason to doubt whether we have in it much of Chand's composition in its original shape; and the nature of the incidents described enhances this doubt. The detailed dates contained in the Chronicle have been shown by Kabirāj Syāmal Dās³ to be in every case about ninety years astray. It tells of repeated conflicts between the hero Prithwi-Rāj and Sultān Shihābuddin, of Ghōr (Muhammad Ghori), in which the latter always, except in the last great battle, comes off the worst, is taken prisoner and is released on payment of a ransom; these seem to be entirely unhistorical, our contemporary Persian authorities knowing of only one encounter (that of Tiraufi (Tirawari) near Thēnēsār, fought in 1191) in which the Sultān was defeated, and even then he escaped un-captured to Lahore. The Mongols (Book XV.) are brought on the stage more than thirty years before they actually set foot in India, and are related to have been vanquished by the redoubtable Prithwi-Rāj. It is evident that such a record cannot possibly be, in its entirety, a contemporary chronicle; but nevertheless it appears to contain a considerable element which, from its language, may belong to Chand's own age, and represents the earliest surviving document in Hindī. "Though we may not possess the actual text of Chand, we have certainly in his writings some of the oldest known specimens of Gaudian literature, abounding in pure Apabrahmasā Śaurasēli Prākṛit forms" (Grierson).

It is very difficult now to form a just estimate of the poem as literature. The language, essentially transitional in character, consists largely of words which have long since died out of the vernacular speech. Even the most learned Hindus of the present day are unable to interpret it with confidence; and the meaning of the verses must be sought by investigating the processes by which Sanskrit and Prākṛit forms have been transfigured in their progress into Hindī. Chand appears, on the whole, to exhibit the merits and defects of ballad chronicles in general. There is much that is lively and spirited in his descriptions of fight or council; and the characters of the Rājput warriors who surround his hero are often sketched in their utterances with skill and animation. The sound, however, frequently predominates over the sense; the narrative is carried on with the wearisome iteration and tedious unfolding of familiar themes and images which characterize all such poetry in India; and his value, for us at least, is linguistic rather than literary.

Chand may be taken as the representative of a long line of successors, continued even to the present day in the Rājput states. Many of their compositions are still widely popular as ballad literature, but are known only in oral versions sung in HindŪstān by professional singers. One of the most famous of these is the *Alhā-khaṇḍ*, reputed to be the work of a contemporary of Chand called Jagnik or Jagnāyak, of Mahōbā in Bundēlkhaṇḍ, who sang the praises of Rājā-Parmāl, a ruler whose wars with Prithwi-Rāj are recorded in the Mahōbā-Khaṇḍ of Chand's work. Alhā and Udāl, the heroes of the poem, are famous warriors in popular legend, and the stories connected with them exist in an eastern recension, current in Bihār, as well as in the Bundēlkhaṇḍ or western form which is best known. Two versions of the latter have been printed, having been taken down as recited by illiterate professional rhapsodists. Another celebrated bard was Śārangdhar of Rantambhōr, who flourished in 1363, and sang the praises of Hammir Dēo (Hamir Deo), the Chaubān chief of Rantambhōr who fell in a heroic struggle against Sultān 'Alā'uddin Khiljī in 1300. He wrote the *Hammir Kāvya* and *Hammir Rāsau*, of which an account is given by Tod;⁴ he was also a poet in Sanskrit, in which language he compiled, in 1363, the anthology called *Śārngadhara-Paddhati*. Another work which may be mentioned (though much more modern) is the long chronicle entitled *Chhattra-Prakās*, or the history of Rājā Chhatarsāl, the Bundēlā rājā of Fannā, who was killed, fighting on behalf of Prince Dārā-Shukōh, in the battle of Dhōlpur won by Aurangzēb in 1658. The author, Lal Kabi, has given in this work a history of the valiant Bundēlā nation which was rendered into English by Captain W. R. Pogson in 1828, and printed at Calcutta.

Before passing on to the more important branch of early

³ See J.A.S.B. (1886), pp. 6 sqq.
Annals and Antiquities, ii. 452 n. and 472 n.

Hindi literature, the works of the *Bhagats*, mention may be made here of a remarkable composition, a poem entitled the *Padmāvatī*, the materials of which are derived from the heroic legends of Rājputānā, but which is not the work of a bard nor even of a Hindu. The author, Malik Muḥammad of Jā's, in Oudh, was a venerated Muslim devotee, to whom the Hindu rājā of Amēthī was greatly attached. Malik Muḥammad wrote the *Padmāvatī* in 1540, the year in which Shēr Shāh Sūr ousted Humāyūn from the throne of Delhi. The poem is composed in the purest vernacular Awadhī, with no admixture of traditional Hindu learning, and is generally to be found written in the Persian character, though the metres and language are thoroughly Indian. It professes to tell the tale of *Padmāvatī* or *Padmīnī*, a princess celebrated for her beauty who was the wife of the Chauhān rājā of Chhṭōr in Mewār. The historical *Padmīnī's* husband was named Bihm Singh, but Malik Muḥammad calls him Ratan Sēn; and the story turns upon the attempts of 'Alā'uddīn Khiljī, the sovereign of Delhi, to gain possession of her person. The tale of the siege of Chhṭōr in 1303 by 'Alā'uddīn, the heroic stand made by its defenders, who perished to the last man in fight with the Sultan's army, and the self-immolation of *Padmīnī* and the other women, the wives and daughters of the warriors, by the fiery death called *jōhar*, will be found related in Tod's *Rājāshtān*, i. 262 sqq. Malik Muḥammad takes great liberties with the history, and explains at the end of the poem that all is an allegory, and that the personages represent the human soul, Divine wisdom, Satan, delusion and other mystical characters.

Both on account of its interest as a true vernacular work, and as the composition of a Muslimān who has taken the incidents of his morality from the legends of his country and not from an exotic source, the poem is memorable. It has often been lithographed, and is very popular; a translation has even been made into Sanskrit. A critical edition has been prepared by Dr G. A. Grierson and Faqīr Sathākar Dwtivēdi.

The other class of composition which is characteristic of the period of early Hindi, the literature of the *Bhagats*, or Vaiṣṇava saints, who propagated the doctrine of *bhakti*, or faith in Vishnu, as the popular religion of Hindōstān, has exercised a much more powerful influence both upon the national speech and upon the themes chosen for poetic treatment. It is also, as a body of literature, of high intrinsic interest for its form and content. Nearly the whole of subsequent poetical composition in Hindi is impressed with one or other type of Vaiṣṇava doctrine, which, like Buddhism many centuries before, was essentially a reaction against Brahmanical influence and the claims of caste, a claim for the rights of humanity in face of the monopoly which the "twice-born" asserted of learning, of worship, of righteousness. A large proportion of the writers were non-Brahmans, and many of them of the lowest castes. As Śiva was the popular deity of the Brahmanas, so was Vishnu of the people; and while the literature of the Śaivas and Śāktas¹ is almost entirely in Sanskrit, and exercised little or no influence on the popular mind in northern India, that of the Vaiṣṇavas is largely in Hindi, and in itself constitutes the great bulk of what has been written in that language.

The Vaiṣṇava doctrine is commonly carried back to Rāmānuja, a Brahman who was born about the end of the 11th century, at Perambur in the neighbourhood of the modern Madras, and spent his life in southern India. His works, which are in Sanskrit and consist of commentaries on the Vēdānta Sūtras, are devoted to establishing "the personal existence of a Supreme Deity, possessing every gracious attribute, full of love and pity for the sinful beings who adore him, and granting the released soul a home of eternal bliss near him—a home where each soul never loses its identity, and whose state is one of perfect peace."² In the Deity's infinite love and pity he has on several occasions become incarnate for the salvation of mankind, and of these incarnations two, Rāmāchandra, the prince of Ayōdhya, and Krishna, the chief of the Yādava clan and son of Vasudēva,

¹ Worshipers of the energetic power—*Śakti*—of Śiva, represented by his consort Pārvatī or Bhavānī.

² Quoted from G. A. Grierson, chapter on "Literature," in the *India Gazetteer* (ed. 1907).

are pre-eminently those in which it is most fitting that he should be worshipped. Both of these incarnations had for many centuries³ attracted popular veneration, and their histories had been celebrated by poets in epics and by weavers of religious myths in *Purānas* or "old stories"; but it was apparently Rāmānuja's teaching which secured for them, and especially for Rāmāchandra, their exclusive place as the objects of *bhakti*—ardent faith and personal devotion addressed to the Supreme. The adherents of Rāmānuja were, however, all Brahmanas, and observed very strict rules in respect of food, bathing and dress; the new doctrine had not yet penetrated to the people.

Whether Rāmānuja himself gave the preference to Rāma against Krishna as the form of Vishnu most worthy of worship is uncertain. He dealt mainly with philosophic conceptions of the Divine Nature, and probably busied himself little with mythological legend. His *mantra*, or formula of initiation, if Wilson⁴ was correctly informed, implies devotion to Rāma; but Vasudēva (Krishna) is also mentioned as a principal object of adoration, and Rāmānuja himself dwelt for several years in Mysore, at a temple erected by the rājā at Yādavagiri in honour of Krishna in his form Raṅghōr.⁵ It is stated that in his worship of Krishna he joined with that god as his *Śakti*, or Energy, his wife Rukmīnī; while the later varieties of Krishna-worship prefer to honour his mistress Rādhā. The great difference, in temper and influence upon life, between these two forms of Vaiṣṇava faith appears to be a development subsequent to Rāmānuja; but by the time of Jaidē (about 1250) it is clear that the theme of Krishna and Rādhā, and the use of passionate language drawn from the relations of the sexes to express the longings of the soul for God, had become fully established; and from that time onwards the two types of Vaiṣṇava religious emotion diverged more and more from one another.

The cult of Rāma is founded on family-life, and the relation of the worshipper to the Deity is that of a child to a father. The morality it inculcates springs from the sacred sources of human piety which in all religions have wrought most in favour of pureness of life, of fraternal helpfulness and of humble devotion to a loving and tender Parent, who desires the good of mankind, His children, and hates violence and wrong. That of Krishna, on the other hand, had for its basis the legendary career of a less estimable human hero, whose exploits are marked by a kind of elvish and fantastic wantonness; it has more and more spent its energy in developing that side of devotion which is perilously near to sensual thought, and has allowed the imagination and ingenuity of poets to dwell on things unmeet for verse or even for speech. It is claimed for those who first opened this way to faith that their hearts were pure and their thoughts innocent, and that the language of erotic passion which they use as the vehicle of their religious emotion is merely mystical and allegorical. This is probable; but that these beginnings were followed by corruption in the multitude, and that the fervent impulses of adoration made way in later times for those of lust and lasciviousness, seems beyond dispute.

The worship of Krishna, especially in his infant and youthful form (which appeals chiefly to women), is widely popular in the neighbourhood of Mathurā, the capital of that land of Braj where as a boy he lived. Its literature is mainly composed in the dialect of this region, called Brajbhāshā. That of Rāma,

³ The worship of Krishna is as old as Megasthenes (about 300 B.C.), who calls him Herakles, and was then, as now, located at Mathurā on the Jumna river. That of Rāma is probably still more ancient; the name occurs in stories of the Buddha.

⁴ *Religious Sects of the Hindus*, p. 40.

⁵ This name of Krishna, which means "He who quits the battle," is connected with the story of the transfer of the Yādava clan from Mathurā to the new capital on the coast of the peninsula of Kāthiawār, the city of Dwārakā. This migration was the result of an invasion of Braj by Jarāsandha, king of Magadhā, before whom Krishna resolved to retreat. As his path southwards took him through Rājputānā and Gujārat, it is in these regions that his form Raṅghōr is most generally venerated as a symbol of the shifting of the centre of divine life from Gangetic to southern India.

though general throughout Hindūstān, has since the time of Tulsi Dās adopted for poetic use the language of Oudh, called Awadhī or Baiswārī, a form of Eastern Hindi easily understood throughout the whole of the Gangetic valley. Thus these two dialects came to be, what they are to this day, the standard vehicles of poetic expression.

Subsequently to Rāmānuja his doctrine appears to have been set forth, about 1250, in the vernacular of the people by Jaidō, a Brahman born at Kinduvīla, the modern Kendulī, in the Birbhūm district of Bengal, author of the Sanskrit *Gūṭā Gōvinda*, and by Nāmdō or Nāmā, a tailor¹ of Mahārāshtra, of both of whom verses in the popular speech are preserved in the *Adi Granth* of the Sikhs. But it was not until the beginning of the 15th century that the Brahman Rāmānand, a prominent *Gōṣāṭhī* of the sect of Rāmānuja, having had a dispute with the members of his order in regard to the stringent rules observed by them, left the community, migrated to northern India (where he is said to have made his headquarters Galtā in Rajpūtānā), and addressed himself to those outside the Brahman caste, thus initiating the teaching of Vaishnavism as the popular faith of Hindūstān. Among his twelve disciples or apostles were a Rajpūt, a Jāt, a leather-worker, a barber and a Musalman weaver; the last-mentioned was the celebrated Kābir (see separate article). One short Hindi poem by Rāmānand is contained in the *Adi Granth*, and Dr Grierson has collected hymns (*bhājans*) attributed to him and still current in Mithilā or Tirhūt. Both Rāmānand and Kābir were adherents of the form of Vaishnavism where devotion is specially addressed to Rāma, who is regarded not only as an incarnation, but as himself identical with the Deity. A contemporary of Rāmānand, Bidyāpati Thākur, is celebrated as the author of numerous lyrics in the Maithilī dialect of Bihār, expressive of the other side of Vaishnavism, the passionate adoration of the Deity in the person of Krishna, the aspirations of the worshipper being mystically conveyed in the character of Rādhā, the cowherdess of Braj and the beloved of the son of Vasudēva. These stanzas of Bidyāpati (who was a Brahman and author of several works in Sanskrit) afterwards inspired the Vaishnava literature of Bengal, whose most celebrated exponent was Chaitanya (b. 1484). "Another famous adherent of the same cult was Mitrā Bai, "the one great poetess of northern India" (Grierson). This lady, daughter of Rājā Ratiyā Rānā, Rājdhōr, of Mērtā in Rajpūtānā, must have been born about the beginning of the 15th century; she was married in 1413 to Rājā Kumbhkarān of Mēwār, who was killed by his son Uday Rānā in 1469. She was devoted to Krishna in the form of Raṅghōr, and her songs have a wide currency in northern India.

An important compilation of the utterances of the early Vaishnava saints or *Bhagats* is contained in the sacred book, or *Adi Granth*, of the Sikh *Gurus*. Nānak, the founder of this sect (1469-1538), though a native of the Punjab (born at Talvandi on the Rāvi near Lahore), took his doctrine from the *Bhagats* (see Kābir); and each of the thirty-one *rāgs*, forming the body of the *Granth*, is followed by a compilation of texts from the utterances of Vaishnava saints, chiefly of Kābir, in confirmation of the teaching of the *Gurus*, while the whole book is closed by a *bhōg* or conclusion, containing more verses by the same authors, as well as by a celebrated Indian Sūfi, Shēkh Farid of Pākpaṭṭan. The body of the *Granth* (q.v.), being in old Panjābī, falls outside the scope of this article; but the extracts included in it from the early writers of old Hindi are a precious store of specimens of authors some of whom have left no other record in the surviving literature. The *Adi Granth*, which was put together about 1600 by Arjun, the fifth *Guru* of the Sikhs, sets forth the creed of the sect in its original pietistic form, before it assumed the militant character which afterwards distinguished it under the five *Gurus* who succeeded him.

2. *Middle Hindi*.—The second period, that of middle Hindi, begins with the reign of the Emperor Akbar (1556-1605); and it is not improbable that the broad and liberal views of this great monarch, his active sympathy with his Hindū subjects, the interest which he took in their religion and literature, and the peace which his organization of the empire secured for Hindo-

¹ In the *Granth* Nāmdō is called a calico-printer, *Chhīpī*. The Marāṭhī tradition is that he was a tailor, *Sāimī*; it is probable that the latter word, being unknown in northern India, has been wrongly rendered by the former.

stan, had an important effect on the great development of Hindi poetry which now set in.² Akbar's court was itself a centre of poetical composition. The court musician Tān Sēn (who was also a poet) is still renowned, and many verses composed by him in the Emperor's name live to this day in the memory of the people. Akbar's favourite minister and companion, Rājā Birbal (who fell in battle on the north-western frontier in 1583), was a musician and a poet as well as a politician, and held the title, conferred by the Emperor, of *Kābi-Rāy*, or poet laureate; his verses and witty sayings are still extremely popular in northern India, though no complete work by him is known to exist. Other nobles of the court were also poets, among them the *Khān-khānān* 'Abdur-Rāḥīm, son of Bairam Khān, whose Hindi *dohās* and *kobitās* are still held in high estimation, and Faizī, brother of the celebrated Abul-Faizī, the Emperor's annalist.

By this time the worship of Krishna as the lover of Rādhā (*Rādhā-bhakti*) had been systematized, and a local habitation found for it at Gokul, opposite Mathurā on the Jumna, some 30 m. upstream from Agra, Akbar's capital, by Vallabhāchārya, a Tāilinga Brāhman from Madras. Born in 1478, in 1497 he chose the land of Braj as his headquarters, thence making missionary tours throughout India. He wrote chiefly, if not entirely, in Sanskrit; but among his immediate followers, and those of his son Biṭṭhalnāth (who succeeded his father on the latter's death in 1530), were some of the most eminent poets in Hindi. Four disciples of Vallabhāchārya and four of Biṭṭhalnāth, who flourished between 1550 and 1570, are known as the *Aṣṭi Chhōḍp*, or "Eight Seals," and are the acknowledged masters of the literature of Braj-bhāshā, in which dialect they all wrote. Their names are Krishna-Dās Pay-abhārī, Sūr Dās (the Bhat), Parmānand Dās, Kumbhan Dās, Chaturbhuj Dās, Chhit Swāmi, Nand Dās and Gōbind Dās. Of these the most celebrated, and the only one whose verses are still popular, is Sūr Dās. The son of Bābā Rām Dās, who was a singer at Akbar's court, Sūr Dās was descended, according to his own statement, from the bard of Prithwī-Rāj, Chand Bardai. A tradition gives the date of his birth as 1483, and that of his death as 1573; but both seem to be placed too early, and in Abul-Faizī's *Am-i Akbarī* he is mentioned as living when that work was completed (1566/7). He was blind, and entirely devoted to the worship of Krishna, to whose address he composed a great number of hymns (*bhājans*), which have been collected in a compilation entitled the *Sar Sāgar*, said to contain 60,000 verses; this work is very highly esteemed as the high-water mark of Braj devotional poetry, and has been repeatedly printed in India. Other compositions by him were a translation in verse of the *Bhāgavata Purāna*, and a poem dealing with the famous story of Nala and Damayanti; of the latter no copies are now known to exist.

The great glory of this age is Tulsi Dās (q.v.). He and Sūr Dās between them are held to have exhausted the possibilities of the poetic art. It is somewhat remarkable that the time of their appearance coincided with the Elizabethan age of English literature.

To these great masters succeeded a period of artifice and reflection, when many works were composed dealing with the rules of poetry and the analysis and the appropriate language of sentiment. Of their writers the most famous is Kāśab Dās, a Brahman of Bundēlkhand, who flourished during the latter part of Akbar's reign and the beginning of that of Jahāngir. His works are the *Rasik-prīya*, on composition (1591), the *Kāvi-prīya*, on the laws of poetry (1601), a highly esteemed poem dedicated to Parbati Rāi Pāturi, a celebrated courtesan of Orchha in Bundēlkhand, the *Rāmacandrikā*, dealing with the history of Rāma, (1610), and the *Vigyān-gūṭā* (1616). The fruit of this elaboration of the poetic art reached its highest perfection in Bihārī Lal, whose *Sat-sat*, or "seven centuries" (1662), is the most remarkable example in Hindi of the rhetorical style in poetry (see separate article).

² It will be remembered that Akbar's reign was remarkable for the translation into Persian of a large number of Sanskrit works of religion and philosophy, most of the versions being made by, or in the names of, members of his court.

Side by side with this cultivation of the literary use of the themes of Rāma and Krishna, there grew up a class of compositions dealing, in a devotional spirit, with the lives and doings of the holy men from whose utterances and example the development of the popular religion proceeded. The most famous of these is the *Bhakti-mālā*, or "Roll of the *Bhagats*," by Nārāyan Dās, otherwise called Nābhā Dās, or Nābhājī. This author, who belonged to the despised caste of Dōms and was a native of the Deccan, had in his youth seen Tulsī Dās at Mathurā, and himself flourished in the first half of the 17th century. His work consists of 108 stanzas in *chhappāī* metre, each setting forth the characteristics of some holy personage, and expressed in a style which is extremely brief and obscure. Its exact date is unknown, but it falls between 1585 and 1623. The book was furnished with a *ikhā* (supplement or gloss) in the *kaḥillā* metre, by Priyā Dās in 1713, gathering up, in an allusive and disjointed fashion, all the legendary stories related of each saint. This again was expanded about a century later by a modern author named Lachhman into a detailed work of biography, called the *Bhakti-sindhū*. From these nearly all our knowledge (such as it is) of the lives of the Vaiṣṇava authors, both of the Rāma and the Krishna cults, is derived, and much of it is of a very legendary and untrustworthy character. Another work, somewhat earlier in date than the *Bhakti-mālā*, named the *Chaurāsī Vārta*, is devoted exclusively to stories of the followers of Vallabhāchārya. It is reputed to have been written by Gōkūlnāth, son of Bīṭṭhāl-nāth, son of Vallabhāchārya, and is dated in 1551.

The matter of these tales is justly characterized by Professor Wilson¹ (who gives some translated specimens) as "marvellous and insipid anecdotes"; but the book is remarkable for being in very artless prose, and, though written more than 300 years ago, shows that the current language of Braj was then almost precisely identical with that now spoken in that region. A specimen of the text will be found at p. 296 of Mr F. S. Grovse's *Mathura, a District Memoir* (3rd ed., 1883).

It would be tedious to enumerate the many authors who succeeded the great period of Hind poetical composition which extended through the reigns of Akbar, Jahāngir and Shāhjahān. None of them attained to the fame of Sūr Dās, Tulsī Dās or Bihārī Lal. Their themes exhibit no novelty, and they repeat with a wearisome monotony the sentiments of their predecessors. The list of Hindī authors drawn up by Dr G. A. Grierson, and printed in the *Journal of the Asiatic Society of Bengal* in 1889, may be consulted for the names and works of these *epigoni*. The courts of Chhatarānāl, rājās of Panānā in Bundelkhaṇḍ, who was killed in battle with Aurangzēb in 1658, and of several rājās of Bāndhō (now called Riwān or Rewah) in Baghelkhaṇḍ, were famous for their patronage of poets; and the Mogul court itself kept up the office of *Kabī-Rōy* or poet laureate even during the fanatical reign of Aurangzēb.

Such, in the briefest outline, is the character of Hind literature during the period when it grew and flourished through its own original forces. Founded by a popular and religious impulse in many respects comparable to that which, nearly 1600 years before, had produced the doctrine and literature, in the vernacular tongue, of Jainism and Buddhism, and cultivated largely (though by no means exclusively) by authors not belonging to the Brahmanical order, it was the legitimate descendant in spirit, as Hindi is the legitimate descendant in speech, of the Prakrit literature which preceded it. Entirely in verse, it adopted and elaborated the Prakrit metrical forms, and carried them to a pitch of perfection too often overlooked by those who concern themselves rather with the substance than the form of the works they read. It covers a wide range of style, and expresses, in the works of its greatest masters, a rich variety of human feeling. Little studied by Europeans in the past, it deserves much more attention than it has received. The few who have explored it speak of it as an "enchanted garden" (Grierson), abounding in beauties of thought and phrase. Above all it is to be remembered that it is genuinely popular, and has reached strata of society scarcely touched by literature in Europe. The ballads of Rajput prowess, the aphorisms of Kabir, Tulsī Dās's *Rāmāyan*, and the *bhājans* of

¹ *Religious Sects*, p. 132.

Sūr Dās are to this day carried about everywhere by wandering minstrels, and have found their way, throughout the great plains of northern India and the uplands of the Vindhya plateau, to the hearts of the people. There is no surer key to unlock the confidence of the villager than an apt quotation from one of these inspired singers.

3. *Literary Urdū*.—The *origines* of Urdū as a literary language are somewhat obscure. The popular account refers its rise to the time of Timūr's invasion (1398). Some authors even claim for it a higher antiquity, asserting that a *dīvān*, or collection of poems, was composed in *Rekhta* by Mas'ūd, son of Sa'd, in the last half of the 11th or beginning of the 12th century, and that Sa'di of Shirāz and his friend Amīr Khusrāu² of Delhi likewise made verses in that dialect before the end of the 13th century. This, however, is very improbable. It has already been seen that during the early centuries of Muslim rule in India adherents of that faith used the language and metrical forms of the country for their compositions. Persian words early made their way into the popular speech; they are common in Chand, and in Kabīr's verses (which are nevertheless unquestionable Hindi) they are in many places used as freely as in the modern dialect. Much of the confusion which besets the subject is due to the want of a clear understanding of what Urdū, as opposed to Hindi, really is.

Urdū, as a literary language, differs from Hindi rather in its form than in its substance. The grammar, and to a large extent the vocabulary, of both are the same. The really vital point of difference, that in which Hindi and Urdū are incommensurable, is the *prosody*. Hardly one of the metres taken over by Urdū poets from Persian agrees with those used in Hindi. In the latter language it is the rule to give the short *a* inherent in every consonant or *nerus* of consonants its full value in scansion (though in prose it is no longer heard), except occasionally at the metrical pause; in Urdū this is never done, the words being scanned generally as pronounced in prose, with a few exceptions which need not be mentioned here. The great majority of Hindi metres are scanned by the number of *matras* or syllabic instants—the value in time of a short syllable—of which the lines consist; in Urdū, as in Persian, the metre follows a special order of long and short syllables.

The question, then, is not When did Persian first become intermixed with Hindi in the literary speech?—for this process began with the first entry of Muslim conquerors into India, and continued for centuries before a line of Urdū verse was composed; nor When was the Persian character first employed to write Hindi?—for the written form is but a subordinate matter; as already mentioned, the MSS. of Malik Muḥammad's purely Hindi poem, the *Padmāvat*, are ordinarily found to be written in the Persian character; and copies lithographed in Dēvanāgarī of the popular compositions of the Urdū poet Nagr are commonly procurable in the bāzārs. We must ask When was the first verse composed in Hindi, whether with or without foreign admixture, according to the forms of Persian prosody, and not in those of the indigenous metrical system? Then, and not till then, did Urdū poetry come into being. This appears to have happened, as already mentioned, about the end of the 16th century. Meantime the vernacular speech had been gradually permeated with Persian words and phrases. The impulse which Akbar's interest in his Hindī subjects had given to the translation of Sanskrit works into Persian had brought the indigenous and the foreign literatures into contact. The current language of the neighbourhood of the capital, the Hindi spoken about Delhi and thence northwards to the Himālaya, was naturally the form of the vernacular which was most subject to foreign influences; and with the extension of Mogul

² Amīr Khusrāu is credited with the authorship of many still popular rhymes, riddles or punning verses (called *paḥlās* and *mukurās*); but these, though often containing Persian words, are in Hindi and scanned according to the prosody of that language; they are, therefore, like Malik Muḥammad's *Padmāvat*, not Urdū or *Rekhta* verse (see Professor Āzād's *Ābi-Hayāt*, pp. 72-76). A late Dakkhani poet who used the *taḥalluṣ* of Sa'di is said by Āzād (p. 79) to have been confused by Mirzā Rafī'us-Saudā in his *Tashīra* with Sa'di of Shirāz.

territory by the conquests in the south of Akbar and his successors, this idiom was carried abroad by their armies, and was adopted by the Musalmān kingdoms of the Deccan as their court language some time before their overthrow by the campaigns of Aurangzēb.

It is not a little remarkable that, as happened with the Vaishnava reformation initiated by Rāmānuja and Rāmānand, and with the Vallabhāchārya cult of Krishna established at Mathurā, the first impulse to literary composition in Urdū should have been given, not at the headquarters of the empire in the north, but at the Muhammadan courts of Gōlkondā and Bijāpur in the south, the former situated amid an indigenous population speaking Telugu, and the latter among one whose speech was Kanarese, both Dravidian languages having nothing in common with the Aryan tongues of the north. This fact of itself defines the nature of the literature thus inaugurated. It had nothing to do with the idiom or ideas of the people among whom it was born, but was from the beginning an imitation of Persian models. It adopted the standards of form and content current among the poets of Erān. The *qaṣīda* or laudatory ode, the *ghazal* or love-sonnet, usually of mystical import, the *masnāvī* or dirge, the *masnāvī* or narrative poem with coupled rhymes, the *hijā* or satire, the *rubāʿī* or epigram—these were the types which Urdū took over ready-made. And with the forms were appropriated also all the conventions of poetic diction. The Persians, having for centuries treated the same themes with a fecundity which most Europeans find extremely wearisome, had elaborated a system of rhetoric and a stock of poetic images which, in the exhaustion of original matter, made the success of the poet depend chiefly upon dexterity of artifice and cleverness of conceit. Pleasing hyperbole, ingenious comparison, antithesis, alliteration, carefully arranged gradation of noun and epithet, are the means employed to obtain variety; and few of the most eloquent passages of later Persian verse admit of translation into any other language without losing that which in the original makes their whole charm. What is true of Persian is likewise true of Urdū poetry. Until quite modern times, there is scarcely anything in it which can be called original.¹ Differences of school, which are made much of by native critics, are to us hardly perceptible; they consist in the use of one or other range of metaphor or comparison, classed, according as they repeat the well-worn poetical stock-in-trade of the Persians, or seek a slightly fresher and more Indian field of sentiment, as the old or the new style of composition.

Shujāʿuddīn Nūrī, a native of Gujārat, a friend of Faizī and contemporary of Akbar, is mentioned by the native biographers as the most ancient Urdū poet after Amir Khusrau. He was tutor of the son of the *waṣīr* of Sultān Abū-l-Ḥasan Kutb Shāh of Gōlkonda, and several *ghazals* by him are said to survive. Kuli Kutb Shāh of Gōlkonda, who reigned from 1581, and his successor ʿAbdullāh Kutb Shāh, who came to the throne in 1611, have both left collections of verse, including *ghazals*, *rubāʿīs*, *masnāvīs* and *qaṣīdas*. And during the reign of the latter Ibn Nishāʿī wrote two works which are still famous as models of composition in Dakhnī; they are *masnāvīs* entitled the *Tūḥ-nāma*, or "Tales of a Parrot," and the *Phūl-bas*. The first, written in 1639, is an adaptation of a Persian work by Nakhshabī, but derives ultimately from a Sanskrit original entitled the *Suka-saplāti*; this collection has been frequently rehandled in Urdū, both in verse and prose, and is the original of the *Tūḥ-nāmahī*, one of the first works in Urdū prose, composed in 1801 by Muḥammad Ḥaidar-bakhsh Ḥaidarī of the Fort William College. The *Phūl-bas* is a love tale named from its heroine, said to be translated from a Persian work entitled the *Basāʾīs*. Another famous work which probably belongs to the same place and time is the *Story of Kāmraṭ and Kālā* by Tahānuddīn, a *masnāvī* which has been published (1836) by M. Garcin de Tassy; what makes this poem remarkable is that, though the work of a Musalmān, its personages are Hindu. Kāmraṭ, the hero, is son of the king of Oudh, and the heroine, Kālā, daughter of the king of Ceylon; the incidents somewhat resemble those of the tale of *as-Sindibād* in the *Thousand and One Nights*; the hero and heroine dream one of the other, and the former sets forth to find his beloved; his wanderings take him to

¹ An exception may be made to this general statement in favour of the *genre* pictures of city and country life contained in the *masnāvīs* of Saūdā and Naḡīr. These are often satires (in the vein of Horace rather than Juvenal), and are full of interest as pictures of society. In Saūdā, however, the conventional language used in description is often Persian rather than Indian.

many strange countries and through many wonderful adventures, ending in a happy marriage.

The court of Bijāpur was no less distinguished in literature. Ibrāhīm ʿAdil Shāh (1579-1626) was the author of a work in verse on music entitled the *Nas-ras* or "Nine Savours," which, however, appears to have been in Hindi rather than Urdū; the three prefaces (*diwānas*) to this poem were rendered into Persian prose by Maulā Zuhūrī, and, under the name of the *Sih naṣr-i Zuhūrī*, are well-known models of style. A successor of this prince, ʿAlī ʿAdil Shāh, had as his court poet a Brahman known poetically as Nuṣratī, who in 1657 composed a *masnāvī* of some repute entitled the *Gulshan-i ʿIshq*, or "Rose-garden of Love," a romance relating the history of Prince Manōhar and Madmālātī,—like the *Kāmraṭ*, an Indian theme. The same poet is author of an extremely long *masnāvī* entitled the *ʿAlī-nāma*, celebrating the monarch under whom he lived.

These early authors, however, were but pioneers; the first generally accepted standard of form, a standard which suffered little change in two centuries, was established by Wālī of Aurangzāb (about 1680-1720) and his contemporary and fellow-townsmān Sirāj. The former of these is commonly called "the Father of Rikhtah"—*Bābā-e Rikhtā*; and all accounts agree that the immense development attained by Urdū poetry in northern India during the 18th century was due to his example and initiative. Very little is known of Wālī's life; he is believed to have visited Delhi towards the end of the reign of Aurangzāb, and is said to have there received instruction from Shāh Gulshan in the art of clothing in a versatile dress the ideas of the Persian poets. His *Kalīdāt* or complete works have been published by M. Garcin de Tassy, with notes and a translation of selected passages (Paris, 1834-1836), and may be commended to readers desirous of consulting in the original a favourable specimen of Urdū poetical composition.

The first of the Delhi school of poets was Zuhūriddīn Ḥātim, who was born in 1699 and died in 1792. In the second year of Muḥammad Shāh (1719), the *diwān* of Wālī reached Delhi, and excited the emulation of scholars there. Ḥātim was the first to imitate it in the Urdū of the north, and was followed by his friends Nāji, Mazmūn and Abrū. Two *diwāns* by him survive. He became the founder of a school, and one of his pupils was Rafī us-Saūdā, the most distinguished poet of northern India. Khān Arzū (1689-1756) was another of the fathers of Urdū poetry in the north. This author is chiefly renowned as a Persian scholar, in which language he not only composed much poetry, but one of the best of Persian lexicons, the *Sirāj-u-l-Lughāt*; but his compositions in Urdū are also highly esteemed. He was the master of Mir Taqī, who ranks next to Saūdā as the most eminent Urdū poet. Arzū died at Lucknow, whither he betook himself after the devastation of Delhi by Nādir Shāh (1739). Another of the early Delhi poets who is considered to have surpassed his fellows was Inʿāmullāh Khān Yaḡīn, who died during the reign of Ahmad Shāh (1748-1754), aged only twenty-five. Another was Mir Dard, pupil of the same Shāh Gulshan who is said to have instructed Wālī; his *diwān* is not long, but extremely popular, and especially esteemed for the skill with which it develops the themes of spiritualism. In his old age he became a *darwish* of the *Naṣbābandī* following, and died in 1793.

Saūdā and Mir Taqī are beyond question the most distinguished Urdū poets. The former was born at Delhi about the beginning of the 18th century, and studied under Ḥātim. He left Delhi after its devastation, and settled at Lucknow, where the Nawāb Asaf-ud-daulah gave him a *jaḡir* of Rs. 6000 a year, and where he died in 1780. His poems are very numerous, and cover all the styles of Urdū poetry; but it is to his satires that his fame is chiefly due, and in these he is considered to have surpassed all other Indian poets. Mir Taqī was born at Agra, but early removed to Delhi, where he studied under Arzū; he was still living there at the time of Saūdā's death, but in 1782 repaired to Lucknow, where he likewise received a pension; he died at a very advanced age in 1810. His works are very voluminous, including no less than six *diwāns*. Mir is counted the superior of Saūdā in the *ghazal* and *masnāvī*, while the latter excelled him in the satire and *qaṣīda*. Sayyid Ahmad, an excellent authority, and himself one of the best of modern authors in Urdū, says of him in his *Asār-u-Sanādīd*: "Mir's language is so pure, and the expressions which he employs so suitable and natural, that to this day all are unanimous in his praise. Although the language of Saūdā is also excellent, and he is superior to Mir in the point of his allusions, he is nevertheless inferior to him in style."

The tremendous misfortunes which befell Delhi at the hands of Nādir Shāh (1739), Ahmad Shāh Durrānī (1756), and the Marāṭhās (1759), and the rapid decay of the Mogul empire under these repeated shocks, transferred the centre of the cultivation of literature from that city to Lucknow, the capital of the newly founded and flourishing state of Oudh. It has been mentioned how Arzū, Saūdā and Mir betook themselves to this refuge and ended their days there; they were followed in their new residence by a school of poets hardly inferior to those who had made Delhi illustrious in the first half of the century. Here they were joined by Mir Hasan (d. 1786), Mir Sāy (d. 1800) and Qalandar-bakhsh Jurʿat (d. 1810), also like themselves refugees from Delhi, and illustrious poets. Mir Hasan was a friend and collaborator of Mir Dard, and first established himself at Faizābād and subsequently at Lucknow; he excelled in the *ghazal*,

rubāʿī, *maghazī* and *marṣiya*, and is counted the third, with Saudī and Mir Taqī, among the most eminent of Urdū poets. His fame chiefly rests upon a much admired *maghazī* entitled the *Sībrū-l-bayān*, or "Magic of Eloquence," a romance relating the loves of Prince Bē-nāzīr and the Princess Badr-i Muṣṣir; his *maghazī* called the *Guldār-i Iram* ("Rose-garden of Iram," the legendary 'Adite paradise in southern Arabia), in praise of Faizābād, is likewise highly esteemed. Mir Muḥammadi Sōz was an elegant poet, remarkable for the success with which he composed in the dialect of the haṛam called *Rakkā*, but somewhat licentious in his verse; he became a *darwish* and renounced the world in his later years. Jur'at was also a prolific poet, but, like Sōz, his *ghazals* and *maghazīs* are licentious and full of double meanings. He imitated Saudī in satire with much success; he also cultivated Hindi poetry, and composed *dohās* and *habības*. Miskīn was another Lucknow poet of the same period, whose *marṣiyas* are especially admired; one of them, that on the death of Muslim and his two sons, is considered a masterpiece of this style of composition. The school of Lucknow, so founded and maintained during the early years of the century, continued to flourish till the dethronement of the last king, Wājīd 'Alī, in 1856. Aṭash and Nāsikh (who died respectively in 1847 and 1841) are the best among the modern poets of the school in the *ghazal*; Mir Anīs, a grandson of Mir Hasan, and his contemporary Dabīr, the former of whom died in December 1875 and the latter a few months later, excelled in the *marṣiya*. Rājab Aḷī Beg Surūr, who died in 1869, was the author of a much-admired romance in rhyming prose entitled the *Fīstānah-e 'Aḷāsh* or "Tale of Marvels," besides a *diwān*. The dethroned prince Wājīd 'Alī himself, poetically styled Akhtar, was also a poet; he published three *diwāns*, among them a quantity of poetry in the rustic dialect of Oudh which is philologically of much interest.

Though Delhi was thus deserted by its brightest lights of literature, it did not altogether cease to cultivate the poetic art. Among the last Mogul several princes were themselves creditable poets. Shāh Alām II. (1761-1806) wrote under the name of Akshab, and was the author of a romance entitled *Manāṣim-e Aqdas*, besides a *diwān*. His son Sulaimān-shukh, brother of Akbar Shāh II., who had at first, like his brother authors, repaired to Lucknow, returned to Delhi in 1815, and died in 1838; he also has left a *diwān*. Lastly, his nephew Bahādur Shāh II., the last titular emperor of Delhi (d. 1862), wrote under the name of Zafar, and was a pupil in poetry of Shaikh Ibrāhīm Zauq, a distinguished writer; he has left a voluminous *diwān*, which has been printed at Delhi. Maḥbūfī (Ghulām-i Hamdānī), who died about 1814, was one of the most distinguished of the revived poetic school of Delhi, and was himself one of its founders. Originally of Lucknow, he left that city for Delhi in 1777, and held conferences of poets, at which several authors who afterwards acquired repute formed their style; he has left five *diwāns*, a *Taḳrīr* or biography of Urdū poets, and a *Shāh-nāma* or account of the kings of Delhi down to Shāh 'Alām. Qāsim (Qiyāmuḍḍīn 'Alī) was one of his society, and died in 1792; he has left several works of merit. Ghālib, otherwise Mirzā Asadullāh Khān Naushāh, laureate of the last Mogul, who died in 1869, was undoubtedly the most eminent of the modern Delhi poets. He wrote chiefly in Persian, of which language, especially in the form cultivated by Firdausī, free from intermixture of Arabic words, he was a master; but his Urdū *diwān*, though short, is excellent in its way, and his reputation spread far and wide. To this school, though he lived and died at Agra, may be attached Mir Wali Muḥammad Naḡir (who died in the year 1832); his *maghazīs* entitled *Juḡī-nāma*, *Kasrī-nāma*, *Banjāre-nāma*, and *Buchāpe-nāma*, as well as his *diwān*, have been frequently reprinted, and are extremely popular. His language is less artificial than that of the generality of Urdū poets, and some of his poems have been printed in Nāgarī, and are as well known and as much esteemed by Hindus as by Mahommedans. His verse is defaced by much obscenity.

4. *Modern Period.*—While such, in outline, is the history of the literary schools of the Deccan, Delhi and Lucknow, a fourth, that of the Fort William College at Calcutta, was being formed, and was destined to give no less an impulse to the cultivation of Urdū prose than had a hundred years before been given to that of poetry by Walli. At the commencement of the 19th century Dr John Gilchrist was the head of this institution, and his efforts were directed towards getting together a body of literature suitable as text-books for the study of the Urdū language by the European officers of the administration. To his exertions we owe the elaboration of the vernacular as an official speech, and the possibility of substituting it for the previously current Persian as the language of the courts and the government. He gathered together at Calcutta the most eminent vernacular scholars of the time, and their works, due to his initiative, are still notable as specimens of elegant and serviceable prose composition, not only in Urdū, but also in Hindi. The chief authors of this school are Haidar (Sayyid Muḥammad Haidar-bakhs), Husaini (Mir Bahādur 'Alī), Mir

Amman Luṭfī, Ḥafīzuddīn Aḥmad, Shēr 'Alī Afsōs, Nihāl Chand of Lahore, Kāgīm 'Alī Jawān, Lallū Lal Kavi, Maghar 'Alī Wils and Ikram 'Alī.

Haidarī died in 1828. He composed the *Toḡā-Kahānī* (1801), a prose redaction of the *Tuḡī-nāmah* which has been already mentioned; a romance named *Arḡūsh-i Mahfil* ("Ornament of the Assembly"), detailing the adventures of the famous Arab chief Ḥātim-i Taī; the *Gul-i Maghfarat* or *Dah Majlis*, an account of the holy persons of the Muḥammadan faith; the *Guldār-i Dānish*, a translation of the *Bahār-i Dānish*, a Persian work containing stories descriptive of the craft and faithlessness of women; and the *Tārīkh-i Nādirī*, a translation of a Persian history of Nādir Shāh. Husaini is the author of an imitation in prose of Mir Ḥasan's *Sībrū-l-bayān*, under the name of *Nāzr-i Bēnāzīr* ("the Incomparable Prose," or "the Prose of Bēnāzīr," the latter being the name of the hero), and of a work named *Ahḷāq-i Hindī*, or "Indian Morals," both composed in 1802. The *Ahḷāq-i Hindī* is an adaptation of a Persian work called the *Mufarriḡ-i-qulūb* ("the Delighter of Hearts"), itself a version of the *Hilōpaddēto*. Mir Amman was a native of Delhi, which he left in the time of Aḥmad Shāh Durrānī for Patna, and in 1801 repaired to Calcutta. To him we owe the *Bāgh-o Bahār* (1801-1802), an adaptation of Amir Khusrau's famous Persian romance entitled the *Chahār Darwāsh*, or "Story of the Four Dervishes." Amman's work is not itself directly modelled on the Persian, but is a re-translation of an almost contemporary rendering by Tahsīn of Etchwā, called the *Naw-tār-i Muraṣṣā*. The style of this composition is much admired by natives of India, and editions of it are very numerous. Amman also composed an imitation of Husaini Wā'iz Kāshifī's *Ahḷāq-i Muḥrīnī* under the name of the *Ganj-i-Kāhīl* ("Treasure of Virtue"), produced in 1802. Ḥafīzuddīn Aḥmad was a professor at the Fort William College; in 1803 he completed a translation of Abul-Faḷāḥ 'Iyār-i Dānish, under the name of the *Khurād-afzār* ("Enlightener of the Understanding"). The '*Iyār-i Dānish*' ("Touchstone of Wisdom") is one of the numerous imitations of the originally Sanskrit collection of apologues known in Persian as the *Fables of Bidpai*, or *Kalīlah and Dimna*. Afsōs was one of the most illustrious of the Fort William school; originally of Delhi, he left that city at the age of eleven, and entered the service of Qāsim 'Alī Khān, Nawāb of Bengal; he afterwards repaired to Hyderabad in the Deccan, and thence to Lucknow, where he was the pupil of Mir Hasan, Mir Sōz and Mir Haidar 'Alī Hairān. He joined the Fort William College in 1800, and died in 1809. He is the author of a much esteemed *diwān*; but his chief reputation is founded on two prose works of great excellence, the *Arḡūsh-i Mahfil* (1803), an account of India adapted from the introduction of the Persian *Khulāṣat-i-tarīkh* of Sujān Rāe, and the *Bāgh-i Urdū* (1808), a translation of Sa'dī's *Gulistan*. Nihāl Chand translated into Urdū a *maghazī*, entitled the *Gul-i Bahār*, under the name of *Maḥbūf-i 'Ishq* ("Religion of Love"); this work is in prose intermingled with verse, was composed in 1804, and has been frequently reproduced. Jawān, like most of his collaborators, was originally of Delhi and afterwards of Lucknow; he joined the College in 1800. He is the author of a version in Urdū of the well-known story of Sakuntalā, under the name of *Sakuntalā Nānak*; the Urdū was rendered from a previous Braj-bhāshā version by Nawāe Kabīshwar made in 1716, and was printed in 1802. He also composed a *Bārah-māsā*, or poetical description of the twelve months (a very popular and often-handled form of composition), with accounts of the various Hindu and Muḥammadan festivals, entitled the *Dastūr-i Hind* ("Usages of India"), printed in 1812. Ikram 'Alī translated, under the name of the *Ikhwānu-s-safā*, or "Brothers of Purity" (1810), a chapter of a famous Arabian collection of treatises on science and philosophy entitled *Rasā'ilu Ikhwānu-s-safā*, and composed in the 10th century. The complete collection, due to different writers who dwelt at Basra, has recently been made known to European readers by the translation of Dr F. Dieterici (1859-1870); the chapter selected by Ikram 'Alī is the third, which records an allegorical strife for the mastery between men and animals before the king of the *Jinn*. The translation is written in excellent Urdū, and is one of the best of the Fort William productions.

Sei Lallū Lal was a Brahman, whose family, originally of Gujārat, had long been settled in northern India. What was done by the other Fort William authors for Urdū prose was done by Lallū Lal almost alone for Hindi. He may indeed without exaggeration be said to have created "High Hindi" as a literary language. His *Prem Sāgar* and *Rājānī*, the former a version in pure Hindi of the 10th chapter of the *Bhāgavata Purāṇa*, detailing the history of Kṛishṇa, and founded on a previous Braj-bhāshā version by Chaturbhuj Mīr, and the latter an adaptation in Braj-bhāshā prose of the *Hilōpaddēto* and part of the *Pancha-tantra*, are unquestionably the most important works in Hindi prose. The *Prem Sāgar* was begun in 1804 and ended in 1810; it enjoys immense popularity in northern India, has been frequently reproduced in a lithographed form, and has several times been printed. The *Rājānī* was composed in 1809; it is much admired for its sententious brevity and the purity of its language. Besides these two works, Lallū Lal was the author of a collection of a hundred anecdotes in Hindi and Urdū entitled *Lafāz-i Hindī*, an anthology of Hindi verse called the *Sabha-bīnā*,

a *Sul-sal* in the style of Bihārī-Lāl called *Sapta-satika* and several other works. He and Jawān worked together at the *Singhāsān Battist* (1801), a redaction in mixed Urdu and Hindi (Dīvānāgarī character) of a famous collection of legends relating the prowess of King Vikramāditya; and he also aided the latter author in the production of the *Sakuntalā Nāṭak*. Māzhar 'Alī Wīlā was his collaborator in the *Battist Pākshī*, a collection of stories similar in many respects to the *Singhāsān Battist*, and also in mixed Urdu-Hindi; and he aided Wīlā in the preparation in Urdu of the *Story of Mādhōnāl*, a romance originally composed in Braj-bhāshā by Mōṭī Rām.

The works of these authors, though compiled and published under the superintendence of Dr Gilchrist, Captain Abraham Lockett, Professor J. W. Taylor, Dr W. Hunter and other European officers of the college of Fort William, and originally intended for the instruction of the Company's officers in the vernacular, are essentially Indian in taste and style, and, until superseded by the more recent developments of literature noticed below, enjoyed a very wide reputation and popularity. They may, indeed, be said to have set the standard of prose composition in Urdu and Hindi, and for the first half of the 19th century their influence in this respect continued almost unchallenged. Side by side with them, among the Muslim population of northern India, another almost contemporaneous impulse did much for the expansion of the Urdu language, and, like the work of the Vaiṣṇava reformers in moulding literary Hindi, gave an impetus to composition which might otherwise have been lacking. This was the reform in Islam led by Sayyid Ahmad and his followers. In all Eastern countries religion is the first and chief subject of literary production; and the controversies which the new preaching aroused in India at once afforded abundant material for authorship in Urdu, and interested deeply the people to whom the works were addressed.

Sayyid Ahmad was born in 1782, and received his early education at Delhi; his instructors were two learned Muslims, Shāh 'Abdu-l-'Aziz, author of a celebrated commentary on the Qur'ān (the *Tafsīr-i 'Asīziyāh*), and his brother 'Abdu-l-Qādir, the writer of the first translation of the holy volume into Urdu. Under their guidance Sayyid Ahmad embraced the doctrines of the Wahhābīs, a sect whose preaching appears at this time to have first reached India. He gathered round him a large number of fervent disciples, among others Ismā'īl Hājī, nephew of 'Abdu-l-'Aziz and 'Abdu-l-Qādir, the chief author of the sect. After a course of preaching and apostleship at Delhi, Sayyid Ahmad set out in 1820 for Calcutta, attended by numerous adherents. Thence in 1822 he started on a pilgrimage to Mecca, whence he went to Constantinople, and was there received with distinction and gained many disciples. He travelled for nearly six years in Turkey and Arabia, and then returned to Delhi. The religious degradation and coldness which he found in his native country strongly impressed him after his sojourn in lands where the life of Islam is stronger, and he and his disciples established a propaganda throughout northern India, reproaching the superstitions which had crept into the faith from contact with Hindus, and preaching a *jihād* or holy war against the Sikhs. In 1828 he started for Peshāwar, attended by, it is said, upwards of 100,000 Indians, and accompanied by his chief followers, Hājī Ismā'īl and 'Abdu-l-Hayy. He was furnished with means by a general subscription in northern India, and by several Muhammadan princes who had embraced his doctrines. At the beginning of 1829 he declared war against the Sikhs, and in the course of time made himself master of Peshāwar. The Afghāns, however, with whom he had allied himself in the contest, were soon disgusted by the rigour of his creed, and deserted him and his cause. He fled across the Indus and took refuge in the mountains of Pakhlā and Dhāmṭūr, where in 1831 he encountered a detachment of Sikhs under the command of Sher Singh, and in the combat he and Hājī Ismā'īl were slain. His sect is, however, by no means extinct; the Wahhābī doctrines have continued to gain ground in India, and to give rise to much controversial writing, down to our own day.

The translation of the Quran by 'Abdu-l-Qādir was finished in 1803, and first published by Sayyid 'Abdullāh, a fervent disciple of Sayyid Ahmad, at Hājī in 1829. The *Tamhīn-i-shāhīn*, or "Awakener of the Heedless," a work in Persian by Sayyid Ahmad, was rendered into Urdu by 'Abdullāh, and published at the same press in 1830. Hājī Ismā'īl was the author of a treatise in Urdu entitled *Taqwīyāt-i-Imān* ("Confirmation of the Faith"), which had great vogue among the following of the Sayyid. Other works by the disciples of the *Tariqah-e-Muhammadiyah* (as the new preaching was called) are the *Tarhīb-i-Jihād* ("Incitation to Holy War"), *Hidāyat-u-l-Mu'minin* ("Guide of the Believers"), *Māzih-u-l-Kabīr wa-l-Bid'ah* ("Exposition of Mortal Sins and Heresy"), *Nashatu-l-Muslimin* ("Admonition to Muslims"), and the *M'at Masūl*, or "Hundred Questions."

Printing was first used for vernacular works by the College Press at Fort William, at the end of the 18th and the beginning of the 19th century, and all the compositions prepared for Dr Gilchrist and his successors which have been mentioned were thus given to the public. But the expense of this method of reproduction long precluded its extensive use in India, and movable types, though

well suited for alphabets derived from the Sanskrit, were not equally applicable to the flowing and graceful characters of Persian. Lithography was introduced about 1837, when the first press was set up at Delhi, and immediately gave a powerful stimulus to the multiplication of literature, both original and editions of older works. In 1832 the vernaculars were substituted for Persian as the official language of the courts and the acts of the legislature, and this at once led to the transfer to the former of a mass of technical and forensic terms which had previously been only to a limited extent in popular use. Thirdly, the spread of education in subjects of Western learning, for which text-books (many of them translations from English) were required, not only greatly enlarged the vocabulary of the common speech, but led by degrees to the use of a simpler and more direct style, and the abandonment wholesale of the florid and artificial ornament which was the legacy of the Persian literature upon which Urdu prose had at first modelled itself. Lastly, the establishment of a vernacular newspaper press, which lithography had rendered possible, placed within the reach of a continually widening public the means of becoming acquainted with new ideas in every department of culture, and practised the writers who contributed to it in the art of wielding their mother-tongue with effect in its application to European themes.

All these revolutionary agencies were at work, though in a tentative and limited fashion, when the great change, following on the Mutiny of 1857, of the transfer of the government of India from the Company to the Crown inaugurated a new era. Since 1860 their operation has become extremely rapid and far-reaching. The use of lithography both for Urdu and Hindi annually gives birth to hundreds of works. The extension of education through both public and private agency has created an immense mass of school-books, and the spread of instruction in English and the activity of translators have filled the vernaculars with a multitude of new words drawn from that language. The newspaper press, in Urdu and Hindi, now counts over two hundred journals, the majority issued in the United Provinces of Agra and Oudh and in the Punjab, but a few at Madras, Hyderabad, Bangalore, Bombay and Calcutta. Of this great body of literary production it is possible to speak only in general terms. Style and vocabulary are still in a somewhat fluid and unsettled condition, and the subjects treated are almost as various as they are in European literatures. Much, indeed, of the work produced has scarcely any claim to literary excellence, and in the crowd of writers we may content ourselves with mentioning only a few whose influence and authority make it probable that they will hereafter be known as leaders in the new culture.

One of the first effects of the new literary inspiration seemed to be the extinction of poetical composition as previously practised. With the deaths of Zaouq (1854) and Ghālīb (1869) of the Delhi school, and those of Anīs (1875) and Dabir (1876) of Lucknow, the end of Urdu poetry appeared to have come. The new age was intensely practical and eager to engage in the race for material and political advancement, and had no time for sentiment, or taste for mystical conceits. Moreover, poetical composition in India, as in other Eastern countries, has always owed much to the patronage of courts and princes. The thrones of Delhi and Lucknow had passed away, and the new rulers showed little interest in this form of achievement. Only at Hyderabad in the Deccan, under the patronage of the Nizam, were laureates still honoured; the last of these, Mirzā Khān Dāgh (1831-1905), enjoyed a wide reputation as a graceful and eloquent master of the poetic art.

But prose and material prosperity did not succeed in monopolizing the genius of the people. The great movement of reform and liberalism in Islam led by Sir Sayyid Ahmad Khān (1817-1898) found its bard in Sayyid Aḥmād Husain of Pānīpāt, poetically styled Hālī—an ambiguous *nom-de-plume* now generally taken in the sense of "modern," or "up-to-date." Hālī in his youth was a pupil of the famous Ghālīb, whose life he has written and of whose writings he has published an able criticism. At the age of forty he came under the influence of Sir Sayyid Ahmad Khān, and from that time devoted his great poetic gifts to the service of his co-religionists. He has published much verse, of which an interesting specimen will be found in the edition of his *Zubair* or *Quatrains* (101 in number), with an English translation, by Mr G. E. Ward (Oxford, 1904); in this is included a famous poem addressed to his muse, setting forth his ideals in poetry—simplicity, avoidance of exaggeration and unreality, direct and emotional appeal to the heart, and above all sincerity. There can be no doubt that he has succeeded in becoming the leader of a new poetic school, which shows much vigour and promise.

Perhaps the most memorable of all Hālī's compositions is his long poem in six-line stanzas (called *musaddas*) on "the flow and ebb of Islam" (1879), which has had an extraordinary influence in stimulating enthusiasm in the cause of progress among the Muslims of the north of India. In it he draws, in simple and direct but searching and eloquent language, a rapid sketch of the glories of Islam in the past, its principles and precepts, and the sources of its strength; and then turns to contrast with this picture the degradation and decay into which it had, when he wrote, fallen in Hindūstān. Never have the vices and shortcomings of a people been lashed by one of themselves with more vigorous denunciation, or with more earnestness of moral purpose. In his preface he

¹ To be carefully distinguished from the reformer of the same name who flourished half a century later.

explains how the poem came to be written—after a youth spent in heedlessness and unsettlement, at the instigation of Sir Sayyid Ahmad Khān, and in the cause of that great reformer. The poem is still recited and imitated by Muslims in the Punjab and United Provinces, though the picture which it presents of Indian Musalmāns is no longer wholly applicable to the community. Hāll has recently completed a life of Sir Sayyid Ahmad Khān in two volumes, entitled *Hayat-i Javid* ("eternal life"), a work of great merit.

Another writer whose work, though chiefly in prose, deals with poetry and poetic style, is Maulavi Muhammad Husain Āzād, lately professor of Arabic at the Government College, Lahore. He has not himself composed much verse; but his biographies of Urdu poets, with criticisms of their works, entitled *Āb-i Hayāt* ("Water of Life," Lahore, 1883), is by far the best book dealing with the subject. His prose style is much admired. As Hāll was the pupil of Ghālib, so was Āzād that of Zama, of whose poems he has published a revised and annotated edition. His other works in prose are *Qisas-i Hind*, episodes of Indian history arranged for schools; *Naurang-i Khyāl*, an allegory dealing with human life; and *Darbār-i Akbar*, an account of the reign of Akbar.

Sir Sayyid Ahmad Khān's life and work are dealt with elsewhere. Among his literary achievements may be mentioned the *Ādirus-Sandhd* ("Vestiges of Princes"), an excellent account of Delhi and its monuments, which has passed through several editions since it was first lithographed in 1847. His essays and occasional papers, published in the *Aligarh Institute Gazette* (started in 1864), and afterwards (from 1870 onwards) in a periodical entitled *Tahsīl-i Akhīdā* (or "Muhammadan Social Reformer"), handle all the problems of religious, social and educational advancement among Indian Musalmāns—the cause with which his life was identified. His great *Commentary on the Qur'ān*, in seven volumes, the last finished only a few days before his death in 1898, is carried to the end of *Sūrah* xx., a little more than half the book. In his Urdu prose found its most powerful wielder for the diffusion of modern ideas, and the movement which he set on foot has been the spring of the best literature in the language during recent years.

Another excellent writer of Urdu is Shamsul-Ulamā Maulavi Nagir Ahmad of Delhi, who is the author of a series of novels describing domestic life, of a somewhat didactic character, which have had a wide popularity, and from their admirable moral tone have been specially serviceable in the education of Indian women. These are entitled the *Mir'ātul-'Arās* (or "Brides' Mirror"), *Touhfat-un-Nasīb* ("the Repentance of Nasīb"), *Bandūn-Nasīb* ("the Seven Stars of the Great Bear"), *Jawāb-Haqq* ("Son of the Age"), and *Azīmā* ("Widows"). But Nagir Ahmad is a man of many ideas; before he took to novel-writing he was the principal translator into Urdu of the *Indian Penal Code* (1861), which is reckoned a masterpiece in the exact rendering of European legal ideas; and more lately he gave to the world the best Urdu version of the Qur'an. He has been a popular lecturer on social subjects, displaying a rich vein of humour, and in his old age even ventured upon verse. During the latter portion of his life he was most closely associated with Sir Sayyid Ahmad Khān.

The novel is one of the most noteworthy features of recent literary composition in Urdu. India has from time immemorial been rich in stories and romances of adventure; but the description of actual life and character in action, as the modern novel is understood in Europe, is quite a new development. The most admired production of this kind in Urdu is a work entitled *Fisṭah-e Āzād*, by Paṅḍit Ratan-nāth Sarāhār of Lucknow. The story, which is very long, is remarkable for the faithful and vivid pictures of Lucknow society which it presents, and its exact and lifelike delineation of character; it appeared originally as a *feuilleton* of the *Amudh Akhbar*, of which paper the author was at the time editor. Another good writer in the same branch of literature is Maulavi 'Abdul-Halim Sharar, also a native of the neighbourhood of Lucknow, but settled at Hyderabad. He was editor of a monthly periodical called the *Du-pudās* ("melter of hearts"), which contained essays and papers in European style, and in it his novels, which are all of an historical character, in the style of Sir Walter Scott, originally appeared. The best are *Āzās and Virginia*, a tale of the Crusades, and *Mansār and Mōhīnd*, a story of which the scene is laid in India at the time of the invasions of Sultan Mahmūd of Ghazni.

Although Urdu chiefly represents Musalmān culture, its use is by no means confined to adherents of that faith. It has just been mentioned that the most popular Urdu novelist is a Hindu (a Brāhman from Kashmir); and the statistics of the vernacular press show that this form of the language is widely used by Hindus as well as Musalmāns. Thus, of eighty periodicals in Urdu published in the United Provinces, twenty-nine are conducted by Hindus; similarly, in the Punjab, of forty-eight Urdu journals, twenty are edited by Hindus.

"High Hindi" has scarcely adapted itself to modern requirements with the thoroughness displayed by Urdu. It is taught in the schools where the population is mainly Hindu, and books of science have been written in it with a terminology borrowed from Sanskrit, in place of the Persian terms used in the other dialect. But Sanskrit is far removed from the daily life of the people, and the majority of works in this style are read only by Pandits, the great bulk of them dealing

with religion, philosophy and the ancient literature. There are thirty-seven Hindi and four Hindi-Urdu journals in the United Provinces; but many of them are exclusively religious in their character, and several, though written in Dēvaṅgarī, employ a mixed language which admits Persian words freely. The old dialects of literature, Awadhī and Braj-bhāshā, are now only used for poetry; High Hindi has been a complete failure for this purpose.

The most noticeable authors in Hindi since the middle of the 19th century have been Bābū Hariśchandra and Rājā Siva Prāsād, both of Benares. The former, during his short life (1850-1885), was an enthusiastic cultivator of the old poetic art, using the dialects just mentioned. He published in the *Sundarī Tūlak* an anthology of the best Hindi poetry, and in the *Kabī-bachan-Sudhā* ("ambrosia of the words of poets") and the magazine called *Hariśchandra-rikā* a quantity of old texts, with much added matter. He also wrote a volume of biographies of famous men, European and Indian, and many critical studies, historical and literary. In history especially he cleared up many problems, and traced the lines for further investigation. In his *Kashmīr Kusum*, or history of Kashmir, a list is given of about a hundred works by him. He was also the real founder of the modern Hindi drama; he wrote plays himself, and inspired others. Rājā Siva Prāsād (1823-1895) served for many years in the educational department, and published a number of works intended for use in schools, which have greatly contributed to the formation of a sound vernacular form of Hindi, not excessively Sanskritized, and not rejecting current Persian forms. The society at Benares called the *Nāgarī Prachārīnī Sabhā* ("Society for promoting the use of the Nāgarī character") has, since the death of Hariśchandra, been active in procuring the publication of works in Hindi, and has issued many useful books, besides conducting a systematic search for old MSS.

BIBLIOGRAPHY.—The best account in English of Hindi literature is Dr G. A. Grierson's *Modern Vernacular Literatures of Hindostān*, issued by the Asiatic Society of Bengal in 1889; the dates in this work, which is founded on indigenous compilations, have, however, in many cases to be received with caution. Before it appeared, Garcin de Tassy's *Histoire de la littérature Hindouste et Hindoustanie*, and his annual summaries of the progress made from 1850 to 1877, were our chief authority, and may still be consulted with advantage. For the religious literature of the Vaishnava sects, Professor H. H. Wilson's *Essay on the Religious Sects of the Hindus* (vol. i. of his collected works) has not yet been superseded.

For Urdu poets, Professor Āzād's *Āb-i Hayāt* (in Urdu) is the most trustworthy record. For the new school of Urdu literature reference may be made to a series of lectures (in English) by Shaikh 'Abdul-Qādir of Lahore, printed in 1898. The catalogues by Professor Blumhardt of Hindustānī and Hindi books in the libraries of the British Museum and the India Office will give a good idea of the volume of the recent productions of the press in those languages. (C. J. L.)

HINDU CHRONOLOGY. The subject of Hindu chronology divides naturally into three parts: the calendar, the eras, and other reckonings.

I. THE CALENDAR

The Hindus have had from very ancient times the system of lunisolar cycles, made by the combination of solar years, regulated by the course of the sun, and lunar years, regulated by the course of the moon, but treated in such a manner as to keep the beginning of the lunar year near the beginning of the solar year. The exact manner in which they arranged the details of their earliest calendar is still a subject of research. We deal here with their calendar as it now stands, in a form which was developed from about A.D. 400 under the influence of the Greek astronomy which had been introduced into India at no very long time previously.

The Hindu calendar, then, is determined by years of two kinds, solar and lunar. For civil purposes, solar years are used in Bengal, including Orissa, and in the Tamil and Malayālam districts of Madras, and lunar years throughout the rest of India. But the lunar year regulates everywhere the general religious rites and festivals, and the details of private and domestic life, such as the selection of auspicious occasions for marriages and for starting on journeys, the choice of lucky moments for shaving, and so on. Consequently, the details of the lunar year are shown even in the almanacs which follow the solar year. On the other hand, certain details of the solar year, such as the course of the sun through the signs and other divisions of the zodiac, are shown in the almanacs which follow the lunar year. We will treat the solar year first, because it governs the lunisolar system, and the explanation of it will greatly simplify the process of explaining the lunar calendar.

The civil solar year is determined by the astronomical solar year. The latter professes to begin at the vernal equinox, but the actual position is as follows. In our Western astronomical astronomy the signs of the zodiac have, in consequence of the precession of the equinoxes, drawn away to a large extent from the constellations from which they derived their names; with the result that the sun now comes to the vernal equinox, at the first point of the sign Aries, not in the constellation Aries, but at a point in Pisces, about 28 degrees before the beginning of Aries. The Hindus, however, have disregarded precession in connexion with their calendar from the time (A.D. 499, 522, or 527, according to different schools) when, by their system, the signs coincided with the constellations; and their sign Aries, called *Mēsha* by them, is still their constellation Aries, beginning, according to them, at or near the star ζ Piscium. Their astronomical solar year is, in fact, not the tropical year, in the course of which the sun really passes from one vernal equinox to the next, but a sidereal year, the period during which the earth makes one revolution in its orbit round the sun with reference to the first point of *Mēsha*; its beginning is the moment of the *Mēsha-saṅkrānti*, the entrance of the sun into the sidereal sign *Mēsha*, instead of the tropical sign Aries; and it begins, not with the true equinox, but with an artificial or nominal equinox.

The length of this sidereal solar year was determined in the following manner. The astronomer selected what the Greeks termed an *exeligmos*, the Romans an *annus magnus* or *mundanus*, a period in the course of which a given order of things is completed by the sun, moon, and planets returning to a state of conjunction from which they have started. The usual Hindu *exeligmos* has been the Great Age of 4,320,000 sidereal solar years, the aggregate of the Kṛita or golden age, the Trētā or silver age, the Dvāpara or brazen age, and the Kali or iron age, in which we now are; but it has sometimes been the Kalpa or aeon, consisting according to one view of 1000, according to another view of 1008, Great Ages. He then laid down the number of revolutions, in the period of his *exeligmos*, of the *nakshatras*, certain stars and groups of stars which will be noticed more definitely in our account of the lunar year; that is, the number of rotations of the earth on its axis, or, in other words, the number of sidereal days. A deduction of the number of the years from the number of the sidereal days gave, as remainder, the number of civil days in the *exeligmos*. And, this remainder being divided by the number of the years, the quotient gave the length of the sidereal solar year: refinements, suggested by experience, inference, or extraneous information, were made by increasing or decreasing the number of sidereal days assigned to the *exeligmos*. The Hindus now recognize three standard sidereal solar years determined in that manner. (1) A year of 365 days 6 hrs. 12 min. 30 sec. according to the *Āryabhaṭṭiya*, otherwise called the *First Ārya-Siddhānta*, which was written by the astronomer *Āryabhaṭa* (b. A.D. 476): this year is used in the Tamil and Malayālam districts, and, we may add, in Ceylon. (2) A year of 365 days 6 hrs. 12 min. 30-915 sec. according to the *Rājamṛigāka*, a treatise based on the *Brahma-Siddhānta* of Brahmagupta (b. A.D. 598) and attributed to king Bhōja, of which the epoch, the point of time used in it for calculations, falls in A.D. 1042: this year is used in parts of Gujārāt (Bombay) and in Rājputānā and other western parts of Northern India. (3) A year of 365 days 6 hrs. 12 min. 36-56 sec. according to the present *Sūrya-Siddhānta*, a work of unknown authorship which dates from probably about A.D. 1000: this year is used in almost all the other parts of India. It may be remarked that, according to modern science, the true mean sidereal solar year measures 365 days 6 hrs. 9 min. 9-6 sec., and the mean tropical year measures 365 days 5 hrs. 48 min. 46-054440 sec.

The result of the use of this sidereal solar year is that the beginning of the Hindu astronomical solar year, and with it the civil solar year and the lunar year and the nominal incidence of the seasons, has always been, and still is, travelling slowly forward in our calendar year by an amount which varies accord-

ing to the particular authority.¹ For instance, *Āryabhaṭa's* year exceeds the Julian year by 12 min. 30 sec. This amounts to exactly one day in 115½ years, and five days in 576 years. Thus, if we take the longer period and confine ourselves to a time when the Julian calendar (old style) was in use, according to *Āryabhaṭa* the *Mēsha-saṅkrānti* began to occur in A.D. 603 on 20th March, and in A.D. 1179 on 25th March. The intermediate advances arrange themselves into four steps of one day each in 116 years, followed by one step of one day in 112 years; thus, the *Mēsha-saṅkrānti* began to occur on 21st March in A.D. 719, on 22nd March in A.D. 835, on 23rd March in A.D. 951, and on 24th March in A.D. 1067 (whence 112 years take us to 25th March in A.D. 1179). It is now occurring sometimes on 11th April, sometimes on the 12th; having first come to the 12th in A.D. 1871.

The civil solar year exists in more varieties than one. The principal variety, conveniently called the *Mēshādi year*, i.e. "the year beginning at the *Mēsha-saṅkrānti*," is the only one that we need notice at this point. The beginning of it is determined directly by the astronomical solar year; and for religious purposes it begins, with that year, at the moment of the *Mēsha-saṅkrānti*. Its first civil day, however, may be either the day on which the *saṅkrānti* occurs, or the next day, or even the day after that: this is determined partly by the time of day or night at which the *saṅkrānti* occurs, which, moreover, of course varies in accordance with the locality as well as the particular authority that is followed; partly by differing details of practice in different parts of the country. In these circumstances an exact equivalent of the *Mēshādi* civil solar year cannot be stated; but it may be taken as now beginning on or closely about the 12th of April.

The solar year is divided into twelve months, in accordance with the successive *saṅkrāntis* or entrances of the sun into the (sidereal) signs of the zodiac, which, as with us, are twelve in number. The names of the signs in Sanskrit are as follows: *Mēsha*, the ram (Aries); *Vṛishabha*, the bull (Taurus); *Mithuna*, the pair, the twins (Gemini); *Karka*, *Karkāta*, *Karkātaka*, the crab (Cancer); *Sīṅha*, the lion (Leo); *Kanyā*, the maiden (Virgo); *Tulā*, the scales (Libra); *Vṛiścika*, the scorpion (Scorpio); *Dhanus*, the bow (Sagittarius); *Makara*, the sea-monster (Capricornus); *Kumbha*, the water-pot (Aquarius); and *Mīna*, the fishes (Pisces). The solar months are known in some parts by the names of the signs or by corrupted forms of them; and these are the best names for them for general use, because they lead to no confusion. But they have elsewhere another set of names, preserving the connexion of them with the lunar months: the Sanskrit forms of these names are *Chaitra*, *Vaiśākha*, *Jyaiścīna*, *Āshāḍha*, *Srāvaṇa*, *Bhādrapada*, *Āśvina* or *Āśvayujya*, *Kārttika*, *Mārgaśīra* or *Mārgaśīra* (also known as *Agrahāyana*), *Pauṣa*, *Māgha*, and *Phālguna*: in some localities these names are used in corrupted forms, and in others vernacular names are substituted for some of them; and, while in some parts the name *Chaitra* is attached to the month *Mēsha*, in other parts it is attached to the month *Mīna*, and so on throughout the series in each case. The astronomical solar month runs from the moment of one *saṅkrānti* of the sun to the moment of the next *saṅkrānti*; and, as the signs of the Hindu zodiac are all of equal length, 30 degrees, as with us, while the speed of the sun (the motion of the earth in its orbit round the sun) varies according to the time of the year, the length of the month is variable: the shortest month is *Dhanus*; the

¹ The disregard of precession, and the consequent travelling forward of the year through the natural seasons, is, of course, a serious defect in the Hindu calendar, the principles of which are otherwise good. Accordingly, an attempt was made by a small band of reformers to rectify this state of things by introducing a precessional calendar, taking as the first lunar month the synodic lunation in which the sun enters the tropical Aries, instead of the sidereal *Mēsha*; and the publication was started, in or about 1886, of the *Sayana-Panchāng* or "Precessional Almanac."

Further, the Hindu sidereal solar year is in excess of the true mean sidereal year by (if we use *Āryabhaṭa's* value) 3 min. 20-4 sec. If we take this, for convenience, at 3 min. 20 sec., the excess amounts to exactly one day in 432 years. And so even the sidereal *Mēsha-saṅkrānti* is now found to occur three or four days later than the day on which it should occur. Accordingly, another reformer had begun, in or about 1865, to publish the *Navān* aṭhāvāḥ *Paṭwardhāni Pañchāng*, the "New or Paṭwardhāni Almanac," in which he determined the details of the year according to the proper *Mēsha-saṅkrānti*.

longest is Mithuna. The civil solar month begins with its first civil day, which is determined, in different localities, in the same manner with the first civil day of the Mēshādi year, as indicated above. The civil month is of variable length; partly for that reason, partly because of the variation in the length of the astronomical month. No exact equivalents of the civil months, therefore, can be stated; but, speaking approximately, we may say that, while the month Mēsha now begins on or closely about 12th April, the beginning of a subsequent month may come as late as the 16th day of the English month in which it falls.

The solar year is also divided into six seasons, the Sanskrit names of which are Vasanta, spring; Grishma, the hot weather; Varshā, the rainy season; Sarad, autumn; Hēmana, the cold weather; and Śitāra, the dewy season. Vasanta begins at the Mīna-saṁkrānti; the other seasons begin at each successive second saṁkrānti from that. Originally, this scheme was laid out with reference to the true course of the sun, and the starting-point of it was the real winter solstice, with Śitāra, as the first season, beginning then; now, owing partly to the disregard of precession, partly to our introduction of New Style, each season comes about three weeks too late; Vasanta begins on or about 12th March, instead of 19th or 20th February, and so on with the rest. It may be added that in early times the year was also divided into three or four, and even into five or seven, seasons; and there appears to have been also a practice of reckoning the seasons according to the lunar months, which, however, would only give a very varying arrangement, in addition to neglecting the point that the seasons are naturally determined by the course of the sun, not of the moon. But there is now recognized only the division into six seasons, determined as stated above.

The solar year is also divided into two parts called Uttarāyana, the period during which the sun is moving to the north, and Dakṣiṇāyana, the period during which it is moving to the south. The Uttarāyana begins at the nominal winter solstice, as marked by the Māksara-saṁkrānti; and the day on which this solstice occurs, usually 12th January at present, is still a special occasion of festivity and rejoicing; the Dakṣiṇāyana begins at the nominal summer solstice, as marked by the Karika-saṁkrānti. It may be added here that, while the Hindus disregard precession in the actual computation of their years and the regulation of their calendar, they pay attention to it in certain other respects, and notably as regards the solstices: the precessional solstices are looked upon as auspicious occasions, as well as the non-precessional solstices, and are customarily shown in the almanacs; and some of the almanacs show also the other precessional saṁkrāntis of the sun.

The civil days of the solar month begin at sunrise. They are numbered 1, 2, 3, &c., in unbroken succession to the end of the month. And, the length of the month being variable for the reasons stated above, the number of the civil days may range from twenty-nine to thirty-two.

The civil days are named after the weekdays, of which the usual appellations (there are various synonyms in each case, and some of the names are used in corrupted forms) are in Sanskrit: Adityavāra or Ravivāra, the day of the sun, sometimes called Ādivāra, the beginning-day (Sunday); Sōmavāra, the day of the moon (Monday); Maṅgalavāra, the day of Mars (Tuesday); Budhavāra, the day of Mercury (Wednesday); Brihaspativāra or Guruvāra, the day of Jupiter (Thursday); Sukravāra, the day of Venus (Friday); and Śanivāra, the day of Saturn (Saturday). It may be mentioned, as a matter of archaeological interest, that, while some of the astronomical books perhaps postulate an earlier knowledge of the "lords of the days," and other writings indicate a still earlier use of the period of seven days, the first proved instance of the use of the name of a weekday is of the year A. D. 484, and is furnished by an inscription in the Saugor district, Central India.

The divisions of the civil day, as far as we need note them, are 60 vipalas = 1 pala = 24 seconds; 60 palas = 1 ghāṭikā = 24 minutes; 60 ghāṭikās = 24 hours = 1 day. There is also the *śukhānta* = 2 ghāṭikās = 48 minutes: this is the nearest approach to the "hour." The comparative value of these measures of time may perhaps be best illustrated thus: 2 1/2 *śukhāntas* = 2 hours; 2 1/2 *ghāṭikās* = 1 hour; 2 1/2 *palas* = 1 minute; 2 1/2 *vipalas* = 1 second.

As their civil day begins at sunrise, the Hindus naturally count all their times, in *ghāṭikās* and *palas*, from that moment. But the moment is a varying one, though not in India to anything like the extent to which it is so in European latitudes; and under the British Government the Hindus have recognized the advantage, and in fact the necessity, especially in connexion with their lunar calendar, of having a convenient means of referring their own times to the time which prevails officially. Consequently, some of the almanacs have adopted the European practice of showing the time of sunrise, in hours and minutes, from midnight; and some of them add the time of sunset from noon.

The lunar year consists primarily of twelve lunations or lunar months, of which the present Sanskrit names, generally

used in more or less corrupted forms, are Chaitra, Vaiśākha, &c., to Phālguna, as given above in connexion with the solar months. It is of two principal varieties, according as it begins with a certain day in the month Chaitra, or with the corresponding day in Kārttika: the former variety is conveniently known as the Chaitrādi year; the latter as the Kārttikādi year. For religious purposes the lunar year begins with its first lunar day; for civil purposes it begins with its first civil day, the relation of which to the lunar day will be explained below. Owing to the manner in which, as we shall explain, the beginning of the lunar year is always shifting backwards and forwards, it is not practicable to lay down any close equivalents for comparison; but an indication may be given as follows. The first civil day of the Chaitrādi year is the day after the new-moon conjunction which occurs next after the entrance of the sun into Mīna, and it now falls from about 13th March to about 12th April: the first civil day of the Kārttikādi year is the first day after the new-moon conjunction which occurs next after the entrance of the sun into Tūlā, and it now falls from about 17th October to about 15th November.

The present names of the lunar months, indicated above, were derived from the *nakṣatras*, which are certain conspicuous stars and groups of stars lying more or less along the neighbourhood of the ecliptic. The *nakṣatras* are regarded sometimes as twenty-seven in number, sometimes as twenty-eight, and are grouped in twelve sets of two or three each, beginning, according to the earlier arrangement of the list, with the pair Kṛttikā and Rohiṇi, and including in the sixth place Chitrā and Svātī, and ending with the tripler Rēvatī, Āsvini and Bharoḍī. They are sometimes styled lunar mansions, and are sometimes spoken of as the signs of the lunar zodiac; and it is, no doubt, chiefly in connexion with the moon that they are now taken into consideration. But they mark divisions of the ecliptic: according to one system, twenty-seven divisions, each of 13 degrees 20 minutes; according to two other systems, twenty-seven or twenty-eight unequal divisions, which we need not explain here. The almanacs show the course of the sun through them, as well as the course of the moon; and the course of the sun was marked by them only, before the time when the Hindus began to use the twelve signs of the solar zodiac. So there is nothing exclusively lunar about them. The present names of the lunar months were derived from the *nakṣatras* in the following manner: the full-moon which occurred when the moon was in conjunction with Chitrā (the star α Virginis) was named Chaitrī, and the lunar month, which contained the Chaitrī full-moon, was named Chaitra; and so on with the others. The present names have superseded another set of names which were at one time in use concurrently with these; these other names are Madhu (= Chaitra), Mādhava, Sukra, Suchi, Nabhas, Nabhasya, Isha, Urjā (= Kārttika), Sahas, Sahasya, Tapas, and Tapasya (= Phālguna) = having marked originally solar seasons of the solar year, rather than lunar months of the lunar year.

A lunar month may be regarded as ending either with the new-moon, which is called *amāvāsya*, or with the full-moon, which is called *pūrṇamāsī*, *pūrṇimā*: a month of the former kind is termed *amānta*, "ending with the new-moon," or *śuklādī*, "beginning with the bright fortnight;" a month of the latter kind is termed *pūrṇimānta*, "ending with the full-moon," or *kṛṣṇādī*, "beginning with the dark fortnight." For all purposes of the calendar, the *amānta* month is used in Northern India, and the *pūrṇimānta* month in Southern India. But only the *amānta* month, the period of the synodic revolution of the moon, is recognized in Hindu astronomy, and for the purpose of naming the lunations and adjusting the lunar to the solar year by the intercalation and suppression of lunar months; and the rule is that the lunar Chaitra is the *amānta* or synodic month at the first moment of which the sun is in the sign Mīna, and in the course of which the sun enters Mēsha: the other months follow in the same way; and the lunar Kārttika is the *amānta* month at the first moment of which the sun is in Tūlā, and in the course of which the sun enters Vṛśchika. The connexion between the lunar and the solar months is maintained by the point that the name Chaitra is applied according to one practice to the solar Mīna, in which the lunar Chaitra begins, and according to another practice to the solar Mēsha, in which the lunar Chaitra ends. Like the lunar year, the lunar month begins for religious purposes with its first lunar day, and for civil purposes with its first civil day.

One mean lunar year of twelve lunations measures very nearly 354 days 8 hrs. 48 min. 34 sec.; and one Hindu solar year measures 365 days 6 hrs. 12 min. 30 sec. according to Āryabhaṭa, or slightly more according to the other two authorities. Consequently, the beginning of a lunar year pure and simple would be always travelling backwards through the solar year, by about eleven days on

each occasion, and would in course of time recede entirely through the solar year, as it does in the Mahomedan calendar. The Hindus prevent that in the following manner. The length of the Hindu astronomical solar month, measured by the *samkrānti* of the sun, its successive entrances into the signs of the zodiac, ranges, in accordance with periodical variations in the speed of the sun, from about 29 days 7 hrs. 38 min. up to about 31 days 15 hrs. 28 min. The length of the *amānta* or synodic lunar month ranges, in accordance with periodical variations in the speed of the moon and the sun, from about 29 days 19 hrs. 30 min. down to about 29 days 7 hrs. 20 min. Consequently, it happens from time to time that there are two new-moon conjunctions, so that two lunations begin, in one astronomical solar month, between two *samkrāntis* of the sun, while the sun is in one and the same sign of the zodiac, and there is no *samkrānti* in the lunation ending with the second new-moon: when this is the case, there are two lunations to which the same name is applicable, and so there is an additional or intercalated month, in the sense that a name is repeated; thus, when two new-moons occur while the sun is in Mēsha, the lunation ending with the first of them, during which the sun has entered Mēsha, is Chaitra; the next lunation, in which there is no *samkrānti*, is Vaiśākha, because it begins when the sun is in Mēsha; and the next lunation after that is again Vaiśākha, for the same reason, and also because the sun enters Vṛṣabha in the course of it; and these circumstances, the first of the two Vaiśākhas is called Adhika-Vaiśākha, "the additional or intercalated Vaiśākha," and the second is called simply Vaiśākha, or sometimes Nija-Vaiśākha, "the natural Vaiśākha." On the other hand, it occasionally happens, in an autumn or winter month, that there are two *samkrāntis* of the sun in one and the same *amānta* or synodic lunar month, between two new-moon conjunctions, so that no lunation begins between two *samkrāntis*: when this is the case, there is one suppressed month, in the sense that a name is omitted; thus, if the sun enters both Dhanus and Makara during one synodic lunation, that lunation is Mārgaśira, because the sun was in Vṛṣchika at the first moment of it and enters Dhanus in the course of it; the next lunation is Māgha, because the sun is in Makara by the time when it begins and will enter Kumbha in the course of it; and the name Pausa, between Mārgaśira and Māgha, is omitted. When a month is thus suppressed, there is always one intercalated month, and sometimes two, in the same Chaitrādi lunar year, so that the lunar year never contains less than twelve months, and from time to time consists of thirteen months. There are normally seven intercalated months, rising to eight when a month is suppressed, in 19 solar years, which equal very nearly 235 lunations; and there is never less than one year without an intercalated month between two years with intercalated months, except when there is only one such month in a year in which a month is suppressed; then there is always an intercalated month in the next year also. The suppression of a month takes place at intervals of 19 years and upwards, regarding which no definite statement can conveniently be made here.

It may be added that an intercalated Chaitra or Kārttika takes the place of the ordinary month as the first month of the year; an intercalated month is not rejected for that purpose, though it is tabooed from the religious and auspicious points of view.

The manner in which this arrangement of intercalated and suppressed months works out, so as to prevent the beginning of the Chaitrādi lunar year departing far from the beginning of the Mēshādi

¹ It might also be called Pausa, because the sun enters Makara in the course of it; and it may be observed that, in accordance with a second rule which formerly existed, it would have been named Pausa because it ends while the sun is in Makara, and the omitted name would have been Mārgaśira. But the more important condition of the present rule, that Pausa begins while the sun is in Dhanus, is not satisfied.

² The well-known Metonic cycle, whence we have by rearrangement our system of Golden Numbers, naturally suggests itself; and we have been told sometimes that that cycle was adopted by the Hindus, and elsewhere that the intercalation of a month by them generally takes place in the years 3, 5, 8, 11, 14, 16, and 19 of each cycle, differing only in respect of the 14th year, instead of the 13th, from the arrangement which is said to have been fixed by Meton. As regards the first point, however, there is no evidence that a special period of 19 years was ever actually used by the Hindus during the period with which we are dealing, beyond the extent to which it figures as a component of the number of years, $19 \times 150 = 2850$, forming the lunisolar cycle of an early work entitled *Rāmaka-Siddhānta*; and, as was recognized by Kalippos not long after the time of Meton himself, the Metonic cycle has not, for any length of time, the closeness of results which has been sometimes supposed to attach to it; it requires to be readjusted periodically. As regards the second point, the precise years of the intercalated months depend upon, and vary with, the year that we may select as the apparent first year of a set of 19 years, and it is not easy to arrange the Hindu years in sets answering to a direct continuation of the Metonic cycle.

solar year, may be illustrated as follows. In A.D. 1815 the Mēsha-samkrānti occurred on 11th April; and the first civil day of the Chaitrādi year was 10th April. In A.D. 1816 and 1817 the first civil day of the Chaitrādi year fell back to 29th March and 19th March. In A.D. 1817, however, there was an intercalated month, Śrāvāṇa; with the result that in A.D. 1818 the first civil day of the Chaitrādi year advanced to 6th April. And, after various shiftings of the same kind—including in A.D. 1822 an intercalation of Āśvina and a suppression of Pausa; followed in A.D. 1823, when the first civil day of the Chaitrādi year had fallen back to 13th March, by an intercalation of Chaitra itself—in A.D. 1834, when the Mēsha-samkrānti occurred again on 11th April, the first civil day of the Chaitrādi year was again 10th April.

The lunar month is divided into two fortnights (*pakṣa*), called bright and dark, or, in Indian terms, *śukla* or *śuddha*, *śuddi*, *śuddi*, and *krishna* or *bahula*, *śuddi*, *śuddi*; the bright fortnight, *śukla-pakṣa*, is the period of the waxing moon, ending at the full-moon; the dark fortnight, *krishna-pakṣa*, is the period of the waning moon, ending at the new-moon. In the *amānta* or *śuklādi* month, the bright fortnight precedes the dark; in the *pūrṇimānta* or *krishṇādi* month, the dark fortnight comes first; and the result is that, whereas, for instance, the bright fortnight of Chaitra is the same period of time throughout India, the preceding dark fortnight is known in Northern India as the dark fortnight of Chaitra, but in Southern India as the dark fortnight of Phālguna. This, however, does not affect the period covered by the lunar year; the Chaitrādi and Kārttikādi years begin everywhere with the bright fortnight of Chaitra and Kārttika respectively; simply, by the *amānta* system the dark fortnights of Chaitra and Kārttika are the second fortnights, and by the *pūrṇimānta* system they are the last fortnights, of the years. Like the month, the fortnight begins for religious purposes with its first lunar day, and for civil purposes with its first civil day.

The lunar fortnights are divided each into fifteen *tithis* or lunar days.³ The *tithi* is the time in which the moon increases her distance from the sun round the circle by twelve degrees; and the almanacs show each *tithi* by its ending-time; that is, by the moment, expressed in *ghaṭikas* and *palas*, after sunrise, at which the moon completes that distance. In accordance with that, the *tithi* is usually used and cited with the weekday on which it ends; but there are special rules regarding certain rites, festivals, &c., which sometimes require the *tithi* to be used and cited with the weekday on which it begins or is current at a particular time. The first *tithi* of each fortnight begins immediately after the moment of new-moon and full-moon respectively; the last *tithi* ends at the moment of full-moon and new-moon. The *tithis* are primarily denoted by the numbers 1, 2, 3, &c., for each fortnight; but, while the full-moon *tithi* is always numbered 15, the new-moon *tithi* is generally numbered 30, even where the *pūrṇimānta* month is used. The *tithis* may be cited either by their figures or by the Sanskrit ordinal words *prathamā*, "first," *dvitīyā*, "second," &c., or corruptions of them. But usually the first *tithi* of either fortnight is cited by the term *pratipadā*, *pratipadā*, and the new-moon and full-moon *tithis* are cited by the terms *amāvāsīyā* and *pūrṇimā*; or, here, again, corruptions of the Sanskrit terms are used. And special names are sometimes prefixed to the numbers of the *tithis*, according to the rites, festivals, &c., prescribed for them, or events or merits assigned to them; for instance, Vaiśākha *śukla* 3 is Akahaya or Akahaya-tritīyā, the third *tithi* which ensures permanence to *śuci* performed on it; Bhādrapada *śukla* 4 is Gaṇeśa-chaturthī, the fourth *tithi* dedicated to the worship of the god Gaṇeśa, Gaṇapati, and the *amānta* Bhādrapada or *pūrṇimānta* Āśvina *krishna* 13 is Kaliyugādi-trayodasī, as being regarded (for some reason which is not apparent) as the anniversary of the beginning of the Kaliyuga, the present Age. The first *tithi* of the year is styled *Saivaitara-pratipadā*, which term answers closely to our "New Year's Day."

The civil days of the lunar month begin, like those of the solar month, at sunrise, and bear in the same way the names of the weekdays. But they are numbered in a different manner; the fortnight by fortnight and according to the *tithis*. The general rule is that the civil day takes the number of the *tithi* which is current at its sunrise. And the results are as follows. As the motions of the sun and the moon vary periodically, a *tithi* is of variable length, ranging, according to the Hindu calculations, from 21 hrs. 34 min. 24 sec. to 26 hrs. 6 min. 24 sec.; it may, therefore, be either shorter or longer than a civil day, the duration of which is practically 24 hours (one minute, roughly, more or less, according to the time of the year). A *tithi* may end at any moment during the civil day; and ordinarily it ends on the civil day after that on which it begins, and covers only one sunrise and gives its number to the day on which it ends. It may, however, begin on

³ It is customary to render the term *tithi* by "lunar day;" it is, in fact, explained as such in Sanskrit works; and, as the *tithis* do mark the age of the moon by periods approximating to 24 hours, they are, in a sense, lunar days. But the *tithi* must not be confused with the lunar day of western astronomy, which is the interval, with a mean duration of about 24 hrs. 54 min., between two successive meridian passages of the moon.

one civil day and end on the next but one, and so cover two sunrises; and it is then treated as a repeated *tithi*, in the sense that its number is repeated; for instance, if the seventh *tithi* so begins and ends, the civil day on which it begins is numbered 6, from the *tithi* which is current at the sunrise of that day and ends on it; the day covered entirely by the seventh *tithi* is numbered 7, because that *tithi* is current at its sunrise; the next day, at the sunrise of which the seventh *tithi* is still current and during which it ends, is again numbered 7; and the number 8 falls to the next day after that, when the eighth *tithi* is current at sunrise.¹ On the other hand, a *tithi* may begin and end during one and the same civil day, so as not to touch a sunrise at all: in this case, it exists for any practical purposes for which it may be wanted (it is, however, to be avoided if possible, as being an unlucky occasion), but it is suppressed or expunged from the numbering of the civil day, in the sense that its number is omitted; for instance, if the seventh *tithi* begins and ends during one civil day, that day is numbered 6 from, as before, the *tithi* which is current at its sunrise and ends when the seventh *tithi* begins; the next day is numbered 8, because the eighth *tithi* is current at its sunrise; and there is, in this case, no civil day bearing the number seven. In consequence of this method of numbering, it sometimes happens, as the result of the suppression of a *tithi*, that the day of a full-moon is numbered 14 instead of 15; that the day of a new-moon is numbered 14 instead of 30; and that the first day of a fortnight, and even the first day of a lunar year, is numbered 2 instead of 1.

There are, on an average, thirteen suppressed *tithis* and seven repeated *tithis* in twelve lunar months; and so the lunar year averages 354 days, rising to about 384 when a month is intercalated. It occasionally happens that there are two suppressions of *tithis* in one and the same fortnight; and the almanacs show such a case in the bright fortnight of Jyaishtha, A.D. 1878: but this occurs only after very long intervals.

The *tithi* is divided into two *karanas*; each *karana* being the time in which the moon increases her distance from the sun by six degrees. But this is a detail of astrological rather than chronological interest. So, also, are two other details *The Karana*, to which a prominent place is given in the lunar calendars; to *yoga*, or time in which the joint motion in longitude, the sum of the motions of the sun and the moon, is increased by 13 degrees 20 minutes; and the *nakshatra*, the position of the moon as referred to the ecliptic by means of the stars and groups of stars which have been mentioned above under the lunar month.

In the Indian calendar everything depends upon exact times, which differ, of course, on every different meridian; and (to cite what is perhaps the most frequent and generally important occurrence) suppression and repetition may affect one *tithi* and civil day in one locality, and another *tithi* and civil day in another locality not very far distant. Consequently, neither for the lunar nor for the solar calendar is there any almanac which is applicable to even the whole area in which any particular length of the astronomical solar year prevails; much less, for the whole of India. Different almanacs are prepared and published for places of leading importance; details for minor places, when wanted, have to be worked out by the local astrologer, the modern representative of an ancient official known as *Sāhvatsara*, the "clerk of the year."

II. ERAS

As far as the available evidence goes (and we have no reason to expect to discover anything opposed to it), any use of eras, in the sense of continuous reckonings which originated in historical occurrences or astronomical epochs and were employed for official and other public chronological purposes, did not prevail in India before the 1st century B.C. Prior to that time, there existed, indeed, in connexion with the sacrificial calendar, a five-years lunisolar cycle, and possibly some extended cycles of the same nature; and there was in Buddhist circles a record of the years elapsed since the death of Buddha, which we shall mention again further on. But, as is gathered from books and is well illustrated by the edicts of *Aśoka* (reigned 264-277 B.C.) and the inscriptions of other rulers, the years of the reign of each successive king were found sufficient for the public dating of proclamations and the record of events. There is no known case in which any Indian king, of really ancient times, deliberately applied himself to the foundation of an era: and we have no reason for thinking that such a thing was ever done, or that any Hindu reckoning at all owes its existence to a recognition of historical requirements. The eras which came into existence

¹ We illustrate the ordinary occurrences. But there are others. Thus, a repeated *tithi* may occasionally be followed by a suppressed one: in this case the numbering of the civil days would be 6, 7, 7, 9, &c., instead of 6, 7, 7, 8, 9, &c. Or it may occasionally be preceded by a suppressed one: in this case the numbering would be 5, 7, 7, 8, &c., instead of 5, 6, 7, 7, 8, &c.

from the 1st century B.C. onwards mostly had their origin in the fortuitous extension of regnal reckonings. The usual course has been that, under the influence of filial piety, pride in ancestry, loyalty to a paramount sovereign, or some other such motive, the successor of some king continued the regnal reckoning of his predecessor, who was not necessarily the first king in the dynasty, and perhaps did not even reign for any long time, instead of starting a new reckoning, beginning again with the year 1, according to the years of his own reign. Having thus run for two reigns, the reckoning was sufficiently well established to continue in the same form, and to eventually develop into a generally accepted local era, which might or might not be taken over by subsequent dynasties ruling afterwards over the same territory. In these circumstances, we find the establisher of any particular era in that king who first continued his predecessor's regnal reckoning, instead of replacing it by his own; but we regard as the founder of the era that king whose regnal reckoning was so continued. We may add here that it was only in advanced stages that any of the Hindu eras assumed specific names: during the earlier period of each of them, the years were simply cited by the term *sāhvatsara* or *vārsha*, "the year (bearing such-and-such a number)," or by the abbreviations *śamvat* and *sam*, without any appellative designation.

The Hindus have had two religious reckonings, which it will be convenient to notice first. Certain statements in the Ceylonese chronicles, the *Dīpaṅśu* and *Mahāvamsa*, The *Buddhist and Jain religions reckonings*, endorsed by an entry in a record of *Aśoka*, show that in the 3rd century B.C. there existed among the Buddhists a record of the time elapsed since the death of Buddha in 483 B.C., from which it was known that *Aśoka* was at the sovereignty 278 years after the death. The reckoning, however, was confined to esoteric Buddhist circles, and did not commend itself for any public use; and the only known inscriptional use of it, which also furnishes the latest known date recorded in it, is found in the Last Edict of *Aśoka*, which presents his dying speech delivered in 226 B.C., 256 years after the death of Buddha. In Ceylon, where, also, the original reckoning was not maintained, there was devised in the 12th century A.D. a reckoning styled *Buddhavarsha*, "the years of Buddha," which still exists, and which purports to run from the death of Buddha, but has set up an erroneous date for that event in 544 B.C. This later reckoning spread from Ceylon to Burma and Siam, where, also, it is still used. It did not obtain any general recognition in India, because, when it was devised, Buddhism had practically died out there, except at *Bōdh-Gayā*. But, as there seems to have been constant intercourse between *Bōdh-Gayā* and Ceylon as well as other foreign Buddhist countries, we should not be surprised to find an occasional instance of its use at *Bōdh-Gayā*: and it is believed that one such instance, belonging to A.D. 1270, has been obtained.

The Jains have had, and still maintain, a reckoning from the death of the founder of their faith, *Vīra*, *Mahāvīra*, *Vardhamāna*, which event is placed by them in 538 B.C. This reckoning figures largely in the Jain books, which put forward dates in it for very early times. But the earliest known synchronous date in it—by which we mean a date given by a writer who recorded the year in which he himself was writing—is one of the year 080, or, according to a different view mentioned in the passage itself, of the year 993. This reckoning, again, did not commend itself for any official or other public use. And the only known inscriptional instances of the use of it are modern ones, of the 19th century. While it is certain that the Jain reckoning, as it exists, has its initial point in 538 B.C. it has not yet been determined whether that is actually the year in which *Vīra* died. All that can be said on this point is that the date is not inconsistent with certain statements in Buddhist books, which mention, by a *Prākṛit* name of which the Sanskrit form is *Nirgrantha-Jātāputra*, a contemporary of Buddha, in whom there is recognized the original of the Jain *Vīra*, *Mahāvīra*, or *Vardhamāna*, and who, the same books say, died while Buddha was still alive. But there are some indications that *Nirgrantha-Jātāputra* may have died only a short time before Buddha himself; and the event may

easily have been set back to 538 B.C. in circumstances, attending a determination of the reckoning long after the occurrence, analogous to those in which the Ceylonese Buddhavarsha set up the erroneous date of 544 B.C. for the death of Buddha.

In the class of eras of royal origin, brought into existence in the manner indicated above, the Hindus have had various reckonings which have now mostly fallen into disuse. We may mention them, without giving them the detailed treatment which the more important of the still existing reckonings demand.

Bygone Eras of royal origin.

The Kalachuri or Chédi era, commencing in A.D. 248 or 249, is known best from inscriptional records, bearing dates which range from the 10th to the 13th century A.D., of the Kalachuri kings of the Chédi country in Central India; and it is from them that it derived the name under which it passes. In earlier times, however, we find this era well established, without any appellation, in Western India, in Gujārat and the Thāṅga district of Bombay, where it was used by kings and princes of the Chalukya, Gurjara, Sēndraka, Kātachuri and Traikūṭaka families. It is traced back there to A.D. 457, at which time there was reigning a Traikūṭaka king named Dahrāsēna. Beyond that point, we have at present no certain knowledge about it. But it seems probable that the founder of it may be recognized in an Abhira king Išvarāsēna, or else in his father Sivadatta, who was reigning at Nāsik in or closely about A.D. 248-49.

The Gupta era, commencing in A.D. 320, was founded by Chandragupta I., the first paramount king in the great Gupta dynasty of Northern India. When the Guptas passed away, their reckoning was taken over by the Maitraka kings of Valabhi, who succeeded them in Kāthiāwār and some of the neighbouring territories; and so it became also known as the Valabhi era.

From Halsi in the Belgaum district, Bombay, we have a record of the Kadamba king Kākusthavarmān, which was framed during the time when he was the Yuvarāja or anointed successor to the sovereignty, and may be referred to about A.D. 500. It is dated in "the eightieth victorious year," and thus indicates the preservation of a reckoning running from the foundation of the Kadamba dynasty by Mayūravarmān, the great-grandfather of Kākusthavarmān. But no other evidence of the existence of this era has been obtained.

The records of the Gāṅga kings of Kalīnganagara, which is the modern Mukhalingam-Nagarikāṭakam in the Gañjām district, Madras, show the existence of a Gāṅga era which ran for at any rate 254 years. And various details in the inscriptions enable us to trace the origin of the Gāṅga kings to Western India, and to place the initial point of their reckoning in A.D. 590, when a certain Satyārāya-Dhruvarāja-Indravarma, an ancestor and probably the grandfather of the first Gāṅga king Rājasiṅha-Indravarma I., commenced to govern a large province in the Konkan under the Chalukya king Kirtivarma I.

An era commencing in A.D. 605 or 606 was founded in Northern India by the great king Harshavardhana, who reigned first at Thāṅṅar and then at Kanauj, and who was the third sovereign in a dynasty which traced its origin to a prince named Naravardhana. A peculiarity about this era is that it continued in use for apparently four centuries after Harshavardhana, in spite of the fact that his line ended with him.

The inscriptions assert that the Western Chālukya king Vikrama or Vikramāditya VI. of Kalyāni in the Nizām's dominions, who reigned from A.D. 1076 to 1126, abolished the use of the Saka era in his dominions in favour of an era named after himself. What he or his ministers did was to adopt, for the first time in that dynasty, the system of regnal years, according to which, while the Saka era also remained in use, most of the records of his time are dated, not in that era, but in the year 50-and-50 of the Chālukya-Vikrama-kāla or Chālukya-Vikrama-varsha, "the time or years of the Chālukya Vikrama." There is some evidence that this reckoning survived Vikramāditya VI. for a short time. But his successors introduced their own regnal reckonings; and that prevented it from acquiring permanence.

In Tirhūt, there is still used a reckoning which is known as the Lakshmanāsēna era from the name of the king of Bengal by whom it was founded. There is a difference of opinion as to the exact initial point of this reckoning; but the best conclusion appears to be that which places it in A.D. 1119. This era prevailed at one time throughout Bengal: we know this from a passage in the *Akharnāma*, written in A.D. 1584, which specifies the Saka era as the reckoning of Gujārat and the Dekkan, the Vikrama era as the reckoning of Mālwā, Delhi, and those parts, and the Lakshmanāsēna era as the reckoning of Bengal.

The last reckoning that we have to mention here is one known as the Rājyābhisheka-Saka, "the era of the anointment to the sovereignty," which was in use for a time in Western India. It dated from the day Jyāishtha sukla 13 of the Saka year 1597 current, = 6 June, A.D. 1674, when Sivaji, the founder of the Marāṭhā kingdom, had himself enthroned.

There are four reckonings which it is difficult at present to class exactly. Two inscriptions of the 15th and 17th centuries, recently

brought to notice from Jēsalmer in Rājputānā, present a reckoning which postulates an initial point in A.D. 624 or in the preceding or the following year, and bears an appellation, Bhāṭika, which seems to be based on the name of the Bhāṭṭi tribe, to which the rulers of Jēsalmer belong. No historical event is known, referable to that time, which can have given rise to an era. It is possible that the apparent initial date represents an epoch, at the end of the Saka year 546 or thereabouts, laid down in some astronomical work composed then or soon afterwards and used in the Jēsalmer territory. But it seems more probable that it is a purely fictitious date, set up by an attempt to evolve an early history of the ruling family.

In the Tinnevely district of Madras, and in the territories of the same presidency in which the Malayālam language prevails, namely, South Kanara below Mangalore, the Malabar district, and the Cochin and Travancore states, there is used a reckoning which is known sometimes as the Kollam or Kolamba reckoning, sometimes as the era of Paraśurāma. The years of it are solar: in the southern parts of the territory in which it is current, they begin with the month Śiṅhā; in the northern parts, they begin with the next month, Kanyā. The initial point of the reckoning is in A.D. 825; and the year 1076 commenced in A.D. 1900. The popular view about this reckoning is that it consists of cycles of 1000 years; that we are now in the fourth cycle; and that the reckoning originated in 1176 B.C. with the mythical Paraśurāma, who exterminated the Kshatriya or warrior caste, and reclaimed the Konkan countries, Western India below the Ghāuts, from the ocean. But the earliest known date in it, of the year 149, falls in A.D. 973; and the reckoning has run on in continuation of the thousand, instead of beginning afresh in A.D. 1825. It seems probable, therefore, that the reckoning had no existence before A.D. 825. The years are cited sometimes as "the Kollam year (of such-and-such a number)," sometimes as "the year (50-and-50) after Kollam appeared;" and this suggests that the reckoning may possibly owe its origin to some event, occurring in A.D. 825, connected with one or other of the towns and ports named Kollam, on the Malabar coast; perhaps Northern Kollam in the Malabar district, perhaps Southern Kollam, better known as Quilon, in Travancore. But the introduction of Paraśurāma into the matter, which would carry back (let us say) the foundation of Kollam to legendary times, may indicate, rather, a purely imaginative origin. Or, again, since each century of the Kollam reckoning begins in the same year A.D. with a century of the Saptarshi reckoning (see below under III. Other Reckonings), it is not impossible that this reckoning may be a southern offshoot of the Saptarshi reckoning, or at least may have had the same astrological origin.

In Nēpāl there is a reckoning, known as the Nēwār era and commencing in A.D. 879, which superseded the Gupta and Harsha eras there. One tradition attributes the foundation of it to a king Rāghavadēva; another says that, in the time and with the permission of a king Jayadēvamalla, a merchant named Sikkhīl paid off, by means of wealth acquired from sand which turned into gold, all the debts then existing in the country, and introduced the new era in commemoration of the occurrence. It is possible that the era may have been founded by some ruler of Nēpāl; but nothing authentic is known about the particular names mentioned in connexion with it. This era appears to have been discarded for state and official purposes, in favour of the Saka era, in A.D. 1768, when the Gūrkhās became masters of Nēpāl; but manuscripts show that in literary circles it has remained in use up to at any rate A.D. 1875.

Inscriptions disclose the use in Kāthiāwār and Gujārat, in the 12th and 13th centuries, of a reckoning, commencing in A.D. 1114, which is known as the Sīrīha-sarvat. No historical occurrence is known, on which it can have been based; and the origin of it is obscure.

The eras mentioned above have for the most part served their purposes and died out. But there are three great reckonings, dating from a very respectable antiquity, which have held their own and survived to the present day. These are the Kaliyuga, Vikrama, and Saka eras. It will be convenient to treat the Kaliyuga first, though, in spite of having the greatest apparent antiquity, it is the latest of the three in respect of actual date of origin.

The Kaliyuga era is the principal astronomical reckoning of the Hindus. It is frequently, if not generally, shown in the almanacs; but it can hardly be looked upon as being now in practical use for civil purposes; and, as regards the custom of previous times as far as we can judge it from the inscriptional use, which furnishes a good

guide, the position is as follows: from Southern India we have one such instance of A.D. 634, one of A.D. 770, three of the 10th century, and then, from the 12th century onwards, but more particularly from the 14th, a certain number of instances, not exactly very small in itself, but extremely so in comparison

Miscellaneous Eras.

Three great eras in general use.

The Kaliyuga Era of 3102 B.C.

with the number of cases of the use of the Vikrama and Saka eras and other reckonings: from Northern India the earliest known instance of is A.D. 1169 or 1175, and the later ones number only four. Its years are by nature sidereal solar years, commencing with the Mēshā-saṁkrānti, the entrance of the sun into the Hindu constellation and sign Mēsha, i.e. Aries (for this and other technical details, see above, under the Calendar);¹ but they were probably cited as lunar years in the inscriptional records which present the reckoning; and the almanacs appear to treat them either as Mēshādi civil solar years with solar months, or as Chaitrādi lunar years with lunar months *amānta* (ending with the new-moon) or *pūrṇimānta* (ending with the full-moon) as the case may be, according to the locality. Its initial point lies in 3102 B.C.; and the year 5002 began in A.D. 1900.²

This reckoning is not an historical era, actually running from 3102 B.C. It was devised for astronomical purposes at some time about A.D. 400, when the Hindu astronomers, having taken over the principles of the Greek astronomy, recognized that they required for purposes of computation a specific reckoning with a definite initial occasion. They found that occasion in a conjunction of the sun, the moon, and the five planets which were then known, at the first point of their sign Mēsha. There was not really such a conjunction; nor, apparently, is it even the case that the sun was actually at the first point of Mēsha at the moment arrived at. But there was an approach to such a conjunction, which was turned into an actual conjunction by taking the mean instead of the true positions of the sun, the moon, and the planets. And, partly from the reckoning which has come down to us, partly from the astronomical books, we know that the moment assigned to the assumed conjunction was according to one school the midnight between Thursday the 17th, and Friday the 18th, February, 3102 B.C., and according to another school the sunrise on the Friday.

The reckoning thus devised was subsequently identified with the Kaliyuga as the iron age, the last and shortest, with a duration of 432,000 years, of the four ages in each cycle of ages in the Hindu system of cosmical periods. Also, traditional history was fitted to it by one school, represented notably by the Purāṇas, which, referring the great war between the Pāṇḍavas and the Kurus, which is the topic of the Mahābhārata, to the close of the preceding age, the Dvāpāra, placed on the last day of that age the culminating event which ushered in the Kali age; namely, the death of Kṛishṇa (the return to heaven of Viṣṇu on the termination of his incarnation as Kṛishṇa), which was followed by the abdication of the Pāṇḍava king Yudhishtira, who, having installed his grand-nephew Parikshit as his successor, then set out on his own journey to heaven. Another school, however, placed the Pāṇḍavas and the Kurus 653 years later, in 2449 B.C. A third school places in 3102 B.C. the anointment of Yudhishtira to the sovereignty, and treats that event as inaugurating the Kali age; from this point of view, the first 3044 years of the Kaliyuga—the period from its commencement in 3102 B.C. to the commencement of the first historical era, the so-called Vikrama era, in 58 B.C.—are also known as “the era of Yudhishtira.”

The Vikrama era, which is the earliest of all the Hindu eras in respect of order of foundation, is the dominant era and the great historical reckoning of Northern India—that is, of the territory on the north of the rivers Narbadā and Mahānādī—to which part of the country its use has always been practically confined. Like, indeed, the Kaliyuga and Saka eras, it is freely cited in almanacs in any part of India; and it is sometimes used in the south by immigrants from the north: but it is, by nature, so essentially foreign to the south that the earliest known inscriptional instance of the use of it in Southern India only dates from A.D. 1218, and the very few later instances that have been obtained, prior to the 15th century A.D., come, along with the instance of A.D. 1218, from the close neighbourhood of the dividing-line between the

¹ It is always to be borne in mind that, as already explained, while the Hindu Mēsha answers to our Aries, it does not coincide with either the sign or the constellation Aries.

² We select A.D. 1900 as a gauge-year, in preference to the year in which we are writing, because its figures are more convenient for comparative purposes. In accordance with the general tendency of the Hindus to cite expired years, the almanacs would mostly show 5001 (instead of 5002) as the number for the Kaliyuga year answering to A.D. 1900-1901. And, for the same reason, this reckoning has often been called the Kaliyuga era of 3101 B.C. There is, perhaps, no particular objection to that, provided that we then deal with the Vikrama and Saka eras on the same lines, and bear in mind that in each case the initial point of the reckoning really lies in the preceding year. But we prefer to treat these reckonings with exact correctness.

north and the south. The Vikrama era has never been used for astronomical purposes. Its years are lunar, with lunar months, but seem liable to be sometimes regarded as solar, with solar months, when they are cited in almanacs of Southern India which present the solar calendar. Originally they were Kārttikādi, with *pūrṇimānta* months (ending with the full-moon). They now exist in the following three varieties: in Kāthiāwār and Gujarāt, they are chiefly Kārttikādi, with *amānta* months (ending with the new-moon); and they are shown in this form in almanacs for the other parts of the Bombay Presidency; but there is also found in Kāthiāwār and that neighbourhood an Āshādhādi variety, commencing with Āshāḍha sukla 1, similarly with *amānta* months; in the rest of Northern India, they are Chaitrādi, with *pūrṇimānta* months. The era has its initial point in 58 B.C., and its first civil day, Kārttika sukla 1; is 19th September in that year if we determine it with reference to the Hindu Tulā-saṁkrānti, or 18th October if we determine it with reference to the tropical equinox. The years of the three varieties, Chaitrādi, Āshādhādi, and Kārttikādi, all commence in the same year A.D.; and the year 1958 began in A.D. 1900.

Hindu legend connects the foundation of this era with a king Vikrama or Vikramāditya of Ujjain in Mālwā, Central India: one version is that he began to reign in 58 B.C.; another is that he died in that year, and that the reckoning commemorates his death. Modern research, however, based largely on the inscriptional records, has shown that there was no such king, and that the real facts are very different. The era owes its existence to the Kushan king Kanishka, a foreign invader, who established himself in Northern India and commenced to reign there in B.C. 58.³ He was the founder of it, in the sense that the opening years of it were the years of his reign. It was established and set going as an era by his successor, who continued the reckoning so started, instead of breaking it by introducing another according to his own regnal years. And it was perpetuated as an era, and transmitted as such to posterity by the Mālavas, the people from whom the modern territory Mālwā derived its name, who were an important section of the subjects of Kanishka and his successors. In consonance with that, records ranging in date from A.D. 473 to 879 style it “the reckoning of the Mālavas, the years of the Mālava lords, the Mālava time or era.” Prior to that, it had no specific name; the years of it were simply cited, in ordinary Hindu fashion, by the term *samvatsara*, “the year (of such-and-such a number),” or by its abbreviations *samvat* and *savt*; and the same was frequently done in later times also, and is habitually done in the present day; and so, in modern times, this era has often been loosely styled “the Samvat era.” The idea of a king Vikrama in connexion with it appears to date from only the 9th or 10th century A.D.

The Saka era, though it actually had its origin in the south-west corner of Northern India, is the dominant era and the great historical reckoning of Southern India; that is, of the territory below the rivers Narbadā and Mahānādī. It is also the subsidiary astronomical reckoning, largely used, from the 6th century A.D. onwards, in the *Karavās*, the works dealing with practical details of the calendar, for laying down epochs or points of time furnishing convenient bases for computation. As a result of that, it came to be used in past times for general purposes also, to a limited extent, in parts of Northern India where it was not indigenous. And it is now used more or less freely, and is cited in almanacs everywhere. Its years are usually lunar, Chaitrādi, and its months are *pūrṇimānta* (ending with the full-moon) in Northern India, and *amānta* (ending with the new-moon) in Southern India; but in times gone by it was sometimes treated for purposes of calculation as having astronomical solar years, and it is now treated as having Mēshādi civil solar years and solar months in those parts of India where that form of the solar calendar prevails. It has its initial point in A.D. 78; and its first civil day, Chaitra sukla 1, is 3rd March

The Saka Era of A.D. 78.

³ It may be remarked that there are about twelve different views regarding the date of Kanishka and the origin of the Vikrama era. Some writers hold that Kanishka began to reign in A.D. 78, and founded the so-called Saka era beginning in that year; one writer would place his initial date about A.D. 123, others would place it in A.D. 278. The view maintained by the present writer was held at one time by Sir A. Cunningham; and, as some others have already begun to recognize, evidence is now steadily accumulating in support of the correctness of it.

in that year, as determined with reference either to the Hindu *M'na-samkrānti* or to the entrance of the sun into the tropical Pisces. The year 1823 began in A.D. 1900.

Regarding the origin of the Saka era, there was current in the 10th and 11th centuries A.D. a belief which, ignoring the difference of a hundred and thirty-five years between the two reckonings, connected the legendary king Vikramāditya of Ujjain, mentioned above under the Vikrama era, with the foundation of this era also. The story runs, from this point of view, that the Sakas were a barbarous people who established themselves in the western and north-western dominions of that king, but were met in battle and destroyed by him, and that the era was established in celebration of that event. The modern belief, however, ascribes the foundation of this era to a king Śālivāhana of Pratiśthāna, which is the modern Paithan, on the Godāvarī, in the Nizam's dominions. But in this case, again, research has shown that the facts are very different. Like the Vikrama era, the Saka era owes its existence to foreign invaders. It was founded by the Chaharāta or Kahaharāta king Nahapāna, who appears to have been a Pahlava or Palhava, i.e. of Parthian extraction, and who reigned from A.D. 78 to about 125.¹ He established himself first in Kāthiāwār, but subsequently brought under his sway northern Gujarāt (Bombay) and Ujjain, and, below the Narbada, southern Gujarāt, Nāsik and probably Khāndēsh. His capital seems to have been Dōhad, in the Pañch Mahāls. And he had two viceroys: one, named Bhūmaka, of the same family with himself, in Kāthiāwār; and another, Chashtana, son of Ghasmōtika, at Ujjain. Soon after A.D. 125, Nahapāna was overthrown, and his family was wiped out, by the Śātavāhana-Śātakarṇi king Gautamīputra-Śri-Śātakarṇi, who thereby recovered the territories on the south of the Narbada, and perhaps secured for a time Kāthiāwār and some other parts on the north of that river. Very soon, however, Chashtana, or else his son Jayadāman, established his sway over all the territory which had belonged to Nahapāna on the north of the Narbada; founded a line of Hinduized foreign kings, who ruled there for more than three centuries; and, continuing Nahapāna's regnal reckoning, established the era to which the name Saka eventually became attached. Inscriptions and coins show that, up to at least the second decade of its fourth century, this reckoning had no specific appellation; its years were simply cited, in the usual fashion, as *varsha*, "the year (of such-and-such a number)." The reckoning was then taken up by the astronomers. And we find it first called Sakakāla, "the time or era of the Sakas," in an epochal date, the end of the year 427, falling in A.D. 505, which was used by the astronomer Varāhamihira (d. A.D. 577) in his Pañchasiddhāntikā. That this name came to be attached to it appears to be due to the points that, along with some of the Pahlavas or Palhavas and the Yavanas or descendants of the Asiatic Greeks, some of the Sakas, the Scythians, had made their way into Kāthiāwār and neighbouring parts by about A.D. 100, and that the Sakas incidentally came to acquire prominence in the memory of the Hindus regarding these occurrences, in such a manner that their name was selected when the occasion arose to devise an appellation for an era the exact origin of which had been forgotten. The name of the imaginary king Śālivāhan's first figures in connexion with the era in a record of A.D. 1272, and seems plainly to have been introduced in imitation of the coupling of the name Vikrama, Vikramāditya, with the era of B.C. 58.

That the Saka era, though it had its origin in the south-west corner of Northern India, is essentially an era of Southern India, is proved by its inscriptional and numismatic history. During the period before the time when it was taken up by the astronomers, it is found only in the inscriptions of Nahapāna, and in the similar records and on the coins of the descendants of Chashtana. After that same time, it figures first in a record of the Chalukya king Kirtivarman I., at Bādāmi in the Bijāpūr district, Bombay, which is dated on the full-moon day of the month Kārttika, falling in A.D. 578, "when there had elapsed five centuries of the years of the anointment of the Saka king to the sovereignty." And from this date onwards the records of a large part of Southern India are mostly dated in this era, by various expressions all of which include

¹ See the preceding note.

the term *Saka* or *Sāka*. In Northern India the case is very different. We have a record dated in the month Kārttika, the Saka year 631 (expired), falling in A.D. 709; it comes from Multāi in the Bētūl district, Central Provinces, that is, from the south of the Narbada; but it belongs to Gujarāt (Bombay), and perhaps to the north, though more probably to the south, of that province. But, setting that aside, the earliest inscriptional instance of the use of this era in Northern India, outside Kāthiāwār and Gujarāt, is found in a record of A.D. 862 at Dēogah near Lalitpūr, the headquarters town of the Lalitpūr district, United Provinces of Agra and Oude; here, however, the record is primarily dated, with the full details of the month, &c., in "Sadvat 919," that is, in the Vikrama year 919; it is only as a subsidiary detail that the Saka year 784 is given in a separate passage at the end of the record, a sort of postscript. From this date onwards the era is found in other records of Northern India, but to any appreciable extent only from A.D. 1137, and to only a very small extent in comparison with the Vikrama and other northern eras; and the cases in which it was used exclusively there, without being coupled with one or other of the northern reckonings, are still more conspicuously few. In short, the general position is that the Saka era has been essentially foreign to Northern India until recent times; it was used there quite exceptionally and sporadically, and in very few cases indeed at any appreciable distance from the dividing-line between the north and the south. That it found its way into Northern India, outside Kāthiāwār and northern Gujarāt at all, is unquestionably due to its use by the astronomers. It also travelled, across the sea, by the 7th century A.D. to Cambodia, and somewhat later to Java; to which parts it was doubtless taken in almanacs, or in invoices, statements of account, &c., by the persons engaged in the trade between Broach and the far east via Tagara (Tér) and the east coast. It also found its way in subsequent times to Assam and Ceylon, and more recently still to Nēpal.

III. OTHER RECKONINGS

We come now to certain reckonings consisting of cycles, and will take first the cycles of Guru or Bṛhaspati, Jupiter. This planet, a very conspicuous object in eastern skies, requires a period of 4332.6 days, = 50.4 days less than twelve Julian years, to make a circuit of the heavens, and has provided the Hindus with two reckonings, each in more than one variety; a cycle of twelve years, and a cycle of sixty years. The years of Jupiter, in all their varieties, are usually styled *samvatsara*; and it is convenient to use this term here, in order to preserve clearly the distinction between them and the solar and lunar years. The *samvatsaras* have no divisions of their own; the months, days, &c., cited with them are those of the ordinary solar or lunar calendar, as the case may be.

The
Cycles of
Jupiter.

The older reckoning of Jupiter appears to be that of the 12-years cycle, which is found in two varieties; in both of them the *samvatsaras* bear, according to certain rules which need not be explained here, the same names with the lunar months, Chaitra, Vaiśākha, &c. In one variety, each *samvatsara* runs from one of the planet's heliacal risings—that is, from the day on which it becomes visible as a morning star on the eastern horizon—to the next such rising; and the length of such a *samvatsara*, according to the Hindu data, is from 392 to 405 days, with an average of 399 days. Inscriptional instances of the use of this cycle are found in six of the Gupta records of Northern India, ranging from A.D. 475 to 528.

The 12-
years
Cycle.

In the other variety of the 12-years cycle, which is mentioned in astronomical works from the time of Āryabhaṭa onwards (b. A.D. 476), the *samvatsaras* are regulated by Jupiter's course with reference to his mean motion and mean longitude: a *samvatsara* of this variety commences when Jupiter thus enters a sign of the zodiac, and lasts for the time occupied by him in traversing that sign from the same point of view; and the period taken by him to do that—that is, the duration of such a *samvatsara*—is slightly in excess, according to the Hindu data, of 361.02 days, which amount is very close to the actual fact, 361.05 days. Inscriptional instances of the use of this cycle are perhaps found in two records of Southern India of the Kadamba series, belonging to about A.D. 575.

The 12-years mean-sign cycle seems to be still used in some parts. And the heliacal risings of Jupiter, as also, indeed, those of the other planets, are shown in almanacs for astrological purposes. In either variety, however, the 12-years cycle is now chiefly of antiquarian interest.

The cycle of Jupiter now in general use is a cycle of sixty years, the *samvatsaras* of which bear certain special names, Prabhava, Vibhava, Sukla, Pramōda, &c., again in accordance with certain rules which we need not explain here. This cycle exists in three varieties.

According to the original constitution of this cycle, the *samvatsaras* are determined as in the second or mean-sign variety of the 12-years cycle: each *samvatsara* commences when Jupiter enters a sign of the zodiac with reference to his mean motion and longitude; and it lasts for slightly more than 361.02 days. This variety is traced back in inscriptions records to A.D. 602, and is still used in Northern India.

Now, the *samvatsaras* are calculated by means of the astronomical solar year commencing with the Mēsha-saṁkrānti, the entrance of the sun into the sign Mēsha (Aries). The process gives the number of the *samvatsaras* last expired before any particular Mēsha-saṁkrānti, with a remainder denoting the portion of the current *samvatsara* elapsed up to the same time; and the remainder, reduced to months, &c., gives the moment of the commencement of the current *samvatsara*, by reckoning back from the Mēsha-saṁkrānti. As the result, apparently, of unwillingness to take the trouble to work out the full details, at some time about A.D. 800 a practice arose, in some quarters, according to which that *samvatsara* of the 60-years cycle which was current at any particular Mēsha-saṁkrānti was taken as coinciding with the astronomical solar year beginning at that *saṁkrānti*, and with the Chaitrādi lunar year belonging to that same solar year. And this practice set up a lunisolar variety of the cycle, in connexion with which we have to notice the following point. While the duration of a mean-sign *samvatsara* is closely about 361.02 days, the length of the Hindu astronomical solar year is closely about 365.258 days. It consequently happens, after every 85 or 86 years, that a mean-sign *samvatsara* begins and ends between two successive Mēsha-saṁkrāntis. In the mean-sign cycle, such a *samvatsara* retains its existence unaffected; and the names Prabhava, Vibhava, &c., run on without any interruption. According to the lunisolar system, however, the position is different; the *samvatsara* beginning and ending between the two Mēsha-saṁkrāntis is expunged or suppressed, in the sense that its name is omitted and is replaced by the next name on the list. The second variety of the 60-years cycle, thus started, ran on alongside of the mean-sign variety, and, being eventually transferred, with that variety, to Northern India, is now known as the northern lunisolar variety. It preserves a connexion between the *samvatsaras* and the movements of Jupiter: but the connexion is an imperfect one; and both in this variety, and still more markedly in the remaining one still to be described, the *samvatsaras* practically became mere appellations for the solar and lunar years.

Meanwhile, just after A.D. 900, another development occurred, and there was started a third variety, which is now known as the southern lunisolar variety. The precise year in which this happened depends on the particular authority that we follow. If we take the elements adopted in the Sūrya-Siddhānta as the proper data for that time and for the locality—Western India below the Nerbada—to which the early history of the cycle belongs, the position was as follows. At the Mēsha-saṁkrānti in A.D. 908 there was current, by the mean-sign system, the *samvatsara* No. 2, Vibhava; but No. 4, Pramōda, was current by the same system at the Mēsha-saṁkrānti in A.D. 909; and No. 5, Sukla, began and ended between the two Mēsha-saṁkrāntis. Accordingly, No. 2, Vibhava, was the lunisolar *samvatsara* for the Mēshādi solar year and the Chaitrādi lunar year commencing in A.D. 908; and by the strict lunisolar system, which was adhered to by some people and is now known as the northern lunisolar system, it was followed in A.D. 909 by No. 4, Pramōda, the name of the intermediate *samvatsara*, No. 3, Sukla, being passed over. On the other hand, whether through oversight, or whatever the reason may have been, by other people the name of No. 3, Sukla, was not passed over, but that *samvatsara* was taken as the lunisolar *samvatsara* for the Mēshādi solar year and the Chaitrādi lunar year beginning in A.D. 909, and No. 4, Pramōda, followed it in A.D. 910. On subsequent similar occasions, also, there was, in

the same quarters, no passing over of the name of any *samvatsara*. And this practice established itself in Southern India, to the exclusion there of the mean-sign and the northern lunisolar varieties; the discrepancy between the last-mentioned variety and the variety thus set up continuing, of course, to increase by one *samvatsara* after every 85 or 86 years. In this variety, the southern lunisolar variety, all connexion between the *samvatsaras* and the movements of Jupiter has now been lost.

The present position of the 60-years cycle in its three varieties may be illustrated thus. In Northern India, by the mean-sign system the *samvatsara* No. 46, Paridhāvin, began, according to different authorities, in August, September or October, A.D. 1899. Consequently, by the northern or expunging lunisolar system, that same *samvatsara*, No. 46, Paridhāvin, coincided with the Mēshādi civil solar year beginning with or just after 12th April, and with the Chaitrādi lunar year beginning with 31st March, A.D. 1900. But by the southern or non-expunging lunisolar system those same solar and lunar years were No. 34, Sarvarin.

The treatment of the cycles of Jupiter in the Sanskrit books shows that it was primarily from the astrological point of view that they appealed to the Hindus; it was only as a secondary consideration that they acquired anything of a chronological nature. For the practical application of any of them to historical purposes, it is, of course, necessary that, along with the mention of a *samvatsara*, there should always be given the year of some known era, or some other specific guide to the exact period to which that *samvatsara* is to be referred. But it is fortunately the case that the *samvatsaras* have been but rarely cited in the inscriptions records without such a guide, of some kind or another.

The Saptarshi reckoning is used in Kashmir, and in the Kāngra district and some of the Hill states on the south-east of Kashmir; some nine centuries ago it was also in use in the Punjab, and apparently in Sind. In addition to being cited by such expressions as Saptarshi-saṁvat, "the year (so-and-so) of the Saptarshi," and Śāstra-saṁvatsara, "the year (so-and-so) of the scriptures," it is found mentioned as Lōkakāla, "the time or era of the people," and by other terms which mark it as a vulgar reckoning. And it appears that modern popular names for it are Pahāpt-saṁvat and Kachchā-saṁvat, which we may render by "the Hill era" and "the crude era." The years of this reckoning are lunar, Chaitrādi; and the months are *pārgimānta* (ending with the full-moon). As matters stand now, the reckoning has a theoretical initial point in 3077 B.C.; and the year 4976, more usually called simply 76, began in A.D. 1900; but there are some indications that the initial point was originally placed one year earlier.

The idea at the bottom of this reckoning is a belief that the Saptarshis, "the Seven Rishis or Saints," Marichi and others, were translated to heaven, and became the stars of the constellation Ursa Major, in 3076 B.C. (or 3077); and that these stars possess an independent movement of their own, which, referred to the ecliptic, carries them round at the rate of 100 years for each *nakshatra* or twenty-seventh division of the circle. Theoretically, therefore, the Saptarshi reckoning consists of cycles of 2700 years; and the numbering of the years should run from 1 to 2700, and then commence afresh. In practice, however, it has been treated quite differently. According to the general custom, which has distinctly prevailed in Kashmir from the earliest use of the reckoning for chronological purposes, and is illustrated by Kalhana in his history of Kashmir, the *Rājataranginī*, written in A.D. 1148-1150, the numeration of the years has been centennial; whenever a century has been completed, the numbering has not run on 101, 102, 103, &c., but has begun again with 1, 2, 3, &c. Almanacs, indeed, show both the figures of the century and the full figures of the entire reckoning, which is treated as running from 3076 B.C., not from 376 B.C. as the commencement of a new cycle, the second; thus, an almanac for the year beginning in A.D. 1793 describes that year as "the year 4869 according to the course of the Seven Rishis, and similarly the year 69." And elsewhere sometimes the full figures are found, sometimes the abbreviated ones; thus, while a manuscript written in A.D. 1648 is dated in "the year 24" (or 4724), another, written in A.D. 1224 is dated in "the year 4300." But, as in the *Rājataranginī*, so also in inscriptions, which range from A.D. 1204 onwards, only the abbreviated figures have hitherto been found. Essentially, therefore, the Saptarshi reckoning is a centennial reckoning, by suppressed or omitted hundreds, with its earlier centuries commencing in 3076, 2976 B.C., and so on, and its later centuries commencing in A.D. 25, 125, 225, &c.; on precisely the same lines with those according to which we may use, e.g. 98 to mean A.D. 1798, and 57 to mean A.D. 1857, and 9 to mean A.D. 1909. And the practical difficulties attending the use of such a system for chronological purposes are obvious; isolated dates recorded in such a fashion cannot be allocated without some explicit clue to

the centuries to which they belong. Fortunately, however, as regards Kashmir, we have the necessary guide in the facts that Kalhāna recorded his own date in the Saka era as well as in this reckoning, and gave full historical details which enable us to determine unmistakably the equivalent of the first date in this reckoning cited by him, and to arrange with certainty the chronology presented by him from that time.

The belief underlying this reckoning according to the course of the Seven Rishis is traced back in India, as an astrological detail, to at least the 6th century A.D. But the reckoning was first adopted for chronological purposes in Kashmir and at some time about A.D. 800; the first recorded date in it is one of "the year 89," meaning 3889, = A.D. 813-814, given by Kalhāna. It was introduced into India between A.D. 925 and 1025.

The Grahaparivṛitti is a reckoning which is used in the southernmost parts of Madras, particularly in the Madura district. It consists of cycles of 90 Mēshādi solar years, and is said, in conformity with its name, which means "the revolution of planets," to be made up by the sum of the days in 1 revolution of the sun, 22 of Mercury, 5 of Venus, 15 of Mars, 11 of Jupiter, and 29 of Saturn. The first cycle is held to have commenced in 24 B.C., the second in A.D. 67, and so on; and, in accordance with that view, the year 34, which began in A.D. 1900, was the 34th year of the 22nd cycle.

No inscriptional use of this cycle has come to notice. There seems no substantial reason for believing that the reckoning was really started in 24 B.C. The alleged constitution of the cycle, which appears to be correct within about twelve days, and might possibly be made apparently exact, suggests an astrological origin. And, if a guess may be hazarded, we would conjecture that the reckoning is an offshoot of the southern lunisolar variety of the 60-years cycle of Jupiter, and had its real origin in some year in which a Prabhava *samvatsara* of that variety commenced, and to which the first year of a Grahaparivṛitti cycle can be referred: that was the case in A.D. 967 and at each subsequent 180th year.

In part of the Gañjām district, Madras, there is a reckoning, known as the *Oṅko* or *Anka*, i.e. literally "the number or numbers," consisting of lunar years, each commencing with Bhādrapada śukla 12, which run theoretically in cycles of 59 years. But the reckoning has the peculiarity that, whether the explanation is to be found in a superstition about certain numbers or in some other reason, the year 6, and any year the number of which ends with 6 or 0 (except the year 10), is omitted from the numbering; so that, for instance, the year 7 follows next after the year 5. The origin of the reckoning is not known. But the use of it seems to be traceable in records of the Gaṅga kings who reigned in that part of the country and in Orissa in the 12th and following centuries. And the initial day, Bhādrapada śukla 12, which figures again in the Vilāyāti and Amli reckoning of Orissa (see farther on), is perhaps to be accounted for on the view that this day was the day of the anointment, in the 7th century, of the first Gaṅga king, Rājasimha-Indravarmān I.

In the Chittagong district, Bengal, there is a solar reckoning, known by the name *Maghī*, of which the year 1262 either began or ended in A.D. 1900; so that it has an initial point in A.D. 639 or 638. It appears that Chittagong was conquered by the king of Arakan in the 9th century, and remained usually in the possession of the Maghs—the Arakanese or a class of them—till A.D. 1666, when it was finally annexed to the Mogul empire. In these circumstances it is plain that the Magh reckoning took its name from the Maghs; its year, which is Mēshādi, from Bengal; and its numbering from the Sakkarāj, the ordinary era of Arakan and Burma, which has its initial point in A.D. 638.

The Hijra (Hegira) era, the reckoning from the flight of Mahomet, which dates from the 10th of July, A.D. 662, is, of course, used by the Mahomedans in India, and is customarily shown, with the details of its calendar, in the Hindu almanacs. An account of it does not fall within the scope of this article. But we have to mention it because we come now to certain Hinduized reckonings which are hybrid offshoots of it. We need only say, however, in explanation of some of the following figures, that the years of the Hijra era are purely lunar, consisting of twelve lunar months and no more; with the result that the

initial day of the year is always travelling backwards through the Julian year, and makes a complete circuit in thirty-four years. The reckonings derived from it, which we have to describe, have apparent initial points in A.D. 591, 593, 594, and 602. They had their real origin, however, in the 14th, 16th, and 17th centuries.

The emperor Akbar succeeded to the throne in February, A.D. 1556, in the Hijra year 963, which ran from 16th November 1555 to 3rd November 1556. Amongst the reforms aimed at by him and his officials, one was to abolish, or at least minimize, by introducing uniformity of numbering, the confusion due to the existence of various reckonings, both Mahomedan and Hindu. And one step taken in that direction was to assign to the Hindu year the same number with the Hijra year. It is believed that this was first done by the Persian clerks of the revenue and financial offices at an early time in Akbar's reign, and that it received authoritative sanction in the Hijra year 971 (21st August 1563 to 8th August 1564). At any rate, the innovation was certainly first made in Upper India; and the numbering started there was introduced into Bengal and those parts as Akbar extended his dominions, but without interfering with local customs as to the commencement of the Hindu year. The result is that we now have the following reckonings, the years of which are used as revenue years:—

In the United Provinces and the Punjab, there is an *Āsvīnādi* lunar reckoning, known as the *Faṣlī*, according to which the year 1308 began in A.D. 1900; so that the reckoning has an apparent initial point in A.D. 593. The name of this reckoning is derived from *faṣl*, "a harvest," of which there are two; the *faṣl-rabi* or "spring harvest," commencing in February, and the *faṣl-i-kharif*, or "autumn harvest," commencing in October. The years of this reckoning begin with the *pūrṇimā* *Āsvina* *krishna* 1, which now falls in September. A peculiar feature of it is that, though the months are lunar, they are not divided into fortnights, and the numbering of the days runs on, as in the Mahomedan month, from the first to the end of the month without being affected by any expunction and repetition of *śūbha*; and, for this and other reasons, it seems that in this case a new form of Hindu year was devised, of such a kind as to enable the agriculturists to realize their produce and pay their assessments comfortably within the year. The Hijra era has, of course, now drawn somewhat widely away from this and the other reckonings derived from it; the Hijra year commencing in A.D. 1900 was 1318, ten years in advance of the *Faṣlī* year.

In Orissa and some other parts of Bengal, there is a reckoning, or two almost identical reckonings, the facts of which are not quite clear. According to one account, the term *Amli-san*, "the official year," is only another name of the *Vilāyāti-san*, "the year received from the *vilāyat* or province of Hindustan." But we are also told that the *Vilāyāti-san* is a *Kanyādi* solar year, whereas the *Amli-san*, though it too has solar months, changes its number on the lunar day Bhādrapada śukla 12 (mentioned above in connexion with the *Oṅko* cycle of Orissa), which comes sometimes in *Kanyā*, but sometimes in the preceding month, *Sinhā*. Elsewhere, again, it is the *Vilāyāti-san* which is shown as changing its number on Bhādrapada śukla 12. In either case, the year 1308 of this reckoning, also, began in A.D. 1900; and so, like the *Faṣlī* of Upper India, this reckoning, too, has an apparent initial point in A.D. 593. The day Bhādrapada śukla 12 now usually falls in September, but may come during the last three days of August. The first day of the solar month *Kanyā* now falls on 15th or 16th September.

In Bengal there is in more general use a Mēshādi solar reckoning, known as the *Bengālī-san* or "Bengal year," according to which the year 1307 began in A.D. 1900; so that this reckoning has an apparent initial point in A.D. 594. The initial day of the year is the first day of the solar month *Mēṣa*, now falling on 12th or 13th April.

The system of *Faṣlī* reckonings was introduced into Southern India under the emperor Shāh Jahān, at some time in the Hijra year 1046, which ran from 26th May, A.D. 1636, to 15th May, A.D. 1637. But the numbering which was current in Northern India was not taken over. A new start was made; and, as the year of the Hijra had gone back, during the intervening seventy-three Julian years, by two years and a quarter (less by only five days) from the date of its commencement in the year 971, the *Faṣlī* reckoning of Southern India began with a nominal year 1046 (instead of 971+73=1044), commencing in A.D. 1636. The *Faṣlī* reckoning of Southern India exists in two varieties. The years of the *Bombay Faṣlī* are popularly known as *Mirjāsāl* years, because they commence when the sun enters the *śukrā* *Mirjāsāl*, which occurs now on 6th or 7th June:

The Grahaparivṛitti cycle.

The Oṅko cycle.

The Maghī reckoning.

Misdirected offshoots of the Hijra era.

The Faṣlī reckoning of Upper India.

Amli-san and Vilāyāti-san of Orissa.

The Bombay Faṣlī.

The Faṣlī of Bombay and Madras.

the reckoning seems to have taken over this initial day from the Marāthā Sūr-san (see below). The Fāsi years of Madras originally began at the Karikā-saṅkrānti, the nominal summer solstice; under the British government, the commencement of them was first fixed to 12th July, on which day the *saṅkrānti* was then usually occurring; but it was afterwards changed to 1st July as a more convenient date. The years of the Bombay and Madras Fāsi have no division of their own into months, fortnights, &c.; the year is always used along with one or other of the real Hindu reckonings, and the details are fitted according to that reckoning.

Another offshoot of the Hijra era, but one of earlier date and not belonging to the class of Fāsi reckonings, is found in the Marāthā country, in the Sūr-san or Shāhūr-san, "the year of months," also known as Arabi-san, "the Arab year." This reckoning, which is met with chiefly in old *sanads* or charters, appears to have branched off in or closely about the Hijra year 745, which ran from 13th May, A.D. 1344, to 3rd May, A.D. 1345; but the exact circumstance in which it originated is not known. The years of this reckoning begin, like those of the Bombay Fāsi, with the entrance of the sun into the *nakṣatra* Mṛgaśīra, which now occurs on 6th or 7th June; but the months and days are those of the Hijra year. The Sūr-san year 1301 began in A.D. 1900; and so the reckoning has an apparent initial point in A.D. 600. A peculiarity attending this reckoning is that, whatever may be the vernacular of a clerk, he uses the Arabic numeral words in reading out the year; and the same words are given alongside of the figures in the Hindu almanacs.

AUTHORITIES.—The Hindu astronomy had already begun to attract attention before the close of the 18th century. The investigation, however, of the calendar and the eras, along with the verification of dates, was started by Warren, whose *Kala Saṅkalita* was published in 1825. The inquiry was carried on by Prinsep in his *Useful Tables* (1834-1836) by Cowasjee Patell in his *Chronology* (1866), and by Cunningham in his *Book of Indian Eras* (1883). But Warren's processes, though mostly giving accurate results, were lengthy and troublesome; and calculations made on the lines laid down by his successors gave results which might or might not be correct, and could only be cited as approximate results. The exact calculation of Hindu dates by easy processes was started by Shankar Balkrishna Dikshit, in an article published in the *Indian Antiquary*, vol. 16 (1889). This was succeeded by methods and tables devised by Jacobi, which were published in the next volume of the same journal. There then followed several contributions in the same line by other scholars, some for exact, others for closely approximate, results, and some valuable articles by Kielhorn on some of the principal Hindu eras and other reckonings which were published in the same journal, vols. 17 (1888) to 25 (1897). And the treatment of the matter culminated for the time being in the publication, in 1896, of Sewell and Dikshit's *Indian Calendar*, which contains an appendix by Schram on eclipses of the sun in India, and was supplemented in 1898 by Sewell's *Eclipses of the Moon in India*. The present article is based on the above-mentioned and various detached writings, supplemented by original research. For the exact calculation of Hindu dates and the determination of the European equivalents of them, use may be made either of Sewell and Dikshit's works mentioned above, or of the improved tables by Jacobi which were published in the *Epigraphia Indica*, vols. 1 and 2 (1892-1894). (J. F. F.)

HINDUISM, a term generally employed to comprehend the social institutions, past and present, of the Hindus who form the great majority of the people of India; as well as the multitudinous crop of their religious beliefs which has grown up, in the course of many centuries, on the foundation of the Brahmanical scriptures. The actual proportion of the total population of India (294 millions) included under the name of "Hindus" has been computed in the census report for 1901 at something like 70% (206 millions); the remaining 30% being made up partly of the followers of foreign creeds, such as Mahomedans, Parsees, Christians and Jews, partly of the votaries of indigenous forms of belief which have at various times separated from the main stock, and developed into independent systems, such as Buddhism, Jainism and Sikhism; and partly of isolated hill and jungle tribes, such as the Santals, Bhils (Bhilla) and Kols, whose crude animistic tendencies have hitherto kept them, either wholly or for the most part, outside the pale of the Brahmanical community. The name "Hindu" itself is of foreign origin, being derived from the Persians, by whom the river Sindhu was called *Hindhu*, a name subsequently applied to the inhabitants of that frontier district; and gradually extended over the upper and middle reaches of the Gangetic valley, whence this whole tract of country between the Himalaya and the Vindhya mountains, west of Bengal, came to be called by the foreign conquerors "Hindustan," or the abode of the

Hindus; whilst the native writers called it "Aryavarta," or the abode of the Aryas.

But whilst, in its more comprehensive acceptation, the term Hinduism would thus range over the entire historical development of Brahmanical India, it is also not infrequently used in a narrower sense, as denoting more especially the modern phase of Indian social and religious institutions—from the earlier centuries of the Christian era down to our own days—as distinguished from the period dominated by the authoritative doctrine of pantheistic belief, formulated by the speculative theologians during the centuries immediately succeeding the Vedic period (see BRAHMANISM). In this its more restricted sense the term may thus practically be taken to apply to the later bewildering variety of popular sectarian forms of belief, with its social concomitant, the fully developed caste-system. But, though one may at times find it convenient to speak of "Brahmanism and Hinduism," it must be clearly understood that the distinction implied in the combination of these terms is an extremely vague one, especially from the chronological point of view. The following considerations will probably make this clear.

The characteristic tenet of orthodox Brahmanism consists in the conception of an absolute, all-embracing spirit, the Brahma (neutr.), being the one and only reality, itself unconditioned, and the original cause and ultimate goal of all individual souls (*Ātma*, i.e. living things). Coupled with this abstract conception are two other doctrines, viz. first, the transmigration of souls (*saṁsāra*), regarded by Indian thinkers as the necessary complement of a belief in the essential sameness of all the various spiritual units; however contaminated, to a greater or less degree, they may be by their material embodiment; and in their ultimate re-union with the *Paramātmān*, or Supreme Self; and second, the assumption of a triple manifestation of the ceaseless working of that Absolute Spirit as a creative, conservative and destructive principle, represented respectively by the divine personalities of Brahma (masc.), Vishnu and Śiva, forming the *Trimūrti* or Triad. As regards this latter, purely exterior doctrine, there can be little doubt of its owing its origin to considerations of theological expediency, as being calculated to supply a sufficiently wide formula of belief for general acceptance; and the very fact of this divine triad including the two principal deities of the later sectarian worship, Vishnu and Śiva, goes far to show that these two gods at all events must have been already in those early days favourite objects of popular adoration to an extent sufficient to preclude their being ignored by a diplomatic priesthood bent upon the formulation of a common creed. Thus, so far from sectarianism being a mere modern development of Brahmanism, it actually goes back to beyond the formulation of the Brahmanical creed. Nay, when, on analysing the functions and attributes of those two divine figures, each of them is found to be but a compound of several previously recognized deities, sectarian worship may well be traced right up to the Vedic age. That the theory of the triple manifestation of the deity was indeed only a compromise between Brahmanical aspirations and popular worship, probably largely influenced by the traditional sanctity of the number three, is sufficiently clear from the fact that, whilst Brahma, the creator, and at the same time the very embodiment of Brahmanical class pride, has practically remained a mere figurehead in the actual worship of the people, Śiva, on the other hand, so far from being merely the destroyer, is also the unmistakable representative of generative and reproductive power in nature. In fact, Brahma, having performed his legitimate part in the mundane evolution by his original creation of the universe, has retired into the background, being, as it were, looked upon as *functus officio*, like a venerable figure of a former generation, whence in epic poetry he is commonly styled *pitāmaha*, "the grandsire." But despite the artificial character of the *Trimūrti*, it has retained to this day at least its theoretical validity in orthodox Hinduism, whilst it has also undoubtedly exercised considerable influence in shaping sectarian belief, in promoting feelings of toleration towards the claims

of rival deities; and in a tendency towards identifying divine figures newly sprung into popular favour with one or other of the principal deities, and thus helping to bring into vogue that notion of avatars, or periodical descents or incarnations of the deity, which has become so prominent a feature of the later sectarian belief.

Under more favourable political conditions,¹ the sacerdotal class might perhaps, in course of time, have succeeded in imposing something like an effective common creed on the heterogeneous medley of races and tribes scattered over the peninsula, just as they certainly did succeed in establishing the social prerogative of their own order over the length and breadth of India. They were, however, fated to fall far short of such a consummation; and at all times orthodox Brahmanism has had to wink at, or ignore, all manner of gross superstitions and repulsive practices, along with the popular worship of countless hosts of godlings, demons, spirits and ghosts, and mystic objects and symbols of every description. Indeed, according to a recent account by a close observer of the religious practices prevalent in southern India, fully four-fifths of the people of the Dravidian race, whilst nominally acknowledging the spiritual guidance of the Brahmans, are to this day practically given over to the worship of their nondescript local village deities (*grāma-devatā*), usually attended by animal sacrifices frequently involving the slaughter, under revolting circumstances, of thousands of victims. Curiously enough these local deities are nearly all of the female, not the male sex. In the estimation of these people "Siva and Vishnu may be more dignified beings, but the village deity is regarded as a more present help in trouble, and more intimately concerned with the happiness and prosperity of the villagers. The origin of this form of Hinduism is lost in antiquity, but it is probable that it represents a pre-Aryan religion, more or less modified in various parts of south India by Brahmanical influence. At the same time, many of the deities themselves are of quite recent origin, and it is easy to observe a deity in making even at the present day."² It is a significant fact that, whilst in the worship of Siva and Vishnu, at which no animal sacrifices are offered, the officiating priests are almost invariably Brahmans, this is practically never the case at the popular performance of those "gloomy and weird rites for the propitiation of angry deities, or the driving away of evil spirits, when the pujaris (or ministrants) are drawn from all other castes, even from the Pariahs, the out-caste section of Indian society."

As from the point of view of religious belief, so also from that of social organization no clear line of demarcation can be drawn between Brahmanism and Hinduism. Though it was not till later times that the network of class divisions and subdivisions attained anything like the degree of intricacy which it shows in these latter days, still in its origin the caste-system is undoubtedly coincident with the rise of Brahmanism, and may even be said to be of the very essence of it.³ The cardinal principle which underlies the system of caste is the preservation of purity of descent, and purity of religious belief and ceremonial usage. Now, that same principle had been operative from the very dawn of the history of Aryanized India. The social organism of the Aryan tribe did not probably differ essentially from that of most communities at that primitive stage of civilization; whilst the body of the people—the *Viś* (or aggregate of *Vaiśyas*)—would be mainly occupied with agricultural and pastoral pursuits, two professional classes—those of the warrior and the priest—had already made good their claim to social distinction. As yet, however, the tribal community would still feel one in race and traditional usage. But

when the fair-coloured Aryan immigrants first came in contact with, and drove back or subdued the dark-skinned race that occupied the northern plains—doubtless the ancestors of the modern Dravidian people—the preservation of their racial type and traditional order of things would naturally become to them a matter of serious concern. In the extreme north-western districts—the Punjab and Rajputana, judging from the fairly uniform physical features of the present population of these parts—they seem to have been signally successful in their endeavour to preserve their racial purity, probably by being able to clear a sufficiently extensive area of the original occupants for themselves with their wives and children to settle upon. The case was, however, very different in the adjoining valley of the Jumna and Ganges, the sacred *Madhye-dra* or Middle-land of classical India. Here the Aryan immigrants were not allowed to establish themselves without undergoing a considerable admixture of foreign blood. It must remain uncertain whether it was that the thickly-populated character of the land scarcely admitted of complete occupation, but only of a conquest by an army of fighting men, starting from the Aryanized region—who might, however, subsequently draw women of their own kin after them—or whether, as has been suggested, a second Aryan invasion of India took place at that time through the mountainous tracts of the upper Indus and northern Kashmir, where the nature of the road would render it impracticable for the invading bands to be accompanied by women and children. Be this as it may, the physical appearance of the population of this central region of northern India—Hindustan and Behar—clearly points to an intermixture of the tall, fair-coloured, fine-nosed Aryan with the short-sized, dark-skinned, broad-nosed Dravidian; the latter type becoming more pronounced towards the lower strata of the social order.⁴ Now, it was precisely in this part of India that mainly arose the body of literature which records the gradual rise of the Brahmanical hierarchy and the early development of the caste-system.

The problem that now lay before the successful invaders was how to deal with the indigenous people, probably vastly outnumbering them, without losing their own racial identity. They dealt with them in the way the white race usually deals with the coloured race—they kept them socially apart. The land being appropriated by the conquerors, husbandry, as the most respectable industrial occupation, became the legitimate calling of the Aryan settler, the *Vaiśya*; whilst handicrafts, gradually multiplying with advancing civilization and menial service, were assigned to the subject race. The generic name applied to the latter was *Śūdra*, originally probably the name of one of the subjected tribes. So far the social development proceeded on lines hardly differing from those with which one is familiar in the history of other nations. The Indo-Aryans, however, went a step farther. What they did was not only to keep the native race apart from social intercourse with themselves, but to shut them out from all participation in their own higher aims, and especially in their own religious convictions and ceremonial practices. So far from attempting to raise their standard of spiritual life, or even leaving it to ordinary intercourse to gradually bring about a certain community of intellectual culture and religious sentiment, they deliberately set up artificial barriers in order to prevent their own traditional modes of worship from being contaminated with the obnoxious practices of the servile race. The serf, the *Śūdra*, was not to worship the gods of the Aryan freemen. The result was the system of four castes (*varṇa*, i.e. "colour"; or *jātis*, "gens"). Though the Brahman, who by this time had firmly secured his supremacy over the *kshatriya*, or noble, in matters spiritual as well as in legislative and administrative functions, would naturally be the prime mover in this regulation of the social

⁴ Thus, in Berar, "there is a strong non-Aryan leaven in the dregs of the agricultural class, derived from the primitive races which have gradually melted down into settled life, and thus become fused with the general community, while these same races are still distinct tribes in the wild tracts of hill and jungle." Sir Alfred C. Lyall, *As. St.*, i. 6.

¹ "It is, perhaps, by surveying India that we at this day can best represent to ourselves and appreciate the vast external reform worked upon the heathen world by Christianity, as it was organized and executed throughout Europe by the combined authority of the Holy Roman Empire and the Church Apostolic." Sir Alfred C. Lyall, *Asiatic Studies*, i. 2.

² Henry Whitehead, D.D., bishop of Madras, *The Village Deities of Southern India* (Madras, 1907).

³ "The effect of caste is to give all Hindu society a religious basis." Sir A. C. Lyall, *Brahmanism*.

order, there seems no reason to believe that the other two upper classes were not equally interested in seeing their hereditary privileges thus perpetuated by divine sanction. Nothing, indeed, is more remarkable in the whole development of the caste-system than the jealous pride which every caste, from the highest to the lowest, takes in its own peculiar occupation and sphere of life. The distinctive badge of a member of the three upper castes was the sacred triple cord or thread (*śāstra*)—made of cotton, hemp or wool, according to the respective caste—with which he was invested at the *upānayana* ceremony, or initiation into the use of the sacred *śāstrī*, or prayer to the sun (also called *gāyatrī*), constituting his second birth. Whilst the Arya was thus a *dvī-ja*, or twice-born, the Sudra remained unregenerate during his lifetime, his consolation being the hope that, on the faithful performance of his duties in this life, he might hereafter be born again into a higher grade of life. In later times, the strict adherence to caste duties would naturally receive considerable support from the belief in the transmigration of souls, already prevalent before Buddha's time, and from the very general acceptance of the doctrine of *karma* ("deed"), or retribution, according to which a man's present station and manner of life are the result of the sum-total of his actions and thoughts in his former existence; as his actions here will again, by the same automatic process of retribution, determine his status and condition in his next existence. Though this doctrine is especially insisted upon in Buddhism, and its designation as a specific term (Pali, *Kamma*) may be due to that creed, the notion itself was doubtless already prevalent in pre-Buddhist times. It would even seem to be necessarily and naturally implied in Brahmanical belief in metempsychosis; whilst in the doctrine of Buddha, who admits no soul, the theory of the net result or fruit of a man's actions hereafter to form or condition the existence of some new individual who will have no conscious identity with himself, seems of a peculiarly artificial and mystic character. But, be this as it may, "the doctrine of *karma* is certainly one of the firmest beliefs of all classes of Hindus, and the fear that a man shall reap as he has sown is an appreciable element in the average morality . . . the idea of forgiveness is absolutely wanting; evil done may indeed be outweighed by meritorious deeds so far as to ensure a better existence in the future, but it is not effaced, and must be atoned for" (*Census Report*, i. 364).

In spite, however, of the artificial restrictions placed on the intermarrying of the castes, the mingling of the two races seems to have proceeded at a tolerably rapid rate. Indeed, the paucity of women of the Aryan stock would probably render these mixed unions almost a necessity from the very outset; and the vaunted purity of blood which the caste rules were calculated to perpetuate can scarcely have remained of more than a relative degree even in the case of the Brahman caste. Certain it is that mixed castes are found referred to at a comparatively early period; and at the time of Buddha—some five or six centuries before the Christian era—the social organization would seem to have presented an appearance not so very unlike that of modern times. It must be confessed, however, that our information regarding the development of the caste-system is far from complete, especially in its earlier stages. Thus, we are almost entirely left to conjecture on the important point as to the original social organization of the subject race. Though doubtless divided into different tribes scattered over an extensive tract of land, the subjected aborigines were slumped together under the designation of Sudras, whose duty it was to serve the upper classes in all the various departments of manual labour, save those of a downright sordid and degrading character which it was left to *vratyas* or outcasts to perform. How, then, was the distribution of crafts and habitual occupations of all kinds brought about? Was the process one of spontaneous growth adapting an already existing social organization to a new order of things; or was it originated and perpetuated by regulation from above? Or was it rather that the status and duties of existing offices and trades came to be determined and made hereditary by some

such artificial system as that by which the Theodosian Code succeeded for a time in organizing the Roman society in the 5th century of our era? "It is well known" (says Professor Dill) "that the tendency of the later Empire was to stereotype society, by compelling men to follow the occupation of their fathers, and preventing a free circulation among different callings and grades of life. The man who brought the grain from Africa to the public stores at Ostia, the baker who made it into loaves for distribution, the butchers who brought pigs from Samnium, Lucania or Bruttium, the purveyors of wine and oil, the men who fed the furnaces of the public baths, were bound to their callings from one generation to another. It was the principle of rural serfdom applied to social functions. Every avenue of escape was closed. A man was bound to his calling not only by his father's but also by his mother's condition. Men were not permitted to marry out of their guild. If the daughter of one of the baker caste married a man not belonging to it, her husband was bound to her father's calling. Not even a dispensation obtained by some means from the imperial chancery, not even the power of the Church could avail to break the chain of servitude." It can hardly be gainsaid that these artificial arrangements bear a very striking analogy to those of the Indian caste-system; and if these class restrictions were comparatively short-lived on Italian ground, it was not perhaps so much that so strange a plant found there an ethnic soil less congenial to its permanent growth, but because it was not allowed sufficient time to become firmly rooted; for already great political events were impending which within a few decades were to lay the mighty empire in ruins. In India, on the other hand, the institution of caste—even if artificially contrived and imposed by the Indo-Aryan priest and ruler—had at least ample time allowed it to become firmly established in the social habits, and even in the affections, of the people. At the same time, one could more easily understand how such a system could have found general acceptance all over the Dravidian region of southern India, with its merest sprinkling of Aryan blood, if it were possible to assume that class arrangements of a similar kind must have already been prevalent amongst the aboriginal tribes prior to the advent of the Aryan. Whether a more intimate acquaintance with the manners and customs of those rude tribes that have hitherto kept themselves comparatively free from Hindu influences may yet throw some light on this question, remains to be seen. But, by this as it may, the institution of caste, when once established, certainly appears to have gone on steadily developing; and not even the long period of Buddhist ascendancy, with its uncompromising resistance to the Brahman's claim to being the sole arbiter in matters of faith, seems to have had any very appreciable retardant effect upon the progress of the movement. It was not only by the formation of ever new endogamous castes and sub-castes that the system gained in extent and intricacy, but even more so by the constant subdivision of the castes into numerous exogamous groups or septs, themselves often involving gradations of social status important enough to seriously affect the possibility of intermarriage, already hampered by various other restrictions. Thus a man wishing to marry his son or daughter had to look for a suitable match outside his sept, but within his caste. But whilst for his son he might choose a wife from a lower sept than his own, for his daughter, on the other hand, the law of hypergamy compelled him, if at all possible, to find a husband in a higher sept. This would naturally lead to an excess of women over men in the higher septs, and would render it difficult for a man to get his daughter respectably married without paying a high price for a suitable bridegroom and incurring other heavy marriage expenses. It can hardly be doubted that this custom has been largely responsible for the crime of female infanticide, formerly so prevalent in India; as it also probably is to some extent for infant marriages, still too common in some parts of India, especially Bengal; and even for the all but universal repugnance to the re-marriage of widows, even when these had been married in early childhood and had never joined their husbands. Yet violations of these

rules are jealously watched by the other members of the sept, and are liable—in accordance with the general custom in which communal matters are regulated in India—to be brought before a special council (*panchayat*), originally consisting of five (*pancha*), but now no longer limited to that number, since it is chiefly the greater or less strictness in the observance of caste rules and the orthodox ceremonial generally that determine the status of the sept in the social scale of the caste. Whilst community of occupation was an important factor in the original formation of non-tribal castes, the practical exigencies of life have led to considerable laxity in this respect—not least so in the case of Brahmans who have often had to take to callings which would seem altogether incompatible with the proper spiritual functions of their caste. Thus, "the prejudice against eating cooked food that has been touched by a man of an inferior caste is so strong that, although the Shastras do not prohibit the eating of food cooked by a Kshatriya or Vaiśya, yet the Brahmans, in most parts of the country, would not eat such food. For these reasons, every Hindu household—whether Brahman, Kshatriya or Sudra—that can afford to keep a paid cook generally entertains the services of a Brahman for the performance of its *cuisine*—the result being that in the larger towns the very name of Brahman has suffered a strange degradation of late, so as to mean only a cook" (Jogendra Nath Bhattacharya, *Hindu Castes and Sects*). In this caste, however, as in all others, there are certain kinds of occupation to which a member could not turn for a livelihood without incurring serious defilement. In fact, adherence to the traditional ceremonial and respectability of occupation go very much hand-in-hand. Thus, amongst agricultural castes, those engaged in vegetable-growing or market-gardening are inferior to the genuine peasant or yeoman, such as the Jat and Rajput; whilst of these the Jat who practises widow-marriage ranks below the Rajput who prides himself on his tradition of ceremonial orthodoxy—though racially there seems little, if any, difference between the two; and the Rajput, again, is looked down upon by the Babhan of Behar because he does not, like himself, scruple to handle the plough, instead of invariably employing low-caste men for this manual labour. So also when members of the Baidya, or physician, caste of Bengal, ranging next to that of the Brahman, farm land on tenure, "they will on no account hold the plough, or engage in any form of manual labour, and thus necessarily carry on their cultivation by means of hired servants" (H. H. Risley, *Census Report*).

The scale of social precedence as recognized by native public opinion is concisely reviewed (*ib.*) as revealing itself "in the facts that particular castes are supposed to be modern representatives of one or other of the original castes of the theoretical Hindu system; that Brahmans will take water from certain castes; that Brahmans of high standing will serve particular castes; that certain castes, though not served by the best Brahmans, have nevertheless got Brahmans of their own whose rank varies according to circumstances; that certain castes are not served by Brahmans at all but have priests of their own; that the status of certain castes has been raised by their taking to infant-marriage or abandoning the re-marriage of widows; that the status of others has been modified by their pursuing some occupations in a special or peculiar way; that some can claim the services of the village barber, the village palanquin-bearer, the village midwife, &c., while others cannot; that some castes may not enter the courtyards of certain temples; that some castes are subject to special taboos, such as that they must not use the village well, or may draw water only with their own vessels, that they must live outside the village or in a separate quarter, that they must leave the road on the approach of a high-caste man and must call out to give warning of their approach." . . . "The first point to observe is the predominance throughout India of the influence of the traditional system of four original castes. In every scheme of grouping the Brahman heads the list. Then come the castes whom popular opinion accepts as the modern representatives of the Kshatriyas; and these are followed by the mercantile groups supposed to be akin to the Vaiśyas. When we leave the higher circles of the twice-born, the difficulty of finding a uniform basis of classification becomes apparent. The ancient designation Sudra finds no great favour in modern times, and we can point to no group that is generally recognized as representing it. The term is used in Bombay, Madras and Bengal to denote a considerable number of castes of moderate respectability, the higher of whom are considered 'clean' Sudras, while the precise status of the lower is a question which lends itself to endless controversy."

. . . In northern and north-western India, on the other hand, "the grade next below the twice-born rank is occupied by a number of castes from whose hands Brahmans and members of the higher castes will take water and certain kinds of sweetmeats. Below these again is rather an indeterminate group from whom water is taken by some of the higher castes, not by others. Further down, where the test of water no longer applies, the status of the caste depends on the nature of its occupation and its habits in respect of diet. There are castes whose touch defiles the twice-born, but who do not commit the crowning enormity of eating beef. . . . In western and southern India the idea that the social state of a caste depends on whether Brahmans will take water and sweetmeats from its members is unknown, for the higher castes will as a rule take water only from persons of their own caste and sub-caste. In Madras especially the idea of ceremonial pollution by the proximity of an unclean caste has been developed with much elaboration. Thus the table of social precedence attached to the Cochin report shows that while a Nayar can pollute a man of a higher caste only by touching him, people of the Kammalan group, including masons, blacksmiths, carpenters and workers in leather, pollute at a distance of 24 ft., toddy-drawers at 36 ft., Pulayan or Cheruman cultivators at 48 ft., while in the case of the Paraiyan (Pariahs) who eat beef the range of pollution is no less than 64 ft."

In this bewildering maze of social grades and class distinctions, the Brahman, as will have been seen, continues to hold the dominant position, being respected and even worshipped by all the others. "The more orthodox Sudras carry their veneration for the priestly class to such a degree that they will not cross the shadow of a Brahman, and it is not unusual for them to be under a vow not to eat any food in the morning, before drinking *Bipracharanamrita*, i.e. water in which the toe of a Brahman has been dipped. On the other hand, the pride of the Brahmans is such that they do not bow to even the images of the gods worshipped in a Sudra's house by Brahman priests" (Jog. Nath Bh.). There are, however, not a few classes of Brahmans who, for various reasons, have become degraded from their high station, and formed separate castes with whom respectable Brahmans refuse to intermarry and consort. Chief amongst these are the Brahmans who minister for "unclean" Sudras and lower castes, including the makers and dealers in spirituous liquors; as well as those who officiate at the great public shrines or places of pilgrimage where they might be liable to accept forbidden gifts, and, as a matter of fact, often amass considerable wealth; and those who officiate as paid priests at cremations and funeral rites, when the wearing apparel and bedding of the deceased are not unfrequently claimed by them as their perquisites.

As regards the other two "twice-born" castes, several modern groups do indeed claim to be their direct descendants, and in vindication of their title make it a point to perform the *upanayana* ceremony and to wear the sacred thread. But though the Brahmans, too, will often acquiesce in the reasonableness of such claims, it is probably only as a matter of policy that they do so, whilst in reality they regard the other two higher castes as having long since disappeared and been merged by miscegenation in the Sudra mass. Hence, in the later classical Sanskrit literature, the term *dvija*, or twice-born, is used simply as a synonym for a Brahman. As regards the numerous groups included under the term of Sudras, the distinction between "clean" and "unclean" Sudras is of especial importance for the upper classes, inasmuch as only the former—of whom nine distinct castes are usually recognized—are as a rule considered fit for employment in household service.

The picture thus presented by Hindu society—as made up of a confused congeries of social groups of the most varied standing, each held together and kept separate from others by a traditional body of ceremonial rules and by the notion of social gradations being due to a divinely instituted order of things—finds something like a counterpart in the religious life of the people. As in the social sphere, so also in the sphere of religious belief, we find the whole scale of types represented from the lowest to the highest; and here as there, we meet with the same failure of welding the confused mass into a well-ordered whole. In their theory of a triple manifestation of an impersonal deity, the Brahmanical theologians, as we have seen, had indeed elaborated a doctrine which might have seemed to form a reasonable, authoritative creed for

a community already strongly imbued with pantheistic notions; yet, at best, that creed could only appeal to the sympathies of a comparatively limited portion of the people. Indeed, the sacerdotal class themselves had made its universal acceptance an impossibility, seeing that their laws, by which the relations of the classes were to be regulated, aimed at permanently excluding the entire body of aboriginal tribes from the religious life of their Aryan masters. They were to be left for all time coming to their own traditional idolatrous notions and practices. However, the two races could not, in the nature of things, be permanently kept separate from each other. Indeed, even prior to the definite establishment of the caste-system, the mingling of the lower race with the upper classes, especially with the aristocratic landowners and still more so with the yeomanry, had probably been going on to such an extent as to have resulted in two fairly well-defined intermediate types of colour between the priestly order and the servile race and to have facilitated the ultimate division into four "colours" (*varna*). In course of time the process of intermingling, as we have seen, assumed such proportions that the priestly class, in their pride of blood, felt naturally tempted to recognize, as of old, only two "colours," the Aryan Brahman and the non-Aryan Sudra. Under these conditions the religious practices of the lower race could hardly have failed in the long run to tell seriously upon the spiritual life of the lay body of the Brahmanical community. To what extent this may have been the case, our limited knowledge of the early phases of the sectarian worship of the people does not enable us to determine. But, on the other hand, the same process of racial intermixture also tended to gradually draw the lower race more or less under the influence of the Brahmanical forms of worship, and thus contributed towards the shaping of the religious system of modern Hinduism. The grossly idolatrous practices, however, still so largely prevalent in the Dravidian South, show how superficial, after all, that influence has been in those parts of India where the admixture of Aryan blood has been so slight as to have practically had no effect on the racial characteristics of the people. These present-day practices, and the attitude of the Brahman towards them, help at all events to explain the aversion with which the strange rites of the subjected tribes were looked upon by the worshippers of the Vedic pantheon. At the same time, in judging the apparently inhuman way in which the Sudras were treated in the caste rules, one has always to bear in mind the fact that the belief in metempsychosis was already universal at the time, and seemed to afford the only rational explanation of the apparent injustice involved in the unequal distribution of the good things in this world; and that, if the Sudra was strictly excluded from the religious rites and beliefs of the superior classes, this exclusion in no way involved the question of his ultimate emancipation and his union with the Infinite Spirit, which were as certain in his case as in that of any other sentient being. What it did make impossible for him was to attain that union immediately on the cessation of his present life, as he would first have to pass through higher and purer stages of mundane existence before reaching that goal; but in this respect he only shared the lot of all but a very few of the saintliest in the higher spheres of life, since the ordinary twice-born would be liable to sink, after his present life, to grades yet lower than that of the Sudra.

To what extent the changes, which the religious belief of the Aryan classes underwent in post-Vedic times, may have been due to aboriginal influences is a question not easily answered, though the later creeds offer only too many features in which one might feel inclined to suspect influences of that kind. The literary documents, both in Sanskrit and Pali, dating from about the time of Buddha onwards—particularly the two epic poems, the *Mahabharata* and *Ramayana*—still show us in the main the *personnel* of the old pantheon; but the character of the gods has changed; they have become anthropomorphized and almost purely mythological figures. A number of the chief gods, sometimes four, but generally eight of them, now appear as *lokapalas* or world-guardians, having definite quarters or intermediate quarters of the compass assigned to them as their

special domains. One of them, Kubera, the god of wealth, is a new figure; whilst another, Varuna, the most spiritual and ethical of Vedic deities—the king of the gods and the universe; the nightly, star-spangled firmament—has become the Indian Neptune, the god of waters. Indra, their chief, is virtually a kind of superior raja, residing in *svarga*, and as such is on visiting terms with earthly kings, driving about in mid-air with his charioteer Matali. As might happen to any earth-lord, Indra is actually defeated in battle by the son of the demon-king of Lanka (Ceylon), and kept there a prisoner till ransomed by Brahma and the gods conferring immortality on his conqueror. A quaint figure in the pantheon of the heroic age is Hanuman, the deified chief of monkeys—probably meant to represent the aboriginal tribes of southern India—whose wonderful exploits as Rama's ally on the expedition to Lanka Indian audiences will never weary of hearing recounted. The Gandharvas figure already in the Veda, either as a single divinity, or as a class of genii, conceived of as the body-guard of Soma and as connected with the moon. In the later Vedic times they are represented as being fond of and dangerous to, women; the Apsaras, apparently originally water-nymphs, being closely associated with them. In the heroic age the Gandharvas have become the heavenly minstrels plying their art at Indra's court, with the Apsaras as their wives or mistresses. These fair damsels play, however, yet another part, and one far from complimentary to the dignity of the gods. In the epics considerable merit is attached to a life of seclusion and ascetic practices by means of which man is considered capable of acquiring supernatural powers equal or even superior to those of the gods—a notion perhaps not unnaturally springing from the pantheistic conception. Now, in cases of danger being threatened to their own ascendancy by such practices, the gods as a rule proceed to employ the usually successful expedient of despatching some lovely nymph to lure the saintly men back to worldly pleasures. Seeing that the epic poems, as repeated by professional reciters, either in their original Sanskrit text, or in their vernacular versions, as well as dramatic compositions based on them, form to this day the chief source of intellectual enjoyment for most Hindus, the legendary matter contained in these heroic poems, however marvellous and incredible it may appear, still enters largely into the religious convictions of the people. "These popular recitals from the Ramayan are done into Gujarati in easy, flowing narrative verse . . . by Premanand, the sweetest of our bards. They are read out by an intelligent Brahman to a mixed audience of all classes and both sexes. It has a perceptible influence on the Hindu character. I believe the remarkable freedom from infidelity which is to be seen in most Hindu families, in spite of their strange gregarious habits, can be traced to that influence; and little wonder" (B. M. Malabar, *Gujarat and the Gujaratis*). Hence also the universal reverence paid to serpents (*naga*) since those early days; though whether it simply arose from the superstitious dread inspired by the insidious reptile so fatal to man in India, or whether the verbal coincidence with the name of the once-powerful non-Aryan tribe of Nagas had something to do with it must remain doubtful. Indian myth represents them as a race of demons sprung from Kadru, the wife of the sage Kasyapa, with a jewel in their heads which gives them their sparkling look; and inhabiting one of the seven beautiful worlds below the earth (and above the hells), where they are ruled over by three chiefs or kings, Sessa, Vasuki and Takshaka; their fair daughters often entering into matrimonial alliances with men, like the mermaids of western legend.

In addition to such essentially mythological conceptions, we meet in the religious life of this period with an element of more serious aspect in the two gods, on one or other of whom the religious fervour of the large majority of Hindus has ever since concentrated itself, viz. Vishnu and Siva. Both these divine figures have grown out of Vedic conceptions—the genial Vishnu mainly out of a not very prominent solar deity of the same name; whilst the stern Siva, i.e. the kind or gracious one—doubtless a euphemistic name—has his prototype in the old fierce

storm-god Rudra, the "Roarer," with certain additional features derived from other deities, especially Pushan, the guardian of flocks and bestower of prosperity, worked up therewith. The exact process of the evolution of the two deities and their advance in popular favour are still somewhat obscure. In the epic poems which may be assumed to have taken their final shape in the early centuries before and after the Christian era, their popular character, so strikingly illustrated by their inclusion in the Brahmanical triad, appears in full force; whilst their cult is likewise attested by the coins and inscriptions of the early centuries of our era. The co-ordination of the two gods in the Trimurti does not by any means exclude a certain rivalry between them; but, on the contrary, a supreme position as the true embodiment of the Divine Spirit is claimed for each of them by their respective votaries, without, however, an honourable, if subordinate, place being refused to the rival deity, wherever the latter, as is not infrequently the case, is not actually represented as merely another form of the favoured god. Whilst at times a truly monotheistic fervour manifests itself in the adoration of these two gods, the polytheistic instincts of the people did not fail to extend the pantheon by groups of new deities in connexion with them. Two of such new gods actually pass as the sons of Siva and his consort Parvati, viz. Skanda—also called Kumara (the youth), Kartikeya, or Subrahmanya (in the south)—the six-headed war-lord of the gods; and Ganese, the lord (or leader) of Siva's troops of attendants, being at the same time the elephant-headed, paunch-bellied god of wisdom; whilst a third, Kama (Kamadeva) or Kandarpa, the god of love, gets his popular epithet of Ananga, "the bodiless," from his having once, in frolicsome play, tried the power of his arrows upon Siva, whilst engaged in austere practices, when a single glance from the third (forehead) eye of the angry god reduced the mischievous urchin to ashes. For his chief attendant, the great god (Mahadeva, Mahesvara) has already with him the "holy" Nandi—presumably, though his shape is not specified, identical in form as in name with Siva's sacred bull of later times, the appropriate symbol of the god's reproductive power. But, in this respect, we also meet in the epics with the first clear evidence of what in after time became the prominent feature of the worship of Siva and his consort all over India, viz. the feature represented by the *linga*, or phallic symbol.

As regards Vishnu, the epic poems, including the supplement to the Mahabharata, the Hariavamsa, supply practically the entire framework of legendary matter on which the later Vaishnava creeds are based. The theory of Avatars which makes the deity—also variously called Narayana, Purushottama, or Vasudeva—periodically assume some material form in order to rescue the world from some great calamity, is fully developed; the ten universally recognized "descents" being enumerated in the larger poem. Though Siva, too, assumes various forms, the incarnation theory is peculiarly characteristic of Vaishnavism; and the fact that the principal hero of the Ramayana (Rama), and one of the prominent warriors of the Mahabharata (Krishna) become in this way identified with the supreme god, and remain to this day the chief objects of the adoration of Vaishnava sectaries, naturally imparts to these creeds a human interest and sympathetic aspect which is wholly wanting in the worship of Siva. It is, however, unfortunately but too true that in some of these creeds the devotional ardour has developed features of a highly objectionable character.

Even granting the reasonableness of the triple manifestation of the Divine Spirit, how is one to reconcile all these idolatrous practices, this worship of countless gods and godlings, demons and spirits indwelling in every imaginable object round about us, with the pantheistic doctrine of the *Ekam Advityam*, "the One without a Second"? The Indian theologian would doubtless have little difficulty in answering that question. For him there is only the One Absolute Being, the one reality that is all in all; whilst all the phenomenal existences and occurrences that crowd upon our senses are nothing more than an illusion of the individual soul estranged for a time from its divine source—an illusion only to be dispelled in the end by the soul's fuller knowledge of its own true nature and its being one with the eternal fountain of blissful being. But

to the man of ordinary understanding, unused to the rarefied atmosphere of abstract thought, this conception of a transcendental, impersonal Spirit and the unreality of the phenomenal world can have no meaning: what he requires is a deity that stands in intimate relation to things material and to all that affects man's life. Hence the exoteric theory of manifestations of the Supreme Spirit, and that not only the manifestations implied in the triad of gods representing the cardinal processes of mundane existence—creation, preservation, and destruction or regeneration—but even such as would tend to supply a rational explanation for superstitious imaginings of every kind. For "the Indian philosophy does not ignore or hold aloof from the religion of the masses: it underlies, supports and interprets their polytheism. This may be accounted the keystone of the fabric of Brahmanism, which accepts and even encourages the rudest forms of idolatry, explaining everything by giving it a higher meaning. It treats all the worships as outward, visible signs of some spiritual truth, and is ready to show how each particular image or rite is the symbol of some aspect of universal divinity. The Hindus, like the pagans of antiquity, adore natural objects and forces—a mountain, a river or an animal. The Brahmas holds all nature to be the vesture or cloak of indwelling, divine energy, which inspires everything that produces awe or passes man's understanding" (Sir Alfred C. Lyall, *Brahminism*).

During the early centuries of our era, whilst Buddhism, where countenanced by the political rulers, was still holding its own by the side of Brahmanism, sectarian belief in the Hindu gods seems to have made steady progress. The caste-^{Sectarianism.} system, always calculated to favour unity of religious practice within its social groups, must naturally have contributed to the advance of sectarianism. Even greater was the support it received later on from the Puranas, a class of poetical works of a partly legendary, partly discursive and controversial character, mainly composed in the interest of special deities, of which eighteen principal (*maha-purana*) and as many secondary ones (*sma-purana*) are recognized, the oldest of which may go back to about the 4th century of our era. It was probably also during this period that the female element was first definitely admitted to a prominent place amongst the divine objects of sectarian worship, in the shape of the wives of the principal gods viewed as their *sakti*, or female energy, theoretically identified with the *Maya*, or cosmic illusion, of the idealistic Vedanta, and the *Prakriti*, or plastic matter, of the materialistic Sankhya philosophy, as the primary source of mundane things. The consubstantial relations of the deities may thus be considered "to typify the mystical union of the two eternal principles, spirit and matter, for the production and reproduction of the universe." But whilst this privilege of divine worship was claimed for the consorts of all the gods, it is principally to Siva's consort, in one or other of her numerous forms, that adoration on an extensive scale came to be offered by a special sect of votaries, the *Saktas*.

In the midst of these conflicting tendencies, an attempt was made, about the latter part of the 8th century, by the distinguished Malabar theologian and philosopher Sankara Acharya to restore the Brahmanical creed to something like its pristine purity, and thus once more^{Sankara.} to bring about a uniform system of orthodox Hindu belief. Though himself, like most Brahmans, apparently by predilection a follower of Siva, his aim was the revival of the doctrine of the Brahma as the one self-existent Being and the sole cause of the universe; coupled with the recognition of the practical worship of the orthodox pantheon, especially the gods of the Trimurti, as manifestations of the supreme deity. The practical result of his labours was the foundation of a new sect, the *Smartas*, i.e. adherents of the *smritis* or tradition, which has a numerous following amongst southern Brahmans, and, whilst professing Sankara's doctrines, is usually classed as one of the Saiva sects, its members adopting the horizontal sectarian mark peculiar to Saivas, consisting in their case of a triple line, the *tripundra*, prepared from the ashes of burnt cow-dung and painted on the forehead. Sankara also founded four Mathas, or convents, for Brahmans; the chief one being that of Sringeri in Mysore, the spiritual head (*Guru*) of which wields considerable power, even that of excommunication, over the Saivas of southern India. In northern India, the professed followers of Sankara are mainly limited to certain classes of mendicants

and ascetics, although the tenets of this great Vedanta teacher may be said virtually to constitute the creed of intelligent Brahmins generally.

Whilst Sankara's chief title to fame rests on his philosophical works, as the upholder of the strict monistic theory of Vedanta, he doubtless played an important part in the partial remodelling of the Hindu system of belief at a time when Buddhism was rapidly losing ground in India. Not that there is any evidence of Buddhists ever having been actually persecuted by the Brahmins, or still less of Sankara himself ever having done so; but the traditional belief in some personal god, as the principal representative of an invisible, all-pervading deity, would doubtless appeal more directly to the minds and hearts of the people than the colourless ethical system promulgated by the Sakya saint. Nor do Buddhist places of worship appear as a rule to have been destroyed by Hindu sectaries, but they seem rather to have been taken over by their own religious uses; at any rate there are to this day not a few Hindu shrines, especially in Bengal, dedicated to Dharmaraj, "the prince of righteousness," as the Buddha is commonly styled. That the tenets and practices of so characteristic a faith as Buddhism, so long prevalent in India, cannot but have left their marks on Hindu life and belief may readily be assumed, though it is not so easy to lay one's finger on the precise features that might seem to betray such an influence. If the general tenderness towards animals, based on the principle of *ahimsa*, or inflicting no injury on sentient beings, be due to Buddhist teaching, that influence must have made itself felt at a comparatively early period, seeing that sentiments of a similar nature are repeatedly urged in the Code of Manu. Thus, in v. 46-48. "He who does not willingly cause the pain of confinement and death to living beings, but desires the good of all, obtains endless bliss. He who injures no creature obtains without effort what he thinks of, what he strives for, and what he fixes his mind on. Flesh-meat cannot be procured without injury to animals, and the slaughter of animals is not conducive to heavenly bliss; from flesh-meat, therefore, let man abstain." Moreover, in view of the fact that Jainism, which originated about the same time as Buddhism, inculcates the same principle, even to an extravagant degree, it seems by no means improbable that the spirit of kindness towards living beings generally was already widely diffused among the people when these new doctrines were promulgated. To the same tendency doubtless is due the gradual decline and ultimate discontinuance of animal sacrifices by all sects except the extreme branch of Sakti-worshippers. In this respect, the veneration shown to serpents and monkeys has, however, to be viewed in a somewhat different light, as having a mythical background; whilst quite a special significance attaches to the sacred character assigned to the cow by all classes of Hindus, even those who are not prepared to admit the claim of the Brahman to the exalted position of the earthly god usually conceded to him. In the Veda no tendency shows itself as yet towards rendering divine honour to the cow; and though the importance assigned her in an agricultural community is easily understood, still the exact process of her deification and her identification with the mother earth in the time of Manu and the epics requires further elucidation. An idealized type of the useful quadruped—likewise often identified with the earth—presents itself in the mythical Cow of Plenty, or "wish-cow" (Kamadhenu, or Kamadughā, i.e. wish-milker), already appearing in the Atharvaveda, and in epic times assigned to Indra, or identified with Surabhi, "the fragrant," the sacred cow of the sage Vasishtha. Possibly the growth of the legend of Krishna—his being reared at Gokula (cow-station); his tender relations to the *gopis*, or cow-herdresses, of Vrindavana; his epithets *Gopala*, "the cowherd," and *Govinda*, "cow-finder," actually explained as "recoverer of the earth" in the great epic, and the *go-lekha*, or "cow-world," assigned to him as his heavenly abode—may have some connexion with the sacred character ascribed to the cow from early times.

Since the time of Sankara, or for more than a thousand years, the gods Vishnu and Siva, or *Hari* and *Hara* as they are also commonly called—with their wives, especially that of the latter god—have shared between them the practical worship of the vast majority of Hindus. But, though the people have thus been divided between two different religious camps, sectarian animosity has upon the whole kept within reasonable limits. In fact, the respectable Hindu, whilst owing special allegiance to one of the two gods as his *ishṭa devatā* (favourite deity), will not withhold his tribute of adoration from the other gods of the pantheon. The high-caste Brahman will probably keep at his home a śīlagrām stone, the favourite symbol of Vishnu, as well as the characteristic emblems of Siva and his consort, to both of which he will do reverence in the morning; and when he visits some holy place of pilgrimage, he will not fail to pay his homage at both the Śaiva and the Vaishnava shrines there. Indeed, "sectarian bigotry and exclusiveness are to be found chiefly among the professional leaders of the

modern brotherhoods and their low-caste followers, who are taught to believe that theirs are the only true gods, and that the rest do not deserve any reverence whatever" (Jog. Nath). The same spirit of toleration shows itself in the celebration of the numerous religious festivals. Whilst some of these—e.g. the *Sankranti* (called *Pongal*, i.e. "boiled rice," in the south), which marks the entrance of the sun into the sign of Capricorn and the beginning of its northward course (*uttarayana*) on the 1st day of the month Māgha (c. Jan. 12); the *Gaṇeśa-caturthī*, or 4th day of the light fortnight of Bhādra (August–September), considered the birthday of Ganesa, the god of wisdom; and the *Holi*, the Indian Saturnalia in the month of Phālguna (February to March)—have nothing of a sectarian tendency about them; others again, which are of a distinctly sectarian character—such as the *Krishna-jannmāshṭami*, the birthday of Krishna on the 8th day of the dark half of Bhādra, or (in the south) of Śrāvāṇa (July–August), the *Durgapuja* and the *Dīpanolī*, or lamp feast, celebrating Krishna's victory over the demon Narakasura, on the last two days of Āśvina (September–October)—are likewise observed and heartily joined in by the whole community irrespective of sect. Widely different, however, as is the character of the two leading gods, are also the modes of worship practised by their votaries.

Siva has at all times been the favourite god of the Brahmins,¹ and his worship is accordingly more widely extended than that of his rival, especially in southern India. Indeed there is hardly a village in India which cannot boast of a shrine dedicated to Siva, and containing the emblem of his reproductive power; for almost the only form in which the "Great God" is adored is the *Linga*, consisting usually of an upright cylindrical block of marble or other stone, mostly resting on a circular perforated slab. The mystic nature of these emblems seems, however, to be but little understood by the common people; and, as H. H. Wilson remarks, "notwithstanding the acknowledged purport of this worship, it is but justice to state that it is unattended in Upper India by any indecent or indelicate ceremonies, and it requires a rather lively imagination to trace any resemblance in its symbols to the objects they are supposed to represent." In spite, however, of its wide diffusion, and the vast number of shrines dedicated to it, the worship of Siva has never assumed a really popular character, especially in northern India, being attended with scarcely any solemnity or display of emotional spirit. The temple, which usually stands in the middle of a court, is as a rule a building of very moderate dimensions, consisting either of a single square chamber, surmounted by a pyramidal structure, or of a chamber for the *linga* and a small vestibule. The worshipper, having first circumambulated the shrine as often as he pleases, keeping it at his right-hand side, steps up to the threshold of the sanctum, and presents his offering of flowers or fruit, which the officiating priest receives; he then prostrates himself, or merely lifts his hands—joined so as to leave a hollow space between the palms—to his forehead, muttering a short prayer, and takes his departure. Amongst the many thousands of *Lingas*, twelve are usually regarded as of especial sanctity, one of which, that of Somnath in Gujarat, where Siva is worshipped as "the lord of Soma," was, however, shattered by Mahmud of Ghazni; whilst another, representing Siva as *Vishvanara*, or "Lord of the Universe," is the chief object of adoration at Benares, the great centre of Siva-worship. The Śaivas of southern India, on the other hand, single out as peculiarly sacred five of their temples which are supposed to enshrine as many characteristic aspects (*linga*) of the god in the form of the five elements, the most holy of these being the shrine of Chidambaram (i.e. "thought-ether") in S. Arcot, supposed to contain the ether-*linga*. According to Pandit S. M. Natesa (*Hindu Feasts, Fasts and Ceremonies*), "the several forms of the god Siva in these sacred shrines are considered to be the bodies or casements of the soul, whose

¹ Siva is said to have first appeared in the beginning of the present age as Sveta, the White, for the purpose of benefitting the Brahmins, and he is invariably painted white; whilst Vishnu, when pictured, is always of a dark-blue colour.

natural bases are the five elements—earth, water, fire, air and ether. The apprehension of God in the last of these five as ether is, according to the Saiva school of philosophy, the highest form of worship, for it is not the worship of God in a tangible form, but the worship of what, to ordinary minds, is vacuum, which nevertheless leads to the attainment of a knowledge of the all-pervading without physical accessories in the shape of any linga, which is, after all, an emblem. That this is the case at Chidambaram is known to every Hindu, for if he ever asks the priests to show him the God in the temple he is pointed to an empty space in the holy of holies, which has been termed the Akasa, or ether-linga." But, however congenial this refined symbolism may be to the worshipper of a speculative turn of mind, it is difficult to see how it could ever satisfy the religious wants of the common man little given to abstract conceptions of this kind.

From early times, detachment from the world and the practice of austerities have been regarded in India as peculiarly conducive to a spirit of godliness, and ultimately to a state of ecstatic communion with the deity. On these grounds it was actually laid down as a rule for a man solicitous for his spiritual welfare to pass the last two of the four stages (*āśrama*) of his life in such conditions of renunciation and self-restraint. Though there is hardly a sect which has not contributed its share to the element of religious mendicancy and asceticism so prevalent in India, it is in connexion with the Siva-cult that these tendencies have been most extensively cultivated. Indeed, the personality of the stern God himself exhibits this feature in a very marked degree, whence the term *mahāyogi* or "great ascetic" is often applied to him.

Of Saiva mendicant and ascetic orders, the members of which are considered more or less followers of Sankara Acharya, the following may be mentioned: (1) *Dandīs*, or staff-bearers, who carry a wand with a piece of red cloth, containing the sacred cord, attached to it, and also wear one or more pieces of cloth of the same colour. They worship Siva in his form of Bhairava, the "terrible." A sub-section of this order are the *Dandi Dasnamis*, or *Dandi* of ten names, so called from their assuming one of the names of Sankara's four disciples, and six of their pupils. (2) *Yogis* (or popularly, *Jogis*), i.e. adherents of the Yoga philosophy and the system of ascetic practices enjoined by it with the view of mental abstraction and the supposed attainment of superhuman powers—practices which, when not merely pretended, but rigidly carried out, are only too apt to produce vacuity of mind and wild fits of frenzy. In these degenerate days their supernatural powers consist chiefly in conjuring, sooth-saying, and feats of jugglery, by which they seldom fail in imposing upon a credulous public. (3) *Sannyāsīs*, devotees who "renounce" earthly concerns, an order not confined either to the Brahmanical caste or to the Saiva persuasion. Those of the latter are in the habit of smearing their bodies with ashes, and wearing a tiger-skin and a necklace or rosary of *rudraksha* berries (Elaeocarpus Ganitrus, lit. "Rudra's eye"), sacred to Siva, and allowing their hair to grow till it becomes matted and filthy. (4) *Parāma-hamsas*, i.e. "supreme geese (or swans)," a term applied to the world-soul with which they claim to be identical. This is the highest order of asceticism, members of which are supposed to be solely engaged in meditating on the Brahma, and to be "equally indifferent to pleasure or pain, insensible of heat or cold, and incapable of satiety of want." Some of them go about naked, but the majority are clad like the *Dandīs*. (5) *Aghora Pantīs*, a vile and disreputable class of mendicants, now rarely met with. Their filthy habits and disgusting practices of gross promiscuous feeding, even to the extent of eating offal and dead men's flesh, look almost like a direct repudiation of the strict Brahmanical code of ceremonial purity and cleanliness, and of the rules regulating the matter and manner of eating and drinking; and they certainly make them objects of loathing and terror wherever they are seen.

On the general effect of the manner of life led by *Sādhus* or "holy men," a recent observer (J. C. Oman, *Mystics, Ascetics and Sainis of India*, p. 273) remarks: "*Sādhusm*; whether perpetuating the peculiar idea of the efficiency of austerities for the acquisition of far-reaching powers over natural phenomena, or bearing its testimony to the belief in the indispensableness of detachment from the world as a preparation for the ineffable joy of ecstatic communion with the Divine Being, has undoubtedly tended to keep before men's eyes, as the highest ideal, a life of purity, self-restraint, and contempt of the world and human affairs. It has also necessarily maintained amongst the laity a sense of the righteous claims of the poor upon the charity of the more affluent members of the community. Moreover, *sādhusm*, by the multiplicity of the independent sects which have arisen in India, has engendered and

favoured a spirit of tolerance which cannot escape the notice of the most superficial observer."

An independent Saiva sect, or, indeed, the only strictly Saiva sect, are the *Vīra Saivas*, more commonly called *Lingavats* (popularly *Lingaitis*) or *Lingavats*, from their practice of wearing on their person a phallic emblem of Siva, made of copper or silver, and usually enclosed in a case suspended from the neck by a string. Apparently from the movable nature of their badge, their *Gurus* are called *Jangamas* ("movable"). This sect counts numerous adherents in southern India; the Census Report of 1901 recording nearly a million and a half, including some 70 or 80 different, mostly endogamous, castes. The reputed founder, or rather reformer, of the sect was Basava (or Basaba), a Brahman of the Belgaum district who seems to have lived in the 11th or 12th century. According to the Basava-purāna he early in life renounced his caste and went to reside at Kalyana, then the capital of the Chalukya kingdom, and later on at Sangamesvara near Ratnagiri, where he was initiated into the Vīra Saiva faith which he subsequently made it his life's work to propagate. His doctrine, which may be said to constitute a kind of reaction against the severe sacerdotalism of Sankara, has spread over all classes of the southern community, most of the priests of Saiva temples there being adherents of it; whilst in northern India its votaries are only occasionally met with, and then mostly as mendicants, leading about a neatly caparisoned bull as representing Siva's sacred bull *Nandi*. Though the Lingavats still show a certain animosity towards the Brahmans, and in the Census lists are accordingly classes as an independent group beside the Hindus, still they can hardly be excluded from the Hindu community, and are sure sooner or later to find their way back to the Brahmanical fold.

Vishnu, whilst less popular with Brahmans than his rival, has from early times proved to the lay mind a more attractive object of adoration on account of the genial and, so to speak, romantic character of his mythical personality. It is not, however, so much the original figure of the god himself that enlists the sympathies of his adherents as the additional elements it has received through the theory of periodical "descents" (*avatāras*) or incarnations applied to this deity. Whilst the Saiva philosophers do not approve of the notion of incarnations, as being derogatory to the dignity of the deity, the Brahmans have nevertheless thought fit to adopt it as apparently a convenient expedient for bringing certain tendencies of popular worship within the pale of their system, and probably also for counteracting the Buddhist doctrines; and for this purpose Vishnu would obviously offer himself as the most attractive figure in the Brahmanical trinity. Whether the incarnation theory started from the original solar nature of the god suggestive of regular visits to the world of men, or in what other way it may have originated, must remain doubtful. Certain, however, it is that at least one of his Avatars is clearly based on the Vedic conception of the sun-god, viz. that of the dwarf who claims as much ground as he can cover by three steps, and then gains the whole universe by his three mighty strides. Of the ten or more Avatars, assumed by different authorities, only two have entered to any considerable extent into the religious worship of the people, viz. those of *Rama* (or Ramachandra) and *Krishna*, the favourite heroes of epic romance. That these two figures would appeal far more strongly to the hearts and feelings of the people, especially the warlike Kshatriyas,¹ than the austere Siva is only what might have been expected; and, indeed, since the time of the epics their cult seems never to have lacked numerous adherents. But, on the other hand, the essentially human nature of these two gods

¹ As in the case of Siva's traditional white complexion, it may not be without significance, from a racial point of view, that Vishnu, Rama and Krishna have various darker shades of colour attributed to them, viz. blue, hyacinthine, and dark azure or dark brown respectively. The names of the two heroes meaning simply "black" or "dark," the blue tint may originally have belonged to Vishnu, who is also called *pīlavas*, dressed in yellow garment, i.e. the colours of sky and sun combined.

would naturally tend to modify the character of the relations between worshipper and worshipped, and to impart to the modes and forms of adoration features of a more popular and more human kind. And accordingly it is exactly in connexion with these two incarnations of Vishnu, especially that of Krishna, that a new spirit was infused into the religious life of the people by the sentiment of fervent devotion to the deity, as it found expression in certain portions of the epic poems, especially the *Bhagavadgita*, and in the *Bhagavatapurana* (as against the more orthodox Vaishnava works of this class such as the *Vishnupurana*), and was formulated into a regular doctrine of faith in the *Sandilya-sutra*, and ultimately translated into practice by the Vaishnava reformers.

The first successful Vaishnava reaction against Sankara's reconstructed creed was led by Ramanuja, a southern Brahman of the 12th century. His followers, the Ramanujas, or Sri-Vaishnavas as they are usually called, worship Vishnu (Narayana) with his consort Sri or Lakshmi (the goddess of beauty and fortune), or their incarnations Rama with Sita and Krishna with Rukmini. Ramanuja's doctrine, which is especially directed against the Linga-worship, is essentially based on the tenets of an old Vaishnava sect, the Bhagavatas or Pancharatras, who worshipped the Supreme Being under the name of Vasudeva (subsequently identified with Krishna, as the son of Vasudeva, who indeed is credited by some scholars with the foundation of that monotheistic creed). The sectarian mark of the Ramanujas resembles a capital U (or, in the case of another division, a Y), painted with a white clay called gopichandana, between the hair and the root of the nose, with a red or yellow vertical stroke (representing the female element) between the two white lines. They also usually wear, like all Vaishnavas, a necklace of *tulasi*, or basil wood, and a rosary of seeds of the same shrub or of the lotus. Their most important shrines are those of Srirangam near Trichinopoly, Mallikote in Mysore, Dvaraka (the city of Krishna) on the Kathiawar coast, and Jagannath in Orissa; all of them decorated with Vishnu's emblems, the tulasi plant and salagram stone. The Ramanuja Brahmans are most punctilious in the preparation of their food and in regard to the privacy of their meals, before taking which they have to bathe and put on woollen or silk garments. Whilst Sankara's mendicant followers were prohibited to touch fire and had to subsist entirely on the charity of Brahman householders, Ramanuja, on the contrary, not only allowed his followers to use fire, but strictly forbade their eating any food cooked, or even seen, by a stranger. On the speculative side, Ramanuja also met Sankara's strictly monistic theory by another recognizing Vishnu as identical with Brahma as the Supreme Spirit animating the material world as well as the individual souls which have become estranged from God through unbelief, and can only attain again conscious union with him through devotion or love (*bhakti*). His tenets are expounded in various works, especially in his commentaries on the Vedanta-sutras and the *Bhagavadgita*. The followers of Ramanuja have split into two sects, a northern one, recognizing the Vedas as their chief authority, and a southern one, basing their tenets on the *Nalayir*, a Tamil work of the Upanishad order. In point of doctrine, they differ in their view of the relation between God Vishnu and the human soul; whilst the former sect define it by the *ape* theory, which makes the soul cling to God as the young ape does to its mother, the latter explain it by the *cat* theory, by which Vishnu himself seizes and rescues the souls as the mother cat does her young ones.

Madhva Acharya, another distinguished Vedanta teacher and founder of a Vaishnava sect, born in Kanara in A.D. 1190, was less intolerant of the Linga cult than Ramanuja, but seems rather to have aimed at a reconciliation of the Saiva and Vaishnava forms of worship. The *Madhvas* or *Madhvaccharis* favour Krishna and his consort as their special objects of adoration, whilst images of Siva, Parvati, and their son Ganesa are, however, likewise admitted and worshipped in some of their temples, the most important of which is at Udipi in South Kanara, with eight monasteries connected with it.

This shrine contains an image of Krishna which is said to have been rescued from the wreck of a ship which brought it from Dvaraka, where it was supposed to have been set up of old by no other than Krishna's friend Arjuna, one of the five Pandava princes. Followers of the Madhva creed are but rarely met with in Upper India. Their sectarian mark is like the U of the Sri-Vaishnavas, except that their central line is black instead of red or yellow. Madhva—who after his initiation assumed the name Anandatirtha—composed numerous Sanskrit works, including commentaries on the Brahma sutras (i.e. the Vedanta aphorisms), the Gita, the Rigveda and many Upanishads. His philosophical theory was a dualistic one, postulating distinctness of nature for the divine and the human soul, and hence independent existence, instead of absorption, after the completion of mundane existence.

The Ramanandis or Ramavats (popularly Ramats) are a numerous northern sect of similar tenets to those of the Ramanujas. Indeed its founder, Ramananda, who probably flourished in the latter part of the 14th century, according to the traditional account, was originally a Sri-Vaishnava monk, and, having come under the suspicion of laxity in observing the strict rules of food during his peregrinations, and been ordered by his superior (Mahant) to take his meals apart from his brethren, left the monastery in a huff and set up a schismatic math of his own at Benares. The sectarian mark of his sect differs but slightly from that of the parent stock. The distinctive features of their creed consist in their making Rama and Sita, either singly or conjointly, the chief objects of their adoration, instead of Vishnu and Lakshmi, and their attaching little or no importance to the observance of privacy in the cooking and eating of their food. Their mendicant members, usually known as Vairagis, are, like the general body of the sect, drawn from all castes without distinction. Thus, the founder's twelve chief disciples include, besides Brahmans, a weaver, a currier, a Rajput, a Jat and a barber—for, they argue, seeing that Bhagavan, the Holy One (Vishnu), became incarnate even in animal form, a Bhakta (believer) may be born even in the lowest of castes. Ramananda's teaching was thus of a distinctly levelling and popular character; and, in accordance therewith, the Bhakta-mata and other authoritative writings of the sect are composed, not in Sanskrit, but in the popular dialects. A follower of this creed was the distinguished poet Tulsiidas, the composer of the beautiful Hindi version of the Ramayana and other works which "exercise more influence upon the great body of Hindu population than the whole voluminous series of Sanskrit composition" (H. H. Wilson).

The traditional list of Ramananda's immediate disciples includes the name of Kabir, the weaver, a remarkable man who would accordingly have lived in the latter part of the 15th century, and who is claimed by both Hindus and Moslems as having been born within their fold. The story goes that, having been deeply impressed by Ramananda's teaching, he sought to attach himself to him; and, one day at Benares, in stepping down the ghat at daybreak to bathe in the Ganges, and putting himself in the way of the teacher, the latter, having inadvertently struck him with his foot, uttered his customary exclamation "Ram Ram," which, being also the initiatory formula of the sect, was claimed by Kabir as such, making him Ramananda's disciple. Be this as it may, Kabir's own reformatory activity lay in the direction of a compromise between the Hindu and the Mahomedan creeds, the religious practices of both of which he criticized with equal severity. His followers, the Kabir Panthis ("those following Kabir's path"), though neither worshipping the gods of the pantheon, nor observing the rites and ceremonial of the Hindus, are nevertheless in close touch with the Vaishnava sects, especially the Ramavats, and generally worship Rama as the supreme deity, when they do not rather address their homage, in hymns and otherwise, to the founder of their creed himself. Whilst very numerous, particularly amongst the low-caste population, in western, central and northern India, resident adherents of Kabir's doctrine are rare in Bengal and the south; although

"there is hardly a town in India where strolling beggars may not be found singing songs of Kabir in the original or as translated into the local dialects." The mendicants of this creed, however, never actually solicit alms; and, indeed, "the quaker-like spirit of the sect, their abhorrence of all violence, their regard for truth and the inobtrusiveness of their opinions render them very inoffensive members of the state" (H. H. Wilson). The doctrines of Kabir are taught, mostly in the form of dialogues, in numerous Hindi works, composed by his disciples and adherents, who, however, usually profess to give the teacher's own words.

The peculiar conciliatory tendencies of Kabir were carried on with even greater zeal from the latter part of the 15th century by one of his followers, Nanak Shah, the promulgator of the creed of the *Nanak Shahis* or *Sikhs*—i.e. (Sanskrit) *sishyo*, disciples, whose guru, or teacher, he called himself—a peaceful sect at first until, in consequence of Mahomedan persecution, a martial spirit was infused into it by the tenth, and last, guru, Govind Shah, changing it into a political organization. Whilst originally more akin in its principles to the Moslem faith, the sect seems latterly to have shown tendencies towards drifting back to the Hindu pale.

Of Ramananda's disciples and successors several others, besides Kabir, have established schismatic divisions of their own, which do not, however, offer any very marked differences of creed. The most important of these, the *Dadu Panthi* sect, founded by Dadu about the year 1600, has a numerous following in Ajmir and Marwar, one section of whom, the Nagas, engage largely in military service, whilst the others are either householders or mendicants. The followers of this creed wear no distinctive sectarian mark or badge, except a skull-cap; nor do they worship any visible image of any deity, the repetition (*japa*) of the name of Rama being the only kind of adoration practised by them.

Although the Vaishnava sects hitherto noticed, in their adoration of Vishnu and his incarnations, Krishna and Rama-chandra, usually associate with these gods their wives, as their *saktis*, or female energies, the sexual element is, as a rule, only just allowed sufficient scope to enhance the emotional character of the rites of worship. In some of the later Vaishnava creeds, on the other hand, this element is far from being kept within the bounds of moderation and decency. The favourite object of adoration with adherents of these sects is Krishna with his mate—but not the devoted friend and counsellor of the Pandavas and deified hero of epic song, nor the ruler of Dvaraka and wedded lord of Rukmini, but the juvenile Krishna, Govinda or Bala Gopala, "the cowherd lad," the foster son of the cowherd Nanda of Gokula, taken up with his amorous sports with the *Gopis*, or wives of the cowherds of Vrindavana (Brindaban, near Mathura on the Yamuna), especially his favourite mistress Radha or Radhika. This episode in the legendary life of Krishna has every appearance of being a later accretion. After barely a few allusions to it in the epics, it bursts forth full-blown in the Harivansa, the Vishnu-purana, the Narada-Pancharatra and the Bhagavata-purana, the tenth canto of which, dealing with the life of Krishna, has become, through vernacular versions, especially the Hindi *Prem-sagar*, or "ocean of love," a favourite romance all over India, and has doubtless helped largely to popularize the cult of Krishna. Strange to say, however, no mention is as yet made by any of these works of Krishna's favourite Radha; it is only in another Purana—though scarcely deserving that designation—that she makes her appearance, viz. in the Brahma-vaivarta, in which Krishna's amours in Nanda's cow-station are dwelt upon in fulsome and wearisome detail; whilst the poet Jayadeva, in the 12th century, made her love for the gay and inconstant boy the theme of his beautiful, if highly voluptuous, lyrical drama, *Gita-govinda*.

The earliest of the sects which associate Radha with Krishna in their worship is that of the Nimavats, founded by Nimbadiya or Nimbarka (i.e. "the sun of the Nimba tree"), a teacher of uncertain date, said to have been a Telugu Brahman who subsequently established himself at Mathura (Muttra) on the Yamuna, where the headquarters of his sect have remained ever since. The Mahant of their monastery at Dhruva Kshetra near Mathura, who claims direct descent from Nimbarka, is said to place the foundation of that establishment as far back as the 5th century—doubtless an

exaggerated claim; but if Jayadeva, as is alleged, and seems by no means improbable, was really a follower of Nimbarka, this teacher must have flourished, at latest, in the early part of the 12th century. He is indeed taken by some authorities to be identical with the mathematician Bhaskara Acharya, who is known to have completed his chief work in A.D. 1150. It is worthy of remark, in this respect, that—in accordance with Ramanuja's and Nimbarka's philosophical theories—Jayadeva's presentation of Krishna's fickle love for Radha is usually interpreted in a mystical sense, as allegorically depicting the human soul's striving, through love, for reunion with God, and its ultimate attainment, after many backslidings, of the longed-for goal. As the chief authority of their tenets, the Nimavats recognize the Bhagavata-purana; though several works, ascribed to Nimbarka—partly of a devotional character and partly expository of Vedanta topics—are still extant. Adherents of this sect are fairly numerous in northern India, their frontal mark consisting of the usual two perpendicular white lines, with, however, a circular black spot between them.

Of greater importance than the sect just noticed, because of their far larger following, are the two sects founded early in the 16th century by Vallabha (Ballabha) Acharya and Chaitanya. In the forms of worship favoured by votaries of these creeds the emotional and erotic elements are allowed yet freer scope than in those that preceded them; and, as an effective auxiliary to these tendencies, the use of the vernacular dialects in prayers and hymns of praise takes an important part in the religious service. The Vallabhacharya, or, as they are usually called, from the title of their spiritual heads, the Gokulasha Gosains, i.e. "the cow-lords (gouramis) residing in Gokula," are very numerous in western and central India. Vallabha, the son of a Telinga Brahman, after extensive journeyings all over India, settled at Gokula near Mathura, and set up a shrine with an image of Krishna Gopala. About the year 1673, in consequence of the fanatical persecutions of the Mogul emperor, this image was transferred to Nathdvra in Udaipur (Mewar), where the shrine of Srinatha ("the lord of Sri," i.e. Vishnu) continues to be the chief centre of worship for adherents of this creed; whilst seven other images, transferred from Mathura at the same time, are located at different places in Rajputana. Vallabha himself went subsequently to reside at Benares, where he died. In the doctrine of this Vaishnava prophet, the dualistic theory of Sankara is resorted to as justifying a joyful and voluptuous cult of the deity. For, if the human soul is identical with God, the practice of austerities must be discarded as directed against God, and it is rather by a free indulgence of the natural appetites and the pleasures of life that man's love for God will best be shown. The followers of his creed, amongst whom there are many wealthy merchants and bankers, direct their worship chiefly to Gopala Lal, the boyish Krishna of Vrindavana, whose image is sedulously attended like a revered living person eight times a day—from its early rising from its couch up to its retiring to repose at night. The aerial mark of the adherents consists of two red perpendicular lines, meeting in a semicircle at the root of the nose, and having a round red spot painted between them. Their principal doctrinal authority is the Bhagavata-purana, as commented upon by Vallabha himself, who was also the author of several other Sanskrit works highly esteemed by his followers. In this sect, children are solemnly admitted to full membership at the early age of four, and even two years of age, when a rosary, or necklace, of 108 beads of basil (tulsi) wood is passed round their necks, and they are taught the use of the octo-syllabic formula *Sri-Krishna saranam mama*, "Holy Krishna is my refuge." Another special feature of this sect is that their spiritual heads, the Gosains, also called Maharajas, so far from submitting themselves to self-discipline and austere practices, adorn themselves in splendid garments, and allow themselves to be habitually regaled by their adherents with choice kinds of food; and being regarded as the living representatives of the "lord of the Gopis" himself, they claim and receive in their own persons all acts of attachment and worship due to the deity, even, it is alleged, to the extent of complete self-surrender. In the final judgment of the famous libel case of the Bombay Maharajas, before the Supreme Court of Bombay, in January 1862, these improprieties were severely commented upon; and though no unparagoning critic of Indian sects as Jogendra Nath seems not to believe in actual immoral practices on the part of the Maharajas, still he admits that "the corrupting influence of a religion, that can make its female votaries address amorous songs to their spiritual guides, must be very great."

A modern offshoot of Vallabha's creed, formed with the avowed object of purging it of its objectionable features, was started, in the early years of the 19th century, by Sahajananda, a Brahman of the Oudh country, who subsequently assumed the name of Svami Narayana. Having entered on his missionary labours at Ahmadabad, and afterwards removed to Jetalpur, where he had a meeting with Bishop Heber, he subsequently settled at the village of Wartal, to the north-west of Baroda, and erected a temple to Lakshmi-Narayana, which, with another at Ahmadabad, forms the two chief centres of the sect, each being presided over by a Maharaja. Their worship is addressed to Narayana, i.e. Vishnu, as the Supreme Being, together with Lakshmi, as well as to Krishna and Radha. The sect is said to be gaining ground in Gujrat. Chaitanya, the

founder of the great Vaishnava sect of Bengal, was the son of a high-caste Brahman of Nadiya, the famous Bengal seat of Sanskrit learning, where he was born in 1485, two years after the birth of Martin Luther, the German reformer. Having married in due time, and a second time after the death of his first wife, he lived as a "householder" (*grhastha*) till the age of 24, when he renounced his family ties and set out as a religious mendicant (*vairagi*), visiting during the next six years the principal places of pilgrimage in northern India, and preaching with remarkable success his doctrine of Bhakti, or passionate devotion to Krishna, as the Supreme Deity. He subsequently made over to his principal disciples the task of consolidating his community, and passed the last twelve years of his life at Puri in Orissa, the great centre of the worship of Vishnu as Jagannatha, or "lord of the world," which he remodelled in accordance with his doctrine, causing the mystic songs of Jayadeva to be recited before the images in the morning and evening as part of the daily service; and, in fact, as in the other Vaishnava creeds, seeking to humanize divine adoration by bringing it into accord with the experience of human love. To this end, music, dancing, singing-parties (*sankirtan*), theatricals—in short anything calculated to produce the desired impression—would prove welcome to him. His doctrine of Bhakti distinguishes five grades of devotional feeling in the *Bhaktas*, or faithful adherents: viz. (*santi*) calm contemplation of the deity; (*dasya*) active servitude; (*sakhye*) friendship or personal regard; (*vatsalya*) tender affection as between parents and children; (*madhurya*) love or passionate attachment, like that which the Gopis felt for Krishna. Chaitanya also seems to have done much to promote the celebration on an imposing scale of the great Puri festival of the Ratha-yatra, or "car-procession," in the month of Ashadha, when, amidst multitudes of pilgrims, the image of Krishna, together with those of his brother Balarama and his sister Subhadra, is drawn along, in a huge car, by the devotees. Just as this festival was, and continues to be, attended by people from all parts of India, without distinction of caste or sex, so also were all classes, even Mahomedans, admitted by Chaitanya as members of his sect. Whilst numerous observances are recommended as more or less meritorious, the ordinary form of worship is a very simple one, consisting as it does mainly of the constant repetition of names of Krishna, or Krishna and Radha, which of itself is considered sufficient to ensure future bliss. The partaking of flesh food and spirituous liquor is strictly prohibited. By the followers of this sect, also, an extravagant degree of reverence is habitually paid to their *gurus* or spiritual heads. Indeed, Chaitanya himself, as well as his immediate disciples, have come to be regarded as complete or partial incarnations of the deity to whom adoration is due, as to Krishna himself; and their modern successors, the Gosains, share to the fullest extent in the devout attentions of the worshippers. Chaitanya's movement, being chiefly directed against the vile practices of the Saktas, then very prevalent in Bengal, was doubtless prompted by the best and purest of intentions; but his own doctrine of divine, though all too human, love was, like that of Vallabha, by no means free from corruptive tendencies,—yet, how far these tendencies have worked their way, who would say? On this point, Dr. W. W. Hunter—who is of opinion that "the death of the reformer marks the beginning of the spiritual decline of Vishnu-worship," observes (*Orissa*, i. 111), "The most deplorable corruption of Vishnu-worship at the present day is that which has covered the temple walls with indecent sculptures, and filled its innermost sanctuaries with licentious rites" . . . yet . . . "it is difficult for a person not a Hindu to pronounce upon the real extent of the evil. None but a Hindu can enter any of the larger temples, and none but a Hindu priest really knows the truth about their inner mysteries"; whilst the well-known native scholar Babu Rajendralal Mitra points out (*Antiquities of Orissa*, i. 111) that "such as they are, these sculptures date from centuries before the birth of Chaitanya, and cannot, therefore, be attributed to his doctrines or to his followers. As a Hindu by birth, and a Vaishnava by family religion, I have had the freest access to the innermost sanctuaries and to the most secret of scriptures. I have studied the subject most extensively, and have had opportunities of judging which no European can have, and I have no hesitation in saying that, 'the mystic songs' of Jayadeva and the 'ocean of love' notwithstanding, there is nothing in the rituals of Jagannatha which can be called licentious." Whilst in Chaitanya's creed, Krishna, in his relations to Radha, remains at least theoretically the chief partner, an almost inevitable step was taken by some minor sects in attaching the greater importance to the female element, and making Krishna's love for his mistress the guiding sentiment of their faith. Of these sects, it will suffice to mention that of the Radha-Vallabhis, started in the latter part of the 16th century, who worship Krishna as Radha-vallabha, "the darling of Radha." The doctrines and practices of these sects clearly verge upon those obtaining in the third principal division of Indian sectarians which will now be considered.

The Saktas, as we have seen, are worshippers of the *sakti*, or the female principle as a primary factor in the creation and reproduction of the universe. And as each of the principal gods is supposed to have associated with him his own

particular *sakti*, as an indispensable complement enabling him to properly perform his cosmic functions, adherents of this persuasion might be expected to be recruited from all *Saktism* sects. To a certain extent this is indeed the case; but though Vaishnavism, and especially the Krishna creed, with its luxuriant growth of erotic legends, might have seemed peculiarly favourable to a development in this direction, it is practically only in connexion with the Saiva system that an independent cult of the female principle has been developed; whilst in other sects—and, indeed, in the ordinary Saiva cult as well—such worship, even where it is at all prominent, is combined with, and subordinated to, that of the male principle. What has made this cult attach itself more especially to the Saiva creed is doubtless the character of Siva as the type of reproductive power, in addition to his function as destroyer which, as we shall see, is likewise reflected in some of the forms of his Sakti. The theory of the god and his Sakti as cosmic principles is perhaps already foreshadowed in the Vedic couple of Heaven and Earth, whilst in the speculative treatises of the later Vedic period, as well as in the post-Vedic Brahmanical writings, the assumption of the self-existent being dividing himself into a male and a female half usually forms the starting-point of cosmic evolution.¹ In the later Saiva mythology this theory finds its artistic representation in Siva's androgynous form of Ardha-narisa, or "half-woman-lord," (typifying the union of the male and female energies; the male half in this form of the deity occupying the right-hand, and the female the left-hand side. In accordance with this type of productive energy, the Saktas divide themselves into two distinct groups, according to whether they attach the greater importance to the male or to the female principle; viz. the *Dakshinacharis*, or "right-hand-observers" (also called *Dakshina-margis*, or followers "of the right-hand path"), and the *Vamacharis*, or "left-hand-observers" (or *Vama-margis*, followers "of the left path"). Though some of the Puranas; the chief repositories of sectarian doctrines, enter largely into Sakta topics, it is only in the numerous Tantras that these are fully and systematically developed. In these works, almost invariably composed in the form of a colloquy, Siva, as a rule, in answer to questions asked by his consort Parvati, unfolds the mysteries of this occult creed.

The principal seat of Sakta worship is the north-eastern part of India—Bengal, Assam and Behar. The great majority of its adherents profess to follow the right-hand practice; and apart from the implied purport and the emblems of the cult, their mode of adoration does not seem to offer any very objectionable features. And even amongst the adherents of the left-hand mode of worship, many of these are said to follow it as a matter of family tradition rather than of religious conviction, and to practise it in a sober and temperate manner; whilst only an extreme sect—the so-called *Kaulas* or *Kulinas*, who appeal to a spurious Upanishad, the *Kaulopanishad*, as the divine authority of their tenets—persist in carrying on the mystic and licentious rites taught in many of the Tantras. But strict secrecy being enjoined in the performance of these rites, it is not easy to check any statements made on this point. The Sakta cult is, however, known to be especially prevalent—though apparently not in a very extreme form—amongst members of the very respectable Kayastha or writer caste of Bengal, and as these are largely employed as clerks and accountants in Upper India, there is reason to fear that their vicious practices are gradually being disseminated through them.

The divine object of the adoration of the Saktas, then, is Siva's wife—the *Devi* (goddess), *Mahadevi* (great goddess), or *Jagan-mata* (mother of the world)—in one or other of her numerous forms, benign or terrible. The forms in which she is worshipped in Bengal are of the latter category, viz. *Durga*, "the unapproachable," and *Kali*, "the black one," or, as some take it, the wife of *Kala*, "time," or death the great dissolver, viz. Siva. In honour of the former, the *Durga-puja* is celebrated

¹ This notion not improbably took its origin in the mystic cosmogonic hymn, *Rigv.* x. 129, where it is said that—"that one (existent, neutr.) breathed breathless by (or with) its *madha* (? inherent power, or nature), beyond that there was nothing whatever . . . that one five (germ) which was enclosed in the void came generated by the power of heat (or fervour); desire then first came upon it, which was the first seed of the mind . . . fertilizing forces there were, *madha* below, *prayati* (? will) above."

during ten days at the time of the autumnal equinox, in commemoration of her victory over the buffalo-headed demon Mahishasura; when the image of the ten-armed goddess, holding a weapon in each hand, is worshipped for nine days, and cast into the water on the tenth day, called the Dasahara, whence the festival itself is commonly called Dasara in western India. *Kali*, on the other hand, the most terrible of the goddess's forms, has a special service performed to her, at the *Kali-puja*, during the darkest night of the succeeding month; when she is represented as a naked black woman, four-armed, wearing a garland of heads of giants slain by her, and a string of skulls round her neck, dancing on the breast of her husband (Mahakala), with gaping mouth and protruding tongue; and when she has to be propitiated by the slaughter of goats, sheep and buffaloes. On other occasions also Vamacharis commonly offer animal sacrifices, usually one or more kids; the head of the victim, which has to be severed by a single stroke, being always placed in front of the image of the goddess as a blood-offering (*bali*), with an earthen lamp fed with ghee burning above it, whilst the flesh is cooked and served to the guests attending the ceremony, except that of buffaloes, which is given to the low-caste musicians who perform during the service. Even some adherents of this class have, however, discontinued animal sacrifices, and use certain kinds of fruit, such as coco-nuts or pumpkins, instead. The use of wine, which at one time was very common on these occasions, seems also to have become much more restricted; and only members of the extreme section would still seem to adhere to the practice of the so-called five *m's* prescribed by some of the Tantras, viz. *mamsa* (flesh), *matsya* (fish), *madya* (wine), *maithuna* (sexual union), and *mudra* (mystical finger signs)—probably the most degrading cult ever practised under the pretext of religious worship.

In connexion with the principal object of this cult, Tantric theory has devised an elaborate system of female figures representing either special forms and personifications or attendants of the "Great Goddess." They are generally arranged in groups, the most important of which are the *Mahavidyas* (great sciences), the 8 (or 9) *Mataras* (mothers) or *Mahamataras* (great mothers), consisting of the wives of the principal gods; the 8 *Nayikas* or mistresses; and different classes of sorceresses and ogresses, called *Yoginis*, *Dakinis* and *Sakinis*. A special feature of the Sakti cult is the use of obscure Vedic mantras, often changed so as to be quite meaningless and on that very account deemed the more efficacious for the acquisition of superhuman powers; as well as of mystic letters and syllables called *hija* (germ), of magic circles (*chakra*) and diagrams (*yantra*); and of amulets of various materials inscribed with formulæ of fancied mysterious import.

This survey of the Indian sects will have shown how little the character of their divine objects of worship is calculated to exert that elevating and spiritualizing influence, so characteristic of true religious devotion. In all but a few of the minor groups religious fervour is only too apt to degenerate into that very state of sexual excitation which devotional exercises should surely tend to repress. If the worship of Siva, despite the purport of his chief symbol, seems on the whole less liable to produce these undesirable effects than that of the rival deity, it is doubtless due partly to the real nature of that emblem being little realized by the common people, and partly to the somewhat repellent character of the "great god," more favourable to evoking feelings of awe and terror than a spirit of fervid devotion. All the more are, however, the gross stimulants, connected with the adoration of his consort, calculated to work up the carnal instincts of the devotees to an extreme degree of sensual frenzy. In the Vaishnava camp, on the other hand, the cult of Krishna, and more especially that of the youthful Krishna, can scarcely fail to exert an influence which, if of a subtler and more insinuating, is not on that account of a less demoralizing kind. Indeed, it would be hard to find anything less consonant with godliness and divine perfection than the pranks of this juvenile god; and if poets and thinkers try to explain them away by dint of allegorical interpretation, the plain man will not for all their refinements take these amusing adventures any the less on *piéd de la lettre*. No fault, in this respect, can assuredly be

found with the legendary Rama, a very paragon of knightly honour and virtue, even as his consort Sita is the very model of a noble and faithful wife; and yet this cult has perhaps retained even more of the character of mere hero-worship than that of Krishna. Since by the universally accepted doctrine of *karman* (deed) or *karmanipaka* ("the maturing of deeds") man himself—either in his present, or some future, existence—enjoys the fruit of, or has to atone for, his former good and bad actions, there could hardly be room in Hindu pantheism for a belief in the remission of sin by divine grace or vicarious substitution. And accordingly the "descents" or incarnations of the deity have for their object, not so much the spiritual regeneration of man as the deliverance of the world from some material calamity threatening to overwhelm it. The generally recognized principal Avatars do not, however, by any means constitute the only occasions of a direct intercession of the deity in worldly affairs, but—in the same way as to this day the eclipses of the sun and moon are ascribed by the ordinary Hindu to these luminaries being temporarily swallowed by the dragon *Rahu* (or *Graha*, "the seizer")—so any uncommon occurrence would be apt to be set down as a special manifestation of divine power; and any man credited with exceptional merit or achievement, or even remarkable for some strange incident connected with his life or death, might ultimately come to be looked upon as a veritable incarnation of the deity, capable of influencing the destinies of man, and might become an object of local adoration or superstitious awe and propitiatory rites to multitudes of people. That the transmigration theory, which makes the spirit of the departed hover about for a time in quest of a new corporeal abode, would naturally lend itself to superstitious notions of this kind can scarcely be doubted. Of peculiar importance in this respect is the worship of the *Pitris* ("fathers") or deceased ancestors, as entering largely into the everyday life and family relations of the Hindus. At stated intervals to offer reverential homage and oblations of food to the forefathers up to the third degree is one of the most sacred duties the devout Hindu has to discharge. The periodical performance of the commemorative rite of obsequies called *Sraddha*—i.e. an oblation "made in faith" (*sraddha*, Lat. *credo*)—is the duty and privilege of the eldest son of the deceased, or, failing him, of the nearest relative who thereby establishes his right as next of kin in respect of inheritance; and those other relatives who have the right to take part in the ceremony are called *sapinda*, i.e. sharing in the *pindeas* (or balls of cooked rice, constituting along with libations of water the usual offering to the Manes)—such relationship being held a bar to intermarriage. The first *Sraddha* takes place as soon as possible after the *utyeshthi* ("final offering") or funeral ceremony proper, usually spread over ten days; being afterwards repeated once a month for a year, and subsequently at every anniversary and otherwise voluntarily on special occasions. Moreover, a simple libation of water should be offered to the Fathers twice daily at the morning and evening devotion called *sandhya* ("twilight"). It is doubtless a sense of filial obligation coupled with sentiments of piety and reverence that gave rise to this practice of offering gifts of food and drink to the deceased ancestors. Hence also frequent allusion is made by poets to the anxious care caused to the Fathers by the possibility of the living head of the family being afflicted with failure of offspring; this dire prospect compelling them to use but sparingly their little store of provisions, in case the supply should shortly cease altogether. At the same time one also meets with frank avowals of a superstitious fear lest any irregularity in the performance of the obsequial rites should cause the Fathers to haunt their old home and trouble the peace of their undutiful descendant, or even prematurely draw him after them to the *Pitri-loka* or world of the Fathers, supposed to be located in the southern region. Terminating as it usually does with the feeding and feeing of a greater or less number of Brahmans and the feasting of members of the performers' own caste, the *Sraddha*, especially its first performance, is often a matter of very considerable expense; and more than ordinary benefit to the deceased is supposed to accrue from it when it takes place at a spot of recognized sanctity, such as one of the great

places of pilgrimage like Prayaga (Allahabad, where the three sacred rivers, Ganga, Yamuna and Sarasvati, meet), Mathura, and especially Gaya and Kasi (Benares). But indeed the *tirtha-yatra*, or pilgrimage to holy bathing-places, is in itself considered an act of piety conferring religious merit in proportion to the time and trouble expended upon it. The number of such places is legion and is constantly increasing. The banks of the great rivers such as the Ganga (Ganges), the Yamuna (Jumna), the Nerbada, the Krishna (Kistna), are studded with them, and the water of these rivers is supposed to be imbued with the essence of sanctity capable of cleansing the pious bather of all sin and moral taint. To follow the entire course of one of the sacred rivers from the mouth to the source on one side and back again on the other in the sun-wise (pradakshina) direction—that is, always keeping the stream on one's right-hand side—is held to be a highly meritorious undertaking which it requires years to carry through. No wonder that water from these rivers, especially the Ganges, is sent and taken in bottles to all parts of India to be used on occasion as healing medicine or for sacramental purposes. In Vedic times, at the *Rajasuya*, or inauguration of a king, some water from the holy river Sarasvati was mixed with the sprinkling water used for consecrating the king. Hence also sick persons are frequently conveyed long distances to a sacred river to heal them of their maladies; and for a dying man to breathe his last at the side of the Ganges is devoutly believed to be the surest way of securing for him salvation and eternal bliss.

Such probably was the belief of the ordinary Hindu two thousand years ago, and such it remains to this day. In the light of facts such as these, who could venture to say what the future of Hinduism is likely to be? Is the regeneration of India to be brought about by the modern theistic movements, such as the Brahma-sama and Arya-sama, as so close and sympathetic an observer of Hindu life and thought as Sir A. Lyall seems to think? "The Hindu mind," he remarks, "is essentially speculative and transcendental; it will never consent to be shut up in the prison of sensual experience, for it has grasped and holds firmly the central idea that all things are manifestations of some power outside phenomena. And the tendency of contemporary religious discussion in India, so far as it can be followed from a distance, is towards an ethical reform on the old foundations, towards searching for some method of reconciling their Vedic theology with the practices of religion taken as a rule of conduct and a system of moral government. One can already discern a movement in various quarters towards a recognition of impersonal theism, and towards fixing the teaching of the philosophical schools upon some definitely authorized system of faith and morals, which may satisfy a rising ethical standard, and may thus permanently embody that tendency to substitute spiritual devotion for external forms and caste rules which is the characteristic of the sects that have from time to time disintegrated from orthodox Brahminism."

AUTHORITIES.—*Census of India* (1901), vol. i. part i.; *India*, by H. H. Risley and E. A. Gait; vol. i. *Ethnographical Appendices*, by H. H. Risley; *The Indian Empire*, vol. i. (new ed., Oxford, 1907); J. Muir, *Original Sanskrit Texts* (2nd ed., 5 vols., London, 1873); Monier Williams, *Religious Thought and Life in India* (London, 1893); *Modern India and the Indians* (London, 1878, 3rd ed. 1879); *Hinduism* (London, 1877); Sir Alfred C. Lyall, *Asiatic Studies* (2 series, London, 1899); "Hinduism" in *Religious Systems of the World* (London, 1904); "Brahminism" in *Great Religions of the World* (New York and London, 1902); W. J. Wilkins, *Modern Hinduism* (London, 1887); J. C. Oman, *Indian Life, Religious and Social* (London, 1879); *The Mystics, Ascetics and Saints of India* (London, 1903); *The Brahmins, Theists and Muslims of India* (London, 1907); S. C. Bose, *Hindus as they are* (2nd ed., Calcutta, 1883); J. Robson, *Hinduism and Christianity* (Edinburgh and London, 3rd ed., 1905); J. Murray Mitchell, *Hinduism Past and Present* (2nd ed., London, 1897); Jogendra Nath Bhattacharya, *Hindu Castes and Sects* (Calcutta, 1896); A. Barth, *The Religions of India* (London, 1882); E. W. Hopkins, *The Religions of India* (London, 1896). (J. E.)

HINDU KUSH, a range of mountains in Central Asia. Throughout 500 m. of its length, from its roots in the Pamir regions till it fades into the Koh-i-Baba to the west of Kabul, this great range forms the water-divide between the Kabul and the Oxus basins, and, for the first 200 m. reckoning westwards, the southern boundary of Afghanistan. It may be said to spring from the head of the Taghdumbash Pamir, where it unites with the great meridional system of Sarikol stretching northwards, and the yet more impressive mountain barrier of Muztagh, the northern base of which separates China from the semi-independent territory of

Kanjut. The Wakhjir pass, crossing the head of the Taghdumbash Pamir into the sources of the river Hunza, almost marks the trijunction of the three great chains of mountains. As the Hindu Kush strikes westwards, after first rounding the head of an Oxus tributary (the Ab-i-Panja, which Curzon considers to be the true source of the Oxus), it closely overlooks the trough of that glacier-fed stream under its northern spurs, its crest at the nearest point being separated from the river by a distance which cannot much exceed 10 m. As the river is here the northern boundary of Afghanistan, and the crest of the Hindu Kush the southern boundary, this distance represents the width of the Afghan kingdom at that point.

Physiography.—For the first 100 m. of its length the Hindu Kush is a comparatively flat-backed range of considerable width, permitting the formation of small lakes on the crest, and possessing no considerable peaks. It is crossed by many passes, varying in height from 12,500 ft. to 17,500 ft., the lowest and the easiest being the well-known group about Baroghil, which has from time immemorial offered a line of approach from High Asia to Chitral and Jalalabad. As the Hindu Kush gradually recedes from the Ab-i-Panja and turns south-westwards it gains in altitude, and we find prominent peaks on the crest which measure more than 24,000 ft. above sea-level. Even here, however, the main central water-divide, or axis of the chain, is apparently not the line of highest peaks, which must be looked for to the south, where the great square-headed giant called Tirach Mir dominates Chitral from a southern spur. For some 40 or 50 m. of this south-westerly bend, bearing away from the Oxus, where the Hindu Kush overlooks the mountain wilderness of Badakshan to the west, the crest is intersected by many passes, of which the most important is the Dorah group (including the Minjan and the Mandal), which rise to about 15,000 ft., and which are, under favourable conditions, practicable links between the Oxus and Chitral basins.

From the Dorah to the Khawak pass (or group of passes, for it is seldom that one line of approach only is to be found across the Hindu Kush), which is between 11,000 and 12,000 ft. in altitude, the water-divide overlooks Kafiristan and Kafiristan Badakshan. Here its exact position is matter of conjecture. It lies amidst a wild, inaccessible region of snow-bound crests, and is certainly nowhere less than 15,000 ft. above sea-level. There is a tradition that Timur attempted the passage of the Hindu Kush by one of the unmaped passes hereabouts, and that, having failed, he left a record of his failure engraved on a rock in the pass.

The Khawak, at the head of the Panjshir tributary of the Kabul river, leading straight from Badakshan to Charikar and the city of Kabul, is now an excellent kafilia route, the road having been engineered under the amir Abdur Rahman's direction, and it is said to be available for traffic throughout the year. From the Khawak to the head of the Ghorband (a river of the Hindu Kush which, rising to the north-west of Kabul, flows north-east to meet the Panjshir near Charikar, whence they run united into the plains of Kohistan) the Hindu Kush is intersected by passes at intervals, all of which were surveyed, and several utilized, during the return of the Russo-Afghan boundary commission from the Oxus to Kabul in 1886. Those utilized were the Kaoshan (the "Hindu Kush" pass *par excellence*), 14,340 ft.; the Chahardar (13,900 ft.), which is a link in one of the amir of Afghanistan's high roads to Turkestan; and the Shibar (8800 ft.), which is merely a diversion into the upper Ghorband of that group of passes between Bamian and the Kabul plains which are represented by the Irak, Hajigak, Unai, &c. About this point it is geographically correct to place the southern extremity of the Hindu Kush, for here commences the Koh-i-Baba system into which the Hindu Kush is merged.

The general conformation of the Hindu Kush system south of the Khawak, no less than such fragmentary evidence of its rock composition as at present exists to the north, points to its construction under the same conditions of upheaval and subsequent denudation as are common to the western Himalaya and the whole of the trans-Indus borderland. Its upheaval above the great sea which submerged all the north-west of the Indian peninsula long after the Himalaya had massed itself as a formidable mountain chain, belongs to a comparatively recent geologic period, and the same thrust upwards of vast masses of cretaceous limestone has disturbed the overlying recent beds of shale and clays with very similar results to those which have left so marked an impress on the Baluch frontier. Successive flexures or ridges are ranged in more or less parallel lines, and from between the bands of hard, unyielding rock of older formation the soft beds of recent shale have been washed out, to be carried through the enclosing ridges by rifts which break across their axes. The Hindu Kush is, in fact, but the face of a great upheaved mass of plateau-land lying beyond it northwards, just as the Himalaya forms the southern face of the great central tableland of Tibet, and its general physiography, exhibiting long, narrow, lateral valleys and transverse lines of "antecedent" drainage, is

similar. There are few passes across the southern section of the Hindu Kush (and this section is, from the politico-geographical point of view, more important to India than the whole Himalayan system) which have not to surmount a succession of crests or ridges as they cross from Afghan Turkestan to Afghanistan. The exceptions are, of course, notable, and have played an important part in the military history of Asia from time immemorial. From a little ice-bound lake called *Asa Kul*, or *Karambar*, which lies on the crest of the Hindu Kush near its northern origin at the head of the *Taghdumbash Pamir*, two very important river systems (those of *Chitral* and *Hunza*) are believed to originate. The lake really lies on the watershed between the two, and is probably a glacial relic. Its contribution to either infant stream appears to depend on conditions of overflow determined by the blocking of ice masses towards one end. It marks the commencement of the water-divide which primarily separates the *Gilgit* basin from that of the *Yashkun*, or *Chitral*, river, and subsequently divides the drainage of *Swat* and *Bajour* from that of the *Chitral* (or *Kunar*). The *Yashkun-Chitral-Kunar* river (it is called by all three names) is the longest affluent of the *Kabul*, and it is in many respects a more important river than the *Kabul*. Throughout its length it is closely flanked on its left bank by this main water-divide, which is called *Moshabar* or *Shandur* in its northern sections, and owns a great variety of names where it divides *Bajour* from the *Kunar* valley. It is this range, crowned by peaks of 22,000 ft. altitude and maintaining an average elevation of some 10,000 ft. throughout its length of 250 m., that is the real barrier of the north—not the Hindu Kush itself. Across it, at its head, are the glacial passes which lead to the foot of the *Baroghil*. Of these *Darok*, with a glacial staircase on each side, is typical. (See *GILGIT*.) Those passes (the *Kilik* and *Mintala*) from the *Pamir* regions, which lead into the rocky gorges and defiles of the upper affluents of the *Hunza* to the east of the *Darok*, belong rather to the *Muztagh* system than to the Hindu Kush. Other passes across this important water-divide are the *Shandur* (12,250 ft.), between *Gilgit* and *Masuj*; the *Lowarai* (10,450 ft.), between the *Panjikora* and *Chitral* valleys; and farther south certain lower crossings which once formed part of the great highway between *Kabul* and *India*.

Deep down in the trough of the *Chitral* river, about midway between its source and its junction with the *Kabul* at *Jalalabad*, is the village and fort of *Chitral* (q.v.). Facing *Chitral*, on the right bank of the river, and extending for some 70 m. from the Hindu Kush, is the lofty snow-clad spur of the Hindu Kush known as *Shawal*, across which one or two difficult passes lead into the *Bashgol* valley of *Kafiristan*. This spur carries the boundary of *Afghanistan* southwards to *Arnawai* (some 50 m. below *Chitral*), where it crosses the river to the long *Shandur* watershed. South of *Arnawai* the *Kunar* valley becomes a part of *Afghanistan* (see *KUNAR*). The value of *Chitral* as an outpost of British India may be best gauged by its geographical position. It is about 100 m. (direct map measurement) from the outpost of Russia at *Langar Kishit* on the river *Panja*, with the *Dorah* pass across the Hindu Kush intervening. The *Dorah* may be said to be about half-way between the two outposts, and the mountain tracks leading to it on either side are rough and difficult. The *Dorah*, however, is not the only pass which leads into the *Chitral* valley from the *Oxus*. The *Mandal* pass, a few miles south of the *Dorah*, is the connecting link between the *Oxus* and the *Bashgol* valley of *Kafiristan*; and the *Bashgol* valley leads directly to the *Chitral* valley at *Arnawai*, about 50 m. below *Chitral*. Nor must we overlook the connexion between north and south of the Hindu Kush which is afforded by the long narrow valley of the *Chitral* (or *Yashkun*) itself, leading up to the *Baroghil* pass. This route was once made use of by the Chinese for purposes of pilgrimage, if not for invasion. Access to *Chitral* from the north is therefore but a matter of practicable tracks, or passes, in two or three directions, and the measure of practicability under any given conditions can best be reckoned from *Chitral* itself. By most authorities the possibility of an advance in force from the north, even under the most favourable conditions, is considered to be exceedingly small; but the tracks and passes of the Hindu Kush are only impracticable so long as they are left as nature has made them.

Historical Notices.—Hindu Kush is the *Caucasus* of Alexander's historians. It is also included in the *Paropamisus*, though the latter term embraces more, *Caucasus* being apparently used only when the alpine barrier is in question. Whether the name was given in mere vanity to the barrier which Alexander passed (as *Arrian* and others repeatedly allege), or was founded also on some verbal confusion, cannot be stated. It was no doubt regarded (and perhaps not altogether untruly) as a part of a great alpine zone believed to traverse Asia from west to east, whether called *Taurus*, *Caucasus* or *Imaus*. *Arrian* himself applies *Caucasus* distinctly to the *Himalaya* also. The application of the name *Tanais* to the *Syr* seems to indicate a real confusion with *Colchian Caucasus*. Alexander, after building an *Alexandria* at its foot (probably at *Hupian* near *Charikar*),

crossed into *Bactria*, first reaching *Drapsaca*, or *Adrapa*. This has been interpreted as *Anderab*, in which case he probably crossed the *Khawak* Pass, but the identity is uncertain. The ancient *Zend* name is, according to *Rawlinson*, *Paresina*, the essential part of *Paropamisus*; this accounts for the great Asiatic *Parnassus* of *Aristotle*, and the *Pho-lo-sin-a* of *Hsüan Tsang*.

The name Hindu Kush is used by *Ibn Batuta*, who crossed (c. 1332) from *Anderab*, and he gives the explanation of the name which, however doubtful, is still popular, as (Pers.) *Hindu-Killer*, "because of the number of Indian slaves who perished in passing" its snows. *Baber* always calls the range Hindu Kush, and the way in which he speaks of it shows clearly that it was a range that was meant, not a solitary pass or peak (according to modern local use, as alleged by *Elphinstone* and *Burnes*). Probably, however, the title was confined to the section from *Khawak* to *Koh-i-Baba*. The name has by some later Oriental writers been modified into *Hindu Koh* (mountain), but this is factitious, and throws no more light on the origin of the title. The name seems to have become known to European geographers by the Oriental translations of the two *Petis de la Croix*, and was taken up by *Delisle* and *D'Anville*. *Rennell* and *Elphinstone* familiarized it. *Burnes* first crossed the range (1832). A British force was stationed at *Bamian* beyond it in 1840, with an outpost at *Saighan*.

The Hindu Kush, formidable as it seems, and often as it has been the limit between petty states, has hardly ever been the boundary of a considerable power. Greeks, White Huns, *Samanidae* of *Bokhara*, *Ghaznevides*, *Mongols*, *Timur* and *Timuridae*, down to *Saddozais* and *Barakzais*, have ruled both sides of this great alpine chain.

AUTHORITIES.—Information about the Hindu Kush and *Chitral* is now comparatively exact. The *Russo-Afghan Boundary Commission* of 1884 and the *Chitral expedition* of 1895 opened up a vast area for geographical investigation, and the information collected is to be found in the reports and gazetteers of the Indian government. The following are the chief recent authorities:—Report of the *Russo-Afghan Boundary Commission* (1886); Report of *Lockhart's Mission* (1886); Report of *Asmar Boundary Commission* (1895); Report of *Pamir Boundary Commission* (1896); *J. Biddulph, Trader of the Hindu Kush* (Calcutta, 1880); *W. M'Nair, "Visit to Kafiristan,"* vol. vi. *R.G.S. Proc.*, 1884; *F. Younghusband, "Journeys on the Pamirs, &c.,"* vol. xiv. *R.G.S. Proc.*, 1892; *Colonel Durand, Making a Frontier* (London, 1899); *Sir G. Robertson, Chitral* (London, 1899). (T. H. H.)

HINDUR, or **NALAGARE**, one of the *Simla* hill states, under the government of the *Punjab*, *India*. Pop. (1901) 52,551; area, 256 sq. m.; estimated revenue, £8600. The country was overrun by the *Gurkhas* for some years before 1815, when they were driven out by the *British*, and the *raja* was confirmed in possession of the territory. The principal products are grain and opium.

HINGANGHAT, a town of British India in *Wardha* district, *Central Provinces*, 21 m. S.W. of *Wardha* town. Pop. (1901) 12,662. It is a main seat of the cotton trade, the cotton here produced in the rich *Wardha* valley having given its name to one of the best indigenous staples of *India*. The principal native traders are *Marwaris*, many of whom have large transactions and export on their own account; but the greater number act as middle-men. There are two cotton-mills and several ginning and pressing factories.

HINGE (in *Mid. Eng. henge* or *hæng*, from *hengen*, to hang), a movable joint, particularly that by which a door or window "hangs" from its side-post, or by which a lid or cover is attached to that which it closes; also any device which allows two parts to be joined together and move upon each other (see *JOINERY*). Figuratively the word is used of that on which something depends, a cardinal or turning point, a crisis.

HINGHAM, a township of *Plymouth* county, *Massachusetts*, U.S.A., on *Massachusetts Bay*. Pop. (1890) 4564; (1900) 5059 (969 being foreign-born); (1905, state census) 4819; (1910) 4965. Area, about 30 sq. m. The township is traversed by the *New York, New Haven & Hartford* railway, and contains the villages of *Hingham*, *West Hingham*, *Hingham Center*, and *South Hingham*. *Derby Academy*, a co-educational school

founded and endowed with about £12,000 in 1784 by Sarah Derby (1714-1790), was opened in 1791. Hingham has a public library (1868), with 12,000 volumes in 1908. The Old Meeting House, erected in 1681, is one of the oldest church buildings in the country used continuously. Manufactures were relatively much more important in the 17th and 18th centuries than since. There were settlers here as early as 1633, some of them—notably Edmund Hobart, ancestor of Bishop John Henry Hobart,—being natives of Hingham, Norfolk, England, whence the name; and in 1635 common land called Barecove became the township of Hingham.

See *History of the Town of Hingham* (4 vols., Hingham, 1893).

HINRICHS, HERMANN FRIEDRICH WILHELM (1704-1861), German philosopher, studied theology at Strassburg, and philosophy at Heidelberg under Hegel (*q.v.*), who wrote a preface to his *Religion im innern Verhältnis zur Wissenschaft* (Heidelberg, 1722). He became a *Privatdozent* in 1810, and held professorships at Breslau (1822) and Halle (1824).

WORKS—(1) Philosophical: *Grundlinien der Philosophie der Logik* (Halle, 1826); *Genesis des Wissens* (Heidelberg, 1835). (2) On aesthetics: *Vorlesungen über Goethes Faust* (Halle, 1825); *Schillers Dichtungen nach ihrem historischen Zusammenhang* (Leipzig, 1837-1839). By these works he became a recognized exponent of orthodox Hegelianism. (3) Historical: *Geschichte der Rechts- und Staatsprinzipien seit der Reformation bis auf die Gegenwart* (Leipzig, 1848-1852); *Die Könige* (2nd ed., Leipzig, 1853).

HINSCIUS, PAUL (1835-1898), German jurist, was the son of Franz Sales August Hinschius (1807-1877), and was born in Berlin on the 25th of December 1835. His father was not only a scientific jurist, but also a lawyer in large practice in Berlin. After working under his father, Hinschius in 1852 began to study jurisprudence at Heidelberg and Berlin, the teacher who had most influence upon him being Aemilius Ludwig Richter (1808-1864), to whom he afterwards ascribed the great revival of the study of ecclesiastical law in Germany. In 1855 Hinschius took the degree of *doctor utriusque juris*, and in 1859 was admitted to the juridical faculty of Berlin. In 1863 he went as professor extraordinarius to Halle, returning in the same capacity to Berlin in 1865; and in 1868 became professor ordinarius at the university of Kiel, which he represented in the Prussian Upper House (1870-1871). He also assisted his father in editing the *Preussische Anwaltszeitung* from 1862 to 1866 and the *Zeitschrift für Gesetzgebung und Rechtspflege in Preussen* from 1867 to 1871. In 1872 he was appointed professor ordinarius of ecclesiastical law at Berlin. In the same year he took part in the conferences of the ministry of ecclesiastical affairs, which issued in the famous "Falk laws." In connexion with the developments of the *Kulturkampf* which resulted from the "Falk laws," he wrote several treatises: e.g. on "The Attitude of the German State Governments towards the Decrees of the Vatican Council" (1871), on "The Prussian Church Laws of 1873" (1873), "The Prussian Church Laws of the years 1874 and 1875" (1875), and "The Prussian Church Law of 14th July 1880" (1881). He sat in the Reichstag as a National Liberal from 1872 to 1878, and again in 1881 and 1882, and from 1889 onwards he represented the university of Berlin in the Prussian Upper House. He died on the 13th of December 1898.

The two great works by which Hinschius established his fame are the *Decretales Pseudo-Isidorianae et capitula Angilramni* (2 parts, Leipzig, 1863) and *Das Kirchenrecht der Katholiken und Protestanten in Deutschland*, vols. i.-vi. (Berlin, 1860-1877). The first of these, for which during 1860 and 1861 he had gathered materials in Italy, Spain, France, England, Scotland, Ireland, Holland and Belgium, was the first critical edition of the False Decretals. His most monumental work, however, is the *Kirchenrecht*, which remains incomplete. The six volumes actually published (*System des katholischen Kirchenrechts*) cover only book i. of the work as planned; they are devoted to an exhaustive historical and analytical study of the Roman Catholic hierarchy and its government of the church. The work is planned with special reference to Germany; but in fact its scheme embraces the whole of the Roman Catholic organization in its principles and practice. Unfortunately even this part of the work remains

incomplete; two chapters of book i. and the whole of book ii., which was to have dealt with "the rights and duties of the members of the hierarchy," remain unwritten; the most notable omission is that of the ecclesiastical law in relation to the regular orders. Incomplete as it is, however, the *Kirchenrecht* remains a work of the highest scientific authority. Epoch-making in its application of the modern historical method to the study of ecclesiastical law in its theory and practice, it has become the model for the younger school of canonists.

See the articles *s.v.* by E. Seckel in Herzog-Hauck, *Realencyklopädie* (3rd ed., 1900), and by Ulrich Steitz in the *Allgemeine deutsche Biographie*, vol. 50 (Leipzig, 1905).

HINTERLAND (German for "the land behind"), the region lying behind a coast or river line, or a country dependent for trade or commerce on any other region. In the purely physical sense "interior" on "back country" is more commonly used, but the word has gained a distinct political significance. It first came into prominence during 1883-1885, when Germany insisted that she had a right to exercise jurisdiction in the territory behind those parts of the African coast that she had occupied. The "doctrine of the hinterland" was that the possessor of the littoral was entitled to as much of the back country as geographically, economically or politically was dependent upon the coast lands, a doctrine which, in the space of ten years, led to the partition of Africa between various European powers.

HINTON, JAMES (1822-1875), English surgeon and author, son of John Howard Hinton (1791-1873), Baptist minister and author of the *History and Topography of the United States* and other works, was born at Reading in 1822. He was educated at his grandfather's school near Oxford, and at the Nonconformist school at Harpenden, and in 1838, on his father's removal to London, was apprenticed to a woollen-draper in Whitechapel. After retaining this situation about a year he became clerk in an insurance office. His evenings were spent in intense study, and this, joined to the ardour, amounting to morbidness, of his interest in moral problems, so affected his health that in his nineteenth year he resolved to seek refuge from his own thoughts by running away to sea. His intention having, however, been discovered, he was sent, on the advice of the physician who was consulted regarding his health, to St Bartholomew's Hospital to study for the medical profession. After receiving his diploma in 1847, he was for some time assistant surgeon at Newport, Essex, but the same year he went out to Sierra Leone to take medical charge of the free labourers on their voyage thence to Jamaica, where he stayed some time. He returned to England in 1850, and entered into partnership with a surgeon in London, where he soon had his interest awakened specially in aural surgery, and gave also much of his attention to physiology. He made his first appearance as an author in 1836 by contributing papers on physiological and ethical subjects to the *Christian Speculator*; and in 1859 he published *Man and his Dwelling-place*. A series of papers entitled "Physiological Riddles," in the *Cornhill Magazine*, afterwards published as *Life in Nature* (1862), as well as another series entitled *Thoughts on Health* (1871), proved his aptitude for popular scientific exposition. After being appointed aural surgeon to Guy's Hospital in 1863, he speedily acquired a reputation as the most skillful aural surgeon of his day, which was fully borne out by his works, *An Atlas of Diseases of the membrana tympani* (1874), and *Questions of Aural Surgery* (1874). But his health broke down, and in 1874 he gave up practice; and he died at the Azores of acute inflammation of the brain on the 16th of December 1875. In addition to the works already mentioned, he was the author of *The Mystery of Pain* (1866) and *The Place of the Physician* (1874). On account of their fresh and vigorous discussion of many of the important moral and social problems of the time, his writings had a wide circulation on both sides of the Atlantic. His *Life and Letters*, edited by Elice Hopkins, with an introduction by Sir W. W. Gull, appeared in 1878.

HIOGO (Hyogo), a town of Japan in the province of Settsu, Nippon, on the western shore of the bay of Osaka, adjoining the foreign settlement of Kobe, 21 m. W. of Osaka by rail. The

growth of its prosperity has been very remarkable. Its population, including that of Kobe, was 135,630 in 1891, and 285,002 in 1903. From 1884 to the close of the century its trade increased nearly eightfold, and the increase was not confined to a few staples of commerce, but was spread over almost the whole trade, in which silk and cotton fabrics, floor-mats, straw-plaits, matches, and cotton yarans are specially important. Kobe owes much of its prosperity to the fact of serving largely as the shipping port of Osaka, the chief manufacturing town in Japan. The foreign community, exclusive of Chinese, exceeds 1000 persons. Kobe is considered the brightest and healthiest of all the places assigned as foreign settlements in Japan, its pure, dry air and granite subsoil constituting special advantages. It is in railway communication with all parts of the country, and wharves admit of steamers of large size loading and discharging cargo without the aid of lighters. The area originally appropriated for a foreign settlement soon proved too restricted, and foreigners received permission to lease lands and houses direct from Japanese owners beyond the treaty limits, a privilege which, together with that of building villas on the hills behind the town, ultimately involved some diplomatic complications. Kobe has a shipbuilding yard, and docks in its immediate neighbourhood.

Hiogo has several temples of interest, one of which has near it a huge bronze statue of Buddha, while by the Minatogawa, which flows into the sea between Hiogo and Kobe, a temple commemorates the spot where Kusunoki Masashige, the mirror of Japanese loyalty, met his death in battle in 1336. The temple of Ikuta was erected on the site of the ancient fane built by Jingo on her return from Korea in the 3rd century.

Hiogo's original name was Bako. Its position near the entrance of the Inland Sea gave it some maritime importance from a very early period, but it did not become really prominent until the 12th century, when Kiyomori, chief of the Taira clan, transferred the capital from Kioto to Fukuhara, in Hiogo's immediate neighbourhood, and undertook various public works for improving the place. The change of capital was very brief, but Hiogo benefited permanently from the distinction.

HIP. (1) (From O. Eng. *hype*, a word common in various forms to many Teutonic languages; cf. Dutch *heup*, and Ger. *Hüfte*), the projecting part of the body formed by the top of the thigh-bone and the side of the pelvis, in quadrupeds generally known as the haunch (see JOINTS). (2) (O. Eng. *hēope*, from same root as M.H. Ger. *hiefe*, a thorn-bush), the fruit of the dog-rose (*Rosa canina*); "hips" are usually joined with "haws," the fruit of the hawthorn.

HIP-KNOB, in architecture, the finial on the hip of a roof, between the barge-boards of a gable.

HIPPARCHUS (fl. 146–126 B.C.), Greek astronomer, was born at Nicaea in Bithynia early in the 2nd century B.C. He observed in the island of Rhodes probably from 161, certainly from 146 until about 126 B.C., and made the capital discovery of the precession of the equinoxes in 130 (see ASTRONOMY: History). The outburst of a new star in 134 B.C. is stated by Pliny (*Hist. nat.* ii. 26) to have prompted the preparation of his catalogue of 1080 stars, substantially embodied in Ptolemy's *Almagest*. Hipparchus founded trigonometry, and compiled the first table of chords. Scientific geography originated with his invention of the method of fixing terrestrial positions by circles of latitude and longitude. There can be little doubt that the fundamental part of his astronomical knowledge was derived from Chaldea. None of his many works has survived except a Commentary on the *Phaenomena* of Aratus and Eudoxus, published by P. Victorius at Florence in 1567, and included by D. Petavius in his *Uranologium* (Paris, 1630). A new edition was published by Carolus Manitius (Leipzig, 1894).

See J. B. J. Delambre, *Histoire de l'Astronomie ancienne*, i. 173; P. Tannery, *Recherches sur l'histoire de l'astr. ancienne*, p. 130; A. Berry, *Hist. of Astronomy*, pp. 40–61; M. Marie, *Hist. des sciences*, i. 207; C. Cornwell Lewis, *Astronomy of the Ancients*, p. 207; R. Grant, *Hist. of Phys. Astronomy*, pp. 318, 437; F. Boll, *Sphaera*, p. 61 (Leipzig, 1903); R. Wolf, *Geschichte der Astronomie*, p. 45; J. F. Montucla, *Hist. des mathématiques*, t. i. p. 257; J. A. Schmidt, *Variarum philosophiarum decas*, cap. i. (Jenae, 1691). (A. M. C.)

HIPPASUS OF METAPONTUM, Pythagorean philosopher, was one of the earliest of the disciples of Pythagoras. He is mentioned both by Diogenes Laërtius and by Iamblichus, but nothing is known of his life. Diogenes says that he left no writings, but other authorities make him the author of a *paradeisis* directed against the Pythagoreans. According to Aristotle (*Metaphysica*, i. 3), he was an adherent of the Heraclitean fire-doctrine, whereas the Pythagoreans maintained the theory that number is the principle of everything. He seems to have regarded the soul as composed of igneous matter, and so approximates the orthodox Pythagorean doctrine of the central fire, or Hestia, to the more detailed theories of Heraclitus. In spite of this divergence, Hippasus is always regarded as a Pythagorean.

See Diogenes viii. 84; Brandis, *History of Greek and Roman Philosophy*; also PYTHAGORAS.

HIPPEASTRUM, in botany, a genus of the natural order Amaryllidaceae, containing about 50 species of bulbous plants, natives of tropical and sub-tropical South America. In cultivation they are generally known as *Amaryllis*. The handsome funnel-shaped flowers are borne in a cluster of two to many, at the end of a short hollow scape. The species and the numerous hybrids which have been obtained artificially, show a great variety in size and colour of the flower, including the richest deep crimson and blood-red, white, or with striped, mottled or blended colours. They are of easy culture, and free-blooming habit. Like other bulbs they are increased by offsets, which should be carefully removed when the plants are at rest, and should be allowed to attain a fair size before removal. These young bulbs should be potted singly in February or March, in mellow loamy soil with a moderate quantity of sand, about two-thirds of the bulb being kept above the level of the soil, which should be made quite solid. They should be removed to a temperature of 60° by night and 70° by day, very carefully watered until the roots have begun to grow freely, after which the soil should be kept moderately moist. As they advance the temperature should be raised to 70° at night, and to 80° or higher with sun heat by day. They do not need shading, but should have plenty of air, and be syringed daily in the afternoon. When growing they require a good supply of water. After the decay of the flowers they should be returned to a brisk moist temperature of from 70° to 80° by day during summer to perfect their leaves, and then be ripened off in autumn. Through the winter they should have less water, but must not be kept entirely dry. The minimum temperature should now be about 55°, to be increased 10° or 15° in spring. As the bulbs get large they will occasionally need shifting into larger pots. Propagation is also readily effected by seeds for raising new varieties. Seeds are sown when ripe in well drained pans of sandy loam at a temperature of about 65°. The seedlings when large enough to handle are placed either singly in very small pots or several in a pot or shallow pan, and put in a bottom heat, in a moist atmosphere with a temperature from 60° to 70°. *H. Ackermansii*, with large, handsome, crimson flowers—itsself a hybrid—is the parent of many of the large-flowered forms; *H. equestris* (Barbados lily), with yellowish-green flowers tipped with scarlet, has also given rise to several handsome forms; *H. alucium* (flowers crimson and green), *H. pardinum* (flowers creamy-white spotted with crimson), and *H. vittatum* (flowers white with red stripes, a beautiful species and the parent of many varieties), are stove or warm greenhouse plants. These kinds, however, are now only regarded as botanical curiosities, and are rarely grown in private or commercial establishments. They have been ousted by the more gorgeous looking hybrids, which have been evolved during the past 100 years. *H. Johnsoni* is named after a Lancashire watchmaker who raised it in 1799 by crossing *H. Reginae* with *H. vittatum*. Since that time other species have been used for hybridizing, notably *H. reticulatum*, *H. alucium*, *H. solandriiflorum*, and sometimes *H. equestris* and *H. psillacinum*. The finest forms since 1880 have been evolved from *H. Leopoldi* and *H. pardinum*. (J. Ws.)

HIPPED ROOF, the name given in architecture to a roof which slopes down on all four sides instead of terminating on

two sides against a vertical gable. Sometimes a compromise is made between the two, half the roof being hipped and half resting on the vertical wall; this gives much more room inside the roof, and externally a most picturesque effect, which is one of the great attractions of domestic architecture in the south of England, and is rarely found in other countries.

HIPPEL, THEODOR GOTTLIEB VON (1741-1796), German satirical and humorous writer, was born on the 31st of January 1741, at Gerdauden in East Prussia, where his father was rector of a school. He enjoyed an excellent education at home, and in his sixteenth year he entered Königsberg university as a student of theology. Interrupting his studies, he went, on the invitation of a friend, to St Petersburg, where he was introduced at the brilliant court of the empress Catherine II. Returning to Königsberg he became a tutor in a private family; but, falling in love with a young lady of high position, his ambition was aroused, and giving up his tutorship he devoted himself with enthusiasm to legal studies. He was successful in his profession, and in 1780 was appointed chief burgomaster in Königsberg, and in 1786 privy councillor of war and president of the town. As he rose in the world, however, his inclination for matrimony vanished, and the lady who had stimulated his ambition was forgotten. He died at Königsberg on the 23rd of April 1796, leaving a considerable fortune. Hippel had extraordinary talents, rich in wit and fancy; but his was a character full of contrasts and contradictions. Cautiousness and ardent passion, dry pedantry and piety, morality and sensuality; simplicity and ostentation composed his nature; and, hence, his literary productions never attained artistic finish. In his *Lebensläufe nach aufsteigender Linie* (1778-1781) he intended to describe the lives of his father and grandfather, but he eventually confined himself to his own. It is an autobiography, in which persons well known to him are introduced, together with a mass of heterogeneous reflections on life and philosophy. *Kreuz- und Quersäge des Ritters A bis Z* (1793-1794) is a satire levelled against the follies of the age—ancestral pride and the thirst for orders, decoration and the like. Among others of his better known works are *Über die Ehe* (1774) and *Über die bürgerliche Verbesserung der Weiber* (1792). Hippel has been called the forerunner of Jean Paul Richter, and has some resemblance to this author, in his constant digressions and in the interweaving of scientific matter in his narrative. Like Richter he was strongly influenced by Laurence Sterne.

In 1827-1838 a collected edition of Hippel's works in 14 vols. was issued at Berlin. *Über die Ehe* has been edited by E. Brenning (Leipzig, 1872), and the *Lebensläufe nach aufsteigender Linie* has in a modernized edition by A. von Oettingen (1878), gone through several editions. See J. Czerny, *Sterne, Hippel und Jean Paul* (Berlin, 1904).

HIPPIAS OF ELIS, Greek sophist, was born about the middle of the 5th century B.C. and was thus a younger contemporary of Protagoras and Socrates. He was a man of great versatility and won the respect of his fellow-citizens to such an extent that he was sent to various towns on important embassies. At Athens he made the acquaintance of Socrates and other leading thinkers. With an assurance characteristic of the later sophists, he claimed to be regarded as an authority on all subjects, and lectured, at all events with financial success, on poetry, grammar, history, politics, archaeology, mathematics and astronomy. He boasted that he was more popular than Protagoras, and was prepared at any moment to deliver an extempore address on any subject to the assembly at Olympia. Of his ability there is no question, but it is equally certain that he was superficial. His aim was not to give knowledge, but to provide his pupils with the weapons of argument, to make them fertile in discussion on all subjects alike. It is said that he boasted of wearing nothing which he had not made with his own hands. Plato's two dialogues, the *Hippias major* and *minor*, contain an exposé of his methods, exaggerated no doubt for purposes of argument but written with full knowledge of the man and the class which he represented. Ast denies their authenticity, but they must have been written by a contemporary writer (as they are mentioned in the literature of the 4th century), and undoubtedly

represent the attitude of serious thinkers to the growing influence of the professional Sophists. There is, however, no question that Hippias did a real service to Greek literature by insisting on the meaning of words, the value of rhythm and literary style. He is credited with an excellent work on Homer, collections of Greek and foreign literature, and archaeological treatises, but nothing remains except the barest notes. He forms the connecting link between the first great sophists, Protagoras and Prodicus, and the innumerable eristics who brought their name into disrepute.

For the general atmosphere in which Hippias moved see SOPHISTS; also histories of Philosophy (e.g. Windelband, Eng. trans. by Tufts, pt. 1, c. 2, §§ 7 and 8).

HIPPO, a Greek philosopher and natural scientist, classed with the Ionian or physical school. He was probably a contemporary of Archelaus and lived chiefly in Athens. Aristotle declared that he was unworthy of the name of philosopher, and, while comparing him with Thales in his main doctrine, adds that his intellect was too shallow for serious consideration. He held that the principle of all things is moisture (*τὸ ὑγρὸν*); that fire develops from water, and from fire the material universe. Further he denied all existence save that of material things as known through the senses, and was, therefore, classed among the "Atheists." The gods are merely great men canonized by popular tradition. It is said that he composed his own epitaph, wherein he claims for himself a place in this company.

HIPPOCRAS, an old medicinal drink or cordial, made of wine mixed with spices—such as cinnamon, ginger and sugar—and strained through woollen cloths. The early spelling usual in English was *ipocras*, or *ypocras*. The word is an adaptation of the Med. Lat. *Vinum Hippocraticum*, or wine of Hippocrates, so called, not because it was supposed to be a receipt of the physician, but from an apothecary's name for a strainer or sieve, "Hippocrates' sleeve" (see W. W. Skeat, *Chaucer*, note to the *Merchant's Tale*).

HIPPOCRATES, Greek philosopher and writer, termed the "Father of Medicine," was born, according to Soranus, in Cos, in the first year of the 80th Olympiad, i.e. in 460 B.C. He was a member of the family of the Asclepiadae, and was believed to be either the nineteenth or seventeenth in direct descent from Aesculapius. It is also claimed for him that he was descended from Hercules through his mother, Phaenarete. He studied medicine under Heraclides, his father, and Herodicus of Selymbria; in philosophy Gorgias of Leontini and Democritus of Abdera were his masters. His earlier studies were prosecuted in the famous Asclepion of Cos, and probably also at Cnidos. He travelled extensively, and taught and practised his profession at Athens, probably also in Thrace, Thessaly, Delos and his native island. He died at Larissa in Thessaly, his age being variously stated as 85, 90, 104 and 109. The incidents of his life are shrouded by uncertain traditions, which naturally sprang up in the absence of any authentic record; the earliest biography was by one of the Sorani, probably Soranus the younger of Ephesus, in the 2nd century; Suidas, the lexicographer, wrote of him in the 11th, and Tzetzes in the 12th century. In all these biographies there is internal evidence of confusion; many of the incidents related are elsewhere told of other persons, and certain of them are quite irreconcilable with his character, so far as it can be judged of from his writings and from the opinions expressed of him by his contemporaries; we may safely reject, for instance, the legends that he set fire to the library of the Temple of Health at Cnidos, in order to destroy the evidence of plagiarism, and that he refused to visit Persia at the request of Artaxerxes Longimanus, during a pestilential epidemic, on the ground that he would in so doing be assisting an enemy. He is referred to by Plato (*Protog.* p. 283; *Phaedr.* p. 211) as an eminent medical authority, and his opinion is also quoted by Aristotle. The veneration in which he was held by the Athenians serves to dissipate the calumnies which have been thrown on his character by Andreas, and the whole tone of his writings bespeaks a man of the highest integrity and purest morality.

Born of a family of priest-physicians, and inheriting all its traditions and prejudices, Hippocrates was the first to cast

superstition aside, and to base the practice of medicine on the principles of inductive philosophy. It is impossible to trace directly the influence exercised upon him by the great men of his time, but one cannot fail to connect his emancipation of medicine from superstition with the widespread power exercised over Greek life and thought by the living work of Socrates, Plato, Aeschylus, Sophocles, Euripides, Herodotus and Thucydides. It was a period of great intellectual development, and it only needed a powerful mind such as his to bring to bear upon medicine the same influences which were at work in other sciences. It must be remembered that his training was not altogether bad, although superstition entered so largely into it. He had a great master in Democritus, the originator of the doctrine of atoms, and there is every reason to believe that the various "asclepia" were very carefully conducted hospitals for the sick, possessing a curious system of case-books, in the form of votive tablets, left by the patients, on which were recorded the symptoms, treatment and result of each case. He had these records at his command; and he had the opportunity of observing the system of training and the treatment of injuries in the gymnasia. One of his great merits is that he was the first to dissociate medicine from priest-craft, and to direct exclusive attention to the natural history of disease. How strongly his mind revolted against the use of charms, amulets, incantations and such devices appears from his writings; and he has expressly recorded, as underlying all his practice, the conviction that, however diseases may be regarded from the religious point of view, they must all be scientifically treated as subject to natural laws (*De aëre*, 29). Nor was he anxious to maintain the connexion between philosophy and medicine which had for long existed in a confused and confusing fashion.¹ His knowledge of anatomy, physiology and pathology was necessarily defective, the respect in which the dead body was held by the Greeks precluding him from practising dissection; thus we find him writing of the tissues without distinguishing between the various textures of the body, confusing arteries, veins and nerves, and speaking vaguely of the muscles as "flesh." But when we come to study his observations on the natural history of disease as presented in the living subject, we recognize at once the presence of a great clinical physician. Hippocrates based his principles and practice on the theory of the existence of a spiritual restoring essence or principle, *phôsis*, the *vis medicatrix naturæ*, in the management of which the art of the physician consisted. This art could, he held, be only obtained by the application of experience, not only to disease at large, but to disease in the individual. He strongly deprecated blind empiricism; the aphorism "ὃ περὶ σφαλέρῃ, ἢ κρίσις χλευρή" (whether it be his or not), tersely illustrates his position. Holding firmly to the principle, *νοῦσαν φôσις ἰστροί*, he did not allow himself to remain inactive in the presence of disease; he was not a merely "expectant" physician; as Sydenham puts it, his practice was "the support of enfeebled and the coercion of outrageous nature." He largely employed powerful medicines and blood-letting both ordinary and by cupping. He advises, however, great caution in their application. He placed great dependence on diet and regimen, and here, quaint as many of his directions may now sound, not only in themselves, but in the reasons given, there is much which is still adhered to at the present day. His treatise *Περὶ ἀέρων, ἰδμάτων, καὶ τόπων* (*Airs, Waters, and Places*) contains the first enunciation of the principles of public health. Although the treatises *Περὶ κρίσεων* cannot be accepted as authentic, we find in the *Προγνώστῶν* evidence of the acuteness of observation in the manner in which the occurrence of critical days in disease is enunciated. His method of reporting cases is most interesting and instructive; in them we can read how thoroughly he had separated himself from the priest-physician. Laennec, to whom we are indebted for the practice of auscultation, freely admits that the idea was suggested to him by study of Hippocrates, who, treating of the presence of morbid fluids in the thorax, gives very particular directions, by

¹ Hippocrates Cous, primus quidem ex omnibus memoria dignus, ab studio sapientiae disciplinam hanc separavit, vir et arte et facundia insignis" (Celsus, *De medicina*).

means of succussion, for arriving at an opinion regarding their nature. Laennec says, "Hippocrate avait tenté l'auscultation immédiate." Although the treatise *Περὶ νόσων* is doubtfully from the pen of Hippocrates, it contains strong evidence of having been the work of his grandson, representing the views of the Father of Medicine. Although not accurate in the conclusions reached at the time, the value of the method of diagnosis is shown by the retention in modern medicine of the name and the practice of "Hippocratic succussion." The power of graphic description of phenomena in the Hippocratic writings is illustrated by the retention of the term "facies Hippocratica" applied to the appearance of a moribund person, pictured in the *Prognostics*. In surgery his writings are important and interesting, but they do not bear the same character of caution as the treatises on medicine; for instance, in the essay *On Injuries of the Head*, he advocates the operation "of trephining" more strongly and in wider classes of cases than would be warranted by the experience of later times.

The *Hippocratic Collection* consists of eighty-seven treatises, of which a part only can be accepted as genuine. The collection has been submitted to the closest criticism in ancient and modern times by a large number of commentators (for full list of the early commentators, see Adams's *Genuine Works of Hippocrates*, Sydenham Society, i. 27, 28). The treatises have been classified according to (1) the direct evidence of ancient writers, (2) peculiarities of style and method, and (3) the presence of anachronisms and of opinions opposed to the general Hippocratic teaching—greatest weight being attached to the opinions of Erotian and Galen. The general estimate of commentators is thus stated by Adams: "The peculiar style and method of Hippocrates are held to be conciseness of expression, great condensation of matter, and disposition to regard all professional subjects in a practical point of view, to eschew subtle hypotheses and modes of treatment based on vague abstractions." The treatises have been grouped in the four following sections: (1) genuine; (2) those consisting of notes taken by students and collected after the death of Hippocrates; (3) essays by disciples; (4) those utterly spurious. Littré accepts the following thirteen as absolutely genuine: (1) *On Ancient Medicine* (*Περὶ ἀρχαίας ἰατρικῆς*); (2) *The Prognostics* (*Προγνώστῶν*); (3) *The Aphorisms* (*Ἀφορισμοί*); (4) *The Epidemics*, i. and iii. ('Ἐπιδημία α' καὶ γ'); (5) *On Regimen in Acute Diseases* (*Περὶ διαίτης ἀκείων*); (6) *On Airs, Waters, and Places* (*Περὶ ἀέρων, ἰδμάτων, καὶ τόπων*); (7) *On the Articulations* (*Περὶ ἄρθρων*); (8) *On Fractures* (*Περὶ ἐγμῶν*); (9) *The Instruments of Reduction* (*Μοχλοῦς*); (10) *The Physician's Establishment, or Surgery* (*Κατ' ἰατροῦς*); (11) *On Injuries of the Head* (*Περὶ τῶν ἐν κεφαλῇ τραυμάτων*); (12) *The Oath* (*Ὄρκος*); (13) *The Law* (*Νόμος*). Of these Adams accepts as certainly genuine the 2nd, 6th, 5th, 3rd (7 books), 4th, 7th, 8th, 9th and 12th, and as "pretty confidently acknowledged as genuine, although the evidence in their favour is not so strong," the 1st, 10th and 13th, and, in addition, (14) *On Ulcers* (*Περὶ ὤλων*); (15) *On Fistulae* (*Περὶ σπληγγῶν*); (16) *On Hemorrhoids* (*Περὶ αἰμορροΐδων*); (17) *On the Sacred Disease* (*Περὶ ἁγίου νόσου*). According to the sceptical and somewhat subjective criticism of Ermerin, the whole collection is to be regarded as spurious except *Epidemics*, books i. and iii. (with a few interpolations), *On Airs, Waters, and Places*, *On Injuries of the Head* ("insigne fragmentum libri Hippocratei"), the former portion of the treatise *On Regimen in Acute Diseases*, and the "obviously Hippocratic" fragments of the *Coan Prognostics*. Perhaps also the *Oath* may be accepted as genuine; its comparative antiquity is not denied. The *Aphorisms* are certainly later and inferior. In the other non-Hippocratic writings Ermerin thinks he can distinguish the hands of no fewer than nineteen different authors, most of them anonymous, and some of them very late.

The earliest Greek edition of the Hippocratic writings is that which was published by Aldus and Asulanus at Venice in 1526 (folio); it was speedily followed by that of Frobenius, which is much more accurate and complete (fol. Basel, 1538). Of the numerous subsequent editions, probably the best was that of Foesius (Frankfort, 1595, 1621, Geneva, 1657), until the publication of the great works of Littré, *Œuvres complètes d'Hippocrate, traduction nouvelle avec le texte grec en regard, collationnée sur les manuscrits et toutes les éditions, accompagnée d'une introduction, de commentaires médicaux, de variantes, et de notes philologiques* (10 vols., Paris, 1839-1861), and of F. Z. Ermerin, *Hippocratis et aliorum medicorum veterum reliquiae* (3 vols., Utrecht, 1859-1864). See also Adams (as cited above), and Reischold's *Hippocrates* (2 vols., Athens, 1864-1865). Daremberg's edition of the *Œuvres choisies* (2nd ed., Paris, 1865) includes the *Oath*, the *Law*, the *Prophetic*, book i., the *Prognostics*, *On Airs, Waters, and Places*, *Epidemics*, books i. and iii., *Regimen*, and *Aphorisms*. Of the separate works attributed to Hippocrates the editions and translations are almost innumerable; of the *Prognostics*, for example, seventy editions are known, while of the *Aphorisms* there are said to exist as many as three hundred. For some notice of the Arabic, Syriac and Hebrew translations of works

professedly by Hippocrates (Ibukrat or Bukrat), the number of which greatly exceeds that of the extant Greek originals, reference may be made to Flügel's contribution to the article "Hippokrates" in the *Encyclopædie* of Ersch and Gruber. They have been partially catalogued by Fabricius in his *Bibliotheca Graeca*. (J. B. T.)

HIPPOCRENE (the "fountain of the horse," ἡ Ἴππου κρήνη), the spring on Mt Helicon, in Boeotia, which, like the other spring there, Aganippe, was sacred to the Muses and Apollo, and hence taken as the source of poetic inspiration. The spring, surrounded by an ancient wall, is now known as *Kryopegadi* or the cold spring. According to the legend, it was produced by the stamping of the hoof of Bellerophon's horse Pegasus. The same story accounts for the Hippocrene in Troezen and the spring Peirene at Corinth.

HIPPODAMUS, of Miletus, a Greek architect of the 5th century B.C. It was he who introduced order and regularity into the planning of cities, in place of the previous intricacy and confusion. For Pericles he planned the arrangement of the harbour-town Peiraeeus at Athens. When the Athenians founded Thuri in Italy he accompanied the colony as architect, and afterwards, in 408 B.C., he superintended the building of the new city of Rhodes. His schemes consisted of series of broad, straight streets, cutting one another at right angles.

HIPPODROME (Gr. ἵπποδρόμος, from ἵππος, horse, and δρόμος, racecourse), the course provided by the Greeks for horse and chariot racing; it corresponded to the Roman *circus*, except that in the latter only four chariots ran at a time, whereas ten or more contended in the Greek games, so that the width was far greater, being about 400 ft., the course being 600 to 700 ft. long. The Greek hippodrome was usually set out on the slope of a hill, and the ground taken from one side served to form the embankment on the other side. One end of the hippodrome was semicircular, and the other end square with an extensive portico, in front of which, at a lower level, were the stalls for the horses and chariots. The modern hippodrome is more for equestrian and other displays than for horse racing. The Hippodrome in Paris somewhat resembles the Roman amphitheatre, being open in the centre to the sky, with seats round on rising levels.

HIPPOLYTUS, in Greek legend, son of Theseus and Hippolyte, queen of the Amazons (or of her sister Antiope), a famous hunter and charioteer and favourite of Artemis. His stepmother Phaedra became enamoured of him, but, finding her advances rejected, she hanged herself, leaving a letter in which she accused Hippolytus of an attempt upon her virtue. Theseus thereupon drove his son from his presence with curses and called upon his father Poseidon to destroy him. While Hippolytus was driving along the shore at Troezen (the scene of the *Hippolytus* of Euripides), a sea-monster (a bull or *phoca*) sent by Poseidon emerged from the waves; the horses were scared, Hippolytus was thrown out of the chariot, and was dragged along, entangled in the reins, until he died. According to a tradition of Epidauros, Asclepius restored him to life at the request of Artemis, who removed him to Italy (see *Vixtus*). At Troezen, where he had a special sanctuary and priest, and was worshipped with divine honours, the story of his death was denied. He was said to have been rescued by the gods at the critical moment, and to have been placed amongst the stars as the Charioteer (*Auriga*). It was also the custom of the Troezenian maidens to cut off a lock of their hair and to dedicate it to Hippolytus before marriage (see Frazer on Pausanias ii. 32. 1). Well-known classical parallels to the main theme are Bellerophon and Antea (or Sthenoboea) and Peleus and Astydamia. The story was the subject of two plays by Euripides (the later of which is extant), of a tragedy by Seneca and of Racine's *Phèdre*. A trace of it has survived in the legendary death of the apocryphal martyr Hippolytus, a Roman officer who was torn to pieces by wild horses as a convert to Christianity (see J. J. Dollinger, *Hippolytus and Callistus*, Eng. tr. by A. Plummer, 1876, pp. 28-39, 51-60).

According to the older explanations, Hippolytus represented the sun, which sets in the sea (cf. the scene of his death and the story of Phaëthon), and Phaedra the moon, which travels behind

the sun, but is unable to overtake it. It is more probable, however, that he was a local hero famous for his chastity, perhaps originally a priest of Artemis, worshipped as a god at Troezen, where he was closely connected and sometimes confounded with Asclepius. It is noteworthy that, in a speech put into the mouth of Theseus by Euripides, the father, who of course believes his wife's story and regards Hippolytus as a hypocrite, throws his son's pretended misogyny and asceticism (Orphism) in his teeth. This seems to point to a struggle between a new ritual and that of Poseidon, the chief deity of Troezen, in which the representative of the intruding religion meets his death through the agency of the offended god, as Orpheus (*q.v.*) was torn to pieces by the votaries of the jealous Dionysus. According to S. Reinach (*Archiv für Religionswissenschaft*, x., 1907, p. 47), the Troezenian Hippolytus was a horse, the hypostasis of an equestrian divinity periodically torn to pieces by the faithful, who called themselves, and believed themselves to be, horses. Death was followed by resuscitation, as in the similar myths of Adonis (the sacred boar), Orpheus (the fox), Pentheus (the fawn), Phaëthon (the white sun-horse).

See Wilamowitz-Möllendorff's Introduction to his German translation of Euripides' *Hippolytus* (1891); A. Kalkmann, *De Hippolytis Euripideis* (Bonn, 1882); and (for representations in art) "Über Darstellung der Hippolytussage" in *Archaeologische Zeitung* (xii, 1883); J. E. Harrison, *Mythology and Monuments of Ancient Athens* (1890), cl.

HIPPOLYTUS, a writer of the early Church. The mystery which enveloped the person and writings of Hippolytus,¹ one of the most prolific ecclesiastical writers of early times, had some light thrown upon it for the first time about the middle of the 19th century by the discovery of the so-called *Philosophumena* (see below). Assuming this writing to be the work of Hippolytus, the information given in it as to the author and his times can be combined with other traditional dates to form a tolerably clear picture. Hippolytus must have been born in the second half of the 2nd century, probably in Rome. Pothius describes him in his *Bibliotheca* (cod. 121) as a disciple of Irenaeus, and from the context of this passage it is supposed that we may conclude that Hippolytus himself so styled himself. But this is not certain, and even if it were, it does not necessarily imply that Hippolytus enjoyed the personal teaching of the celebrated Gallic bishop; it may perhaps merely refer to that relation of his theological system to that of Irenaeus which can easily be traced in his writings. As a presbyter of the church at Rome under Bishop Zephyrinus (199-217), Hippolytus was distinguished for his learning and eloquence. It was at this time that Origen, then a young man, heard him preach (Hieron. *Vir. ill.* 61; cp. Euseb. *H.E.* vi. 14, 16). It was probably not long before questions of theology and church discipline brought him into direct conflict with Zephyrinus, or at any rate with his successor Calixtus I. (*q.v.*). He accused the bishop of favouring the Christological heresies of the Monarchians, and, further, of subverting the discipline of the Church by his lax action in receiving back into the Church those guilty of gross offences. The result was a schism, and for perhaps over ten years Hippolytus stood as bishop at the head of a separate church. Then came the persecution under Maximinus the Thracian. Hippolytus and Pontius, who was then bishop, were transported in 235 to Sardinia, where it would seem that both of them died. From the so-called chronograph of the year 354 (*Catalogus Liberianus*) we learn that on the 13th of August, probably in 236, the bodies of the exiles were interred in Rome and that of Hippolytus in the cemetery on the Via Tiburtina. So we must suppose that before his death the schismatic was received again into the bosom of the Church, and this is confirmed by the fact that his memory was henceforth celebrated in the Church as that of a holy martyr. Pope Damasus I. dedicated to him one of his famous epigrams, and Prudentius (*Peristephanon*, 11) drew a highly coloured picture of his gruesome death, the details of which are certainly purely legendary: the myth of Hippolytus the son of Theseus was transferred to the Christian martyr. Of the historical Hippolytus little remained in the memory of after

¹ According to the legend St Hippolytus was a Roman soldier who was converted by St Lawrence.

ages. Neither Eusebius (*H.E.* vi. 20, 2) nor Jerome (*Vir. ill.* 61) knew that the author so much read in the East and the Roman saint were one and the same person. The notice in the *Chronicon Paschale* preserves one slight reminiscence of the historical facts, namely, that Hippolytus's episcopal see was situated at Portus near Rome. In 1551 a marble statue of a seated man was found in the cemetery of the Via Tiburtina: on the sides of the seat were carved a paschal cycle, and on the back the titles of numerous writings. It was the statue of Hippolytus, a work at any rate of the 3rd century; at the time of Pius IX. it was placed in the Lateran Museum, a record in stone of a lost tradition.

Hippolytus's voluminous writings, which for variety of subject can be compared with those of Origen, embrace the spheres of exegesis, homiletics, apologetics and polemic, chronography and ecclesiastical law. His works have unfortunately come down to us in such a fragmentary condition that it is difficult to obtain from them any very exact notion of his intellectual and literary importance. Of his exegetical works the best preserved are the *Commentary on the Prophet Daniel* and the *Commentary on the Song of Songs*. In spite of many instances of a want of taste in his typology, they are distinguished by a certain sobriety and sense of proportion in his exegesis. We are unable to form an opinion of Hippolytus as a preacher, for the *Homilies on the Feast of Epiphany* which go under his name are wrongly attributed to him. He wrote polemical words directed against the pagans, the Jews and heretics. The most important of these polemical treatises is the *Refutation of all Heresies*, which has come to be known by the inappropriate title of the *Philosophumena*. Of its ten books, the second and third are lost; Book i. was for a long time printed (with the title *Philosophumena*) among the works of Origen; Books iv.-x. were found in 1842 by the Greek Minoides Mynas, without the name of the author, in a MS. at Mount Athos. It is nowadays universally admitted that Hippolytus was the author, and that Books i. and iv.-x belong to the same work. The importance of the work has, however, been much overrated; a close examination of the sources for the exposition of the Gnoetic system which is contained in it has proved that the information it gives is not always trustworthy. Of the dogmatic works, that on *Christ and Antichrist* survives in a complete state. Among other things it includes a vivid account of the events preceding the end of the world, and it was probably written at the time of the persecution under Septimius Severus, *i.e.* about 202. The influence of Hippolytus was felt chiefly through his works on chronographic and ecclesiastical law. His chronicle of the world, a compilation embracing the whole period from the creation of the world up to the year 234, formed a basis for many chronological works both in the East and West. In the great compilations of ecclesiastical law which arose in the East since the 4th century (see below: also APOSTOLIC CONSTITUTIONS) much of the material was taken from the writings of Hippolytus; how much of this is genuinely his, how much of it worked over, and how much of it wrongly attributed to him, can no longer be determined beyond dispute even by the most learned investigation.

BIBLIOGRAPHY.—The edition of J. A. Fabricius, *Hippolyti opera graece et latine* (2 vols., Hamburg, 1716-1718, reprinted in Gallandi, *Bibliotheca veterum patrum* (vol. ii., 1766), and Migne, *Cursus patrum. ser. Graeca*, vol. x.) is out of date. The preparation of a complete critical edition has been undertaken by the Prussian Academy of Sciences. The task is one of extraordinary difficulty, for the textual problems of the various writings are complex and confused: the Greek original is extant in a few cases only (the *Commentary on Daniel*, the *Refutation*, on *Antichrist*, parts of the *Chronicle*, and some fragments); for the rest we are dependent on fragments of translations, chiefly Slavonic, all of which are not even published. Of the Academy's edition one volume was published at Berlin in 1897, containing the *Commentaries on Daniel* and on the *Song of Songs*, the treatise on *Antichrist*, and the *Lesser Exegetical and Homiletic Works*, edited by Nathanael Bonwetsch and Hans Achelis. The *Commentary on the Song of Songs* has also been published by Bonwetsch (Leipzig, 1902) in a German translation based on a Russian translation by N. Marr of the Grusian (Georgian) text, and he added to it (Leipzig, 1904) a translation of various small exegetical pieces, which are preserved in a Georgian version only (*The Blessing of Jacob*, *The Blessing of Moses*, *The Narrative of*

David and Goliath). A great part of the original of the *Chronicle* has been published by Adolf Bauer (Leipzig, 1905) from the *Codex Martiensis Graecus*, 221. For the *Refutation* we are still dependent on the editions of Miller (Oxford, 1851), Duncker and Schneidewia (Göttingen, 1859), and Cruice (Paris, 1860). An English translation is to be found in the *Anto-Nicene Christian Library* (Edinburgh, 1868-1869).

See Bunsen, *Hippolytus and his Age* (1852, 2nd ed., 1854; Ger. ed., 1853); Döllinger, *Hippolytus und Kallistus* (Regenab. 1855; Eng. transl., Edinb., 1876); Gerhard Ficker, *Studien zur Hippolytfrage* (Leipzig, 1893); Hans Achelis, *Hippolytstudien* (Leipzig, 1897); Karl Johannes Neumann, *Hippolytus von Rom in seiner Stellung zu Staat und Welt*, part i. (Leipzig, 1902); Adhémar d'Alès, *La Théologie de Saint Hippolyte* (Paris, 1906). (G. K.)

HIPPOLYTUS, THE CANONS OF. This book stands at the head of a series of Church Orders, which contain instructions in regard to the choice and ordination of Christian ministers, regulations as to widows and virgins, conditions of reception of converts from heathenism, preparation for and administration of baptism, rules for the celebration of the eucharist, for fasting, daily prayers, charity suppers, memorial meals, first-fruits, &c. We shall give (1) a description of the book as we have it at present; (2) a brief statement of its relation to allied documents; (3) some remarks on the evidence for its date and authorship.

1. We possess the *Canons of Hippolytus* only in an Arabic version, itself made from a Coptic version of the original Greek. Attention was called to the book by Wansleben and Ludolf towards the end of the 17th century, but it was only in 1870 that it was edited by Haneberg, who added a Latin translation, and so made it generally accessible. In 1891 H. Achelis reproduced this translation in a revised form, embodying it in a synopsis of allied documents. He suspected much interpolation and derangement of order, and consequently rearranged its contents with a free hand. In 1900 a German translation was made by H. Riedel, based on fresh MSS. These showed that the book, as hitherto edited, had been thrown into disorder by the displacement of two pages near the end; they also removed other difficulties upon which the theory of interpolation had been based. Further discoveries, to be spoken of presently, have added to our materials for the study of the book.

The book is attributed to "Hippolytus, the chief of the bishops of Rome," and is divided into thirty-eight canons, to which short headings are prefixed. This division is certainly not original, but it is convenient for purposes of reference. Canon 1 is preface; it contains a brief confession of faith in the Trinity, and especially in the Word, the Son of God; and it speaks of the expulsion of heretics from the Church. Canons 2-5 give regulations for the selection and ordination of bishops, presbyters and deacons. The bishop is chosen by the whole congregation: "one of the bishops and presbyters" is to lay hands upon him and say a prayer which follows (3); he is at once to proceed with "the offering," taking up the eucharistic service at the point where the *sursum corda* comes in. A presbyter (4) is to be ordained with the same prayer as a bishop, "with the exception of the word bishop"; but he is given no power of ordination (this appears to be inconsistent with c. 2). The duties of a deacon are described, and the prayer of his ordination follows (5). Canons 6-9 deal with various classes in the Church. One who has suffered punishment for the faith (6) is to be counted a presbyter without ordination: "his confession is his ordination." Readers and sub-deacons (7) are given the Gospel, but are not ordained by laying-on of hands. A claim to ordination on the ground of gifts of healing (8) is to be admitted, if the facts are clear and the healing is from God. Widows are not ordained (9): "ordination is for men only." Canons 10-15 describe conditions for the admission of converts. Certain occupations are incompatible with Christian life; only under compulsion may a Christian be a soldier. Canons 16-18 deal chiefly with regulations concerning women. Canon 19 is a long one dealing with catechumens, preparation for baptism, administration of that sacrament, and of the eucharist for the newly baptized. The candidate is twice anointed: first, with the oil of exorcism, after he has said, with his face westward, "I renounce thee, O devil, and all thy following"; and, again, immediately after the baptism. As he stands in the water, he declares his faith in response to an interrogatory creed; and after each of the three clauses he is immersed. After the second anointing the bishop gives thanks "for that Thou hast made them worthy that they should be born again, and hast poured out Thy Holy Ghost upon them, so that they may belong, each one of them, to the body of the Church": he signs them with the cross on their foreheads, and kisses them: The eucharist then proceeds: "the bishop gives them of the body of Christ and says, This is the body of Christ, and they answer Amen"; and similarly for the cup.

Milk and honey are then given to them as being "born a second time as little children." A warning is added against eating anything before communicating. Canons 20-22 deal with fast-days, daily services in church, and the fast of the pasover-week. Canon 23 seems as if it closed the series, speaking, as it does, of "our brethren the bishops" who in their cities have made regulations "according to the commands of our fathers the apostles": "let none of our successors alter them; because it saith that the teaching is greater than the sea, and hath no end." We pass on, however, to regulations about the sick (24) who are to be visited by the bishop, "because it is a great thing for the sick that the high-priest should visit them (for the shadow of Peter healed the sick)." Canons 25-27 deal again with prayers and church-services. The "seven hours" are specified, with reasons for their observance (25); attendance at sermons is urged (26), "for the Lord is in the place where his lordship is proclaimed" (comp. *Didachè* 4, part of the *Two Ways*). When there are no prayers in church, reading at home is enjoined (27): "let the sun each morning see the book upon thy knees" (comp. Ath. *Ad virg.*, § 12. "Let the sun when he ariseth see the book in thy hands"). Prayer must be preceded by the washing of the hands. "No believer must take food before communicating, especially on fast-days": only believers may communicate (28). The sacred elements must be guarded, "lest anything fall into the cup, and it be a sin unto death for the presbyters." No crumb must be dropped, "lest an evil spirit get possession of it." Canons 30-35 contain various rules, and specially deal with suppers for the poor (*i.e. agapae*) and memorial feasts. Then we have a prayer for the offering of first-fruits (36); a direction that ministers shall wear fair garments at "the mysteries" (37); and a command to watch during the night of the resurrection (38). The last canon hereupon passes into a general exhortation to right living, which forms a sixth part of the whole book. In Riedel's translation we read this for the first time as a connected whole. It falls into two parts, and describes, first, the true life of ordinary Christians, warning them against an empty profession, and laying down many precepts of morality; and then it addresses itself to the "ascete" who "wishes to belong to the rank of the angels," and who lives a life of solitude and poverty. He is encouraged by an exposition, on somewhat strange lines, of the temptations of our Lord, and is specially warned against spiritual pride and contempt of other men. The book closes with an appeal for love and mutual service, based on the parables in St. Matthew xxv.

2. It is impossible to estimate the position of the Canons of Hippolytus without some reference to allied documents (see APOSTOLICAL CONSTITUTIONS). (a) The most important of these is what is now commonly called the *Egyptian Church Order*. This is preserved to us in Coptic and Aethiopic versions, of which Achelis, in his synopsis, gives German translations. The subject-matter and arrangement of these canons correspond generally to those of Hippolytus; but many of the details are modified to bring them into accord with a later practice. A new light was thrown on the criticism of this work by Hauler's discovery (1900) of a Latin version (of which, unfortunately, about half is missing) in the Verona palimpsest, from which he has also given us large Latin fragments of the *Didascalía* (which underlies books i.-vi. of the Apostolic Constitutions, and which hitherto we have only known from the Syriac). The Latin of the Egyptian Church Order is somewhat more primitive than the Coptic, and approaches more nearly, at some points, to the *Canons of Hippolytus*. It has a preface which refers to a treatise *Concerning Spiritual Gifts*, as having immediately preceded it, but neither this nor the Coptic-Aethiopic form has either the introduction or concluding exhortation which is found in the *Canons of Hippolytus*. (b) The *Testament of the Lord* is a document in Syriac, of which the opening part had been published by Lagarde, and of which Rahmani (1899) has given us the whole. It professes to contain instructions given by our Lord to the apostles after the resurrection. After an introduction containing apocalyptic matter, it passes on to give elaborate directions for the ordering of the Church, embodying, in a much-expanded form, the Egyptian Church Order, and showing a knowledge of the preface to that document which appears in the Latin version. It cannot be placed with probability earlier than the latter part of the 4th century. (c) The *Apostolic Constitutions* is a composite document, which probably belongs to the end of the 4th century. Its first six books are an expanded edition of a *Didascalía* which we have already mentioned; its seventh book similarly expands and modifies the *Didachè*; its eighth book begins by treating of "spiritual gifts," and then in c. 3 passes on to expand in like manner the Egyptian Church Order. The hand which has

wrought up all these documents has been shown to be that of the interpolator of the Ignatian Epistles in the longer Greek recension. (d) The *Canons of Basil* is the title of an Arabic work, of which a German translation has been given us by Riedel, who thinks that they have come through Coptic from an original Greek book. They embody, in a modified form, considerable portions of the *Canons of Hippolytus*.

3. We now approach the difficult questions of date and authorship. Much of the material has been quite recently brought to light, and criticism has not had time to investigate and pronounce upon it. Some provisional remarks, therefore, are all that can prudently be made. It seems plain that we have two lines of tradition: (1) The *Canons of Hippolytus*, followed by the *Canons of Basil*; (2) the Egyptian Church Order, itself represented (a) by the Latin version, the *Testament of the Lord*, and the Apostolic Constitutions, which are linked together by the same preface (or portions of it); (b) by the Coptic and Aethiopic versions. Now, the preface of the Latin version points to a time when the canons were embodied in a *corpus* of similar materials, or, at the least, were preceded by a work on "Spiritual Gifts." The *Canons of Hippolytus* have a wholly different preface, and also a long exhortation at the close. The question which criticism must endeavour to answer is, whether the *Canons of Hippolytus* are the original from which the Egyptian Church Order is derived, or whether an earlier body of canons lies behind them both. At present it is probably wise to assume that the latter is the true explanation. For the *Canons of Hippolytus* appear to contain contradictory regulations (*e.g.* cc. 2 and 4 of the presbyters), and also suggest that they have received a considerable supplement (after c. 23). There is, however, no doubt that they present us with a more primitive stage of Church life than we find in the Egyptian Church Order. The mention of subdeacons (which, after Riedel's fresh manuscript evidence, cannot now be dismissed as due to interpolation) makes it difficult to assign a date much earlier than the middle of the 3rd century.

The Puritan severity of the canons well accords with the temper of the writer to whom the Arabic title attributes them; and it is to be noted that the exhortation at the close contains a quotation from 2 Peter actually attributed to the apostle, and Hippolytus is perhaps the earliest author who can with certainty be said to have used this epistle. But the general style of Hippolytus, which is simple, straightforward and strong, is in marked contrast with that of the closing passage of the canons; moreover, his mind, as presented to us in his extant writings, appears to be a much larger one than that of the writer of these canons; it is as difficult to think of Hippolytus as it would be to think of Origen in such a connexion. How, then, are we to account for the attribution? There is evidence to show that Hippolytus was highly revered throughout the East: his writings, which were in Greek, were known, but his history was entirely unknown. He was supposed to be "a pupil (*γυμνάσιος*) of apostles" (Palladius, 4th century), and the Arabic title calls him "chief of the bishops of Rome," *i.e.* archbishop of Rome. It is hard to trust this attribution more than the attribution of a Coptic discourse on the *Dormitio Mariae* to "Evodius, archbishop of the great city Rome, who was the second after Peter the apostle" (*Texts and Studies*, iv. 2-44)—Evodius being by tradition first bishop of Antioch. A whole group of books on Church Order bears the name of Clement of Rome; and the attribution of our canons to Hippolytus may be only an example of the same tendency. The fact that Hippolytus wrote a treatise *Concerning Spiritual Gifts*, and that some such treatise is not only referred to in the Latin preface to the Egyptian Church Order, but is actually found at the beginning of book viii. of the Apostolic Constitutions, introduces an interesting complication; but we cannot here pursue the matter further. Dom Morin's ingenious attribution of the canons to Dionysius of Alexandria (on the ground of Eusebius, *H.E.* vi. 46. 5) cannot be accepted in view of the broader church policy which that writer represents. If the Hippolytean authorship be given up, it is probable that Egypt will make

the strongest claim to be the locality in which the canons were compiled in their present form.

The authorities of chief practical importance are H. Achelis, *Texte u. Unters.* vi. 4 (1891); Rahmani, *Testamentum Domini* (1899); Hauer, *Didascalus Apostolorum* (1900); Riedel, *Kirchenrechtsquellen des Patriarchats Alexandrien* (1900). (J. A. R.)

HIPPOPOTAMUS, of Ephesus, Greek iambic poet. Expelled from Ephesus in 540 B.C. by the tyrant Athenagoras, he took refuge in Clazomenae, where he spent the rest of his life in poverty. His deformed figure and malicious disposition exposed him to the caricature of the Chian sculptors Bupalus and Athenis, upon whom he revenged himself by issuing against them a series of satires. They are said to have hanged themselves like Lycambes and his daughters when assailed by Archilochus, the model and predecessor of Hipponax. His coarseness of thought and feeling, his rude vocabulary, his want of grace and taste, and his numerous allusions to matters of merely local interest prevented his becoming a favourite in Attica. He was considered the inventor of parody and of a peculiar metre, the *scason* or *choliambus*, which substitutes a spondee for the final iambus of an iambic senarius, and is an appropriate form for the burlesque character of his poems.

Fragments in Bergk, *Poetae Lyrici Graeci*; see also B. J. Peltzer, *De parodica Graecorum poeti* (1855), containing an account of Hipponax and the fragments.

HIPPOPOTAMUS ("river-horse," Gr. *ἵππος*, horse and *ποταμός*, river), the name of the largest representative of the non-ruminating artiodactyle ungulate mammals, and its living and extinct relatives. The common hippopotamus (*Hippopotamus amphibius*), which formerly inhabited all the great rivers of Africa but whose range has now been much restricted, is most likely the *behemoth* of Scripture, and may very probably in Biblical times have been found in the Jordan valley, since at a still earlier (Pleistocene) epoch it ranged over a large part of Europe. It typifies not only a genus, but likewise a family, *Hippopotamidae*, distinguished from its relatives the pigs and

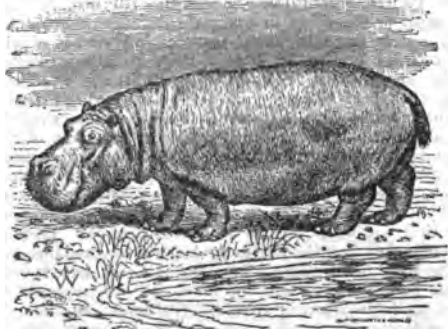

The Hippopotamus (*Hippopotamus amphibius*).

peccaries, or *Suidae*, by the following assemblage of characters: Muzzle very broad and rounded. Feet short and broad, with four subequal toes, bearing short rounded hoofs, and all reaching the ground in walking. Incisors not rooted but continuously growing; those of the upper jaw curved and directed downwards; those of the lower straight and procumbent. Canines very large, curved, continuously growing; upper ones directed downwards. Premolars $\frac{4}{4}$; molars $\frac{3}{3}$. Stomach complex. No caecum.

In form the hippopotamus is a huge, unwieldy creature, measuring in the largest specimens fully 14 ft. from the extremity of the upper lip to the tip of the tail, while it ordinarily attains a length of 12 ft., with a height of 5 ft. at the shoulders, and a girth round the thickest part of the body almost equal to its length. The small ears are exceedingly flexible, and kept in constant motion when the animal is seeking to catch a distant

sound; the eyes are placed high up on the head, but little below the level of the ears; while the gape is wide, and the upper lip thick and bulging so as to cover over even its large tusks when the mouth is closed. The molars, which show trefoil-shaped grinding-surfaces are well adapted for masticating vegetable substances, while the formidable array of long spear-like incisors and curved chisel-edged canines or tusks root up rank grass like an agricultural implement. The legs are short, so that the body is but little elevated above the ground; and the feet, which are small in proportion to the size of the animal, terminate in four short toes each bearing a small hoof. With the exception of a few tufts of hair on the lips, on the sides of the head and neck, and at the extremity of the short robust tail, the skin of the hippopotamus, some portions of which are 2 in. in thickness, is destitute of covering. Hippopotamuses are gregarious animals, living in herds of from 20 to 40 individuals on the banks and in the beds of rivers, in the neighbourhood of which they most readily find appropriate food. This consists chiefly of grass and of aquatic plants, of which these animals consume enormous quantities, the stomach being capable of containing from 5 to 6 bushels. They feed principally by night, remaining in the water during the day, although in districts where they are little disturbed they are less exclusively aquatic. In such remote quarters they put their heads boldly out of the water to blow, but when rendered suspicious they become exceedingly cautious in this respect, only exposing their nostrils above the water, and even this they prefer doing amid the shelter of water plants. In spite of their enormous size and uncouth form, they are expert swimmers and divers, and can remain easily under the water from five to eight minutes. They walk on the bottoms of rivers, beneath at least 1 ft. of water. At nightfall they come on land to feed; and when, as often happens on the banks of the Nile, they reach cultivated ground, they do immense damage to growing crops, destroying by their ponderous tread even more than they devour. To scare away these unwelcome visitors the natives in such districts are in the habit of kindling fires at night. Although hippopotamuses do not willingly go far from the water on which their existence depends, they occasionally travel long distances by night in search of food, and in spite of their clumsy appearance are able to climb steep banks and precipitous ravines with ease. Of a wounded hippopotamus which Sir S. Baker saw leaving the water and galloping inland, he writes: "I never could have imagined that so unwieldy an animal could have exhibited such speed. No man could have had a chance of escape." The hippopotamus does not confine itself to rivers and lakes, but has been known to prefer the waters of the ocean as its home during the day. Of a mild and inoffensive disposition, it seeks to avoid collision with man; when wounded, however, or in defence of its young, it exhibits great ferocity, and native canoes are capsized and occasionally demolished by its infuriated attacks; the bellowing grunt then becoming loud enough to be heard a mile away. As among elephants, so also among hippopotamuses there are "rogues"—old bulls which have become soured in solitude, and are at all times dangerous. Assuming the offensive on every occasion, they attack all and sundry without shadow of provocation; and the natives avoid their haunts, which are usually well known.

The only other living species is the pygmy hippopotamus, *H. (Choeropsis) liberiensis*, of West Africa, an animal not larger than a clumsily made pig of full dimensions, and characterized by having generally one (in place of two) pair of incisors. It is much less aquatic than its giant relative, having, in fact, the habits of a pig.

A small extinct species (*H. lemerlei*) inhabited Madagascar at a comparatively recent date; while other dwarf kinds were natives of Crete (*H. minutus*) and Malta and Sicily (*H. penlandi*) during the Pleistocene. A large form of the ordinary species (*H. amphibius major*) was distributed over Europe as far north as Yorkshire at the same epoch; while an allied species (*H. palacindicus*) inhabited Pleistocene India. Contemporary with the latter was, however, a species (*H. namadicus*) with three pairs of incisors; and "hexaprotodont" hippopotamuses are

also characteristic of the Pliocene of India and Burma (*H. svalensis* and *H. iravadicus*), and of Algeria, Egypt and southern Europe (*H. hipponeusis*).

For the ancestral genera of the hippopotamus line, see **ARTIODACTYLA**.

HIPPURIC ACID (Gr. ἵππος, horse, οὐρον, urine), benzoyl glycolic or benzoyl amidoacetic acid, $C_9H_9NO_3$ or $C_6H_5CO-NH-CH_2-CO_2H$, an organic acid found in the urine of horses and other herbivora. It is excreted when many aromatic compounds, such as benzoic acid and toluene, are taken internally. J. v. Liebig in 1829 showed that it differed from benzoic acid, and in 1830 determined its constitution, while in 1853 V. Dessaignes (*Ann.* 87, p. 325) synthesized it by acting with benzoyl chloride on zinc glycollicide. It is also formed by heating benzoic anhydride with glycollic (Th. Curtius, *Ber.*, 1884, 17, p. 1662), and by heating benzamide with monochloroacetic acid. It crystallizes in rhombic prisms which are readily soluble in hot water, melt at 187° C. and decompose at about 240° C. It is readily hydrolysed by hot caustic alkalis to benzoic acid and glycollic. Nitrous acid converts it into benzoyl glycollic acid, $C_6H_5CO-O-CH_2-CO_2H$. Its ethyl ester reacts with hydrazine to form hippuryl hydrazine, $C_6H_5CO-NH-CH_2-CO-NH-NH_2$, which was used by Curtius for the preparation of azoimide (*q.v.*).

HIPURNIAS, a tribe of South American Indians, 2000 or 3000 in number, living on the river Purus, western Brazil. Their houses are long, low and narrow: the side walls and roof are one, poles being fixed in the ground and then bent together so as to meet and form a pointed arch for the cross-sections. They use small bark canoes. Their chief weapons are poisoned arrows. They have a native god called Guintiniri.

HIRA, the capital of an Arabian kingdom, founded in the 2nd century A.D., on the western edge of Irak, was situated at 32° N., 44° 20' E., about 4 m. S.E. of modern Nejeff, by the Sa'ade canal, on the shore of the Bahr Nejeff or Assyrium Stagnum. Its kings governed the western shore of the lower Euphrates and of the Persian Gulf, their kingdom extending inland to the confines of the Nejd. This Lakhmid kingdom was more or less dependent, during the four centuries of its existence, on the Sassanian empire, to which it formed a sort of buffer state towards Arabia. After the battle of Kadesiya and the founding of Kufa by the Arabs, Hira lost its importance and fell into decay. The ruin mounds covering the ancient site, while extensive, are insignificant in appearance and give no indications of the existence of important buildings.

HIRADO, an island belonging to Japan, 19½ m. long and 6 m. wide, lying off the west coast of the province of Hizen, Kiushiu, in 33° 15' N. and 129° 25' E. It is celebrated as the site of the original Dutch factory—often erroneously written Firando—and as the place where one of the finest blue-and-white porcelains of Japan (*Hiradoyaki*) was produced in the 17th and 18th centuries. The kilns are still active.

HIRE-PURCHASE AGREEMENT, in the law of contract, a form of bailment of goods, on credit, which has extended very considerably of late years. Originally applied to the sale of the more expensive kinds of goods, such as pianos and articles of furniture, the hire-purchase agreement has now been extended to almost every description. The agreement is usually in writing, with a stipulation that the payments to purchase shall be by weekly, monthly or other instalments. The agreement is virtually one to purchase, but in order that the vendor may be able to recover the goods at any time on non-payment of an instalment, it is treated as an agreement to let and hire, with a provision that when the last instalment has been paid the goods shall become the property of the hirer. A clause provides that in case of default of any instalment, or breach of any part of the agreement, all previous payments shall be forfeited to the lender, who can forcibly recover the goods. Such agreements, therefore, do not pass the property in the goods, which remains in the lender until all the instalments have been paid. But the terms of the agreement may sometimes purposely obscure the nature of the transaction between the parties, where, for example, the hire-purchase is merely to create a security for money. In such

a case a judge will look to the true nature of the transaction. If it is not a real letting and hiring, the agreement will require registration under the Bills of Sale Acts. If the agreement contains words to the effect that a person has "bought or agreed to buy" goods, the transaction comes under the Factors Act 1889, and the person in possession of the goods may dispose of them and give a good title. The doctrine of reputed ownership, by which a bankrupt is deemed the reputed owner of goods in his apparent possession, has been somewhat modified by trade customs, in accordance with which property is frequently let out on the hire-purchase system (see **BANKRUPTCY**).

HIRING (from O. Eng. *hýrian*, a word common to many Teutonic languages cf. Ger. *heuern*, Dutch *huwen*, &c.), in law, a contract by which one man grants the use of a thing to another in return for a certain price. It corresponds to the *locatio-conductio* of Roman law. That contract was either a letting of a thing (*locatio-conductio rei*) or of labour (*locatio operarum*). The distinguishing feature of the contract was the price. Thus the contracts of *mutuum*, *commodatum*, *depositum* and *mandatum*, which are all gratuitous contracts, become, if a price is fixed, cases of *locatio-conductio*. In modern English law the term can scarcely be said to be used in a strictly technical sense. The contracts which the Roman law grouped together under the head of *locatio-conductio*—such as those of landlord and tenant, master and servant, &c.—are not in English law treated as cases of hiring but as independent varieties of contract. Neither in law books nor in ordinary discourse could a tenant farmer be said to hire his land. Hiring would generally be applied to contracts in which the services of a man or the use of a thing are engaged for a short time.

Hiring Fairs, or *Statute Fairs*, still held in Wales and some parts of England, were formerly an annual fixture in every important country town. These fairs served to bring together masters and servants. The men and maids seeking work stood in rows, the males together and the females together, while masters and mistresses walked down the lines and selected those who suited them. Originally these hiring-fairs were always held on Martinmas Day (11th of November). Now they are held on different dates in different towns, usually in October or November. In Cumberland the men seeking work stood with straws in their mouths. In Lincolnshire the bargain between employer and employed was closed by the giving of the "fasten-penny," the earnest money, usually a shilling, which "fastened" the contract for a twelvemonth. Some few days after the Statute Fair it was customary to hold a second called a Mop Fair or Runaway Mop. "Mop" (from Lat. *mappa*, napkin, or small cloth) meant in Old English a tuft or tassel, and the fair was so called, it is suggested, in allusion to tufts or badges worn by those seeking employment. Thus the carter wore whipcord on his hat, the cowherd a tuft of cow's hair, and so on. Another possible explanation would be to take the word "mop" in its old provincial slang sense of "a fool," mop fair being the fools' fair, a sort of last chance offered to those who were too dull or slovenly-looking to be hired at the statute fair. Perhaps "runaway" suggests the idea of those absent through drunkenness, or those who simply feared to face the ordeal of the larger hiring and so ran away.

HIROSAKI, a town of Japan in the province of Michmoku or Rikuchiu, north Nippon, 22 m. S.W. of Aomori by rail. Pop. about 37,000. The fine isolated cone of Iwakisan, a mountain of pilgrimage, rises to the west. Hiroasaki is a very old place, formerly residence of a great daimio (or daimyo) and capital of a vast principality, and still the seat of a high court with jurisdiction over the surrounding districts of Aomori and Akita. Like most places in north Nippon, it is built with continuous verandas extending from house to house, and affording a promenade completely sheltered from the snows of winter. Apples of fine flavour grow in the district, which also enjoys some reputation for its peculiar green lacquer-ware.

HIROSHIGE (1797-1858), Japanese artist, was one of the principal members of that branch of the *Ukiyo-ye* or Popular School of Painting in Japan, a school which chiefly made

colour-prints. His family name was Andō Tokitarō; that under which he is known having been, in accordance with Japanese practice, adopted by him in recognition of the fact that he was a pupil of Toyohiro. The earliest reference to him is in the account given by an inhabitant of the Lu-chu islands of a visit to Japan; where a sketch of a procession drawn with great skill by Hiroshige at the age of ten years only is mentioned as one of the remarkable sights seen. At the age of fifteen he applied unsuccessfully to be admitted to the studio of the elder Toyokuni; but was eventually received by Toyohiro. On the death of the latter in 1828, he began to practise on his own account, but finding small encouragement at Yedo (Tōkyō) he removed to Kiōto, where he published a set of landscapes. He soon returned to Yedo, where his work soon became popular, and was imitated by other artists. He died in that city on the 6th day of the 9th month of the year, Ansei 5th, at the age of sixty-two, and was buried at Asakusa. One of his pupils, Hironobu, received from him the name of Hiroshige II. and another, Ando Tokubei, that of Hiroshige III. All three were closely associated with the work signed with the name of the master. Hiroshige II. some time after the year 1863 fell into disgrace and was compelled to leave Yedo for Nagasaki, where he died; Hiroshige III. then called himself Hiroshige II. He died in 1896. The earlier prints by these artists, whose work can hardly be separated, are of extraordinary merit. They applied the process of colour block printing to the purposes of depicting landscape, with a breadth, skill and suitability of convention that has been equalled only by Hokusai in Japan, and by no European. Most of their subjects were derived from the neighbourhood of Yedo, or were scenes on the old high road—the Tokaidō—that ran from that city to Kiōto. The two elder of the name were competent painters, and pictures and drawings by them are occasionally to be met with.

See E. F. Strange, "Japanese Colour-prints" (*Victoria and Albert Museum Handbook*, 1904).

HIROSHIMA, a city and seaport of Japan, capital of the government of its name in central Nippon. Pop. (1903) 113,645. It is very beautifully situated on a small plain surrounded by hills, the bay being studded with islands. In its general aspect it resembles Osaka, from which it is 190 m. W. by rail, and next to that place and Hiogo it is the most important commercial centre on the Inland Sea. The government has an area of about 3000 sq. m., with a population of about 1,500,000. Hiroshima is famous all over Japan owing to its association with the neighbouring islet of Itaku-Shima, "Island of Light," which is dedicated to the goddess Bentin and regarded as one of the three wonders of Japan. The chief temple dates from the year 587, and the island, which is inhabited largely by priests and their attendants, is annually visited by thousands of pilgrims. But the hallowed soil is never tilled, so that all provisions have to be brought from the surrounding districts.

HIRPINI (from an Oscan or Sabine stem *hirpo*, "wolf"), an inland Samnite tribe in the south of Italy, whose territory was bounded by that of the Lucani on the S., the Campani on the S.W., the Appuli (Apuli) and Frentani on the E. and N.E. On the N. we find them, politically speaking, identified with the Pentri and Caraceni, and with them constituting the Samnite alliance in the wars of the 4th century B.C. (see **SAMNITES**). The Roman policy of separation cut them off from these allies by the foundation of Beneventum in 268 B.C., and henceforward they are a separate unit; they joined Hannibal in 216 B.C., and retained their independence until, after joining in the Social war, which in their part of Italy can hardly be said to have ceased till the final defeat of the Samnites by Sulla in 83 B.C., they received the Roman franchise. Of their Oscan speech, besides the evidence of their place-names, only a few fragments survive (R. S. Conway, *The Italic Dialects*, pp. 170 ff.; and for *hirpo*, *ib.* p. 200). In the ethnology of Italy the Hirpini appear from one point of view as the purest type of Saffine stock, namely, that in which the proportion of ethnica formed with the suffix *-no* is highest, thirty-three out of thirty-six tribal or municipal epithets being formed thereby (e.g. *Caudini*, *Compsani*) and only

one with the suffix *-ti* (*Abellinates*), where it is clearly secondary. On the significance of this see **SABINI**. (R. S. C.)

HIRSAU (formerly *Hirschau*), a village of Germany, in the kingdom of Württemberg, on the Nagold and the Pforzheim-Horb railway, 2 m. N. of Calw. Pop. 800. Hirsau has some small manufactures, but it owes its origin and historical interest to its former Benedictine monastery, *Monasterium Hirsaugiense*, at one period one of the most famous in Europe. Its picturesque ruins, of which only the chapel with the library hall are still in good preservation, testify to the pristine grandeur of the establishment. It was founded about 830 by Count Erlafried of Calw, at the instigation of his son, Bishop Notting of Vercelli, who enriched it with, among other treasures, the body of St Aurelius. Its first occupants (838) were a colony of fifteen monks from Fulda, disciples of Hrabanus Maurus and Walafrid Strabo, headed by the abbot Lüdebert. During about a century and a half, under the fostering care of the counts of Calw, it enjoyed great prosperity, and became an important seat of learning; but towards the end of the 10th century the ravages of the pestilence combined with the rapacity of its patrons, and the selfishness and immorality of its inmates, to bring it to the lowest ebb. After it had been desolate and in ruins for upwards of sixty years it was rebuilt in 1059, and under Abbot William—Wilhelm von Hirsau—abbot from 1069 to 1091, it more than regained its former splendour. By his *Constitutiones Hirsaugienses*, a new religious order, the *Ordo Hirsaugiensis*, was formed, the rule of which was afterwards adopted by many monastic establishments throughout Germany, such as those of Blaubeuren, Erfurt and Schaffhausen. The friend and correspondent of Pope Gregory VII., and of Anselm of Canterbury, Abbot William took active part in the politico-ecclesiastical controversies of his time; while a treatise from his pen, *De musica et tonis*, as well as the *Philosophicarum et astronomicarum institutionum libri iii.*, bears witness to his interest in science and philosophy. About the end of the 12th century the material and moral welfare of Hirsau was again very perceptibly on the decline; and it never afterwards again rose into importance. In consequence of the Reformation it was secularized in 1558; in 1692 it was laid in ruins by the French. The *Chronicon Hirsaugiense*, or, as in the later edition it is called, *Annales Hirsaugienses* of Abbot Trithemius (Basel, 1559; St Gall, 1690), is, although containing much that is merely legendary, an important source of information, not only on the affairs of this monastery, but also on the early history of Germany. The *Codex Hirsaugiensis* was edited by A. F. Gröber and printed at Stuttgart in 1843.

See Steck, *Das Kloster Hirschau* (1844); Helmsdorfer, *Forschungen zur Geschichte des Abts Wilhelm von Hirschau* (Göttingen, 1874); Weizsäcker, *Führer durch die Geschichte des Klosters Hirschau* (Stuttgart, 1898); Süßmann, *Forschungen zur Geschichte des Klosters Hirschau* (Halle, 1903); Gieseke, *Die Hirschauer während des Investiturstreits* (Gotha, 1883); C. H. Klaiber, *Das Kloster Hirschau* (Tübingen, 1886); and Baer, *Die Hirsauers Bauschule* (Freiburg, 1897).

HIRSCH, MAURICE DE, BARON HIRSCH AUF GEREUTH, in the baronage of Bavaria (1831–1896), capitalist and philanthropist (German by birth, Austro-Hungarian by domicile), was born at Munich, 9th December 1831. His grandfather, the first Jewish landowner in Bavaria, was ennobled with the *prädikat* "auf Gereuth" in 1818; his father, who was banker to the Bavarian king, was created a baron in 1866. The family for generations has occupied a prominent position in the German Jewish community. At the age of thirteen young Hirsch was sent to Brussels to school, but when seventeen years old he went into business. In 1855 he became associated with the banking house of Bischoffshelm & Goldschmidt, of Brussels, London and Paris. He amassed a large fortune, which he increased by purchasing and working railway concessions in Austria, Turkey and the Balkans, and by speculations in sugar and copper. While living in great splendour in Paris and London and on his estates in Hungary, he devoted much of his time to schemes for the relief of his Hebrew co-religionists in lands where they were persecuted and oppressed. He took a deep interest in the educational work of the Alliance Israélite Universelle, and on two occasions presented the society

with gifts of a million francs. For some years he regularly paid the deficits in the accounts of the Alliance, amounting to several thousand pounds a year. In 1889 he capitalized his donations and presented the society with securities producing an annual income of £16,000. On the occasion of the fortieth anniversary of the emperor Francis Joseph's accession to the Austrian throne he gave £500,000 for the establishment of primary and technical schools in Galicia and the Bukowina. The greatest charitable enterprise on which he embarked was in connexion with the persecution of the Jews in Russia (see ANTI-SEMITISM). He gave £10,000 to the funds raised for the repatriation of the refugees in 1882, but, feeling that this was a very lame conclusion to the efforts made in western Europe for the relief of the Russian Jews, he offered the Russian Government £2,000,000 for the endowment of a system of secular education to be established in the Jewish pale of settlement. The Russian Government was willing to accept the money, but declined to allow any foreigner to be concerned in its control or administration. Thereupon Baron de Hirsch resolved to devote the money to an emigration and colonization scheme which should afford the persecuted Jews opportunities of establishing themselves in agricultural colonies outside Russia. He founded the Jewish Colonization Association as an English society, with a capital of £2,000,000, and in 1892 he presented to it a further sum of £7,000,000. On the death of his wife in 1899 the capital was increased to £11,000,000, of which £1,250,000 went to the Treasury, after some litigation, in death duties. This enormous fund, which is probably the greatest charitable trust in the world, is now managed by delegates of certain Jewish societies, chiefly the Anglo-Jewish Association of London and the Alliance Israélite Universelle of Paris, among whom the shares in the association have been divided. The association, which is prohibited from working for profit, possesses large colonies in South America, Canada and Asia Minor. In addition to its vast agricultural work it has a gigantic and complex machinery for dealing with the whole problem of Jewish persecution, including emigration and distributing agencies, technical schools, co-operative factories, savings and loan banks and model dwellings in the congested Russian Jewries. It also subventions and assists a large number of societies all over the world whose work is connected with the relief and rehabilitation of Jewish refugees. Besides this great organization, Baron de Hirsch founded in 1891 a benevolent trust in the United States for the benefit of Jewish immigrants, which he endowed with £493,000. His minor charities were on a princely scale, and during his residence in London he distributed over £100,000 among the local hospitals. It was in this manner that he disposed of the whole gross proceeds derived from his successes on the English turf, of which he was a lavish patron. He raced, as he said himself, "for the London hospitals," and in 1892, when his filly, La Flèche, won the Oaks, St Leger and One Thousand Guineas, his donations from this source amounted to about £40,000. Baron de Hirsch married on 28th June 1855 Clara, daughter of Senator Bischoffsheim of Brussels (b. 1833), by whom he had a son and daughter, both of whom predeceased him. He died at Ogyalla, near Komorn, in Hungary, 21st April 1896. The baroness, who seconded her husband's charitable work with great munificence—their total benefactions have been estimated at £18,000,000,—died at Paris on the 1st of April 1899.

For details of Baron de Hirsch's chief charities see the annual reports of the Alliance Israélite Universelle and of the "Administration Centrale" of the Jewish Colonization Association. (L. W.)

HIRSCH, SAMSON RAPHAEL (1808–1888), Jewish theologian, was born in Hamburg in 1808 and died at Frankfurt-on-the-Main in 1888. He opposed the reform tendency of Geiger (*q.v.*), and presented Jewish orthodoxy in a new and attractive light. His philosophical conception of tradition, associated as it was with conservatism in ritual practice, created what is often known as the Frankfort "Neo-Orthodoxy." Hirsch exercised a profound influence on the Synagogue and undoubtedly stemmed the tide of liberalism. His famous *Nineteen Letters* (1836), with which the Neo-Orthodoxy began, were translated into English by Drachmann (New York, 1899). Other works by Hirsch were

Hovot, and commentaries on the Pentateuch and Psalms. These are marked by much originality, but their exegesis is fanciful. Three volumes of his essays have been published (1902–1908); these were collected as *Gesammelte Schriften* from his periodical *Jeschurun*.

For Hirsch's religious philosophy see S. A. Hirsch, *A Book of Essays* (London, 1905).

HIRSCHBERG, a town of Germany, in the Prussian province of Silesia, beautifully situated at the confluence of the Bober and Zacken, 1120 ft. above the sea-level, 48 m. S.E. of Görlitz, on the railway to Glatz, with branches to Grünthal and Schmiedeberg. Pop. (1905) 19,317. It is surrounded by pleasant promenades occupying the site of its former fortifications. It possesses an Evangelical church, the church of the Holy Cross, one of the six *Gnaden Kirchen* for the Silesian Protestants stipulated for in the agreement at Altranstädt between Charles XII. of Sweden and the emperor Joseph I. in 1707, four Roman Catholic churches, one of which dates from the 14th century, a synagogue, several schools, an orphanage and an asylum. The town is the principal emporium of commerce in the Silesian mountains, and its industries include the carding and spinning of wool, and the manufacture of linen and cotton fabrics, yarn, artificial flowers, paper, cement, porcelain, sealing-wax, blacking, chemicals and cider. There is also a lively trade in corn, wine and agricultural produce. The town is celebrated for its romantic surroundings, including the Cavallerberg, from which there is a splendid view, the Hausberg, the Helicon, crowned by a small Doric temple, the Kreuzberg, with walks commanding beautiful views, and the Sattler ravine, over which there is a railway viaduct. Hirschberg was in existence in the 11th century, and obtained town rights in 1108 from Duke Boleslaus of Poland. It withstood a siege by the Hussites in 1427, and an attack of the imperial troops in 1640. The foundation of its prosperity was laid in the 16th century by the introduction of the manufacture of linen and veils.

Hirschberg is also the name of a town of Thuringia on the Saale with manufactures of leather and knives. Pop. 2000.

HIRSON, a town of northern France in the department of Aisne, 35 m. by rail N.E. of Laon, on the Oise. Pop. (1906) 8335. It occupies an important strategic position close to the point of intersection of several railway lines, and not far from the Belgian frontier. For its defence there are a permanent fort and two batteries, near the railway junction. The town carries on the manufacture of glass bottles, tiles, iron and tin goods, wool-spinning and brewing.

HIRTIUS, AULUS (c. 90–43 B.C.), Roman historian and statesman. He was with Julius Caesar as legate in Gaul, but after the civil war broke out in 49 he seems to have remained in Rome to protect Caesar's interests. He was also a personal friend of Cicero. He was nominated with C. Vibius Pansa by Caesar for the consulship of 43; and after the dictator's assassination in March 44, he and his colleague supported the senatorial party against M. Antonius, with whom Hirtius had at first sided. The consuls set out for Mutina, where Antonius was besieging Decimus Brutus. On the 15th of April, Pansa was attacked by Antonius at Forum Gallorum, about 8 m. from Mutina, and lost his life in the engagement. Hirtius, however, compelled Antonius to retire on Mutina, where another battle took place on the 25th (or 27th) of April, in which Hirtius was slain. Of the continuations of Caesar's *Commentaries*—the eighth book of the Gallic war, the history of the Alexandrian, African and Spanish wars—the first is generally allowed to be by Hirtius; the Alexandrian war is perhaps by him (or Oppius); the last two are supposed to have been written at his request, by persons who had taken part in the events described, with a view to subsequent revision and incorporation in his proposed work on military commanders. The language of Hirtius is good, but his style is monotonous and lacks vigour.

Hirtius and the other continuators of Caesar are discussed in M. Schanz, *Geschichte der römischen Literatur*, i.; also R. Schneider, *Bellum Africanum* (1905). For the history of the period see under ANTONIUS; Cicero's *Letters* (ed. Tyrrell and Purser); G. Boissier, *Cicero and his Friends* (Eng. trans., 1897).

HISHĀM IBN AL-KALBĪ [Abū-l-Mundhir Hishām ibn Maḥmūd ibn us-Sa'ib ul-Kalb] d. c. 819), Arabic historian,

was born in Kufa, but spent much of his life in Bagdad. Like his father, on whose authority he relied largely, he collected information about the genealogies and history of the ancient Arabs. According to the *Fihrist* (see NAOLM) he wrote 140 works. As independent works they have almost entirely ceased to exist, but his account of the genealogies of the Arabs is continually quoted in the *Kitāb ul-Aghāni*.

Large extracts from another of his works, the *Kitāb ul-Asnām*, are contained in the *Khizānat ul-Adab* (iii. 242-246) and in the geography of Yāqūt (*q.v.*). These latter have been translated with comments by J. Wellhausen in his *Reste des arabischen Heidentums* (2nd ed., Berlin, 1897). (G. W. T.)

HISPELLUM (mod. Spello, *q.v.*), an ancient town of Umbria, Italy, 3 m. N. of Fulginiae, on the road between it and Perugia, 1030 ft. above sea-level. It does not appear to be mentioned before the time of Augustus, who founded a colony there (*Colonia Julia Hispellum*) and extended its territory to the springs of the Clitumnus, which had originally belonged to the territory of Mevania. It received the name of Flavia Constans by a rescript of the emperor Constantine, a copy of which on a marble tablet is still preserved at Spello. The gate by which the town is entered is ancient and has three portrait statues above it; two other gates and a part of the city wall, built of rectangular blocks of local limestone, may still be seen, as also the ruins of what is supposed to be a triumphal arch (attributed to Augustus) and an amphitheatre, and perhaps of a theatre, close to the modern high-road, outside the town. (T. As.)

HISSAR, a district in Central Asia, lying between 66° 30' and 70° E. and 30° 15' and 37° N. and dependent on the amir of Bokhara. It forms that part of the basin of the Amu-darya or Oxus which lies on the north side of the river, opposite the Afghan province of Balkh. The western prolongation of the Tian-shan, which divides the basin of the Zarafshan from that of the upper Amu, after rising to a height of 12,300 ft., bifurcates in 67° 45' E. The main chain, the southern arm of this bifurcation, designated the Hissar range, but sometimes called also Koh-i-tau, forms the N. and N.W. boundaries of Hissar. On the W. it is wholly bounded by the desert; the Amu limits it on the S. and S.E.; and Karateghin and Darvas complete the boundary on the E. Until 1875 it was one of the least known tracts of Central Asia. Hissar is traversed from north to south by four tributaries of the Amu, viz. the Surkhab or Vakhsh, Kafirnihan, Surkhan and Shirabad-darya, which descend from the snowy mountains to the north and form a series of fertile valleys, disposed in a fan-shape, within which lie the principal towns. In the N.W. boundary range between Khuzar and Derbent is situated the defile formerly called the Iron Gate (Caspian Gates, Bāb-al-Hadīd, Dar Ahanfir and in Chinese T'ie-mēn-kuan) but now styled Buzghol-khana or the Goat-house. It was also called Kohluga, said to be a Mongol word meaning barrier. This pass is described as a deep but narrow chasm in a transverse range, whose rocks overhang and threaten to choke the tortuous and gloomy corridor (in places but five paces wide) which affords the only exit from the valley. In ancient times it was a vantage point of much importance and commanded one of the chief routes between Turkestan and India. Hsüan Tsang, the Chinese traveller, who passed through it in the 7th century, states that there were then two folding doors or gates, cased with iron and hung with bells, placed across the pass. Clavijo, the Spanish ambassador to the court of Timur, heard of this when he passed through the defile nearly 800 years later, but the gates had then disappeared.

The Surkhan valley is highly cultivated, especially in its upper portion. It supplies Bokhara with corn and sheep, but its chief products are rice and flax. The town of Hissar (pop. 15,000) commands the entrance into the fertile valleys of the Surkhan and Kafirnihan, just as Kabadian at the southern end of the latter defends them from the south. Hissar was long famous for its damascened swords and its silk goods. Kulab produces wheat in abundance, and gold is brought thither from the surrounding districts. Kabadian is a large, silk-producing town, and is surrounded with rice-fields.

The population consists principally of Uzbegs and Tajiks,

the former predominating and gradually pushing the Tajiks into the hills. On the banks of the Amu there are Turkomans who work the ferries, drive sheep and accompany caravans. Lyuli (gipsies), Jews, Hindus and Afghans are other elements of the population. The climate of the valleys of Hissar and Kulab is pleasant, as they are protected by mountains to the north and open towards the south. They produce all the cereals and garden plants indigenous to Central Asia. Cotton is grown in the district of Shirabad; and cotton, wheat, flax, sheep and rock-salt are all exported.

History.—This country was anciently part of the Persian empire of the Achaemenidae, and probably afterwards of the Graeco-Bactrian kingdom, and then subject to the invading Asiatic tribes who broke up that kingdom, e.g. the Yue-chi. It was afterwards conquered by the Ephthalites or White Huns, who were subdued by the Turks in the early part of the 7th century. It then became subject successively to the Mahomedan invaders from Persia, and after to the Mongol dynasty of Jenghiz Khan, and to Timur and his successors. It subsequently became a cluster of Uabeg states and was annexed by the amir of Bokhara (*q.v.*) in 1869-1870, soon after the Russian occupation of Samarkand. (J. T. BE., C. EL.)

HISSAR, a town and district of British India, in the Delhi division of the Punjab. The town is situated on the Rajputana railway and the Western Jumna canal, 102 m. W.N.W. of Delhi. Pop. (1901) 17,647. It was founded in 1356 by the emperor Feroz Shah, who constructed the canal to supply it with water; but this fell into decay during the 18th century, owing to the constant inroads of marauders. Hissar was almost completely depopulated during the famine of 1783, but was afterwards occupied by the famous Irish adventurer George Thomas, who built a fort and collected inhabitants. It is now chiefly known for its cattle and horse fairs, and has a cotton factory.

The DISTRICT comprises an area of 5217 sq. m. It forms the western border district of the great Bikanir desert, and consists for the most part of sandy plains dotted with shrub and brushwood, and broken by undulations towards the south, which rise into hills of rock like islands out of a sea of sand. The Ghaggar is its only river, whose supply is uncertain, depending much on the fall of rain in the lower Himalayas; its overflow in times of heavy rain is caught by *jhils*, which dry up in the hot season. The Western Jumna canal crosses the district from east to west, irrigating many villages. The soil is in places hard and clayey, and difficult to till; but when sufficiently irrigated it is highly productive. Old mosques and other buildings exist in parts of the district. Hissar produces a breed of large milk-white oxen, which are in great request for the carriages of natives. The district has always been subject to famine. The first calamity of this kind of which there is authentic record was in 1783; and Hissar has suffered severely in more recent famines. Its population in 1901 was 781,717, showing practically no increase in the decade, whereas in the previous decade there had been an increase of 15%. The climate is very dry, but westerly winds blowing from the middle of March till July. Cotton weaving, ginning and pressing are carried on. The district is served by the Rajputana-Malwa, the Southern Punjab and the Jodhpur-Bikanir railways. The chief trading centres are Bhiwani, Hausi, Hissar and Sirsa.

Before the Mahomedan conquest, the semi-desert tract of which Hissar district now forms part was the retreat of Chauhan Rajputs. Towards the end of the 18th century the Bhattis of Bhattiana gained ascendancy after bloody struggles. To complete the ruin brought on by these conflicts, nature lent her aid in the great famine of 1783. Hissar passed nominally to the British in 1803, but they could not enforce order till 1810. Early in the mutiny of 1857 Hissar was wholly lost for a time to British rule, and all Europeans were either murdered or compelled to fly. The Bhattis rose under their hereditary chiefs, and the majority of the Mahomedan population followed their example. Before Delhi had been recovered, the rebels were utterly routed.

HISTIAEUS (d. 494 B.C.), tyrant of Miletus under the Persian king Darius Hystaspis. According to Herodotus he rendered great service to Darius while he was campaigning in Scythia by persuading his fellow-despots not to destroy the bridge over the Danube by which the Persians must return. Choosing his own reward for this service, he became possessor of territory near Myrcinus (afterwards Amphipolis), rich in timber and minerals. The success of his enterprise led to his being invited to Susa, where in the midst of every kind of honour he was virtually a prisoner of Darius, who had reason to dread his growing power in Ionia. During this period the Greek cities were left under native despots supported by Persia, Aristagoras, son-in-law of Histiaeus, being ruler of Miletus in his stead. This prince, having failed against Naxos in a joint expedition with the satrap Artaphernes, began to stir up the Ionians to revolt, and this result was brought to pass, according to Herodotus, by a secret message from Histiaeus. The revolt assumed a formidable character and Histiaeus persuaded Darius that he alone could quell it. He was allowed to leave Susa, but on his arrival at the coast found himself suspected by the satrap, and was ultimately driven to establish himself (Herodotus says as a pirate; more probably in charge of the Bosphorus route) at Byzantium. After the total failure of the revolt at the battle of Lade, he made various attempts to re-establish himself, but was captured by the Persian Harpagus and crucified by Artaphernes at Sardis. His head was embalmed and sent to Darius, who gave it honourable burial. The theory of Herodotus that the Ionian revolt was caused by the single message of Histiaeus is incredible; there is evidence to show that the Ionians had been meditating since about 512 a patriotic revolt against the Persian domination and the "tyrants" on whom it rested (see Grote, *Hist. of Greece*, ed. 1907, especially p. 122 note; art. IONIA, and authorities; also S. Heinlein in *Klio*, 1909, pp. 341-351).

HISTOLOGY (Gr. *hístos*, web, tissue, properly the web-beam of the loom, from *hísthai*, to make to stand), the science which deals with the structure of the tissues of plants and animals (see **CYTOLOGY**).

HISTORY. The word "history" is used in two senses. It may mean either the record of events, or events themselves. Originally (see below) limited to inquiry and statement, it was only in comparatively modern times that the meaning of the word was extended to include the phenomena which form or might form their subject. It was perhaps by a somewhat careless transference of ideas that this extension was brought about. Now indeed it is the commoner meaning. We speak of the "history of England" without reference to any literary narrative. We term kings and statesmen the "makers of history," and sometimes say that the historian only records the history which they make. History in this connexion is obviously not the record, but the thing to be recorded. It is unfortunate that such a double meaning of the word should have grown up, for it is productive of not a little confusion of thought.

History in the wider sense is all that has happened, not merely all the phenomena of human life, but those of the natural world as well. It includes everything that undergoes change; and as modern science has shown that there is nothing absolutely static, therefore the whole universe, and every part of it, has its history. The discovery of ether brought with it a reconstruction of our ideas of the physical universe, transferring the emphasis from the mathematical expression of static relationships to a dynamic conception of a universe in constant transformation; matter in equipoise became energy in gradual readjustment. Solids are solids no longer. The universe is in motion in every particle of every part; rock and metal merely a transition stage between crystallization and dissolution. This idea of universal activity has in a sense made physics itself a branch of history. It is the same with the other sciences—especially the biological division, where the doctrine of evolution has induced an attitude of mind which is distinctly historical.

But the tendency to look at things historically is not merely the attitude of men of science. Our outlook upon life differs in just this particular from that of preceding ages. We recognize the

unstable nature of our whole social fabric, and are therefore more and more capable of transforming it. Our institutions are no longer held to be inevitable and immutable creations. We do not attempt to fit them to absolute formulae, but continually adapt them to a changing environment. Even modern architecture, notably in America, reflects the consciousness of change. The permanent character of ancient or medieval buildings was fitted only to a society dominated by static ideals. Now the architect builds, not for all time, but for a set of conditions which will inevitably cease in the not distant future. Thus our whole society not only bears the marks of its evolution, but shows its growing consciousness of the fact in the most evident of its arts. In literature, philosophy and political science, there is the same historical trend. Criticism no longer judges by absolute standards; it applies the standards of the author's own environment. We no longer condemn Shakespeare for having violated the ancient dramatic laws, nor Voltaire for having objected to the violations. Each age has its own expression, and in judging each we enter the field of history. In ethics, again, the revolt against absolute standards limits us to the relative, and morals are investigated on the basis of history, as largely conditioned by economic environment and the growth of intellectual freedom. Revelation no longer appeals to scientific minds as a source of knowledge. Experience on the other hand is history. As for political science, we do not regard the national state as that ultimate and final product which men once saw in the Roman Empire. It has hardly come into being before forces are evident which aim at its destruction. Internationalism has gained ground in Europe in recent years; and Socialism itself, which is based upon a distinct interpretation of history, is regarded by its followers as merely a stage in human progress, like those which have gone before it. It is evident that Freeman's definition of history as "past politics" is miserably inadequate. Political events are mere externals. History enters into every phase of activity, and the economic forces which urge society along are as much its subject as the political result.

In short the historical spirit of the age has invaded every field. The world-picture presented in this encyclopaedia is that of a dynamic universe, of phenomena in process of ceaseless change. Owing to this insistent change all things which happen, or seem to happen, are history in the broader sense of the word. The encyclopaedia itself is a history of them in the stricter sense,—the description and record of this universal process. This narrower meaning is the subject of the rest of this article.

The word "history" comes from the Gr. *hístoria*, which was used by the Ionians in the 6th century B.C. for the search for knowledge in the widest sense. It meant inquiry, investigation, not narrative. It was not until two centuries later that the *hístōrikos*, the reciter of stories, superseded the *hístōrēn* (*hístōrōs*), the seeker after knowledge. Thus history began as a branch of scientific research,—much the same as what the Athenians later termed philosophy. Herodotus himself was as much a scientific explorer as a reciter of narrative, and his life-long investigation was *hístōriē* in his Ionian speech. Yet it was Herodotus himself who first hinted at the new use of the word, applied merely to the details accumulated during a long search for knowledge. It is not until Aristotle, however, that we have it definitely applied to the literary product instead of the inquiry which precedes it. From Aristotle to modern times, history (Lat. *historia*) has been a form of literature. It is only in the scientific environment of to-day that we recognize once more, with those earliest of the forerunners of Herodotus, that history involves two distinct operations, one of which, investigation, is in the field of science, while the other, the literary presentation, is in the field of art.

The history of history itself is therefore two-fold. History as art flourishes with the arts. It calls upon the imagination and the literary gifts of expression. Its history does not run parallel with the scientific side, but rather varies in inverse ratio with scientific activity. Those periods which have been dominated by the great masters of style have been less interested in the criticism of the historian's methods of investigation than in the beauty of his rhetoric. The scientific historian, deeply interested

in the search for truth, is generally but a poor artist, and his uncoloured picture of the past will never rank in literature beside the splendid distortions which glow in the pages of a Michelet or Macaulay. History the art, in so far as it is conditioned upon genius, has no single traceable line of development. Here the product of the age of Pericles remains unsurpassed still; the works of Herodotus and Thucydides standing along with those of Pheidias as models for all time. On the other hand, history the science has developed so that it has not only gained recognition among historians as a distinct subject, but it has raised with it a group of auxiliary sciences which serve either as tools for investigation or as a basis for testing the results. The advance in this branch of history in the 19th century was one of its greatest achievements. The vast gulf which lies between the history of Egypt by Herodotus and that by Flinders Petrie is the measure of its achievement. By the mechanism now at his disposal the scientific explorer can read more history from the dust-heaps of Abydos than the greatest traveller of antiquity could gather from the priests of Sais. In tracing the history of history we must therefore keep in mind the double aspect.

History itself, this double subject, the science and the art combined, begins with the dawn of memory and the invention of speech. It is wrong to term those ages *pre-historic* whose history has not come down to us, including in one category the pre-literary age and the literary whose traces have been lost. Even the pre-literary had its history, first in myth and then in saga. The saga, or epos, was a great advance upon the myth, for in it the deeds of men replace or tend to replace the deeds of the gods. But we are still largely in the realm of imagination. Poetry, as Thucydides complained, is a most imperfect medium for fact. The bard will exaggerate or distort his story. True history, as a record of what really has happened, first reached maturity in prose. Therefore, although much of the past has been handed down to us in epic, in ballad and in the legends of folk-lore, we must turn from them to what became history in the narrower sense.

The earliest prose origins of history are the inscriptions. Their inadequacy is evident from two standpoints. Their permanence depends not upon their importance, but upon the durability of the substance on which they are inscribed. A note for a wedding ring baked into the clay of Babylon has been preserved, while the history of the greatest events has perished. In the second place they are sealed to all but those who know how to read them, and so they lie forgotten for centuries while oral tradition flourishes,—being within the reach of every man. It is only recently that archaeology, turning from the field of art, has undertaken to interpret for us this first written history. The process by which the modern fits together all the obtainable remains of an antiquity, and reconstructs even that past which left no written record, lies outside the field of this article. But such enlargement of the field of history is a modern scientific product, and is to be distinguished from the imperfect beginnings of history-writing which the archaeologist is able to decipher.

Next to the inscriptions,—sometimes identical with them,—are the early chronicles. These are of various kinds. Family chronicles preserved the memory of heroic ancestors whose deeds in the earliest age would have passed into the keeping of the bards. Such family archives were perhaps the main source for Roman historians. But they are not confined to Rome or Greece. Genealogies also pass from the bald verse, which was the vehicle for oral transmission, to such elaborate tables as those in which Manetho has preserved the dynasties of Egyptian Pharaohs.

In this field the priest succeeds the poet. The temple itself became the chief repository of records. There were simple religious annals, votive tablets recording miracles accomplished at a shrine, lists of priests and priestesses, accounts of benefactions, of prodigies and portents. In some cases, as in Rome, the pontiffs kept a kind of register, not merely of religious history, but of important political events as well. Down to the time of the Gracchi (131 B.C.) the Pontifex Maximus inscribed the year's events upon annual tablets of wood which were preserved in the *Regia*, the official residence of the pontiff in the Forum. These

pontifical "annals" thus came to be a sort of civic history. Chronicles of the Greek cities were commonly ascribed to mythical authors, as for instance that of Miletus, the oldest, so Cadmus the inventor of letters. But they were continued and edited by men in whom the critical spirit was awakening, as when the chronicles of Ionian towns began the criticism of Homer.

The first historians were the logographi of these Ionian cities; men who carried their inquiry (*historiē*) beyond both written record and oral tradition to a study of the world around them. Their "saying" (*logos*) was gathered mostly from contemporaries; and upon the basis of a widened experience they became critics of their traditions. The opening lines of Hecataeus of Miletus begin the history of the true historic spirit in words which read like a sentence from Voltaire. "Hecataeus of Miletus thus speaks: I write as I deem true, for the traditions of the Greeks seem to me manifold and laughable." Those words mark an epoch in the history of thought. They are the introduction to historical criticism and scientific investigation. Whatever the actual achievement of Hecataeus may have been, from his time onward the scientific movement was set going. Herodotus of Halicarnassus struggled to rationalize mythology, and established chronology on a solid basis. And finally Herodotus, a professional story-teller, rose to the height of genuine scientific investigation. Herodotus' inquiry was not simply that of an idle tourist. He was a critical observer, who tested his evidence. It is easy for the student now to show the inadequacy of his sources, and his failure here or there to discriminate between fact and fable. But given the imperfect medium for investigation and the absence of an archaeological basis for criticism, the work of Herodotus remains a scientific achievement, as remarkable for its approximation to truth as for the vastness of its scope. Yet it was Herodotus' chief glory to have joined to this scientific spirit an artistic sense which enabled him to cast the material into the truest literary form. He gathered all his knowledge of the ancient world, not simply for itself, but to mass it around the story of the war between the east and west, the Greeks and the Persians. He is first and foremost a story-teller; his theme is like that of the bards, a heroic event. His story is a vast prose epos, in which science is to this extent subordinated to art. "This is the showing forth of the Inquiry of Herodotus of Halicarnassus, to the end that neither the deeds of men may be forgotten by lapse of time, nor the works, great and marvellous, which have been produced, some by Hellenes, some by Barbarians, may lose their renown, and especially that the causes may be remembered for which these waged war with one another" (*i.e.* the Persian war).

In Thucydides a higher art than that of Herodotus was combined with a higher science. He scorned the story-teller "who seeks to please the ear rather than to speak the truth," and yet his rhetoric is the culmination of Greek historical prose. He withdrew from vulgar applause, conscious that his narrative would be considered "disappointing to the ear," yet he recast the materials out of which he constructed it in order to lift that narrative into the realm of pure literature. Speeches, letters and documents are reworded to be in tone with the rest of the story. It was his art, in fact, which really created the Peloponnesian war out of its separate parts. And yet this art was merely the language of a scientist. The "laborious task" of which he speaks is that of consulting all possible evidence, and weighing conflicting accounts. It is this which makes his rhetoric worth while, "an everlasting possession, not a prize competition which is heard and forgotten."

From the sublimity of Thucydides, and Xenophon's straightforward story, history passed with Theopompus and Ephorus into the field of rhetoric. A revival of the scientific instinct of investigation is discernable in Timaeus the Sicilian, at the end of the 4th century, but his attack upon his predecessors was the text of a more crushing attack upon himself by Polybius, who declares him lacking in critical insight and biased by passion. Polybius' comments upon Timaeus reach the dignity of a treatise upon history. He protests against its use for controversial pamphlets which distort the truth. "Directly a man assumes the moral attitude of an historian he ought to forget all

considerations, such as love of one's friends, hatred of one's enemies.... He must sometimes praise enemies and blame friends. For as a living creature is rendered useless if deprived of its eyes, so if you take truth from History, what is left but an unprofitable tale" (bk. xii. 14). These are the words of a Ranker. Unfortunately Polybius, like most modern scientific historians, was no artist. His style is the very opposite of that of Isocrates and the rhetoricians. It is often only clear in the light of inscriptions, so closely does it keep to the sources. The style found no imitator; history passed from Greece to Rome in the guise of rhetoric. In Dionysius of Halicarnassus the rhetoric was combined with an extensive study of the sources; but the influence of the Greek rhetoricians upon Roman prose was deplorable from the standpoint of science. Cicero, although he said that the duty of the historian is to conceal nothing true, to say nothing false, would in practice have written the kind of history that Polybius denounced. He finds fault with those who are *non exornatores rerum sed lautum narratores*. History for him is the mine from which to draw argument in oratory and example in education. It is not the subject of a scientific curiosity.

It should be noted before we pass to Rome that with the expansion of Hellenism the subject of historians expanded as well. Universal history was begun by Ephorus, the rhetorician, and formed the theme of Polybius and Diodorus. Exiled Greeks were the first to write histories of Rome worthy of the name. The Alexandrian Eratosthenes placed chronology upon the scientific basis of astronomy, and Apollodorus drew up the most important *chronica* of antiquity.

History-writing in Rome,—except for the Greek writers resident there,—was until the first half of the 1st century B.C. in the form of annals. Then came rhetorical ornamentation,—and the Ciceronian era. The first Roman historian who rose to the conception of a science and art combined was Sallust, the student of Thucydides. The Augustan age produced in Livy a great popular historian and natural artist and a trained rhetorician (in the speeches),—but as uncritical and inaccurate as he was brilliant. From Livy to Tacitus the gulf is greater than from Herodotus to Thucydides. Tacitus is at least a consummate artist. His style ranges from the brilliancy of his youth to the sternness and sombre gravity of age, passing almost to poetic expression in its epigrammatic terseness. Yet in spite of his searching study of authorities, his keen judgment of men, and his perception of underlying principles of moral law, his view was warped by the heat of faction, which glows beneath his external objectivity. After him Roman history-writing speedily degenerated. Suetonius' *Lives of the Caesars* is but a superior kind of journalism. But his gossip of the court became the model for historians, whose works, now lost, furnish the main source for the *Historia Augusta*. The importance to us of this uncritical collection of biographies is sufficient comment on the decline of history-writing in the latter empire. Finally, from the 4th century the epitomes of Eutropius and Festus served to satisfy the lessening curiosity in the past and became the handbooks for the middle ages. The single figure of Ammianus Marcellinus stands out of this age like a belated disciple of Tacitus. But the world was changing from antique to Christian ideals just as he was writing, and with him we leave this outline of ancient history.

The 4th and 5th centuries saw a great revolution in the history of history. The story of the pagan past slipped out of mind, and in its place was set, by the genius of Eusebius, the story of the world force which had superseded it, Christianity, and of that small fraction of antiquity from which it sprang,—the Jews. Christianity from the first had forced thinking men to reconstruct their philosophy of history, but it was only after the Church's triumph that its point of view became dominant in historiography. Three centuries more passed before the pagan models were quite lost to sight. But from the 7th century to the 17th—from Isidore of Seville and the English Bede for a thousand years,—mankind was to look back along the line of Jewish priests and kings to the Creation. Egypt was of interest only as it came into Israelite history, Babylon and Nineveh were

to illustrate the judgments of Yahweh, Tyre and Sidon to reflect the glory of Solomon. The process by which the "gentiles" have been robbed of their legitimate history was the inevitable result of a religion whose sacred books make them lay figures for the history of the Jews. Rejected by the Yahweh who became the Christian God, they have remained to the present day, in Sunday schools and in common opinion, not nations of living men, with the culture of arts and sciences, but outcasts who do not enter into the divine scheme of the world's history. When a line was drawn between pagan and Christian back to the creation of the world, it left outside the pale of inquiry nearly all antiquity. But it must be remembered that that antiquity was one in which the German nations had no personal interest. Scipio and the Gracchi were essentially unreal to them. The one living organization with which they came into touch was the Church. So Cicero and Pompey paled before Joshua and Paul. Diocletian, the organizing genius, became a bloodthirsty monster, and Constantine, the murderer, a saint.

Christian history begins with the triumph of the Church. With Eusebius of Caesarea the apologetic pamphlets of the age of persecutions gave way to a calm review of three centuries of Christian progress. Eusebius' biography of Constantine shows what distortion of fact the father of Church history permitted himself, but the Ecclesiastical History was fortunately written for those who wanted to know what really happened, and remains to-day an invaluable repository of Christian antiquities. With the continuations of Socrates, Sozomen and Theodoret, and the Latin manual which Cassiodorus had woven from them (the *Historia tripartita*), it formed the body of Church history during all the middle ages. An even greater influence, however, was exercised by Eusebius' *Chronica*. Through Jerome's translation and additions, this scheme of this world's chronology became the basis for all medieval world chronicles. It settled until our own day the succession of years from the Creation to the birth of Christ,—fitting the Old Testament story into that of ancient history. Henceforth the Jewish past,—that one path back to the beginning of the world,—was marked out by the absolute laws of mathematics and revelation. Jerome had marked it out; Sulpicius Severus, the biographer of St Martin, in his *Historia sacra*, adorned it with the attractions of romance. Sulpicius was admirably fitted to interpret the miraculous Bible story to the middle ages. But there were few who could write like him, and Jerome's *Chronicle* itself, or rather portions of it, became, in the age which followed, a sort of universal preface for the monastic chronicler. For a time there were even attempts to continue "imperial chronicles," but they were insignificant compared with the influence of Eusebius and Jerome.

From the first, Christianity had a philosophy of history. Its earliest apologists sought to show how the world had followed a divine plan in its long preparation for the life of Christ. From this central fact of all history, mankind should continue through war and suffering until the divine plan was completed at the judgment day. The fate of nations is in God's hands; history is the revelation of His wisdom and power. Whether He intervenes directly by miracle, or merely sets His laws in operation, He is master of men's fate. This idea, which has underlain all Christian philosophy of history, from the first apologists who prophesied the fall of the Empire and the coming of the millennium, down to our own day, received its classic statement in St Augustine's *City of God*. The terrestrial city, whose eternity had been the theme of pagan history, had just fallen before Alaric's Goths. Augustine's explanation of its fall passes in review not only the calamities of Roman history,—combined with a pathetic perception of its greatness,—but carries the survey back to the origin of evil at the creation. Then over against this *civitas terrena* he sets the divine city which is to be realized in Christendom. The Roman Empire,—the last general form of the earthly city,—gives way slowly to the heavenly. This is the main thread of Augustine's philosophy of history. The mathematical demonstration of its truth was left by Augustine for his disciple, Paulus Orosius.

Orosius' *Seven Books of Histories against the Pagans*, written

as a supplement to the *City of God*, is the first attempt at a Christian "World History." This manual for the middle ages arranged the rise and fall of empires with convincing exactness. The history of antiquity, according to it, begins with Ninus. His realm was overthrown by the Medes in the same year in which the history of Rome began. From the first year of Ninus' reign until the rebuilding of Babylon by Semiramis there were sixty-four years; the same between the first of Procas and the building of Rome. Eleven hundred and sixty-four years after each city was built, it was taken,—Babylon by Cyrus, Rome by Alaric, and Cyrus' conquest took place just when Rome began the Republic. But before Rome becomes a world empire, Macedonia and Carthage intervene, guardians of Rome's youth (*ulor curatorque*). This scheme of the four world-monarchies, which was to prevail through all the middle ages, was developed through seven books filled with the story of war and suffering. As it was Orosius' aim to show that the world had improved since the coming of Christ, he used Trogus Pompeius' war history, written to exalt Roman triumphs, to show the reverse of victory,—disaster and ruin. Livy, Caesar, Tacitus and Suetonius were plundered for the story of horrors; until finally even the Goths in Spain shine by contrast with the pagan heroes; and through the confusion of the German invasions one may look forward to Christendom,—and its peace.

† The commonest form of medieval historical writing was the chronicle, which reaches all the way from monastic annals, mere notes on Easter tables, to the dignity of national monuments. Utterly lacking in perspective, and dominated by the idea of the miraculous, they are for the most part a record of the trivial or the marvellous. Individual historians sometimes recount the story of their own times with sober judgment, but seldom know how to test their sources when dealing with the past. Contradictions are often copied down without the writer noticing them; and since the middle ages forged and falsified so many documents,—monasteries, towns and corporations gaining privileges or titles of possession by the bold use of them,—the narrative of medieval writers cannot be relied upon unless we can verify it by collateral evidence. Some historians, like Otto of Freising, Guibert of Nogent or Bernard Gui, would have been scientific if they had had our appliances for comparison. But even men like Roger Bacon, who deplored the inaccuracy of texts, had worked out no general method to apply in their restoration. Toward the close of the middle ages the vernacular literatures were adorned with Villani's and Froissart's chronicles. But the merit of both lies in their journalistic qualities of contemporary narrative. Neither was a history in the truest sense.

• The Renaissance marked the first great gain in the historic sense, in the efforts of the humanists to realize the spirit of the antique world. They did not altogether succeed; antiquity to them meant largely Plato and Cicero. Their interests were literary, and the un-Ciceronian centuries were generally ignored. Those in which the foundations of modern Europe were laid, which produced parliaments, cathedrals, cities, Dante and Chaucer, were grouped alike on one dismal level and christened the middle ages. The perspective of the humanists was only one degree better than that of the middle ages. History became the servant to literature, an adjunct to the classics. Thus it passed into the schools, where text-books still in use devote 200 pages to the Peloponnesian war and two to the Athens of Pericles.

• But if the literary side of humanism has been a barrier to the progress of scientific history, the discovery and elucidation of texts first made that progress possible. Historical criticism soon awoke. Laurentius Valla's brilliant attack on the "Donation of Constantine" (1440), and Ulrich von Hutten's rehabilitation of Henry IV. from monkish tales mark the rise of the new science. One sees at a glance what an engine of controversy it was to be; yet for a while it remained but a phase of humanism. It was north of the Alps that it parted company with the grammarians. Classical antiquity was an Italian past, the German scholars turned back to the sources of their national history. Aeneas Sylvius Piccolomini (Pius II.) had discovered Otto of Freising and Jordanes. Maximilian I. encouraged the

search for manuscripts, and Vienna became a great humanistic centre. Conrad Celtes left his *Germania Illustrata* unfinished, but he had found the works of Hroswitha. Conrad Peutinger gathered all sorts of Chronicles in his room in Vienna, and published several,—among them Gregory of Tours. This national movement of the 15th century was not paralleled in France or England, where the classical humanities reigned. The Reformation meanwhile gave another turn to the work of German scholars.

The Reformation, with its heated controversies, seems a strange starting-point for science, yet it, even more than the Renaissance, brought out scientific methods of historical investigation. It not only sobered the humanist tendency to sacrifice truth for aesthetic effect, it called for the documents of the Church and subjected them to the most hostile criticism. Luther himself challenged them. Then in the *Magdeburg Centuries* (1559-1574) Protestantism tried to make good its attack on the medieval Church by a great collection of sources accompanied with much destructive criticism. This gigantic work is the first monument of modern historical research. The reply of Cardinal Baronius (*Annales ecclesiastici*, 1588-1607) was a still greater collection, drawn from archives which till then had not been used for scientific history. Baronius' criticism and texts are faulty, though far surpassing anything before his day, and his collection is the basis for most subsequent ones,—in spite of J. J. Scaliger's refutation, which was to contain an equal number of volumes of the errors in Baronius.

The movement back to the sources in Germany until the Thirty Years' War was a notable one. Collections were made by Simon Schard (1535-1573), Johannes Pistorius (1576-1608), Marquard Freher (1565-1614), Melchior Goldast (1576-1635) and others. After the war Leibnitz began a new epoch, both by his philosophy with its law of continuity in phenomena, and by his systematic attempt to collect sources through an association (1670). His plan to have documents printed as they were, instead of "correcting" them, was a notable advance. But from Leibnitz until the 19th century German national historiography made little progress,—although church historians like Mosheim and Neander stand out among the greatest historians of all time.

France had not paralleled the activity of Maximilian's Renaissance historians. The father of modern French history, or at least of historical research, was André Duchesne (1584-1640), whose splendid collections of sources are still in use. Jean Bodin wrote the first treatise on scientific history (*Methodus ad facilem historiarum cognitionem*, 1566), but he did not apply his own principles of criticism; and it was left for the Benedictine monks of the Congregation of St Maur to establish definitely the new science. The place of this school in the history of history is absolutely without a parallel. Few of those in the audiences of Molière, returning home under the grey walls of St Germain-des-Près, knew that within that monastery the men whose midnight they disturbed were laying the basis for all scientific history; and few of the later historians of that age have been any wiser. But when Luc d'Achery turned from exegetica to patristics and the lives of the saints, as a sort of Christian humanist, he led the way to that vast work of collection and comparison of texts which developed through Mabillon, Montfaucon, Ruinart, Martène, Bouquet and their associates, into the indispensable implements of modern historians. Here, as in the Reformation, controversy called out the richest product. Jean Mabillon's treatise, *De re diplomatica* (1681), was due to the criticisms of that group of Belgian Jesuits whose *Acta Sanctorum quotquot toto orbe coluntur* (1643, &c., see BOLLANDISTS) was destined to grow into the greatest repository of legend and biography the world has seen. In reply to D. Papebroch's criticisms of the chronicle of St Denis, Mabillon prepared this manual for the testing of medieval documents. Its canons are the basis, indeed, almost the whole, of the science of diplomatic (*q.v.*), the touchstone of truth for medieval research. Henceforth even the mediocre scholar had a body of technical rules by which to sort out the vast mass of apocrypha in medieval

documentary sources. Scientific history depends upon implements. Without manuals, dictionaries, and easy access to texts, we should go as far astray as any medieval chronicler. The France of the Maurists supplied the most essential of these instruments. The great "glossary" of Ducange is still in enlarged editions the indispensable encyclopaedia of the middle ages. Chronology and palaeography were placed on a new footing by Dom Bernard de Montfaucon's *Palaeographia graeca* (1708), the monumental *Art de vérifier les dates* (3rd ed., 1818-1831, in 38 vols.), and the *Nouveau Traité de diplomatique* (1750-1765) of Dom Tassin and Dom Toussaint. The collections of texts which the Maurists published are too many and too vast to be enumerated here (see C. Langlois, *Manuel de bibliographie historique*, pp. 293 ff.). Dom Bouquet's *Historiens de la Gaule et de la France*—the national repository for French historians—is but one of a dozen tasks of similar magnitude. During the 18th century this deep under-work of scientific history continued to advance, though for the most part unseen by the brilliant writers whose untrustworthy generalities passed for history in the salons of the old régime. Interrupted by the Revolution, it revived in the 19th century, and the roll of honour of the French École des Chartes has almost rivalled that of St Germain-des-Prés.

The father of critical history in Italy was L. A. Muratori (1672-1750), the Italian counterpart of Leibnitz. His vast collection of sources (*Rerum Italicarum scriptores*), prepared amid every discouragement, remains to-day the national monument of Italian history; and it is but one of his collections. His output is perhaps the greatest of any isolated worker in the whole history of historiography. The same haste, but much less care, marked the work of J. D. Mansi (d. 1769), the compiler of the fullest collection of the Councils. Spain, stifled by the Inquisition, produced no national collection of sources during the 17th and 18th centuries, although Nicolas Antonio (d. 1684) produced a national literary history of the first rank.

England in the 16th century kept pace with Continental historiography. Henry VIII.'s chaplain, John Leland, is the father of English antiquaries. Three of the most precious collections of medieval manuscripts still in existence were then begun by Thomas Bodley (the Bodleian at Oxford), Archbishop Matthew Parker (Corpus Christi at Cambridge), and Robert Cotton (the Cottonian collection of the British Museum). In Elizabeth's reign a serious effort was made to arrange the national records, but until the end of the 18th century they were scattered in not less than fifteen repositories. In the 17th and 18th centuries English scholarship was enriched by such monuments of research as William Dugdale's *Monasticon*, Thomas Madox's *History of the Exchequer*, Wilkins's *Concilia*, and Thomas Rymer's *Foedera*. But these works, important as they were, gave but little idea of the wealth of historical sources which the 19th century was to reveal in England.

In the 19th century the science of history underwent a sort of industrial revolution. The machinery of research, invented by the genius of men like Mabillon, was perfected and set going in all the archives of Europe. Isolated workers or groups of workers grew into national or international associations, producing from archives vast collections of material to be worked up into the artistic form of history. The result of this movement has been to revolutionize the whole subject. These men of the factory—devoting their lives to the cataloguing of archives and libraries, to the publication of material, and then to the gigantic task of indexing what they have produced—have made it possible for the student in an American or Australian college to master in a few hours in his library sources of history which baffled the long years of research of a Martène or Rymer. The texts themselves have mostly become as correct as they can ever be, and manuals and bibliographies guide one to and through them, so that no one need go astray who takes the trouble to make use of the mechanism which is at his hand. For example, since the papal archives were opened, so many *regesta* have appeared that soon it will be possible to follow the letter-writing of the medieval popes day by day for century after century.

The apparatus for this research is too vast to be described here. Archives have been reformed, their contents catalogued or calendared; government commissions have rescued numberless documents from oblivion or destruction, and learned societies have supplemented and criticized this work and co-ordinated the results. Every state in Europe now has published the main sources for its history. The "Rolls" series, the *Monumenta Germaniae historica*, and the *Documents inédits* are but the more notable of such national products. A series of periodicals keeps watch over this enormous output. The files and indices of the *English Historical Review*, *Historische Zeitschrift*, *Revue historique*, or *American Historical Review* will alone reveal the strength and character of historical research in the later 19th century.

Every science which deals with human phenomena is in a way an implement in this great factory system, in which the past is welded together again. Psychology has been drawn upon to interpret the movements of revolutions or religions, anthropology and ethnology furnish a clue to problems to which the key of documents has been lost. Genealogy, heraldry and chronology run parallel with the wider subject. But the real auxiliary sciences to history are those which deal with those traces of the past that still exist, the science of language (philology), of writing (palaeography), of documents (diplomatic), of seals (sphragistics), of coins (numismatics), of weights and measures, and archaeology in the widest sense of the word. These sciences underlie the whole development of scientific history. Dictionaries and manuals are the instruments of this industrial revolution. Without them the literary remains of the race would still be as useless as Egyptian inscriptions to the fellahen. Archaeology itself remained but a minor branch of art until the machinery was perfected which enabled it to classify and interpret the remains of the "pre-historic" age.

This is the most remarkable chapter in the whole history of history—the recovery of that past which had already been lost when our literary history began. The perspective stretches out as far as the other side of Homer as we are this. The old "providential" scheme of history disintegrates before a new interest in the "gentile" nations to whose high culture Hebrew sources bore unwilling testimony. Biblical criticism is a part of the historic process. The Jewish texts, once the infallible basis of history, are now tested by the libraries of Babylon, from which they were partly drawn, and Hebrew history sinks into its proper place in the wide horizon of antiquity. The finding of the Rosetta stone left us no longer dependent upon Greek, Latin or Hebrew sources, and now fifty centuries of Egyptian history lie before us. The scientific historian of antiquity works on the hills of Crete, rather than in the quiet of a library with the classics spread out before him. There he can reconstruct the splendour of that Minoan age to which Homeric poems look back, as the Germanic epics looked back to Rome or Verona. His discoveries, co-ordinated and arranged in vast *corpora inscriptionum*, stand now alongside Herodotus or Livy, furnishing a basis for their criticism. Medieval archaeology has, since Quicherat, revealed how men were living while the monks wrote chronicles, and now cathedrals and castles are studied as genuine historic documents.

The immense increase in available sources, archaeological and literary, has remade historical criticism. Ranke's application of the principles of "higher criticism" to works written since the invention of printing (*Kritik neuerer Geschichtsschreiber*) was an epoch-making challenge of narrative sources. Now they are everywhere checked by contemporary evidence, and a clearer sense of what constitutes a primary source has discredited much of what had been currently accepted as true. This is true not only of ancient history, where last year's book may be a thousand years out of date, but of the whole field. Hardly an "old master" remains an authoritative book of reference. Gibbon, Grote, Giesebrecht, Guizot stand to-day by reason of other virtues than their truth. Old landmarks drop out of sight—e.g. the fall of the Western Empire in 476, the coming of the Greeks to Italy in 1450, dates which once enclosed the middle ages. The perspective changes—the Renaissance grows less and the middle

ages more; the Protestant Revolution becomes a complex of economics and politics and religion; the French Revolution a vast social reform in which the Terror was an incident, &c., &c. The result has been a complete transformation of history since the middle of the 19th century.

In the 17th century the Augustinian scheme of world history received its last classic statement in Bossuet's *Histoire universelle*. Voltaire's reply to it in the 18th (*Essai sur les mœurs*) attacked its limitations on the basis of deism, and its miraculous procedure on that of science. But while there are foreshadowings of the evolutionary theory in this work, neither the *philosophes* historians nor Hume nor Gibbon arrived at a constructive principle in history which could take the place of the Providence they rejected. Religion, though false, might be a real historic force. History became the tragic spectacle of a game of dupes—the real movers being priests, kings or warriors. The pawns slowly acquired reason, and then would be able to regulate the moves themselves. But all this failed to give a satisfactory explanation of the laws which determine the direction of this evolution. Giovanni Battista Vico (1668–1744) was the first to ask why there is no science of human history. But his lonely life and unrecognized labours leave him apart from the main movement, until his works were discovered again in the 19th century. It was A. L. H. Heeren who, at the opening of the 19th century, first laid that emphasis upon the economic factors in history which is to-day slowly replacing the Augustinian explanation of its evolution. Heeren's own influence, however, was slight. The first half of the century (apart from the scientific activity of Pertz, Guizot, &c.) was largely dominated by the romanticists, with their exaggeration of the individual. Carlyle's "great man theory of history" is logically connected with the age of Scott. It was a philosophy of history which lent itself to magnificent dramatic creations; but it explained nothing. It substituted the work of the genius for the miraculous intervention of Providence, but, apart from certain abstract formulae such as Truth and Right, knew nothing of why or how. It is but dealing in words to say that the meaning of it all is God's revelation of Himself. Granting that, what is the process? Why does it so slowly reveal the Right of the middle ages (as in slavery for instance) to be the Wrong to-day? Carlyle stands to Bossuet as the sage to the myth. Hegel got no closer to realities. His idealistic scheme of history, which makes religion the keynote of progress, and describes the function of each—Judaism to typify duty, Confucianism order, Mahomedanism justice, Buddhism patience, and Christianity love—does not account for the facts of the history enacted by the devotees. It characterizes, not the real process of evolution, but an ideal which history has not realized. Besides, it does not face the question how far religion itself is a product or a cause, or both combined.

In the middle of the century two men sought to incorporate in their philosophy the physical basis which Hegel had ignored in his spiritism—recognizing that life is conditioned by an environment and not an abstraction for metaphysics. H. T. Buckle, in his *History of Civilization in England* (1857), was the first to work out the influences of the material world upon history, developing through a wealth of illustration the importance of food, soil and the general aspect of nature upon the formation of society. Buckle did not, as is generally believed, make these three factors dominate all history. He distinctly stated that "the advance of European civilization is characterized by a diminishing influence of physical laws and an increasing influence of mental laws," and "the measure of civilization is the triumph of mind over external agents." Yet his challenge, not only to the theologian, but also to those "historians whose indolence of thought" or "natural incapacity" prevented them from attempting more than the annalistic record of events, called out a storm of protest from almost every side. Now that the controversy has cleared away, we see that in spite of Buckle's too confident formulation of his laws, his pioneer work in a great field marks him out as the Augustine of the scientific age. Among historians, however, Buckle's theory received but little favour for another generation. Meanwhile the economists had themselves taken up the problem,

and it was from them that the historians of to-day have learned it. Ten years before Buckle published his history, Karl Marx had already formulated the "economic theory of history." Accepting with reservation Feuerbach's attack on the Hegelian "absolute idea," based on materialistic grounds (*Der Mensch ist, was er isst*), Marx was led to the conclusion that the causes of that process of growth which constitutes the history of society are to be found in the economic conditions of existence. From this he went on to socialism, which bases its militant philosophy upon this interpretation of history. But the truth or falseness of socialism does not affect the theory of history. In 1845 Marx wrote of the Young-Hegelians that to separate history from natural science and industry was like separating the soul from the body, and "finding the birthplace of history, not in the gross material production on earth, but in the misty cloud formation of heaven" (*Die heilige Familie*, p. 238). In his *Misère de la philosophie* (1847) he lays down the principle that social relationships largely depend upon modes of production, and therefore the principles, ideas and categories which are thus evolved are no more eternal than the relations they express, but are historical and transitory products. In the famous *Manifesto of the Communist Party* (1848) the theory was applied to show how the industrial revolution had replaced feudal with modern conditions. But it had little vogue; except among Socialists, until the third volume of *Das Kapital* was published in 1894, when its importance was borne in upon continental scholars. Since then the controversy has been almost as heated as in the days of the Reformation. It is an exaggeration of the theory which makes it an explanation of all human life, but the whole science of dynamic sociology rests upon the postulate of Marx.

The content of history always reflects the interests of the age in which it is written. It was so in Herodotus and in medieval chronicles. Modern historians began with politics. But as the complex nature of society became more evident in the age of democracy, the economic or sociological history gained ground. Histories of commerce and cities now rank beside those on war and kings, although there are readers still who prefer to follow the pennants of robber barons rather than to watch the slow evolution of modern conditions. The drum-and-trumpet history has its place like that of art, jurisprudence, science or philosophy. Only now we know that no one of these is more than a single glimpse at a vast complex of phenomena, most of which lie for ever beyond our ken.

This expansion of interest has intensified specialization. Historians no longer attempt to write world histories; they form associations of specialists for the purpose. Each historian chooses his own epoch or century and his own subject, and spends his life mastering such traces of it as he can find. His work there enables him to judge of the methods of his fellows, but his own remains restricted by the very wealth of material which has been accumulated on the single subject before him. Thus the great enterprises of to-day are co-operative—the *Cambridge Modern History*, Lavisse and Rambaud's *Histoire générale*, or Lavisse's *Histoire de France*, like Hunt and Poole's *Political History of England*, and Oncken's *Allgemeine Geschichte in Einzeldarstellungen*. But even these vast sets cover but the merest fraction of their subjects. The Cambridge history passes for the most part along the political crust of society, and seldom glances at the social forces within. This limitation of the professed historian is made up for by the growingly historical treatment of all the sciences and arts—a tendency noted before, to which this edition of the *Encyclopædia Britannica* is itself a notable witness. Indeed, for a definition of that limitless subject which includes all the phenomena that stand the warp and stress of change, one might adapt a famous epitaph—*si historiam requiris, circumspice*.

BIBLIOGRAPHY.—See Ch. V. Langlois, *Manuel de bibliographie historique* (2 vols., 1904). This forms the logical bibliography of this article. It is a general survey of the whole apparatus of historical research, and is the indispensable guide to the subject. Similar bibliographies covering sections of history are noted with the articles where they properly belong, e.g. in English medieval history the manual of Chas. Gross, *Sources and Literature of English History*;

in German history the *Quellenkunde* of Dahlmann-Waitz (7th ed.); for France the *Bibliographie de l'histoire de France* of C. Monod (antiquated, 1888), or the *Sources de l'histoire de France* so ably begun by A. Molinier's volumes on the mediæval period. Perhaps the sanest survey of the present scientific movement in history is the clear summary of Ch. V. Langlois and Ch. Seignobos, *Introduction to the Study of History* (trans. with preface by F. York Powell, London, 1898). Much more ambitious is E. Bernheim's *Lehrbuch der historischen Methode und der Geschichtsphilosophie mit Nachweis der wichtigsten Quellen und Hilfsmittel zum Studium der Geschichte* (3rd and 4th ed., Leipzig, 1903). (J. T. S. *)

HIT, a town of Asiatic Turkey, in the vilayet of Bagdad, on the west bank of the Euphrates, 70 m. W.N.W. of Bagdad, in 33° 38' 8" N., 42° 52' 15" E. It is picturesquely situated on a line of hills, partly natural, but in large part certainly artificial, the accumulation of centuries of former habitation, from 30 to 100 ft. in height, bordering the river. The houses are built of field stones and mud. A striking feature of the town is a lofty and well-proportioned minaret, which leans quite perceptibly. Behind and around Hit is an extensive but utterly barren plain, through which flow several streams of bitter water, coming from mineral springs. Directly behind the town are two bitumen springs, one cold and one hot, within 30 ft. of one another. The gypsum cliffs on the edge of the plain, and the rocks which crop out here and there in the plain, are full of seams of bitumen, and the whole place is redolent of sulphuretted hydrogen. Across the river there are naphtha springs. Indeed, the entire region is one possessing great potential wealth in mineral oils and the like. Hit, with its fringe of palms, is like an oasis in the desert occasioned by the outcrop of these deposits. From time immemorial it has been the chief source of supply of bitumen for Babylonia, the prosperity of the town depending always upon its bitumen fountains, which are still the property of the government, but are rented out to any one who wishes to use them. There is also a shipyard at Hit, where the characteristic Babylonian boats are still made, smeared within and without with bitumen. Hit is the head of navigation on the Euphrates. It is also the point from which the camel-post starts across the desert to Damascus. About 8 m. inland from Hit, on a bitter stream, lies the small town of Kubeitha. Hit is mentioned, under the name of Ist, in the Karnak inscription as paying tribute to Tethmosis (Thothmes) III. In the Bible (Ezra viii. 15) it is called Ahava; the original Babylonian name seems to have been *Ihi*, which becomes in the Talmud *Ihidakira*, in Ptolemy *Iῦάκαρα*, and in Zosimus and Ammianus *Δακίρα* and *Diacira*.

See Geo. Rawlinson's *Herodotus*, I. 179, and note by H. C. Rawlinson; J. P. Peters, *Nippur* (1897); H. V. Cocce, *By Nile and Euphrates* (1904). (J. P. Pe.)

HITA, GINÉS PEREZ DE (1544?–1605?), Spanish novelist and poet, was born at Mula (Murcia) about the middle of the 16th century. He served in the campaign of 1569–1571 against the Moriscos, and in 1572 wrote a rhymed history of the city of Lorca which remained unpublished till 1889. He owes his wide celebrity to the *Historia de los bandos de Zegries y Abencerrajes* (1595–1604), better known as the *Guerras civiles de Granada*, which purports to be a chronicle based on an Arabic original ascribed to a certain Aben-Hamin. Aben-Hamin is a fictitious personage, and the *Guerras de Granada* is in reality a historical novel, perhaps the earliest example of its kind, and certainly the first historical novel that attained popularity. In the first part the events which led to the downfall of Granada are related with uncommon brilliancy, and Hita's sympathetic transcription of life at the Emir's court has clearly suggested the conventional presentation of the picturesque, chivalrous Moor in the pages of Mlle de Scadéry, Mme de Lafayette, Châteaubriand and Washington Irving. The second part is concerned with the author's personal experiences, and the treatment is effective; yet, though Calderón's play, *Amar después de la muerte*, is derived from it, the second part has never enjoyed the vogue or influence of the first. The exact date of Hita's death is unknown. His blank verse rendering of the *Crónica Troyana*, written in 1596, exists in manuscript.

HITCHCOCK, EDWARD (1793–1864), American geologist, was born of poor parents at Deerfield, Massachusetts, on the 24th of May 1793. He owed his education chiefly to his own

exertions, and was preparing himself to enter Harvard College when he was compelled to interrupt his studies from a weakness in his eyesight. In 1815 he became principal of the academy of his native town; but he resigned this office in 1818 in order to study for the ministry. Having been ordained in 1821 pastor of the Congregational church of Conway, Mass., he employed his leisure in making a scientific survey of the western counties of the state. From 1825 to 1845 he was professor of chemistry and natural history, from 1845 to 1864 was professor of natural theology and geology at Amherst College, and from 1845 to 1854 was president; the college owed its early success largely to his energetic efforts, especially during the period of his presidency. In 1830 he was appointed state geologist of Massachusetts, and in 1836 was made geologist of the first district of the state of New York. In 1840 he received the degree of LL.D. from Harvard, and in 1846 that of D.D. from Middlebury College, Vermont. Besides his constant labours in geology, zoology and botany, Hitchcock took an active interest in agriculture, and in 1850 he was sent by the Massachusetts legislature to examine into the methods of the agricultural schools of Europe. In geology he made a detailed examination and exposition of the fossil footprints from the Triassic sandstones of the Connecticut valley. His collection is preserved in the Hitchcock Ichnological Museum of Amherst College, and a description of it was published in 1858 in his report to the Massachusetts legislature on the ichnology of New England. The footprints were regarded as those of reptiles, amphibia and birds (?). In 1857 he undertook, with the aid of his two sons, the geological survey of Vermont, which was completed in 1861. As a writer on geological science, Hitchcock was largely concerned in determining the connexion between it and religion, and employing its results to explain and support what he regarded as the truths of revelation. He died at Amherst, on the 27th of February 1864.

His son, CHARLES HENRY HITCHCOCK (1836–), did good service in geology, in Vermont, New Hampshire (1868–1878), and other parts of America, and became professor of geology at Dartmouth in 1868.

The following are Edward Hitchcock's principal works: *Geology of the Connecticut Valley* (1823); *Catalogue of Plants growing without cultivation in the vicinity of Amherst* (1829); *Reports on the Geology of Massachusetts* (1833–1841); *Elementary Geology* (1840; ed. 2, 1841; and later ed. with C. H. Hitchcock 1862); *Fossil Footprints in the United States* (1848); *Outline of the Geology of the Globe and of the United States in particular* (1853); *Illustrations of Surface Geology* (1850); *Ichnology of New England* (1858); *The Religion of Geology and its Connected Sciences* (1851; new ed., 1869); *Reminiscences of Amherst College* (1863); and various papers in the *American Journal of Science*, and other periodicals.

HITCHCOCK, GEORGE (1850–), American artist, was born at Providence, Rhode Island, in 1850. He graduated from Brown University in 1872 and from the law school of Harvard University in 1874; then turned his attention to art and became a pupil of Boulanger and Lefebvre in Paris. He attracted notice in the Salon of 1885 with his "Tulip Growing," a Dutch garden which he painted in Holland. He had for years a studio at Egmond, in the Netherlands. He became a Chevalier of the Legion of Honour, France; a member of the Vienna Academy of Arts, the Munich Secession Society, and other art bodies; and is represented in the Dresden gallery; the imperial collection, Vienna; the Chicago Art Institute, and the Detroit Museum of Fine Arts.

HITCHCOCK, ROSWELL DWIGHT (1817–1887), American divine, was born at East Machias, Maine, on the 15th of August 1817, graduated at Amherst College in 1836, and later studied at Andover Theological Seminary, Mass. After a visit to Germany he was a tutor at Amherst in 1839–1842, and was minister of the First (Congregational) Church, Exeter, New Hampshire, in 1845–1852. He became professor of natural and revealed religion in Bowdoin College, Brunswick, Maine, in 1852, and in 1855 professor of church history in the Union Theological Seminary in New York, of which he was president in 1880–1887. He died at Somerset, Mass., on the 16th of June 1887.

Among his works are: *Life of Edward Robinson* (1863); *Socialism* (1879); *Carmine Sanctorum* (with Z. Eddy and L. W. Mudge, 1885); and *Eternal Atomism* (1888).

HITCHIN, a market town in the Hitchin parliamentary division of Hertfordshire, England, on the small river Hiz, 32 m. N. from London by the Great Northern railway. Pop. of urban district (1901) 10,072. It is the junction of the main line with the Cambridge branch, and with a branch of the Midland railway to Bedford. The church of St Mary is Perpendicular, with a fine porch, a painting of the Adoration of the Magi, attributed to Rubens, a small crypt said to have been used by Cromwell as a prison for the Royalists, and many interesting monuments. Hitchin Priory is a mansion on the site of a Carmelite foundation of the early 14th century. A Gilbertine nunnery, founded later in the same century, stood adjacent to the church, and portions of the buildings appear in an existing block of almshouses. The grammar school (1632) was reconstituted in 1889 for boys and girls. Straw-plaiting, malting, brewing, and the cultivation and distillation of lavender and peppermint are carried on.

HITTITES, an ancient people, alluded to frequently in the earlier records of Israel, and also, under slightly variant names, in Egyptian records of the XVIIIth, XIXth and XXth Dynasties, and in Assyrian from about 1100 to 700 B.C. They appear also in the Vannic cuneiform texts, and are believed to be the authors of a class of monuments bearing inscriptions in a peculiar pictographic character, and widely distributed over Asia Minor and N. Syria, around which much controversy has raged during the past thirty years.

1. *The Bible.*—In the Old Testament the name of the race is written *Heth* (with initial aspirate), members of it being *Hitti*, *Hittim*, which the Septuagint renders *ἕθρ*, *ἕθρῆαιος*, *ἕθρῆν* or *ἕθρῆν*, keeping, it will be noted, *ē* in the stem throughout. The race appears in two connexions. (a) In pre-Israelite Palestine, it is resident about Hebron (Gen. xxiii. 3), and in the central uplands (Num. xiii. 29). To Joshua (i. 4) is promised "from the wilderness and this Lebanon even unto the great river, the river Euphrates, all the land of the Hittites." The term "wilderness" here is of geographical ambiguity; but the promise is usually taken to mean that Palestine itself was part of the Hittite land before the coming of Israel; and an apostrophe of Ezekiel (xvi. 3) to Jerusalem, "thy mother (was) an Hittite," is quoted in confirmation. Under the monarchy we hear frequently of Hittites within the borders of Israel, but either as a small subject people, coupled with other petty tribes, or as individuals in the Jewish service (e.g. Uriah, in the time of David). It appears, therefore, that there survived in Palestine to late times a detached Hittite population, with which Hebrews sometimes intermarried (Judges iii. 5-6; Gen. xxvi. 34) and lived in relations now amicable, now tyrannical (e.g. Hittites were made tributary bondsmen by Solomon, 1 Kings ix. 20, 21; 2 Chron. viii. 7, 8). (b) An independent and powerful Hittite people was domiciled N. of Palestine proper, organized rather as a confederacy of tribes than a single monarchy (1 Kings x. 28; 2 Kings vii. 6). Presumably it was a daughter of these Hittites that Solomon took to wife. If the emendation of 2 Sam. xxiv. 64, "Tahtim-hodshi," based on the Septuagint version *ἕθρῆν καθῆς* be accepted, we hear of them at Kadesh on Orontes; and some minor Hittite cities are mentioned, e.g. Luz; but no one capital city of the race is clearly indicated. Carchemish, on the Euphrates, though mentioned three times (2 Chron. xxxv. 20; Isa. x. 9; Jer. xlvi. 2), is not connected explicitly with Hittites, a fact which is not surprising, since that city was no longer under a Hatti dynasty at the epoch of the Old Testament references. So far as the Old Testament goes, therefore, we gather that the Hittites were a considerable people, widely spread in Syria, in part subdued and to some extent assimilated by Israel, but in part out of reach. The latter portion was not much known to the Hebrews, but was vaguely feared as a power in the early days of the monarchy, though not in the later pre-Captivity period. The identification of the northern and southern Hittites, however, presents certain difficulties not yet fully explained; and it seems that we must assume Heth to have been the name both of a country in the north and of a tribal population not confined to that country.

2. *Egyptian Records.*—The decipherment of the inscriptions of the XVIIIth Theban Dynasty led, before the middle of the

19th century, to the discovery of the important part played in the Syrian campaigns of Tethmosis (Thothmes) III. by the H-₁ (vulgarly transliterated *Kheta*, though the vocalization is uncertain). The coincidence of this name, beginning with an aspirate, led H. K. Brugsch to identify the Kheta with Heth. That identification stands, and no earlier Egyptian mention of the race has been found. Tethmosis III. found the Kheta ("Great" and "Little") in N. Syria, not apparently at Kadesh, but at Carchemish, though they had not been in possession of the latter place long (not in the epoch of Tethmosis I.'s Syrian campaign). They were a power strong enough to give the Pharaoh cause to vaunt his success (see also EGYPT: *Ancient History*, § "The New Empire"). Though he says he levied tribute upon them, his successors in the dynasty nearly all record fresh wars with the Kheta who appear as the northernmost of Pharaoh's enemies, and Amenophis or Amenhotep III. saw fit to take to wife Gilukhipa, a Syrian princess, who may or may not have been a Hittite. This queen is by some supposed to have introduced into Egypt certain exotic ideas which blossomed in the reign of Amenophis IV. The first Pharaoh of the succeeding dynasty, Rameses I., came to terms with a Kheta king called Saplel or Saparura; but Seti I. again attacked the Kheta (1366 B.C.), who had apparently pushed southwards. Forced back by Seti, the Kheta returned and were found holding Kadesh by Rameses II., who, in his fifth year, there fought against them and a large body of allies, drawn probably in part from beyond Taurus, the battle which occasioned the monumental poem of Pentaur. After long struggles, a treaty was concluded in Rameses's twenty-first year, between Pharaoh and "Kheta-sar" (i.e. Kheta-king), of which we possess an Egyptian copy. The discovery of a cuneiform tablet containing a copy of this same treaty, in the Babylonian language, was reported from Boghaz Keui in Cappadocia by H. Winckler in 1907. It argues the Kheta a people of considerable civilization. The Kheta king subsequently visited Pharaoh and gave him his daughter to wife. Rameses' successor, Mineptah, remained on terms with the Kheta folk; but in the reign of Rameses III. (Dyn. XX.) the latter seem to have joined in the great raid of northern tribes on Egypt which was checked by the battle of Pelusium. From this point (c. 1150 B.C.)—the point at which (roughly) the monarchic history of Israel in Palestine opens—Egyptian records cease to mention Kheta; and as we know from other sources that the latter continued powerful in Carchemish for some centuries to come, we must presume that the rise of the Israelite state interposed an effective political barrier.

3. *Assyrian Records.*—In an inscription of Tiglath Pileser I. (about 1100 B.C.), first deciphered in 1857, a people called *Khatti* is mentioned as powerful in Girgamish on Euphrates (i.e. Carchemish); and in other records of the same monarch, subsequently read, much mention is made of this and of other N. Syrian names. These *Khatti* appear again in the inscriptions of Assur-nazir-pal (early 9th century B.C.), in whose time Carchemish was very wealthy, and the *Khatti* power extended far over N. Syria and even into Mesopotamia. Salmanser II. (d. 825 B.C.) raided the *Khatti* and their allies year after year; and at last Sargon III., in 717 B.C., relates that he captured Carchemish and its king, Pisiris, and put an end to its independence. We hear no more of it thenceforward. These *Khatti*, there is no reasonable doubt, are identical with *Kheta*. (For the chronology see further under BABYLONIA AND ASSYRIA.)

4. *Other Cuneiform Records.*—The name of the race appears in certain of the Tel-el-Amarna letters, tablets written in Babylonian script to Amenophis (Amenhotep) IV. and found in 1891 on the site of his capital. Some of his governors in Syrian districts (e.g. one Asiru of Phoenicia) report movements of the Hittites, who were then pursuing an aggressive policy (about 1400 B.C.). There are also other letters from rulers of principalities in N. Syria (Mitanni) and E. Asia Minor (Azzawa), who write in non-Semitic tongues and are supposed to have been Hittites.

Certain *Kheta* or *Khatti* are mentioned in the Vannic inscriptions (deciphered partially by A. H. Sayce and others) as attacked by

kings of Binas (Van), and apparently domiciled on the middle Euphrates N. of Taurus in the 9th century B.C. This name again may safely be identified with *Khalti-Khela*.

The Khatti also appear on a "prophecy-tablet," referring ostensibly to the time of Sargon of Agadé (middle of 4th millennium B.C.); but the document is probably of very much later date. Lastly, a fragmentary chronicle of the 1st Babylonian Dynasty mentions an invasion of Akkad by them about 1800 B.C.

From all these various sources we should gather that the Hittites were among the more important racial elements in N. Syria and S.E. Asia Minor for at least a thousand years. The limits at each end, however, are very ill defined, the superior falling not later than 2000 B.C. and the inferior not earlier than 600 B.C. This people was militant, aggressive and unsettled in the earlier part of that time; commercial, wealthy and enervated in the latter. A memorial of its trading long remained in Asia in the shape of the weight-measure called in cuneiform records the *manek* "of Carchemish." These Hittites had close relations with other Asia Minor peoples, and at times headed a confederacy. During the later part of their history they were in continual contact with Assyria, and, as a Syrian power, and perhaps also as a Cappadocian one, they finally succumbed to Assyrian pressure.

The "Hittite" Monuments.—It remains to consider in the light of the foregoing evidence a class of monuments to which attention began to be called about 1870. In that year two Americans, Consul J. A. Johnson and the Rev. S. Jessup, rediscovered, at Hamah (Hamath) on Orontes, five basaltic blocks bearing pictographic inscriptions in relief, one of which had been reported by J. L. Burckhardt in 1812. In spite of their efforts and subsequent attempts made by Tyrwhitt Drake and Richard Burton, when consul at Damascus, proper copies could not be obtained; and it was not till the end of 1872 that, thanks to W. Wright of Beirut, casts were taken and the stones themselves sent to Constantinople by Subhi Pasha of Damascus. As usually happens when a new class of antiquities is announced, it was soon found that the "Hamathite" inscriptions did not stand alone. A monument in the same script had been seen in Aleppo by Tyrwhitt Drake and George Smith in 1872. It still exists, built into a mosque on the western wall of the city. Certain clay sealings, eight of which bore pictographic signs, found by A. H. Layard in the palace of Assur-beni-pal at Kuyunjik (Nineveh), as long ago as 1851 and noticed then as in a "doubtful character," were compared by Hayes Ward and found to be of the Hamathite class. A new copy of the long known rock-sculpture at Ivri² in S.W. Cappadocia was published by E. J. Davis in 1876, and clearly showed Hamathite characters accompanying the figures. Davis also reported, but did not see; a similar inscription at Bulgar Maden, not far away. Sculptures seen by W. Skene and George Smith at Jerablus, on the middle Euphrates, led to excavations being undertaken there, in 1878, by the British Museum, and to the discovery of certain Hamathite inscriptions accompanying sculptures, a few of which were brought to London. The conduct of these excavations, owing to the death of George Smith, devolved on Consul Henderson of Aleppo, and was not satisfactorily carried out. Meanwhile Wright, Ward and Sayce had all suggested "Hittite" as a substitute for "Hamathite," because no other N. Syrian people loomed so large in ancient records as did the Hittites, and the suggestion began to find acceptance. Jerablus was confidently identified with Carchemish (but without positive proof to this day), and the occurrence of Hamathite monuments there was held to confirm the Hittite theory.

In 1876 Sayce pointed out the resemblance between certain Hittite signs and characters in the lately deciphered Cypriote syllabary, and suggested that the comparison might lead to a beginning of decipherment; but the hope has proved vain. To

¹ First described by the Turk, Hajji Khalifa, in the 17th century; first seen by the Swedish traveller Otter in 1736, and first published in 1840 in Ritter's *Erdkunde*, iii., after a drawing by Major Fischer, made in 1837.

this scholar, however, is owed the next great step ahead. In 1879 it first occurred to him to compare the rock-monuments at Boghaz Keui (see PTERIA) and Euyuk in N. Cappadocia, discovered by Texier and Hamilton in 1835 and subsequently explored by G. Perrot and E. Guillaume. These, he now saw, bore Hittite pictographs. Other rock-sculptures at Gaur Kalessi, in Galatia, and in the Karabel pass near Smyrna, he suspected of belonging to the same class; and visiting the last-named locality in the autumn, he found Hittite pictographs accompanying one of the two figures.³ He announced his discoveries in 1880, and proclaimed the fact that a great Hittite empire, extending from Kadesh to Smyrna, had risen from the dead. A month later he had the good fortune to recover copies of a silver boss, or hill-top, offered to various museums about 1860, but rejected by them as a meaningless forgery and for a long time lost again to sight. Round the rim was a cuneiform legend, and in the field a Hittite figure with six Hittite symbols engraved twice over on either hand of it. Reading the cuneiform as *Tarqu-dimme sar mat Erme* (i.e. "T. king of the country E."), Sayce distributed phonetic values, corresponding to the syllables of the two proper names, among four of the Hittite characters, reserving two as "ideograms" of "king" and "country," and launched into the field of decipherment. But he subsequently recognized that this was a false start, and began afresh from another basis. Since then a number of other monuments have been found, some on new sites, others on sites already known to be Hittite, the distribution of which can be seen by reference to the accompanying map. It will be observed that, so far as at present known, they cluster most closely in Commagene, Cappadocia and S. Phrygia.

The following notes supplement the map:—
A. WEST ASIA MINOR.—"Niobe" (*Saralla Tash*) and *Karabel* (two); rock-cut figures with much defaced hieroglyphs in relief. Remains of buildings, not yet explored, lie near the "Niobe" figure. Nothing purely Hittite has been found at Sardis or in any W. Asian excavation; but small Hittite objects have been sold in Smyrna and Aidin.

B. PHRYGIA.—*Gaur-Kalessi*; rock-cut figures and remains of a stronghold, but no inscriptions. *Doghanlıdere* and *Beikcu* in the Phrygian rock-monument country; at the first is a sculptured rock-panel with a few pictographs in relief; at the latter a fragment of an inscription in relief was disinterred from a mound. *Kalıtola Yedig*, near Ighin; block inscribed in relief, disinterred from mounds apparently marking a camp or palace-enclosure. *Eflatun Bunar* (= Plato's Spring), W. of Konia; megalithic building with rude, and greatly defaced reliefs, not certainly Hittite; no inscription. *Fassiler*, W. of Konia; gigantic *siela*, or composite statue (figure on animals), not certainly Hittite; no inscription. *Konia*; relief of warrior, drawn by Texier in 1835, and since lost; of very doubtful Hittite character. A gold inscribed Hittite ring, now at Oxford, was bought there in 1903. *Emirghazi* (anc. *Ardistama*?); three inscriptions in relief (two on altars) and large mounds. Evidently an important Hittite site. *Kara-Dagh*; hill-sanctuary with incised carving of seated figure and inscriptions, found by Miss G. L. Bell and Sir W. M. Ramsay in 1907 (see their *Thousand and One Churches*, 1909).

C. NORTH CAPPADOCIA.—*Boghaz Keui* (see PTERIA); largicity with remains of palace, citadel, walls, &c. Long rock-cut inscription of ten lines in relief, two short relief inscriptions cut on blocks, and also cuneiform tablets in Babylonian and also in a native language, first found *in situ* in 1893, and showing the site to be the capital of Arava, whence came two of the Tell el-Amarna letters. Near the site are the rock reliefs of *Yasili Kayu* in two hypaethral galleries, showing, in the one, two processions composed of over sixty figures meeting at the head of the gallery; in the other, isolated groups of figures, fifteen in number (see for detailed description *Murray's Guide to Asia Minor*, 1895, pp. 23 ff.). Pictographs accompany many of the figures. The whole makes the most extensive group of Hittite remains yet known. *Boghaz Keui* was never thoroughly explored until 1907, the survey of Perrot and Guillaume having been superficial only and the excavations of E. Chantre (1894) very slight. In 1906 a German expedition under Professor H. Winckler undertook the work, and great numbers of cuneiform tablets were found. These refer to the reigns of at least four kings from Subbiluliuma (= Saplal, see above) to Hattusil II. or Khattusil (= Khetasar, see above). The latter was an ally of Katashmanturgu of Babylon,

² The "Niobe" statue near Manisa was not definitely known for "Hittite" till 1882, when G. Dennis detected pictographs near it.

³ The "pseudo-Sesostris" of Herodotus, already demonstrated non-Egyptian by Rosellini. The second figure was unknown, till found by Dr Beddoe in 1856.

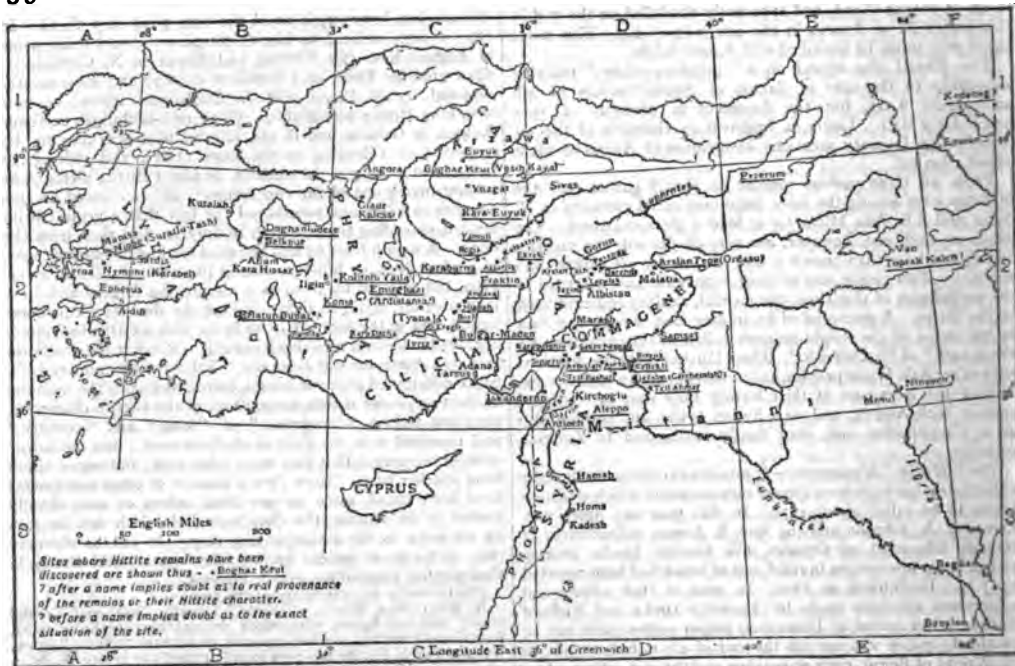

and powerful enough to write to the Babylonian court as a sovereign of equal standing. His letter shows that he considered the rise of Assyria a menace to himself. Winckler claims to read *Hatti* as the name of the possessors of Boghaz Keui, and to find in this name the proof of the Hittite character of Syro-Cappadocian power and of the imperial predominance of the city. But it remains to be proved whether these tablets were written there, and not rather, being in a foreign script, abroad, like most of the Tell el-Amarna archives. O. Puchstein has cleared and studied important architectural remains. *Eyysuk*: large mound with remains of palace entered between sphinxes. Sculptured wall-dados, but no Hittite inscriptions. Cuneiform tablets; some Babylonian, others in a native language. Also inscriptions in early Phrygian character and language, found in 1894. The most famous of Hittite reliefs is here—a double-headed eagle "displayed" on the flank of one of the gateway sphinxes. This is supposed to have suggested to the Seljuks of Konia their heraldic device adopted in the 13th century, which, brought to Europe by the Crusaders, became the emblem of Teutonic empire in 1345. This derivation must be taken, however, *cum grano*, proof of its successive steps being wanting. *Kara-Eyysuk*: a mound near Dedik, partially excavated by E. Chantre in 1894. Cuneiform tablets and small objects possibly, but not certainly, Hittite. A colossal eagle was found on a deserted site near *Yamuli* on the middle Halys, in 1907 by W. Attmore Robinson.

D. SOUTH CAPPADOCIA.—*Karaburnu*: long, incised rock-inscription. *Bogja*, eight hours west of Kaisariye; four-sided *stela* with incised inscription. *Assarjik*, on the side of Mt. Argaeus; incised rock-inscription. *Ekrkek*: a fragmentary inscription in relief and an incised inscription on a *stela* of very late appearance. *Fraklin* or *Farakdin* (probably *anc. Das-tarkon*); sculptured rock-panel showing two groups of figures in act of cult, with hieroglyphs in relief. *Arsalan Tash*, near Comana (Cappadocia), on the *Tashji* Dagh; two colossal lions, one with incised inscription. *Tashji* in the Zamanti valley; rock-relief with rudely incised inscriptions. *Aidaval* and *Bor*; inscriptions incised on sculptured *stelae* of kings (?), probably from Tyana (*Ekseli Hisar*). All are now in Constantinople. A silver seal with hieroglyphs, now at Oxford, came also from *Bor*. *Nigdeh*: basalt drum or altar with incised inscription. *Ieriz*: rock-sculpture of king adoring god, with three inscriptions in relief. A second sculpture, similar in subject but smaller and much defaced, was found hard by in 1906. *Bulgar Maden*: long incised rock-inscription, near silver-mines. *Gurun* (*Gurun*): two rock-inscriptions in relief, much damaged. *Arsalan-Tepe*, near Ordasu (two hours from Malatia); large mound whence two sculptured *stelae* or wall-blocks with inscriptions in relief have been unearthed (now in Constantinople and the Louvre). Four other

reliefs, reported found near Malatia and published by J. Garstang in *Annals Arch. and Anthropol.*, 1908, probably came also from *Arsalan Tepe*. *Palango*: lower anionic hall of draped statue with incised inscription, now in Constantinople. Also a small basalt lion. *Arsalan Tash*, near Palango; two rude gateway lions, uninscribed. *Yapalak*: defaced inscription, reported by J. S. Sterrett but never copied. *Jagin*: obelisk with long inscription in relief on all four faces, now in Constantinople. These last four places seem to lie on a main road leading from Cappadocia to Marash and the Syrian sites. The expedition sent out by Cornell University in 1907 found several Hittite inscriptions on rocks near *Darende* in the valley of the Tokhma Su.

E. NORTH SYRIA.—*Marash*: several monuments (*stelae*, wall-blocks and two lions) with inscriptions, both in relief and incised (part are now at Constantinople; part in Berlin and America); evidently one of the most important of Hittite sites. *Karaburshlu*, *Arishan*, *Gerchin*, *Sinjert*: mounds about the head-waters of the Kara Su. The last-named mound, brought to O. Puchstein's notice in 1892 by the chance discovery of sculptured wall-dados, now in Constantinople, was the scene of extensive German excavations in 1893-1894, directed by F. v. Luschan and K. Koldewey, and was found to cover a walled town with central fortified palace. Hittite, cuneiform and old Aramaean monuments were found with many small objects, most of which have been taken to Berlin; but no Hittite inscriptions came to light. *Sakchegewu* (*Sakchegewu*), a site with several mounds between Sinjerli and Aintab; series of reliefs, once wall-dados, now in Berlin and Constantinople. This site is in process of excavation by Professor J. Garstang of the University of Liverpool. A sculptured portico has come to light in the smallest of the five mounds, and much pottery, with incised and painted decoration, has been recovered. *Aintab*: fragment of relief inscription. *Samat* (*Samosata*): sculptured *stela* with incised inscription much defaced. *Jerablus*; see above. Several Hittite objects sent from Birejik and Aintab to Europe probably came from Jerablus, others from *Tell Bashur* on the Sajur. *Kelileh*, near Jerablus; two *stelae*, one with relief inscription. *Iskanderia* (*Alexandretta*): source of a long inscription cut on both sides of a spheroidal object of unknown origin. *Kirchoglu*, a site on the Afrin, whence a fragmentary draped statue with incised inscriptions was sent to Berlin. *Aleppo*: inscription in relief (see above). *Tell Ahmar* (on left bank of Euphrates); large *stela* with sculpture and long relief inscription, found in 1908 with several sculptured *stelae* and two gateway lions, inscribed in cuneiform. Two hours north, a lion and a fragment of a relief inscription were found in 1907 by Miss G. L. Bell. *Tell Halaf* in Mid-Mesopotamia, near Ras el-Ain; sculptures on portico of a temple or palace; cuneiform inscriptions

and large mounds, explored in 1902 by Oppenheim. *Hamah*; five blocks inscribed in relief (see above).

F. OUTLYING SITES.—*Erseram*; source of an incised inscription, perhaps not originally found there. *Kedabeg*; metal boss or hit-top with pictographs, found in a tomb and stated by F. Hommel to be Hittite, but doubtful. *Toprak Kaleh*; bronze fragments with two pictographs; doubtful if Hittite. *Ninneh*; sealings, see above. *Babylon*; a bowl and a *stela* of storm-god, both with incised inscriptions; doubtless spoil of war or tribute brought from Syria. The bowl is inscribed round the outside, the *stela* on the back.

(For a detailed description of the subjects of the reliefs, &c., with the necessary illustrations, see the works indicated in the bibliography.)

Structures.—The structural remains found as yet on Hittite sites are few, scanty and far between. They consist of: (a) Ground plans of a palatial building and three temples and fortifications with sculptured gate at Boghaz Keui. The palace was built round a central court, flanked by passages and entered by a doorway of three *ballants* hung on two columns. The whole plan bears more than a superficial resemblance to those of Cretan palaces in the later Minoan period. Only the rough core of the walls is standing to a height of about 3 ft. The fortifications of the citadel have an elaborate double gate with flanking towers. (b) Fortifications, palace, &c., at Sinjerli. The gates here are more elaborate than at Boghaz Keui, but planned with the same idea—that of entrapping in an enclosed space, barred by a second door, an enemy who may have forced the first door, while flanking towers would add to his discomfiture. The palace plan is again rectangular, with a central pillared hall, and very similar in plan to that of Boghaz Keui. The massive walls are also of similar construction. Dados of relief-sculpture run round the inner walls; this feature seems to have been common to Hittite buildings of a sumptuous kind, and accounts for most of the sculptured blocks that have been found, e.g. at Jerablus, Sakchegeuzu, Euyuk, Arslan Tepe, &c. Columns, probably of wood, rested on bases carved as winged lions. (c) Gate with sculptured approach at Euyuk. The ground plan of the gate is practically the same in idea as that at Sinjerli. Structures were found at Jerablus, but never properly uncovered or planned. (d) Sculptured porticoes of temples or palaces uncovered at Sakchegeuzu and Tell Halaf (see above). On other sites, e.g. Arslan Tepe (Ordasu), Arbistan, Marash (above the modern town and near the springs), Beikeul, mounds, doubtless covering structures, may be seen, and sculptured slabs have been recovered. The mounds, probably Hittite, in N. Syria alone are to be counted by hundreds. No tombs certainly Hittite have been found,¹ though it is possible that some of the reliefs (e.g. at Fraktin) are of funerary character.

Sculptures and other Objects of Art.—The sculptures hitherto found consist of reliefs on rocks and on *stelae*, either honorific or funerary; reliefs on blocks forming parts of wall-dados; and a few figures more or less in the round, though most of these (e.g. the sphinxes of Euyuk and the lions of Arslan Tash and Marash) are not completely disengaged from the block. The most considerable sculptured rock-panels are at Boghaz Keui (see PTERIA); the others (Ivris, Fraktin, Karabel, Giau Kalessi, Doghanudere), it should be observed, all lie N. of Taurus—a fact of some bearing on the problem of the origin and local domicile of the art, since rock-reliefs, at any rate, cannot be otherwise than *in situ*. Sculptured *stelae*, honorific or funerary, all with pyramidal or slightly rounded upper ends, and showing a single regal or divine figure or two figures, have come to light at Bor, Marash, Sinjerli, Jerablus, Babylon, &c. These, like most of the rock-panels, are all marked as Hittite by accompanying pictographic inscriptions. The wall-blocks are seldom inscribed, the exceptions (e.g. the Arslan Tepe lion-hunt and certain blocks from Marash and Jerablus) being not more certainly wall-dados than *stelae*. The only fairly complete anthropoid statue known is the much-defaced "Niobe" at Suratlu Tash, engaged in the rock behind. The aniconic lower part of an inscribed statue wholly in the round was found at Palanga, and parts of others at Kirchoglu and Marash. Despite considerable

¹ Five intramural graves were explored at Sinjerli, but whether of the Hittite or of the Assyrian occupation is doubtful.

differences in execution and details, all these sculptures show one general type of art, a type which recalls now Babylonian, now Assyrian, now Egyptian, now archaic Ionian, style, but is always individual and easily distinguishable from the actual products of those peoples. The figures, whether of men or beasts, are of a squat, heavy order, with internal features (e.g. bones, muscles, &c.) shown as if external, as in some Mesopotamian sculptures. The human type is always very brachycephalic, with brow receding sharply and long nose making almost one line with the sloping forehead. In the sculptures of the Com-magene and the Tyana districts, the nose has a long curving tip, of very Jewish appearance, but not unlike the outline given to Kheta warriors in Egyptian scenes. The lips are full and the chin short and shaven. The whole physiognomy is fleshy and markedly distinct from that of other Syrians. At Boghaz Keui, Euyuk and Jerablus, the facial type is very markedly non-Semitic. But not much stress can be laid on these differences owing to (1) great variety of execution in different sculptures, which argues artists of very unequal capacity; (2) doubt whether individual portraits are intended in some cases and not in others. The hair of males is sometimes, but not always, worn in pigtail. The fashions of head-covering and clothes are very various, but several of them—e.g. the horned cap of the Ivris god; the conical hat at Boghaz Keui, Fraktin, &c.; the "jockey-cap" on the Tarkudimme boss; the broad-bordered over-robe, and the upturned shoes—are not found on other Asiatic monuments, except where Hittites are portrayed. Animals in profile are represented more naturalistically than human beings, e.g. at Yasili Kaya, and especially in some pictographic symbols in relief (e.g. at Hamah). This, however, is a feature common to Mesopotamian and Egyptian, and perhaps to all primitive art.

The subjects depicted are processions of figures, human and divine (Yasili Kaya, Euyuk, Giau Kalessi); scenes of sacrifice or adoration, or other cult-practice (Yasili Kaya, Euyuk, Fraktin, Ivris, and perhaps the figures seated beside tables at Marash Sakchegeuzu, Sinjerli, &c.); of the chase (Arslan Tepe, Sakchegeuzu); but not, as known at present, of battle. Both at Euyuk and Yasili Kaya reliefs in one and the same series are widely separated in artistic conception and execution, some showing the utmost *sautele*, others expressing both outline and motion with fair success. The fact warns us against drawing hasty inductions as to relative dates from style and execution.

Besides sculptures, well assured, Hittite art-products include a few small objects in metal (e.g. heavy, inscribed gold ring bought by Sir W. M. Ramsay at Konia; base silver seal, supported on three lions' claws, bought by D. G. Hogarth at Bor; inscribed silver boss of "Tarkudimme," mentioned above, &c., &c.); many intaglios in various stones (chiefly in steatite), mostly either spheroidal or gable-shaped, but a few scarabaeoid, conical or cylindrical, bearing sometimes pictographic symbols, sometimes divine, human or animal figures. The best collection is at Oxford. The majority are of very rude workmanship, bodies and limbs being represented by mere skeleton lines or unfilled outlines; a few vessels (e.g. inscribed basalt bowl found at Babylon) and fragments of ware painted with dark ornament on light body-clay, or in polychrome on a cream-white slip, or black burnished, found on N. Cappadocian sites, &c. The bronzes hitherto claimed as Hittite have been bought on the Syrian coast or come from not certainly Hittite sites in Cappadocia (see E. Chantre, *Mission en Cappadocie*). A great many small objects were found in the excavations at Sinjerli, including carved ivories, seals, toilet-instruments, implements, &c., but these have not been published. Nor, except provisionally, has the pottery, found at Sakchegeuzu.

Inscriptions.—These, now almost sixty in number (excluding seals), are all in a pictographic character which employed symbols somewhat elaborately depicted in relief, but reduced to conventional and "shorthand" representations in the incised texts. So far, the majority of our Hittite inscriptions, like those first found at Hamah, are in relief (cameo); but the incised characters, first observed in the Tyana district, have since been shown, by discoveries at Marash, Babylon, &c., to have had a

wider range. It has usually been assumed that the incised inscriptions, being the more conventionalized, are all of later date than those in relief; but comparison of Egyptian inscriptions, wherein both incised and cameo characters coexisted back to very early times, suggests that this assumption is not necessarily correct. The Hittite symbols at present known show about two hundred varieties; but new inscriptions continually add to the list, and great uncertainty remains as to the distinction of many symbols (*i.e.* whether mere variants or not), and as to many others which are defaced or broken in our texts. The objects represented by these symbols have been certainly identified in only a few instances. A certain number are heads (human and animal) detached from bodies, in a manner not known in the Egyptian hieroglyphic system, with which some of the other symbols show obvious analogies. Articles of dress, weapons, tools, &c., also appear. The longer inscriptions are disposed in horizontal zones or panels, divided by lines, and, it seems, they were to be read *boustrophedon*, not only as regards the lines (which begin right to left) but also the words, which are written in columnar fashion, syllable *below* syllable, and read downwards and upwards alternately. The direction of reading is towards any faces which may be shown among the pictographs. The words are perhaps distinguished in some texts by punctuation marks.

Long and patient efforts have been made to decipher this script, ever since it was first restored to our knowledge; and among the would-be decipherers honourable mention must be made, for persistence and courage, of Professor A. H. Sayce and of Professor P. Jensen. Other interpretations have been put forward by F. E. Peiser (based on conjectures as to the names on the Nineveh sealings), C. R. Conder (based largely on Cypriote comparisons and phonetic values transferred from these) and C. J. Ball (based on Hittite names recorded on Egyptian and Assyrian monuments, and applied to word-groups on the Hittite monuments). These, however, as having arbitrary and inadequate foundations, and for other reasons, have not been accepted. F. Hommel, J. Halévy and J. Menant have done useful work in distinguishing word-groups, and have essayed partial interpretations. No other decipherers call for mention. A. H. Sayce and P. Jensen alone have enlisted any large body of adherents; and the former, who has worked upon his system for thirty years and published in the *Proceedings of the Society for Biblical Archaeology* for 1907 a summary of his method and results, has proceeded on the more scientific plan. His system, however, like all others, is built in the main upon hypotheses incapable at present of quite satisfactory verification, such, for example, as the conjectural reading "Gargamish" for a group of symbols which recurs in inscriptions from Jerablus and elsewhere. In this case, to add to the other obvious elements of uncertainty, it must be borne in mind that the location of Carchemish at Jerablus is not proved, though it is very probable. Other conjectural identifications of groups of symbols with the place-names Hamath, Marash, Tyana are bases of Sayce's system. Jensen's system may be said to have been effectually demolished by L. Messerschmidt in his *Bemerkungen* (1898); but Sayce's system, which has been approved by Hommel and others, is probably in its main lines correct. Its frequent explanation, however, of incompatible symbols by the doctrines of phonetic variation and interchange, or by alternative values of the same symbol used as ideograph, determinative or phonetic complement, and the occasional use of circular argument in the process of "verification," do not inspire confidence in other than its broader results. Sayce's phonetic values and interpretations of determinatives are his best assured achievements. But the words thus arrived at represent a language on which other known tongues throw little or no light, and their meaning is usually to be guessed only. In some significant cases, however, the Boghaz Keui tablets appear to give striking confirmation of Sayce's conjectures.

Writing in 1903 L. Messerschmidt, editor of the best collection of Hittite texts up to date, made a *tabula rasa* of all systems of decipherment, asserting that only one sign out of two hundred—

the bisected oval, determinative of divinity—had been interpreted with any certainty; and in view of this opinion, coupled with the steady refusal of historians to apply the results of any Hittite decipherment, and the obvious lack of satisfactory verification, without which the piling of hypothesis on hypothesis may only lead further from probability, there is no choice but to suspend judgment for some time longer as to the inscriptions and all deductions drawn from them.

Are the Monuments Hittite?—It is time to ask this question, although a perfectly satisfactory answer can only be expected when the inscriptions themselves have been deciphered. Almost all "Hittitologues" assume a connexion between the monuments and the Kheta-Khatti-Hittites, but in various degrees; *e.g.* while Sayce has said roundly that common sense demands the acceptance of all as the work of the Hittites, who were the dominant caste throughout a loosely-knit empire extending at one time from the Orontes to the Aegean, Messerschmidt has stated with equal dogmatism that the Hittites proper were only one people out of many¹ in N. Syria and Asia Minor who shared a common civilization, and that therefore they were authors of a part of the monuments only—presumably the N. Syrian, Commagenian and Cataonian groups. O. Puchstein² has denied to the Hittites some of the N. Syrian monuments, holding these of too late a date (judged by their Assyrian analogies) for the flourishing period of the Kheta-Khatti, as known from Egyptian and Assyrian records. He would ascribe them to the Kummukh (Commagenians), who seem to have succeeded the Khatti as the strongest opponents of Assyria in these parts. He was possibly right as regards the Sinjerli and Sakchegeuzu sculptures, which are of provincial appearance. The following considerations, however, may be stated in favour of the ascription of the monuments to the Hittites:—

(1) The monuments in question are found frequently wherever, from other records, we know the Hittites to have been domiciled at some period, *i.e.* throughout N. Syria and in Cataonia. (2) It was under the Khatti that Carchemish was a flourishing commercial city; and if Jerablus be really Carchemish, it is significant that apparently the most numerous and most artistic of the monuments occur there. (3) Among all the early peoples of N. Syria and Asia Minor known to us from Egyptian and Assyrian records, the Kheta-Khatti alone appear frequently as leading to war peoples from far beyond Taurus. (4) The Kheta certainly had a system of writing and a glyptic art in the time of Rameses II., or else the Egyptian account of their copy of the treaty would be baseless. (5) The physiognomy given to Kheta warriors by Egyptian artists is fairly representative of the prevailing type shown in the Hittite sculptures.

Furthermore, the Boghaz Keui tablets, though only partially deciphered as yet, go far to settle the question. They show that whether Boghaz Keui was actually the capital of the Hatti or not, it was a great city of the Hatti, and that the latter were an important element in Cappadocia from very early times. Before the middle of the 16th century B.C. the Cappadocian Hatti were already in relations, generally more or less hostile, with a rival power in Syria, that of Mitanni; and Subbiliuma (= Saplel or Saparura), king of these Hatti, a contemporary of Amenophis IV. and Rameses I., seems to have obtained lasting dominion in Syria by subduing Dushratta of Mitanni. Carchemish thenceforward became a Hatti city and the southern capital of Cappadocian power. Since all the Syrian monuments of the Hittite class, so far known, seem comparatively late (most show such strong Assyrian influence that they must fall after 1200 B.C. and probably even considerably later), while the North Cappadocian monuments (as Sayce, Ramsay, Perrot and others saw long ago) are the earlier in style, we are bound to ascribe the origin of the civilization which they represent to the Cappadocian Hatti.

¹ The Assyrian records, as well as the Egyptian, distinguish many peoples in both areas from the Kheta-Khatti; and the most we can infer from these records is that there was an occasional league formed under the Hittites, not any imperial subjection or even a continuous federation.

² *Pseudo-Hethitische Kunst* (Berlin, 1890).

Whether the Mitanni had shared in that civilization while independent, and whether they were racially kin to the Hatti, cannot be determined at present. Winckler has adduced evidence from names of local gods to show that there was an Indo-European racial element in Mitanni; but none for a similar element in the Hatti, whose chief god was Teshub. The majority of scholars has always regarded the Hittites proper as, at any rate, non-Semitic, and some leading authorities have called them proto-Armenian, and believed that they have modern descendants in the Caucasus. This racial question can hardly be determined till those Hatti records, whether in cuneiform or pictographic script, which are couched in a native tongue, not in Babylonian, are read. In the meantime we have proper names to argue from; and these give us at least the significant indication that the Hittite nominative ended in *s* and the accusative in *m*. In any case the connexion of the Hatti with the peculiar class of monuments which we have been describing, can hardly be further questioned; and it has become more than probable that the Hatti of Cappadocia were responsible in the beginning for the art and script of those monuments and for the civilization of which they are memorials. Other peoples of north Syria and Asia Minor (e.g. the Kummukh or Commagians and the Muski or Phrygians) came no doubt under the influence of this civilization and imitated its monuments, while subject to or federated with the Hatti. Through Phrygia and Lydia (q.v.) influences of this same Cappadocian civilization passed towards the west; and indeed, before the Greek colonization of Asia Minor, a loosely knit Hatti empire may have stretched even to the Aegean. The Nymphs (Kara Bel) and Niobe sculptures near Smyrna are probably memorials of that extension. Certainly some inland Anatolian power seems to have kept Aegean settlers and culture away from the Ionian coast during the Bronze Age, and that power was in all likelihood the Hatti kingdom of Cappadocia. Owing perhaps to Assyrian aggression, this power seems to have begun to suffer decay about 1000 B.C. and thereafter to have shrunk inwards, leaving the coasts open. The powers of Phrygia and Lydia rose successively out of its ruins, and continued to offer westward passage to influences of Mesopotamian culture till well into historic times. The Greeks came too late to Asia to have had any contact with Hatti power obscured from their view by the intermediate and secondary state of Phrygia. Their earliest writers regarded the latter as the seat of the oldest and most godlike of mankind. Only one Greek author, Herodotus, alludes to the prehistoric Cappadocian power and only at the latest moment of its long decline. At the same time, some of the Greek legends seem to show that peoples, with whom the Greeks came into early contact, had vivid memories of the Hatti. Such are the Amazon stories, whose local range was very extensive, and the myths of Memnon and Pelops. The real reference of these stories, however, was forgotten, and it has been reserved to our own generation to rediscover the records of a power and a civilization which once dominated Asia Minor and north Syria and occupied all the continental roads of communication between the East and the West of the ancient world. The credit of having been the first to divine this importance of the Hittites should always be ascribed to Sayce.

The history of the Hatti and their civilization, then, would appear to have been, very briefly, this. They belonged to an ethnic scattered widely over Eastern Asia Minor and Syria at an early period (Khatti invaded Akkad about 1800 B.C. in the reign of Samsuditana); but they first formed a strong state in Cappadocia late in the 16th century B.C. Subbiliuma became their first great king, though he had at least one dynastic predecessor of the name of Hattusil. The Hatti now pushed southwards in force, overcame the kingdom of Mitanni and proceeded partly to occupy and partly to make tributary both north Syria and western Mesopotamia where some of their congeners were already settled. They came early into collision with Egypt, and at the height of their power under Hattusil II. fought the battle of Kadesh with Rameses II., on at least equal terms. Both now and previously the diplomatic correspondence

of the Hatti monarchs shows that they treated on terms of practical equality with both the Babylonian and the Egyptian courts; and that they waged constant wars in Syria, mainly with the Amorite tribes. At this time the Hatti empire or confederacy probably included, on the west, both Phrygia and Lydia. The Boghaz Keui correspondence ceases to be important with the generation following Hattusil II., and in the Assyrian records, which begin about a couple of centuries later, we find Carchemish the chief Hatti city and N. Syria called the Hattiland. It is possible therefore that a change of imperial centre took place after the Hatti had ceased to fear Egypt in north Syria. If so, the continuation of Hittite history will have to be sought among the remains at Jerablus and other middle Euphratean sites, rather than in those at Boghaz Keui. The establishment of the Hatti at Carchemish not only made them a commercial people and probably sapped their highland vigour, but also brought them into closer proximity to the rising North Semitic power of Assyria, whose advent had been regarded with apprehension by Hattusil II. (see above). One of his successors, Arnaunta (late 13th century?), was already feeling the effect of Assyrian pressure, and with the accession of Tiglath Pileser I., about a century later, a long but often interrupted series of Assyrian efforts to break up the Hatti power began. A succession of Ninevite armies raided north Syria and even south-east Asia Minor, and gradually reduced the Hatti. But the resistance of the latter was sturdy and prolonged. They remained the strongest power in Syria and eastern Asia Minor till well into the first millennium B.C., and their Syrian seat was not lost finally till after the great extension of Assyrian power which took place in the latter part of the 9th century. What had been happening to their Cappadocian province meanwhile we do not yet know; but the presence of Phrygian inscriptions at Euyuk and Tyana, ancient seats of their power, suggests that the client monarchy in the Sangarius valley shook itself free during the early part of the Hittite struggle with Assyria, and in the day of Hatti weakness extended its dominion over the home territory of its former suzerain. "White Syrians," however, were still in Cappadocia even after the Cimmerians had destroyed the Phrygian monarchy, allowing Lydia to become independent under the Mermnad dynasty. Croesus found them centred at Pteria in the 6th century and dealt them a final blow. But much of their secular or religious custom lived on to be recorded by Greek writers, and regarded by modern scholars as typically "Anatolian."

BIBLIOGRAPHY.—General summaries: L. Messerschmidt, *The Hittites* ("Ancient East" series, vi., 1903); A. H. Sayce, *The Hittites* ("Bypaths of Biblical Knowledge" series, xii., 2nd ed. 1892); G. Perrot and C. Chipiez, *History of Art in Sardania, Judaea, Syria and Asia Minor* (Eng. trans., vol. ii., 1890); L. Lantsheere, *De la race et de la langue des Hittites* (1891); P. Jensen, *Hittiter und Armenier* (1898); M. Jastrow, final chapter in H. V. Hilprecht, *Exploration in Bible Lands* (1903); W. Wright, *Empire of the Hittites* (1884); F. Hommel, *Hittiter und Skythen* (1898); D. G. Hogarth, *Jonia and the East* (1909); W. Max Müller, *Asien und Europa*, chap. xxv. (1893). See also authorities for Egyptian and Assyrian history.

Inscriptions: L. Messerschmidt, "Corpus Inscr. Hettitarum," *Zeitsch. d. d. morgenl. Gesellsch.* (1900, 1902, 1906, &c.), and "Bemerkungen zu d. Heth. Inschriften," *Mittel. d. vorderasiat. Gesellsch.* (1898); P. Jensen, "Grundlagen für eine Entzifferung der (Hatt. oder) Cilicischen Inschriften," *Zeitsch. d. d. morgenl. Gesellsch.* (1894); F. E. Peiser, *Die Hettitischen Inschriften* (1892); A. H. Sayce, "Decipherment of the Hittite Inscriptions," *Proc. Soc. of Bibl. Archaeology* (1903), and "Hittite Inscriptions, translated and annotated," *ibid.* (1905, 1907); J. Menant, "Études Hittitiques," *Recueil de travaux rel. à la philologie, &c.*, and *Mém. de l'Acad. Inscr.*, vol. xxxiv. (1890); J. Halévy in *Revue sémitique*, vol. 3. Also divers articles by A. H. Sayce, F. Hommel and others in *Proc. and Trans. Soc. Bibl. Arch.* since 1876, and in *Recueil de travaux, &c.*, since its beginning.

Exploration: G. Perrot and E. Guillaume, *Exploration arch. de la Galatie, &c.* (1862-1872); E. Chantre, *Mission en Cappadoce* (1898); Sir W. M. Ramsay, "Syro-Cappadocian Monuments," in *Athen. Mittheilungen* (1889), with D. G. Hogarth, "Pre-Hellenic Monuments of Cappadocia," in *Recueil de travaux, &c.* (1892-1895); and with Miss Gertrude Bell, *The Thousand and One Churches* (1900); C. Humann and O. Puchstein, *Reisen in Nord-Syrien, &c.* (1890); J. Garstang in *Annals of Archaeology and Anthropology*, i. (1908) and following numbers. Reports on excavations at Sinjerli in *Berl.*

Philol. Wochenschrift (1891), pp. 803, 951; and F. von Luschan, and others, "Ausgrabungen in Sendschirli" in *Mitteil. Orient-Sammlungen* (Berlin Museum, 1893 ff.); and on excavations at Boghaz-Keui, H. Winckler in *Oriental. Literaturzeitung* (Berlin, 1907); *Mitteil. Orient-Gesellschaft* (Dec. 1907). See also s.s. PTERIA.

(D. G. H.)

HITTORFF, JACQUES IGNACE (1792-1867), French architect, was born at Cologne on the 20th of August 1792. After serving an apprenticeship to a mason in his native town, he went in 1810 to Paris, and studied for some years at the Academy of Fine Arts, where he was a favourite pupil of Bélanger, the government architect, who in 1814 appointed him his principal inspector. Succeeding Bélanger as government architect in 1818, he designed many important public and private buildings in Paris and also in the south of France. From 1819 to 1830 in collaboration with le Comte he directed the royal fêtes and ceremonials. After making architectural tours in Germany, England, Italy and Sicily, he published the result of his observations in the latter country in the work *Architecture antique de la Sicile* (3 vols., 1826-1830; new edition, 1866-1867), and also in *Architecture moderne de la Sicile* (1826-1835). One of his important discoveries was that colour had been made use of in ancient Greek architecture, a subject which he especially discussed in *Architecture polychrome chez les Grecs* (1830) and in *Restitution du temple d'Empédocle à Selinunte* (1851); and in accordance with the doctrines enunciated in these works he was in the habit of making colour an important feature in most of his architectural designs. His principal building is the church of St Vincent de Paul in the basilica style, which was constructed between 1830 and 1844. He also designed the two fountains in the Place de la Concorde, the Circus of the Empress, the Rotunda of the panoramas, many cafés and restaurants of the Champs Elysées, the houses forming the circle round the Arc de Triomphe de l'Étoile, besides many embellishments of the Bois de Boulogne and other places. In 1833 he was elected a member of the Academy of Fine Arts. He died in Paris on the 25th of March 1867.

HITZACKER, a town of Germany, in the Prussian province of Hanover at the influx of the Jetze into the Elbe, 33 m. N.E. of Lüneburg by the railway to Wittenberge. Pop. (1905) 1106. It has an Evangelical church and an old castle and numerous medieval remains. There are chalybeate springs and a hydro-pathic establishment in the town. The famous library now in Wolfenbüttel was originally founded here by Augustus, duke of Brunswick (d. 1666) and was removed to its present habitation in 1643.

HITZIG, FERDINAND (1807-1875), German biblical critic, was born at Hainingen, Baden, where his father was a pastor, on the 23rd of June 1807. He studied theology at Heidelberg under H. E. G. Paulus, at Halle under Wilhelm Gesenius and at Göttingen under Ewald. Returning to Heidelberg he became *Privatdozent* in theology in 1829, and in 1831 published his *Begriff der Kritik am Alten Testamente praktisch erörtert*, a study of Old Testament criticism in which he explained the critical principles of the grammatico-historical school, and his *Des Propheten Jonas Orakel über Moab*, an exposition of the 15th and 16th chapters of the book of Isaiah attributed by him to the prophet Jonah mentioned in 2 Kings xiv. 25. In 1833 he was called to the university of Zürich as professor ordinarius of the theology. His next work was a commentary on Isaiah with a translation (*Übersetzung u. Auslegung des Propheten Jesajas*), which he dedicated to Heinrich Ewald, and which Hermann Hupfeld (1796-1866), well known as a commentator on the Psalms (1855-1861), pronounced to be his best exegetical work. At Zürich he laboured for a period of twenty-eight years, during which, besides commentaries on *The Psalms* (1835-1836; 2nd ed., 1863-1865), *The Minor Prophets* (1838; 3rd ed., 1863), *Jeremiah* (1841; 2nd ed., 1866), *Ezekiel* (1847), *Daniel* (1850), *Ecclesiastes* (1847), *Canticles* (1855), and *Proverbs* (1858), he published a monograph, *Über Johannes Markus u. seine Schriften* (1843), in which he maintained the chronological priority of the second gospel, and sought to prove that the Apocalypse was written by the same author. He also published various treatises

of archaeological interest, of which the most important are *Die Erfindung des Alphabets* (1840), *Urgeschichte u. Mythologie der Phönizier* (1845), and *Die Grabchrift des Eschmunazar* (1855). After the death of Friedrich Umbreit (1795-1860), one of the founders of the well-known *Studien und Kritiken*, he was called in 1861 to succeed him as professor of theology at Heidelberg. Here he wrote his *Geschichte des Volkes Israel* (1869-1870), in two parts, extending respectively to the end of the Persian domination and to the fall of Masada, A.D. 72, as well as a work on the Pauline epistles, *Zur Kritik Paulinischer Briefe* (1870), on the Moabite Stone, *Die Inschrift des Mescha* (1870), and on Assyrian, *Sprache u. Sprachen Assyriens* (1871), besides revising the commentary on Job by Ludwig Hirzel (1801-1841), which was first published in 1839. He was also a contributor to the *Monatsschrift des wissenschaftlichen Vereins in Zürich*, the *Zeitschrift der deutschen morgenländischen Gesellschaft*, the *Theologische Studien u. Kritiken*, Eduard Zeller's *Theologische Jahrbücher*, and Adolf Hilgenfeld's *Zeitschrift für wissenschaftliche Theologie*. Hitzig died at Heidelberg on the 22nd of January 1875. As a Hebrew philologist he holds high rank; and as a constructive critic he is remarkable for acuteness and sagacity. As a historian, however, some of his speculations have been considered fanciful. "He places the cradle of the Israelites in the south of Arabia, and, like many other critics, makes the historical times begin only with Moses" (F. Lichtenberger, *History of German Theology*, p. 569).

His lectures on biblical theology (*Vorlesungen über biblische Theologie u. messianische Weissagungen*) were published in 1860 after his death, along with a portrait and biographical sketch by his pupil, J. J. Kneucker (b. 1830), professor of theology at Heidelberg. See Heinrich Steiner, *Ferdinand Hitzig* (1882); and Adolf Kamphausen's article in *Herzog-Hauck's Realencyclopädie*.

HIUNG-NU, HIONG-NU, HEUNG-NU, a people who about the end of the 3rd century B.C. formed, according to Chinese records, a powerful empire from the Great Wall of China to the Caspian. Their ethnical affinities have been much discussed; but it is most probable that they were of the Turki stock, as were the Huns, their later western representatives. They are the first Turkish people mentioned by the Chinese. A theory which seems plausible is that which assumes them to have been a heterogeneous collection of Mongol, Tungus, Turki and perhaps even Finnish hordes under a Mongol military caste, though the Mongolo-Tungus element probably predominated. Towards the close of the 1st century of the Christian era the Hiung-nu empire broke up. Their subsequent history is obscure. Some of them seem to have gone westward and settled on the Ural river. These, de Guignes suggests, were the ancestors of the Huns, and many ethnologists hold that the Hiung-nu were the ancestors of the modern Turks.

See *Journal Anthropological Institute* for 1874; Sir H. H. Howorth, *History of the Mongols* (1876-1880); 6th Congress of Orientalists, Leiden, 1883 (*Actes*, part iv. pp. 177-195); de Guignes, *Histoire générale des Huns, des Turcs, des Mongoles, et des autres Tartares occidentaux* (1756-1758).

HIVITES, an ancient tribe of Palestine driven out by the invading Israelites. In Josh. ix. 7, xi. 19 they are connected with Gibeon. The meaning of the name is uncertain; Wellhausen derives it from חַי "Eve," or "serpent," in which case the Hivites were originally the snake clan; others explain it from the Arabic *havy*, "family," as meaning "dwellers in (Bedouin) encampments." (See PALESTINE; JEWS.)

HJÖRRING, an ancient town of Denmark, capital of the amt (county) of its name, in the northern insular part of the peninsula of Jutland. Pop. (1901) 7901. It lies 7 m. inland from the shore of Jammer Bay, a stretch of coast notoriously dangerous to shipping. On the coast is Lønstrup, a favoured seaside resort. In this neighbourhood as well as to the south-east of Hjörning, slight elevations are seen, deserving the name of hills in this low-lying district. Hjörning is on the northern railway of Jutland, which here turns eastward to the Cattedag part of Frederikshavn (23 m.), a harbour of refuge.

HKAMTI LÔNG (called Kantigyl by the Burmese, and Bor Hkampti by the peoples on the Assam side), a collection of seven

Shan states subordinate to Burma, but at present beyond the administrative border. Estimated area, 900 sq. m.; estimated pop. 11,000. It lies between 27° and 28° N. and 97° and 98° E., and is bordered by the Mishmi country on the N., by the Patkai range on the W., by the Hukawng valley on the S. and E., and indeed all round by various Chingpaw or Kachin communities. The country is little known. It was visited by T. T. Cooper, the Chinese traveller and political agent at Bhamo, where he was murdered; by General Woodthorpe and Colonel Macgregor in 1884, by Mr Errol Grey in the following year, and by Prince Henry of Orleans in 1895. All of these, however, limited their explorations to the valley of the Mali-hka, the western branch of the Irrawaddy river. Hkamti has shrunk very much from its old size. It was no doubt the northernmost province of the Shan kingdom, founded at Mogaung by Sam Lông-hpa, the brother of the ruler of Kambawsa, when that empire had reached its greatest extension. The irruption of Kachins or Chingpaw from the north has now completely hemmed the state in. Prince Henry of Orleans described it as "a splendid territory, fertile in soil and abundant in water, where tropical and temperate culture flourish side by side, and the inhabitants are protected on three fronts by mountains." According to him the Kiutze, the people of the hills between the Irrawaddy and the Salween, call it the kingdom of Moam.

HLOTHHERE, king of Kent, succeeded his brother Egberht in 673, and appears for a time to have reigned jointly with his nephew Eadric, son of Egberht, as a code of laws still extant was issued under both names. Neither is mentioned in the account of the invasion of Æthelred in 676. In 685 Eadric, who seems to have quarrelled with Hlothhere, went into exile and led the South Saxons against him. Hlothhere was defeated and died of his wounds.

See Bede, *Hist. eccl.* (Plummer), iv. 5, 17, 26, v. 24; *Saxon Chronicle* (Earle and Plummer), s.a. 685; Schmid, *Gesetze*, pp. 10 sqq.; Thorpe, *Ancient Laws*, i. 26 sqq.

HOACTZIN, or **HOATZIN**, a bird of tropical South America, thought by Buffon to be that indicated by Hernandez or Fernandez under these names, the *Opisthocomus hoazin* or *O. cristatus* of modern ornithologists—a very curious and remarkable form, which has long exercised the ingenuity of classifiers. Placed by Buffon among his "Hoccos" (Curassows), and then by P. L. S. Müller and J. F. Gmelin in the Linnaean genus *Phasianus*, some of its many peculiarities were recognized by J. K. W. Illiger in 1811 as sufficient to establish it as a distinct genus, *Opisthocomus*; but various positions were assigned to it by subsequent systematic authors. L'Herminier was the first to give any account of its anatomy (*Comptes rendus*, 1837, v. 433), and from his time our knowledge of it has been successively increased by Johannes Müller (*Ber. Akad. Wissensch. Berlin*, 1841, p. 177), Deville (*Rev. et mag. de zoologie*, 1852, p. 217), Gervais (Castelnau, *Expéd. Amérique du Sud, zoologie, anatomie*, p. 66), Huxley (*Proc. Zool. Society*, 1868, p. 304), Perrin (*Trans. Zool. Society*, ix. p. 353), and A. H. Garrod (*Proc. Zool. Society*, 1879, p. 109). After a minute description of the skeleton of *Opisthocomus*, with the especial object of determining its affinities, Huxley declared that it "resembles the ordinary gallinaceous birds and pigeons more than it does any others, and that when it diverges from them it is either *swi generis* or approaches the *Musophagidae*." He accordingly regarded it as the type and sole member of a group, named by him *Heteromorphae*, which sprang from the great Carinate stem later than the *Tinamomorphae*, *Turnicomorphae*, or *Charadriomorphae*, but before the *Peristeromorphae*, *Pterocloromorphae* or *Alectroromorphae*. This conclusion is substantially the same as that at which A. H. Garrod subsequently arrived after closely examining and dissecting specimens preserved in spirit; but the latter has gone further and endeavoured to trace more particularly the descent of this peculiar form and some others, remarking that the ancestor of *Opisthocomus* must have left the parent stem very shortly before the true *Gallinae* first appeared, and at about the same time as the independent pedigree of the *Cuculidae* and *Musophagidae* commenced—these two groups being, he believed, very closely related, and *Opisthocomus* serving to fill the gap between them.

The first thing that strikes the observer of its skeleton is the extraordinary structure of the sternal apparatus, which is wholly unlike that of any other bird known. The keel is only developed on the posterior part of the sternum—the fore part being, as it were, cut away, while the short furcula at its symphysis meets the manubrium, with which it is firmly consolidated by means of a prolonged and straight hypocleidium, and anteriorly ossifies with the coracoids. This unique arrangement seems to be correlated with the enormously capacious crop, which rests upon the furcula and fore part of the sternum, and is also received in a cavity formed on the surface of each of the great pectoral muscles. Furthermore this crop is extremely muscular, so as more to resemble a gizzard, and consists of two portions divided by a partial constriction, after a fashion of which no other example is known among birds. The true gizzard is greatly reduced.

The hoactzin appears to be about the size of a small pheasant, but is really a much smaller bird. The beak is strong, curiously denticulated along the margin of the maxilla near the base, and is beset by diverging bristles. The eyes, placed in the middle of a patch of bare skin, are furnished with bristly lashes, resembling those of horn-bills and some few other birds. The head bears a long pendant crest of loose yellowish feathers. The body is olive-coloured, varied with white above, and beneath



Hoactzin.

is of a dull bay. The wings are short and rounded. The tail is long and tipped with yellow. The legs are rather short, the feet stout, the tarsi reticulated, and the toes scutellated; the claws long and slightly curved. According to all who have observed the habits of this bird, it lives in bands on the lower trees and bushes bordering the streams and lagoons, feeding on leaves and various wild fruits, especially, says H. W. Bates (*Naturalist on the River Amazons*, i. 120), those of a species of *Psidium*, and it is also credited with eating those of an arum (*Caladium arborescens*), which grows plentifully in its haunts. "Its voice is a harsh, grating hiss," continues the same traveller, and "it makes the noise when alarmed, all the individuals sibilating as they fly heavily away from tree to tree, when disturbed by passing canoes." It exhales a very strong odour—wherefore it is known in British Guiana as the "stink-bird"—compared by Bates to "musk combined with wet hides," and by Deville to that of a cow-house. The species is said to be polygamous; the nest is built on trees, of sticks placed above one another, and softer materials atop. Therein the hen lays her eggs to the number of three or four, of a dull-yellowish white, somewhat profusely marked with reddish blotches and spots, so as to resemble those of some of the *Rallidae* (*Proc. Zool. Society*, 1867, pl. xv. fig. 7. p. 164). The young are covered only with very scanty hair, like down, and have well-developed claws on the first and second fingers of the wing, which they use

in clambering about the twigs in a quadrupedal manner; if placed in the water they swim and dive well, although the adults seem to be not at all aquatic. (A. N.)

HOADLY, BENJAMIN (1676-1761), English divine, was born at Westerham, Kent, on the 14th of November 1676. In 1691 he entered Catharine Hall, Cambridge, where he graduated M.A. and was for two years tutor, after which he held from 1701 to 1711 the lectureship of St Mildred in the Poultry, and along with it from 1704 the rectory of St Peter-le-Poer, London. His first important appearance as a controversialist was against Edmund Calamy "the younger" in reference to conformity (1703-1707), and after this he came into conflict with Francis Atterbury, first on the interpretation of certain texts and then on the whole Anglican doctrine of non-resistance. His principal treatises on this subject were the *Measures of Submission to the Civil Magistrate* and *The Origin and Institution of Civil Government discussed*; and his part in the discussion was so much appreciated by the Commons that in 1709 they presented an address to the queen praying her to "bestow some dignity in the church on Mr Hoadly for his eminent services both to church and state." The queen returned a favourable answer, but the dignity was not conferred. In 1710 he was presented by a private patron to the rectory of Streatham in Surrey. In 1715 he was appointed chaplain to the king, and the same year he obtained the bishopric of Bangor. He held the see for six years, but never visited the diocese. In 1716, in reply to George Hickes (*q.v.*), he published a *Preservative against the Principles and Practices of Nonjurors in Church and State*, and in the following year preached before the king his famous sermon on the *Kingdom of Christ*, which was immediately published by royal command. These works were attacks on the divine authority of kings and of the clergy, but as the sermon dealt more specifically and distinctly with the power of the church, its publication caused an ecclesiastical ferment which in certain aspects has no parallel in religious history. It was at once resolved to proceed against him in convocation, but this was prevented by the king proroguing the assembly, a step which had consequences of vital bearing on the history of the Church of England, since from that period the great Anglican council ceased to transact business of a more than formal nature. The restrained sentiments of the council in regard to Hoadly found expression in a war of pamphlets known as the Bangorian Controversy, which, partly from a want of clearness in the statements of Hoadly, partly from the disingenuousness of his opponents and the confusion resulting from exasperated feelings, developed into an intricate and bewildering maze of side discussions in which the main issues of the dispute were concealed almost beyond the possibility of discovery. But however vague and uncertain might be the meaning of Hoadly in regard to several of the important bearings of the questions around which he aroused discussion, he was explicit in denying the power of the Church over the conscience, and its right to determine the condition of men in relation to the favour of God. The most able of his opponents was William Law; others were Andrew Snape, provost of Eton, and Thomas Sherlock, dean of Chichester. So exercised was the mind of the religious world over the dispute that in July 1717 as many as seventy-four pamphlets made their appearance; and at one period the crisis became so serious that the business of London was for some days virtually at a stand-still. Hoadly, being not unskilled in the art of flattery, was translated in 1721 to the see of Hereford, in 1723 to Salisbury and in 1734 to Winchester. He died at his palace at Chelsea on the 17th of April 1761. His controversial writings are vigorous if prolix and his theological essays have little merit. He must have been a much hated man, for his latitudinarianism offended the high church party and his rationalism the other sections. He was an intimate friend of Dr Samuel Clarke, of whom he wrote a life.

Hoadly's brother, JOHN HOADLY (1678-1746), was archbishop of Dublin from 1730 to 1742 and archbishop of Armagh from the latter date until his death on the 10th of July 1746. In early life the archbishop was very intimate with Gilbert Burnet, then

bishop of Salisbury, and in later life he was a prominent figure in Irish politics.

The works of Benjamin Hoadly were collected and published by his son John in 3 vols. (1773). To the first volume was prefixed the article "Hoadly," from the supplement to the *Biographia Britannica*. See also L. Stephen, *English Thought in the 18th Century*.

HOAR, SAMUEL (1778-1856), American lawyer, was born in Lincoln, Massachusetts, on the 18th of May 1778. He was the son of Samuel Hoar, an officer in the American army during the War of Independence, for many years a member of the Massachusetts General Court, and a member in 1820-1821 of the state Constitutional Convention. The son graduated at Harvard in 1802, was admitted to the Massachusetts bar in 1805 and began practice at Concord. His success in his profession was immediate, and for a half-century he was one of the leading lawyers of Massachusetts. He was in early life a Federalist and was later an ardent Whig in politics. He was a member of the state senate in 1825, 1832 and 1833, and of the national house of representatives in 1835-1837, during which time he made a notable speech in favour of the constitutional right of congress to abolish slavery in the District of Columbia. In November 1844, having retired from active legal practice some years before, he went to Charleston, S.C., at the request of Governor George Nixon Briggs (1796-1861), to test in the courts of South Carolina the constitutionality of the state law which provided that "it shall not be lawful for any free negro, or person of color, to come into this state on board any vessel, as a cook, steward or mariner, or in any other employment," and that such free negroes should be seized and locked up until the vessels on which they had come were ready for sea, when they should be returned to such vessels. His visit aroused great excitement, he was threatened with personal injury, the state legislature passed resolutions calling for his expulsion, and he was compelled to leave early in December. In 1848 he was prominent in the Free Soil movement in Massachusetts, and subsequently assisted in the organization of the Republican Party. In 1850 he served in the Massachusetts house of representatives. He married a daughter of Roger Sherman of Connecticut. He died at Concord, Massachusetts, on the 2nd of November 1856.

See a memoir by his son G. F. Hoar in *Memorial Biographies of the New England Historic Genealogical Society*, vol. iii. (Boston, 1883); the estimate by R. W. Emerson in *Lectures and Biographical Sketches* (Boston, 1903); and "Samuel Hoar's Expulsion from Charleston," *Old South Leaflets*, vol. vi. No. 140.

His son, EBENEZER ROCKWOOD HOAR (1816-1895), was born at Concord, Massachusetts, on the 21st of February 1816. He graduated at Harvard in 1835 and at the Harvard Law School in 1839, and was admitted to the Massachusetts bar in 1840. From 1849 to 1855 he was a judge of the Massachusetts court of common pleas, from 1859 to 1869 a judge of the state supreme court, and in 1869-1870 attorney-general of the United States in the cabinet of President Grant, and in that position fought unmerited "machine" appointments to offices in the civil service until at the pressure of the "machine" Grant asked for his resignation from the cabinet. The Senate had already shown its disapproval of Hoar's policy of civil service reform by its failure in 1870 to confirm the President's nomination of Hoar as associate-justice of the supreme court. In 1871 he was a member of the Joint High Commission which drew up the Treaty of Washington. In 1872 he was a presidential elector on the Republican ticket, and in 1873-1875 was a representative in Congress. He was a member of the Board of Overseers of Harvard University from 1868 to 1880 and from 1881 to 1887, and was president of the Board in 1878-1880 and in 1881-1887. He was also prominent in the affairs of the Unitarian church. He was a man of high character and brilliant wit. He died at Concord on the 31st of January 1895.

Another son, GEORGE FRISBIE HOAR (1826-1904), was born in Concord, Massachusetts, on the 29th of August 1826. He graduated at Harvard in 1846 and at the Harvard Law School in 1849. He settled in the practice of law in Worcester, Massachusetts, where in 1852 he became a partner of Emory Washburn (1800-1877). In 1852 he was elected as a Free-Soiler to the

Massachusetts House of Representatives, and during his single term of service became the leader of his party in that body. He was active in the organization of the Republican party in Massachusetts, and in 1857 was elected to the State senate, but declined a re-election. During 1856-1857 he was active in behalf of the Free-State cause in Kansas. He was a member of the National House of Representatives from 1869 until 1877, and in this body took high rank as a ready debater and a conscientious committee worker. He was prominent as a defender and supporter of the Freedman's Bureau, took a leading part in the later reconstruction legislation and in the investigation of the Crédit Mobilier scandal, and in 1876 was one of the House managers of the impeachment of General W. W. Belknap, Grant's secretary of war. In 1877 he was a member of the Electoral Commission which settled the disputed Hayes-Tilden election. From 1877 until his death he was a member of the United States senate. In the senate almost from the start he took rank as one of the most influential leaders of the Republican party; he was a member from 1882 until his death of the important Judiciary Committee, of which he was chairman in 1891-1893 and in 1895-1904. His most important piece of legislation was the Presidential Succession Act of 1886. He was a delegate to every Republican National Convention from 1876 to 1904, and presided over that at Chicago in 1880. He was a conservative by birth and training, and although he did not leave his party he disagreed with its policy in regard to the Philippines, and spoke and voted against the ratification of the Spanish Treaty. He was regent of the Smithsonian Institution in 1880-1881, and long served as an overseer of Harvard University (1896-1904) and as president of its alumni association. He was also president of the American Historical Association (1894-1895) and of the American Antiquarian Society (1884-1887). Like his brother, he was a leading Unitarian, and was president of its National Conference from 1894 to 1902. He died at Worcester, Massachusetts, on the 30th of September 1904. A memorial statue has been erected there.

See his *Recollections of Seventy Years* (New York, 1903).

HOARE, SIR RICHARD COLT, BART. (1758-1838), English antiquary, was the eldest son of Richard Hoare, who was created a baronet in 1786, and was born on the 9th of December 1758. He was descended from Sir Richard Hoare (1648-1718), lord mayor of London, the founder of the family banking business. An ample allowance from his grandfather, Henry Hoare, enabled him to pursue the archaeological studies for which he had already shown an inclination. In 1783 he married Hester, daughter of William Henry, Lord Lytton, and after her death in 1785 he paid a prolonged visit to France, Italy and Switzerland. He succeeded to the baronetcy in 1787, and in 1788 made a second continental tour, the record of his travels appearing in 1819 under the title *A Classical Tour through Italy and Sicily*. A journey through Wales was followed by a translation of the *Itinerarium Cambriae* and of the *Descriptio Cambriae* of Giraldus Cambrensis, Hoare adding notes and a life of Giraldus to the translation. This was first published in 1804, and has been revised by T. Wright (London, 1863). Sir Richard died at Stourhead, Wiltshire, on the 10th of May 1838, being succeeded in the baronetcy by his half-brother, Henry Hugh Hoare. Hoare's most important work was his *Ancient History of North and South Wiltshire* (1812-1819); he also did some work on the large *History of Modern Wiltshire* (1822-1844).

For notices of him and a list of his works, many of which were printed privately, see the *Gentleman's Magazine* for July 1838, and the *Dict. Nat. Biog.* vol. xxvii. (1891). See also E. Hoare, *History of the Hoare Family* (1883).

HOBART, GARRET AUGUSTUS (1844-1899), Vice-President of the United States 1897-1899, was born at Long Branch, N.J., on the 3rd of June 1844. He graduated at Rutgers College in 1863, was admitted to the bar in 1869, practised law at Paterson, N.J., and rose to prominence in the State. He was long conspicuous in the State Republican organization, was chairman of the New Jersey State Republican Committee from 1880 to 1890, became a member in 1884 of the Republican National Committee, and was the delegate-at-large from New Jersey to five successive Republican national nominating conventions.

He served in the New Jersey Assembly in 1873-1874, and in the New Jersey Senate in 1877-1882, and was speaker of the Assembly in 1874 and president of the Senate in 1881 and 1882. He was also prominent and successful in business and accumulated a large fortune. He accepted the nomination as Vice-President in 1896, on the ticket with President McKinley, and was elected; but while still in office he died at Paterson, N.J., on the 21st of November 1899.

See the *Life* (New York, 1910) by David Magie.

HOBART, JOHN HENRY (1775-1830), American Protestant Episcopal bishop, was born in Philadelphia, Pennsylvania, on the 14th of September 1775, being fifth in direct descent from Edmund Hobart, a founder of Hingham, Massachusetts. He was educated at the Philadelphia Latin School, the College of Philadelphia (now the University of Pennsylvania), and Princeton, where he graduated in 1793. After studying theology under Bishop William White at Philadelphia, he was ordained deacon in 1798, and priest two years later. He was elected assistant bishop of New York, with the right of succession, in 1811, and was acting diocesan from that date because of the ill-health of Bishop Benjamin Moore, whom he formally succeeded on the latter's death in February 1816. He was one of the founders of the General Theological Seminary, became its professor of pastoral theology in 1821, and as bishop was its governor. In his zeal for the historic episcopacy he published in 1807 *An Apology for Apostolic Order and its Advocates*, a series of letters to Rev. John M. Mason, who, in *The Christian's Magazine*, of which he was editor, had attacked the Episcopacy in general and in particular Hobart's *Collection of Essays on the Subject of Episcopacy* (1806). Hobart's zeal for the General Seminary and the General Convention led him to oppose the plan of Philander Chase, bishop of Ohio, for an Episcopal seminary in that diocese; but the Ohio seminary was made directly responsible to the House of Bishops, and Hobart approved the plan. His strong opposition to "dissenting churches" was nowhere so clearly shown as in a pamphlet published in 1816 to dissuade all Episcopalians from joining the American Bible Society, which he thought the Protestant Episcopal Church had not the numerical or the financial strength to control. In 1818, to counterbalance the influence of the Bible Society and especially of Scott's *Commentaries*, he began to edit with selected notes the *Family Bible* of the Society for Promoting Christian Knowledge. He delivered episcopal charges to the clergy of Connecticut and New York entitled *The Churchman* (1819) and *The High Churchman Vindicated* (1826), in which he accepted the name "high churchman," and stated and explained his principles "in distinction from the corruptions of the Church of Rome and from the Errors of Certain Protestant Sects." He exerted himself greatly in building up his diocese, attempting to make an annual visit to every parish. His failing health led him to visit Europe in 1823-1825. Upon his return he preached a characteristic sermon entitled *The United States of America compared with some European Countries, particularly England* (published 1826), in which, although there was some praise for the English church, he so boldly criticized the establishment, state patronage, cabinet appointment of bishops, lax discipline, and the low requirements of theological education, as to rouse much hostility in England, where he had been highly praised for two volumes of *Sermons on the Principal Events and Truths of Redemption* (1824). He died at Auburn, New York, on the 12th of September 1830. He was able, impetuous, frank, perfectly fearless in controversy, a speaker and preacher of much eloquence, a supporter of missions to the Oneida Indians in his diocese, and the compiler of the following devotional works: *A Companion for the Altar* (1804), *Festivals and Fasts* (1804), *A Companion to the Book of Common Prayer* (1805), and *A Clergyman's Companion* (1805).

See *Memorial of Bishop Hobart*, containing a *Memoir* (New York, 1831); John McVicker, *The Early Life and Professional Years of Bishop Hobart* (New York, 1834), and *The Closing Years of Bishop Hobart* (New York, 1836).

HOBART PASHA, AUGUSTUS CHARLES HOBART-HAMPDEN (1822-1886), English naval captain and Turkish admiral, was

born in Leicestershire on the 1st of April 1822, being the third son of the 6th Earl of Buckinghamshire. In 1835 he entered the Royal Navy and served as a midshipman on the coast of Brazil in the suppression of the slave trade, displaying much gallantry in the operations. In 1855 he took part, as captain of the "Driver," in the Baltic Expedition, and was actively engaged at Bomarsund and Abo. In 1862 he retired from the navy with the rank of post-captain; but his love of adventure led him, during the American Civil War, to take the command of a blockade-runner. He had the good fortune to run the blockade eighteen times, conveying war material to Charleston and returning with a cargo of cotton. In 1867 Hobart entered the Turkish service, and was immediately nominated to the command of that fleet, with the rank of "Bahrie Limassi" (rear-admiral). In this capacity he performed splendid service in helping to suppress the insurrection in Crete, and was rewarded by the Sultan with the title of Pasha (1869). In 1874 Hobart, whose name had, on representations made by Greece, been removed from the British Navy List, was reinstated; his restoration did not, however, last long, for on the outbreak of the Russo-Turkish war he again entered Turkish service. In command of the Turkish squadron he completely dominated the Black Sea, blockading the ports of South Russia and the mouths of the Danube, and paralysing the action of the Russian fleet. On the conclusion of peace Hobart still remained in the Turkish service, and in 1881 was appointed Mushir, or marshal, being the first Christian to hold that high office. His achievements as a blockade-runner, his blockade of Crete, and his handling of the Turkish fleet against the torpedo-lined coasts of Russia, showed him to be a daring, resourceful, and skilful commander, worthy to be ranked among the illustrious names of British naval heroes. He died at Milan on the 19th of June 1886.

See his *Sketches of My Life* (1886), which must, however, be used with caution, since it contains many proved inaccuracies.

HOBART, the capital of Tasmania, in the county of Buckingham, on the southern coast of the island. It occupies a site of great beauty, standing on a series of low hills at the foot of Mount Wellington, a lofty peak (4166 ft.) which is snow-clad for many months in the year. The town fronts Sullivan's Cove, a picturesque bay opening into the estuary of the river Derwent, and is nearly square in form, laid out with wide streets intersecting at right angles, the chief of which are served by electric tramways. It is the seat of the Anglican bishop of Tasmania, and of the Roman Catholic archbishop of Hobart. The Anglican cathedral of St David dates from 1873, though its foundations were laid as early as 1817. St Mary's Roman Catholic cathedral is a beautiful building; but perhaps the most notable ecclesiastical building in Hobart is the great Baptist tabernacle in Upper Elizabeth Street. The most prominent public buildings are the Houses of Parliament, to which an excellent library is attached; the town hall, a beautiful building of brown and white Tasmanian freestone in Italian style; the museum and national art gallery, and the general post office (1904) with its lofty clock-tower. Government House, the residence of the governor of Tasmania, a handsome castellated building, stands in its domain on the banks of the Derwent, to the north of the town. The botanical gardens adjoin. Of the parks and public gardens, the most extensive is the Queen's Domain, covering an area of about 700 acres, while the most central is Franklin Square, adorned with a statue of Sir John Franklin, the famous Arctic explorer, who was governor of Tasmania from 1837 to 1843. The university of Tasmania, established in 1890, and opened in 1893, has its headquarters at Hobart. The town is celebrated for its invigorating climate, and its annual regatta on the Derwent attracts numerous visitors. The harbour is easy of access, well sheltered and deep, with wharf accommodation for vessels of the largest tonnage. It is a regular port of call for several intercolonial lines from Sydney and Melbourne, and for lines from London to New Zealand. The exports, of an average value of £850,000 annually, consist mainly of fruit, hops, grain, timber and wool. The industries comprise brewing, saw-milling,

iron-founding, flour-milling, tanning, and the manufacture of pottery and woollen goods. Hobart is the centre of a large fruit-growing district, the produce of which, for the most part, is exported to London and Sydney. The city was founded in 1804 and takes its name from Lord Hobart (see **BUCKINGHAMSHIRE, EARLS OF**), then secretary of state for the colonies. It was created a municipality in 1853, and a city in 1857; and in 1881 its name was changed from Hobart Town to the present form. The chief suburbs are Newton, Sandy Bay, Wellington, Risdon, Glenorchy, Bellerive and Beltana. The population of the city proper in 1901 was 24,652, or including suburbs, 34,182.

HOBBEMA, MEYNDERT (c. 1638-1709), the greatest landscape painter of the Dutch school after Ruysdael, lived at Amsterdam in the second half of the 17th century. The facts of his life are somewhat obscure. Nothing is more disappointing than to find that in Hobbema's case chronology and signed pictures substantially contradict each other. According to the latter his practice lasted from 1650 to 1680; according to the former his birth occurred in 1638, his death as late as 1709. If the masterpiece formerly in the Bredel collection, called "A Wooded Stream," honestly bears the date of 1650, or "The Cottages under Trees" of the Ford collection the date of 1652, the painter of these canvases cannot be Hobbema, whose birth took place in 1638, unless indeed we admit that Hobbema painted some of his finest works at the age of twelve or fourteen. For a considerable period it was profitable to pass Hobbemas as Ruysdaels, and the name of the lesser master was probably erased from several of his productions. When Hobbema's talent was recognized, the contrary process was followed, and in this way the name, and perhaps fictitious dates, reappeared by fraud. An experienced eye will note the differences which occur in Hobbema's signatures in such well-known examples as adorn the galleries of London and Rotterdam, or the Grosvenor and van der Hoop collections. Meanwhile, we must be content to know that, if the question of dates could be brought into accordance with records and chronology, the facts of Hobbema's life would be as follows.

Meyndert Hobbema was married at the age of thirty to Eeltje Vinck of Gorcum, in the Oudekerk or old church at Amsterdam, on the 2nd of November 1668. Witnesses to the marriage were the bride's brother Cornelius Vinck and Jacob Ruysdael. We might suppose from this that Hobbema and Ruysdael, the two great masters of landscape, were united at this time by ties of friendship, and accept the belief that the former was the pupil of the latter. Yet even this is denied to us, since records tell us that there were two Jacob Ruysdaels, cousins and contemporaries, at Amsterdam in the middle of the 17th century—one a framemaker, the son of Solomon, the other a painter, the son of Isaac Ruysdael. Of Hobbema's marriage there came between 1668 and 1673 four children. In 1704 Eeltje died, and was buried in the pauper section of the Lelden cemetery at Amsterdam. Hobbema himself survived till December 1709, receiving burial on the 14th of that month in the pauper section of the Westerkerk cemetery at Amsterdam. Husband and wife had lived during their lifetime in the Rozen-gracht, at no great distance from Rembrandt, who also dwelt there in his later and impoverished days. Rembrandt, Hals, Jacob Ruysdael, and Hobbema were in one respect alike. They all died in misery, insufficiently rewarded perhaps for their toil, imprudent perhaps in the use of the means derived from their labours. Posterity has recognized that Hobbema and Ruysdael together represent the final development of landscape art in Holland. Their style is so related that we cannot suppose the first to have been unconnected with the second. Still their works differ in certain ways, and their character is generally so marked that we shall find little difficulty in distinguishing them, nor indeed shall we hesitate in separating those of Hobbema from the feebler productions of his imitators and predecessors—Isaac Ruysdael, Rontbouts, de Vries, Dekker, Looten, Verboom, du Bois, van Kessel, van der Hagen, even Philip de Koningk. In the exercise of his craft Hobbema was patient beyond all conception. It is doubtful whether any one ever so completely

mastered as he did the still life of woods and hedges, or mills and pools. Nor can we believe that he obtained this mastery otherwise than by constantly dwelling in the same neighbourhood, say in Guelders or on the Dutch Westphalian border, where day after day he might study the branching and foliage of trees and underwood embowering cottages and mills, under every variety of light, in every shade of transparency, in all changes produced by the seasons. Though his landscapes are severely and moderately toned, generally in an olive key, and often attuned to a puritanical grey or russet, they surprise us, not only by the variety of their leafage, but by the finish of their detail as well as the boldness of their touch. With astonishing subtlety light is shown penetrating cloud, and illuminating, sometimes transiently, sometimes steadily, different portions of the ground, shining through leaves upon other leaves, and multiplying in an endless way the transparency of the picture. If the chance be given him he mirrors all these things in the still pool near a cottage, the reaches of a sluggish river, or the swirl of the stream that feeds a busy mill. The same spot will furnish him with several pictures. One mill gives him repeated opportunities of charming our eye; and this wonderful artist, who is only second to Ruysdael because he had not Ruysdael's versatility and did not extend his study equally to downs and rocky eminences, or torrents and estuaries—this is the man who lived penuriously, died poor, and left no trace in the artistic annals of his country! It has been said that Hobbema did not paint his own figures, but transferred that duty to Adrian van de Velde, Lingelbach, Barendt Gael, and Abraham Storck. As to this much is conjecture.

The best of Hobbema's dated pictures are those of the years 1663 to 1667. Of the former, several in the galleries of Brussels and St Petersburg, and one in the Holford collection, are celebrated. Of 1665 fine specimens are at Grosvenor House and the Wallace collection. Of seven pieces in the National Gallery, including the "Avenue at Middelharnis," which some assign to 1689, and the "Ruins of Breberode Castle," two are dated 1667. A sample of the last of these years is also in the Fitzwilliam Museum at Cambridge. Amongst the masterpieces in private hands in England may be noticed two landscapes in Buckingham Palace, two at Bridgewater House, and one belonging to Mr Walter of Bearwood. On the continent are a "Wooded Landscape" in the Berlin gallery, a "Forest" belonging to the duchess of Sagan in Paris, and a "Glade" in the Louvre. There are other fine Hobbemas in the Antwerp Museum, the Arenberg gallery at Brussels, and the Belvedere at Vienna.

HOBBS, THOMAS (1588-1679), English philosopher, second son of Thomas Hobbes, was born at Westport (now part of Malmesbury, Wiltshire) on the 5th of April 1588. His father, vicar of Charlton and Westport, an illiterate and choleric man, quarrelled, it is said, with a brother clergyman at the church door, and was forced to decamp, leaving his three children to the care of an elder brother Francis, a flourishing glover at Malmesbury. Thomas Hobbes was put to school at Westport church at the age of four, passed to the Malmesbury school at eight, and was taught again in Westport later at a private school kept by a young man named Robert Latimer, fresh from Oxford and "a good Grecian." He had begun Latin and Greek early, and under Latimer made such progress as to be able to translate the *Medea* of Euripides into Latin iambic verse before he was fourteen. About the age of fifteen he was sent to Oxford and entered at Magdalen Hall. During his residence, the first principal of Magdalen Hall, John Hussee, was succeeded by John Wilkinson, who ruled in the interest of the Calvinistic party in the university. Thus early was he brought into contact with the aggressive Puritan spirit. Apart from this, Hobbes owed little to his university training, which was based on the scholastic logic then prevalent. We have from himself a lively record of his student life (*Vit. carm. esp.* p. lxxv.), which, though penned in extreme old age, may be taken as trustworthy. He tells how, when he had slowly taken in the doctrine of logical figures and moods, he put it aside and would prove things only in his own way; how he then heard about bodies as consisting of matter and form, as throwing off species of themselves for perception, and as moved by sympathies and antipathies, with much else of a like sort, all beyond his comprehension; and how he therefore turned to his

old books again, fed his mind on maps and charts of earth and sky, traced the sun in his path, followed Drake and Cavendish girdling the main, and gazed with delight upon pictured haunts of men and wonders of unknown lands. Very characteristic is the interest in men and things, and the disposition to cut through questions in the schools after a trenchant fashion of his own. He was little attracted by the scholastic learning, though it would be wrong to take his words as evidence of a precocious insight into its weakness. The truth probably is that he took no interest in studies which there was no risk in neglecting, and thought as little of rejecting as of accepting the traditional doctrines. He adds that he took his degree at the proper time; but in fact, upon any computation and from whatever cause, he remained at Magdalen Hall five, instead of the required four, years, not being admitted as bachelor till the 5th of February 1608.

In the same year Hobbes was recommended by Wilkinson as tutor to the son of William Cavendish, baron of Hardwick (afterwards 2nd earl of Devonshire), and thus began a lifelong connexion with a great and powerful family. Twice it was loosened—once, for a short time, after twenty years, and again, for a longer period, during the Civil War—but it never was broken. Hobbes spoke of the first years of his tutorship as the happiest of his life. Young Cavendish was hardly younger than Hobbes, and had been married, a few months before, at the instance of the king, to Christiana, the only daughter of Edward, Lord Bruce of Kinloss, though by reason of the bride's age, which was only twelve years, the pair had no establishment for some time. Hobbes was his companion rather than tutor (before becoming secretary); and, growing greatly attached to each other, they were sent abroad together on the grand tour in 1610. During this journey, the duration of which cannot be precisely stated, Hobbes acquired some knowledge of French and Italian, and also made the important discovery that the scholastic philosophy which he had learned in Oxford was almost universally neglected in favour of the scientific and critical methods of Galileo, Kepler and Montaigne. Unable at first to cope with their unfamiliar ideas, he determined to become a scholar, and until 1628 was engaged in a careful study of Greek and Latin authors, the outcome of which was his great translation of Thucydides. But when he had finished his work he kept it lying by him for years, being no longer so sure of finding appreciative readers; and when he did send it forth, in 1628, he was fain to be content with "the few and better sort."¹

Translation of Thucydides.

That he was finally determined to publication by the political troubles of the year 1628 may be regarded as certain, not only from his own express declaration at a later time (*Vit. carm. esp.*), but also from unmistakable hints in the account of the life and work of his author prefixed to the translation on its appearance. This was the year of the Petition of Right, extorted from the king in the third parliament he had tried within three years of his accession; and, in view of Hobbes's later activity, it is significant that he came forward just then, at the mature age of forty, with his version of the story of the Athenian democracy as the first production of his pen. Nothing else is known of his doings

¹ The translation, under the title *Eight Books of the Peloponnesian War, written by Thucydides the son of Olorus, interpreted with faith and diligence immediately out of the Greek by Thomas Hobbes, secretary to the late Earl of Devonshire*, appeared in 1628 (or 1629), after the death of the earl, to whom touching reference is made in the dedication. It reappeared in 1634, with the date of the dedication altered, as if then newly written. Though Hobbes claims to have performed his work "with much more diligence than elegance," his version is remarkable as a piece of English writing, but is by no means accurate. It fills vols. viii. and ix. in Molesworth's collection (11 vols. including index vol.) of *Hobbes's English Works* (London, Bohn, 1839-1845). The volumes of the collection will here be cited as *E.W.* Molesworth's collection of the Latin *Opera philosophica* (5 vols., 1839-1845) will be cited as *L.W.* The five hundred and odd Latin hexameters under the title *De mirabilibus Peccis* (*L.W.* v. 323-340), giving an account of a short excursion from Chatsworth to view the seven wonders of the Derbyshire Peak, were written before 1628 (in 1626 or 1627), though not published till 1636. It was a New Year's present to his patron, who gave him 5s. in return. A later edition, in 1678, included an English version by another hand.

before 1628, except that through his connexion with young Cavendish he had relations with literary men of note like Ben Jonson, and also with Bacon and Lord Herbert of Cherbury. If he never had any sympathy with Herbert's intuitionist principles in philosophy, he was no less eager, as he afterwards showed, than Herbert to rationalize in matters of religious doctrine, so that he may be called the second of the English deists, as Herbert has been called the first. With Bacon he was so intimate (Aubrey's *Lives*, pp. 222, 602) that some writers have described him as a disciple. The facts that he used to walk with Bacon at Gorhambury, and would jot down with exceptional intelligence the eager thinker's sudden "notions," and that he was employed to make the Latin version of some of the *Essays*, prove nothing when weighed against his own disregard of all Bacon's principles, and the other evidence that the impulse to independent thinking came to him not from Bacon, and not till some time after Bacon's death in 1626.¹

So far as we have any positive evidence, it was not before the year 1629 that Hobbes entered on philosophical inquiry. Meanwhile a great change had been wrought in his circumstances. His friend and master, after about two years' tenure of the earldom of Devonshire, died of the plague in June 1628, and the affairs of the family were so disordered financially that the widowed countess was left with the task of righting them in the boyhood of the third earl. Hobbes went on for a time living in the household; but his services were no longer in demand, and, remaining inconsolable under his personal bereavement, he sought distraction, in 1629, in another engagement which took him abroad as tutor to the son of Sir Gervase Clifton, of an old Nottinghamshire family. This, his second, sojourn abroad appears to have been spent chiefly in Paris, and the one important fact recorded of it is that he then first began to look into Euclid. The engagement came to an end in 1631, when he was recalled to train the young earl of Devonshire, now thirteen years old, son of his previous pupil. In the course of the next seven years in Derbyshire and abroad, Hobbes took his pupil over rhetoric,² logic, astronomy, and the principles of law, with other subjects. His mind was now full of the thought of motion in nature, and on the continent he sought out the philosophical speculators or scientific workers. In Florence in 1636 he saw Galileo, for whom he ever retained the warmest admiration, and spent eight months in daily converse with the members of a scientific circle in Paris, held together by Marin Mersenne (q.v.). From that time (the winter of 1636-1637) he too, as he tells us, was numbered among philosophers.

His introduction to Euclid took place accidentally in 1629 (Aubrey's *Lives*, p. 604). Euclid's manner of proof became the model for his own way of thinking upon all subjects. It is less easy to determine when he awoke to an interest in the physical doctrine of motion. The story told by himself (*Vii. p. xx.*) is that, hearing the question asked "What is sense?" he fell to thinking often on the subject, till it suddenly occurred to him that if bodies and their internal parts were at rest, or were always in the same state of motion, there could be no distinction of anything, and consequently no sense; the cause of all things must therefore be sought in diversity of movements. Starting from this principle he was driven to geometry for insight into the ground and modes of motion. The biographies we possess do not tell us where or when this great change of interest occurred. Nothing is said, however, which contradicts a statement that on his third journey in Europe he began to study the doctrine of motion more seriously, being interested in it before; and as he claims more than once (*L.W. v. 303; E.W. vii. 468*) to have explained light and sound by

¹ Hobbes, in minor works dealing with physical questions (*L.W. iv. 316; E.W. vii. 112*), makes two incidental references to Bacon's writings, but never mentions Bacon as he mentions Galileo, Kepler, Harvey, and others (*De corpore*, ep. ded.), among the lights of the century. The word "Induction," which occurs in only three or four passages throughout all his works (and these again minor ones), is never used by him with the faintest reminiscence of the import assigned to it by Bacon; and, as will be seen, he had nothing but scorn for experimental work in physics.

² The free English abstract of Aristotle's *Rhetoric*, published in 1681, after Hobbes's death, as *The Whole Art of Rhetoric* (*E.W. vi. 423-510*), corresponds with a Latin version dictated to his young pupil. Among Hobbes's papers preserved at Hardwick, where he died, there remains the boy's dictation-book, interspersed with headings, examples, &c. in Hobbes's hand.

a mechanical hypothesis as far back as 1630, the inspiration may be assigned to the time of the second journey. But it was not till the third journey that the new interest became an overpowering passion, and the "philosopher" was on his way home before he had advanced so far as to conceive the scheme of a system of thought to the elaboration of which his life should henceforth be devoted.

Hobbes was able to carry out his plan in some twenty years or more from the time of its conception, but the execution was so broken in upon by political events, and so complicated with other labours, that its stages can hardly be followed without some previous understanding of the relations of the parts of the scheme, as there is reason to believe they were sketched out from the beginning. His scheme was first to work out, in a separate treatise *De corpore*, a systematic doctrine of Body, showing how physical phenomena were universally explicable in terms of motion, as motion or mechanical action was then (through Galileo and others) understood—the theory of motion being applied in the light of mathematical science, after quantity, the subject-matter of mathematics, had been duly considered in its place among the fundamental conceptions of philosophy, and a clear indication had been given, at first starting, of the logical ground and method of all philosophical inquiry. He would then single out Man from the realm of nature, and, in a treatise *De homine*, show what specific bodily motions were involved in the production of the peculiar phenomena of sensation and knowledge, as also of the affections and passions thence resulting, whereby man came into relation with man. Finally he would consider, in a crowning treatise *De cive*, how men, being naturally rivals or foes, were moved to enter into the better relation of Society, and demonstrate how this grand product of human wit must be regulated if men were not to fall back into brutishness and misery. Thus he proposed to unite in one coherent whole the separate phenomena of Body, Man and the State.

Hobbes came home, in 1637, to a country seething with discontent. The reign of "Thorough" was collapsing, and the forces pent up since 1629 were soon to rend the fabric of the state. By these events Hobbes was distracted from the orderly execution of his philosophic plan. The Short Parliament, as he tells us at a later time (*E.W. iv. 414*), was not dissolved before he had ready "a little treatise in English," in which he sought to prove that the points of the royal prerogative which the members were determined to dispute before granting supplies "were inseparably annexed to the sovereignty which they did not then deny to be in the king." Now it can be proved that at this time he had written not only his *Human Nature* but also his *De corpore politico*, the two treatises (though published separately ten years later) having been composed as parts of one work;³ and there cannot be the least question that together they make "the little treatise" just mentioned. We are therefore to understand, first, that he wrote the earliest draft of his political theory some years before the outbreak of the Civil War, and, secondly, that this earliest draft was not written till, in accordance with his philosophical conception, he had established the grounds of polity in human nature. The first point is to be noted, because it has often been supposed that Hobbes's political doctrine took its peculiar complexion from his revulsion against the state of anarchy before his eyes, as he wrote during the progress of the Civil War. The second point must be maintained against his own implied, if not express, statement some years later, when publishing his *De cive* (*L.W. ii. 151*), that he wrote this third part of his system before he had been able to set down any finished representation of the fundamental doctrines which it presupposed. In the beginning of 1640, therefore, he had written out his doctrine of Man at least, with almost as much elaboration as it ever received from him.

In November 1640 the Long Parliament succeeded to the Short, and sent Laud and Straford to the Tower, and Hobbes, who had become, or thought he had become, a marked man by the circulation of his treatise (of which, "though not printed, many gentlemen had copies"), hastened to Paris, "the first of all that fled." He was now for the fourth and last time abroad, and did not return for eleven years. Apparently he remained the greater part of the time in or about

³ Among the Hardwick papers there is preserved a MS. copy of the work, under the title *Elementes of Law Naturall and Politique*, with the dedication to the earl of Newcastle, written in Hobbes's own hand, and dated May 9, 1640. This dedication was prefixed to the first thirteen chapters of the work when printed by themselves, under the title *Human Nature* in 1650.

Paris. He was welcomed back into the scientific coterie about Mersenne, and forthwith had the task assigned him of criticizing the *Meditations* of Descartes, which had been sent from Holland, before publication, to Mersenne with the author's request for criticism from the most different points of view. Hobbes was soon ready with the remarks that were printed as "Third" among the six (later seven) sets of "Objections" appended, with "Replies" from Descartes, to the *Meditations*, when published shortly afterwards in 1641 (reprinted in *L.W.* v. 249-274). About the same time also Mersenne sent to Descartes, as if they came from a friend in England, another set of objections which Hobbes had to offer on various points in the scientific treatises, especially the *Dioptrics*, appended by Descartes to his *Discourse on Method* in 1637; to which Descartes replied without suspecting the common authorship of the two sets. The result was to keep the two thinkers apart rather than bring them together. Hobbes was more eager to bring forward his own philosophical and physical ideas than careful to enter into the full meaning of another's thought; and Descartes was too jealous, and too confident in his conclusions to bear with this kind of criticism. He was very curt in his replies to Hobbes's philosophical objections, and broke off all correspondence on the physical questions, writing privately to Mersenne that he had grave doubts of the Englishman's good faith in drawing him into controversy (*L.W.* v. 277-307).

Meanwhile Hobbes had his thoughts too full of the political theory which the events of the last years had ripened within him to settle, even in Paris, to the orderly composition of his works. Though connected in his own mind with his view of human nature and of nature generally, the political theory, as he always declared, could stand by itself. Also, while he may have hoped at this time to be able to add much (though he never did) to the sketch of his doctrine of Man contained in the unpublished "little treatise," he might extend, but could hardly otherwise modify, the sketch he had there given of his carefully articulated theory of Body Politic. Possibly, indeed, before that sketch was written early in 1640, he may, under pressure of the political excitement, have advanced no small way in the actual composition of the treatise *De Cive*, the third section of his projected system. In any case, it was upon this section, before the others, that he set to work in Paris; and before the end of 1641 the book, as we know from the date of the dedication (November 1), was finished. Though it was forthwith printed in the course of the year 1642, he was content to circulate a limited number of copies privately¹; and when he found his work received with applause (it was praised even by Descartes), he seems to have taken this recognition of his philosophical achievement as an additional reason for deferring publication till the earlier works of the system were completed. Accordingly, for the next three or four years, he remained steadily at work, and nothing appeared from him in public except a short treatise on optics (*Tractatus opticus*, *L.W.* v. 217-248) included in the collection of scientific tracts published by Mersenne under the title *Cogitata physico-mathematica* in 1644, and a highly compressed statement of his psychological application of the doctrine of motion (*L.W.* v. 309-318), incorporated with Mersenne's *Ballistica*, published in the same year. Thus or otherwise he had become sufficiently known by 1645 to be chosen as a referee, with Descartes, Roberval and others, in the famous controversy between John Pell (*q.v.*) and the Dane Longomontanus (*q.v.*) over that problem of the squaring of the circle which was seen later on to have such a fatal charm for himself. But though about this time he had got ready all or most of the materials for his fundamental work on Body, not even now was he able to make way with its composition,

¹The book, of which the copies are rare (one in Dr Williams's library in London and one in the Bodleian), was printed in quarto size (Paris, 1642), with a pictorial title-page (not afterwards reproduced) of scenes and figures illustrating its three divisions, "Liber-tas," "Imperium," "Religio." The title *Elementorum philosophiae sectio tertia, De cive*, expresses its relation to the unwritten sections, which also comes out in one or two back-references in the text.

and when he returned to it after a number of years, he returned a different man.

The Civil War had broken out in 1642, and the royalist cause began to decline from the time of the defeat at Marston Moor, in the middle of 1644. Then commenced an exodus of the king's friends. Newcastle himself, who was a cousin of Hobbes's late patron and to whom he dedicated the "little treatise" of 1640, found his way to Paris, and was followed by a stream of fugitives, many of whom were known to Hobbes. The sight of these exiles made the political interest once more predominant in Hobbes, and before long the revived feeling issued in the formation of a new and important design. It first showed itself in the publication of the *De cive*, of which the fame, but only the fame, had extended beyond the inner circle of friends and critics who had copies of the original impression. Hobbes now entrusted it, early in 1646, to his admirer, the Frenchman Samuel de Sorbière, by whom it was seen through the Elzevir press at Amsterdam in 1647—having previously inserted a number of notes in reply to objections, and also a striking preface, in the course of which he explained its relation to the other parts of the system not yet forthcoming, and the (political) occasion of its having been composed and being now published before them.² So hopeless, meanwhile, was he growing of being able to return home that, later on in the year, he was on the point of leaving Paris to take up his abode in the south with a French friend,³ when he was engaged "by the month" as mathematical instructor to the young prince of Wales, who had come over from Jersey about the month of July. This engagement lasted nominally from 1646 to 1648 when *Leviathan*. Charles went to Holland. Thus thrown more than ever into the company of the exiled royalists, it was then, if not earlier, that he conceived his new design of bringing all his powers of thought and expression to bear upon the production of an English book that should set forth his whole theory of civil government in relation to the political crisis resulting from the war. The *De cive*, presently to be published, was written in Latin for the learned, and gave the political theory without its foundation in human nature. The unpublished treatise of 1640 contained all or nearly all that he had to tell concerning human nature, but was written before the terrible events of the last years had disclosed how men might still be urged by their anti-social passions back into the abyss of anarchy. There was need of an exposition at once comprehensive, incisive and popular. The State, it now seemed to Hobbes, might be regarded as a great artificial man or monster (*Leviathan*), composed of men, with a life that might be traced from its generation through human reason under pressure of human needs to its dissolution through civil strife proceeding from human passions. This, we may suppose, was the presiding conception from the first, but the design may have been variously modified in the three or four years of its execution. Before the end, in 1650-1651, it is plain that he wrote in direct reference to the greatly changed aspect of affairs in England. The king being dead, and the royalist cause appearing to be hopelessly lost, he did not scruple, in closing the work with a general "Review and Conclusion," to raise the question of the subject's right to change allegiance when a former sovereign's power to protect was irrevocably gone. Also he took advantage of the rule of the Commonwealth to indulge much more freely than he might have otherwise dared in rationalistic criticism of religious doctrines; while, amid the turmoil of sects, he could the more forcibly urge that the preservation of social order, when again firmly restored, must depend on the assumption by the civil power of the right

²*L.W.* ii, 133-134. In this first public edition (12mo), the title was changed to *Elementa philosophica de cive*, the references in the text to the previous sections being omitted. The date of the dedication to the young earl of Devonshire was altered from 1641 to 1646.

³Described as "nobilis Languedocianus" in *Viz.*; doubtless the same with the "Dominus Verduisus, nobilis Aquitanus," to whom was dedicated the *Exam. et emend. math. hod.* (*L.W.* iv.) in 1660. Du Verduis was one of Hobbes's profoundest admirers and most frequent correspondents in later years; there are many of his letters among Hobbes's papers at Hardwick.

to wield all sanctions, supernatural as well as natural, against the pretensions of any clergy, Catholic, Anglican or Presbyterian, to the exercise of an *imperium in imperio*.

We know the *Leviathan* only as it finally emerged from Hobbes's pen. During the years of its composition he remained in or near Paris, at first in attendance on his royal pupil, with whom he became a great favourite. In 1647 Hobbes was overtaken by a serious illness which disabled him for six months. Mersenne begged him not to die outside the Roman Catholic Church, but Hobbes said that he had already considered the matter sufficiently and afterwards took the sacrament according to the rites of the Church of England. On recovering from this illness, which nearly proved fatal, he resumed his literary task, and carried it steadily forward to completion by the year 1650, having also within the same time translated into English, with characteristic force of expression, his Latin treatise. Otherwise the only thing known (from one or two letters) of his life in those years is that from the year 1648 he had begun to think of returning home; he was then sixty, and might well be weary of exile. When 1650 came, as if to prepare the way for the reception of his *magnum opus*, he allowed the publication of his earliest treatise, divided into two separate small volumes (*Human Nature, or the Fundamental Elements of Policy*, E.W. iv. 1-76, and *De Corpore Politico, or the Elements of Law, Moral and Politic*, pp. 77-228).¹ In 1651² he published his translation of the *De Cive* under the title of *Philosophical Rudiments concerning Government and Society* (E.W. ii.). Meanwhile the printing of the greater work was proceeding, and finally it appeared about the middle of the same year, 1651, under the title of *Leviathan, or the Matter, Form and Power of a Commonwealth, Ecclesiastical and Civil* (E.W. iii.), with a quaint frontispiece in which, from behind hills overlooking a fair landscape of town and country, there towered the body (above the waist) of a crowned giant, made up of tiny figures of human beings and bearing sword and crozier in the two hands. It appeared, and soon its author was more lauded and decried than any other thinker of his time; but the first effect of its publication was to sever his connexion with the exiled royalist party, and to throw him for protection on the revolutionary Government. No sooner did copies of the book reach Paris than he found himself shunned by his former associates, and though he was himself so little conscious of disloyalty that he was forward to present a manuscript copy "engrossed in vellum in a marvellous fair hand"³ to the young king of the Scots (who, after the defeat at Worcester, escaped to Paris about the end of October), he was denied the royal presence when he sought it shortly afterwards. Straightway, then, he saw himself exposed to a double peril. The exiles had among them desperadoes who could slay; and, besides exciting the enmity of the Anglican clergy about the king, who bitterly resented the secularist spirit of his book, he had compromised himself with the French authorities by his elaborate attack on the papal system. In the circumstances, no resource was left him but secret flight. Travelling with what speed he could in the depths of a severe winter and under the effects of a recent (second) illness, he managed to reach London, where, sending in his submission to the council of state, he was allowed to subside into private life.

Though Hobbes came back, after his eleven years' absence, without having as yet publicly proved his title to rank with the natural philosophers of the age, he was sufficiently conscious of what he had been able to achieve in *Leviathan*; and it was

¹ *The Human Nature* corresponds with cc. i.-xiii. of the first part of the original treatise. The remaining six chapters of the part stand now as Part I. of the *De corpore politico*. Part II. of the *D.C.P.* corresponds with the original second part of the whole work.

² At the beginning of this year he wrote and published in Paris a letter on the nature and conditions of poetry, chiefly epic, in answer to an appeal to his judgment made in the preface to Sir W. Davenant's heroic poem, *Gondibert* (E.W. iv. 441-458). The letter is dated Jan. 10, 1650 (1650/1).

³ This presentation copy, so described by Clarendon (*Survey of the Leviathan*, 1676, p. 8), is doubtless the beautifully written and finely bound MS. now to be found in the British Museum (Egerton MSS. 1910).

in no humble mood that he now, at the age of sixty-four, turned to complete the fundamental treatise of his philosophical system. Neither those whom his masterpiece soon roused to enthusiasm, nor those whom it moved to indignation, were likely to be indifferent to anything he should now write, whether it lay near to or far from the region of practice. Taking up his abode in Fetter Lane, London, on his return, and continuing to reside there for the sake of intellectual society, even after renewing his old ties with the earl of Devonshire, who lived in the country till the Restoration,⁴ he worked so steadily as to be printing the *De corpore* in the year 1654. Circumstances (of which more presently), however, kept the book back till the following year, and meanwhile the readers of *Leviathan* had a different excitement. In 1654 a small treatise, "Of Liberty and Necessity" (E.W. iv. 229-278), issued from the press, claiming to be an answer to a discourse on the same subject by Bishop Bramhall of Londonderry (afterwards archbishop of Armagh, d. 1663), addressed by Hobbes to the marquis of Newcastle.⁵ It had grown out of an oral discussion between Hobbes and Bramhall in the marquis's presence at Paris in 1646. Bramhall, a strong Arminian, had afterwards written down his views and sent them to Newcastle to be answered in this form by Hobbes. Hobbes duly replied, but not for publication, because he thought the subject a delicate one. But it happened that Hobbes had allowed a French acquaintance to have a private translation of his reply made by a young Englishman, who secretly took a copy of the original for himself; and now it was this unnamed purloiner who, in 1654, when Hobbes had become famous and feared, gave it to the world of his own motion, with an extravagantly laudatory epistle to the reader in its front. Upon Hobbes himself the publication came as a surprise, but, after his plain speaking in *Leviathan*, there was nothing in the piece that he need scruple to have made known, and he seems to have condoned the act. On the other hand, Bramhall, supposing Hobbes privy to the publication, resented the manner of it, especially as no mention was made of his rejoinder. Accordingly, in 1655, he printed everything that had passed between them (under the title of *A Defence of the True Liberty of Human Actions from Antecedent or Extrinsic Necessity*), with loud complaint against the treatment he had received, and the promise added that, in default of others, he himself would stand forward to expose the deadly principles of *Leviathan*. About this time Hobbes had begun to be hard pressed by other foes, and, being never more sure of himself than upon the question of the will, he appears to have welcomed the opportunity thus given him of showing his strength. By 1656 he was ready with his *Questions concerning Liberty, Necessity and Chance* (E.W. v.), in which he replied with astonishing force to the bishop's rejoinder point by point, besides explaining the occasion and circumstances of the whole debate, and reproducing (as Bramhall had done) all the pieces from the beginning. As perhaps the first clear exposition and defence of the *psychological* doctrine of determinism, Hobbes's own two pieces must ever retain a classical importance in the history of the free-will controversy; while Bramhall's are still worth study as specimens of scholastic fence. The bishop, it should be added, returned to the charge in 1658 with ponderous *Casitations of Mr Hobbes's Animadversions*, and also made good his previous threat in a bulky

⁴ During all the time he was abroad he had continued to receive from his patron a yearly pension of £80, and they remained in steady correspondence. The earl, having sided with the king in 1642, was declared unfit to sit in the House of Peers, and though, by submission to Parliament, he recovered his estates when they were sequestered later on, he did not sit again till 1660. Among Hobbes's friends at this time are specially mentioned John Selden and William Harvey, who left him a legacy of £10. According to Aubrey, Selden left him an equal bequest, but this seems to be a mistake. Harvey (not Bacon) is the only Englishman he mentions in the dedicatory epistle prefixed to the *De corpore*, among the founders, before himself, of the new natural philosophy.

⁵ The treatise bore the date, "Rouen, Aug. 20, 1652," but it should have been 1646, as afterwards explained by Hobbes himself (E.W. v. 25).

appendix entitled *The Catching of Leviathan the Great Whale*. Hobbes never took any notice of the *Castigations*, but ten years later replied to the charges of atheism, &c., made in the non-political part of the appendix, of which he says he then heard for the first time (*E.W.* iv. 279-384). This *Answer* was first published after Hobbes's death.¹

We may now follow out the more troublesome conflict, or rather series of conflicts, in which Hobbes became entangled from the time of publishing his *De corpore* in 1655, and which checked all his remaining years. In *Leviathan* he had vehemently assailed the system of the universities, as originally founded for the support of the papal against the civil authority, and as still working social mischief by adherence to the old learning. The attack was duly noted at Oxford, where under the Commonwealth a new spirit of scientific activity had begun to stir. In 1654 Seth Ward (1617-1689), the Savilian professor of astronomy, replying in his *Vindiciae academiarum* to some other assaults (especially against John Webster's *Examen of Academies*) on the academic system, retorted upon Hobbes that, so far from the universities being now what he had known them in his youth, he would find his geometrical pieces, when they appeared, better understood there than he should like. This was said in reference to the boasts in which Hobbes seems to have been freely indulging of having squared the circle and accomplished other such feats; and, when a year later the *De corpore* (*E.W.* i.) finally appeared, it was seen how the thrust had gone home. In the chapter (xx.) of that work where Hobbes dealt with the famous problem whose solution he thought he had found, there were left expressions against Vindex (Ward) at a time when the solutions still seemed to him good; but the solutions themselves, as printed, were allowed to be all in different ways halting, as he naively confessed he had discovered only when he had been driven by the insults of malevolent men to examine them more closely with the help of his friends. A strange conclusion this, and reached by a path not less strange, as was now to be disclosed by a relentless hand. Ward's colleague, the more famous John Wallis (q.v.), Savilian professor of geometry from 1649, had been privy to the challenge thrown out in 1654, and it was arranged that they should critically dispose of the *De corpore* between them. Ward was to occupy himself with the philosophical and physical sections, which he did in leisurely fashion, bringing out his criticism in the course of next year (*In Th. Hobbesii philosophiam exercitatio epistolarum*). Wallis was to confine himself to the mathematical chapters, and set to work at once with characteristic energy. Obtaining an unbound copy of the *De corpore*, he saw by the mutilated appearance of the sheets that Hobbes had repeatedly altered his demonstrations before he issued them at last in their actual form, grotesque as it was, rather than delay the book longer. Obtaining also a copy of the work as it had been printed before Hobbes had any doubt of the validity of his solutions, Wallis was able to track his whole course from the time of Ward's provocation—his passage from exultation to doubt, from doubt to confessed impotence, yet still without abandoning the old assumption of confident strength; and all his turnings and windings were now laid bare in one of the most trenchant pieces of controversial writing ever penned. 'Wallis's *Elenchus geometriae Hobbesianae*, published in 1655 about three months after the *De corpore*, contained also an elaborate criticism of Hobbes's whole attempt to relay the foundations of mathematical science in its place within the general body of reasoned knowledge—a criticism which, if it failed to allow for the merit of the conception, exposed only too effectually the utter inadequacy of the result. Taking up mathematics when not only his mind was already formed but his thoughts were crystallizing into a philosophical system, Hobbes had, in fact, never put himself to school and sought to work up gradually to the best knowledge of the time, but had been more anxious from the first to become himself an innovator with whatever insufficient means. The consequence was that, when not spending himself in vain attempts to solve the impossible problems that have always waylaid the fancy of self-sufficient beginners, he took an interest only in the elements of geometry, and never had any notion of the full scope of mathematical science, undergoing as it then was (and not least at the hands of Wallis) the extraordinary development which made it before the end of the century the potent instrument of physical discovery which it became in the hands of Newton. He was even unable, in dealing with the elementary conceptions of geometry, to work out with any consistency the few original thoughts he had, and thus became the easy sport of Wallis. At his advanced age, however, and with the sense he had of his powers, he was not likely to be brought to a better mind by so insulting an opponent. He did indeed, before allowing an English

translation of the *De corpore* (*E.W.* i.) to appear in 1656, take care to remove some of the worst mistakes exposed by Wallis, and, while leaving out all the references to Vindex, now profess to make, in altered form, a series of mere "attempts" at quadrature; but he was far from yielding the ground to the enemy. With the translation,² in the spring of 1656, he had ready *Six Lessons to the Professors of Mathematics, one of Geometry, the other of Astronomy, in the University of Oxford* (*E.W.* vii. 181-356), in which, after reasserting his view of the principles of geometry in opposition to Euclid's, he proceeded to repel Wallis's objections with no lack of dialectical skill, and with an unreserve equal to Wallis's own. He did not scruple, in the ardour of conflict, even to maintain positions that he had resigned in the translation, and he was not afraid to assume the offensive by a counter criticism of three of Wallis's works then published. When he had thus disposed of the "Paralogisms" of his more formidable antagonist in the first five Lessons, he ended with a lesson on "Manners" to the two professors together, and set himself gravely at the close to show that he too could be abusive. In this particular part of his task, it must be allowed, he succeeded very well; his criticism of Wallis's works, especially the great treatise *Arithmetica infinitorum* (1655), only showed how little able he was to enter into the meaning of the modern analysis. Wallis, on his side, was not less ready to keep up the game in English than he had been to begin it in Latin. Swift as before to strike, in three months' time he had deftly turned his own word against the would-be master by administering *Due Correction for Mr Hobbes, or School Discipline for not saying his Lessons right*, in a piece that differed from the *Elenchus* only in being more biting and unrestrained. Having an easy task in defending himself against Hobbes's trivial criticism, he seized the opportunity given him by the English translation of the *De corpore* to track Hobbes again step by step over the whole course, and now to confront him with his incredible inconsistencies multiplied by every new utterance. But it was no longer a fight over mathematical questions only. Wallis having been betrayed originally by his fatal cleverness into the pettiest carping at words, Hobbes had retorted in kind, and then it became a high duty in the other to defend his Latin with great parade of learning and give fresh provocation. One of Wallis's rough sallies in this kind suggested to Hobbes the title of the next rejoinder with which, in 1657, he sought to close the unseemly wrangle. Arguing in the *Lessons* that a mathematical point must have quantity, though this were not reckoned, he had explained the Greek word *στυγή*, used for a point, to mean a visible mark made with a hot iron; whereupon he was charged by Wallis with gross ignorance for confounding *στυγή* and *στυγμα*. Hence the title of his new piece: *Στυγμα ἀγαμέμνωνος, ἀγροίκου, ἀντιπολιτείας, ἀμύθητος, or Marks of the Absurd Geometry, Rural Language, Scottish Church Politics, and Barbarisms of John Wallis, Professor of Geometry and Doctor of Divinity* (*E.W.* vii. 357-400). He now attacked more in detail but not more happily than before Wallis's great work, while hardly attempting any further defence of his own positions; also he repelled with some force and dignity the insults that had been heaped upon him, and fought the verbal points, but could not leave the field without making political insinuations against his adversary, quite irrelevant in themselves and only noteworthy as evidence of his own resignation to Cromwell's rule. The thrusts were easily and nimbly parried by Wallis in a reply (*Hobbesii puncti disjunctio*, 1657) occupied mainly with the verbal questions. Irritating as it was, it did not avail to shake Hobbes's determination to remain silent; and thus at last there was peace for a time.

Before the strife flamed up again, Hobbes had published, in 1658, the outstanding section of his philosophical system, and thus completed, after a fashion, the scheme he had planned more than twenty years before. So far as the treatise *De homine* (*L.W.* ii. 11-32) was concerned, the completion was more in name than in fact. It consisted for the most part of an elaborate theory of vision which, though very creditable to Hobbes's scientific insight, was out of place, or at least out of proportion, in a philosophical consideration of human nature generally. The remainder of the treatise, dealing cursorily with some of the topics more fully treated in the *Human Nature* and the *Leviathan*, has all the appearance of having been tagged in haste to the optical chapters (composed years before)³ as

¹ This translation, *Concerning Body*, though not made by Hobbes, was revised by him; but it is far from accurate, and not seldom, at critical places (e.g. c. vi. § 2), quite misleading. Philosophical citations from the *De corpore* should always be made in the original Latin. Molesworth reprints the Latin, not from the first edition of 1655, but from the modified edition of 1668—modified, in the mathematical chapters, in general (not exact) keeping with the English edition of 1656. The Vindex episode, referred to in the *Six Lessons*, becomes intelligible only by going beyond Molesworth to the original Latin edition of 1655.

² They were composed originally, in a somewhat different and rather more extended form, as the second part of an English treatise on Optics, completed by the year 1646. Of this treatise, preserved in Harleian MSS. 3360, Molesworth otherwise prints the dedication to the marquis of Newcastle, and the concluding paragraphs (*E.W.* vii. 467-471).

³ The *Vil. auct.* refers to 1676, a 'Letter to William duke of Newcastle on the Contradictory about Liberty and Necessity, held with Benjamin Laney, bishop of Ely.' In that year there did appear a (confused) little tract written by Laney against Hobbes's concluding statement of his own 'Opinion' in the 'Liberty and Necessity' of 1654 (1646), but I can find no trace of any further writing by Hobbes on the subject" (G. Croom Robertson, *Hobbes*, p. 202).

a makeshift for the proper transition required in the system from questions of Body Natural to questions of Body Politic. Hobbes had in fact spent himself in his earlier constructive efforts, and at the age of seventy, having nothing to add to his doctrine of Man as it was already in one form or another before the world, was content with anything that might stand for the fulfilment of his philosophical purpose. But he had still in him more than twenty years of vigorous vitality, and, not conscious to himself of any shortcoming, looked forward, now his hands were free, to doing battle for his doctrines. Rather than remain quiet, on finding no notice taken of his latest production, he would himself force on a new conflict with the enemy. Wallis having meanwhile published other works and especially a comprehensive treatise on the general principles of calculus (*Mathesis universalis*, 1657), he might take this occasion of exposing afresh the new-fangled methods of mathematical analysis and reasserting his own earlier positions. Accordingly, by the spring of 1660, he had managed to put his criticism and assertions into five dialogues under the title *Examinatio et emendatio mathematicae hodiernae quibus explicatur in libris Johannis Wallisii*, with a sixth dialogue so called, consisting almost entirely of seventy or more propositions on the circle and cycloid.¹ Wallis, however, would not take the bait. Hobbes then tried another tack. Next year, having solved, as he thought, another ancient *crux*, the duplication of the cube, he had his solution brought out anonymously at Paris in French, so as to put Wallis and other critics off the scent and extort a judgment that might be withheld from a work of his. The artifice was successful, and no sooner had Wallis publicly refuted the solution than Hobbes claimed the credit of it, and went more wonderfully than ever astray in its defence. He presently republished it (in modified form), with his remarks, at the end of a new Latin dialogue which he had meanwhile written in defence of another part of his philosophical doctrine. This was the *Dialogus physicus, sive De natura aëris* (*L.W.* iv. 233-296), fulminated in 1661 against Boyle and other friends of Wallis who, as he fancied, under the influence of that malevolent spirit, were now in London, after the Restoration, forming themselves into a society (incorporated as the Royal Society in 1662) for experimental research, to the exclusion of himself personally, and in direct contravention of the method of physical inquiry enjoined in the *De corpore*.² All the laborious manipulation recorded in Boyle's *New Experiments touching the Spring of the Air* (1660), which Hobbes chose, without the least warrant, to take as the manifesto of the new "academicians," seemed to him only to confirm the conclusions he had reasoned out years before from speculative principles, and he warned them that if they were not content to begin where he had left off their work would come to naught. To as much of this diatribe as concerned himself Boyle quickly replied with force and dignity, but it was from Hobbes's old enemy that retribution came, in the scathing satire *Hobbius heauton-timorumenos* (1662). Wallis, who had deftly steered his course amid all the political changes of the previous years, managing ever to be on the side of the ruling power, was now apparently stung to fury by a wanton allusion in Hobbes's latest dialogue to a passage of his former life (his deciphering for the parliament the king's papers taken at Naseby), whereof he had once boasted but after the Restoration could not speak or hear too little. The revenge he took was crushing. Professing to be roused by the attack on his friend Boyle, when he had scorned to lift a finger in defence of himself against the earlier dialogues, he tore them all to shreds with an art of which no general description can give an idea. He got, however, upon more dangerous ground when, passing wholly by the political insinuation against himself, he roundly charged Hobbes with having written *Leviathan* in support of Oliver's title, and deserted his royal master in distress. Hobbes seems to have been fairly bewildered by the rush and whirl of sarcasm with which Wallis drove him anew from every mathematical position he had ever taken up, and did not venture forth into the field of scientific controversy again for some years, when he had once followed up the physical dialogue of 1661 by seven shorter ones, with the inevitable appendix, entitled *Problemata physica, una cum magnitudine circuli* (*L.W.* iv. 297-384), in 1662.³

¹ *L.W.* iv. 1-232. The propositions on the circle, forty-six in number (shattered by Wallis in 1662), were omitted by Hobbes when he republished the *Dialogues* in 1668, in the collected edition of his Latin works from which Molesworth reprints. In the part omitted, at p. 154 of the original edition, Hobbes refers to his first introduction to Euclid, in a way that confirms the story in Aubrey quoted in an earlier paragraph.

² Remaining at Oxford, Wallis, in fact, took no active part in the constitution of the new society, but he had been, from 1645, one of the originators of an earlier association in London, thus continued or revived. This earlier society had been continued also at Oxford after the year 1649, when Wallis and others of its members received appointments there.

³ The *Problemata physica* was at the same time put into English (with some changes and omission of part of the mathematical appendix), and presented to the king, to whom the work was dedicated in a remarkable letter apologizing for *Leviathan*. In its English form, as *Seven Philosophical Problems and Two Propositions of Geometry* (*E.W.* vii. 1-68), the work was first published in 1682, after Hobbes's death.

But all the more eagerly did he take advantage of Wallis's loose calumny to strike where he felt himself safe. His answer to the personal charges took the form of a letter about himself in the third person addressed to Wallis in 1662, under the title of *Considerations upon the Reputation, Loyalty, Manners and Religion of Thomas Hobbes* (*E.W.* iv. 409-440). In this piece, which is of great biographical value, he told his own and Wallis's "little stories during the time of the late rebellion" with such effect that Wallis, like a wise man, attempted no further reply. Thus ended the second bout.

After a time Hobbes took heart again and began a third period of controversial activity, which did not end, on his side, till his ninetieth year. Little need be added to the simple catalogue of the untiring old man's labours in this last stage of his life. The first piece, published in 1666, *De principis et ratiocinatione geometricarum* (*L.W.* iv. 385-484), was designed, as the sub-title declared, to lower the pride of geometrical professors by showing that there was no less uncertainty and error in their works than in those of physical or ethical writers. Wallis replied shortly in the *Philosophical Transactions* (August 1666). Three years later he brought his three great achievements together in compendious form, *Quadratura circuli, Cubatio sphaerae, Duplicatio cubi*, and as soon as they were once more refuted by Wallis, reprinted them with an answer to the objections, in compliment to the grand-duke of Tuscany, who paid him attentions on a visit to England in 1669 (*L.W.* iv. 485-522). Wallis, who had promised to leave him alone henceforward, refuted him again before the year was out. In 1671 he worked up his propositions over again in *Rosetum geometricum* (*L.W.* v. 1-50), as a fragrant offering to the geometrical reader, appending a criticism (*Censura brevis*, pp. 50-88) on the first part of Wallis's treatise *De motu*, published in 1669; also he sent *Three Papers* to the Royal Society on selected points treated very briefly, and when Wallis, still not weary of confuting, shortly replied, published them separately with triumphant *Considerations on Dr Wallis's Answer to them* (*E.W.* vii. 429-448). Next year (1672), having now, as he believed, established himself with the Royal Society, he proceeded to complete the discomfiture of Wallis by a public address to the Society on all the points at issue between them from the beginning, *Lux Mathematica excussa collisionibus Johannis Wallisii et Thomae Hobbesii* (*L.W.* v. 89-150), the light, as the author R. R. (Roset Repertor) added, being here "increased by many very brilliant rays." Wallis replied in the *Transactions*, and then finally held his hands. Hobbes's energy was not yet exhausted. In 1674, at the age of eighty-six, he published his *Principia et problemata aliquot geometrica, ante desperata nunc breviter explicata et demonstrata* (*L.W.* v. 150-214), containing in the chapters dealing with questions of principle not a few striking observations, which ought not to be overlooked in the study of his philosophy. His last piece of all, *Decameron physiologicum* (*E.W.* vii. 69-180), in 1678, was a new set of dialogues on physical questions, most of which he had treated in a similar fashion before; but now, in dealing with gravitation, he was able to fire a parting shot at Wallis; and one more demonstration of the equality of a straight line to the arc of a circle, thrown in at the end, appropriately closed the strangest warfare in which perverse thinker ever engaged.⁴

We must now turn back to trace the fortunes of Hobbes and his other doings in the last twenty years of his life. All these controversial writings on mathematics and physics Later Years. represent but one half of his activity after the age of seventy; though, as regards the other half, it is not possible, for a reason that will be seen, to say as definitely in what order the works belonging to the period were produced. From the time of the Restoration he acquired a new prominence in the public eye. No year had passed since the appearance of *Leviathan* without some indignant protest against the influence which its trenchant doctrine was calculated to produce upon minds longing above everything for civil repose; but after the Restoration "Hobbesism" became a fashionable creed, which it was the duty of every lover of true morality and religion to denounce. Two or three days after Charles's arrival in London, Hobbes drew in the street the notice of his former pupil, and was at once received into favour. The young king, if he had ever himself resented the apparent disloyalty of the "Conclusion" of *Leviathan*, had not retained the feeling long, and could appreciate the principles of the great book when the application of them happened, as now, to be turned in his own favour. He had, besides, a relish for Hobbes's wit (as he used to say, "Here comes the bear to be baited"), and did not like the old man the less because his presence at court scandalized the bishops or the prim virtue of Chancellor Hyde. He even went the length of bestowing on Hobbes (but not always paying) a pension of £100, and had his portrait hung up in the royal ⁴ Wallis's pieces were excluded from the collected edition of his works (1693-1697), and have become extremely rare.

closet. These marks of favour, naturally, did not lessen Hobbes's self-esteem, and perhaps they explain, in his later writings, a certain slavishness toward the regal authority, which is wholly absent from his rational demonstration of absolutism in the earlier works. At all events Hobbes was satisfied with the rule of a king who had appreciated the author of *Leviathan*, and protected him when, after a time, protection in a very real sense became necessary. His eagerness to defend himself against Wallis's imputation of disloyalty, and his apologetic dedication of the *Problema physica* to the king, are evidence of the hostility with which he was being pressed as early as 1662; but it was not till 1666 that he felt himself seriously in danger. In that year the Great Fire of London, following on the Great Plague, roused the superstitious fears of the people, and the House of Commons embodied the general feeling in a bill against atheism and profaneness. On the 17th of October it was ordered that the committee to which the bill was referred "should be empowered to receive information touching such books as tend to atheism, blasphemy and profaneness, or against the essence and attributes of God, and in particular the book published in the name of one White,¹ and the book of Mr Hobbes called the *Leviathan*, and to report the matter with their opinion to the House." Hobbes, then verging upon eighty, was terrified at the prospect of being treated as a heretic, and proceeded to burn such of his papers as he thought might compromise him. At the same time he set himself, with a very characteristic determination, to inquire into the actual state of the law of heresy. The results of his investigation were first announced in three short Dialogues added (in place of the old "Review and Conclusion," for which the day had passed) as an Appendix to his Latin translation of *Leviathan* (*L.W.* iii.), included with the general collection of his works published at Amsterdam in 1668. In this appendix, as also in the posthumous tract, published in 1680, *An Historical Narration concerning Heresy and the Punishment thereof* (*E.W.* iv. 385-408), he aimed at showing that, since the High Court of Commission had been put down, there remained no court of heresy at all to which he was amenable, and that even when it stood nothing was to be declared heresy but what was at variance with the Nicene Creed, as he maintained the doctrine of *Leviathan* was not.

The only consequence that came of the parliamentary scare was that Hobbes could never afterwards get permission to print anything on subjects relating to human conduct. The collected edition of his Latin works (in two quarto volumes) appeared at Amsterdam in 1668, because he could not obtain the censor's licence for its publication at London, Oxford or Cambridge. Other writings which he had finished, or on which he must have been engaged about this time, were not made public till after his death—the king apparently having made it the price of his protection that no fresh provocation should be offered to the popular sentiment. The most important of the works composed towards 1670, and thus kept back, is the extremely spirited dialogue to which he gave the title *Behemoth: the History of the Causes of the Civil Wars of England and of the Counsels and Artifices by which they were carried on from the year 1640 to the year 1660.*² To the same period probably belongs the unfinished *Dialogue between a Philosopher and a Student of the Common Laws of England* (*E.W.* vi. 1-160), a trenchant criticism of the constitutional theory of English government as upheld by Coke. Aubrey takes credit for having tried to induce Hobbes to write upon the subject in 1664 by presenting him with a copy of Bacon's *Elements of the Laws of England*, and though the attempt was then unsuccessful, Hobbes later on took to studying the statute-book, with *Coke upon Littleton*. One other posthumous production also (besides the tract on Heresy before mentioned) may be referred to this, if not, as Aubrey suggests, an earlier time—the two thousand and odd elegiac verses in which he gave his

¹The *De medio animarum status* of Thomas White, a heterodox Catholic priest, who contested the natural immortality of the soul. White (who died 1676) and Hobbes were friends.

²*E.W.* vi. 161-418. Though *Behemoth* was kept back at the king's express desire, it saw the light, without Hobbes's leave, in 1679, before his death.

view of ecclesiastical encroachment on the civil power; the quaint verses, disposed in his now favourite dialogue-form, were first published, nine years after his death, under the title *Historia ecclesiastica* (*L.W.* v. 341-408), with a preface by Thomas Rymer.

For some time Hobbes was not even allowed to utter a word of protest, whatever might be the occasion that his enemies took to triumph over him. In 1669 an unworthy follower—Daniel Scargil by name, a fellow of Corpus Christi College, Cambridge—had to recant publicly and confess that his evil life had been the result of Hobbist doctrines. In 1674 John Fell, the dean of Christ Church, who bore the charges of the Latin translation of Anthony Wood's *History and Antiquities of the University of Oxford* (1670), struck out all the complimentary epithets in the account of his life, and substituted very different ones; but this time the king did suffer him to defend himself by publishing a dignified letter (*Vit. Auct.* pp. xlvi.-l.), to which Fell replied by adding to the translation when it appeared a note full of the grossest insults. And, amid all his troubles, Hobbes was not without his consolations. No Englishman of that day stood in the same repute abroad, and foreigners, noble or learned, who came to England, never forgot to pay their respects to the old man, whose vigour and freshness of intellect no progress of the years seemed able to quench. Among these was the grand-duke of Tuscany (Ferdinand II.), who took away some works and a portrait to adorn the Medicean library.

His pastimes in the latest years were as singular as his labours. The autobiography in Latin verse, with its playful humour, occasional pathos and sublime self-complacency, was thrown off at the age of eighty-four. At eighty-five, in the year 1673, he sent forth a translation of four books of the *Odyssey* (ix.-xii.) in rugged but not seldom happily turned English rhymes; and, when he found this *Voyage of Ulysses* eagerly received, he had ready by 1675 a complete translation of both *Iliad* and *Odyssey* (*E.W.* x.), prefaced by a lively dissertation "Concerning the Virtues of an Heroic Poem," showing his unabated interest in questions of literary style. After 1675, he passed his time at his patron's seats in Derbyshire, occupied to the last with intellectual work in the early morning and in the afternoon hours, which it had long been his habit to devote to thinking and to writing. Even as late as August 1679 he was promising his publisher "somewhat to print in English." The end came very soon afterwards. A suppression of urine in October, in spite of which he insisted upon being conveyed with the family from Chatsworth to Hardwick Hall towards the end of November, was followed by a paralytic stroke, under which he sank on the 4th of December, in his ninety-second year. He lies buried in the neighbouring church of Ault Hucknall.

He was tall and erect in figure, and lived on the whole a temperate life, though he used to say that he had been drunk about a hundred times. His favourite exercise was tennis, which he played regularly even after the age of seventy. Socially he was genial and courteous, though in argument he occasionally lost his temper. As a friend he was generous and loyal. Intellectually bold in the extreme, he was curiously timid in ordinary life, and is said to have had a horror of ghosts. He read little, and often boasted that he would have known as little as other men if he had read as much. He appears to have had an illegitimate daughter for whom he made generous provision. In the National Portrait Gallery there is a portrait of him by J. M. Wright, and two others are in the possession of the Royal Society.

As already suggested, it cannot be allowed that Hobbes falls into any regular succession from Bacon; neither can it be said that he handed on the torch to Locke. He was the one English thinker of the first rank in the long period of two generations separating Locke from Bacon, but, save in the chronological sense, there is no true relation of succession among the three. It would be difficult even to prove any ground of affinity among them beyond a desposition to take sense as a prime factor in the account of subjective experience: their common interest in physical science was shared

Personal character-
traits.

Place in
English
thought.

equally by rationalist thinkers of the Cartesian school, and was indeed begotten of the time. Backwards, Hobbes's relations are rather with Galileo and the other inquirers who, from the beginning of the 17th century, occupied themselves with the physical world in the manner that has come later to be distinguished by the name of science in opposition to philosophy. But even more than in external nature, Hobbes was interested in the phenomena of social life, presenting themselves so impressively in an age of political revolution. So it came to pass that, while he was unable, by reason of imperfect training and too tardy development, with all his pains, to make any contribution to physical science or to mathematics as instrumental in physical research, he attempted a task which no other adherent of the new "mechanical philosophy" conceived—nothing less than such a universal construction of human knowledge as would bring Society and Man (at once the matter and maker of Society) within the same principles of scientific explanation as were found applicable to the world of Nature. The construction was, of course, utterly premature, even supposing it were inherently possible; but it is Hobbes's distinction, in his century, to have conceived it, and he is thereby lifted from among the scientific workers with whom he associated to the rank of those philosophical thinkers who have sought to order the whole domain of human knowledge. The effects of his philosophical endeavour may be traced on a variety of lines. Upon every subject that came within the sweep of his system, except mathematics and physics, his thoughts have been productive of thought. When the first storm of opposition from smaller men had begun to die down, thinkers of real weight, beginning with Cumberland and Cudworth, were moved by their aversion to his analysis of the moral nature of man to probe anew the question of the natural springs and the rational grounds of human action; and thus it may be said that Hobbes gave the first impulse to the whole of that movement of ethical speculation that, in modern times, has been carried on with such remarkable continuity in England. In politics the revulsion from his particular conclusions did not prevent the more clear-sighted of his opponents from recognizing the force of his supreme demonstration of the practical irresponsibility of the sovereign power, wherever seated, in the state; and, when in a later age the foundations of a positive theory of legislation were laid in England, the school of Bentham—James Mill, Grote, Molesworth—brought again into general notice the writings of the great publicist of the 17th century, who, however he might, by the force of temperament, himself prefer the rule of one, based his whole political system upon a rational regard to the common weal. Finally, the psychology of Hobbes, though too undeveloped to guide the thoughts or even perhaps arrest the attention of Locke, when essaying the scientific analysis of knowledge, came in course of time (chiefly through James Mill) to be connected with the theory of associationism developed from within the school of Locke, in different ways, by Hartley and Hume; nor is it surprising that the later associationists, finding their principle more distinctly formulated in the earlier thinker, should sometimes have been betrayed into affiliating themselves to Hobbes rather than to Locke. For his ethical theories see ETHICS.

Sufficient information is given in the *Vitae Hobbianae auctarium* (L.W. i. p. lxx. ff.) concerning the frequent early editions of Hobbes's separate works, and also concerning the works of those who wrote against him, to the end of the 17th century. In the 18th century, after Clarke's *Boyle Lectures* of 1703-1705, the opposition was less express. In 1750 *The Moral and Political Works* were collected, with life, &c., by Dr Campbell, in a folio edition, including in order, *Human Nature, De corpore politico, Leviathan, Answer to Bramhall's Catching of the Leviathan, Narration concerning Heresy, Of Liberty and Necessity, Behemoth, Dialogue of the Common Laws, the Introduction to the Thucydides, Letter to Davenant and two others, the Preface to the Homer, De mirabilibus Pecci* (with English translation), *Considerations on the Reputation, &c.*, of T. H. In 1812 the *Human Nature and the Liberty and Necessity* (with supplementary extracts from the *Questions* of 1656) were reprinted in a small edition of 250 copies, with a meritorious memoir (based on Campbell) and dedication to Horne Tooke, by Philip Mallet. Molesworth's edition (1839-1845), dedicated to Grote, has been referred to in a former note. Of translations may be mentioned *Les Éléments philosophiques du citoyen* (1649) and *Le Corps politique* (1652), both by S. de Sorbière,

conjoined with *Le Traité de la nature humaine*, by d'Holbach, in 1787, under the general title *Les Œuvres philosophiques et politiques de Thomas Hobbes*; a translation of the first section, "Computatio sive logica," of the *De corpore*, included by Desautel de Tracy with his *Éléments d'idéologie* (1804), a translation of *Leviathan* into Dutch in 1678, and another (anonymous) into German—*Des Engländer Thomas Hobbes Leviathan oder der kirchliche und bürgerliche Staat* (Halle, 1794, 2 vols.); a translation of the *De cive* by J. H. v. Kirchmann—*T. Hobbes: Abhandlung über den Bürger, &c.* (Leipzig, 1873). Important later editions are those of Ferdinand Tönnies, *Behemoth* (1889), on which see Croom Robertson's *Philosophical Remains* (1894), p. 451; *Elements of Law* (1886).

Biographical and Critical Works.—There are three accounts of Hobbes's life, first published together in 1681, two years after his death, by R. B. (Richard Blackbourne, a friend of Hobbes's admirer, John Aubrey), and reprinted, with complimentary verses by Cowley and others, at the beginning of Sir W. Molesworth's collection of the *Latin Works*: (1) *T. H. Malmesb. vita* (pp. xiii-xxi.), written by Hobbes himself, or (as also reported) by T. Rymer, at his dictation; (2) *Vitae Hobbianae auctarium* (pp. xxii-lxxx.), turned into Latin from Aubrey's English; (3) *T. H. Malmesb. vita carmine expressa* (pp. lxxxi-cxc.), written by Hobbes at the age of eighty-four (first published by itself in 1680). *The Life of Mr T. H. of Malmesbury*, printed among the *Lives of Eminent Men*, in 1813, from Aubrey's papers in the Bodleian, &c. (vol. ii. pt. ii. pp. 593-637), contains some interesting particulars not found in the *Auctarium*. All that is of any importance for Hobbes's life is contained in G. Croom Robertson's *Hobbes* (1886) in Blackwood's *Philosophical Classics*, and Sir Leslie Stephen's *Hobbes* (1904) in the "English Men of Letters" series, both of which deal fully with his philosophy also. See also F. Tönnies, *Hobbes Leben und Lehre* (1896), *Hobbes-Analekten* (1904) foll.; G. Zart, *Einfluss der englischen Philosophie seit Bacon auf die deutsche Philosophie des 18ten Jahrh.* (Berlin, 1881); G. Brandt, *Thomas Hobbes: Grundlinien seiner Philosophie* (1895); G. Lyon, *La Philos. de Hobbes* (1893); J. M. Robertson, *Pioneer Humanists* (1907); J. Rickaby, *Free Will and Four English Philosophers* (1906), pp. 1-72; J. Watson, *Hedonistic Theories* (1895); W. Graham, *English Political Philosophy from Hobbes to Maine* (1899); W. J. H. Campion, *Outlines of Lectures on Political Science* (1895). (G. C. R.; X.)

HOBBY, a small horse, probably from early quotations, of Irish breed, trained to an easy gait so that riding was not fatiguing. The common use of the word is for a favourite pursuit or occupation, with the idea either of excessive devotion or of absence of ulterior motive or of profit, &c., outside the occupation itself. This use is probably not derived from the easy ambling gait of the Irish "hobby," but from the "hobby-horse," the mock horse of the old morris-dances, made of a painted wooden horse's head and tail, with a framework casing for an actor's body, his legs being covered by a cloth made to represent the "housings" of the medieval tilting-horse. A hobby or hobby-horse is thus a toy, a diversion. The O. Fr. *hobin*, or *hobi*, Mod. *aubin*, and Ital. *ubina* are probably adaptations of the English, according to the *New English Dictionary*. The O. Fr. *hober*, to move, which is often taken to be the origin of all these words, is the source of a use of "hobby" for a small kind of falcon, *falco subulato*, used in hawking.

HOBHOUSE, ARTHUR HOBHOUSE, 1ST BARON (1819-1904), English judge, fourth son of Henry Hobhouse, permanent under-secretary of state in the Home Office, was born at Hadspey, Somerset, on the 20th of November 1819. Educated at Eton and Balliol, he was called to the bar at Lincoln's Inn in 1845, and rapidly acquired a large practice as a conveyancer and equity draftsman; he became Q.C. in 1862, and practised in the Rolls Court, retiring in 1866. He was an active member of the charity commission and urged the appropriation of pious bequests to educational and other purposes. In 1872 he began a five years' term of service as legal member of the council of the governor-general of India, his services being acknowledged by a K.C.S.I.; and in 1881 he was appointed a member of the judicial committee of the privy council, on which he served for twenty years. He was made a peer in 1885, and consistently supported the Liberal party in the House of Lords. He died on the 6th of December 1904, leaving no heir to the barony.

His papers read before the Social Science Association on the subject of property were collected in 1880 under the title of *The Dead Hand*.

HOBOKEN, a small town of Belgium on the right bank of the Scheldt about 4 m. above Antwerp. It is only important on account of the ship-building yard which the Cockerill firm of Seraing has established at Hoboken. Many wealthy Antwerp

merchants have villas here, and it is the headquarters of several of the leading rowing clubs on the Scheldt. Pop. (1904) 12,816.

HOBOKEN, a city of Hudson county, New Jersey, U.S.A., on the Hudson river, adjoining Jersey City on the S. and W. and opposite New York city, with which it is connected by ferries and by two subway lines through tunnels under the river. Pop. (1890) 43,648; (1900) 59,364, of whom 21,380 were foreign-born, 10,843 being natives of Germany; (1910 census) 70,324. Of the total population in 1900, 48,349 had either one or both parents foreign-born, German being the principal racial element. The city is served by the West Shore, and the Delaware, Lackawanna & Western railways, being the eastern terminus of the latter, and is connected by electric railway with the neighbouring cities of north-eastern New Jersey. In Hoboken are the piers of the North German Lloyd, the Hamburg American, the Netherlands American, the Scandinavian and the Phoenix steamship lines. Hoboken occupies a little more than 1 sq. m. and lies near the foot of the New Jersey Palisades, which rise both on the W. and N. to a height of nearly 200 ft. Much of its surface has had to be filled in to raise it above high tide, but Castle Point, in the N.E., rises from the generally low level about 100 ft. On this Point are the residence and private estate of the founder of the city, John Stevens (1749-1838), Hudson Park, and facing it the Stevens Institute of Technology, an excellent school of mechanical engineering endowed by Edwin A. Stevens (1795-1868), son of John Stevens, opened in 1871, and having in 1909-1910 34 instructors and 300 students. The institute owes much to its first president, Henry Morton (1836-1902), a distinguished scientist, whose aim was "to offer a course of instruction in which theory and practice were carefully balanced and thoroughly combined," and who gave to the institute sums aggregating \$175,000 (see *Morton Memorial, History of Stevens Institute*, ed. by Furman, 1905). In connexion with the institute there is a preparatory department, the Stevens School (1870). The city maintains a teachers' training school. Among the city's prominent buildings are the Delaware, Lackawanna & Western station, the Hoboken Academy (1860), founded by German Americans, and the public library. The city has an extensive coal trade and numerous manufactures, among which are lead pencils, leather goods, silk goods, wall-paper and caskets. The value of the manufactured product increased from \$7,151,391 in 1890 to \$12,092,872 in 1900, or 69.1%. The factory product in 1905 was valued at \$14,077,305, an increase of 34.3% over that for 1900. The site of Hoboken (originally "Hobocan-hackingh," the place of the tobacco pipe) was occupied about 1640 as a Dutch farm, but in 1643 the stock and all the buildings except a brew-house were destroyed by the Indians. In 1711 title to the place was acquired by Samuel Bayard, a New York merchant, who built on Castle Point his summer residence. During the War of Independence his descendant, William Bayard, was a loyalist, and his home was burned and his estate confiscated. In 1784 the property was purchased by John Stevens, the inventor, who in 1804 laid it out as a town. For the next thirty-five years its "Elysian Fields" were a famous pleasure resort of New York City. Hoboken was incorporated as a town in 1849 and as a city in 1855. On the 30th of June 1900 the wharves of the North German Lloyd Steamship Company and three of its ocean liners were almost completely destroyed by a fire, which caused a loss of more than 300 lives and over \$5,000,000.

HOBSON'S CHOICE, i.e. "this or nothing," an expression that arose from the fact that the Cambridge-London carrier, Thomas Hobson (1544-1630), refused, when letting his horses on hire, to allow any animal to leave the stable out of its turn. Among other bequests made by Hobson, and commemorated by Milton, was a conduit for the Cambridge market-place, for which he provided the perpetual maintenance. See *Spectator*, No. 509 (14th of October 1712).

HOBY, SIR THOMAS (1530-1566), English diplomatist and translator, son of William Hoby of Leominster, was born in 1530. He entered St John's College, Cambridge, in 1545, but in 1547 he went to Strassburg, where he was the guest of Martin Bucer, whose *Gratulation . . . unto the Church of England for the*

restitution of Christes Religion he translated into English. He then proceeded to Italy, visiting Padua and Venice, Florence and Siena, and in May 1550 he had settled at Rome, when he was summoned by his half-brother, Sir Philip Hoby (1505-1558), then ambassador at the emperor's court, to Augsburg. The brothers returned to England at the end of the year, and Thomas attached himself to the service of the marquis of Northampton, whom he accompanied to France on an embassy to arrange a marriage between Edward VI. and the princess Elizabeth. Shortly after he returned to England he started once more for Paris, and in 1552 he was engaged on his translation of *The Courtier of Count Baldessar Castilio*. His work was probably completed in 1554, and the freedom of the allusions to the Roman church probably accounts for the fact that it was withheld from publication until 1561. The *Cortegiano* of Baldassare Castiglione, which Dr Johnson called "the best book that ever was written upon good breeding," is a book as entirely typical of the Italian Renaissance as Machiavelli's *Prince* in another direction. It exercised an immense influence on the standards of chivalry throughout Europe, and was long the recognized authority for the education of a nobleman. The accession of Mary made it desirable for the Hobys to remain abroad, and they were in Italy until the end of 1555. Thomas Hoby married in 1558 Elizabeth, the learned daughter of Sir Anthony Cook, who wrote a Latin epitaph on her husband. He was knighted in 1566 by Elizabeth, and was sent to France as English ambassador. He died on the 13th of July in the same year in Paris, and was buried in Bisham Church.

His son, SIR EDWARD HOBY (1560-1617), enjoyed Elizabeth's favour, and he was employed on various confidential missions. He was constable of Queenborough Castle, Kent, where he died on the 1st of March 1617. He took part in the religious controversies of the time, publishing many pamphlets against Theophilus Higgons and John Fludd or Floyd. He translated, from the French of Mathieu Coignet, *Politique Discourses on Truth and Lying* (1586).

The authority for Thomas Hoby's biography is a MS. "Booke of the Travaile and lief of me Thomas Hoby, with diverse things worth the noting." This was edited for the Royal Historical Society by Edgar Powell in 1902. Hoby's translation of *The Courtier* was edited (1900) by Professor Walter Raleigh for the "Tudor Translations" series.

HOCHÉ, LAZARE (1768-1797), French general, was born of poor parents near Versailles on the 24th of June 1768. At sixteen years of age he enlisted as a private soldier in the *Gardes françaises*. He spent his entire leisure in earning extra pay by civil work, his object being to provide himself with books, and this love of study, which was combined with a strong sense of duty and personal courage, soon led to his promotion. When the *Gardes françaises* were broken up in 1789 he was a corporal, and thereafter he served in various line regiments up to the time of his receiving a commission in 1792. In the defence of Thionville in that year Hoche earned further promotion, and he served with credit in the operations of 1792-1793 on the northern frontier of France. At the battle of Neerwinden he was aide-de-camp to General le Veneur, and when Dumouriez deserted to the Austrians, Hoche, along with le Veneur and others, fell under suspicion of treason; but after being kept under arrest and unemployed for some months he took part in the defence of Dunkirk, and in the same year (1793) he was promoted successively *chef de brigade*, general of brigade, and general of division. In October 1793 he was provisionally appointed to command the Army of the Moselle, and within a few weeks he was in the field at the head of his army in Lorraine. His first battle was that of Kaiserslautern (28th-30th of November) against Prussians. The French were defeated, but even in the midst of the Terror the Comité de Public Safety continued Hoche in his command. Pertinacity and fiery energy in their eyes outweighed everything else, and Hoche soon showed that he possessed these qualities. On the 22nd of December he stormed the lines of Fröschweiler, and the representatives of the Convention with his army at once added the Army of the Rhine to his sphere of command. On the 26th of December the French

carried by assault the famous lines of Weissenburg, and Hoche pursued his success, sweeping the enemy before him to the middle Rhine in four days. He then put his troops into winter quarters. Before the following campaign opened, he married Anne Adélaïde Dechaux at Thionville (March 11th, 1794). But ten days later he was suddenly arrested, charges of treason having been preferred by Pichegru, the displaced commander of the Army of the Rhine, and by his friends. Hoche escaped execution, however, though imprisoned in Paris until the fall of Robespierre. Shortly after his release he was appointed to command against the Vendéans (21st of August 1794). He completed the work of his predecessors in a few months by the peace of Jaunay (15th of February 1795), but soon afterwards the war was renewed by the Royalists. Hoche showed himself equal to the crisis and inflicted a crushing blow on the Royalist cause by defeating and capturing de Sombreuil's expedition at Quiberon and Penthièvre (16th–21st of July 1795). Thereafter, by means of mobile columns (which he kept under good discipline) he succeeded before the summer of 1796 in pacifying the whole of the west, which had for more than three years been the scene of a pitiless civil war. After this he was appointed to organize and command the troops destined for the invasion of Ireland, and he started on this enterprise in December 1796. A tempest, however, separated Hoche from the expedition, and after various adventures the whole fleet returned to Brest without having effected its purpose. Hoche was at once transferred to the Rhine frontier, where he defeated the Austrians at Neuwied (April), though operations were soon afterwards brought to an end by the Preliminaries of Leoben. Later in 1797 he was minister of war for a short period, but in this position he was surrounded by obscure political intrigues, and, finding himself the dupe of Barras and technically guilty of violating the constitution, he quickly laid down his office, returning to his command on the Rhine frontier. But his health grew rapidly worse, and he died at Wetzlar on the 19th of September 1797 of consumption. The belief was widely spread that he had been poisoned, but the suspicion seems to have been without foundation. He was buried by the side of his friend Marceau in a fort on the Rhine, amidst the mourning not only of his army but of all France.

See Privat, *Notions historiques sur la vie morale, politique et militaire du général Hoche* (Strassburg, 1798); Daunou, *Éloge du général Hoche* (1798), delivered on behalf of the Institut at Hoche's funeral; Rousselin, *Vie de Lazare Hoche, général des armées de la république française* (Paris, 1798; this work was printed at the public expense and distributed to the schools); Dubroca, *Éloge funèbre du général Hoche* (Paris, 1800); *Vie et pensées du général Hoche* (Bern); Champrobert, *Notice historique sur Lazare Hoche, le pacificateur de la Vendée* (Paris, 1840); Dourille, *Histoire de Lazare Hoche* (Paris, 1844); Desprez, *Lazare Hoche d'après sa correspondance* (Paris, 1858; new ed., 1880); Bergougnoux, *Essai sur la vie de Lazare Hoche* (1852); E. de Bonnechose, *Lazare Hoche* (1867); H. Martin, *Hoche et Bonaparte* (1875); Dutemple, *Vie politique et militaire du général Hoche* (1879); Escaude, *Hoche en Irlande* (1883); Cunéo d'Ornano, *Hoche* (1892); A. Chuquet, *Hoche et la lutte pour l'Alsace* (a volume of this author's series on the campaigns of the Revolution, 1893); E. Charavay, *Le Général Hoche* (1893); A. Duruy, *Hoche et Marceau* (1885).

HOCHHEIM, a town of Germany, in the Prussian province of Hesse-Nassau, situated on an elevation not far from the right bank of the Main, 3 m. above its influx into the Rhine and 3 m. E. of Mainz by the railway from Cassel to Frankfort-on-Main. Pop. (1905) 3779. It has an Evangelical and a Roman Catholic church, and carries on an extensive trade in wine, the English word "Hock," the generic term for Rhine wine, being derived from its name. Hochheim is mentioned in the chronicles as early as the 7th century. It is also memorable as the scene of a victory gained here, on the 7th of November 1813 by the Austrians over the French.

See Schüler, *Geschichte der Stadt Hochheim am Main* (Hochheim, 1888).

HÖCHST, a town of Germany, in the Prussian province of Hesse-Nassau on the Main, 6 m. by rail W. of Frankfort-on-Main. Pop. (1905) 14,121. It is a busy industrial town with large dye-works and manufactures of machinery, snuff, tobacco, waxcloth, gelatine, furniture and biscuits. Brewing is carried

on and there is a considerable river trade. The Roman Catholic church of St. Justinus is a fine basilica originally built in the 9th century; it has been restored several times, and a Gothic choir was added in the 15th century. The town has also an Evangelical church and a synagogue, and a statue of Bismarck by Alois Mayer. Höchst belonged formerly to the electors of Mainz who had a palace here; this was destroyed in 1634 with the exception of one fine tower which still remains. In 1622 Christian, duke of Brunswick, was defeated here by Count Tilly, and in 1795 the Austrians gained a victory here over the French.

Höchst is also the name of a small town in Hesse. This has some manufactures, and was formerly the seat of a Benedictine monastery.

HÖCHSTÄDT, a town of Bavaria, Germany, in the district of Swabia, on the left bank of the Danube, 34 m. N.E. of Ulm by rail. Pop. (1905) 2305. It has three Roman Catholic churches, a castle flanked by walls and towers and some small industries, including malting and brewing. Höchstädt, which came into the possession of Bavaria in 1266, has been a place of battles. Here Frederick of Hohenstaufen, viceroy of the Empire for Henry IV., was defeated by Henry's rival, Hermann of Luxembourg, in 1081; in 1703 the Imperialists were routed here by Marshal Villars in command of the French; in August 1704 Marlborough and Prince Eugene defeated the French and Bavarians commanded by Max Emanuel, the elector of Bavaria and Marshal Tallard, this battle being usually known as that of Blenheim; and in June 1800 an engagement took place here between the Austrians and the French.

There is another small town in Bavaria named Höchstädt. Pop. 2000. This is on the river Aisch, not far from Bamberg, to which bishopric it belonged from 1157 to 1802, when it was ceded to Bavaria.

HOCHSTETTER, FERDINAND CHRISTIAN VON, BARON (1820–1884), Austrian geologist, was born at Esslingen, Württemberg, on the 30th of April 1820. He was the son of Christian Ferdinand Hochstetter (1787–1860), a clergyman and professor at Brünn, who was also a botanist and mineralogist. Having received his early education at the evangelical seminary at Maulbronn, he proceeded to the university of Tübingen; there under F. A. Quenstedt the interest he already felt in geology became permanently fixed, and there he obtained his doctor's degree and a travelling scholarship. In 1852 he joined the staff of the Imperial Geological Survey of Austria and was engaged until 1856 in parts of Bohemia, especially in the Böhmerwald, and in the Fichtel and Karlsbad mountains. His excellent reports established his reputation. Thus he came to be chosen as geologist to the Novara expedition (1857–1859), and made numerous valuable observations in the voyage round the world. In 1859 he was engaged by the government of New Zealand to make a rapid geological survey of the islands. On his return he was appointed in 1860 professor of mineralogy and geology at the Imperial Polytechnic Institute in Vienna, and in 1876 he was made superintendent of the Imperial Natural History Museum. In these later years he explored portions of Turkey and eastern Russia, and he published papers on a variety of geological, palaeontological and mineralogical subjects. He died at Vienna on the 18th of July 1884.

PUBLICATIONS.—*Karlsbad, seine geognostischen Verhältnisse und seine Quellen* (1858); *New Zealand* (1863); *Geological and Topographical Atlas of New Zealand* (1864); *Leitfaden der Mineralogie und Geologie* (with A. Bischof) (1876, ed. 8, 1890).

HOCKEY (possibly derived from the "hooked" stick with which it is played; cf. O. Fr. *hoquet*, shepherd's crook), a game played with a ball or some similar object by two opposing sides, using hooked or bent sticks, with which each side attempts to drive it into the other's goal. In one or more of its variations Hockey was known to most northern peoples in both Europe and Asia, and the Romans possessed a game of similar nature. It was played indiscriminately on the frozen ground or the ice in winter. In Scotland it was called "shinty," and in Ireland "hurley," and was usually played on the hard, sandy sea-shore

with numerous players on each side. The rules were simple and the play very rough.

Modern Hockey, properly so called, is played during the cold season on the hard turf, and owes its recent vogue to the formation of "The Men's Hockey Association" in England in 1875. The rules drawn up by the Wimbledon Club in 1883 still obtain in all essentials. Since 1895 "international" matches at hockey have been played annually between England, Scotland, Ireland and Wales; and in 1907 a match was played between England and France, won by England by 14 goals to nil. In 1890 Divisional Association matches (North, South, West, Midlands) and inter-university matches (Oxford and Cambridge) were inaugurated, and have since been played annually. County matches are also now regularly played in England, twenty-six counties competing in 1907. Of other hockey clubs playing regular matches in 1907, there were eighty-one in the London district, and fifty-nine in the provinces.

The game is played by teams of eleven players on a ground 100 yds. long and 50 to 60 yds. wide. The goals are in the centre of each end-line, and consist of two uprights 7 ft. high surmounted by a horizontal bar, enclosing a space 12 ft. wide. In front of each goal is a space enclosed by a curved line, its greatest diameter from the goal-line being 15 ft., called the *striking-circle*. The positions of the players on each side may be seen on the accompanying diagram. Two umpires, one on each side of the centre-line, officiate.

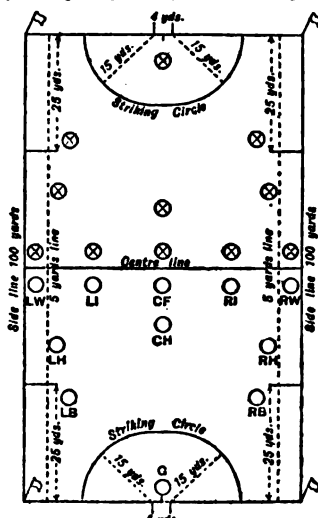

Diagram of Hockey Field.

- G. Goal.
- RB. Right Back.
- LB. Left Back.
- RH. Right Half.
- CH. Centre Half.
- LH. Left Half.
- RW. Right Wing.
- RI. Inside Right.
- CF. Centre Forward.
- LI. Inside Left.
- LW. Left Wing.

then endeavours, by means of striking, passing and dribbling, to drive the ball into its opponents' goal. A player is "off side" if he is nearer the enemy's goal than one of his own side who strikes the ball, and he may not strike the ball himself until it has been touched by one of the opposing side. The ball may be caught (but not held) or stopped by any part of the body, but may not be picked up, carried, kicked, thrown or knocked except with the stick. An opponent's stick may be hooked, but not an opponent's person, which may not be obstructed in any way. No left-handed play is allowed. Penalties for infringing rules are of two classes; "free hits" and "penalty bullies," to be taken where the foul occurred. For flagrant fouls penalty goals may also be awarded. A "corner" occurs when the ball goes behind the goal-line, but not into goal. If it is hit by the attacking side, or unintentionally by the defenders, it must be brought out 25 yds., in a direction at right angles to the goal-line from the point where it crossed the line, and there "bullied." But if the ball is driven from within the 25-yd. line unintentionally behind the goal-line by the defenders, a member of the attacking side is given a free hit from a point within 3 yds. of a corner flag, the members of the defending side remaining behind their goal-line. If the ball is hit intentionally behind the goal-line by the attacking side, the free hit is taken from the point where the ball went over. No goal can be scored from a free hit directly.

Ice Hockey (or *Bandy*, to give it its original name) is far more popular than ordinary Hockey in countries where there is much ice; in fact in America "Hockey" means Ice Hockey, while the land game is called Field Hockey. Ice Hockey in its simplest form of driving a ball across a given limit with a stick or club has been played for centuries in northern Europe, attaining its greatest popularity in the Low Countries, and there are many 16th- and 17th-century paintings extant which represent games of Bandy, the players using an implement formed much like a golf club.

In England Bandy is controlled by the "National Bandy Association." A team consists of eleven players, wearing skates, and the proper space for play is 200 yds. by 100 yds. in extent. The ball is of solid india-rubber, between 2½ and 3½ in. in diameter. The bandies are 2 in. in diameter and about 4 ft. long. The goals, placed in the centre of each goal-line, consist of two upright posts 7 ft. high and 12 ft. apart, connected by a lath. A match is begun by the referee throwing up the ball in the centre of the field, after which it must not be touched other than with the bandy until a goal is scored or the ball passes the boundaries of the course, in which case it is hit into the field in any direction excepting forward from the point where it went out by the player who touched it last. If the ball is hit across the goal-line but not into a goal, it is hit out by one of the defenders from the point where it went over, the opponents not being allowed to approach nearer than 25 yds. from the goal-line while the hit is made.

In America the development of the modern game is due to the Victoria Hockey Club and McGill University (Montreal). About 1881 the secretary of the former club made the first efforts towards drawing up a recognized code of laws, and for some time afterwards playing rules were agreed upon from time to time whenever an important match was played, the chief teams being, besides those already mentioned, the Ottawa, Quebec, Crystal and Montreal Hockey Clubs, the first general tournament taking place in 1884. Three years later the "Amateur Hockey Association of Canada" was formed, and a definite code of rules drawn up. Soon afterwards, in consequence of exhibitions given by the best Canadian teams in



Hockey Stick.

some of the larger cities of the United States, the new game was taken up by American schools, colleges and athletic clubs, and became nearly as popular in the northern states as in the Dominion. The rules differ widely from those of English Bandy. The rink must be at least 112 ft. long by 58 ft. wide, and seven players form a side. The goals are 6 ft. wide and 4 ft. high and are provided with goal-nets. Instead of the English painted cricket-ball a puck is used, made of vulcanized rubber in the form of a draught-stone, 1 in. thick, and 3 in. in diameter. The sticks are made of one piece of hard wood, and may not be more than 3 in. wide at any part. The game is played for two half-hour or twenty-minute periods with an intermission of ten minutes. At the beginning of a match, and also when a goal has been made, the puck is *faced*, i.e. it is placed in the middle of the rink between the sticks of the two centres, and the referee calls "play." Whichever side then secures the ball endeavours by means of passing and dribbling to get the puck into a position from which a goal may be *shot*. The puck may be stopped by any part of the person but not carried or knocked except with the stick. No stick may be raised above the shoulder except when actually striking the puck. When the puck is driven off the rink or behind the goal, or a foul has been made behind the goal, it is faced 5 yds. inside the rink. The goal-keeper must maintain a standing position.

There are a number of Hockey organizations in America, all under the jurisdiction of the "American Amateur Hockey League" in the United States and the "Canadian Amateur Athletic League" in Canada.

Ice Polo, a winter sport similar to Ice Hockey, is almost exclusively played in the New England states. A rubber-covered ball is used and the stick is heavier than that used in Ice Hockey. The radical difference between the two games is that, in Ice Polo, there is no strict off-side rule, so that passes and shots at goal may come from any and often the most unexpected direction. Five men constitute a team: a goal-tender, a half-back, a centre and two rushers. The rushers must be rapid skaters, adepts in dribbling and passing and good goal shots. The centre supports the rushers, passing the ball to them or trying for goal himself. The half-back is the first defence and the goal-tender the last. The rink is 150 ft. long.

Ring Hockey may be played on the floor of any gymnasium or large room by teams of six, comprising a goal-keeper, a quarter, three

forwards and a centre. The goals consist of two uprights 3 ft. high and 4 ft. apart. The ring, which takes the place of the ball or puck, is made of flexible rubber, and is 5 in. in diameter with a 3-in. opening through the centre. It weighs between 12 and 16 oz. The stick is a wand of light but tough wood, between 36 and 40 in. long, about $\frac{1}{2}$ in. in diameter, provided with a 5-in. guard 20 in. from the lower end. The method of shooting is to insert the end of the stick in the hole of the ring and drive it towards the goal. A goal shot from the field counts one point, a goal from a foul $\frac{1}{2}$ point. When a foul is called by the referee a player of the opposing side is allowed a free shot for goal from any point on the quarter line.

Roller Polo, played extensively during the winter months in the United States, is practically Ice Polo adapted to the floors of gymnasiums and halls, the players, five on a side, wearing roller-skates. The first professional league was organized in 1883.

HOCK-TIDE, an ancient general holiday in England, celebrated on the second Monday and Tuesday after Easter Sunday. Hock-Tuesday was an important term day, rents being then payable, for with Michaelmas it divided the rural year into its winter and summer halves. The derivation of the word is disputed: no analogy with Ger. *hoch*, "high," being generally denied. No trace of the word is found in Old English, and "hock-day," its earliest use in composition, appears first in the 12th century. The characteristic pastime of hock-tide was called binding. On Monday the women, on Tuesday the men, stopped all passers of the opposite sex and bound them with ropes till they bought their release with a small payment, or a rope was stretched across the highroads, and the passers were obliged to pay toll. The money thus collected seems to have gone towards parish expenses. Many entries are found in parish registers under "Hocktyde money." The hocktide celebration became obsolete in the beginning of the 18th century. At Coventry there was a play called "The Old Coventry Play of Hock Tuesday." This, suppressed at the Reformation owing to the incidental disorder, and revived as part of the festivities on Queen Elizabeth's visit to Kenilworth in July 1575, depicted the struggle between Saxons and Danes, and has given colour to the suggestion that hock-tide was originally a commemoration of the massacre of the Danes on St. Brice's Day, the 13th of November A.D. 1002, or of the rejoicings at the death of Hardicanute on the 8th of June 1042 and the expulsion of the Danes. But the dates of these anniversaries do not bear this out.

HOCUS, a shortened form of "hocus pocus," used in the 17th century in the sense of "to play a trick on any one," to "hoax," which is generally taken to be a derivative. "Hocus pocus" appears to have been a mock Latin expression first used as the name of a juggler or conjurer. Thus in Ady's *Candle in the Dark* (1655), quoted in the *New English Dictionary*, "I will speak of one man . . . that went about in King James his time . . . who called himself, The Kings Majesties most excellent Hocus Pocus, and so was called, because that at the playing of every Trick, he used to say, *Hocus pocus, lontus talontus, vade celeriter jubeo*, a dark composure of words, to blinde the eyes of the beholders, to make his Trick pass the more currantly without discovery." Tillotson's guess (*Sermons*, xxvi.) that the phrase was a corruption of *hoc est corpus* and alluded to the words of the Eucharist, "in ridiculous imitation of the priests of the Church of Rome in their trick of Transubstantiation" has frequently been accepted as a serious derivation, but has no foundation. A connexion with a supposed demon of Scandinavian mythology, called "Ochus Bochus," is equally unwarranted. "Hocus" is used as a verb, meaning to drug, stupefy with opium, &c., for a criminal purpose. This use dates from the beginning of the 19th century.

HODDEN (a word of unknown origin), a coarse kind of cloth made of undyed wool, formerly much worn by the peasantry of Scotland. It was usually made on small hand-looms by the peasants themselves. Grey hodden was made by mixing black and white fleeces together in the proportion of one to twelve when weaving.

HODDESDON, an urban district in the Hertford parliamentary division of Hertfordshire, England, near the river Lea, 17 m. N. from London by the Great Eastern railway (Broxbourne and Hoddesdon station on the Cambridge line). Pop. (1901), 4711. This is the northernmost of a series of populous townships

extending from the suburbs of London along the Lea valley as far as its junction with the Stort, which is close to Hoddesdon. They are in the main residential. Hoddesdon was a famous coaching station on the Old North Road; and the Bull posting-house is mentioned in Matthew Prior's "Down Hall." The Lea has been a favourite resort of anglers (mainly for coarse fish in this part) from the time of Izaak Walton, in whose book Hoddesdon is specifically named. The church of St Augustine, Broxbourne, is a fine example of Perpendicular work, and contains interesting monuments, including an altar tomb with enamelled brasses of 1473. Hoddesdon probably covers the site of a Romano-British village.

HOVEDA (*Hodida, Hadeto*), a town in Arabia situated on the Red Sea coast 14° 48' N. and 42° 57' E. It lies on a beach of muddy sand exposed to the southerly and westerly winds. Steamers anchor more than a mile from shore, and merchandize has to be transhipped by means of *sambuks* or native boats. But Hoveda has become the chief centre of the maritime trade of Turkish Yemen, and has superseded Mokha as the great port of export of South Arabian coffee. The town is composed of stone-built houses of several storeys, and is surrounded, except on the sea face, by a fortified enceinte. The population is estimated at 33,000, and contains, besides the Arab inhabitants and the Turkish officials and garrison, a considerable foreign element, Greeks, Indians and African traders from the opposite coast. There are consulates of Great Britain, United States, France, Germany, Italy and Greece. The steam tonnage entering and clearing the port in 1904 amounted to 78,700 tons, the highest hitherto recorded. Regular services are maintained with Aden, and with Suez, Massowa and the other Red Sea ports. Large *dhow*s bring dates from the Persian Gulf, and occasional steamers from Bombay call on their way to Jidda with cargoes of grain. The imports for 1904 amounted in value to £467,000, the chief items being piece goods, food grains and sugar; the exports amounted to £457,000, including coffee valued at £229,000.

HODENING, an ancient Christmas custom still surviving in Wales, Kent, Lancashire and elsewhere. A horse's skull or a wooden imitation on a pole is carried round by a party of youths, one of whom conceals himself under a white cloth to simulate the horse's body, holding a lighted candle in the skull. They make a house-to-house visitation, begging gratuities. The "Penitential" of Archbishop Theodore (d. 690) speaks of "any who, on the kalands of January, clothe themselves with the skins of cattle and carry heads of animals." This, coupled with the fact that among the primitive Scandinavians the horse was often the sacrifice made at the winter solstice to Odin for success in battle, has been thought to justify the theory that hodenning is a corruption of Odining.

HODGE, CHARLES (1797-1878), American theologian, was born in Philadelphia, Pennsylvania, on the 28th of December 1797. He graduated at the College of New Jersey (now Princeton) in 1815, and in 1819 at the Princeton Theological seminary, where he became an instructor in 1820, and the first professor of Oriental and Biblical literature in 1822. Meanwhile, in 1821, he had been ordained as a Presbyterian minister. From 1826 to 1828 he studied under de Sacy in Paris, under Gesenius and Tholuck in Halle, and under Hengstenberg, Neander and Humboldt in Berlin. In 1840 he was transferred to the chair of exegetical and didactic theology, to which subjects that of polemic theology was added in 1854, and this office he held until his death. In 1825 he established the quarterly *Biblical Repository*, the title of which was changed to *Biblical Repository and Theological Review* in 1830 and to *Biblical Repository and Princeton Review* in 1837. With it, in 1840, was merged the *Literary and Theological Review* of New York, and in 1872 the *American Presbyterian Review* of New York, the title becoming *Presbyterian Quarterly and Princeton Review* in 1872 and *Princeton Review* in 1877. He secured for it the position of theological organ of the Old School division of the Presbyterian church, and continued its principal editor and contributor until 1868, when the Rev. Lyman H. Atwater became his colleague. His more important essays were republished under the titles *Essays and Reviews*

(1857), *Princeton Theological Essays, and Discussions in Church Polity* (1878). He was moderator of the General Assembly (O.S.) in 1846, a member of the committee to revise the *Book of Discipline* of the Presbyterian church in 1858, and president of the Presbyterian Board of Foreign Missions in 1868-1870. The 24th of April 1872, the fiftieth anniversary of his election to his professorship, was observed in Princeton as his jubilee by between 400 and 500 representatives of his 2700 pupils, and \$50,000 was raised for the endowment of his chair. He died at Princeton on the 19th of June 1878. Hodge was one of the greatest of American theologians.

Besides his articles in the *Princeton Review*, he published a *Commentary on the Epistle to the Romans* (1835, abridged 1836, rewritten and enlarged 1864, new ed. 1886), *Constitutional History of the Presbyterian Church in the United States* (2 vols., 1839-1842); *The Way of Life* (1843); *Commentaries on Ephesians* (1856); *1 Corinthians* (1857); *2 Corinthians* (1859); *Systematic Theology* (3 vols., 2200 pp., 1871-1873), probably the best of all modern expositions of Calvinistic dogmatic; and *What is Darwinism?* (1874), in which he opposed "Atheistic Evolutionism." After his death a volume of *Conference Papers* (1879) was published. His life, by his son, was published in 1880.

His son, ARCHIBALD ALEXANDER HODGE (1823-1886), also famous as a Presbyterian theologian, was born at Princeton on the 18th of July 1823. He graduated at the College of New Jersey in 1841, and at the Princeton Theological seminary in 1846, and was ordained in 1847. From 1847 to 1850 he was a missionary at Allahabad, India, and was then pastor of churches successively at Lower West Nottingham, Maryland (1851-1855); at Fredericksburg, Virginia (1855-1861), and at Wilkes-Barré, Pennsylvania (1861-1864). From 1864 to 1877 he was professor of didactic and polemical theology in the Allegheny Theological seminary at Allegheny, Pennsylvania, where he was also from 1866 to 1877 pastor of the North Church (Presbyterian). In 1878 he succeeded his father as professor of didactic theology at the Princeton seminary. He died on the 11th of November 1886. Besides writing the biography of his father, he was the author of *Outlines of Theology* (1860, new ed. 1875; enlarged, 1879); *The Atonement* (1867); *Exposition of the Confession of Faith* (1869); and *Popular Lectures on Theological Themes* (1887). See C. A. Salmond's *Charles and A. A. Hodge* (New York, 1888).

HODGKIN, THOMAS (1831-), British historian, son of John Hodgkin (1800-1875), barrister, was born in London on the 20th of July 1831. Having been educated as a member of the Society of Friends and taken the degree of B.A. at London University, he became a partner in the banking house of Hodgkin, Barnett & Co., Newcastle-on-Tyne, a firm afterwards amalgamated with Lloyds' Bank. While continuing in business as a banker, Hodgkin devoted a good deal of time to historical study, and soon became a leading authority on the history of the early middle ages, his books being indispensable to all students of this period. His chief works are, *Italy and her Invaders* (8 vols., Oxford, 1880-1899); *The Dynasty of Theodosius* (Oxford, 1889); *Theodoric the Goth* (London, 1891); and an introduction to the *Letters of Cassiodorus* (London, 1886). He also wrote a *Life of Charles the Great* (London, 1897); *Life of George Fox* (Boston, 1896); and the opening volume of Longman's *Political History of England* (London, 1906).

HODGKINSON, EATON (1789-1861), English engineer, the son of a farmer, was born at Anderton near Northwich, Cheshire, on the 26th of February 1789. After attending school at Northwich, he began to help his widowed mother on the farm, but to escape from that uncongenial occupation he persuaded her in 1811 to remove to Manchester and start a pawnbroking business. There he made the acquaintance of John Dalton, and began those inquiries into the strength of materials which formed the work of his life. He was associated with Sir William Fairbairn in an important series of experiments on cast iron, and his help was sought by Robert Stephenson in regard to the forms and dimensions of the tubes for the Britannia bridge. A paper which he communicated to the Royal Society on "Experimental Researches on the Strength of Pillars of Cast Iron and other Materials," in 1840 gained him a Royal medal in 1841, and he was also elected a fellow. In 1847 he was appointed professor of the mechanical

principles of engineering in University College, London, and at the same time he was employed as a member of the Royal Commission appointed to inquire into the application of iron to railway structures. In 1848 he was chosen president of the Manchester Philosophical Society, of which he had been a member since 1826, and to which, both previously and subsequently, he contributed many of the more important results of his discoveries. For several years he took an active part in the discussions of the Institution of Civil Engineers, of which he was elected an honorary member in 1851. He died at Eaglesfield House, near Manchester, on the 18th of June 1861.

HODGSON, BRIAN HOUGHTON (1800-1894), English administrator, ethnologist and naturalist, was born at Lower Beech, Prestbury, Cheshire, on the 1st of February 1800. His father, Brian Hodgson, came of a family of country gentlemen, and his mother was a daughter of William Houghton of Manchester. In 1816 he obtained an East Indian writership. After passing through the usual course at Haileybury, he went out to India in 1818, and after a brief service at Kumon as assistant-commissioner was in 1820 appointed assistant to the Resident at Katmandu, the capital of Nepal. In 1823 he obtained an under-secretaryship in the foreign department at Calcutta, but his health failed, and in 1824 he returned to Nepal, to which the whole of his life, whether in or out of India, may be said to have been thenceforth given. He devoted himself particularly to the collection of Sanskrit MSS. relating to Buddhism, and hardly less so to the natural history and antiquities of the country, and by 1839 had contributed eighty-nine papers to the *Transactions of the Asiatic Society of Bengal*. His investigations of the ethnology of the aboriginal tribes were especially important. In 1833 he became Resident in Nepal, and passed many stormy years in conflict with the cruel and faithless court to which he was accredited. He succeeded, nevertheless, in concluding a satisfactory treaty in 1839; but in 1842 his policy, which involved an imperious attitude towards the native government, was upset by the interference of Lord Ellenborough, but just arrived in India and not unnaturally anxious to avoid trouble in Nepal during the conflict in Afghanistan. Hodgson took upon himself to disobey his instructions, a breach of discipline justified to his own mind by his superior knowledge of the situation, but which the governor-general could hardly be expected to overlook. He was, nevertheless, continued in office for a time, but was recalled in 1843, and resigned the service. In 1845 he returned to India and settled at Darjeeling, where he devoted himself entirely to his favourite pursuits, becoming the greatest authority on the Buddhist religion and on the flora of the Himalayas. It was he who early suggested the recruiting of Gurkhas for the Indian army, and who influenced Sir Jung Bahadur to lend his assistance to the British during the mutiny in 1857. In 1858 he returned to England, and lived successively in Cheshire and Gloucestershire, occupied with his studies to the last. He died at his seat at Alderley Grange in the Cotswold Hills on the 23rd of May 1894. No man has done so much to throw light on Buddhism as it exists in Nepal, and his collections of Sanskrit manuscripts, presented to the East India Office, and of natural history, presented to the British Museum, are unique as gatherings from a single country. He wrote altogether 184 philological and ethnological and 127 scientific papers, as well as some valuable pamphlets on native education, in which he took great interest. His principal work, *Illustrations of the Literature and Religion of Buddhists* (1841), was republished with the most important of his other writings in 1872-1880.

His life was written by Sir W. W. Hunter in 1896.

HÓDMEZÖ-VÁSÁRHELY, a town of Hungary, in the county of Csongrád, 135 m. S.E. of Budapest by rail. Pop. (1900) 60,824, of which about two-thirds are Protestants. The town, situated on Lake Hód, not far from the right bank of the Tisza, has a modern aspect. The soil of the surrounding country, of which 383 sq. m. belong to the municipality, is exceedingly fertile, the chief products being wheat, mangcorn, barley, oats, millet, maize and various descriptions of fruit, especially melons. Extensive vineyards, yielding large quantities of both white and

red grapes, skirt the town, and the horned cattle and horses of Hódmező-Vásárhely have a good reputation; sheep and pigs are also extensively reared. The commune is protected from inundations of the Tisza by an enormous dike, but the town, nevertheless, sometimes suffers considerable damage during the spring floods.

HODOGRAPH (Gr. *ὁδός*, a way, and *γράφω*, to write), a curve of which the radius vector is proportional to the velocity of a moving particle. It appears to have been used by James Bradley, but for its practical development we are mainly indebted to Sir William Rowan Hamilton, who published an account of it in the *Proceedings of the Royal Irish Academy*, 1846. If a point be in motion in any orbit and with any velocity, and if, at each instant, a line be drawn from a fixed point parallel and equal to the velocity of the moving point at that instant, the extremities of these lines will lie on a curve called the hodograph. Let PP_1P_2 be the path of the moving point, and let OT, OT_1, OT_2 be drawn

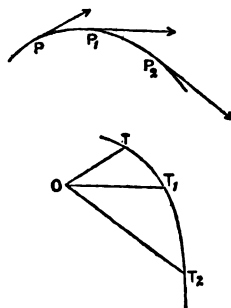

from the fixed point O parallel and equal to the velocities at P, P_1 , P_2 respectively, then the locus of T is the hodograph of the orbits described by P (see figure). From this definition we have the following important fundamental property which belongs to all hodographs, viz. that at any point the tangent to the hodograph is parallel to the direction, and the velocity in the hodograph equal to the magnitude of the resultant acceleration at the corresponding point of the orbit. This will be evident if we consider that, since radii vectors of the

hodograph represent velocities in the orbit, the elementary arc between two consecutive radii vectors of the hodograph represents the velocity which must be compounded with the velocity of the moving point at the beginning of any short interval of time to get the velocity at the end of that interval, that is to say, represents the change of velocity for that interval. Hence the elementary arc divided by the element of time is the rate of change of velocity of the moving-point, or in other words, the velocity in the hodograph is the acceleration in the orbit.

Analytically thus (Thomson and Tait, *Nat. Phil.*):—Let x, y, z be the coordinates of P in the orbit, ξ, η, ζ those of the corresponding point T in the hodograph, then

$$\xi = \frac{dx}{dt}, \eta = \frac{dy}{dt}, \zeta = \frac{dz}{dt};$$

therefore

$$\frac{d\xi}{ds} = \frac{d^2x}{dt^2} = \frac{d^2y}{dt^2} = \frac{d^2z}{dt^2} \dots \dots \dots (1).$$

Also, if s be the arc of the hodograph,

$$\frac{ds}{dt} = v = \sqrt{\left(\frac{dx}{dt}\right)^2 + \left(\frac{dy}{dt}\right)^2 + \left(\frac{dz}{dt}\right)^2} \\ = \sqrt{\left(\frac{d^2x}{dt^2}\right)^2 + \left(\frac{d^2y}{dt^2}\right)^2 + \left(\frac{d^2z}{dt^2}\right)^2} \dots \dots (2).$$

Equation (1) shows that the tangent to the hodograph is parallel to the line of resultant acceleration, and (2) that the velocity in the hodograph is equal to the acceleration.

Every orbit must clearly have a hodograph, and, conversely, every hodograph a corresponding orbit; and, theoretically speaking, it is possible to deduce the one from the other, having given the other circumstances of the motion.

For applications of the hodograph to the solution of kinematical problems see MECHANICS.

HODSON, WILLIAM STEPHEN RAIKES (1821-1858), known as "Hodson of Hodson's Horse," British leader of light cavalry during the Indian Mutiny, third son of the Rev. George Hodson, afterwards archdeacon of Stafford and canon of Lichfield, was born on the 19th of March 1821 at Maise more Court, near Gloucester. He was educated at Rugby and Cambridge, and

accepted a cadetship in the Indian army at the advanced age for those days of twenty-three. Joining the 2nd Bengal Grenadiers he went through the first Sikh War, and was present at the battles of Moodkee, Ferozeshah and Sohraon. In one of his letters home at this period he calls the campaign a "tissue of mismanagement, blunders, errors, ignorance and arrogance," and outspoken criticism such as this brought him many bitter enemies throughout his career, who made the most of undeniable faults of character. In 1847, through the influence of Sir Henry Lawrence, he was appointed adjutant of the corps of Guides, and in 1852 was promoted to the command of the Guides with the civil charge of Yusafzai. But his brusque and haughty demeanour to his equals made him many enemies. In 1855 two separate charges were brought against him. The first was that he had arbitrarily imprisoned a Pathan chief named Khadar Khan, on suspicion of being concerned in the murder of Colonel Mackeson. The man was acquitted, and Lord Dalhousie removed Hodson from his civil functions and remanded him to his regiment on account of his lack of judgment. The second charge was more serious, amounting to an accusation of malversation in the funds of his regiment. He was tried by a court of inquiry, who found that his conduct to natives had been "unjustifiable and oppressive," that he had used abusive language to his native officers and personal violence to his men, and that his system of accounts was "calculated to screen peculation and fraud." Subsequently another inquiry was carried out by Major Reynell Taylor, which dealt simply with Hodson's accounts and found them to be "an honest and correct record . . . irregularly kept." At this time the Guides were split up into numerous detachments, and there was a system of advances which made the accounts very complicated. The verdicts of the two inquiries may be set against each other, and this particular charge declared "not proven." It is possible that Hodson was careless and extravagant in money matters rather than actually dishonest; but there were several similar charges against him. During a tour through Kashmir with Sir Henry Lawrence he kept the purse and Sir Henry could never obtain an account from him, subsequently Sir George Lawrence accused him of embezzling the funds of the Lawrence Asylum at Kasauli; while Sir Neville Chamberlain in a published letter says of the third brother, Lord Lawrence, "I am bound to say that Lord Lawrence had no opinion of Hodson's integrity in money matters. He has often discussed Hodson's character in talking to me, and it was to him a regret that a man possessing so many fine gifts should have been wanting in a moral quality which made him untrustworthy." Finally, on one occasion Hodson spent £500 of the pay due to Lieutenant Godby, and under threat of exposure was obliged to borrow the money from a native banker through one of his officers named Bisharat Ali.

It was just at the time when Hodson's career seemed ruined that the Indian Mutiny broke out, and he obtained the opportunity of rehabilitating himself. At the very outset of the campaign he made his name by riding with despatches from General Anson at Karnal to Meerut and back again, a distance of 152 m. in all, in seventy-two hours, through a country swarming with the rebel cavalry. This feat so pleased the commander-in-chief that he empowered him to raise a regiment of 2000 irregular horse, which became known to fame as Hodson's Horse, and placed him at the head of the Intelligence Department. In his double rôle of cavalry leader and intelligence officer, Hodson played a large part in the reduction of Delhi and consequently in saving India for the British empire. He was the finest swordsman in the army, and possessed that daring recklessness which is the most useful quality of leadership against Asiatics. In explanation of the fact that he never received the Victoria Cross it was said of him that it was because he earned it every day of his life. But he also had the defects of his qualities, and could display on occasion a certain cruelty and callousness of disposition. Reference has already been made to Bisharat Ali, who had lent Hodson money. During the siege of Delhi another native, said to be an enemy of Bisharat Ali's, informed Hodson that he had turned rebel

and had just reached Khurkhouda, a village near Delhi. Hodson thereupon took out a body of his sows, attacked the village, and shot Bisharat Ali and several of his relatives. General Crawford Chamberlain states that this was Hodson's way of wiping out the debt. Again, after the fall of Delhi, Hodson obtained from General Wilson permission to ride out with fifty horsemen to Humayun's tomb, 6 m. out of Delhi, and bring in Bahadur Shah, the last of the Moguls. This he did with safety in the face of a large and threatening crowd, and thus dealt the mutineers a heavy blow. On the following day with 100 horsemen he went out to the same tomb and obtained the unconditional surrender of the three princes, who had been left behind on the previous occasion. A crowd of 6000 persons gathered, and Hodson with marvellous coolness ordered them to disarm, which they proceeded to do. He sent the princes on with an escort of ten men, while with the remaining ninety he collected the arms of the crowd. On galloping after the princes he found the crowd once more pressing on the escort and threatening an attack; and fearing that he would be unable to bring his prisoners into Delhi he shot them with his own hand. This is the most bitterly criticized action in his career, but no one but the man on the spot can judge how it is necessary to handle a crowd; and in addition one of the princes, Abu Bukht, heir-apparent to the throne, had made himself notorious for cutting off the arms and legs of English children and pouring the blood into their mothers' mouths. Considering the circumstances of the moment, Hodson's act at the worst was one of irregular justice. A more unpleasant side to the question is that he gave the king a safe conduct, which was afterwards seen by Sir Donald Stewart, before he left the palace, and presumably for a bribe; and he took an armet and rings from the bodies of the princes. He was freely accused of looting at the time, and though this charge, like that of peculation, is matter for controversy, it is very strongly supported. General Pelham Burn said that he saw loot in Hodson's boxes when he accompanied him from Fatehgarh to take part in the siege of Lucknow, and Sir Henry Daly said that he found "loads of loot" in Hodson's boxes after his death, and also a file of documents relating to the Guides case, which had been stolen from him and of which Hodson denied all knowledge. On the other hand the Rev. G. Hodson states in his book that he obtained the inventory of his brother's possessions made by the Committee of Adjustment and it contained no articles of loot, and Sir Charles Gough, president of the committee, confirmed this evidence. This statement is totally incompatible with Sir Henry Daly's and is only one of many contradictions in the case. Sir Henry Norman stated that to his personal knowledge Hodson remitted several thousand pounds to Calcutta which could only have been obtained by looting. On the other hand, again, Hodson died a poor man, his effects were sold for £170, his widow was dependent on charity for her passage home, was given apartments by the queen at Hampton Court, and left only £400 at her death.

Hodson was killed on the 11th of March 1858 in the attack on the Begum Kotee at Lucknow. He had just arrived on the spot and met a man going to fetch powder to blow in a door; instead Hodson, with his usual recklessness, rushed into the doorway and was shot. On the whole, it can hardly be doubted that he was somewhat unscrupulous in his private character, but he was a splendid soldier, and rendered inestimable services to the empire.

The controversy relating to Hodson's moral character is very complicated and unpleasant. Upon Hodson's side see Rev. G. Hodson, *Hodson of Hodson's Horse* (1883), and L. J. Trotter, *A Leader of Light Horse* (1901); against him, R. Bosworth Smith, *Life of Lord Lawrence*, appendix to the 6th edition of 1885; T. R. E. Holmes, *History of the Indian Mutiny*, appendix N to the 5th edition of 1898, and *Four Famous Soldiers* by the same author, 1889; and General Sir Crawford Chamberlain, *Remarks on Captain Trotter's Biography of Major W. S. R. Hodson* (1901).

HODY, HUMPHREY (1650-1707), English divine, was born at Odcombe in Somersetshire in 1650. In 1676 he entered Wadham College, Oxford, of which he became fellow in 1685.

In 1684 he published *Contra historiam Aristee de LXX. interpretibus dissertatio*, in which he showed that the so-called letter of Aristee, containing an account of the production of the Septuagint, was the late forgery of a Hellenist Jew originally circulated to lend authority to that version. The dissertation was generally regarded as conclusive, although Isaac Vossius published an angry and scurrilous reply to it in the appendix to his edition of Pomponius Mela. In 1689 Hody wrote the *Prolegomena* to the Greek chronicle of John Malalas, published at Oxford in 1691. The following year he became chaplain to Edward Stillingfleet, bishop of Worcester, and for his support of the ruling party in a controversy with Henry Dodwell regarding the non-juring bishops he was appointed chaplain to Archbishop Tillotson, an office which he continued to hold under Tenison. In 1698 he was appointed regius professor of Greek at Oxford, and in 1704 was made archdeacon of Oxford. In 1701 he published *A History of English Councils and Convocations*, and in 1703 in four volumes *De Bibliorum textis originalibus*, in which he included a revision of his work on the Septuagint, and published a reply to Vossius. He died on the 20th of January 1707.

A work, *De Græcis Illustribus*, which he left in manuscript, was published in 1742 by Samuel Jebb, who prefixed to it a Latin life of the author.

HOE, RICHARD MARCH (1812-1886), American inventor, was born in New York City on the 12th of September 1812. He was the son of Robert Hoe (1784-1833), an English-born American mechanic, who with his brothers-in-law, Peter and Matthew Smith, established in New York City a manufactory of printing presses, and used steam to run his machinery. Richard entered his father's manufactory at the age of fifteen and became head of the firm (Robert Hoe & Company) on his father's death. He had considerable inventive genius and set himself to secure greater speed for printing presses. He discarded the old flat-bed model and placed the type on a revolving cylinder, a model later developed into the well-known Hoe rotary or "lightning" press, patented in 1846, and further improved under the name of the Hoe web perfecting press (see PRINTING). He died in Florence, Italy, on the 7th of June 1886.

See *A Short History of the Printing Press* (New York, 1902) by his nephew Robert Hoe (1839-1909), who was responsible for further improvements in printing, and was an indefatigable worker in support of the New York Metropolitan Museum.

HOE (through Fr. *hose* from O.H.G. *housen*, mod. Ger. *Haus*; the root is seen in "hew," to cut, cleave; the word must be distinguished from "hoe," promontory, tongue of land, seen in place names, e.g. Morthoe, Luton Hoo, the Hoe at Plymouth, &c.; this is the same as Northern English "heugh" and is connected with "hang"), an agricultural and gardening implement used for extirpating weeds, for stirring the surface-soil in order to break the capillary channels and so prevent the evaporation of moisture, for singling out turnips and other root-crops and similar purposes. Among common forms of hoe are the ordinary

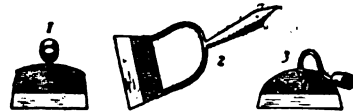

FIG. 1.—Three Forms of Manual Hoe.

garden-hoe (numbered 1 in fig. 1), which consists of a flat blade set transversely in a long wooden handle; the Dutch or trust-hoe (2), which has the blade set into the handle after the fashion of a spade; and the swan-neck hoe (3), the best manual hoe for agricultural purposes, which has a long curved neck to attach the blade to the handle; the soil falls back over this, blocking it and thus avoided a longer stroke obtained. Several types of horse-drawn hoe capable of working one or more rows at a time are used among root and grain crops. The illustrations show two forms of the implement, the blades of which differ in shape from those of the garden-hoe. Fig. 2 is in ordinary use for hoeing between two lines of beans or turnips or other "roots." Fig. 3

is adapted for the narrow rows of grain crops and is also convertible into a root-hoe. In the lever-hoe, which is largely used in grain crops, the blades may be raised and lowered by means



FIG. 2.—Martin's One-Row Horse Hoe.

of a lever. The horse-drawn hoe is steered by means of handles in the rear, but its successful working depends on accurate drilling of the seed, because unless the rows are parallel the roots of the plants are liable to be cut and the foliage injured. Thus Jethro Tull (17th century), with whose name the beginning of

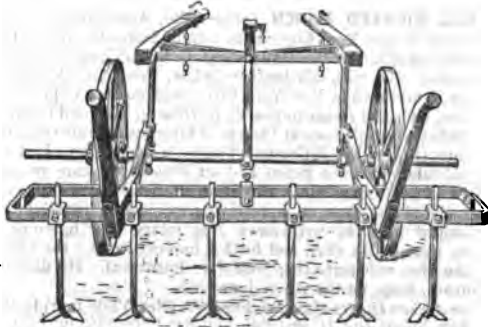

FIG. 3.—Martin's General Purpose Steerage Horse Hoe.

the practice of horse-hoeing is principally connected, used the drill which he invented as an essential adjunct in the so-called "Horse-hoeing Husbandry" (see AGRICULTURE).

HOEFNAGEL, JORIS (1545-1601), Dutch painter and engraver, the son of a diamond merchant, was born at Antwerp. He travelled abroad, making drawings from archaeological subjects, and was a pupil of Jan Bol at Mechlin. He was afterwards patronized by the elector of Bavaria at Munich, where he stayed eight years, and by the Emperor Rudolph at Prague. He died at Vienna in 1601. He is famous for his miniature work, especially on a missal in the imperial library at Vienna; he painted animals and plants to illustrate works on natural history; and his engravings (especially for Braun's *Civitates orbis terrarum*, 1572, and Ortelius's *Theatrum orbis terrarum*, 1570) give him an interesting place among early topographical draughtsmen.

HOF, a town of Germany, in the Bavarian province of Upper Franconia, beautifully situated on the Saale, on the north-eastern spurs of the Fichtelgebirge, 103 m. S.W. of Leipzig on the main line of railway to Regensburg and Munich. Pop. (1885) 22,257; (1905) 36,348. It has one Roman Catholic and three Protestant churches (among the latter that of St Michael, which was restored in 1884), a town hall of 1563, a gymnasium with an extensive library, a commercial school and a hospital founded in 1262. It is the seat of various flourishing industries, notably woollen, cotton and jute spinning, jute weaving, and the manufacture of cotton and half-woollen fabrics. It has also dye-works, flour-mills, saw-mills, breweries, iron-works, and manufactures of machinery, iron and tin wares, chemicals and sugar. In the neighbourhood there are large

marble quarries and extensive iron mines. Hof, originally called Regnitzhof, was built about 1080. It was held for some time by the dukes of Meran, and was sold in 1373 to the burgraves of Nuremberg. The cloth manufacture introduced into it in the 15th century, and the manufacture of veils begun in the 16th century, greatly promoted its prosperity, but it suffered severely in the Albertine and Hussite wars as well as in the Thirty Years' War. In 1792 it came into the possession of Prussia; in 1806 it fell to France; and in 1810 it was incorporated with Bavaria. In 1823 the greater part of the town was destroyed by fire.

See Ernst, *Geschichte und Beschreibung des Bezirks und der Stadt Hof* (1866); Tillmann, *Die Stadt Hof und ihre Umgebung* (Hof, 1899), and C. Meyer, *Quellen zur Geschichte der Stadt Hof* (1894-1896).

HOFER, ANDREAS (1767-1810), Tirolese patriot, was born on the 22nd of November 1767 at St Leonhard, in the Passeier valley. There his father kept an inn known as "am Sand," which Hofer inherited, and on that account he was popularly known as the "Sandwirth." In addition to this he carried on a trade in wine and horses with the north of Italy, acquiring a high reputation for intelligence and honesty. In the wars against the French from 1796 to 1805 he took part, first as a sharp-shooter and afterwards as a captain of militia. By the treaty of Pressburg (1805) Tirol was transferred from Austria to Bavaria, and Hofer, who was almost fanatically devoted to the Austrian house, became conspicuous as a leader of the agitation against Bavarian rule. In 1808 he formed one of a deputation who went to Vienna, at the invitation of the archduke John, to concert a rising; and when in April 1809 the Tirolese rose in arms, Hofer was chosen commander of the contingent from his native valley, and inflicted an overwhelming defeat on the Bavarians at Sterzing (April 11). This victory, which resulted in the temporary reoccupation of Innsbruck by the Austrians, made Hofer the most conspicuous of the insurgent leaders. The rapid advance of Napoleon, indeed, and the defeat of the main Austrian army under the archduke Charles, once more exposed Tirol to the French and Bavarians, who reoccupied Innsbruck. The withdrawal of the bulk of the troops, however, gave the Tirolese their chance again; after two battles fought on the Iselberg (May 25 and 29) the Bavarians were again forced to evacuate the country, and Hofer entered Innsbruck in triumph. An autograph letter of the emperor Francis (May 29) assured him that no peace would be concluded by which Tirol would again be separated from the Austrian monarchy, and Hofer, believing his work accomplished, returned to his home. Then came the news of the armistice of Znaim (July 12), by which Tirol and Vorarlberg were surrendered by Austria unconditionally and given up to the vengeance of the French. The country was now again invaded by 40,000 French and Bavarian troops, and Innsbruck fell; but the Tirolese once more organized resistance to the French "atheists and freemasons," and, after a temporary hesitation, Hofer—on whose head a price had been placed—threw himself into the movement. On the 15th of August, in another battle on the Iselberg, the French under Marshal Lefebvre were routed by the Tirolese peasants, and Hofer once more entered Innsbruck, which he had some difficulty in saving from sack. Hofer was now elected *Oberkommandant* of Tirol, took up his quarters in the Hofburg at Innsbruck, and for two months ruled the country in the emperor's name. He preserved the habits of a simple peasant, and his administration was characterized in part by the peasant's shrewd common sense, but yet more by a pious solicitude for the minutest details of faith and morals. On the 29th of September Hofer received from the emperor a chain and medal of honour, which encouraged him in the belief that Austria did not intend again to desert him; the news of the conclusion of the treaty of Schönbrunn (October 14), by which Tirol was again ceded to Bavaria, came upon him as an overwhelming surprise. The French in overpowering force at once pushed into the country, and, an amnesty having been stipulated in the treaty, Hofer and his companions, after some hesitation, gave in their submission. On the 12th of November, however,

urged on by the hotter heads among the peasant leaders and deceived by false reports of Austrian victories, Hofer again issued a proclamation calling the mountaineers to arms. The summons met with little response, the enemy advanced in irresistible force, and Hofer, a price once more set on his head, had to take refuge in the mountains. His hiding-place was betrayed by one of his neighbours, named Josef Raffl, and on the 27th of January 1810 he was captured by Italian troops and sent in chains to Mantua. There he was tried by court-martial, and on the 20th of February was shot, twenty-four hours after his condemnation. This crime, which was believed to be due to Napoleon's direct orders, caused an immense sensation throughout Germany and did much to inflame popular sentiment against the French. At the court of Austria, too, which was accused of having cynically sacrificed the hero, it produced a painful impression, and Metternich, when he visited Paris on the occasion of the marriage of the archduchess Marie Louise to Napoleon, was charged to remonstrate with the emperor. Napoleon expressed his regret, stating that the execution had been carried out against his wishes, having been hurried on by the zeal of his generals. In 1823 Hofer's remains were removed from Mantua to Innsbruck, where they were interred in the Franciscan church, and in 1834 a marble statue was erected over his tomb. In 1893 a bronze statue of him was also set up on the Iselberg. At Meran his patriotic deeds of heroism are the subject of a festival play celebrated annually in the open air. In 1818 the patent of nobility bestowed upon him by the Austrian emperor in 1809 was conferred upon his family.

See *Leben und Thaten des ehemaligen Tyroler Insurgenten-Chefs And. Hofer* (Berlin, 1810); *And. Hofer und die Tyroler Insurrection im Jahr 1809* (Munich, 1811); Hormayr, *Geschichte And. Hofer's Sandwirts als Passeyer* (Leipzig, 1845); B. Weber, *Das Thal Passeyer und seine Bewohner mit besonderer Rücksicht auf Andreas Hofer und das Jahr 1809* (Innsbruck, 1851); Rapp, *Tirol im Jahr 1809* (Innsbruck, 1852); Weidinger, *Andreas Hofer und seine Kampfgenossen* (3rd ed., Leipzig, 1861); Heigel, *Andreas Hofer* (Munich, 1874); *Stampler, Sandwirt Andreas Hofer* (Freiburg, 1874); Schmolze, *Andreas Hofer und seine Kampfgenossen* (Innsbruck, 1900). His history has supplied the materials for tragedies to B. Auerbach and Immermann, and for numerous ballads, of which some remain very popular in Germany (see Franke, *Andreas Hofer im Liede*, Innsbruck, 1884).

HÖFFDING, HARALD (1843-), Danish philosopher, was born and educated in Copenhagen. He became a schoolmaster, and ultimately in 1883 professor in the university of Copenhagen. He was much influenced by Soren Kierkegaard in the early development of his thought, but later became a positivist, retaining, however, and combining with it the spirit and method of practical psychology and the critical school. His best-known work is perhaps his *Den nyere Filosofis Historie* (1894), translated into English from the German edition (1895) by B. E. Meyer as *History of Modern Philosophy* (2 vols., 1900), a work intended by him to supplement and correct that of Hans Bröchner, to whom it is dedicated. His *Psychology, the Problems of Philosophy* (1905) and *Philosophy of Religion* (1906) also have appeared in English.

Among Höffding's other writings, practically all of which have been translated into German, are: *Den engelske Filosofi i vor Tid* (1873); *Ethik* (1876, ed. 1879); *Psychologi i Omrids paa Grundlag af Erfaring* (ed. 1892); *Psychologiske Undersøgelser* (1889); *Charles Darwin* (1889); *Konkvisiteten i Kant's filosofiske Udviklingsgang* (1893); *Det psykologiske Grundlag for logiske Domme* (1899); *Roussseau og seine Philosophie* (1901); *Mindre Arbejder* (1899).

HOFFMANN, AUGUST HEINRICH (1798-1874), known as **HOFFMANN VON FALLERSLEBEN**, German poet, philologist and historian of literature, was born at Fallersleben in the duchy of Lüneburg, Hanover, on the 2nd of April 1798, the son of the mayor of the town. He was educated at the classical schools of Helmstedt and Brunswick, and afterwards at the universities of Göttingen and Bonn. His original intention was to study theology, but he soon devoted himself entirely to literature. In 1823 he was appointed custodian of the university library at Breslau, a post which he held till 1838. He was also made extraordinary professor of the German language and literature at that university in 1830, and ordinary professor in 1835,

but he was deprived of his chair in 1842 in consequence of his *Unpolitische Lieder* (1840-1841), which gave much offence to the authorities in Prussia. He then travelled in Germany, Switzerland and Italy, and lived for two or three years in Mecklenburg, of which he became a naturalized citizen. After the revolution of 1848 he was enabled to return to Prussia, where he was restored to his rights, and received the *Wartegeld*—the salary attached to a promised office not yet vacant. He married in 1849, and during the next ten years lived first in Bingerbrück, afterwards in Neuwied, and then in Weimar, where together with Oskar Schade (1826-1906) he edited the *Weimarsche Jahrbuch* (1854-1857). In 1860 he was appointed librarian to the Duke of Ratibor at the monasterial castle of Corvey near Hoxter on the Weser, where he died on the 19th of January 1874. Fallersleben was one of the best popular poets of modern Germany. In politics he ardently sympathized with the progressive tendencies of his time, and he was among the earliest and most effective of the political poets who prepared the way for the outbreak of 1848. As a poet, however, he acquired distinction chiefly by the ease, simplicity and grace with which he gave expression to the passions and aspirations of daily life. Although he had not been scientifically trained in music, he composed melodies for many of his songs, and a considerable number of them are sung by all classes in every part of Germany. Among the best known is the patriotic *Deutschland, Deutschland über Alles*, composed in 1841 on the island of Heligoland, where a monument was erected in 1891 to his memory (subsequently destroyed).

The best of his poetical writings is his *Gedichte* (1827; 9th ed., Berlin, 1887); but there is great merit also in his *Alemannische Lieder* (1826, 5th ed., 1843), *Soldatenlieder* (1831), *Soldatenleben* (1852), *Rheinleben* (1865), and in his *Fünfzig Kinderlieder, Fünfzig neue Kinderlieder, and Alte und neue Kinderlieder*. His *Unpolitische Lieder, Deutsche Lieder aus der Schweiz und Streifflüchter* are not without poetical value, but they are mainly interesting in relation to the movements of the age in which they were written. As a student of ancient Teutonic literature Hoffmann von Fallersleben ranks among the most persevering and cultivated of German scholars, some of the chief results of his labours being embodied in his *Horae Belgicae, Fundgruben für Geschichte deutscher Sprache und Literatur, Altsächsische Blätter, Spenden zur deutschen Literaturgeschichte und Findlinge*. Among his editions of particular works may be named *Reynke Vos, Monumenta Elnonensia and Theophilus—Die deutsche Philologie im Grundriss* (1836) at the time of its publication a valuable contribution to philological research, and historians of German literature still attach importance to his *Geschichte des deutschen Kirchlides bis auf Luther* (1832; 3rd ed., 1861), *Unsere volkstümlichen Lieder* (3rd ed., 1860) and *Die deutschen Gesellschaftslieder des 10 und 17 Jahrh.* (2nd ed., 1860). In 1868-1870 Hoffmann published in 6 vols an autobiography, *Mein Leben: Aufzeichnungen und Erinnerungen* (an abbreviated ed. in 2 vols., 1894). His *Gesammelte Werke* were edited by H. Gerstenberg in 8 vols. (1891-1894); his *Ausgewählte Werke* by H. Benzmann (1905, 4 vols.). See also *Briefe von Hoffmann von Fallersleben und Moritz Haupt am Ferdinand Wolf* (1874); J. M. Wagner, *Hoffmann von Fallersleben, 1818-1868* (1869-1870); and R. von Gottschall, *Portraits und Studien* (vol. v., 1876).

HOFFMANN, ERNST THEODOR WILHELM (1776-1822), German romance-writer, was born at Königsberg on the 24th of January 1776. For the name Wilhelm he himself substituted Amadeus in homage to Mozart. His parents lived unhappily together, and when the child was only three they separated. His bringing up was left to an uncle who had neither understanding nor sympathy for his dreamy and wayward temperament. Hoffmann showed more talent for music and drawing than for books. In 1792, when little over sixteen years old, he entered the university of Königsberg, with a view to preparing himself for a legal career. The chief features of interest in his student years were an intimate friendship for Theodor Gottlieb von Hippel (1775-1843), a nephew of the novelist Hippel, and an unhappy passion for a lady to whom he gave music lessons; the latter found its outlet, not merely in music, but also in two novels, neither of which he was able to have published. In the summer of 1795 he began his practical career as a jurist in Königsberg, but his mother's death and the complications in which his love-affair threatened to involve him made him decide to leave his native town and continue his legal apprenticeship

in Glogau. In the autumn of 1798 he was transferred to Berlin, where the beginnings of the new Romantic movement were in the air. Music, however, had still the first place in his heart, and the Berlin opera house was the chief centre of his interests.

In 1800 further promotion brought him to Posen, where he gave himself up entirely to the pleasures of the hour. Unfortunately, however, his brilliant powers of caricature brought him into ill odour, and instead of receiving the hoped-for preferment in Posen itself, he found himself virtually banished to the little town of Plozk on the Vistula. Before leaving Posen he married, and his domestic happiness alleviated to some extent the monotony of the two years' exile. His leisure was spent in literary studies and musical composition. In 1804 he was transferred to Warsaw, where, through J. E. Hitzig (1780-1849), he was introduced to Zacharias Werner, and began to take an interest in the later Romantic literature; now, for the first time, he discovered how writers like Novalis, Tieck, and especially Wackenroder, had spoken out of his own heart. But in spite of this literary stimulus, his leisure in Warsaw was mainly occupied by composition; he wrote music to Brentano's *Lustige Musikanten* and Werner's *Kreuz an der Ostsee*, and also an opera *Liebe und Eifersucht*, based on Calderon's drama *La Bonda y la Flor*.

The arrival of the French in Warsaw and the consequent political changes put an end to Hoffmann's congenial life there, and a time of tribulation followed. A position which he obtained in 1808 as musical director of a new theatre in Bamberg availed him little, as within a very short time the theatre was bankrupt and Hoffmann again reduced to destitution. But these misfortunes induced him to turn to literature in order to eke out the miserable livelihood he earned by composing and giving music lessons. The editor of the *Allgemeine musikalische Zeitung* expressed his willingness to accept contributions from Hoffmann, and here appeared for the first time some of the musical sketches which ultimately passed over into the *Phantasiestücke in Callots Manier*. This work appeared in four volumes in 1814 and laid the foundation of his fame as a writer. Meanwhile, Hoffmann had again been for some time attached, in the capacity of musical director, to a theatrical company, whose headquarters were at Dresden. In 1814 he gladly embraced the opportunity that was offered him of resuming his legal profession in Berlin, and two years later he was appointed councillor of the Court of Appeal (*Kammergericht*). Hoffmann had the reputation of being an excellent jurist and a conscientious official, he had leisure for literary pursuits and was on the best of terms with the circle of Romantic poets and novelists who gathered round Fouqué, Chamisso and his old friend Hitzig. Unfortunately, however, the habits of intemperance which, in earlier years, had thrown a shadow over his life, grew upon him, and his health was speedily undermined by the nights he spent in the wine-house, in company unworthy of him. He was struck down by locomotor ataxy, and died on the 24th of July 1822.

The *Phantasiestücke*, which had been published with a commendatory preface by Jean Paul, were followed in 1816 by the gruesome novel—to some extent inspired by Lewis's *Monk*—*Die Elixiers des Teufels*, and the even more gruesome and grotesque stories which make up the *Nachstücke* (1817, 2 vols.). The full range of Hoffmann's powers is first clearly displayed in the collection of stories (4 vols., 1810-1821) *Die Serapiensbrüder*, this being the name of a small club of Hoffmann's more intimate literary friends. *Die Serapiensbrüder* includes not merely stories in which Hoffmann's love for the mysterious and the supernatural is to be seen, but novels in which he draws on his own early reminiscences (*Rat Krespel*, *Fermate*), finely outlined pictures of old German life (*Der Artushof*, *Meister Martin der Kupfer und seine Gesellen*), and vivid and picturesque incidents from Italian and French history (*Doge und Dogressa*, the story of Marino Faliero, and *Das Fraulein von Scuderi*). The last-mentioned story is usually regarded as Hoffmann's masterpiece. Two longer works also belong to Hoffmann's later years and display to advantage his powers as a humorist, these are *Klein Zaches, genannt Zinnober* (1819), and *Lebens-*

ansichten des Katers Murr, nebst fragmentarischer Biographie des Kapellmeisters Johannes Kreisler (1821-1822).

Hoffmann is one of the master novelists of the Romantic movement in Germany. He combined with a humour that reminds us of Jean Paul the warm sympathy for the artist's standpoint towards life, which was enunciated by early Romantic leaders like Tieck and Wackenroder; but he was superior to all in the almost clairvoyant powers of his imagination. His works abound in grotesque and gruesome scenes—in this respect they mark a descent from the high ideals of the Romantic school; but the gruesome was only one outlet for Hoffmann's genius, and even here the secret of his power lay not in his choice of subjects, but in the wonderfully vivid and realistic presentation of them. Every line he wrote leaves the impression behind it that it expresses something felt or experienced; every scene, vision or character he described seems to have been real and living to him. It is this realism, in the best sense of the word, that made him the great artist he was, and gave him so extraordinary a power over his contemporaries.

The first collected edition of Hoffmann's works appeared in ten volumes (*Ausgewählte Schriften*, 1827-1828); to these his widow added five volumes in 1839 (including the 3rd edition of J. E. Hitzig's *Aus Hoffmanns Leben und Nachlass*, 1823). Other editions of his works appeared in 1844-1845, 1871-1873, 1879-1883, and, most complete of all, *Sämtliche Werke*, edited by E. Griebach, in 15 vols. (1900). There are many editions of selections, as well as cheap reprints of the more popular stories. All Hoffmann's important works—except *Klein Zaches* and *Kater Murr*—have been translated into English: *The Devil's Elixir* (1821), *The Golden Pot* by Carlyle (in *German Romances*, 1827), *The Serapiensbrüder* by A. Estlin (1886-1892), &c. In France Hoffmann was even more popular than in England. Cf. G. Thureau, *Hoffmanns Erzählungen in Frankreich* (1896). An edition of his *Œuvres complètes* appeared in 12 vols. in Paris in 1830. The best monograph on Hoffmann is by G. Ellinger, *E. T. A. Hoffmann* (1894); see also O. Klinke, *Hoffmanns Leben und Werke vom Standpunkte eines Ironiarstes* (1903); and the exhaustive bibliography in Goedeke's *Grundriss zur Geschichte der deutschen Dichtung*, 2nd ed., vol. viii, pp. 468 ff. (1905). (J. G. R.)

HOFFMANN, FRANÇOIS BENOÎT (1760-1828), French dramatist and critic, was born at Nancy on the 11th of July 1760. He studied law at the university of Strassburg, but a slight hesitation in his speech precluded success at the bar, and he entered a regiment on service in Corsica. He served, however, for a very short time, and, returning to Nancy, he wrote some poems which brought him into notice at the little court of Lunéville over which the marquis de Boufflers then presided. In 1784 he went to Paris, and two years later produced the opera *Phèdre*. His opera *Adrien* (1792) was objected to by the government on political grounds, and Hoffmann, who refused to make the changes proposed to him, ran considerable risk under the revolutionary government. His later operas, which were numerous, were produced at the Opéra Comique. In 1807 he was invited by Etienne to contribute to the *Journal de l'Empire* (afterwards the *Journal des débats*). Hoffmann's wide reading qualified him to write on all sorts of subjects, and he turned, apparently with no difficulty, from reviewing books on medicine to violent attacks on the Jesuits. His severe criticism of Chateaubriand's *Martyrs* led the author to make some changes in a later edition. He had the reputation of being an absolutely conscientious and incorruptible critic and thus exercised wide influence. Hoffmann died in Paris on the 25th of April 1828. Among his numerous plays should be mentioned an excellent one-act comedy, *Le Roman d'une heure* (1803), and an amusing one-act opera *Les Rendez-vous bourgeois*.

See Sainte-Beuve, "M. de Feletz et la critique littéraire sous l'Empire" in *Causeries de lundis*, vol. i.

HOFFMANN, FRIEDRICH (1600-1742), German physician, a member of a family that had been connected with medicine for 200 years before him, was born at Halle on the 19th of February 1600. At the gymnasium of his native town he acquired that taste for and skill in mathematics to which he attributed much of his after success. At the age of eighteen he went to study medicine at Jena, whence in 1680 he passed to Erfurt, in order to attend Kasper Cramer's lectures on chemistry. Next year, returning to Jena, he received his doctor's diploma, and, after publishing a thesis, was permitted to

teach. Constant study then began to tell on his health, and in 1682, leaving his already numerous pupils, he proceeded to Minden in Westphalia to recruit himself, at the request of a relative who held a high position in that town. After practising at Minden for two years, Hoffmann made a journey to Holland and England, where he formed the acquaintance of many illustrious chemists and physicians. Towards the end of 1684 he returned to Minden, and during the next three years he received many flattering appointments. In 1688 he removed to the more promising sphere of Halberstadt, with the title of physician to the principality of Halberstadt; and on the founding of Halle university in 1693, his reputation, which had been steadily increasing, procured for him the primarius chair of medicine, while at the same time he was charged with the responsible duty of framing the statutes for the new medical faculty. He filled also the chair of natural philosophy. With the exception of four years (1708-1712), which he passed at Berlin in the capacity of royal physician, Hoffmann spent the rest of his life at Halle in instruction, practice and study, interrupted now and again by visits to different courts of Germany, where his services procured him honours and rewards. His fame became European. He was enrolled a member of many learned societies in different foreign countries, while in his own he became privy councillor. He died at Halle on the 12th of November 1742.

Of his numerous writings a catalogue is to be found in Haller's *Bibliotheca medicinae practicae*. The chief is *Medicina rationalis systematica*, undertaken at the age of sixty, and published in 1730. It was translated into French in 1739, under the title of *Médecine raisonnée d'Hoffmann*. A complete edition of Hoffmann's works, with a life of the author, was published at Geneva in 1740, to which supplements were added in 1753 and 1760. Editions appeared also at Venice in 1745 and at Naples in 1753 and 1793. (See also MEDICINE.)

HOFFMANN, JOHANN JOSEPH (1805-1878), German scholar, was born at Würzburg on the 16th of February 1805. After studying at Würzburg he went on the stage in 1825; but owing to an accidental meeting with the German traveller, Dr Philipp Franz von Siebold (1796-1866), in July 1830, his interest was diverted to Oriental philology. From Siebold he acquired the rudiments of Japanese, and in order to take advantage of the instructions of Ko-ching-chang, a Chinese teacher whom Siebold had brought home with him, he made himself acquainted with Malay, the only language except Chinese which the Chinaman could understand. In a few years he was able to supply the translations for Siebold's *Nippon*; and the high character of his work soon attracted the attention of older scholars. Stanislas Julien invited him to Paris; and he would probably have accepted the invitation, as a disagreement had broken out between him and Siebold, had not M. Baud, the Dutch colonial minister, appointed him Japanese translator with a salary of 1800 florins (£150). The Dutch authorities were slow in giving him further recognition; and he was too modest a man successfully to urge his claims. It was not till after he had received the offer of the professorship of Chinese in King's College, London, that the authorities made him professor at Leiden and the king allowed him a yearly pension. In 1875 he was decorated with the order of the Netherlands Lion, and in 1877 he was elected corresponding member of the Berlin Academy. He died at the Hague on the 23rd of January 1878.

Hoffmann's chief work was his unfinished Japanese Dictionary, begun in 1839 and afterwards continued by L. Serrurier. Unable at first to procure the necessary type, he set himself to the cutting of punches, and even when the proper founts were obtained he had to act as his own compositor as far as Chinese and Japanese were concerned. His Japanese grammar (*Japanische Sprechlehre*) was published in Dutch and English in 1867, and in English and German in 1876. Of his miscellaneous productions it is enough to mention "Japans Bezüge mit der koraischen Halbinsel und mit Schina" in *Nippon*, vii.; *Yo-San-fi-Rok. L'Art d'élever les vers à soie au Japon*, par Onchaki Mourikowami (Paris, 1848); "Die Heilkunde in Japan" in *Mittheil. d. deutsch. Gesellsch. für Natur- und Völkerk. Ost-Asiens* (1873-1874); and *Japanische Studien* (1878).

HOFFMANN, AUGUST WILHELM VON (1818-1892), German chemist, was born at Giessen on the 8th of April 1818. Not

intending originally to devote himself to physical science, he first took up the study of law and philology at Göttingen, and the general culture he thus gained stood him in good stead when he turned to chemistry, the study of which he began under Liebig. When, in 1845, a school of practical chemistry was started in London, under the style of the Royal College of Chemistry, Hoffmann, largely through the influence of the Prince Consort, was appointed its first director. It was with some natural hesitation that he, then a *Privatdozent* at Bonn, accepted the position, which may well have seemed rather a precarious one; but the difficulty was removed by his appointment as extraordinary professor at Bonn, with leave of absence for two years, so that he could resume his career in Germany if his English one proved unsatisfactory. Fortunately the college was more or less successful, owing largely to his enthusiasm and energy, and many of the men who were trained there subsequently made their mark in chemical history. But in 1864 he returned to Bonn, and in the succeeding year he was selected to succeed E. Mitscherlich as professor of chemistry and director of the laboratory in Berlin University. In leaving England, of which he used to speak as his adopted country, Hoffmann was probably influenced by a combination of causes. The public support extended to the college of chemistry had been dwindling for some years, and before he left it had ceased to have an independent existence and had been absorbed into the School of Mines. This event he must have looked upon as a curtailment of its possibilities of usefulness. But, in addition, there is only too much reason to suppose that he was disappointed at the general apathy with which his science was regarded in England. No man ever realized more fully than he how entirely dependent on the advance of scientific knowledge is the continuation of a country's material prosperity, and no single chemist ever exercised a greater or more direct influence upon industrial development. In England, however, people cared for none of these things, and were blind to the commercial potentialities of scientific research. The college to which Hoffmann devoted nearly twenty of the best years of his life was starved; the coal-tar industry, which was really brought into existence by his work and that of his pupils under his direction at that college, and which with a little intelligent forethought might have been retained in England, was allowed to slip into the hands of Germany, where it is now worth millions of pounds annually; and Hoffmann himself was compelled to return to his native land to find due appreciation as one of the foremost chemists of his time. The rest of his life was spent in Berlin, and there he died on the 5th of May 1892. That city possesses a permanent memorial to his name in Hofmann House, the home of the German Chemical Society (of which he was the founder), which was formally opened in 1900, appropriately enough with an account of that great triumph of German chemical enterprise, the industrial manufacture of synthetical indigo.

Hoffmann's work covered a wide range of organic chemistry, though with inorganic bodies he did but little. His first research, carried out in Liebig's laboratory at Giessen, was on coal-tar, and his investigation of the organic bases in coal-gas naphtha established the nature of aniline. This substance he used to refer to as his first love, and it was a love to which he remained faithful throughout his life. His perception of the analogy between it and ammonia led to his famous work on the amines and ammonium bases and the allied organic phosphorus compounds, while his researches on rosaniline, which he first prepared in 1858, formed the first of a series of investigations on colouring matters which only ended with quinoline red in 1887. But in addition to these and numberless other investigations for which he was responsible the influence he exercised through his pupils must also be taken into account. As a teacher, besides the power of accurately gauging the character and capabilities of those who studied under him, he had the faculty of infecting them with his own enthusiasm, and thus of stimulating them to put forward their best efforts. In the lecture-room he laid great stress on the importance of experimental demonstrations, paying particular attention to their selection and arrangement, though, since he

himself was a somewhat clumsy manipulator, their actual exhibition was generally entrusted to his assistants. He was the possessor of a clear and graceful, if somewhat florid, style, which showed to special advantage in his numerous obituary notices or encomiums (collected and published in three volumes *Zur Erinnerung an vorangegangene Freunde*, 1888). He also excelled as a speaker, particularly at gatherings of an international character, for in addition to his native German he could speak English, French and Italian with fluency.

See *Memorial Lectures delivered before the Chemical Society, 1893-1900* (London, 1901).

HOFMANN, JOHANN CHRISTIAN KONRAD VON (1810-1877). Lutheran theologian and historian, was born on the 21st of December 1810 at Nuremberg, and studied theology and history at the university of Erlangen. In 1829 he went to Berlin, where Schlieiermacher, Hengstenberg, Neander, Ranke and Raumer were among his teachers. In 1833 he received an appointment to teach Hebrew and history in the gymnasium of Erlangen. In 1835 he became *Repetent*, in 1838 *Privatdozent* and in 1841 *professor extraordinarius* in the theological faculty at Erlangen. In 1842 he became *professor ordinarius* at Rostock, but in 1845 returned once more to Erlangen as the successor of Gottlieb Christoph Adolf von Harless (1806-1879), founder of the *Zeitschrift für Protestantismus und Kirche*, of which Hofmann became one of the editors in 1846, J. F. Hüfling (1802-1853) and Gottfried Thomasius (1802-1875) being his collaborators. He was a conservative in theology, but an enthusiastic adherent of the progressive party in politics, and sat as member for Erlangen and Fürth in the Bavarian second chamber from 1863 to 1868. He died on the 20th of December 1877.

He wrote *Die sieben Jahre des Jeremias u. die sieben Jahrwochen des Daniel* (1836); *Geschichte des Aufstiegs in den Covenen* (1837); *Lehrbuch der Weltgeschichte für Gymnasien* (1839), which became a text-book in the Protestant gymnasia of Bavaria; *Weissagung u. Erfüllung im alten u. neuen Testamente* (1841-1844; 2nd ed., 1857-1860); *Der Schriftbeweis* (1852-1856; 2nd ed., 1857-1860); *Die heilige Schrift des neuen Testaments zusammenhängend untersucht* (1862-1875); *Schutzschriften* (1856-1859), in which he defends himself against the charge of denying the Atonement, and *Theologische Ethik* (1878). His most important works are the five last named. In theology, as in ecclesiastical polity, Hofmann was a Lutheran of an extreme type, although the strongly marked individuality of some of his opinions laid him open to repeated accusations of heterodoxy. He was the head of what has been called the Erlangen School, and "in his day he was unquestionably the chief glory of the University of Erlangen" (Lichtenberger).

See the articles in Herzog-Hauck's *Realencyclopädie und Allgemeine deutsche Biographie*; and cf. F. Lichtenberger, *History of German Theology in the Nineteenth Century* (1889) pp. 446-458.

HOFMANN, MELCHIOR (c. 1498-1543-4), anabaptist, was born at Hall, in Swabia, before 1500 (Zur Linden suggests 1498). His biographers usually give his surname as above; in his printed works it is Hoffman, in his manuscripts Hoffmann. He was without scholarly training, and first appears as a furrier at Livland. Attracted by Luther's doctrine, he came forward as a lay preacher, combining business travels with a religious mission. Accompanied by Melchior Rinck, also a skinner or furrier, and a religious enthusiast, he made his way to Sweden. Joined by Bernard Knipperdolling, the party reached Stockholm in the autumn of 1524. Their fervid attacks on image worship led to their expulsion. By way of Livonia, Hofmann arrived at Dorpat in November 1524, but was driven thence in the following January. Making his way to Riga, and thence to Wittenberg, he found favour with Luther; his letter of the 22nd of June 1525 appears in a tract by Luther of that year. He was again at Dorpat in May 1526; later at Magdeburg. Returning to Wittenberg, he was coldly received; he wrote there his exposition of Daniel xiii. (1527). Repairing to Holstein, he got into the good graces of Frederick I. of Denmark, and was appointed by royal ordinance to preach the Gospel at Kiel. He was extravagant in denunciation, and developed a Zwinglian view of the Eucharist. Luther was alarmed. At a colloquy of

preachers in Flensburg (8th April 1529) Hofmann, John Campanus and others were put on their defence. Hofmann maintained (against the "magic" of the Lutherans) that the function of the Eucharist, like that of preaching, is an appeal for spiritual union with Christ. Refusing to retract, he was banished. At Strassburg to which he now turned, he was well received (1529) till his anabaptist development became apparent. He was in relations with Schwenkfeld and with Carlstadt, but assumed a prophetic rôle of his own. Journeying to East Friesland, (1530) he founded a community at Emden (1532), securing a large following of artisans. Despite the warning of John Trypmaker, who prophesied for him "six months" in prison, he returned in the spring of 1533 to Strassburg, where we hear of his wife and child. He gathered from the Apocalypse a vision of "resurrections" of apostolic Christianity, first under John Hus, and now under himself. The year 1533 was to inaugurate the new era; Strassburg was to be the seat of the New Jerusalem. In May 1533 he and others were arrested. Under examination, he denied that he had made common cause with the anabaptists and claimed to be no prophet, a mere witness of the Most High, but refused the articles of faith proposed to him by the provincial synod. Hofmann and Claus Frey, an anabaptist, were detained in prison, a measure due to the terror excited by the Münster episode of 1533-1534. The synod, in 1539, made further effort to reclaim him. The last notice of his imprisonment is on the 19th of November 1543; he probably died soon after.

Two of his publications, with similar titles, in 1530, are noteworthy as having influenced Menno Simons and David Joris (*Weissagung von heiliger göttlicher schrift, und Prophecy oder Weissagung von warer heiliger göttlicher schrift*). Bock treats him as an antitrinitarian, on grounds which Wallace rightly deems inconclusive. With better reason Trechsel includes him among pioneers of some of the positions of Servetus. His Christology was Valentinian. While all are elected to salvation, only the regenerate may receive baptism, and those who sin after regeneration sin against the Holy Ghost, and cannot be saved. His followers were known as Hofmannites or Melchiorites.

See G. Herrmann, *Essai sur la vie et les écrits de M. Hofmann* (1852); F. O. zur Linden, *M. Hofmann, ein Prophet der Wiederkunft* (1885); H. Holtzmann, in *Allgemeine deutsche Biographie* (1880); Hegler in Hauck's *Realencyclopädie* (1900); Bock, *Hist. Antitrin.* (1776), ii.; Wallace, *Antitrin. Biography* (1850) iii., app. iii.; Trechsel, *Prot. Antitrin. vor F. Socin* (1839) i.; Barclay, *Inner Life of Rel. Societies* (1876). An alleged portrait, from an engraving of 1608, is reproduced in the appendix to A. Ross, *Panséus* (1655). (A. G.)

HOFMEISTER, WILHELM FRIEDRICH BENEDICT (1824-1877), German botanist, was born at Leipzig on the 18th of May 1824. He came of a family engaged in trade, and after being educated at the *Realschule* of Leipzig he entered business as a music-dealer. Much of his botanical work was done while he was so employed, till in 1863 he was nominated, without intermediate academic steps, to the chair in Heidelberg; thence he was transferred in 1872 to Tübingen, in succession to H. von Mohl. His first work was on the distribution of the Coniferae in the Himalaya, but his attention was very soon devoted to studying the sexuality and origin of the embryo of Phanerogams. His contributions on this subject extended from 1847 till 1860, and they finally settled the question of the origin of the embryo from an ovum, as against the prevalent pollen-tube theory of M. J. Schleiden, for he showed that the pollen-tube does not itself produce the embryo, but only stimulates the ovum already present in the ovule. He soon turned his attention to the embryology of Bryophytes and Pteridophytes, and gave continuous accounts of the germination of the spores and fertilization in *Pilularia*, *Salvinia*, *Selaginella*. Some of the main facts of the life of ferns and mosses were already known; these, together with his own wider observations, were worked into that great general pronouncement published in 1851 under the title, *Vergleichende Untersuchungen der Keimung, Entfaltung und Fruchtbildung höherer Kryptogamen und der Samenbildung der Coniferen*.

This work will always stand in the first rank of botanical books. It antedated the *Origin of Species* by eight years, but contained facts and comparisons which could only become intelligible on some theory of descent. The plan of life-story common to them all, involving two alternating generations, was demonstrated for Liverworts, Mosses, Ferns, Equiseta, Rhizocarps, Lycopodiaceae, and even Gymnosperms, with a completeness and certainty which must still surprise those who know the botanical literature of the author's time. The conclusions of Hofmeister remain in their broad outlines unshaken, but rather strengthened by later-acquired details. In the light of the theory of descent the common plan of life-history in plants apparently so diverse as those named acquires a special significance; but it is one of the remarkable features of this great work that the writer himself does not theorize—with an unerring insight he points out his comparisons and states his homologies, but does not indulge in explanatory surmises. It is the typical work of an heroic age of plant-morphology. From 1857 till 1862 Hofmeister wrote occasionally on physiological subjects, such as the ascent of sap, and curvatures of growing parts, but it was in morphology that he found his natural sphere. In 1861, in conjunction with other botanists, a plan was drawn up of a handbook of physiological botany, of which Hofmeister was to be editor. Though the original scheme was never completed, the editor himself contributed two notable parts, *Die Lehre von der Pflanzenselle* (1867) and *Allgemeine Morphologie der Gewächse* (1868). The former gives an excellent summary of the structure and relations of the vegetable cell as then known, but it did not greatly modify current views. The latter was notable for its refutation of the spiral theory of leaf arrangement in plants, founded by C. F. Schimper and A. Braun. Hofmeister transferred the discussion from the mere study of mature form to the observation of the development of the parts, and substituted for the "spiral tendency" a mechanical theory based upon the observed fact that new branchings appear over the widest gaps which exist between next older branchings of like nature. With this important work Hofmeister's period of active production closed; he fell into ill-health, and retired from his academic duties some time before his death at Lindenau, near Leipzig, on the 12th of January 1877. (F. O. B.)

HOFMEYR, JAN HENDRIK (1845-1900), South African politician, was born at Cape Town on the 4th of July 1845. He was educated at the South African College, and at an early age turned his attention to politics, first as a journalist. He was editor of the *Zuid Afrikaan* till its incorporation with *Ons Land*, and of the *Zuid Afrikaansche Tijdschrift*. By birth, education and sympathies a typical Dutch Afrikaner, he set himself to organize the political power of his fellow-countrymen. This he did very effectively, and when in 1870 he entered the Cape parliament as member for Stellenbosch, he became the real leader of the Dutch party. Yet he only held office for six months—as minister without portfolio in the Scanlen ministry from May to November 1881. He held no subsequent official post in the colony, though he shared with Sir Thomas Upington and Sir Charles Mills the honour of representing the Cape at the intercolonial conference of 1887. Here he supported the proposal for entrusting the defence of Simon's Town to Cape Colony, leaving only the armament to be provided by the imperial government, opposed trans-oceanic penny postage, and moved a resolution in favour of an imperial customs union. At the colonial conference of 1894 at Ottawa he was again one of the Cape representatives. In 1888 and in 1889 he was a member of the South African customs conference.

His chief importance as a public man was, however, derived from his power over the Dutch in Cape Colony, and his control of the Afrikaner Bond. In 1878 he had himself founded the "Farmers' Association," and as the Cape farmers were almost entirely Dutch the Association became a centre of Dutch influence. When the Bond was formed in 1882, with purely political aims, Hofmeyr made haste to obtain control of it, and in 1883 amalgamated the Farmers' Association with it. Under his direction the constitution of the Bond was modified

by the elimination of the provisions inconsistent with loyalty to the British crown. But it remained an organization for obtaining the political supremacy of the Cape Dutch. (See *CAPE COLONY: History*.) His control over the Bond enabled him for many years, while free from the responsibilities of office, to make and unmake ministers at his will, and earned for him the name of "Cabinet-maker of South Africa." Although officially the term "Afrikaner" was explained by Hofmeyr to include white men of whatever race, yet in practice the influence of the Bond was always exerted in favour of the Dutch, and its power was drawn from the Dutch districts of Cape Colony. The sympathies of the Bond were thus always strongly with the Transvaal, as the chief centre of Dutch influence in South Africa; and Hofmeyr's position might in many respects be compared with that of Parnell at the head of the Irish Nationalist party in Great Britain. In the Bechuanaland difficulty of 1884 Hofmeyr threw all the influence of the Bond into the scale in favour of the Transvaal. But in the course of the next few years he began to drift away from President Kruger. He resented the reckless disregard of Cape interests involved in Kruger's fiscal policy; he feared that the Transvaal, after its sudden leap into prosperity upon the gold discoveries of 1886, might overshadow all other Dutch influences in South Africa; above all he was convinced, as he showed by his action at the London conference, that the protection of the British navy was indispensable to South Africa, and he set his face against Kruger's intrigues with Germany, and his avowed intention of acquiring an outlet to the sea in order to get into touch with foreign powers.

In 1890 Hofmeyr joined forces with Cecil Rhodes, who became premier of Cape Colony with the support of the Bond. Hofmeyr's influence was a powerful factor in the conclusion of the Swaziland convention of 1890, as well as in stopping the "trek" to Banyaland (Rhodesia) in 1891—a notable reversal of the policy he had pursued seven years before. But the reactionary elements in the Bond grew alarmed at Rhodes's imperialism, and in 1895 Hofmeyr resigned his seat in parliament and the presidency of the Bond. Then came the Jameson Raid, and in its wake there rolled over South Africa a wave of Dutch and anti-British feeling such as had not been known since the days of Majuba. (The proclamation issued by Sir Hercules Robinson disavowing Jameson was suggested by Hofmeyr, who helped to draw up its terms.) Once more Hofmeyr became president of the Bond. By an alteration of the provincial constitution, all power in the Cape branch of the Bond was vested in the hands of a vigilance committee of three, of whom Hofmeyr and his brother were two. As the recognized leader of the Cape Dutch, he protested against such abuses as the dynamite monopoly in the Transvaal, and urged Kruger even at the eleventh hour to grant reasonable concessions rather than plunge into a war that might involve Cape Afrikanerdom and the Transvaal in a common ruin. In July 1899 he journeyed to Pretoria, and vainly supported the proposal of a satisfactory franchise law, combined with a limited representation of the Uitlanders in the Volksraad, and in September urged the Transvaal to accede to the proposed joint inquiry. During the negotiations of 1899, and after the outbreak of war, the official organ of the Bond, *Ons Land*, was conspicuous for its anti-British attitude, and its violence forced Lord Roberts to suppress it in the Cape Colony district under martial law. Hofmeyr never associated himself publicly with the opinions expressed by *Ons Land*, but neither did he repudiate them. The tide of race sympathy among his Dutch supporters made his position one of great difficulty, and shortly after the outbreak of war he withdrew to Europe, and refused to act as a member of the "Conciliatory Committee" which came to England in 1901 in the interests of the Boer republics.

Towards the close of the war Hofmeyr returned to South Africa and organized the Bond forces for the general election held in Cape Colony at the beginning of 1904, which resulted in the defeat of the Bond party. Hofmeyr retained his ascendancy over the Cape Dutch, but now began to find himself somewhat out of sympathy with the larger outlook on South African

affairs taken by the younger leaders of the Boers in the Transvaal. During 1906 he gave offence to the extreme section of the Bond by some criticisms of the *taal* and his use of English in public speeches. At the general election in 1908 the Bond, still largely under his direction, gained a victory at the polls, but Hofmeyr himself was not a candidate. In the renewed movement for the closer union of the South African colonies he advocated federation as opposed to unification. When, however, the unification proposals were ratified by the Cape parliament, Hofmeyr procured his nomination as one of the Cape delegates to England in the summer of 1909 to submit the draft act of union to the imperial government. He attended the conferences with the officials of the Colonial Office for the preparation of the draft act, and after the bill had become law went to Germany for a "cure." He returned to London in October 1909, where he died on the 16th of that month. His body was taken to Cape Town for burial.

HOFSTEDE DE GROOT, PETRUS (1802-1886), Dutch theologian, was born at Leer in East Friesland, Prussia, on the 8th of October 1802, and was educated at the Gymnasium and university of Gröningen. For three years (1826-1829) he was pastor of the Reformed Church at Ulrum, and then entered upon his lifelong duties as professor of theology at Gröningen. With his colleagues L.G. Parcau, J. F. van Vordt, and W. Muurling he edited from 1837 to 1872 the *Waarheid in Liefde*. In this review and in his numerous books he vigorously upheld the orthodox faith against the Dutch "modern theology" movement. Many of his works were written in Latin, including *Disputatio, qua ep. ad Hebraeos cum Paulin. epistolis comparatur* (1826), *Institutiones historiae ecclesiae* (1835), *Institutio theologiae naturalis* (1842), *Encyclopaedia theologi christiani* (1844). Others, in Dutch, were: *The Divine Education of Humanity up to the Coming of Jesus Christ* (3 vols., 1846), *The Nature of the Gospel Ministry* (1858), *The "Modern Theology" of the Netherlands* (1869), *The Old Catholic Movement* (1877). He became professor emeritus in 1872, and died at Gröningen on the 5th of December 1886.

HOGARTH, WILLIAM (1697-1764), the great English painter and pictorial satirist, was born at Bartholomew Close in London on the 26th of November 1697, and baptized on the 28th in the church of St Bartholomew the Great. He had two younger sisters, Mary, born in 1699, and Ann, born in 1701. His father, Richard Hogarth, who died in 1718, was a schoolmaster and literary hack, who had come to the metropolis to seek that fortune which had been denied to him in his native Westmorland. The son seems to have been early distinguished by a talent for drawing and an active perceptive faculty rather than by any close attention to the learning which he was soon shrewd enough to see had not made his parent prosper. "Shows of all sorts gave me uncommon pleasure when an infant," he says, "and mimicry, common to all children, was remarkable in me. . . . My exercises when at school were more remarkable for the ornaments which adorned them than for the exercise itself." This being the case, it is no wonder that, by his own desire, he was apprenticed to a silver-plate engraver, Mr Ellis Gamble, at the sign of the "Golden Angel" in Cranbourne Street or Alley, Leicester Fields. For this master he engraved a shop-card which is still extant. When his apprenticeship began is not recorded; but it must have been concluded before the beginning of 1720, for in April of that year he appears to have set up as engraver on his own account. His desires, however, were not limited to silver-plate engraving. "Engraving on copper was, at twenty years of age, my utmost ambition." For this he lacked the useful skill as a draughtsman; and his account of the means which he took to supply this want, without too much interfering with his pleasure, is thoroughly characteristic, though it can scarcely be recommended as an example. "Laying it down," he says, "first as an axiom, that he who could by any means acquire and retain in his memory, perfect ideas of the subjects he meant to draw, would have as clear a knowledge of the figure as a man who can write freely hath of the twenty-four letters of the alphabet and their infinite

combinations (each of these being composed of lines), and would consequently be an accurate designer. . . . I therefore endeavoured to habituate myself to the exercise of a sort of technical memory, and by repeating in my own mind, the parts of which objects were composed, I could by degrees combine and put them down with my pencil." This account, it is possible, has something of the complacency of the old age in which it was written; but there is little doubt that his marvellous power of seizing expression owed less to patient academical study than to his unexampled eye-memory and tenacity of minor detail. But he was not entirely without technical training, since, by his own showing, he occasionally "took the life" to correct his memories, and is known to have studied at Sir James Thornhill's then recently opened art school.

"His first employment" (*i.e.* after he set up for himself) "seems," says John Nichols, in his *Anecdotes*, "to have been the engraving of arms and shop bills." After this he was employed in designing "plates for booksellers." Of these early and mostly insignificant works we may pass over "The Lottery, an Emblematic Print on the South Sea Scheme," and some book illustrations, to pause at "Masquerades and Operas" (1724), the first plate he published on his own account. This is a clever little satire on contemporary follies, such as the masquerades of the Swiss adventurer Heidegger, the popular Italian opera-singers, Rich's pantomimes at Lincoln's Inn Fields, and last, but by no means least, the exaggerated popularity of Lord Burlington's protégé, the architect painter William Kent, who is here represented on the summit of Burlington Gate, with Raphael and Michelangelo for supporters. This worthy, Hogarth had doubtless not learned to despise less in the school of his rival Sir James Thornhill. Indeed almost the next of Hogarth's important prints was aimed at Kent alone, being that memorable burlesque of the unfortunate altarpiece designed by the latter for St Clement Danes, which, in deference to the ridicule of the parishioners, Bishop Gibson took down in 1725. Hogarth's squib, which appeared subsequently, exhibits it as a very masterpiece of confusion and bad drawing. In 1726 he prepared twelve large engravings for Butler's *Hudibras*. These he himself valued highly, and they are the best of his book illustrations. But he was far too individual to be the patient interpreter of other men's thoughts, and it is not in this direction that his successes are to be sought.

To 1727-1728 belongs one of those rare occurrences which have survived as contributions to his biography. He was engaged by Joshua Morris, a tapestry worker, to prepare a design for the "Element of Earth." Morris, however, having heard that he was "an engraver, and no painter," declined the work when completed, and Hogarth accordingly sued him for the money in the Westminster Court, where, on the 28th of May 1728, the case was decided in his (Hogarth's) favour. It may have been the aspersion thus early cast on his skill as a painter (coupled perhaps with the unsatisfactory state of print-selling, owing to the uncontrolled circulation of piratical copies) that induced him about this time to turn his attention to the production of "small conversation pieces" (*i.e.* groups in oil of full-length portraits from 12 to 15 in. high), many of which are still preserved in different collections. "This," he says, "having novelty, succeeded for a few years." Among his other efforts in oil between 1728 and 1732 were "The Wanstead Conversation," "The House of Commons examining Bambridge," an infamous warden of the Fleet, and several pictures of the chief actors in Gay's popular *Beggar's Opera*.

On the 23rd of March 1729 he was married at old Paddington church to Jane Thornhill, the only daughter of Kent's rival above mentioned. The match was a clandestine one, although Lady Thornhill appears to have favoured it. We next hear of him in "lodgings at South Lambeth," where he rendered some assistance to the then well-known Jonathan Tyers, who opened Vauxhall in 1732 with an entertainment styled a *ridotto al fresco*. For these gardens Hogarth painted a poor picture of Henry VIII. and Anne Boleyn, and he also permitted Hayman to make copies of the later series of the "Four Times of the Day."

In return, the grateful Tyers presented him with a gold pass ticket "In perpetuum Beneficii Memoriam." It was long thought that Hogarth designed this himself. Mr Warwick Wroth (*Numismatic Chronicle*, vol. xviii.) doubts this, although he thinks it probable that Hogarth designed some of the silver Vauxhall passes which are figured in Wilkinson's *Londina illustrata*. The only engravings between 1726 and 1732 which need be referred to are the "Large Masquerade Ticket" (1727), another satire on masquerades, and the print of "Burlington Gate" (1731), evoked by Pope's *Epistle to Lord Burlington*, and defending Lord Chandos, who is therein satirized. This print gave great offence, and was, it is said, suppressed.

By 1731 Hogarth must have completed the earliest of the series of moral works which first gave him his position as a great and original genius. This was "A Harlot's Progress," the paintings for which, if we may trust the date in the last of the pictures, were finished in that year. Almost immediately afterwards he must have begun to engrave them—a task he had at first intended to leave to others. From an advertisement in the *Country Journal*; or, the *Craftsman*, 29th of January 1732, the pictures were then being engraved, and from later announcements it seems clear that they were delivered to the subscribers early in the following April, on the 21st of which month an unauthorized prose description of them was published. We have no record of the particular train of thought which prompted these story-pictures; but it may perhaps be fairly assumed that the necessity for creating some link of interest between the personages of the little "conversation pieces" above referred to, led to the further idea of connecting several groups or scenes so as to form a sequent narrative. "I wished," says Hogarth, "to compose pictures on canvases, similar to representations on the stage." "I have endeavoured," he says again, "to treat my subject as a dramatic writer; my picture is my stage, and men and women my players, who by means of certain actions and gestures are to exhibit a *dumb show*." There was never a more eloquent dumb show than this of "Harlot's Progress." In six scenes the miserable career of a woman of the town is traced out remorselessly from its first facile beginning to its shameful and degraded end. Nothing of the detail is softened or abated; the whole is acted out *coram populo*, with the hard, uncompassionate morality of the age the painter lived in, while the introduction here and there of one or two well-known characters such as Colonel Charteris and Justice Gonson give a vivid reality to the satire. It had an immediate success. To say nothing of the fact that the talent of the paintings completely reconciled Sir James Thornhill to the son-in-law he had hitherto refused to acknowledge, more than twelve hundred names of subscribers to the engravings were entered in the artist's book. On the appearance of plate iii. the lords of the treasury trooped to the print shop for Sir John Gonson's portrait which it contained. The story was made into a pantomime by Theophilus Cibber, and by some one else into a ballad opera; and it gave rise to numerous pamphlets and poems. It was painted on fan-mounts and transferred to cups and saucers. Lastly, it was freely pirated. There could be no surer testimony to its popularity.

From the MSS. of George Vertue in the British Museum (Add. MSS. 23060-98) it seems that during the progress of the plates, Hogarth was domiciled with his father-in-law, Sir James Thornhill, in the Middle Piazza, Covent Garden (the "second house eastward from James Street"), and it must have been there that set out the historical expedition from London to Sheerness of which the original record still exists at the British Museum. This is an oblong MS. volume entitled *An Account of what seem'd most Remarkable in the Five Days' Peregrination of the Five Following Persons, viz., Messieurs Tothall, Scott, Hogarth, Thornhill and Forrest. Begun on Saturday May 27th 1732 and Finish'd On the 31st of the Same Month. Abi lu et fac similitur. Inscription on Dulwich College Porch*. The journal, which is written by Ebenezer, the father of Garrick's friend Theodosius Forrest, gives a good idea of what a "frisk"—as Johnson called it—was in those days, while the illustrations were by Hogarth and Samuel Scott the landscape painter.

John Thornhill, Sir James's son, made the map. This version (in prose) was subsequently run into rhyme by one of Hogarth's friends, the Rev. Wm. Gostling of Canterbury, and after the artist's death both versions were published. In the absence of other biographical detail, they are of considerable interest to the student of Hogarth. In 1733 Hogarth moved into the "Golden Head" in Leicester Fields, which, with occasional absences at Chiswick, he continued to occupy until his death. By December of this year he was already engaged upon the engravings of a second Progress, that of a Rake. It was not as successful as its predecessor. It was in eight plates in lieu of six. The story is unequal; but there is nothing finer than the figure of the desperate hero in the Covent Garden gaming-house, or the admirable scenes in the Fleet prison and Bedlam, where at last his headlong career comes to its tragic termination. The plates abound with allusive suggestion and covert humour; but it is impossible to attempt any detailed description of them here.

"A Rake's Progress" was dated June 25, 1735, and the engravings bear the words "according to Act of Parliament." This was an act (8 Geo. II. cap. 13) which Hogarth had been instrumental in obtaining from the legislature, being stirred thereto by the shameless piracies of rival print-sellers. Although loosely drawn, it served its purpose; and the painter commemorated his success by a long inscription on the plate entitled "Crowns, Mitres, &c.," afterwards used as a subscription ticket to the Election series. These subscription tickets to his engravings, let us add, are among the brightest and most vivacious of the artist's productions. That to the "Harlot's Progress" was entitled "Boys peeping at Nature," while the Rake's Progress was heralded by the delightful etching known as "A Pleased Audience at a Play, or The Laughing Audience."

We must pass more briefly over the prints which followed the two Progresses, noting first "A Modern Midnight Conversation," an admirable drinking scene which comes between them in 1733, and the bright little plate of "Southwark Fair," which, although dated 1733, was published with "A Rake's Progress" in 1735. Between these and "Marriage à la mode," upon the pictures of which the painter must have been not long after at work, come the small prints of the "Consultation of Physicians" and "Sleeping Congregation" (1736), the "Scholars at a Lecture" (1737); the "Four Times of the Day" (1738), a series of pictures of 18th century life, the earlier designs for which have been already referred to; the "Strolling Actresses dressing in a Barn" (1738), which Walpole held to be, "for wit and imagination, without any other end, the best of all the painter's works"; and finally the admirable plates of the Distrest Poet painfully composing a poem on "Riches" in a garret, and the Enraged Musician fulminating from his parlour window upon a discordant orchestra of knife-grinders, milk-girls, ballad-singers and the rest upon the pavement outside. These are dated respectively 1736 and 1741. To this period also (*i.e.* the period preceding the production of the plates of "Marriage à la mode") belong two of those history pictures to which, in emulation of the Haymans and Thornhills, the artist was continually attracted. "The Pool of Bethesda" and the "Good Samaritan," "with figures seven feet high," were painted *circa* 1736, and presented by the artist to St Bartholomew's Hospital, where they remain. They were not masterpieces; and it is pleasanter to think of his connexion with Captain Coram's recently established Foundling Hospital (1739), which he aided with his money, his graver and his brush, and for which he painted that admirable portrait of the good old philanthropist which is still, and deservedly, one of its chief ornaments.

In "A Harlot's Progress" Hogarth had not strayed much beyond the lower walks of society, and although, in "A Rake's Progress," his hero was taken from the middle classes, he can scarcely be said to have quitted those fields of observation which are common to every spectator. It is therefore more remarkable, looking to his education and antecedents, that his masterpiece, "Marriage à la mode," should successfully depict, as the advertisement has it, "a variety of modern occurrences in high life."

Yet, as an accurate delineation of upper class 18th century society, his "Marriage à la mode" has never, we believe, been seriously assailed. The countess's bedroom, the earl's apartment with its lavish coronets and old masters, the grand saloon with its marble pillars and grotesque ornaments, are fully as true to nature as the frowsy chamber in the "Turk's Head Bagno," the quack-doctor's museum in St Martin's Lane, or the mean opulence of the merchant's house in the city. And what story could be more vividly, more perspicuously, more powerfully told than this goddess alliance of *sacs et parchemins*—this miserable tragedy of an ill-assorted marriage? There is no defect of invention, no superfluity of detail, no purposeless stroke. It has the merit of a work by a great master of fiction, with the additional advantages which result from the pictorial fashion of the narrative; and it is matter for congratulation that it is still to be seen by all the world in the National Gallery in London, where it can tell its own tale better than pages of commentary. The engravings of "Marriage à la mode" were dated April 1745. Although by this time the painter found a ready market for his engravings, he does not appear to have been equally successful in selling his pictures. The people bought his prints; but the richer and not numerous connoisseurs who purchased pictures were wholly in the hands of the importers and manufacturers of "old masters." In February 1745 the original oil paintings of the two Progresses, the "Four Times of the Day" and the "Strolling Actresses" were still unsold. On the last day of that month Hogarth disposed of them by an ill-devised kind of auction, the details of which may be read in Nichols's *Anecdotes*, for the paltry sum of £47.7s. No better fate attended "Marriage à la mode," which six years later became the property of Mr Lane of Hillingdon for 120 guineas, being then in Carlo Maratti frames which had cost the artist four guineas a piece. Something of this was no doubt due to Hogarth's impracticable arrangements, but the fact shows conclusively how completely blind his contemporaries were to his merits as a painter, and how hopelessly in bondage to the all-powerful picture-dealers. Of these latter the painter himself gave a graphic picture in a letter addressed by him under the pseudonym of "Britophil" to the *St James's Evening Post*, in June 1737.

But if Hogarth was not successful with his dramas on canvas, he occasionally shared with his contemporaries in the popularity of portrait painting. For a picture, executed in 1746, of Garrick as Richard III. he was paid £300, "which was more," says he, "than any English artist ever received for a single portrait." In the same year a sketch of Simon Fraser, Lord Lovat, afterwards beheaded on Tower Hill, had an exceptional success.

We must content ourselves with a brief enumeration of the most important of his remaining works. These are "The Stage Coach or Country Inn Yard" (1747); the series of twelve plates entitled "Industry and Idleness" (1747), depicting the career of two London apprentices; the "Gate of Calais" (1749), which had its origin in a rather unfortunate visit paid to France by the painter after the peace of Aix-la-Chapelle; the "March to Finchley" (1750); "Beer Street," "Gin Lane" and the "Four Stages of Cruelty" (1751); the admirable representations of election humours in the days of Sir Robert Walpole, entitled "Four Prints of an Election" (1755-1758); and the plate of "Credulity, Superstition and Fanaticism, a Medley" (1762), adapted from an earlier unpublished design called "Enthusiasm Delineated." Besides these must be chronicled three more essays in the "great style of history painting," viz. "Paul before Felix," "Moses brought to Pharaoh's Daughter" and the Altarpiece for St Mary Redcliffe at Bristol. The first two were engraved in 1751-1752, the last in 1794. A subscription ticket to the earlier pictures, entitled "Paul before Felix Burlesqued," had a popularity far greater than that of the prints themselves.

In 1745 Hogarth painted that admirable portrait of himself with his dog Trump, which is now in the National Gallery. In a corner of this he had drawn on a palette a serpentine curve with the words "The Line of Beauty." Much inquiry ensued as to the meaning of this hieroglyphic; and in an unpropitious hour the painter resolved to explain himself in writing. The

result was the well-known *Analysis of Beauty* (1753), a treatise to fix "the fluctuating ideas of Taste," otherwise a desultory essay having for pretext the precept attributed to Michelangelo that a figure should be always "Pyramidal, Serpent like and multiplied by one two and three." The fate of the book was what might have been expected. By the painter's adherents it was praised as a final deliverance upon aesthetics; by his enemies and professional rivals, its obscurities, and the minor errors which, notwithstanding the benevolent efforts of literary friends, the work had not escaped, were made the subject of endless ridicule and caricature. It added little to its author's fame, and it is perhaps to be regretted that he ever undertook it. Moreover, there were further humiliations in store for him. In 1750 the success of a little picture called "The Lady's Last Stake," painted for Lord Charlemont, procured him a commission from Sir Richard Grosvenor to paint another picture "upon the same terms." Unhappily on this occasion he deserted his own field of genre and social satire, to select the story from Boccaccio (or rather Dryden) of Sigismunda weeping over the heart of her murdered lover Guiscardo, being the subject of a picture in Sir Luke Schaub's collection by Furini which had recently been sold for £400. The picture, over which he spent much time and patience, was not regarded as a success; and Sir Richard rather meanly shuffled out of his bargain upon the plea that "the constantly having it before one's eyes, would be too often occasioning melancholy ideas to arise in one's mind." Sigismunda, therefore, much to the artist's mortification, and the delight of the malicious, remained upon his hands. As, by her husband's desire, his widow valued it at £500, it found no purchaser until after her death, when the Boydells bought it for 56 guineas. It was exhibited, with others of Hogarth's pictures, at the Spring Gardens exhibition of 1761, for the catalogue of which Hogarth engraved a Head-piece and a Tail-piece which are still the delight of collectors; and finally, by the bequest of Mr J. H. Anderdon, it passed in 1879 to the National Gallery, where, in spite of theatrical treatment and a repulsive theme, it still commands admiration for its colour, drawing and expression.

In 1761 Hogarth was sixty-five years of age, and he had but three years more to live. These three years were embittered by an unhappy quarrel with his quondam friends, John Wilkes and Churchill the poet, over which most of his biographers are contented to pass rapidly. Having succeeded John Thornhill in 1757 as serjeant painter (to which post he was reappointed at the accession of George III.), an evil genius prompted him in 1762 to do some "timed" thing in the ministerial interest, and he accordingly published the indifferent satire of "The Times, plate i." This at once brought him into collision with Wilkes and Churchill, and the immediate result was a violent attack upon him, both as a man and an artist, in the opposition *North Briton*, No. 17. The alleged decay of his powers, the miscarriage of Sigismunda, the cobbled composition of the *Analysis*, were all discussed with scurrilous malignity by those who had known his domestic life and learned his weaknesses. The old artist was deeply wounded, and his health was failing. Early in the next year, however, he replied by that portrait of Wilkes which will for ever carry his squinting features to posterity. Churchill retaliated in July by a savage *Epistle to William Hogarth*, to which the artist rejoined by a print of Churchill as a bear, in torn bands and ruffles, not the most successful of his works. "The pleasure, and pecuniary advantage," writes Hogarth manfully, "which I derived from these two engravings" (of Wilkes and Churchill), "together with occasionally riding on horseback, restored me to as much health as can be expected at my time of life." He produced but one more print, that of "Finis, or The Bathos," March 1764, a strange jumble of "fag ends," intended as a tail-piece to his collected prints; and on the 26th October of the same year he died of an aneurism at his house in Leicester Square. His wife, to whom he left his plates as a chief source of income, survived him until 1789. He was buried in Chiswick churchyard, where a tomb was erected to him by his friends in 1771, with an epitaph by Garrick. Not far off, on the road

to Chiswick Gardens, still stands the little red-brick Georgian villa in which from September 1749 until his death he spent the summer seasons. After many vicissitudes and changes of ownership it was purchased in 1902 by Lieut.-Colonel Shipway of Chiswick, who turned it into a Hogarth museum and preserved it to the nation.

From such records of him as survive, Hogarth appears to have been much what from his portrait one might suppose him to have been—a blue-eyed, honest, combative little man, thoroughly insular in his prejudices and antipathies, fond of flattery, sensitive like most satirists, a good friend, an intractable enemy, ambitious, as he somewhere says, in all things to be singular, and not always accurately estimating the extent of his powers. With the art connoisseurship of his day he was wholly at war, because, as he believed, it favoured foreign mediocrity at the expense of native talent; and in the heat of argument he would probably, as he admits, often come "to utter blasphemous expressions against the divinity even of Raphael Urbino, Correggio and Michelangelo." But it was rather against the third-rate copies of third-rate artists—the "ship-loads of dead Christs, Holy Families and Madonnas"—that his indignation was directed; and in speaking of his attitude with regard to the great masters of art, it is well to remember his words to Mrs Piozzi:—"The connoisseurs and I are at war, you know; and because I hate them, they think I hate Titian—and let them!"

But no doubt it was in a measure owing to this hostile attitude of his towards the all-powerful picture-brokers that his contemporaries failed to recognize adequately his merits as a painter, and persisted in regarding him as an ingenious humorist alone. Time has reversed that unjust sentence. He is now held to have been a splendid painter, pure and harmonious in his colouring, wonderfully dexterous and direct in his handling, and in his composition leaving little or nothing to be desired. As an engraver his work is more conspicuous for its vigour, spirit and intelligibility than for finish and beauty of line. He desired that it should tell its own tale plainly, and bear the distinct impress of his individuality, and in this he thoroughly succeeded. As a draughtsman his skill has sometimes been debated, and his work at times undoubtedly bears marks of haste, and even carelessness. If, however, he is judged by his best instead of his worst, he will not be found wanting in this respect. But it is not after all as a draughtsman, an engraver or a painter that he claims his unique position among English artists—it is as a humorist and a satirist upon canvas. Regarded in this light he has never been equalled, whether for his vigour of realism and dramatic power, his fancy and invention in the decoration of his story, or his merciless anatomy and exposure of folly and wickedness. If we regard him—as he loved to regard himself—as "author" rather than "artist," his place is with the great masters of literature,—with the Thackerays and Fieldings, the Cervantes and Molières.

AUTHORITIES.—The main body of Hogarth literature is to be found in the autobiographical *Memoranda* published by John Ireland in 1798, and in the successive *Anecdotes* of the antiquary John Nichols. Much minute information has also been collected in F. G. Stephens' *Catalogue of the Satirical Prints and Drawings in the British Museum*. But a copious bibliography of books, pamphlets, &c., relating to Hogarth, together with detailed catalogues of his paintings and prints, will be found in the *Memoir* of Hogarth by Austin Dobson. First issued in 1879, this was reprinted and expanded in 1891, 1897, 1902 and finally in 1907. Pictures by Hogarth from private collections are constantly to be found at the annual exhibitions of the Old Masters at Burlington House; but most of the best-known works have permanent homes in public galleries. "Marriage à la mode," "Sigismunda," "Lavinia Fenton," the "Shrimp Girl," the "Gate of Calais," the portraits of himself, his sister and his servants, are all in the National Gallery; the "Rake's Progress" and the Election Series, in the Soane Museum; and the "March to Finchley" and "Captain Coram" in the Foundling. There are also notable pictures in the Fitzwilliam Museum at Cambridge and the National Portrait Gallery. At the Print Room in the British Museum there is also a very interesting set of sixteen designs for the series called "Industry and Idleness," the majority of which formerly belonged to Horace Walpole. (A. D.)

HOGG, JAMES (1770-1835). Scottish poet, known as the "Ettrick Shepherd," was baptized at Ettrick in Selkirkshire

on the 9th of December 1770. His ancestors had been shepherds for centuries. He received hardly any school training, and seems to have had difficulty in getting books to read. After spending his early years herding sheep for different masters, he was engaged as shepherd by Mr Laidlaw, tenant of Blackhouse, in the parish of Yarrow, from 1790 till 1799. He was treated with great kindness, and had access to a large collection of books. When this was exhausted he subscribed to a circulating library in Peebles. While attending to his flock, he spent a great deal of time in reading. He profited by the company of his master's sons, of whom William Laidlaw is known as the friend of Scott and the author of *Lucy's Flitton*. Hogg's first printed piece was "The Mistakes of a Night" in the *Scots Magazine* for October 1794, and in 1801 he published his *Scottish Pastorals*. In 1802 Hogg became acquainted with Sir Walter Scott, who was then collecting materials for his *Border Minstrelsy*. On Scott's recommendation Constable published Hogg's miscellaneous poems (*The Mountain Bard*) in 1807. By this work, and by *The Shepherd's Guide, being a Practical Treatise on the Diseases of Sheep*, Hogg realized about £300. With this money he unfortunately embarked on farming in Dumfriesshire, and in three years was utterly ruined, having to abandon all his effects to his creditors. He returned to Ettrick, only to find that he could not even obtain employment as a shepherd; so he set off in February 1810 to push his fortune in Edinburgh as a literary adventurer. In the same year he published a collection of songs, *The Forest Minstrel*, to which he was the largest contributor. This book, being dedicated to the countess of Dalkeith (afterwards duchess of Buccleuch), and recommended to her notice by Scott, was rewarded with a present of 100 guineas. He then began a weekly periodical, *The Spy*, which he continued from September 1810 till August 1811. The appearance of *The Queen's Wake* in 1813 established Hogg's reputation as a poet; Byron recommended it to John Murray, who brought out an English edition. The scene of the poem is laid in 1561; the queen is Mary Stuart; and the "wake" provides a simple framework for seventeen poems sung by rival bards. It was followed by the *Pilgrims of the Sun* (1815), and *Mador of the Moor* (1816). The duchess of Buccleuch, on her death-bed (1814), had asked her husband to do something for the Ettrick bard; and the duke gave him a lease for life of the farm of Altrive in Yarrow, consisting of about 70 acres of moorland, on which the poet built a house and spent the last years of his life. In order to obtain money to stock his farm Hogg asked various poets to contribute to a volume of verse which should be a kind of poetic "benefit" for himself. Failing in his applications he wrote a volume of parodies, published in 1816, as *The Poetic Mirror, or the Living Bards of Great Britain*. He took possession of his farm in 1817; but his literary exertions were never relaxed. Before 1820 he had written the prose tales of *The Brownie of Bodsbeck* (1818) and two volumes of *Winter Evening Tales* (1820), besides collecting, editing and writing part of two volumes of *The Jacobite Relics of Scotland* (1819-1821), and contributing largely to *Blackwood's Magazine*. "The Chaldee MS.," which appeared in *Blackwood's Magazine* (October 1817), and gave such offence that it was immediately withdrawn, was largely Hogg's work.

In 1820 he married Margaret Phillips, a lady of a good Annandale family, and found himself possessed of about £1000, a good house and a well-stocked farm. Hogg's connexion with *Blackwood's Magazine* kept him continually before the public; his contributions, which include the best of his prose works, were collected in the *Shepherd's Calendar* (1820). The wit and mischief of some of his literary friends made free with his name as the "Shepherd" of the *Noctes Ambrosianae*, and represented him in ludicrous and grotesque aspects; but the effect of the whole was favourable to his popularity. "Whatever may be the merits of the picture of the Shepherd [in the *Noctes Ambrosianae*—and no one will deny its power and genius," writes Professor Veitch—"it is true, all the same, that this Shepherd was not the Shepherd of Ettrick or the man James Hogg. He was neither a Socrates nor a Falstaff, neither to be credited

with the wisdom and lofty idealizings of the one, nor with the characteristic humour and coarseness of the other." *The Three Perils of Woman* (1820), and *The Three Perils of Man* (1822), were followed in 1825 by an epic poem, *Queen Hynde*, which was unfavourably received. He visited London in 1832, and was much lionized. On his return a public dinner was given to him in Peebles,—Professor Wilson in the chair,—and he acknowledged that he had at last "found fame." His health, however, was seriously impaired. With his pen in his hand to the last, Hogg in 1834 published a volume of *Lay Sermons*, and *The Domestic Manners and Private Life of Sir Walter Scott*, a book which Lockhart regarded as an infringement on his rights. In 1835 appeared three volumes of *Tales of the Wars of Montrose*. Hogg died on the 21st of November 1835, and was buried in the churchyard of his native parish Ettrick. His fame had seemed to fill the whole district, and was brightest at its close; his presence was associated with all the border sports and festivities; and as a man James Hogg was ever frank, joyous and charitable. It is mainly as a great peasant poet that he lives in literature. Some of his lyrics and minor poems—his "Skylark," "When the Kye comes Home," his verses on the "Comet" and "Evening Star," and his "Address to Lady Ann Scott"—are exquisite. *The Queen's Wake* unites his characteristic excellences—his command of the old romantic ballad style, his graceful fairy mythology and his aerial flights of imagination. In the fairy story of Kilmeny in this work Hogg seems completely transformed; he is absorbed in the ideal and supernatural, and writes under direct and immediate inspiration.

See Hogg's "Memoir of the Author's Life, written by himself," prefixed to the 3rd edition (1821) of *The Mountain Bard*, also *Memorials of James Hogg, the Ettrick Shepherd*, edited by his daughter, Mrs M. G. Garden (enlarged edition with preface by Professor Veitch, 1903), and Sir G. B. S. Douglas, *James Hogg* (1899) in the "Famous Scots" series; also *The Poems of James Hogg*, selected by William Wallace (1903). John Wilson ("Christopher North") had a real affection for Hogg, but for some reason or other made no use of the materials placed in his hands for a biography of the poet. The memoir mentioned on the title-page of the *Works* (1838-1840) never appeared, and the memoir prefixed to the edition of Hogg's works published by Blackie & Co. (1865) was written by the Rev. Thomas Thompson. See also Wilson's *Noctes Ambrosianae*; Mrs Oliphant's *Annals of a Publishing House*, vol. i. chap. vii.; Gillilan's *First Gallery of Literary Portraits*; Cunningham's *Biog. and Crit. Hist. of Lit.*; and the general index to *Blackwood's Magazine*. A collected edition of Hogg's *Tales* appeared in 1837 in 6 vols., and a second in 1851; his *Poetical Works* were published in 1822, 1838-1840 and 1865-1866. For an admirable account of the social entertainments Hogg used to give in Edinburgh, see *Memoir of Robert Chambers* (1874), by Dr William Chambers, pp. 263-270.

HOGG, THOMAS JEFFERSON (1792-1862), English man of letters, was born at Norton, Durham, on the 24th of May 1792. He was educated at Durham grammar school and at University College, Oxford. Here he became the intimate friend of the poet Shelley, with whom in 1811 he was expelled from the university for refusing to disclaim connexion with the authorship of the pamphlet *The Necessity for Atheism*. He was then sent to study law at York, where he remained for six months. Hogg's behaviour to Harriet Shelley interrupted his relations with her husband for some time, but in 1813 the friendship was renewed in London. In 1817 Hogg was called to the bar, and became later a revising barrister. In 1844 he inherited £2000 under Shelley's will, and in 1855, in accordance with the wishes of the poet's family, began to write Shelley's biography. The first two volumes of it were published in 1858, but they proved to be far more an autobiography than a biography, and Shelley's representatives refused Hogg further access to the materials necessary for its completion. Hogg died on the 27th of August 1862.

HOGMANAY, the name in Scotland and some parts of the north of England for New Year's Eve, as also for the cake then given to the children. On the morning of the 31st of December the children in small bands go from door to door singing:

"Hogmanay
Trolloyay
Gie's o' your white bread and nae o' your grey";

and begging for small gifts or alms. These usually take the form of an oaten cake. The derivation of the term has been much disputed. Cotgrave (1611) says: "It is the voice of the country folks begging small presents or New Year's gifts . . . an ancient term of rejoicing derived from the Druids, who were wont the first of each January to go into the woods, where, having sacrificed and banquetted together, they gathered mistletoe, esteeming it excellent to make beasts fruitful and most soverayne against all poyson." And he connects the word, through such Norman French forms as *hoguwané*, with the old French *aguillanneuf*, which he explains as *au gui-l'an-neuf*, "to the mistletoe the New Year!"—this being (on his interpretation) the Druidical salutation to the coming year as the revellers issued from the woods armed with boughs of mistletoe. But though this explanation may be accepted as containing the truth in referring the word to a French original, Cotgrave's detailed etymology is now repudiated by scientific philologists, and the identical French *aguillanneuf* remains, like it, in obscurity.

HOGSHEAD, a cask for holding liquor or other commodities, such as tobacco, sugar, molasses, &c.; also a liquid measure of capacity, varying with the contents. As a measure for beer, cider, &c., it equals 54 gallons. A statute of Richard III. (1483) fixed the hogshead of wine at 63 wine-gallons, *i.e.* 52½ imperial gallons. The etymology of the word has been much discussed. According to Skeat, the origin is to be found in the name for a cask or liquid measure appearing in various forms in several Teutonic languages, in Dutch *oxhooff* (modern *okshoofd*), Dan. *oxhoved*, O. Swed. *oxhufvud*, &c. The word should therefore be "oxhead," and "hogshead" is a mere corruption. It has been suggested that the name arose from the branding of such a measure with the head of an ox (see *Notes and Queries*, series iv. 2, 46, note by H. Tiedeman). The *New English Dictionary* does not attempt any explanation of the term, and takes "hogshead" as the original form, from which the forms in other languages have been corrupted. The earlier Dutch forms *hukeshonet* and *hockshoof* are nearer to the English form, and, further, the Dutch for "ox" is *os*.

HOHENASPERG, an ancient fortress of Germany, in the kingdom of Württemberg, 10 m. N. of Stuttgart, is situated on a conical hill, 1100 ft. high, overlooking the town of Asperg. It was formerly strongly fortified and was long the state prison of the kingdom of Württemberg. Among the many who have been interned here may be mentioned the notorious Jew financier, Joseph Süß-Opppenheimer (1692-1738) and the poet C. F. D. Schubart (1739-1791). It is now a reformatory. Hohenasperg originally belonged to the counts of Calw; it next passed to the counts palatine of Tübingen and from them was acquired in 1308 by Württemberg. In 1535 the fortifications were extended and strengthened, and in 1635 the town was taken by the Imperialists, who occupied it until 1649.

See Schön, *Die Staatsgefängnisse von Hohenasperg* (Stuttgart, 1899); and Biffart, *Geschichte der Württembergischen Feste Hohenasperg* (Stuttgart, 1858).

HOHENFRIEDBERG, or **HOHENFRIEDEBERG**, a village of Silesia, about 6 m. from the small town of Striegau. It gives its name to a battle (also called the battle of Striegau) in the War of the Austrian Succession, fought on the 3rd of June 1745 between the Prussians under Frederick the Great and the Austrians and Saxons commanded by Prince Charles of Lorraine. In May the king, whose army had occupied extended winter quarters in Silesia, had drawn it together into a position about Neisse whence he could manœuvre against the Austrians, whether they invaded Silesia by Troppau or Glatz, or joined their allies (who, under the duke of Weissenfels, were on the upper Elbe), and made their advance on Schweidnitz, Breslau or Liegnitz. On the Austrians concentrating towards the Elbe, Frederick gradually drew his army north-westward along the edge of the mountain country until on the 1st of June it was near Schweidnitz. At that date the Austro-Saxons were advancing (very slowly owing to the poorness of the roads and the dilatoriness of the Saxon artillery train) from Waldenburg

and Landshut through the mountains, heading for Striegau. After a few minor skirmishes at the end of May, Frederick had made up his mind to offer no opposition to the passage of the Allies, but to fall upon them as they emerged, and the Prussian army was therefore kept concentrated out of sight, while only selected officers and patrols watched the débouches of the mountains. On the other hand the Allies had no intention of delivering battle, but meant only, on emerging from the mountains, to take up a suitable camping position and thence to interpose between Breslau and the king, believing that "the king was at his wits' end, and, once the army really began its retreat on Breslau, there would be frightful consternation in its ranks." But in fact, as even the coolest observers noticed, the Prussian army was in excellent spirits and eager for the "decisive affair" promised by the king. On the 3rd of June, watched by the invisible patrols, the Austrians and Saxons emerged from the hills at Hohenfriedberg with bands playing and colours flying. Their advanced guard of infantry and cavalry spread out into the plain, making for a line of hills spreading north-west from Striegau, where the army was to



encamp. But the main body moved slowly, and at last Prince Charles and Weissenfels decided to put off the occupation of the line of hills till the morrow. The army bivouacked therefore in two separate wings, the Saxons (with a few Austrian regiments) between Günthersdorf and Pilgramshain, the Austrians near Hausdorf. They were about 70,000 strong, Frederick 65,000.

The king had made his arrangements in good time, aided by the enemy's slowness, and in the evening he issued simple orders to move. About 9 P.M. the Prussians marched off from Alt-Jauernick towards Striegau, the guns on the road, the infantry and cavalry, in long open columns of companies and squadrons, over the fields on either side—a night march well remembered by contrast with others as having been executed in perfect order. Meanwhile General Dumoulin, who commanded an advanced detachment between Striegau and Stanowitz, broke camp silently and moved into position below the hill north-west of Striegau, which was found to be occupied by Saxon light infantry outposts. The king's orders were for Dumoulin and the right wing of the main army to deploy and advance towards Häslicht against the Saxons, and for the left wing infantry to prolong the line from the marsh to Günthersdorf, covered by the left-wing cavalry on the plain near Thomaswaldau. On the side of the Austrians, the outlying hussars are said to have noticed and reported the king's movement, for the night was clear and starlit, but their report, if made, was ignored.

At 4 A.M. Dumoulin advanced on Pilgramshain, neglecting the fire of the Saxon outpost on the Spitzberg, whereupon

this promptly retired in order to avoid being surrounded. Dumoulin then posted artillery on the slope of the hill and deployed his six grenadier battalions facing the village. The leading cavalry of the main army came up and deployed on Dumoulin's left front in open rolling ground. Meantime the duke of Weissenfels had improvised a line of defence, posting his infantry in the marshy ground and about Pilgramshain, and his cavalry, partly in front of Pilgramshain and partly on the intervening space, opposite that of the Prussians. But before the marshy ground was effectively occupied by the duke's infantry, his cavalry had been first shaken by the fire of Dumoulin's guns on the Spitzberg and a heavy battery that was brought up on to the Gräbener Fuchsberg, and then charged by the Prussian right-wing cavalry, and in the mêlée the Allies were gradually driven in confusion off the battlefield. The cavalry battle was ended by 6.30 A.M., by which time Dumoulin's grenadiers, stiffened by the line regiment Anhalt (the "Old Dessauer's" own), were vigorously attacking the garden hedges and walls of Pilgramshain, and the Saxon and Austrian infantry in the marsh was being attacked by Prince Dietrich of Dessau with the right wing of the king's infantry. The line infantry of those days, however, did not work easily in bad ground, and the Saxons were steady and well drilled. After an hour's fight, well supported by the guns and continually reinforced as the rest of the army closed up, the prince expelled the enemy from the marsh, while Dumoulin drove the light troops out of Pilgramshain. By 7 A.M. the Saxons, forming the left wing of the allied army, were in full retreat.

While his allies were being defeated, Prince Charles of Lorraine had done nothing, believing that the cannonade was merely an outpost affair for the possession of the Spitzberg. His generals indeed had drawn out their respective commands in order of battle, the infantry south of Günthersdorf, the cavalry near Thomaswaldau, but they had no authority to advance without orders, and stood inactive, while, 1 m. away, the Prussian columns were debüching over the Striegau Water. This phase of the king's advance was the most delicate of all, and the moment that he heard from Prince Dietrich that the marsh was captured he stopped the northward flow of his battalions and swung them westward, the left wing cavalry having to cover their deployment. But when one-third of this cavalry only had crossed at Teichau the bridge broke. For a time the advanced squadrons were in great danger. But they charged boldly, and a disjointed cavalry battle began, during which (Ziethen's hussars having discovered a ford) the rest of the left-wing cavalry was able to cross. At last 25 intact squadrons under Lieut.-General von Nassau charged and drove the Austrians in disorder towards Hohenfriedberg. This action was the more creditable to the victors in that 45 squadrons in 3 separate fractions defeated a mass of 60 squadrons that stood already deployed to meet them.

Meanwhile the Prussian infantry columns of the centre and left had crossed Striegau Water and deployed to their left, and by 8.30 they were advancing on Günthersdorf and the Austrian infantry south of that place. Frederick's purpose was to roll up the enemy from their inner flank, and while Prince Dietrich, with most of the troops that had forced the Saxons out of the marsh, pursued Weissenfels, two regiments of his and one of Dumoulin's were brought over to the left wing and sent against the north side of Günthersdorf. In the course of the general forward movement, which was made in what was for those days a very irregular line, a wide gap opened up between the centre and left, behind which 10 squadrons of the Bayreuth dragoon regiment, with Lieut.-General von Gessler, took up their position. Thus the line advanced. The grenadiers on the extreme left cleared Thomaswaldau, and their fire galled the Austrian squadrons engaged in the cavalry battle to the south. Then Günthersdorf, attacked on three sides, was also evacuated by the enemy. But although Frederick rode back from the front saying "the battle is won," the Prussian infantry, in spite

of its superior fire discipline, failed for some time to master the defence, and suffered heavily from the eight close-range volleys they received, one or two regiments losing 40 and 50 % of their strength. The Austrians, however, suffered still more; feeling themselves isolated in the midst of the victorious enemy, they began to waver, and at the psychological moment Gessler and the Bayreuth dragoons charged into their ranks and "broke the equilibrium." These 1500 sabres scattered twenty battalions of the enemy and brought in 2500 prisoners and 66 Austrian colours, and in this astounding charge they themselves lost no more than 94 men. By nine o'clock the battle was over, and the wrecks of the Austro-Saxon army were retreating to the mountains. The Prussians, who had been marching all night, were too far spent to pursue.

The loss of the allies was in all 15,224, 7985 killed and wounded, and 7239 prisoners, as well as 72 guns and 83 standards and colours. The Prussians lost 4666 killed and wounded, 71 missing.

HOHENHEIM, a village of Germany, in the kingdom of Württemberg, 7 m. S. of Stuttgart by rail. Pop. 300. It came in 1768 from the counts of Hohenheim to the dukes of Württemberg, and in 1785 Duke Karl Eugen built a country house here. This house with grounds is now the seat of the most important agricultural college in Germany; it was founded in 1817, was raised to the position of a high school in 1865, and now ranks as a technical high school with university status.

See Fröhlich, *Das Schloss und die Akademie Hohenheim* (Stuttgart, 1870).

HOHENLIMBURG, a town of Germany, on the Lenne, in the Prussian prov. of Westphalia, 30 m. by rail S.E. of Dortmund. Pop. (1905) 12,790. It has two Evangelical churches, a Roman Catholic church and a synagogue. The town is the seat of various iron and metal industries, while dyeing, cloth-making and linen-weaving are also carried on here. It is the chief town of the county of Limburg, and formerly belonged to the counts of Limburg, a family which became extinct in 1508. Later it passed to the counts of Bentheim-Tecklenburg. The castle of Hohenlimburg, which overlooks the town, is now the residence of Prince Adolf of Bentheim-Tecklenburg.

HOHENLOHE, a German princely family which took its name from the district of Hohenlohe in Franconia. At first a county, its two branches were raised to the rank of principalities of the Empire in 1744 and 1764 respectively; in 1806 they lost their independence and their lands now form part of the kingdoms of Bavaria and of Württemberg. At the time of the mediatisation the area of Hohenlohe was 680 sq. m. and its estimated population was 108,000. The family is first mentioned in the 12th century as possessing the castle of Hohenloch, or Hohenlohe, near Uffenheim, and its influence was soon perceptible in several of the Franconian valleys, including those of the Kocher, the Jagst and the Tauber. Henry I. (d. 1183) was the first to take the title of count of Hohenlohe, and in 1230 his grandsons, Gottfried and Conrad, supporters of the emperor Frederick II., founded the lines of Hohenlohe—Hohenlohe and Hohenlohe-Brauneck, names taken from their respective castles. The latter became extinct in 1390, its lands passing later to Brandenburg, while the former was divided into several branches, only two of which, however, Hohenlohe-Weikersheim and Hohenlohe-Uffenheim-Speckfeld, need be mentioned here. Hohenlohe-Weikersheim, descended from Count Kraft I. (d. 1313), also underwent several divisions, that which took place after the deaths of Counts Albert and George in 1551 being specially important. At this time the lines of Hohenlohe-Neuenstein and Hohenlohe-Waldenburg were founded by the sons of Count George. Meanwhile, in 1412, the family of Hohenlohe-Uffenheim-Speckfeld had become extinct, and its lands had passed through the marriages of its heiresses into other families.

The existing branches of the Hohenlohe family are descended from the lines of Hohenlohe-Neuenstein and Hohenlohe-Waldenburg, established in 1551. The former of these became Protestant, while the latter remained Catholic. Of the family of Hohenlohe-Neuenstein, which underwent several partitions and inherited Gleichen in 1631, the senior line became extinct

in 1805, while in 1701 the junior line divided itself into three branches, those of Langenburg, Ingelfingen and Kirchberg. Kirchberg died out in 1861, but members of the families of Hohenlohe-Langenburg and Hohenlohe-Ingelfingen are still alive, the latter being represented by the branches of Hohenlohe-Ingelfingen and Hohenlohe-Öhringen. The Roman Catholic family of Hohenlohe-Waldenburg was soon divided into three branches, but two of these had died out by 1720. The surviving branch, that of Schillingsfürst, was divided into the lines of Hohenlohe-Schillingsfürst and Hohenlohe-Bartenstein; other divisions followed, and the four existing lines of this branch of the family are those of Waldenburg, Schillingsfürst, Jagstberg and Bartenstein. The family of Hohenlohe-Schillingsfürst possesses the duchies of Ratibor and of Corbie inherited in 1824.

The principal members of the family are dealt with below.

I. **FRIEDRICH LUDWIG**, prince of Hohenlohe-Ingelfingen (1746-1818), Prussian general, was the eldest son of Prince Johann Friedrich (d. 1796) of Hohenlohe-Ingelfingen, and began his military career as a boy, serving against the Prussians in the last years of the Seven Years' War. Entering the Prussian army after the peace (1763), he was on account of his rank at once made major, and in 1775 he became lieutenant-colonel; in 1778 he took part in the War of the Bavarian Succession and about the same time was made a colonel. Shortly before the death of Frederick the Great he was promoted to the rank of major-general and appointed chief of a regiment. For some years the prince did garrison duty at Breslau, until in 1791 he was made governor of Berlin. In 1794 he commanded a corps in the Prussian army on the Rhine and distinguished himself greatly in many engagements, particularly in the battle of Kaiserslautern on the 20th of September. He was at this time the most popular soldier in the Prussian army. Blücher wrote of him that "he was a leader of whom the Prussian army might well be proud." He succeeded his father in the principality, and acquired additional lands by his marriage with a daughter of Count von Hoym. In 1806 Hohenlohe now a general of infantry, was appointed to command the left-wing army of the Prussian forces opposing Napoleon, having under him Prince Louis Ferdinand of Prussia; but, feeling that his career had been that of a prince and not that of a scientific soldier, he allowed his quartermaster-general Massenbach to influence him unduly. Disputes soon broke out between Hohenlohe and the commander-in-chief, the duke of Brunswick, the armies marched hither and thither without effective results, and finally Hohenlohe's army was almost destroyed by Napoleon at Jena (see NAPOLEONIC CAMPAIGNS). The prince displayed his usual personal bravery in the battle, and managed to rally a portion of his corps near Erfurt, whence he retired into Prussia. But the pursuers followed him up closely, and, still acting under Massenbach's advice, he surrendered the remnant of his army at Prenzlau on the 28th of October, a fortnight after Jena and three weeks after the beginning of hostilities. Hohenlohe's former popularity and influence in the army had now the worst possible effect, for the commandants of garrisons everywhere lost heart and followed his example. After two years spent as a prisoner of war in France Hohenlohe retired to his estates, living in self-imposed obscurity until his death on the 15th of February 1818. He had, in August 1806, just before the outbreak of the French War, resigned the principality to his eldest son, not being willing to become a "mediatised" ruler under Württemberg suzerainty.

II. **LUDWIG ALOYSIUS**, prince of Hohenlohe-Waldenburg-Bartenstein (1765-1829), marshal and peer of France, was born on the 18th of August 1765. In 1784 he entered the service of the Palatinate, which he quitted in 1792 in order to take the command of a regiment raised by his father for the service of the emigrant princes of France. He greatly distinguished himself under Condé in the campaigns of 1792-1793, especially at the storming of the lines of Weissenburg. Subsequently he entered the service of Holland, and, when almost surrounded by the army of General Pichegru, conducted a masterly retreat from the island of Bommel. From 1794 to 1799 he served as

colonel in the Austrian campaigns; in 1799 he was named major-general by the archduke Charles; and after obtaining the rank of lieutenant-general he was appointed by the emperor governor of the two Galicias. Napoleon offered to restore to him his principality on condition that he adhered to the confederation of the Rhine, but as he refused, it was united to Württemberg. After Napoleon's fall in 1814 he entered the French service, and in 1815 he held the command of a regiment raised by himself, with which he took part in the Spanish campaign of 1823. In 1827 he was created marshal and peer of France. He died at Lunéville on the 30th of May 1839.

III. ALEXANDER LEOPOLD FRANZ EMMERICH, prince of Hohenlohe-Waldenburg-Schillingsfürst (1794-1849), priest and reputed miracle-worker, was born at Kupferzell, near Waldenburg, on the 17th of August 1794. By his mother, the daughter of an Hungarian nobleman, he was from infancy destined for the church; and she entrusted his early education to the ex-Jesuit Riel. In 1804 he entered the "Theresianum" at Vienna, in 1808 the academy at Bern, in 1810 the archiepiscopal seminary at Vienna, and afterwards he studied at Tyrsau and Ellwangen. He was ordained priest in 1815, and in the following year he went to Rome, where he entered the society of the "Fathers of the Sacred Heart." Subsequently, at Munich and Bamberg, he was blamed for Jesuit and obscurantist tendencies, but obtained considerable reputation as a preacher. His first co-called miraculous cure was effected, in conjunction with a peasant, Martin Michel, on a princess of Schwarzenberg who had been for some years paralytic. Immediately he acquired such fame as a performer of miraculous cures that multitudes from various countries flocked to partake of the beneficial influence of his supposed supernatural gifts. Ultimately, on account of the interference of the authorities with his operations, he went in 1821 to Vienna and then to Hungary, where he became canon at Grosswardein and in 1844 titular bishop of Sardica. He died at Vöslau near Vienna on the 17th of November 1849. He was the author of a number of ascetic and controversial writings, which were collected and published in one edition by S. Brunner in 1851.

IV. KRAFT, prince of Hohenlohe-Ingelfingen (1827-1892), soldier and military writer, son of Prince Adolf of Hohenlohe-Ingelfingen (1797-1873), was born at Koschentin in Upper Silesia. He was a nephew of the Prince Hohenlohe noticed above, who commanded the Prussians at Jena. Educated with great rigour, owing to the impoverishment of the family estates during the Napoleonic wars, he was sent into the Prussian army, and commissioned to the artillery at the least expensive arm of the service. He joined the Prussian Guard artillery in 1845, and it was soon discovered that he had unusual aptitudes as an artillery officer. For a time his brother officers resented the presence of a prince, until it was found that he made no attempt to use his social position to secure advancement. After serving as a military attaché in Vienna and on the Transylvanian frontier during the Crimean War, he was made a captain on the general staff, and in 1856 personal aide-de-camp to the king, remaining, however, in close touch with the artillery. In 1864, having become in the meanwhile successively major and lieutenant-colonel, he resigned the staff appointments to become commander of the new Guard Field Artillery regiment and in the following year he became colonel. In 1866 he saw his first real active service. In the bold advance of the Guard corps on the Austrian right wing at Königgrätz (see SEVEN WEEKS' WAR), he led the Guard reserve artillery with the greatest dash and success, and after the short war ended he turned his energies, now fortified by experience, to the better tactical training of the Prussian artillery. In 1868 he was made a major-general and assigned to command the Guard artillery brigade. In this capacity he gained great distinction during the Franco-German war and especially at Gravelotte and Sedan; he was in control of the artillery attack on the fortifications of Paris. In 1873 he was placed in command of an infantry division, and three years later was promoted lieutenant-general. He retired in 1879, was made general of infantry in 1883 and general of artillery

in 1889. His military writings were numerous, and amongst them several have become classics. These are *Briefe über Artillerie* (Eng. trans. *Letters on Artillery*, 1887); *Briefe über Strategie* (1897; Eng. trans. *Letters on Strategy*, 1898), and *Gespräche über Reiterci* (1887; Eng. trans. *Conversations on Cavalry*). The *Briefe über Infanterie* and *Briefe über Kavallerie* (translated into English, *Letters on Infantry*, *Letters on Cavalry*, 1889) are of less importance, though interesting as a reflection of prevailing German ideas. His memoirs (*As meinem Leben*) were prepared in retirement near Dresden, and the first volume (1897) created such a sensation that eight years were allowed to elapse before the publication was continued. Prince Kraft died near Dresden on the 16th of January 1892. (C. F. A.)

V. CHLODWIG KARL VIKTOR, prince of Hohenlohe-Schillingsfürst (1819-1901), statesman, was born on the 31st of March 1819 at Schillingsfürst in Bavaria. His father, Prince Franz Joseph (1787-1841), was a Catholic, his mother, Princess Konstanza of Hohenlohe-Langenburg, a Protestant. In accordance with the compromise customary at the time, Prince Chlodwig and his brothers were brought up in the religion of their father, while his sisters followed that of their mother. In spite of the difference of creed the family was very united, and it was to the spirit that rendered this possible that the prince owed his liberal and tolerant point of view, which was to exercise an important influence on his political activity. As the younger son of a cadet line of his house it was necessary for Prince Chlodwig to follow a profession. For a while he thought of obtaining a commission in the British army through the influence of his aunt, Princess Feodora of Hohenlohe-Langenburg (née princess of Leiningen), Queen Victoria's half-sister. He decided, however, to enter the Prussian diplomatic service. His application to be excused the preliminary steps, which involved several years' work in subordinate positions in the Prussian civil service, was refused by Frederick William IV., and the prince, with great good sense, decided to sacrifice his pride of rank and to accept the king's conditions. As auscultator in the courts at Coblenz he acquired a taste for jurisprudence, became a *Referendar* in September 1843, and after some months of travel in France, Switzerland and Italy went to Potsdam as a civil servant (May 13, 1844). These early years were invaluable, not only as giving him experience of practical affairs but as affording him an insight into the strength and weakness of the Prussian system. The immediate result was to confirm his Liberalism. The Prussian principle of "propagating enlightenment with a stick" did not appeal to him, he "recognized the confusion and want of clear ideas in the highest circles," the tendency to make agreement with the views of the government the test of loyalty to the state; and he noted in his journal (June 25, 1844) four years before the revolution of '48, "a slight cause and we shall have a rising." "The free press," he notes on another occasion, "is a necessity, progress the condition of the existence of a state." If he was an ardent advocate of German unity, and saw in Prussia the instrument for its attainment, he was throughout opposed to the "Prussification" of Germany, and ultimately it was he who made the unification of Germany possible by insisting at once on the principle of union with the North German states and at the same time on the preservation of the individuality of the states of the South.

On the 12th of November 1834 the landgrave Viktor Amadeus of Hesse-Rotenburg died, leaving to his nephews, the princes Viktor and Chlodwig Hohenlohe, his allodial estates: the duchy of Ratibor in Silesia, the principality of Corvey in Westphalia, and the lordship of Treffurt in the Prussian governmental district of Erfurt. On the death of Prince Franz Joseph on the 14th of January 1841 it was decided that the principality of Schillingsfürst should pass to the third brother, Philipp Ernst, as the two elder sons, Viktor and Chlodwig, were provided for already under their uncle's will, the one with the duchy of Ratibor, the other with Corvey and Treffurt. The youngest son, Gustav (b. February 28, 1823), the future cardinal, was destined for the Church. On the death of Prince Philipp Ernst

(May 3, 1845) a new arrangement was made: Prince Chlodwig became prince of Schillingfürst, while Corvey was assigned to the duke of Ratibor, Trefurt was subsequently sold by Prince Chlodwig, who purchased with the price large estates in Posen. This involved a complete change in Prince Chlodwig's career. His new position as a "reigning" prince and hereditary member of the Bavarian Upper House was incompatible with that of a Prussian official. On the 18th of April 1846 he took his seat as a member of the Bavarian *Reichsrath*, and on the 26th of June received his formal discharge from the Prussian service.

Save for the interlude of 1848 the political life of Prince Hohenlohe was for the next eighteen years not eventful. During the revolutionary years his sympathies were with the Liberal idea of a united Germany, and he compromised his chances of favour from the king of Bavaria by accepting the task (November 1, 1848) of announcing to the courts of Rome, Florence and Athens the accession to office of the Archduke John of Austria as regent of Germany. But he was too shrewd an observer to hope much from a national parliament which "wasted time in idle babble," or from a democratic victory which had stunned but not destroyed the German military powers. On the 16th of February 1847 he had married the Princess Marie of Sayn-Wittgenstein-Berleburg, the heiress to vast estates in Russia.¹ This led to a prolonged visit to Werki in Lithuania (1851-1853) in connexion with the management of the property, a visit repeated in 1860. In general this period of Hohenlohe's life was occupied in the management of his estates, in the sessions of the Bavarian *Reichsrath* and in travels. In 1856 he visited Rome, during which he noted the baneful influence of the Jesuits. In 1859 he was studying the political situation at Berlin, and in the same year he paid a visit to England. The marriage of his brother Konstantin in 1859 to another princess of Sayn-Wittgenstein-Berleburg led also to frequent visits to Vienna. Thus Prince Hohenlohe was brought into close touch with all the most notable people in Europe. At the same time, during this period (1850-1866) he was endeavouring to get into relations with the Bavarian government, with a view to taking a more active part in affairs. Towards the German question his attitude at this time was tentative. He had little hope of a practical realization of a united Germany, and inclined towards the tripartite divisions under Austria, Prussia and Bavaria—the so-called "Trias." He attended the *Fursten-tag* at Frankfort in 1863, and in the Schleswig-Holstein question was a supporter of the prince of Augustenburg. It was at this time that, at the request of Queen Victoria, he began to send her regular reports on the political condition of Germany.

Prince Hohenlohe's importance in history, however, begins with the year 1866. In his opinion the war was a blessing. It had demonstrated the insignificance of the small and middle states, "a misfortune for the dynasties"—with whose feelings a mediatized prince could scarcely be expected to be over-sympathetic—but the best possible good fortune for the German nation. In the Bavarian *Reichsrath* Hohenlohe now began to make his voice heard in favour of a closer union with Prussia, clearly, if such a union were desirable, he was the man in every way best fitted to prepare the way for it. One of the main obstacles in the way was the temperament of Louis II. of Bavaria, whose ideas of kingship were very remote from those of the Hohenzollerns, whose pride revolted from any concession to Prussian superiority, and who—even during the crisis of 1866—was more absorbed in operas than in affairs of state. Fortunately Richard Wagner was a politician as well as a composer, and equally fortunately Hohenlohe was a man of culture capable of appreciating "the master's" genius. It was Wagner, apparently, who persuaded the king to place Hohenlohe at the head of his government (*Denkwürdigkeiten*, i. 178, 211), and on the 31st of December 1866 the prince was duly appointed minister

¹ Through her mother, *née* Princess Stephanie Radziwill (d. 1832). Before Prince Wittgenstein's death (1887) a new law had forbidden foreigners to hold land in Russia. Prince Hohenlohe appears, however, to have sold one of his wife's estates and to have secured certain privileges from the Russian court for the rest.

of the royal house and of foreign affairs and president of the council of ministers.

As head of the Bavarian government Hohenlohe's principal task was to discover some basis for an effective union of the South German states with the North German Confederation, and during the three critical years of his tenure of office he was, next to Bismarck, the most important statesman in Germany. He carried out the reorganization of the Bavarian army on the Prussian model, brought about the military union of the southern states, and took a leading share in the creation of the customs parliament (*Zollparlament*), of which on the 28th of April 1868 he was elected a vice-president. During the agitation that arose in connexion with the summoning of the Vatican council Hohenlohe took up an attitude of strong opposition to the ultramontane position. In common with his brothers, the duke of Ratibor and the cardinal, he believed that the policy of Pius IX.—inspired by the Jesuits (that "devil's society," as he once called it)—of setting the Church in opposition to the modern State would prove ruinous to both, and that the definition of the dogma of papal infallibility, by raising the pronouncements of the Syllabus of 1864 into articles of faith, would commit the Church to this policy irrevocably. This view he embodied into a circular note to the Catholic powers (April 9, 1869), drawn up by Dollinger, inviting them to exercise the right of sending ambassadors to the council and to combine to prevent the definition of the dogma. The greater powers, however, were for one reason or another unwilling to intervene, and the only practical outcome of Hohenlohe's action was that in Bavaria the powerful ultramontane party combined against him with the Bavarian "patriots" who accused him of bartering away Bavarian independence to Prussia. The combination was too strong for him; a bill which he brought in for curbing the influence of the Church over education was defeated, the elections of 1869 went against him, and in spite of the continued support of the king he was forced to resign (March 7, 1870).

Though out of office, his personal influence continued very great both at Munich and Berlin and had not a little to do with favourable terms of the treaty of the North German Confederation with Bavaria, which embodied his views, and with its acceptance by the Bavarian parliament.² Elected a member of the German Reichstag, he was on the 23rd of March 1871 chosen one of its vice-presidents, and was instrumental in founding the new groups which took the name of the Liberal Imperial party (*Liberales Reichspartei*), the objects of which were to support the new empire, to secure its internal development on Liberal lines, and to oppose clerical aggression as represented by the Catholic Centre. Like the duke of Ratibor, Hohenlohe was from the first a strenuous supporter of Bismarck's anti-papal policy, the main lines of which (prohibition of the Society of Jesus, &c.) he himself suggested. Though sympathizing with the motives of the Old Catholics, however, he realized that they were doomed to sink into a powerless sect, and did not join them, believing that the only hope for a reform of the Church lay in those who desired it remaining in her communion.³ In 1872 Bismarck proposed to appoint Cardinal Hohenlohe Prussian envoy at the Vatican, but his views were too much in harmony with those of his family, and the pope refused to receive him in this capacity.⁴

In 1873 Bismarck chose Prince Hohenlohe to succeed Count Harry Arnim as ambassador in Paris, where he remained for seven years. In 1878 he attended the congress of Berlin as third German representative, and in 1880, on the death of Bernhard Ernst von Bülow (October 20), secretary of state for foreign affairs, he was called to Berlin as temporary head of the Foreign Office and representative of Bismarck during his

² Speech of December 30, 1870, in the *Reichsrath*. *Denkwürdigkeiten*, ii. 36.

³ "If I wished to leave the Church because of all the scandalous occurrences in the Catholic Church, I should have had to secede while studying Church history," *op. cit.* ii. 92.

⁴ Dr Johann Friedrich (*q.v.*), afterwards one of the Old Catholic leaders, was his secretary at the time of the Vatican council, and supplied historical and theological material to the opposition bishops.

absence through illness. In 1885 he was chosen to succeed Manteuffel as governor of Alsace-Lorraine. In this capacity he had to carry out the coercive measures introduced by the chancellor in 1887-1888, though he largely disapproved of them;¹ his conciliatory disposition, however, did much to reconcile the Alsace-Lorrainers to German rule. He remained at Strassburg till October 1894, when, at the urgent request of the emperor, he consented, in spite of his advanced years, to accept the chancellorship in succession to Caprivi. The events of his chancellorship belong to the general history of Germany (q.v.); as regards the inner history of this time the editor of his memoirs has very properly suppressed the greater part of the detailed comments which the prince left behind him. In general, during his term of office, the personality of the chancellor was less conspicuous in public affairs than in the case of either of his predecessors. His appearances in the Prussian and German parliaments were rare, and great independence was left to the secretaries of state. What influence the tact and experience of Hohenlohe exercised behind the scenes on the masterful will and impulsive character of the emperor cannot as yet be generally known.

Prince Hohenlohe resigned the chancellorship on the 17th of October 1900, and died at Ragaz on the 6th of July 1901. On the 16th of February 1897 he had celebrated his golden wedding; on the 21st of December of the same year the princess died. There were six children of the marriage: Elizabeth (b. 1847); Stephanie (b. 1851); Philipp Ernst, reigning prince of Hohenlohe-Schillingsfürst (b. 1853), who married Princess Charitél. Ypsilanti; Albert (1857-1866); Moritz and Alexander, twins (b. 1862).

All other authorities for the life of Prince Hohenlohe have been superseded by the *Denkwürdigkeiten* (3 vols., Stuttgart and Leipzig, 1906). With the exception noted above these are singularly full and outspoken, the latter quality causing no little scandal in Germany and bringing down on Prince Alexander, who was responsible for their publication, the disapproval of the emperor. They form not only the record of a singularly full and varied life, but are invaluable to the historian for the wealth of material they contain and for appreciations of men and events by an observer who had the best opportunities for forming a judgment. The prince himself they reveal not only as a capable man of affairs, though falling short of greatness, but as a personality of singular charm, tenacious of his principles, tolerant, broad-minded, and possessed of a large measure of the swing grace of humour.

See generally A. F. Fischer, *Geschichte des Hauses Hohenlohe* (1866-1871); K. Weller, *Hohenlohisches Urkundenbuch, 1153-1350* (Stuttgart, 1899-1901), and *Geschichte des Hauses Hohenlohe* (Stuttgart, 1904). (W. A. P.; C. F. A.)

HOHENSTAUFEN, the name of a village and ruined castle near Lorsch in Swabia, now in the kingdom of Württemberg, which gave its name to a celebrated Swabian family, members of which were emperors or German kings from 1138 to 1208, and again from 1214 to 1254. The earliest known ancestor was Frederick, count of Büren (d. 1094), whose son Frederick built a castle at Staufen, or Hohenstausen, and called himself by this name. He was a firm supporter of the emperor Henry IV., who rewarded his fidelity by granting him the dukedom of Swabia in 1079, and giving him his daughter Agnes in marriage. In 1081 he remained in Germany as Henry's representative, but only secured possession of Swabia after a struggle lasting twenty years. In 1105 Frederick was succeeded by his son Frederick II., called the One-eyed, who, together with his brother Conrad, afterwards the German king Conrad III., held south-west Germany for their uncle the emperor Henry V. Frederick inherited the estates of Henry V. in 1125, but failed to secure the throne, and took up an attitude of hostility towards the new emperor, Lothair the Saxon, who claimed some of the estates of the late emperor as crown property. A war broke out and ended in the complete submission of Frederick at Bamberg. He retained, however, his dukedom and estates. In 1138 Conrad of Hohenstausen was elected German king,

¹ He protested against the passport system as likely to lead to a war with France, for which he preferred not to be responsible. (Letter to Wilnowski, *Denkw.* ii. 433), but on the chancellor taking full responsibility consented to retain office.

and was succeeded in 1152, not by his son but by his nephew Frederick Barbarossa, son of his brother Frederick (d. 1147). Conrad's son Frederick inherited the duchy of Franconia which his father had received in 1115, and this was retained by the Hohenstausen until the death of Duke Conrad II. in 1196. In 1152 Frederick received the duchy of Swabia from his cousin the German king Frederick I., and on his death in 1167 it passed successively to Frederick's three sons Frederick, Conrad and Philip. The second Hohenstausen emperor was Frederick Barbarossa's son, Henry VI., after whose death a struggle for the throne took place between Henry's brother Philip, duke of Swabia, and Otto of Brunswick, afterwards the emperor Otto IV. Regained for the Hohenstausen by Henry's son, Frederick II., in 1214, the German kingdom passed to his son, Conrad IV., and when Conrad's son Conradin was beheaded in Italy in 1268, the male line of the Hohenstausen became extinct. Daughters of Philip of Swabia married Ferdinand III., king of Castile and Leon, and Henry II., duke of Brabant, and a daughter of Conrad, brother of the emperor Frederick I., married into the family of Guelph. The castle of Hohenstausen was destroyed in the 16th century during the Peasants' War, and only a few fragments now remain.

See F. von Raumer, *Geschichte der Hohenstausen und ihrer Zeit* (Leipzig, 1878); B. F. W. Zimmermann, *Geschichte der Hohenstausen* (Stuttgart, 1st ed. 1838; 2nd ed., 1865); F. W. Schirrmacher, *Die letzten Hohenstausen* (Göttingen, 1871).

HOHENSTEIN (Hohenstein-Ernstthal), a town of Germany, in the kingdom of Saxony, on the slopes of the Erzgebirge, and on the railway Reichenbach-Chemnitz, 12 m. N.E. of Zwickau. Pop. (1905) 13,903. Hohenstein possesses two fine Evangelical churches, a town hall, restored in 1876, and several monuments to famous men. The principal industries are the spinning and weaving of cotton, the manufacture of machines, stockings, gloves and woollen and silk fabrics, cotton printing and dyeing. Many of the inhabitants are also employed in the neighbouring copper and arsenic mines. Not far from Hohenstein there is a mineral spring, connected with which there are various kinds of baths. Hohenstein is the birthplace of the physicist G. H. von Schubert and of C. G. Schröter (1699-1782), one of the inventors of the pianoforte. Hohenstein consists of two towns, Hohenstein and Ernstthal, which were united in 1898.

Another place of the same name is a town in East Prussia. Pop. (1900) 2467. This Hohenstein, which was founded by the Teutonic Order in 1359, has a Roman Catholic and an Evangelical church, a synagogue and several educational establishments.

HOHENZOLLERN, the name of a castle which stood on the hill of Zollern about 1½ m. south of Hechingen, and gave its name to the family to which the present German emperor belongs. A vague tradition connects the house with the Colonna family of Rome, or the Colalto family of Lombardy; but one more definite unites the Hohenzollerns with the Burkhardingers, who were counts in Raetia during the early part of the 10th century, and two of whom became dukes of Swabia. Tassilo, a member of this family, is said to have built a castle at Zollern early in the 9th century; but the first historical mention of the name is in the *Chronicon* of a certain Berthold (d. 1088), who refers to Burkhard and Wezil, or Werner, of Zollern, or Zolorin. These men appear to have been counts of Zollern, and to have met their death in 1061. The family of Wezil died out in 1194, and the existing branches of the Hohenzollerns are descended from Burkhard and his son Frederick, whose eldest son, Frederick II., was in great favour with the German kings, Lothair the Saxon and Conrad III. Frederick II. died about 1245, and his son and successor, Frederick III., was a constant supporter of the Hohenstausen. This count married Sophia, daughter and heiress of Conrad, burgrave of Nuremberg, and about 1192 he succeeded his father-in-law as burgrave, obtaining also some lands in Austria and Franconia. He died about 1200, and his sons, Conrad and Frederick, ruled their lands in common until 1227, when an important division took place. Conrad became burgrave of Nuremberg, and, receiving the lands which

had come into the family through his mother, founded the Franconian branch of the family, which became the more important of the two; while Frederick, receiving the county of Zollern and the older possessions of the family, was the ancestor of the Swabian branch.

Early in the 12th century Burkhard, a younger son of Frederick I., secured the county of Hohenberg, and this district remained in the possession of the Hohenzollerns until the death of Count Sigismund in 1486. Its rulers, however, with the exception of Count Albert II. (d. 1298), played an unimportant part in German history. Albert, who was a Minnesinger, was loyal to the declining fortunes of the Hohenstaufen, and afterwards supported his brother-in-law, Rudolph of Habsburg, in his efforts to obtain the German throne. He shared in the campaigns of Rudolph and fell in battle in 1298, during the struggle between Adolph of Nassau and Albert of Habsburg (afterwards King Albert I.). When this family became extinct in 1486 Hohenberg passed to the Habsburgs.

The Franconian branch of the Hohenzollerns was represented in 1227 by Conrad, burgrave of Nuremberg, whom the emperor Frederick II. appointed guardian of his son Henry, and administrator of Austria. After a short apostasy, during which he supported Henry Raspe, landgrave of Thuringia, Conrad returned to the side of the Hohenstaufen and aided Conrad IV. He died in 1261, when his son and successor, the burgrave Frederick III., had already obtained Bayreuth through his marriage with Elizabeth, daughter of Otto of Meran (d. 1234). Frederick took a leading part in German affairs, and it is interesting to note that he had a considerable share in securing the election of his uncle, Rudolph of Habsburg, as German king in 1273. He died in 1297 and was succeeded by his son, Frederick IV. This burgrave fought for King Albert I. in Thuringia, and supported Henry VII. in his efforts to secure Bohemia for his son John; but in 1314, forsaking his father's policy, he favoured Louis, afterwards the emperor Louis IV., in his struggle with Frederick, duke of Austria, and by his conduct at the battle of Mühldorf in 1322 and elsewhere earned the designation of "saviour of the empire." Frederick, however, did not neglect his hereditary lands. He did something for the maintenance of peace and the security of traders, gave corporate privileges to villages, and took the Jews under his protection. His services to Louis were rewarded in various ways, and, using part of his wealth to increase the area of his possessions, he bought the town and district of Ansbach in 1331. Dying in 1332, Frederick was succeeded by his son, John II., who, after one of his brothers had died and two others had entered the church, ruled his lands in common with his brother Albert. About 1338 John bought Culmbach and Plassenburg, and on the strength of a privilege granted to him in 1347 he seized many robber-fortresses and held the surrounding lands as imperial fiefs. In general he continued his father's policy, and when he died in 1357 was succeeded by his son, Frederick V., who, after the death of his uncle Albert in 1361, became sole ruler of Nuremberg, Ansbach and Bayreuth. Frederick lived in close friendship with the emperor Charles IV., who formally invested him with Ansbach and Bayreuth and made him a prince of the empire in 1363. In spite of the troubled times in which he lived, Frederick was a successful ruler, and introduced a regular system of public finance into his lands. In 1397 he divided his territories between his sons John and Frederick, and died in the following year. His elder son, John III., who had married Margaret, a daughter of the emperor Charles IV., was frequently in the company of his brothers-in-law, the German kings Wenceslaus and Sigismund. He died without sons in 1420.

Since 1397 the office of burgrave of Nuremberg had been held by John's brother, Frederick, who in 1415 received Brandenburg from King Sigismund, and became margrave of Brandenburg as Frederick I. (q.v.). On his brother's death in 1420 he reunited the lands of his branch of the family, but in 1427 he sold his rights as burgrave to the town of Nuremberg. The subsequent history of this branch of the Hohenzollerns is identified with that of Brandenburg from 1415 to 1701, and with that of Prussia

since the latter date, as in this year the elector Frederick III. became king of Prussia. In 1871 William, the seventh king, took the title of German emperor. While the electorate of Brandenburg passed according to the rule of primogeniture, the Franconian possessions of the Hohenzollerns, Ansbach and Bayreuth, were given as appanages to younger sons, an arrangement which was confirmed by the *dispositio Achillea* of 1473. These principalities were ruled by the sons and descendants of the elector Albert Achilles from 1486 to 1603; and, after reverting to the elector of Brandenburg, by the descendants of the elector John George from 1603 to 1791. In 1791 Prince Charles Alexander (d. 1806), who had inherited both districts, sold his lands to Prussia.

The influence of the Swabian branch of the Hohenzollerns was weakened by several partitions of its lands; but early in the 16th century it rose to some eminence through Count Eitel Frederick II. (d. 1512), a friend and adviser of the emperor Maximilian I. Eitel received from this emperor the district of Haigerloch, and in 1534 his grandson Charles (d. 1576) was granted the counties of Sigmaringen and Vöhringen by the emperor Charles V. In 1576 the sons of Charles divided their lands, and founded three branches of the family, one of which is still flourishing. Eitel Frederick IV. took Hohenzollern with the title of Hohenzollern-Hechingen; Charles II. Sigmaringen and Vöhringen and the title of Hohenzollern-Sigmaringen; and Christopher took Haigerloch. Christopher's family died out in 1634, but the remaining lines are of some importance. Count John George of Hohenzollern-Hechingen was made a prince in 1623, and John of Hohenzollern-Sigmaringen soon received the same honour. In 1695 these two branches of the family entered conjointly into an agreement with Brandenburg, which provided that, in case of the extinction of either of the Swabian branches, the remaining branch should inherit its lands; and if both branches became extinct the principalities should revert to Brandenburg. During the 17th and 18th centuries and during the period of the Napoleonic wars the history of these lands was very similar to that of the other small estates of Germany. In consequence of the political troubles of 1848 Princes Frederick William of Hohenzollern-Hechingen and Charles Anton of Hohenzollern-Sigmaringen resigned their principalities, and accordingly these fell to the king of Prussia, who took possession on the 12th of March 1850. By a royal decree of the 20th of May following the title of "highness," with the prerogatives of younger sons of the royal house, was conferred on the two princes. The proposal to raise Prince Leopold of Hohenzollern-Sigmaringen (1835-1905) to the Spanish throne in 1870 was the immediate cause of the war between France and Germany. In 1908 the head of this branch of the Hohenzollerns, the only one existing besides the imperial house, was Leopold's son William (b. 1864), who, owing to the extinction of the family of Hohenzollern-Hechingen in 1869, was called simply prince of Hohenzollern. In 1866 Prince Charles of Hohenzollern-Sigmaringen was chosen prince of Rumania, becoming king in 1881.

The modern Prussian province of Hohenzollern is a long, narrow strip of territory bounded on the S.W. by Baden and in other directions by Württemberg. It was divided into two principalities, Hohenzollern-Sigmaringen and Hohenzollern-Hechingen, until 1850, when these were united. They now form the government of Sigmaringen (q.v.).

The castle of Hohenzollern was destroyed in 1423, but it has been restored several times. Some remains of the old building may still be seen adjoining the present castle, which was built by King Frederick William IV.

See *Monumenta Zollerana*, edited by R. von Stillfried and T. Marker (Berlin, 1852-1890); *Quellen und Untersuchungen zur Geschichte des Hauses Hohenzollern*, edited by E. Berner (Berlin, 1901 fol.); R. von Stillfried, *Altertümer und Kunstdenkmale des erlauchten Hauses von Hohenzollern* (Berlin, 1852-1867) and *Stammtafeln des Gesamthauses Hohenzollern* (Berlin, 1869); L. Schmid, *Die älteste Geschichte des erlauchten Gesamthauses der königlichen und fürstlichen Hohenzollern* (Tübingen, 1883-1888); E. Schwartz, *Stammtafel des preussischen Königshauses* (Breslau

1806): *Hohenollersche Forschungen. Jahrbuch für die Geschichte der Hohenollers*, edited by C. Meyer (Berlin, 1801-1902); *Hohenollers Jahrbuch, Forschungen und Abbildungen zur Geschichte der Hohenollers in Brandenburg-Preussen*, edited by Seidel (Leipzig, 1807-1903), and T. Carlyle, *History of Frederick the Great* (London, 1872-1873). (A. W. H.*)

HOKKAIDO, the Japanese name for the northern division of the empire (*Hoku* = north, *kai* = sea, and *do* = road), including Yezo, the Kuriles and their adjacent islets.

HOKUSAI (1760-1840), the greatest of all the Japanese painters of the Popular School (*Ukiyo-ye*), was born at Yedo (Tōkyō) in the 9th month of the 10th year of the period Hōreki, i.e. October-November 1760. He came of an artisan family, his father having been a mirror-maker, Nakajima Issai. After some practice as a wood-engraver he, at the age of eighteen, entered the studio of Katsugawa Shunshō, a painter and designer of colour-prints of considerable importance. His disregard for the artistic principles of his master caused his expulsion in 1785; and thereafter—although from time to time Hokusai studied various styles, including especially that of Shiba Gokan, from whom he gained some fragmentary knowledge of European methods—he kept his personal independence. For a time he lived in extreme poverty, and, although he must have gained sums for his work which might have secured him comfort, he remained poor, and to the end of his life proudly described himself as a peasant. He illustrated large numbers of books, of which the world-famous *Manga*, a pictorial encyclopaedia of Japanese life, appeared in fifteen volumes from 1812 to 1875. Of his colour-prints the "Thirty-six Views of Mount Fuji" (the whole set consisting of forty-six prints) were made between 1823 and 1829; "Views of Famous Bridges" (11), "Waterfalls" (8), and "Views of the Lu-chu Islands" (8), are the best known of those issued in series; but Hokusai also designed some superb broadsheets published separately, and his *surimono* (small prints made for special occasions and ceremonies) are unequalled for delicacy and beauty. The "Hundred Views of Mount Fuji" (1834-1835), 3 vols., in monochrome, are of extraordinary originality and variety. As a painter and draughtsman Hokusai is not held by Japanese critics to be of the first rank, but this verdict has never been accepted by Europeans, who place him among the greatest artists of the world. He possessed great powers of observation and characterization, a singular technical skill, an unflinching gift of good humour, and untiring industry. He was an eager student to the end of his long life, and on his death-bed said, "If Heaven had lent me but five years more, I should have become a great painter." He died on the 10th of May 1849.

See E. de Goncourt, *Hokusai* (1896); M. Revon, *Étude sur Hokusai* (1896); E. F. Fenollosa, *Catalogue of the Exhibition of Paintings by Hokusai at Tōkyō* (1901); E. F. Strange, *Hokusai* (1906). (E. F. S.)

HOLBACH, PAUL HEINRICH DIETRICH, BARON D' (1723-1789), French philosopher and man of letters, of German origin, was born at Heidelberg in the palatinate in 1723. Of his family little is known; according to J. J. Rousseau his father was a rich parvenu, who brought his son at an early age to Paris, where the latter spent most of his life. Much of Holbach's fame is due to his intimate connexion with the brilliant coterie of bold thinkers and polished wits whose creed, the new philosophy, is concentrated in the famous *Encyclopédie*. Possessed of easy means and being of hospitable disposition, he kept open house for Helvétius, D'Alembert, Diderot, Condillac, Turgot, Buffon, Grimm, Hume, Garrick, Wilkes, Sterne, and for a time J. J. Rousseau, guests who, while enjoying the intellectual pleasure of their host's conversation, were not insensible to his excellent cuisine and costly wines. For the *Encyclopédie* he compiled and translated a large number of articles on chemistry and mineralogy, chiefly from German sources. He attracted more attention, however, in the department of philosophy. In 1767 *Christianisme dévoilé* appeared, in which he attacked Christianity and religion as the source of all human evils. This was followed up by other works, and in 1770 by a still more open attack in his most famous book, *Le Système de la nature*, in which it

is probable he was assisted by Diderot. Denying the existence of a deity, and refusing to admit as evidence a priori arguments, Holbach saw in the universe nothing save matter in spontaneous movement. What men call their souls become extinct when the body dies. Happiness is the end of mankind. "It would be useless and almost unjust to insist upon a man's being virtuous if he cannot be so without being unhappy. So long as vice renders him happy, he should love vice." The restraints of religion were to be replaced by an education developing an enlightened self-interest. The study of science was to bring human desires into line with their natural surroundings. Not less direct and trenchant are his attacks on political government, which, interpreted by the light of after events, sound like the first distant mutterings of revolution. Holbach exposed the logical consequences of the theories of the Encyclopaedists. Voltaire hastily seized his pen to refute the philosophy of the *Système* in the article "Dieu" in his *Dictionnaire philosophique*, while Frederick the Great also drew up an answer to it. Though vigorous in thought and in some passages clear and eloquent, the style of the *Système* is diffuse and declamatory, and asserts rather than proves its statements. Its principles are summed up in a more popular form in *Bon Sens, ou idées naturelles opposées aux idées surnaturelles* (Amsterdam, 1772). In the *Système social* (1773), the *Politique naturelle* (1773-1774) and the *Moralité universelle* (1776) Holbach attempts to rear a system of morality in place of the one he had so fiercely attacked, but these later writings had not a tittle of the popularity and influence of his earlier work. He published his books either anonymously or under borrowed names, and was forced to have them printed out of France. The uprightness and sincerity of his character won the friendship of many to whom his philosophy was repugnant. J. J. Rousseau is supposed to have drawn his portrait in the virtuous atheist Wolmar of the *Nouvelle Héloïse*. He died on the 21st of January 1789.

Holbach is also the author of the following and other works: *Essai du déisme* (1767); *De l'impotence sacerdotale* (1767); *Prêtres démasqués* (1768); *Examen critique de la vie et des ouvrages de St Paul* (1770); *Histoire critique de Jésus-Christ* (1770), and *Ethocratie* (1776). For further particulars as to his life and doctrines see Grimm's *Correspondance littéraire*, &c. (1813); Rousseau's *Confessions*; Morellet's *Mémoires* (1821); Madame de Genlis, *Les Dîners du Baron Holbach*; Madame d'Épinay's *Mémoires*; Avezac-Lavigne, *Diderot et la société du Baron d'Holbach* (1875), and Morley's *Diderot* (1878).

HOLBACH, a market town in the Holland or Spalding parliamentary division of Lincolnshire, England, on the Midland and Great Northern joint railway, 23½ m. N.E. of Peterborough. Pop. of urban district (1901), 4755. All Saints' Church, with a lofty spire, is a fine specimen of late Decorated work. The grammar school, founded in 1669, occupies a building erected in 1877. Other public buildings are the assembly rooms and a market house. Roman and Saxon remains have been found, and the market dates from the 13th century.

HOLBEIN, HANS, the elder (c. 1460-1524), belonged to a celebrated family of painters in practice at Augsburg and Basel from the close of the 15th to the middle of the 16th century. Though closely connected with Venice by her commercial relations, and geographically nearer to Italy than to Flanders, Augsburg at the time of Maximilian cultivated art after the fashion of the Flemings, and felt the influence of the schools of Bruges and Brussels, which had branches at Cologne and in many cities about the headwaters of the Rhine. It was not till after the opening of the 16th century, and between that and the era of the Reformation, that Italian example mitigated to some extent the asperity of South German painting. Flemish and German art was first tempered with Italian elements at Augsburg by Hans Holbein the elder. Hans first appears at Augsburg as partner to his brother Sigismund, who survived him and died in 1540 at Berne. Sigismund is described as a painter, but his works have not come down to us. Hans had the lead of the partnership at Augsburg, and signed all the pictures which it produced. In common with Herlen, Schöngauer, and other masters of South Germany, he first cultivated a style

akin to that of Memlinc and other followers of the schools of Brussels and Bruges, but he probably modified the systems of those schools by studying the works of the masters of Cologne. As these early impressions waned, they were replaced by others less favourable to the expansion of the master's fame; and as his custom increased between 1499 and 1506, we find him relying less upon the teaching of the schools than upon a mere observation and reproduction of the quaintnesses of local passion plays. Most of his early works indeed are taken from the Passion, and in these he obviously marshalled his figures with the shallow stage effect of the plays, copying their artificial system of grouping, careless to some extent of proportion in the human shape, heedless of any but the coarser forms of expression, and technically satisfied with the simplest methods of execution. If in any branch of his art he can be said to have had a conscience at this period, we should say that he showed it in his portrait drawings. It is seldom that we find a painted likeness worthy of the name. The drawings of which numbers are still preserved in the galleries of Basel, Berlin and Copenhagen show extraordinary quickness and delicacy of hand, and a wonderful facility for seizing character; and this happily is one of the features which Holbein bequeathed to his more famous son, Hans the younger. It is between 1512 and 1522 that Holbein tempered the German quality of his style with some North Italian elements. A purer taste and more pleasing realism mark his work, which in drapery, dress and tone is as much more agreeable to the eye as in respect of modelling and finish it is smoother and more carefully rounded. Costume, architecture, ornament and colour are applied with some knowledge of the higher canons of art. Here, too, advantage accrued to Hans the younger, whose independent career about this time began.

The date of the elder Holbein's birth is unknown. But his name appears in the books of the tax-gatherers of Augsburg in 1494, superseding that of Michael Holbein, who is supposed to have been his father. Previous to that date, and as early as 1493, he was a painter of name, and he executed in that year, it is said, for the abbey at Weingarten, the wings of an altarpiece representing Joachim's Offering, the Nativity of the Virgin, Mary's Presentation in the Temple, and the Presentation of Christ, which now hang in separate panels in the cathedral of Augsburg. In these pieces and others of the same period, for instance in two Madonnas in the Moritz chapel and castle of Nuremberg, we mark the clear impress of the schools of Van der Weyden and Memlinc; whilst in later works, such as the Basilica of St Paul (1504) in the gallery of Augsburg, the wane of Flemish influence is apparent. But this altarpiece, with its quaint illustrations of St Paul's life and martyrdom, is not alone of interest because its execution is characteristic of old Holbein. It is equally so because it contains portraits of the master himself, accompanied by his two sons, the painters Ambrose (c. 1494-c. 1519) and Hans the younger. Later pictures, such as the Passion series in the Fürstenberg gallery at Donaueschingen, or the Martyrdom of St Sebastian in the Munich Pinakothek, contain similar portraits, the original drawings of which are found in old Holbein's sketch-book at Berlin, or in stray leaves like those possessed by the duke of Aumale in Paris. Not one of these fails to give us an insight into the character, or a reflex of the features, of the members of this celebrated family. Old Holbein seems to ape Leonardo, allowing his hair and beard to grow wildly, except on the upper lip. Hans the younger is a plain-looking boy. But his father points to him with his finger, and hints that though but a child he is clearly a prodigy.

After 1516 Hans Holbein the elder appears as a defaulter in the registers of the tax-gatherers at Augsburg; but he willingly accepts commissions abroad. At Issenheim in Alsace, where Grünewald was employed in 1516, old Holbein also finds patrons, and contracts to complete an altarpiece. But misfortune or a bailiff pursues him, and he leaves Issenheim, abandoning his work and tools. According to Sandrart, he wanders to Basel and takes the freedom of its gild. His brother Sigismund and others are found suing him for debt before the courts of Augsburg. Where he lived when he executed the altarpiece,

of which two wings with the date of 1522 are in the gallery of Carlsruhe, is uncertain; where he died two years later is unknown. He slinks from ken at the close of a long life, and disappears at last heeded by none but his own son, who claims his brushes and paints from the monks of Issenheim without much chance of obtaining them. His name is struck off the books of the Augsburg gild in 1524.

The elder Holbein was a prolific artist, who left many pictures behind him. Earlier than the Basilica of St Paul, already mentioned, is the Basilica of St Mary Maggiore, and a Passion in eleven pieces, in the Augsburg gallery, both executed in 1499. Another Passion, with the roof of Jesse and a tree of the Dominicans, is that preserved in the Staedel, Saalhof, and church of St Leonard at Frankfurt. It was executed in 1501. The Passion of Donaueschingen was finished after 1502, in which year was completed the Passion of Kaisheim, a conglomerate of twenty-seven panels, now divided amongst the galleries of Munich, Nuremberg, Augsburg and Schleissheim. An altarpiece of the same class, commissioned for the monastery of St Moritz at Augsburg in 1504-1508, has been dispersed and lost. 1512 is the date of a Conception in the Augsburg gallery, long assigned, in consequence of a forged inscription, to Hans Holbein the younger. A diptych, with a Virgin and Child, and a portrait of an old man, dated 1513, came in separate parts into the collections of Mr. Posonyi and Count Lanckoronski at Vienna. The sketch-books of Berlin, Copenhagen and Augsburg give a lively picture of the forms and dress of Augsburg residents at the beginning of the 16th century. They comprise portraits of the emperor Maximilian, the future Charles V., Kunz von der Rosen, the fool of Maximilian, the Fuggers, friars, merchants, and at rare intervals ladies.

See also the biography by Stödtner (Berlin, 1896).

HOLBEIN, HANS, the younger (1497-1543), German painter, favourite son of Hans Holbein the elder, was probably born at Augsburg about the year 1497. Though Sandrart and Van Mander declare that they do not know who gave him the first lessons, he doubtless received an artist's education from his father. About 1515 he left Augsburg with Ambrose, his elder brother, to seek employment as an illustrator of books at Basel. His first patron is said to have been Erasmus, for whom, shortly after his arrival, he illustrated with pen-and-ink sketches an edition of the *Encomium Moriae*, now in the museum of Basel. But his chief occupation was that of drawing titlepage-blocks and initials for new editions of the Bible and classics issued from the presses of Froben and other publishers. His leisure hours, it is supposed, were devoted to the production of rough painter's work, a schoolmaster's sign in the Basel collection, a table with pictures of St Nobody in the library of the university at Zurich. In contrast with these coarse productions, the portraits of Jacob Meyer and his wife in the Basel museum, one of which purports to have been finished in 1516, are miracles of workmanship. It has always seemed difficult indeed to ascribe such excellent creations to Holbein's nineteenth year; and it is hardly credible that he should have been asked to do things of this kind so early, especially when it is remembered that neither he nor his brother Ambrose were then allowed to matriculate in the guild of Basel. Not till 1517 did Ambrose, whose life otherwise remains obscure, join that corporation; Hans, not overburdened with practice, wandered into Switzerland, where (1517) he was employed to paint in the house of Jacob Hertenstein at Lucerne. In 1519 Holbein reappeared at Basel, where he matriculated and, there is every reason to think, married. Whether, previous to this time, he took advantage of his vicinity to the Italian border to cross the Alps is uncertain. Van Mander says that he never was in Italy; yet the large wall-paintings which he executed after 1519 at Basel, and the series of his sketches and pictures which is still extant, might lead to the belief that Van Mander was misinformed. The spirit of Holbein's compositions for the Basel town hall, the scenery and architecture of his numerous drawings, and the cast of form in some of his imaginative portraits, make it more likely that he should have felt the direct influence of North Italian painting than that he should have taken Italian elements from imported works or prints. The Swiss at this period wandered in thousands to swell the ranks of the French or imperial armies fighting on Italian soil, and the road they took may have been followed by Hans on a more peaceful mission. He shows himself at all events familiar with Italian examples

at various periods of his career; and if we accept as early works the "Flagellation," and the "Last Supper" at Basel, coarse as they are, they show some acquaintance with Lombard methods of painting, whilst in other pieces; such as the series of the Passion in oil in the same collection, the modes of Hans Holbein the elder are agreeably commingled with a more modern, it may be said Italian, polish. Again, looking at the "Virgin" and "Man of Sorrows" in the Basel museum, we shall be struck by a searching metallic style akin to that of the Ferrarese; and the "Lais" or the "Venus and Amor" of the same collection reminds us of the Leonardesques of the school of Milan. When Holbein settled down to an extensive practice at Basel in 1519, he decorated the walls of the house "Zum Tanz" with simulated architectural features of a florid character after the fashion of the Veronese; and his wall paintings in the town-hall, if we can truly judge of them by copies, reveal an artist not unfamiliar with North Italian composition, distribution, action, gesture and expression. In his drawings too, particularly in a set representing the Passion at Basel, the arrangement; and also the perspective, form and decorative ornament, are in the spirit of the school of Mantegna. Contemporary with these, however, and almost inexplicably in contrast with them as regards handling, are portrait-drawings such as the likenesses of Jacob Meyer, and his wife, which are finished with German delicacy, and with a power and subtlety of hand seldom rivalled in any school. Curiously enough, the same contrast may be observed between painted compositions and painted portraits. The "Bonifacius Amerbach" of 1519 at Basel is acknowledged to be one of the most complete examples of smooth and transparent handling that Holbein ever executed. His versatility at this period is shown by a dead Christ (1521), a corpse in profile on a dissecting table, and a set of figures in couples; the "Madonna and St Pantalus," and "Kaiser Henry with the Empress Kunigunde" (1522), originally composed for the organ loft of the Basel cathedral, now in the Basel museum. Equally remarkable, but more attractive, though injured, is the "Virgin and Child between St Ursus and St Nicholas" (not St Martin) giving alms to a beggar, in the gallery of Solothurn. This remarkable picture is dated 1522, and seems to have been ordered for an altar in the minster of St Ursus of Solothurn by Nicholas Conrad, a captain and statesman of the 16th century, whose family allowed the precious heirloom to fall into decay in a chapel of the neighbouring village of Grenchen. Numerous drawings in the spirit of this picture, and probably of the same period in his career, might have led Holbein's contemporaries to believe that he would make his mark in the annals of Basel as a model for painters of altarpieces as well as a model for pictorial composition and portrait. The promise which he gave at this time was immense. He was gaining a freedom in draughtsmanship that gave him facility to deal with any subject. Though a realist, he was sensible of the dignity and severity of religious painting. His colour had almost all the richness and sweetness of the Venetians. But he had fallen on evil times, as the next few years undoubtedly showed. Amongst the portraits which he executed in these years are those of Froben, the publisher, known only by copies at Basel and Hampton Court, and Erasmus, who sat in 1523, as he likewise did in 1530, in various positions, showing his face threequarters as at Longford, Basel, Turin, Parma, the Hague and Vienna, and in profile as in the Louvre or at Hampton Court. Besides these, Holbein made designs for glass windows, and for woodcuts, including subjects of every sort, from the Virgin and Child with saints of the old time to the Dance of Death, from gospel incidents extracted from Luther's Bible to satirical pieces illustrating the sale of indulgences and other abuses denounced by Reformers. Holbein, in this way, was carried irresistibly with the stream of the Reformation, in which, it must now be admitted, the old traditions of religious painting were wrecked, leaving nothing behind but unpictorial elements which Cranach and his school vainly used for pictorial purposes.

Once only, after 1526, and after he had produced the "Lais" and "Venus and Amor," did Holbein with impartial spirit give his services and pencil to the Roman Catholic cause. The burgo-

master Meyer, whose patronage he had already enjoyed, now asked him to represent himself and his wives and children in prayer before the Virgin; and Holbein produced the celebrated altarpiece now in the palace of Prince William of Hesse at Darmstadt, the shape and composition of which are known to all the world by its copy in the Dresden museum. The drawings for this masterpiece are amongst the most precious relics in the museum of Basel. The time now came when art began to suffer from unavoidable depression in all countries north of the Alps. Holbein, at Basel, was reduced to accept the smallest commissions—even for scutcheons. Then he saw that his chances were dwindling to nothing, and taking a bold resolution, armed with letters of introduction from Erasmus to More, he crossed the Channel to England, where in the one-sided branch of portrait painting he found an endless circle of clients. Eighty-seven drawings by Holbein in Windsor Castle, containing an equal number of portraits, of persons chiefly of high quality, testify to his industry in the years which divide 1528 from 1543. They are all originals of pictures that are still extant, or sketches for pictures that were lost or never carried out. Sir Thomas More, with whom he seems to have had a very friendly connexion, sat to him for likenesses of various kinds. The drawing of his head is at Windsor. A pen-and-ink sketch, in which we see More surrounded by all the members of his family, is now in the gallery of Basel, and numerous copies of a picture from it prove how popular the lost original must once have been. At the same period were executed the portraits of Warham (Lambeth and Louvre), Wyatt (Louvre), Sir Henry Guildford and his wife (Windsor), all finished in 1527, the astronomer Nicholas Kratzer (Louvre), Thomas Godsalve (Dresden), and Sir Bryan Tuke (Munich) in 1528. In this year, 1528, Holbein returned to Basel, taking to Erasmus the sketch of More's family. With money which he brought from London he purchased a house at Basel wherein to lodge his wife and children, whose portraits he now painted with all the care of a husband and father (1528). He then witnessed the flight of Erasmus and the fury of the iconoclasts, who destroyed in one day almost all the religious pictures at Basel. The municipality, unwilling that he should suffer again from the depression caused by evil times, asked him to finish the frescoes of the town-hall, and the sketches from these lost pictures are still before us to show that he had not lost the spirit of his earlier days, and was still capable as a composer. His "Rehoboam receiving the Israelite Envoys," and "Saul at the Head of his Array meeting Samuel," testify to Holbein's power and his will, also proved at a later period by the "Triumphs of Riches and Poverty," executed for the Steelyard in London (but now lost), to prefer the fame of a painter of history to that of a painter of portraits. But the reforming times still remained unfavourable to art. With the exception of a portrait of Melanchthon (Hanover) which he now completed, Holbein found little to do at Basel. The year 1530, therefore, saw him again on the move, and he landed in England for the second time with the prospect of bettering his fortunes. Here indeed political changes had robbed him of his earlier patrons. The circle of More and Warham was gone. But that of the merchants of the Steelyard took its place, for whom Holbein executed the long and important series of portraits that lie scattered throughout the galleries and collections of England and the Continent, and bear date after 1532. Then came again the chance of practice in more fashionable circles. In 1533 the "Ambassadors" (National Gallery), and the "Triumphs of Wealth and Poverty" were executed, then the portraits of Leland and Wyatt (Longford), and (1534) the portrait of Thomas Cromwell. Through Cromwell Holbein probably became attached to the court, in the pay of which he appears permanently after 1537. From that time onwards he was connected with all that was highest in the society of London. Henry VIII. invited him to make a family picture of himself, his father and family, which obtained a post of honour at Whitehall. The beautiful cartoon of a part of this fine piece at Hardwicke Hall enables us to gauge its beauty before the fire which destroyed it in the 17th century. Then Holbein painted Jane Seymour in state (Vienna), employing

some English hand perhaps to make the replicas at the Hague, Sion House and Woburn; he finished the Southwell of the *Uffizi* (copy at the Louvre), the jeweller Morett at Dresden, and last, not least, Christine of Denmark, who gave sittings at Brussels in 1538. During the journey which this work involved Holbein took the opportunity of revisiting Basel, where he made his appearance in silk and satin, and *pro forma* only accepted the office of town painter. He had been living long and continuously away from home, not indeed observing due fidelity to his wife, who still resided at Basel, but fairly performing the duties of keeping her in comfort. His return to London in autumn enabled him to do homage to the king in the way familiar to artists. He presented to Henry at Christmas a portrait of Prince Edward. Again abroad in the summer of 1539, he painted with great fidelity the princess Anne of Cleves, at Düren near Cologne, whose form we still see depicted in the great picture of the Louvre. That he could render the features of his sitter without flattery is plain from this one example. Indeed, habitual flattery was contrary to his habits. His portraits up to this time all display that uncommon facility for seizing character which his father enjoyed before him, and which he had inherited in an expanded form. No amount of labour, no laboriousness of finish—and of both he was ever prodigal—betrayed him into loss of resemblance or expression. No painter was ever quicker at noting peculiarities of physiognomy, and it may be observed that in none of his faces, as indeed in none of the faces one sees in nature, are the two sides alike. Yet he was not a child of the 16th century, as the Venetians were, in substituting touch for line. We must not look in his works for modulations of surface or subtle contrasts of colour in juxtaposition. His method was to the very last delicate, finished and smooth, as became a painter of the old school.

Amongst the more important creations of Holbein's later time we should note his "Duke of Norfolk" at Windsor, the hands of which are so perfectly preserved as to compensate for the shrivel that now disfigures the head. Two other portraits of 1541 (Berlin and Vienna), the Falconer at the Hague, and John Chambers at Vienna (1542), are noble specimens of portrait art; most interesting and of the same year are the likenesses of Holbein himself, of which several examples are extant—one particularly good at Föhna, the seat of the Stackelberg family near Riga, and another at the *Uffizi* in Florence. Here Holbein appears to us as a man of regular features, with hair just turning grey, but healthy in colour and shape, and evidently well to do in the world. Yet a few months only separated him then from his death-bed. He was busy painting a picture of Henry the VIII. confirming the Privileges of the Barber Surgeons (Lincoln's Inn Fields), when he sickened of the plague and died after making a will about November 1543. His loss must have been seriously felt in England. Had he lived his last years in Germany, he would not have changed the current which decided the fate of painting in that country; he would but have shared the fate of Dürer and others who merely prolonged the agony of art amidst the troubles of the Reformation. (J. A. C.)

The early authorities are Karel Van Mander's *Het Schilder Boek* (1604), and J. von Sandrart, *Accademia Toscana* (1675). See also R. H. Wornum, *Life and Work of Holbein* (1867); H. Knackfuss, *Holbein* (1899); G. S. Davies, *Holbein* (1903); A. F. G. A. Woltmann, *Holbein und seine Zeit* (1876).

HOLBERG, LUDVIG HOLBERG, BARON (1684-1754), the great Scandinavian writer, was born at Bergen, in Norway, on the 3rd of December 1684. Both Holberg's parents died in his childhood, his father first, leaving a considerable property; and in his eleventh year he lost his mother also. Before the latter event, however, the family had been seriously impoverished by a great fire, which destroyed several valuable buildings, but notwithstanding this, the mother left to each of her six children some little fortune. In 1695 the boy Holberg was taken into the house of his uncle, Peder Lem, who sent him to the Latin school, and prepared him for the profession of a soldier; but soon after this he was adopted by his cousin Otto Munthe, and went to him up in the mountains. His great

desire for instruction, however, at last induced his family to send him back to Bergen, to his uncle, and there he remained, eagerly studying, until the destruction of that city by fire in 1702, when he was sent to the university of Copenhagen. But he soon exhausted his resources, and, having nothing to live upon, was glad to hurry back to Norway, where he accepted the position of tutor in the house of a rural dean at Voss. He soon returned to Copenhagen, where in 1704 he took his degree, and worked hard at French, English and Italian. But he had to gain his living, and accordingly he accepted the post of tutor once more, this time in the house of Dr Smith, vice-bishop of Bergen. The good doctor had travelled much, and the reading of his itineraries and note-books awakened such a longing for travel in the young Holberg that at last, at the close of 1704, having scraped together 60 dollars, he went on board a ship bound for Holland. He proceeded as far as Aix-la-Chapelle, where he fell sick of a fever, and suffered so much from weakness and poverty, that he made his way on foot to Amsterdam, and came back to Norway. Ashamed to be seen so soon in Bergen, he stopped at Christianssand, where he lived through the winter, supporting himself by giving lessons in French. In the spring of 1706 he travelled, in company with a student named Brix, through London to Oxford, where he studied for two years, gaining his livelihood by giving lessons on the violin and the flute. He mentions, with gratitude, the valuable libraries of Oxford, and it is pleasant to record that it was while he was there that it first occurred to him, as he says, "how splendid and glorious a thing it would be to take a place among the authors." Through London and Elsinore he reached Copenhagen a third time, and began to lecture at the university; his lectures were attended, but he got no money. He was asked in 1709 to conduct a rich young gentleman to Dresden, and on his return journey he lectured at Leipzig, Halle and Hamburg. Once more in Copenhagen, he undertook to teach the children of Admiral Gedde. Weary with this work, he took a post at Borch College in 1710, where he wrote, and printed in 1711, his first work, *An Introduction to the History of the Nations of Europe*, and was permitted to present to King Frederick IV. two manuscript essays on Christian IV. and Frederick III. The king soon after presented him with the title of Professor, and with the Rosenkrantz grant of 100 dollars for four years, the holder of which was expected to travel. Holberg accordingly started in 1714, and visited, chiefly on foot, a great portion of Europe. From Amsterdam he walked through Rotterdam to Antwerp, took a boat to Brussels, and on foot again reached Paris. Walking and skating, he proceeded in the depth of winter to Marseilles, and on by sea to Genoa. On the last-mentioned voyage he caught a fever, and nearly died in that city. On his recovery he pushed on to Civita Vecchia and Rome. When the spring had come, being still very poor and in feeble health, he started homewards on foot by Florence, across the Apennines, through Bologna, Parma, Piacenza, Turin, over the Alps, through Savoy and Dauphiné to Lyons, and finally to Paris, where he arrived in excellent health. After spending a month in Paris, he walked on to Amsterdam, took sail to Hamburg, and so went back to Denmark in 1716. He spent the next two years in extreme poverty, and published his *Introduction to Natural and Popular Law*. But at last, in 1718, his talents were recognized by his appointment as professor of metaphysics at the university of Copenhagen; and in 1720 he was promoted to the lucrative chair of public eloquence, which gave him a seat in the consistory. His pecuniary troubles were now at an end. Hitherto he had written only on law, history and philology, although in a Latin controversy with the jurist Andreas Hojer of Flensburg his satirical genius had flashed out. But now, and until 1728, he created an entirely new class of humorous literature under the pseudonym of Hans Mikkelson. The serio-comic epic of *Peder Paars*, the earliest of the great classics of the Danish language, appeared in 1719. This poem was a brilliant satire on contemporary manners, and enjoyed an extraordinary success. But the author had offended in it several powerful persons who threatened his life, and if Count Danneberg had not personally interested the king in

him, Holberg's career might have had an untimely close. During the next two years he published five shorter satires, all of which were well received by the public. The great event of 1721 was the erection of the first Danish theatre in Grønnegade, Copenhagen; Holberg took the direction of this house, in which was played, in September 1722, a Danish translation of *L'Avare*. Until this time no plays had been acted in Denmark except in French and German, but Holberg now determined to use his talent in the construction of Danish comedy. The first of his original pieces performed was *Den politiske Kandestøber* (The Pewterer turned Politician), he wrote other comedies with miraculous rapidity, and before 1722 was closed, there had been performed in succession, and with immense success, *Den Vaegsindede* (The Waverer), *Jean de France*, *Jeppo paa Bjerget*, and *Gert the Westphalian*. Of these five plays, four at least are masterpieces; and they were almost immediately followed by others. Holberg took no rest, and before the end of 1723 the comedies of *Barselstuen* (The Lying-in Room), *The Eleventh of July*, *Jakob von Thyboe*, *Den Bundesløse* (The Fidget), *Erasmus Montanus*, *Don Ranudo*, *Ulysses of Ithaca*, *Without Head or Tail*, *Wickcraft* and *Melampe* had all been written, and some of them acted. In 1724 the most famous comedy that Holberg produced was *Henrik and Pernille*. But in spite of this unprecedented blaze of dramatic genius the theatre fell into pecuniary difficulties, and had to be closed, Holberg composing for the last night's performance, in February 1727, a *Funeral of Danish Comedy*. All this excessive labour for the stage had undermined the great poet's health, and in 1725 he had determined to take the baths at Aix-la-Chapelle; but instead of going thither he wandered through Belgium to Paris, and spent the winter there. In the spring he returned to Copenhagen with recovered health and spirits, and worked quietly at his protean literary labours until the great fire of 1728. In the period of national poverty and depression that followed this event, a puritanical spirit came into vogue which was little in sympathy with Holberg's dramatic or satiric genius. He therefore closed his career as a dramatic poet by publishing in 1731 his acted comedies, with the addition of five which he had no opportunity of putting on the stage. With characteristic versatility, he adopted the serious tone of the new age, and busied himself for the next twenty years with historical, philosophical and statistical writings. During this period he published his poetical satire called *Metamorphosis* (1726), his *Epistolae ad virum perillustrem* (1727), his *Description of Denmark and Norway* (1729), *History of Denmark*, *Universal Church History*, *Biographies of Famous Men*, *Moral Reflections*, *Description of Bergen* (1737), *A History of the Jews*, and other learned and laborious compilations. The only poem he published at this time was the famous *Nicolai Klimii iter subterraneum* (1741), afterwards translated into Danish by Baggesen. When Christian VI. died in 1747, pietism lost its sway; the theatre was reopened and Holberg was appointed director, but he soon resigned this arduous post. The six comedies he wrote in his old age did not add to his reputation. His last published work was his *Epistles*, in 5 vols. the last of them posthumous (1754). In 1747 he was created by the new king Baron of Holberg. In August 1753 he took to his bed, and he died at Copenhagen on the 28th of January 1754, in the seventieth year of his age. He was buried at Sorø, in Zealand. He had never married, and he bequeathed all his property, which was considerable, to Sorø College.

Holberg was not only the founder of Danish literature and the greatest of Danish authors, but he was, with the exception of Voltaire, the first writer in Europe during his own generation. Neither Pope nor Swift, who perhaps excelled him in particular branches of literary production, approached him in range of genius, or in encyclopaedic versatility. Holberg found Denmark provided with no books, and he wrote a library for her. When he arrived in the country, the Danish language was never heard in a gentleman's house. Polite Danes were wont to say that a man wrote Latin to his friends, talked French to the ladies, called his dogs in German, and only used Danish to swear at his servants. The single genius of Holberg revolutionized this

system. He wrote poems of all kinds in a language hitherto employed only for ballads and hymns; he instituted a theatre, and composed a rich collection of comedies for it; he filled the shelves of the citizens with works in their own tongue on history, law, politics, science, philology and philosophy, all written in a true and manly style, and representing the extreme attainment of European culture at the moment. Perhaps no author who ever lived has had so vast an influence over his countrymen, an influence that is still at work after 200 years.

The editions of Holberg's works are legion. Complete editions of the *Comedies* are too numerous to be quoted; the best is that brought out in 3 vols. by F. L. Lichtenberg, in 1870. Of *Feder Paars* there exist at least twenty-three editions, besides translations in Dutch, German and Swedish. The *Iter subterraneum* has been three several times translated into Danish, ten times into German, thrice into Swedish, thrice into Dutch, thrice into English, twice into French, twice into Russian and once into Hungarian. The life of Holberg was written by Welhaven in 1858 and by Georg Brandes in 1884. Among works on his genius by foreigners may be mentioned an exhaustive study by Robert Prutz (1857), and *Holberg considéré comme imitateur de Molière*, by A. Legraire (Paris, 1864). (E. G.)

HOLBORN, a central metropolitan borough of London, England, bounded N.W. by St Pancras, N.E. by Finsbury, S.E. by the City of London; S. and W. by the City of Westminster and St Marylebone. Pop. (1901), 59,405. Area 405.1 acres. Its main thoroughfare is that running E. and W. under the names of Holborn Viaduct, High Holborn and New Oxford Street.

The name of Holborn was formerly derived from Old Bourne, a tributary of the Fleet, the valley of which is clearly seen where Holborn Viaduct crosses Farringdon Street. Of the existence of this tributary, however, there is no evidence, and the origin of the name is found in *Hole-bourne*, the stream in the hollow, in allusion to the Fleet itself. The fall and rise of the road across the valley before the construction of the viaduct (1869) was abrupt and inconvenient. In earlier times a bridge here crossed the Fleet, leading from Newgate, while a quarter of a mile west of the viaduct is the site of Holborn Bars, at the entrance to the City, where tolls were levied. The better residential district of Holborn, which extends northward to Euston Road in the borough of St Pancras, is mainly within the parish of St George, Bloomsbury. The name of Bloomsbury is commonly derived from William Blemund, a lord of the manor in the 15th century. A dyke called Blemund's Ditch, of unknown origin, bounded it on the south, where the land was marshy. During the 18th century Bloomsbury was a fashionable and wealthy residential quarter. The reputation of the district immediately to the south, embraced in the parish of St Giles in the Fields, was far different. From the 17th century until modern times this was notorious as a home of crime and poverty. Here occurred some of the earliest cases of the plague which spread over London in 1664-1665. The opening of the thoroughfares of New Oxford Street (1840) and Shaftesbury Avenue (1855) by no means wholly destroyed the character of the district. The circus of Seven Dials, east of Shaftesbury Avenue, affords a typical name in connexion with the lowest aspect of life in London. A similar notoriety attached to Saffron Hill on the eastern confines of the borough. By a singular contrast, the neighbouring thoroughfare of Hatton Garden, leading north from Holborn Circus, is a centre of the diamond trade.

Of the ecclesiastical buildings of Holborn that of first interest is the chapel of St Etheldreda in Ely Place, opening from Holborn Circus. Ely Place takes its name from a palace of the bishops of Ely, who held land here as early as the 13th century. Here died John of Gaunt in 1399. The property was acquired by Sir Christopher Hatton, Lord Chancellor under Queen Elizabeth, after whom Hatton Garden is named; though the bishopric kept some hold upon it until the 18th century. The chapel, the only remnant of the palace, is a beautiful decorated structure with a vaulted crypt, itself above ground-level. Both are used for worship by Roman Catholics, by whom the chapel was acquired in 1874 and opened five years later after careful restoration. The present parish church of St Giles in the Fields, between Shaftesbury Avenue and New

Oxford Street, dates from 1734, but here was situated a leper's hospital founded by Matilda, wife of Henry I., in 1101. Its chapel became the parish church on the suppression of the monasteries. The church of St Andrew, the parish of which extends into the City, stands near Holborn Viaduct. It is by Wren, but there are traces of the previous Gothic edifice in the tower. Sacheverell was among its rectors (1713-1724), and Thomas Chatterton (1770) was interred in the adjacent burial ground, no longer extant, of Shoe Lane Workhouse; the register recording his Christian name as William. Close to this church is the City Temple (Congregational).

Two of the four Inns of Court, Lincoln's Inn and Gray's Inn, lie within the borough. Of the first the Tudor gateway opens upon Chancery Lane. The chapel, hall and residential buildings surrounding the squares within, are picturesque, but of later date. To the west lie the fine square, with public gardens, still called, from its original character, Lincoln's Inn Fields. Gray's Inn, between High Holborn and Theobald's Road, and west of Gray's Inn Road, is of similar arrangement. The fabric of the small chapel is apparently of the 14th century, and may have been attached to the manor house of Portpool, held at that period by the Lords Grey of Wilton. Of the former Inns of Chancery attached to these Inns of Court the most noteworthy buildings remaining are those of Staple Inn, of which the timbered and gabled Elizabethan front upon High Holborn is a unique survival of its character in a London thoroughfare; and of Barnard's Inn, occupied by the Mercer's School. Both these were attached to Gray's Inn. Of Furnival's and Thavies Inns, attached to Lincoln's Inn, only the names remain. The site of the first is covered by the fine red brick buildings of the Prudential Assurance Company, Holborn Viaduct. Among other institutions in Holborn, the British Museum, north of New Oxford Street, is pre-eminent. The varied collections of Sir John Soane, accumulated at his house in Lincoln's Inn Fields, are open to view as the Soane Museum. There may also be mentioned the Royal College of Surgeons, Lincoln's Inn Fields, with museum; the Royal Colleges of Organists, and of Veterinary Surgeons, the College of Preceptors, the Jews' College, and the Metropolitan School of Shorthand. Among hospitals are the Italian, the Homoeopathic, the National for the paralysed and epileptic, the Alexandra for children with hip disease, and the Hospital for sick children. The Foundling Hospital, Guilford Street, was founded by Thomas Coram in 1739.

HOLCROFT, THOMAS (1745-1809), English dramatist and miscellaneous writer, was born on the 10th of December 1745 (old style) in Orange Court, Leicester Fields, London. His father, besides having a shoemaker's shop, kept riding horses for hire; but having fallen into difficulties was reduced ultimately to the necessity of hawking pedlary. The son accompanied his parents in their tramps, and succeeded in procuring the situation of stable boy at Newmarket, where he spent his evenings chiefly in miscellaneous reading and the study of music. Gradually he obtained a knowledge of French, German and Italian. At the end of his term of engagement as stable boy he returned to assist his father, who had again resumed his trade of shoemaker in London; but after marrying in 1765, he became a teacher in a small school in Liverpool. He failed in an attempt to set up a private school, and became prompter in a Dublin theatre. He acted in various strolling companies until 1778, when he produced *The Crisis; or, Love and Famine*, at Drury Lane. *Duplicity* followed in 1781. Two years later he went to Paris as correspondent of the *Morning Herald*. Here he attended the performances of Beaumarchais's *Mariage de Figaro* until he had memorized the whole. The translation of it, with the title *The Polities of the Day*, was produced at Drury Lane in 1784. *The Road to Ruin*, his most successful melodrama, was produced in 1792. A revival in 1873 ran for 118 nights. Holcroft died on the 23rd of March 1809. He was a member of the Society for Constitutional Information, and on that account was, in 1794, indicted of high treason, but was discharged without a trial. Among his novels may be mentioned *Always*

(1780), an account, largely autobiographical, of a strolling comedian, and *Hugh Trevor* (1794-1797). He also was the author of *Travels from Hamburg through Westphalia, Holland and the Netherlands to Paris*, of some volumes of verse and of translations from the French and German.

His *Memoirs written by Himself and continued down to the Time of his Death, from his Diary, Notes and other Papers*, by William Hazlitt, appeared in 1816, and was reprinted, in a slightly abridged form, in 1852.

HOLDEN, HUBERT ASHTON (1822-1896), English classical scholar, came of an old Staffordshire family. He was educated at King Edward's school, Birmingham, and Trinity College, Cambridge (senior classic, 1845; fellow, 1847). He was vice-principal of Cheltenham College (1853-1858), and headmaster of Queen Elizabeth's school, Ipswich (1858-1883). He died in London on the 1st of December 1896. In addition to several school editions of portions of Cicero, Thucydides, Xenophon and Plutarch, he published an expurgated text of Aristophanes with a useful onomasticon (re-issued separately, 1902) and larger editions of Cicero's *De officiis* (revised ed., 1898) and of the *Octavius* of Minucius Felix (1853). His chief works, however, were his *Foliorum silvula* (1852), a collection of English extracts for translation into Greek and Latin verse; *Folia silvulae* (translations of the same); and *Foliorum centuriæ*, a companion volume of extracts for Latin prose translation. In English schools these books have been widely used for the teaching of Latin and Greek composition.

HOLDEN, SIR ISAAC, BART. (1807-1897), English inventor and manufacturer, was the son of Isaac Holden, a native of Cumberland, and was born at Hurlet, a village between Paisley and Glasgow, on the 7th of May 1807. His early life was passed in very straitened circumstances, but his father spared no pains to give him as much elementary education as possible. At the age of ten he began to work as weaver's draw-boy, and afterwards was employed in a cotton mill. Meanwhile his education was continued at the night schools, and from time to time, as funds allowed, he was taken from work and sent to the grammar-school, to which he at last went regularly for a year or two until he was fifteen, when his father removed to Paisley and apprenticed him to an uncle, a shawl-weaver there. This proving too much for his strength, in 1823 he became assistant teacher in a school at Paisley, and in 1828 he was appointed mathematical teacher in the Queen's Square Academy, Leeds. At the end of six months he was transferred to Lingard's grammar school, near Huddersfield, and shortly afterwards became classical master at Castle Street Academy, Reading. It was here that in 1829 he invented a lucifer match by adopting sulphur as the medium between the explosive material and the wood, but he refused to patent the invention. In 1830 his health again failed, and he returned to Scotland, where a Glasgow friend set up a school for him. After six months, however, he was recommended for the post of bookkeeper to Messrs. Townend Brothers, worsted manufacturers, of Cullingworth, where his interest in machinery soon led to his transfer from the counting-house to the mill. There his experiments led him to the invention of his square motion wool-comber and of a process for making genappe yarns, a patent for which was taken out by him in conjunction with S. C. Lister (Lord Masham) in 1847. The firm of Lister & Holden, which established a factory near Paris in 1848, carried on a successful business, and in 1859, when Lister retired, was succeeded by Isaac Holden and Sons, which became the largest wool-combing business in the world, employing upwards of 4000 workpeople. In 1865 Holden's medical advisers insisted on complete change of occupation, and he entered parliament as Liberal member for Knaresborough. From 1868 to 1882 he was without a seat, but in the latter year he was elected for the northern division of the West Riding, and in 1885 for Keighley. He was created a baronet in 1893, and died suddenly at Oakworth House, near Keighley, on the 13th of August 1897.

His son and heir, Sir Angus Holden, was in 1908 created a peer with the title of Baron Holden of Alston.

HÖLDERLIN, JOHANN CHRISTIAN FRIEDRICH (1770-1843), German poet, was born on the 20th of March 1770, at Lauffen on the Neckar. His mother removing, after a second marriage, to Nürtingen, he began his education at the classical school there. He was destined by his relations for the church, and with this view was later admitted to the seminaries at Denkendorf and Maulbronn. At the age of eighteen he entered as a student of theology the university of Tübingen, where he remained till 1793. He was already the writer of occasional verses, and had begun to sketch his novel *Hyperion*, when he was introduced in this year to Schiller, and obtained through him the post of tutor to the young son of Charlotte von Kalb. A year later he left this situation to attend Fichte's lectures, and to be near Schiller in Jena. The latter recognized in the young poet something of his own genius, and encouraged him by publishing some of his early writings in his periodicals *Die neue Thalia* and *Die Horen*. In 1796 Hölderlin obtained the post of tutor in the family of the banker J. F. Gontard in Frankfurt-on-Main. For Gontard's beautiful and gifted wife, Susette, the "Diotima" of his *Hyperion*, he conceived a violent passion; and she became at once his inspiration and his ruin. At the end of two years, during which time the first volume of *Hyperion* was published (1797), a crisis appears to have occurred in their relations, for the young poet suddenly left Frankfurt. In spite of ill-health, he now completed *Hyperion*, the second volume of which appeared in 1799, and began a tragedy, *Der Tod des Empedokles*, a fragment of which is published among his works. His friends became alarmed at the alternate depression and nervous irritability from which he suffered, and he was induced to go to Switzerland, as tutor in a family at Hauptwil. There his health improved; and several of his poems, among which are *Der blinde Sänger*, *An die Hoffnung* and *Dichternut*, were written at this time. In 1801 he returned home to arrange for the publication of a volume of his poems; but, on the failure of this enterprise, he was obliged to accept a tutorship at Bordeaux. "Diotima" died a year later, in June 1802, and the news is supposed to have reached Hölderlin shortly afterwards, for in the following month he suddenly left Bordeaux, and travelled homewards on foot through France, arriving at Nürtingen destitute and insane. Kind treatment gradually alleviated his condition, and in lucid intervals he occupied himself by writing verses and translating Greek plays. Two of these translations—the *Antigone* and *Oedipus rex* of Sophocles—appeared in 1804, and several of his short poems were published by Franz K. L. von Seckendorff in his *Musenalmanach*, 1807 and 1808. In 1804 Hölderlin obtained the sinecure post of librarian to the landgrave Frederick V. of Hesse-Homburg, and went to live in Homburg under the supervision of friends; but two years later becoming irremediably but harmlessly insane, he was taken in the summer of 1807 to Tübingen, where he remained till his death on the 7th of June 1843.

Hölderlin's writings are the production of a beautiful and sensitive mind; but they are intensely, almost morbidly, subjective, and they lack real human strength. Perhaps his strongest characteristic was his passion for Greece, the result of which was that he almost entirely discarded rhyme in favour of the ancient verse measures. His poems are all short pieces; of his tragedy only a fragment was written. *Hyperion, oder der Eremit in Griechenland* (1797-1799), is a romance in letters, in which the stormy fervour of the "Sturm und Drang" is combined with a romantic enthusiasm for Greek antiquity. The interest centres not in the story, for the novel has little or none—Hyperion is a young Greek who takes part in the rising of his people against the Turks in 1770—but in its lyric subjectivity and the dithyrambic beauty of its language.

Hölderlin's lyrics, *Lyrische Gedichte*, were edited by L. Uhland and G. Schwab in 1826. A complete edition of his works, *Sämmtliche Werke*, with a biography by C. T. Schwab, appeared in 1846; also *Dichtungen* by K. Köstlin (Tübingen, 1864), and (the best edition) *Gesammelte Dichtungen* by B. Litzmann (2 vols., Stuttgart, 1897). For biography and criticism, see C. C. T. Litzmann, *F. Hölderlins Leben* (Berlin, 1890), A. Wilbrandt, *Hölderlin* (2nd ed., Berlin, 1891), and C. Müller, *Friedrich Hölderlin, sein Leben und sein Dichten* (Bremen, 1894).

HOLDERNESSE, EARL OF, an English title borne by Sir John Ramsay and later by the family of Darcy. John Ramsay (c. 1580-1626), a member of the Scottish family of Ramsay of Dalhousie, was knighted for his share in rescuing James VI. from the hands of John Ruthven, earl of Gowrie, in August 1600. In 1606 the king created him Viscount Haddington and Lord Ramsay of Barns, and in 1621 made him an English peer as earl of Holdernesse. Ramsay died without surviving issue in February 1626, when his titles became extinct. In 1644 Charles I. created his nephew, Prince Rupert, earl of Holdernesse, but when the prince died unmarried in November 1683 the earldom again became extinct. Conyers Darcy (1599-1689), who was made earl of Holdernesse in 1682 only a few days after the death of Rupert, was the son and heir of Conyers Darcy, Lord Darcy and Conyers (c. 1571-1654), and succeeded his father in these baronies in March 1654. He was succeeded as 2nd earl by his only son Conyers (c. 1620-1692), who was member of parliament for Yorkshire during the reign of Charles II. In his turn he was succeeded by his grandson Robert (1681-1722). Robert's only son, Robert Darcy, 4th earl of Holdernesse (1718-1778), was a diplomatist and a politician. From 1744 to 1746 he was ambassador at Venice and from 1749 to 1751 he represented his country at the Hague. In 1751 he became one of the secretaries of state, and he remained in office until March 1761, when he was dismissed by George III. From 1771 to 1776 he acted as governor to two of the king's sons, a "solemn phantom" as Horace Walpole calls him. He left no sons, and all his titles became extinct except the barony of Conyers, which had been created by writ in 1509 in favour of his ancestor Sir William Conyers (d. 1525). This descended to his only daughter Amelia (1754-1784), the wife of Francis Osborne, afterwards 5th duke of Leeds, and when the 7th duke of Leeds died in 1859 it passed to his nephew, Sackville George Lane-Fox (1827-1888), falling into abeyance on his death. Hornby castle in Yorkshire, now the principal seat of the dukes of Leeds, came to them through marriage of the 5th duke with the heiress of the families of Conyers and of Darcy.

HOLDHEIM, SAMUEL (1806-1860), Jewish rabbi, a leader of reform in the German Synagogue, was born in Posen in 1806 and died in Berlin in 1860. In 1836 he was appointed rabbi at Frankfurt-on-the-Oder, in 1840 he was transferred to the rabbinate of Mecklenburg-Schwerin. He then became prominent as an advocate on the one hand of religious freedom (much trammelled at the time by Prussian state laws) and on the other of reform within the Jewish community. Various rabbinical conferences were held, at Brunswick (1844), Frankfurt-on-the-Main (1845) and Breslau (1846). At all of these Holdheim was a strong supporter of the policy of modifying ritual (especially with regard to Sabbath observance, marriage laws and liturgical customs). In 1846 he was chosen Rabbi of the new Berlin congregation and there exercised considerable influence on the course of Jewish reform.

See I. H. Ritter in the *Jewish Quarterly Review*, i. 202. The same authority has written the life of Holdheim in vol. iii. of his *Geschichte der jüdischen Reformation* (Berlin, 1865). Graetz in his *History* passes an unfavourable judgment on Holdheim, and there were admittedly grounds for opposition to Holdheim's attitude. A moderate criticism is contained in Dr D. Philipson's *History of the Reform Movement in Judaism* (London, 1906).

HOLGUÍN, a town of the high plateau country in the interior of Oriente province, Cuba, about 65 m. N.W. of Santiago de Cuba. Pop. (1907) 7592. The town is near the Marañon and Jigüé rivers, on a plain from which hills rise on all sides except the E., on which side it is open to the winds of the plateau. Holguín was long the principal acclimatization station for Spanish troops. The oldest public buildings are two churches built in 1800 and 1809 respectively. Holguín has trade in cabinet woods, tobacco, Indian corn and cattle products, which it exports through its port Gibara, about 25 m. N.N.E., with which it is connected by railway. Holguín was settled about 1720 and became a *ciudad* (city) in 1751. In the Ten Years' War of 1868-78 and in the revolution of 1895-98 Holguín was an insurgent centre.

HOLIDAY, originally the "holy day," a festival set apart for religious observances as a memorial of some sacred event or sacred person; hence a day on which the ordinary work or business ceases. For the religious sense see **FEASTS AND FESTIVALS**, and **SUNDAY**. Apart from the use of the term for a single day of rest or enjoyment, it is commonly used in the plural for a recognized and regular period (as at schools, &c.) of absence from work. It is unnecessary here to deal with what may be regarded as private holidays, which are matters of agreement between employer and employed or between the authorities of this or that institution and those who attend it. In recent years there has been a notable tendency in most occupations to shorten the hours of labour, and make holidays more regular. It will suffice to deal here with public holidays, the observance of which is prescribed by the state. In one respect these have been diminished, in so far as saints' days are no longer regarded as entailing non-attendance at the government offices in England, as was the case at the beginning of the 19th century. But while the influence of religion in determining such holidays has waned, the importance of making some compulsory provision for social recreation has made itself felt. In England four days, known as Bank Holidays (*q.v.*), are set apart by statute to be observed as general holidays, while the sovereign may by proclamation appoint any day to be similarly observed. Endeavours have been made from time to time to get additional days recognized as general holidays, such as Empire Day (May 24th), Arbor Day, &c. In the British colonies there is no uniform practice. In Canada eight days are generally observed as public holidays: New Year's Day, Good Friday, Easter Monday, Christmas Day, the birthday of the sovereign, Victoria Day, Dominion Day and Labour Day. Some of the provinces have followed the American example by adding an Arbor Day. Alberta and Saskatchewan observe Ash Wednesday. In Quebec, where the majority of the population is Roman Catholic, the holy days are also holidays, namely, the Festival of the Epiphany, Ash Wednesday, Good Friday, Easter Monday, the Ascension, All Saint's Day, Conception Day, Christmas Day. In 1897 Labour Day was added. In New South Wales, the 1st of January, Good Friday, Easter Eve, Easter Monday, the birthday of the sovereign, the 1st of August, the birthday of the prince of Wales, Christmas Day and the 26th of December, are observed as holidays. In Victoria there are thirteen public holidays during the year, and in Queensland fourteen. In New Zealand the public holidays are confined to four; Christmas Day, New Year's Day, Good Friday and Labour Day. In most of the other British colonies the usual number of public holidays is from six to eight.

In the United States there is no legal holiday in the sense of the English bank holidays. A legal holiday is dependent upon state and territorial legislation. It is usual for the president to proclaim the last Thursday in November as a day of thanksgiving; this makes it only a legal holiday in the District of Columbia, and in the territories, but most states make it a general holiday. Independence Day (July 4th) and Labour Day (first Monday in September) are legal holidays in most states. There are other days which, in connexion with particular events or in remembrance of particular persons, have been made legal holidays by particular states. For example, Lincoln's birthday, Washington's birthday, Memorial Day (May 30th), Patriots' Day (April 19th, Maine and Mass.), R. E. Lee's birthday (Jan. 19th, Ala., Fla., Ga., Va.), Pioneers' Day (July 24th, Utah), Colorado Day (Aug. 1st), Battle of New Orleans (Jan. 8th, La.), Bennington Battle Day (Aug. 16th, Vt.), Defenders' Day (Sept. 12th, Md.), Arbor Day (April 22nd, Nebraska; second Friday in May R.I., &c.), Admission Day (September 9th, Cal.; Oct. 31st, Nev.), Confederate Memorial Day (April 26th, Ala., Fla., Ga., Miss., May 10th, N. & S. Car., June 3rd, La., Miss., Texas), &c.

See M'Curdy, *Bibliography of Articles relating to Holidays* (Boston, 1905).

HOLLINSHED (or **HOLLINGSHEAD**), **RAPHAEL** (d. c. 1580), English chronicler, belonged probably to a Cheshire family, and according to Anthony Wood was educated at one of the English

universities, afterwards becoming a "minister of God's Word." The authenticity of these facts is doubtful, although it is possible that Raphael was the Hollinshed who matriculated from Christ's College, Cambridge, in 1544. About 1560 he came to London and was employed as a translator by Reginald or Reyner Wolfe, to whom he says he was "singularly beholden." Wolfe was already engaged in the preparation of a universal history, and Hollinshed worked for some years on this undertaking; but after Wolfe's death in 1573 the scope of the work was abridged, and it appeared in 1578 as the *Chronicles of England, Scotland, and Ireland*. The work was in two volumes, which were illustrated, and although Hollinshed did a great deal of the work he received valuable assistance from William Harrison (1534-1593) and others, while the part dealing with the history of Scotland is mainly a translation of Hector Boece's *Scotorum historie*. Afterwards, as is shown by his will, Hollinshed served as steward to Thomas Burdet of Bramcote, Warwickshire, and died about 1580.

A second edition of the *Chronicles*, enlarged and improved but without illustrations, which appeared in 1587, contained statements which were offensive to Queen Elizabeth and her advisers, and immediately after publication some of the pages were excised by order of the privy council. These excisions were published separately in 1723. An edition of the *Chronicles*, in accordance with the original text, was published in six volumes in 1808. The work contains a large amount of information, and shows that its compilers were men of great industry; but its chief interest lies in the fact that it was largely used by Shakespeare and other Elizabethan dramatists; Shakespeare, who probably used the edition of 1587, obtaining from the *Chronicles* material for most of his historical plays, and also for *Macbeth*, *King Lear* and part of *Cymbeline*. A single manuscript by Hollinshed is known to be extant. This is a translation of Florence of Worcester, and is in the British Museum. See W. G. Boswell-Stone, *Shakespeare's Hollinshed. The Chronicle and the historical play compared* (London, 1896).

HOLKAR, the family name of the Mabratta ruler of Indore (*q.v.*), which has been adopted as a dynastic title. The termination *-kar* implies that the founder of the family came from the village of Hol near Poona.

HOLL, FRANK (1845-1888), English painter, was born in London on the 4th of July 1845, and was educated chiefly at University College School. He was a grandson of William Holl, an engraver of note, and the son of Francis Holl, A.R.A., another engraver, whose profession he originally intended to follow. Entering the Royal Academy schools as a probationer in painting in 1860, he rapidly progressed, winning silver and gold medals, and making his debut as an exhibitor in 1864 with "A Portrait" and "Turned out of Church," a subject picture. "A Fern Gatherer" (1865); "The Ordeal" (1866); "Convalescent" (the somewhat grim pathos of which attracted much attention), and "Faces in the Fire" (1867), succeeded. Holl gained the travelling studentship in 1868; the successful work was characteristic of the young painter's mood, being "The Lord gave, and the Lord hath taken away." His insatiable zeal for work of all kinds began early to undermine the artist's health, but his position was assured by the studentship picture, which created a sort of *furor*, although, as with most of his works, the blackness of its coloration, probably due to his training as an engraver, was even more decidedly against it than the sadness of its theme. Otherwise, this painting exhibited nearly all the best technical qualities to which he ever attained, except high finish and clearness, and a very sincere vein of pathos. Holl was much below Millais in portraiture, and far inferior in all the higher ways of design; in technical resources, relatively speaking, he was but scantily provided. The range of his studies and the manner of his painting were narrower than those of Josef Israels, with whom, except as a portrait-painter, he may better be compared than with Millais. In 1870 he painted "Better is a Dinner of Herbs where Love is, than a Stalled Ox and Hatred therewith"; "No Tidings from the Sea," a scene in a fisherman's cottage, in 1871—a story told with breath-catching pathos and power; "I am the Resurrection and the Life" (1872); "Leaving Home" (1873), "Deserted" (1874), both of which had great success; "Her First-born," girls carrying a baby to the grave (1876); and "Going Home" (1877). In 1877 he painted the two pictures "Hush" and

"Hushed." "Newgate, Committed for Trial," a very sad and telling piece, first attested the breaking down of the painter's health in 1878. In this year he was elected A.R.A., and exhibited "The Gifts of the Fairies," "The Daughter of the House," "Absconded," and a very fine portrait of Samuel Cosins, the mezzotint engraver. This last canvas is a masterpiece, and deserved the success which attended the print engraved from it. Holl was overwhelmed with commissions, which he would not decline. The consequences of this strain upon a constitution which was never strong were more or less, though unequally, manifest in "Ordered to the Front," a soldier's departure (1880); "Home Again," its sequel, in 1883 (after which he was made R.A.). In 1886 he produced a portrait of Millais as his diploma work, but his health rapidly declined and he died at Hampstead, on the 31st of July 1888. Holl's better portraits, being of men of rare importance, attest the commanding position he occupied in the branch of art he so unflinchingly followed. They include likenesses of Lord Roberts, painted for queen Victoria (1882); the prince of Wales, Lord Dufferin, the duke of Cleveland (1885); Lord Overstone, Mr Bright, Mr Gladstone, Mr Chamberlain, Sir J. Tenniel, Earl Spencer, Viscount Cranbrook, and a score of other important subjects. (F. G. S.)

HOLLAND, CHARLES (1735-1769), English actor, was born in Chiswick, the son of a baker. He made his first appearance on the stage in the title rôle of *Orosoko* at Drury Lane in 1755, John Palmer, Richard Yates and Mrs Cibber being in the cast. He played under Garrick, and was the original Florizel in the latter's adaptation of Shakespeare's *Winter's Tale*. Garrick thought highly of him, and wrote a eulogistic epitaph for his monument in Chiswick church.

His nephew, Charles Holland (1768-1849) was also an actor, who played with Mrs Siddons and Kean.

HOLLAND, SIR HENRY, BART. (1788-1873), English physician and author, was born at Knutsford, Cheshire, on the 27th of October 1788. His maternal grandmother was the sister of Josiah Wedgwood, whose grandson was Charles Darwin; and his paternal aunt was the mother of Mrs Gaskell. After spending some years at a private school at Knutsford, he was sent to a school at Newcastle-on-Tyne, whence after four years he was transferred to Dr J. P. Estlin's school near Bristol. There he at once took the position of head boy, in succession to John Cam Hobhouse, afterwards Lord Broughton, an honour which required to be maintained by physical prowess. On leaving school he became articled clerk to a mercantile firm in Liverpool, but, as the privilege was reserved to him of passing two sessions at Glasgow university, he at the close of his second session sought relief from his articles, and in 1806 began the study of medicine in the university of Edinburgh, where he graduated in 1811. After several years spent in foreign travel, he began practice in 1816 as a physician in London—according to his own statement, "with a fair augury of success speedily and completely fulfilled." This "success," he adds, "was materially aided by visits for four successive years to Spa, at the close of that which is called the London season." It must also, however, be in a great degree attributed to his happy temperament and his gifts as a conversationalist—qualities the influence of which, in the majority of cases belonging to his class of practice, is often of more importance than direct medical treatment. In 1816 he was elected F.R.S., and in 1828 F.R.C.S. He became physician in ordinary to Prince Albert in 1840, and was appointed in 1852 physician in ordinary to the queen. In April 1853 he was created a baronet. He was also a D.C.L. of Oxford and a member of the principal learned societies of Europe. He was twice married, his second wife being a daughter of Sydney Smith, a lady of considerable literary talent, who published a biography of her father. Sir Henry Holland at an early period of his practice resolved to devote to his professional duties no more of his time than was necessary to secure an income of £5000 a year, and also to spend two months of every year solely in foreign travel. By the former resolution he secured leisure for a wide acquaintance with

general literature, and for a more than superficial cultivation of several branches of science; and the latter enabled him, besides visiting, "and most of them repeatedly, every country of Europe," to make extensive tours in the other three continents, journeying often to places little frequented by European travellers. As, moreover, he procured an introduction to nearly all the eminent personages in his line of travel, and knew many of them in his capacity of physician, his acquaintance with "men and cities" was of a species without a parallel. The *London Medical Record*, in noticing his death, which took place on his eighty-fifth birthday, October 27, 1873, remarked that it "had occurred under circumstances highly characteristic of his remarkable career." On his return from a journey in Russia he was present, on Friday, October 24th, at the trial of Marshal Bazaine in Paris, dining with some of the judges in the evening. He reached London on the Saturday, took ill the following day, and died quietly on the Monday afternoon.

Sir Henry Holland was the author of *General View of the Agriculture of Cheshire* (1807); *Travels in the Ionian Isles, Albania, Thessaly and Greece* (1812-1813, 2nd ed. 1819); *Medical Notes and Reflections* (1839); *Chapters on Mental Physiology* (1852); *Essays on Scientific and other Subjects contributed to the Edinburgh and Quarterly Reviews* (1862); and *Recollections of Past Life* (1872).

HOLLAND, HENRY FOX, 1ST BARON (1705-1774), English statesman, second son of Sir Stephen Fox, was born on the 28th of September 1705. Inheriting a large share of the riches which his father had accumulated, he squandered it soon after attaining his majority, and went to the Continent to escape from his creditors. There he made the acquaintance of a country-woman of fortune, who became his patroness and was so lavish with her purse that, after several years' absence, he was in a position to return home and, in 1735, to enter parliament as member for Hindon in Wiltshire. He became the favourite pupil and devoted supporter of Sir Robert Walpole, achieving unequalled and unenviable proficiency in the worst political arts of his master and model. As a speaker he was fluent and self-possessed, imperturbable under attack, audacious in exposition or retort, and able to hold his own against Pitt himself. Thus he made himself a power in the House of Commons and an indispensable member of several administrations. He was surveyor-general of works from 1737 to 1742, was member for Windsor from 1741 to 1761; lord of the treasury in 1743, secretary at war and member of the privy council in 1746, and in 1755 became leader of the House of Commons, secretary of state and a member of the cabinet under the duke of Newcastle. In 1757, in the rearrangements of the government, Fox was ultimately excluded from the cabinet, and given the post of paymaster of the forces. During the war, which Pitt conducted with extraordinary vigour, and in which the nation was intoxicated with glory, Fox devoted himself mainly to accumulating a vast fortune. In 1763 he again accepted the leadership of the House, with a seat in the cabinet, under the earl of Bute, and exercised his skill in cajolery and corruption to induce the House of Commons to approve of the treaty of Paris of 1763; as a recompense, he was raised to the House of Lords with the title of Baron Holland of Foxley, Wiltshire, on the 16th of April 1763. In 1765 he was forced to resign the paymaster generalship, and four years later a petition of the livery of the city of London against the ministers referred to him as "the public defaulter of unaccounted millions." The proceedings brought against him in the court of exchequer were stayed by a royal warrant; and in a statement published by him he proved that in the delays in making up the accounts of his office he had transgressed neither the law nor the custom of the time. From the interest on the outstanding balances he had, none the less, amassed a princely fortune. He strove, but in vain, to obtain promotion to the dignity of an earl, a dignity upon which he had set his heart, and he died at Holland House, Kensington, on the 1st of July 1774, a sorely disappointed man, with a reputation for cunning and unscrupulousness which cannot easily be matched, and with an unpopularity which justifies the conclusion that he was the most thoroughly hated statesman of his day. Lord Holland married in 1744

Lady Georgina Caroline Lennox, daughter of the duke of Richmond, who was created Baroness Holland, of Holland, Lincolnshire, in 1762. There were four sons of the marriage: Stephen, 2nd Lord Holland (d. 1774); Henry (d. an infant); Charles James (the celebrated statesman); and Henry Edward (1755-1811), soldier and diplomatist.

See Walpole's and other memoirs of the time, also the article Fox, CHARLES JAMES.

HOLLAND, HENRY RICH, 1ST EARL OF (1590-1649), 2nd son of Robert, 1st earl of Warwick, and of Penelope, Sir Philip Sidney's "Stella," daughter of Walter Devereux, 1st earl of Essex, was baptized on the 19th of August 1590, educated at Emmanuel College, Cambridge, knighted on the 3rd of June 1610, and returned to parliament for Leicester in 1610 and 1614. In 1610 he was present at the siege of Juliérs. Favours were showered upon him by James I. He was made gentleman of the bedchamber to Charles, prince of Wales, and captain of the yeomen of the guard; and on the 8th of March 1623 he was raised to the peerage as Baron Kensington. In 1624 he was sent to Paris to negotiate the marriage treaty between Charles and Henrietta Maria. On the 15th of September he was created earl of Holland, and in 1625 was sent on two further missions, first to Paris to arrange a treaty between Louis XIII. and the Huguenots, and later to the Netherlands in company with Buckingham. In October 1627 he was given command of the troops sent to reinforce Buckingham at Rhé, but through delay in starting only met the defeated troops on their return. He succeeded Buckingham as chancellor of Cambridge University; was master of the horse in 1628, and was appointed constable of Windsor and high steward to the queen in 1629. He interested himself, like his elder brother, Lord Warwick, in the plantations; and was the first governor of the Providence company in 1630, and one of the proprietors of Newfoundland in 1637. In 1631 he was made chief-justice-in-eye south of the Trent, and in this capacity was responsible for the unpopular revival of the obsolete forest laws. He intrigued at court against Portland and against Strafford, who expressed for him the greatest contempt. In 1636 he was disappointed at not obtaining the great office of lord high admiral, but was made instead groom of the stole. In 1639 he was appointed general of the horse, and drew ridicule upon himself by the fiasco at Kelso. In the second war against the Scots he was superseded in favour of Conway. He opposed the dissolution of the Short Parliament, joined the peers who supported the parliamentary cause, and gave evidence against Strafford. He was, however, won back to the king's side by the queen, and on the 16th of April 1641 made captain general north of the Trent. Dissatisfied, however, with Charles's refusal to grant him the nomination of a new baron, he again abandoned him, refused the summons to York, and was deprived of his office as groom of the stole at the instance of the queen, who greatly resented his ingratitude. He was chosen by the parliament in March and July 1642 to communicate its votes to Charles, who received him, much to his indignation, with studied coldness. He was appointed one of the committee of safety in July; made zealous speeches on behalf of the parliamentary cause to the London citizens; and joined Essex's army at Twickenham, where, it is said, he persuaded him to avoid a battle. In 1643 he appeared as a peacemaker, and after failing to bring over Essex, he returned to the king. His reception, however, was not a cordial one, and he was not reinstated in his office of groom of the stole. After, therefore, accompanying the king to Gloucester and taking part in the first battle of Newbury, he once more returned to the parliament, declaring that the court was too much bent on continuing hostilities, and the influence of the "papists" too strong for his patriotism. He was restored to his estates, but the Commons obliged the Lords to exclude him from the upper house, and his petition in 1645 for compensation for his losses and for a pension was refused. His hopes being in this quarter also disappointed, he once again renewed his allegiance to the king's cause; and after endeavouring to promote the negotiations for peace in 1645 and 1647 he took up arms in the second Civil War, received

a commission as general, and put himself at the head of 600 men at Kingston. He was defeated on the 7th of July 1647, captured at St Neots shortly afterwards, and imprisoned at Warwick Castle. He was tried before a "high court of justice" on the 3rd of February 1649, and in spite of his plea that he had received quarter was sentenced to death. He was executed together with Hamilton and Capel on the 9th of March. Clarendon styles him "a very well-bred man and a fine gentleman in good times." He was evidently a man of shallow character, devoid of ability, raised far above his merits and hopelessly unfit for the great times in which he lived. Lord Holland married Elizabeth, daughter and heiress of Sir Walter Cope of Kensington, and, besides several daughters, had four sons, of whom the eldest, Robert, succeeded him as 2nd earl of Holland, and inherited the earldom of Warwick in 1673.

HOLLAND, HENRY RICHARD VASSALL FOX, 3RD BARON (1773-1849), was the son of Stephen Fox, 2nd Baron Holland, his mother, Lady Mary Fitzpatrick, being the daughter of the earl of Upper Ossory. He was born at Winterslow House in Wiltshire, on the 21st of November 1773, and his father died in the following year. He was educated at Eton and at Christ Church, Oxford, where he became the friend of Canning, of Hookham Frere, and of other wits of the time. Lord Holland did not take the same political side as his friends in the conflicts of the revolutionary epoch. He was from his boyhood deeply attached to his uncle, C. J. Fox, and remained steadily loyal to the Whig party. In 1791 he visited Paris and became acquainted with Lafayette and Talleyrand, and in 1793 he again went abroad to travel in France and Italy. At Florence he met with Lady Webster, wife of Sir Godfrey Webster, Bart., who left her husband for him. She was by birth Elizabeth Vassall (1770-1845), daughter of Richard Vassall, a planter in Jamaica. A son was born of their irregular union, a Charles Richard Fox (1796-1873), who after some service in the navy entered the Grenadiers, and was known in later life as a collector of Greek coins. His collection was bought for the royal museum of Berlin when he died in 1873. He married Lady Mary Fitzclarence, a daughter of William IV. by Mrs Jordan. Sir Godfrey Webster having obtained a divorce, Lord Holland was enabled to marry on the 6th of July 1797. He had taken his seat in the House of Lords on the 5th of October 1796. During several years he may be said almost to have constituted the Whig party in the Upper House. His protests against the measures of the Tory ministers were collected and published, as the *Opinions of Lord Holland* (1841), by Dr Moylan of Lincoln's Inn. In 1800 he was authorized to take the name of Vassall, and after 1807 he signed himself Vassall Holland, though the name was no part of his title. In 1800 Lord and Lady Holland went abroad and remained in France and Spain till 1805, visiting Paris during the Peace of Amiens, and being well received by Napoleon. Lady Holland always professed a profound admiration of Napoleon, of which she made a theatrical display after his fall, and he left her a gold snuff-box by his will. In public life Lord Holland took a share proportionate to his birth and opportunities. He was appointed to negotiate with the American envoys, Monroe and W. Pinkney, was admitted to the privy council on the 27th of August 1806, and on the 15th of October entered the cabinet "of all the talents" as lord privy seal, retiring with the rest of his colleagues in March 1807. He led the opposition to the Regency bill in 1811, and he attacked the "orders in council" and other strong measures of the government taken to counteract Napoleon's Berlin decrees. He was in fact in politics a consistent Whig, and in that character he denounced the treaty of 1813 with Sweden which bound England to consent to the forcible union of Norway, and he resisted the bill of 1816 for confining Napoleon in St Helena. His loyalty as a Whig secured recognition when his party triumphed in the struggle for parliamentary reform, by his appointment as chancellor of the duchy of Lancaster in the cabinet of Lord Grey and Lord Melbourne, and he was still in office when he died on the 22nd of October 1840. Lord Holland is notable, not for his somewhat

¹ *Hist. of the Rebellion*, xi. 263.

insignificant political career, but as a patron of literature, as a writer on his own account, and because his house was the centre and the headquarters of the Whig political and literary world of the time; and Lady Holland (who died on the 16th of November 1845) succeeded in taking the sort of place in London which had been filled in Paris during the 18th century by the society ladies who kept "salons." Lord Holland's *Foreign Reminiscences* (1850) contain much amusing gossip from the Revolutionary and Napoleonic era. His *Memoirs of the Whig Party* (1852) is an important contemporary authority. His small work on *Lopo de Vega* (1806) is still of some value. Holland had two legitimate sons, Stephen, who died in 1800, and Henry Edward, who became 4th Lord Holland. When this peer died in December 1859 the title became extinct.

See *The Journal of Elisabeth, Lady Holland*, edited by the earl of Ilchester (1908); and Lloyd Sanders, *The Holland House Circle* (1908).

HOLLAND, JOSIAH GILBERT (1819-1881), American author and editor, was born in Belchertown, Massachusetts, on the 24th of July 1819. He graduated in 1843 at the Berkshire Medical College (no longer in existence) at Pittsfield, Mass., and after practising medicine in 1844-1847, and making an unsuccessful attempt, with Charles Robinson (1818-1894), later first governor of the state of Kansas, to establish a hospital for women, he taught for a brief period in Richmond, Virginia, and in 1848 was superintendent of schools in Vicksburg, Mississippi. In 1849 he became assistant editor under Samuel Bowles, and three years later one of the owners, of the Springfield (Massachusetts) *Republican*, with which he retained his connexion until 1867. He then travelled for some time in Europe, and in 1870 removed to New York, where he helped to establish and became editor and one-third owner of *Scribner's Monthly* (the title of which was changed in 1881 to *The Century*), which absorbed the periodicals *Hours at Home*, *Pulnam's Magazine* and the *Riverside Magazine*. He remained editor of this magazine until his death. Dr Holland's books long enjoyed a wide popularity. The earlier ones were published over the pseudonym "Timothy Titcomb." His writings fall into four classes: history and biography, represented by a *History of Western Massachusetts* (1855), and a *Life of Abraham Lincoln* (1865); fiction, of which *Miss Gilbert's Career* (1860) and *The Story of Seawoaks* (1875) remain faithful pictures of village life in eastern United States; poetry, of which *Bitter-Sweet* (1858) and *Kathrina, Her Life and Mine* (1867) were widely read; and a series of homely essays on the art of living, of which the most characteristic were *Letters to Young People, Single and Married* (1858), *Gold Foil, hammered from Popular Proverbs* (1859), *Letters to the Joneses* (1863), and *Every-Day Topics* (2 series, 1876 and 1882). While a resident of New York, where he died on the 12th of October 1881, he identified himself with measures for good government and school reform, and in 1872 became a member and for a short time in 1875 was president of the Board of Education.

See Mrs H. M. Plunkett's *Josiah Gilbert Holland* (New York, 1894).

HOLLAND, PHILEMON (1552-1637), English scholar, "the translator-general in his age," was born at Chelmsford in Essex. He was the son of a clergyman, John Holland, who had been obliged to take refuge in Germany and Denmark with Miles Coverdale during the Marian persecution. Having become a fellow of Trinity College, Cambridge, and taken the degree of M.A., he was incorporated at Oxford (July 11th, 1585). Having subsequently studied medicine, about 1595 he settled as a doctor in Coventry, but chiefly occupied himself with translations. In 1628 he was appointed headmaster of the free school, but, owing probably to advancing age, he held office for only eleven months. His latter days were oppressed by poverty, partly relieved by the generosity of the common council of Coventry, which in 1632 assigned him £3, 6s. 8d. for three years, "if he should live so long." He died on the 9th of February, 1636-1637. His fame is due solely to his translations, which included Livy, Pliny's *Natural History*, Plutarch's *Morals*, Suetonius,

Ammianus Marcellinus and Xenophon's *Cyropaedia*. He published also an English version, with additions, of Camden's *Britannia*. His Latin translation of Brice Bauderon's *Pharmacopœia* and his *Regimen sanitatis Salerni* were published after his death by his son, HENRY HOLLAND (1583-1765), who became a London bookseller, and is known to bibliographers for his *Basiliologia; a Booke of Kings, being the true and liuely Effigies of all our English Kings from the Conquest* (1618), and his *Heroologia Anglica* (1620).

HOLLAND, RICHARD, or RICHARD DE HOLLANDE (fl. 1450), Scottish writer, author of the *Buke of the Howlat*, was secretary or chaplain to the earl of Moray (1450) and rector of Halkirk, near Thurso. He was afterwards rector of Abbreochy, Loch Ness, and later held a chantry in the cathedral of Norway. He was an ardent partisan of the Douglases, and on their overthrow retired to Orkney and later to Shetland. He was employed by Edward IV. in his attempt to rouse the Western Isles through Douglas agency, and in 1482 was excluded from the general pardon granted by James III. to those who would renounce their fealty to the Douglases.

The poem, entitled the *Buke of the Howlat*, written about 1450, shows his devotion to the house of Douglas:—

"On ilk beugh till embrace
Writtin in a bill was
O Dowglass, O Dowglass
Tender and trewe!"

(il. 400-403).

and is dedicated to the wife of a Douglas—

"Thus for ane Dow of Dunbar drew I this Dyte,
Dowit with ane Dowglass, and boith war thei dowis."

but all theories of its being a political allegory in favour of that house may be discarded. Sir Walter Scott's judgment that the *Buke* is "a poetical apologue . . . without any view whatever to local or natural politics" is certainly the most reasonable. The poem, which extends to root lines written in the irregular alliterative rhymed stanza, is a bird-allegory, of the type familiar in the *Parlement of Foules*. It has the incidental interest of showing (especially in stanzas 62 and 63) the antipathy of the "Inglish-speaking Scot" to the "Scots-speaking Gael" of the west, as is also shown in Dunbar's *Flyting with Kennedy*.

The text of the poem is preserved in the Alscan and Bannatyne MSS. Fragments of an early 16th century black-letter edition, discovered by D. Laing, are reproduced in the *Adversaria* of the Bannatyne Club. The poem has been frequently reprinted, by Pinkerton, in his *Scottish Poems* (1792); by D. Laing (Bannatyne Club 1823; reprinted in "New Club" series, Paisley, 1882); by the Hunterian Club in their edition of the Bannatyne MS., and by A. Diebler (Chemnitz, 1893). The latest edition is that by F. J. Amours in *Scottish Alliterative Poems* (Scottish Text Society, 1897), pp. 47-81. (See also Introduction pp. xx-xxvii.)

HOLLAND, officially the kingdom of the Netherlands (*Koninkrijk der Nederlanden*), a maritime country in the north-west of Europe. The name Holland is that of the former countyship, which forms part of the political, as well as the geographical centre of the kingdom (see the next article).

Topography.—Holland is bounded on the E. by Germany, on the S. by Belgium, on the W. and N. by the North Sea, and at the N.E. corner by the Dollart. From Stevensweert southward to the extreme corner of Limburg the boundary line is formed by the river Maas or Meuse.¹ On the east a natural geographical boundary was formed by the long line of marshy fens extending along the borders of Overysel, Drente and Groningen. The kingdom extends from 53° 32' 51" (Groningen Cape on Rottum Island) to 50° 45' 49" N. (Mesch in the province of Limburg), and from 3° 23' 27" (Sluis in the province of Zeeland) to 7° 12' 20" E. (Langakkerschans in the province of Groningen). The greatest length from north to south, viz. that from Rottum Island to Eijsden near Maastricht is 164 m., and the greatest breadth from south-west to north-east, or from Zwin near Sluis to Losser in Overysel, 144 m. The area is subject

¹ At Maastricht, however, a portion lies on the left bank of the river, measured, according to the treaty with Belgium, 19th of April 1839, art. 4, by an average radius of 1200 Dutch fathoms (7874 ft.) from the outer glacis of the fortress.

to perpetual variation owing, on the one hand, to the erosion of the coasts, and, on the other, to reclamation of land by means of endiking and drainage operations. In 1889 the total area was calculated at 12,558 sq. m., and, including the Zuider Zee and the Wadden (2050 sq. m.) and the Dutch portion of the Dollart (23 sq. m.), 14, 613 sq. m. In no country in Europe has the character of the territory exercised so great an influence on the inhabitants as in the Netherlands; and, on the other hand, no people has so extensively modified the condition of its territory as the Dutch. The greatest importance attaches therefore to the physical conformation of the country.

The coast-line extends in a double curve from south-west to north-east, and is formed by a row of sand dunes, 171 m. in length, fringed by a broad sandy beach descending very gradually into the sea. In the north and south, however, this line is broken by the inlets of the sea which form the Frisian and the South Holland and Zeeland islands respectively; but the dunes themselves are found continued along the seaward side of these islands, thus indicating the original continuity of the coast-line. The breadth of the dunes naturally varies greatly, the maximum width of about 4375 yds. being found at Schoorl, north-west of Alkmaar. The average height of the individual dune-tops is not above 33 ft., but attains a maximum of 197 ft. at the High Blinkert, near Haarlem. The steepness of the dunes on the side towards the sea is caused by the continual erosion, probably traceable, in part at least, to the channel current (which at mean tide has a velocity of 14 or 15 in. per second), and to the strong west or north-west winds which carry off large quantities of material. This alteration of coast-line appears at Loosduinen, where the moor or fenland formerly developed behind the dunes now crops out on the shore amid the sand, being pressed to the compactness of lignite by the weight of the sand drifted over it. Again, the remains of the Roman camp Brittenburg or Huis te Britten, which originally lay within the dunes and, after being covered by them, emerged again in 1520, were, in 1604, 1600 paces out to sea, opposite Katwijk; while, besides Katwijk itself, several other villages of the west coast, as Domburg, Scheveningen, Egmond, have been removed further inland. The tendency of the dunes to drift off on the landward side is prevented by the planting of bent-grass (*Arundo arenaria*), whose long roots serve to bind the sand together. It must be further remarked that both the "dune-pans," or depressions, which are naturally marshy through their defective drainage, and the *geest* grounds—that is, the grounds along the foot of the downs—have been in various places either planted with wood or turned into arable and pasture land; while the numerous springs at the base of the dunes are of the utmost value to the great cities situated on the marshy soil inland, the example set by Amsterdam in 1853 in supplying itself with this water having been readily followed by Leiden, the Hague, Flushing, &c.

As already remarked, the coast-line of Holland breaks up into a series of islands at its northern and southern extremities. The principal sea-inlets in the north are the Texel Gat or Marsdiep and the Vlie, which lead past the chain of the Frisian Islands into the large inland sea or gulf called the Zuider Zee, and the Wadden or "shallows," which extend along the shores of Friesland and Groningen as far as the Dollart and the mouth of the Ems. The inland sea-board thus formed consists of low coasts of sea-clay protected by dikes, and of some high diluvial strata which rise far enough above the level of the sea to make dikes unnecessary, as in the case of the Gooi hills between Naarden and the Eem, the Veluwe hills between Nykerk and Elburg, and the steep cliffs of the Gaasterland between Oude Mirdum and Stavoren. The Dollart was formed in 1277 by the inundation of the Ems basin, more than thirty villages being destroyed at once. The Zuider Zee and the bay in the Frisian coast known as the Lauwers Zee also gradually came into existence in the 13th century. The extensive sea-arms forming the South Holland and Zeeland archipelago are the Hont or West Scheldt, the East Scheldt, the Grevelingen (communicating with Krammer and the Volkerak) and the Haringvliet, which after being joined by the Volkerak is known as the Hollandsch Diep. These inlets were formerly of much greater extent than now, but are gradually closing up owing to the accumulation of mud deposits, and no longer have the same freedom of communication with one another. At the head of the Hollandsch Diep is the celebrated railway bridge of the Moerdyk (1868-1871) 1607 yds. in length; and above this bridge lies the Biesbosch ("reed forest"), a group of marshy islands formed by a disastrous inundation in 1421, when seventy-two villages and upwards of 100,000 lives were destroyed.

Besides the dunes the only hilly regions of Holland are the southern half of the province of Limburg, the neighbourhood of Nijmegen, the hills of Utrecht, including the Gooi hills, the Veluwe hills, the region in Gelderland, the isolated hills in the middle and east of Overysel and the Hondsrug range in Drenthe. The remainder of the country is flat, and shows a regular downward slope from south-east to north-west, in which direction the rivers mainly flow. The elevation of the surface of the country ranges between the extreme height of 1057 ft. near Vaals in the

farthest corner of Limburg, and 16-20 ft. below the Amsterdam zero, in some of the drained lands in the western half of the country. In fact, one quarter of the whole kingdom, consisting of the provinces of North and South Holland, the western portion of Utrecht as far as the Vaurt Rhine, Zeeland, except the southern part of Zeeland-Flanders, and the north-west part of North Brabant, lies below the Amsterdam zero; and altogether 35% of the country, or all that part lying west of a line drawn through Groningen, Utrecht and Antwerp, lies within one metre above the Amsterdam zero and would be submerged if the sea broke down the barrier of dunes and dikes. This difference between the eastern and western divisions of Holland has its counterpart in the landscape and the nature of the soil. The western division consists of low fen or clay soil and presents a monotonous expanse of rich meadow-land, carefully drained in regular lines of canals bordered by stunted willows, and dotted over with windmills, the sails of canal craft and the clumps of elm and poplar which surround each isolated farm-house. The landscape of the eastern division is considered less typical. Here the soil consists mainly of sand and gravel, and the prevailing scenery is formed of waste heaths and patches of wood; while here and there fertile meadows extend along the banks of the streams, and the land is laid out in the highly regular manner characteristic of fen reclamation (see DRENTE).

The entire drainage of Holland is into the North Sea. The three principal rivers are the Rhine, the Maas (Meuse) and the Scheldt (Schelde), and all three have their origin outside the country, whilst the Scheldt has its mouth only in Holland, giving its name to the two broad inlets of the sea which bound the Zeeland islands. The Rhine in its course through Holland is merely the parent stream of several important branches, splitting up into Rhine and Waal, Rhine and Ysel, Crooked Rhine and Lek (which takes two-thirds of the waters), and at Utrecht into Old Rhine and Vecht, finally reaching the sea through the sluices at Katwijk (a little more than a drainage canal). The Ysel and the Vecht flow to the Zuider Zee; the other branches to the North Sea. The Maas, whose course is almost parallel to that of the Rhine, follows in a wide curve the general slope of the country, receiving the Roer, the Mark and the Aa. Towards its mouth its waters find their way into all the channels intersecting the South Holland archipelago. The main stream joining the Waal at Gorinchem flows on to Dordrecht as the Merwede, and is continued thence to the sea by the Old Maas, the North, and the New Maas, the New Maas being formed by the junction of the Lek and the North. From Gorinchem the *Nieuw Merwede* (constructed in the second half of the 19th century) extends between dykes through the marshes of the Biesbosch to the Hollandsch Diep. These great rivers render very important service as waterways. The mean velocity of their flow seldom exceeds 4.9 ft., but rises to 6.4 ft. when the river is high. In the lower reaches of the streams the velocity and slope are of course affected by the tides. In the Waal ordinary high water is perceptible as far up as Zalt Bommel in Gelderland, in the Lek the maximum limits or ordinary and spring tides are at Vianen and Kullenburg respectively, in the Ysel above the Katveer at the junction of the Willemsvaart and past Wybe midway between Zwolle and Deventer; and in the Maas near Heusden and at Well in Limburg. Into the Zuider Zee there also flow the Kuinder, the Zwart Water, with its tributary the Vecht, and the Eem. The total length of navigable channels is about 1150 m., but sand banks and shallows not infrequently impede the shipping traffic at low water during the summer. The smaller streams are often of great importance. Except where they rise in the fens they call into life a strip of fertile grassland in the midst of the barren sand, and are responsible for the existence of many villages along their banks. Following the example of the great Kampen irrigation canal in Belgium, artificial irrigation is also practised by means of some of the smaller streams, especially in North Brabant, Drenthe and Overysel, and in the absence of streams, canals and sluices are sometimes specially constructed to perform the same service. The low-lying spaces at the confluences of the rivers, being readily laid under water, have been not infrequently chosen as sites for fortresses. As a matter of course, the streams are also turned to account in connexion with the canal system—the Dommel, Berkel, Vecht, Regge, Holland Ysel, Gouwe, Rotta, Schie, Spaarne, Zaan, Amstel, Dieze, Amer, Mark, Zwart Water, Kuinder and the numerous Aas in Drenthe and Groningen being the most important in this respect.

It is unnecessary to mention the names of the numerous marshy lakes which exist, especially in Friesland and Groningen, and are connected with rivers or streamlets. Those of Friesland are of note for the abundance of their fish and their beauty. **Lakes.** of situation, on which last account the Uddelermeer in Gelderland is also celebrated. The Rottkanje Lake near Brielle is remarkable for the strong salty solution which covers even the growing reeds with a

¹ The datum plane, or basis of the measurement of heights, is throughout Holland, and also in some of the border districts of Germany, the *Amsterdamsch Peil* (A.P.), or Amsterdam water-level, and represents the average high water-level of the Y at Amsterdam at the time when it was still open to the Zuider Zee. Local and provincial "peils" are, however, also in use on some water-ways.

HOLLAND

English Miles
0 1 2 3 4 5 6 7 8 9 10

- Capitals of Countries
- Capitals of Provinces
- Boundaries of Provinces
- Railways
- Canals
- Marsh
- Fortifications



—

hard crust. Many of the lakes are nothing more than deep pits or marshes from which the peat has been extracted.

Dikes.—The circumstance that so much of Holland is below the sea-level necessarily exercises a very important influence on the drainage, the climate and the sanitary conditions of the country, as well as on its defence by means of inundation. The ending of low lands against the sea which had been quietly proceeding during the first eleven centuries of the Christian era, received a fresh impetus in the 12th and 13th centuries from the fact that the level of the sea then became higher in relation to that of the land. This fact is illustrated by the broadening of river mouths and estuaries at this time, and the beginning of the formation of the Zuider Zee. A new feature in diking was the construction of dams or sluices across the mouths of rivers, sometimes with important consequences for the villages situated on the spot. Thus the dam on the Amstel (1257) was the origin of Amsterdam, and the dam on the Ye gave rise to Edam. But Holland's chief protection against inundation is its long line of sand dunes, in which only two real breaches have been effected during the centuries of erosion. These are represented by the famous sea dikes called the Westkapelle dike and the Hondsbosche Zeewering, or sea-defence, which were begun respectively in the first and second halves of the 15th century. The first extends for a distance of over 4000 yds. between the villages of Westkapelle and Domburg in the island of Walcheren; the second is about 4900 yds. long, and extends from Kamperduin to near Petten, whence it is continued for another 1100 yds. by the Pettemer dike. These two sea dikes were reconstructed by the state at great expense between the year 1860 and 1884, having consisted before that time of little more than a protected sand dike. The earthen dikes are protected by stone-slupes and by piles, and at the more dangerous points also by *sinkstukken* (sinking pieces), artificial structures of brushwood laden with stones, and measuring some 400 yds. in circuit, by means of which the current is to some extent turned aside. The Westkapelle dike, 12,468 ft. long, has a seaward slope of 300 ft., and is protected by rows of piles and basalt blocks. On its ridge, 30 ft. broad, there is not only a roadway but a service railway. The cost of its upkeep is more than £6000 a year, and of the Hondsbosche Zeewering £2000 a year. When it is remembered that the woodwork is infested by the pile worm (*Teredo navalis*), the ravages of which were discovered in 1731, the labour and expense incurred in the construction and maintenance of the sea dikes now existing may be imagined. In other parts of the coast the dunes, though not pierced through, have become so wasted by erosion as to require artificial strengthening. This is afforded, either by means of a so-called sleeping dike (*slaperdyk*) behind the weak spot, as, for instance, between Kadzand and Breskens in Zealand-Flanders, and again between 's Gravenzande and Loosduinen; or by means of piers or breakwaters (*hoofden*, heads) projecting at intervals into the sea and composed of piles, or brushwood and stones. The first of such breakwaters was that constructed in 1857 at the north end of the island of Goeree, and extends over 100 yds. into the sea at low water. Similar constructions are to be found on the seaward side of the islands of Walcheren, Schouwen and Voorn, and between 's Gravenzande and Scheveningen, and Katwijk and Noordwijk. Owing to the obstruction which they offer to drifting sands, artificial dunes are in course of time formed about them, and in this way they become at once more effective and less costly to maintain. The firm and regular dunes which now run from Petten to Kallantsog (formerly an island), and thence northwards to Huisduinen, were thus formed about the Zyper (1617) and Koegras (1610) dikes respectively. From Huisduinen to Nieuwediep the dunes are replaced by the famous Helder seawall. The shores of the Zuider Zee and the Wadden, and the Frisian and Zuider Zee islands, are also partially protected by dikes. In more than one quarter the dikes have been repeatedly extended so as to enclose land conquered from the sea, the work of reclamation being aided by a natural process. Layer upon layer of clay is deposited by the sea in front of the dikes, until a new fringe has been added to the coast-line on which sea-

grasses begin to grow. Upon these clay-lands (*kwelders*) horses, cattle and sheep are at last able to pasture at low tide, and in course of time they are in turn endiked.

River dikes are as necessary as sea dikes, elevated banks being found only in a few places, as on the Lower Rhine. Owing to the unsuitability of the foundations, Dutch dikes are usually marked by a great width, which at the crown varies between 13 and 26 ft. The height of the dike ranges to 40 in. above high water-level. Between the dikes and the stream lie "forelands" (*interwaarden*), which are usually submerged in winter, and frequently lie 1 or 2 yds. higher than the country within the dikes. These forelands also offer in course of time an opportunity for endiking and reclamation. In this way the towns of Rotterdam, Schiedam, Vlaardingen and Maasluis have all gradually extended over the Maas dike in order to keep in touch with the river, and the small town of Delfshaven is built altogether on the outer side of the same dike.

Impoldering.—The first step in the reclamation of land is to "impolder" it, or convert it into a "polder" (i.e. a section of artificially drained land), by surrounding it with dikes or quays for the twofold purpose of protecting it from all further inundation from outside and of controlling the amount of water inside. Impoldering for its own sake or on a large scale was impossible as long as the means of drainage were restricted. But in the beginning of the 15th century new possibilities were revealed by the adaptation of the windmill to the purpose of pumping water. It was gradually recognized that the masses of water which collected whenever peat-digging had been carried on were an unnecessary menace to the neighbouring lands, and also that a more enduring source of profit lay in the bed of the fertile sea-clay under the peat. It became usual, therefore, to make the subsequent drainage of the land a condition of the extraction of peat from it, this condition being established by proclamation in 1595.

Drainage.—It has been shown that the western provinces of Holland may be broadly defined as lying below sea-level. In fact the surface of the sea-clay in these provinces is from 1½ to 16½ ft. below the Amsterdam zero. The ground-water is, therefore, relatively very high and the capacity of the soil for further absorption proportionately low. To increase the reservoir capacity of the polder, as well as to conduct the water to the windmills or engines, it is intersected by a network of ditches cut at right angles to each other, the amount of ditching required being usually one-twelfth of the area to be drained. In modern times pumping engines have replaced windmills, and the typical old Dutch landscape with its countless hooded heads and swinging arms has been greatly transformed by the advent of the chimney stacks of the pumping-stations. The power of the pumping-engines is taken on the basis of 12 h.p. per 1000 hectares for every metre that the water has to be raised, or stated in another form, the engines must be capable of raising nearly 9 lb. of water through 1 yd. per acre per minute. The main ditches, or canals, however, also serve as a means of navigation. The level at which it is desired to keep the water in these ditches constitutes the unit of water measurement for the polder, and is called the polder's *summer peil* (Z.P.) or summer water-level. In pasture-polders (*hoepolders*) Z.P. is 1 to 1½ ft. below the level of the polder, and in agricultural polders 2½ to 3½ ft. below. Owing to the shrinkage of the soil in reclaimed lands, however, that is, lands which have been drained after fen or other reclamation, the sides of the polder are often higher than the middle, and it is necessary by means of small dams or sluices to make separate water-tight compartments (*afpolderingen*), each having its own unit of measurement. Some polders also have a winter peil as a precaution against the increased fall of water in that season. The summer water-level of the pasture polders south of the former Y is about 4 to 8 ft. below the Amsterdam zero, but in the Noorderkwartier to the north, it reaches 10½ ft. below A.P. in the Beeshotel polder, and in reclaimed lands (*droogmakersjen*) may be still lower, thus in the Reeuwijk polder north of Gouda it is 21½ ft. below.

The drainage of the country is effected by natural or artificial means, according to the slope of the ground. Nearly all the polders of Zealand and South Holland are able to discharge naturally into the sea at average low water, self-regulating sluices being used. But in North Holland and Utrecht on the contrary the polder water has generally to be raised. In some deep polders and drained lands where the water cannot be brought to the required height at once, windmills are found at two or even three different levels. The final removal of polder water, however, is only truly effected upon its discharge into the "outer waters" of the country, that is, the sea itself or the large rivers freely communicating with it; and this happens with but a small proportion of Dutch polders, such as those of Zealand, the Holland Vael and the Noorderkwartier.

As the system of impoldering extended, the small sluggish rivers were gradually cut off by dikes from the marshy lands through which they flowed, and by sluices from the waters with which they communicated. Their level ranges from about 1½ to 4 ft. above that of the pasture polders. In addition, various kinds of canals

and endiked or embanked lakes had come into existence, forming altogether a vast network of more or less stagnant waters. These waters are utilized as the temporary reservoirs of the superfluous polder water, each system of reservoirs being termed a *boezem* (bosom or basin), and all lands watering into the same boezem being considered as belonging to it. The largest boezem is that of Friesland, which embraces nearly the whole province. It sometimes happens that a polder is not in direct contact with the boezem to which it belongs, but first drains into an adjacent polder, from which the water is afterwards removed. In the same way, some boezems discharge first into others, which then discharge into the sea or rivers. This is usually the case where there is a great difference in height between the surface of the boezem and the outer waters, and may be illustrated by the Alblasserwaard and the Rotte boezems in the provinces of South and North Holland respectively. In time of drought the water in the canals and boezems is allowed to run back into the polders, and so serve a double purpose as water-reservoirs. Boezems, like polders, have a standard water-level which may not be exceeded, and as in the polder this level may vary in the different parts of an extended boezem. The height of the boezem *peil* ranges between 1½ ft. above to 1½ ft. below the Amsterdam zero, though the average is about 1 to 1½ ft. below. Some boezems, again, which are less easily controlled, have a "danger water-level" at which they refuse to receive any more water from the surrounding polders. The Schie or Delflands boezem of South Holland is of this kind, and such a boezem is termed *besloten* or "sequestered," in contradistinction to a "free" boezem. A third kind of boezem is the reserve or *berg-boezem*, which in summer may be made dry and used for agriculture, while in winter it serves as a special reserve. The centuries of labour and self-sacrifice involved in the making of this complete and harmonious system of combined defence and reclamation are better imagined than described, and even at the present day the evidences of the struggle are far less apparent than real.

Geology.—Except in Limburg, where, in the neighbourhood of Maastricht, the upper layers of the chalk are exposed and followed by Oligocene and Miocene beds, the whole of Holland is covered by recent deposits of considerable thickness, beneath which deep borings have revealed the existence of Pliocene beds similar to the "Crag" of East Anglia. They are divided into the *Duistien*, corresponding in part with the English Coralline Crag, the *Scaldvizen* and *Poedertien* corresponding with the Walton Crag, and the *Amsteltien* corresponding with the Red Crag of Suffolk. In the south of Holland the total thickness of the Pliocene series is only about 200 ft., and they are covered by about 100 ft. of Quaternary deposits; but towards the north the beds sink down and at the same time increase considerably in thickness, so that at Utrecht a deep boring reached the top of the Pliocene at a depth of 513 ft. and at 1198 ft. it had not touched the bottom. At Amsterdam the top of the Pliocene lay 625 ft. below the surface, but the boring, 1038 ft. deep, did not reach the base of the uppermost division of the Pliocene, viz. the *Amsteltien*. Eastward and westward of Amsterdam, as well as southward, the Pliocene beds rise slowly to the surface, and gradually decrease in thickness. They were laid down in a broad bay which covered the east of England and nearly the whole of the Netherlands, and was open to the North Sea. There is evidence that the sea gradually retreated northwards during the deposition of these beds, until at length the Rhine flowed over to England and entered the sea north of Cromer. The appearance of northern shells in the upper divisions of the Pliocene series indicates the approach of the Glacial period, and glacial drift containing Scandinavian boulders now covers much of the country east of the Zuider Zee. The more modern deposits of Holland consist of alluvium, wind-blown sands and peat.

Climate.—Situated in the temperate zone between 50° and 53° N. the climate of Holland shows a difference in the lengths of day and night extending in the north to nine hours, and there is a correspondingly wide range of temperature; it also belongs to the region of variable winds. On an average of fifty years the mean annual temperature was 49.8° Fahr.; the maximum, 93.9° Fahr.; the minimum, -5.8° Fahr. The mean annual barometric height is 29.93 in.; the mean annual moisture, 81%; the mean annual rainfall, 27.99 in. The mean annual number of days with rain is 204, with snow 19, and with thunder-storms 18. The increased rainfall from July to December (the summer and autumn rains), and the increased evaporation in spring and summer (5.2 in. more than the rainfall), are of importance as regards "poldering" and draining operations. The prevalence of south-west winds during nine months of the year and of north-west during three (April-June) has a strong influence on the temperature and rainfall, tides, river mouths and outlets, and also, geologically, on dunes and sand drifts, and on fens and the accumulation of clay on the coast. The west winds of course increase the moisture, and moderate both the winter cold and the summer heat, while the east winds blowing over the

continent have an opposite influence. It cannot be said that the climate is particularly good, owing to the changeableness of the weather, which may alter completely within a single day. The heavy atmosphere likewise, and the necessity of living within doors or in confined localities, cannot but exercise an influence on the character and temperament of the inhabitants. Only of certain districts, however, can it be said that they are positively unhealthy; to this category belong some parts of the Holland provinces, Zeeland, and Friesland, where the inhabitants are exposed to the exhalations from the marshy ground, and the atmosphere is often burdened with sea-fogs.

Fauna.—In the densely populated Netherlands, with no extensive forests, the fauna does not present any unusual varieties. The otter, martin and badger may be mentioned among the rarer wild animals, and the weasel, ermine and pole-cat among the more common. In the 18th century wolves still roamed the country in such large numbers that hunting parties were organized against them; now they are unknown. Roe-buck and deer are found in a wild state in Gelderland and Overysel, foxes are plentiful in the dry wooded regions on the borders of the country, and hares and rabbits in the dunes and other sandy stretches. Among birds may be reckoned about two hundred and forty different kinds which are regular inhabitants, although nearly two hundred of these are migratory. The woodcock, partridge, hawk, water-ouzel, magpie, jay, raven, various kinds of owls, wood-pigeon, golden-crested wren, tufted lark and titmouse are among the birds which breed here. Birds of passage include the buzzard, kite, quail, wild fowl of various kinds, golden thrush, wagtail, linnet, finch and nightingale. Storks are plentiful in summer and might almost be considered the most characteristic feature of the prevailing landscape.

Flora.—The flora may be most conveniently dealt with in the four physiographical divisions to which it belongs. These are, namely, the heath-lands, pasture-lands, dunes and coasts. Heath (*Erica tetralix*) and ling (*Calluna vulgaris*) cover all the waste sandy regions in the eastern division of the country. The vegetation of the meadow-lands is monotonous. In the more damp and marshy places the bottom is covered with marsh trefoil, carex, smooth equisetum, and rush. In the ditches and pools common yellow and white water-lilies are seen, as well as water-soldier (*Stratiotes aloides*), great and lesser reed-mace, sweet flag and bur-reed. The plant forms of the dunes are stunted and meagre as compared with the same forms elsewhere. The most common plant here is the stiff sand-reed (*Arundo arenaria*), called sand-oats in Drente and Overysel, where it is much used for making mats. Like the sand-reed, the dewberry bramble and the shrub of the buckthorn (*Hippobosac rhannoides*) perform a useful service in helping to bind the sand together. Furze and the common juniper are regular dune plants, and may also be found on the heaths of Drente, Overysel and Gelderland. Thyme and the small white dune-rose (*Rosa pimpinellifolia*) also grow in the dunes, and wall-pepper (*Sedum acre*), field fever-wort, reindeer moss, common asparagus, sheep's fescue, fass, the pretty Solomon-seal (*Polygonatum officinale*), and the broad-leaved or marsh orchis (*Orchis latifolia*). The sea-plants which flourish on the sand and mud-banks along the coasts greatly assist the process of littoral deposits and are especially cultivated in places. Sea-aster flourishes in the Wadden of Friesland and Groningen, the Dollart and the Zeeland estuaries, giving place nearer the shore to sandspurry (*Spergularia*), or sea-poa or floating meadow grass (*Glyceria maritima*), which grows up to the dikes, and affords pasture for cattle and sheep. Along the coast of Overysel and in the Biesbosch lake club-rush, or scirpus, is planted in considerable quantities for the hat-making industry, and common sea-wrack (*Zostera marina*) is found in large patches in the northern half of the Zuider Zee, where it is gathered for trade purposes during the months of June, July and August. Except for the willow-plots found along the rivers on the clay lands, nearly all the wood is confined to the sand and gravel soils, where copes of birch and alder are common.

Population.—The following table shows the area and population in the eleven provinces of the Netherlands:—

Province	Area in sq. m.	Population 1890.	Population 1900.	Density per sq. m. in 1900.
North Brabant	1,980	509,628	553,842	280
Gelderland	1,965	512,202	566,549	288
South Holland	1,166	940,641	1,144,448	981
North Holland	1,070	829,489	968,131	905
Zeeland	690	199,234	216,295	313
Utrecht	534	221,007	251,034	470
Friesland	1,282	335,558	340,262	265
Overysel	1,291	295,445	333,338	258
Groningen	790	272,786	299,602	379
Drente	1,030	130,704	148,544	144
Limburg	850	255,721	281,934	332
Total	12,648	4,511,415	5,104,137 ¹	404

¹ This total includes 153 persons assigned to no province.

¹ See J. Loric, *Contributions à la géologie des Pays-bas* (1885-1895), *Archives du Mus. Teyler* (Haarlem), ser. 2, vol. ii. pp. 109-240, vol. iii. pp. 1-160, 375-461, vol. iv. pp. 165-309 and Bull. soc. belge géol. vol. iii. (1889); *Mém.* pp. 409-449; F. W. Harmel, "On the Pliocene Deposits of Holland," &c., *Quart. Journ. Geol. Soc., London*, vol. jii. (1896) pp. 748-781, pls. xxxiv., xxxv.

The extremes of density of population are found in the provinces of North Holland and South Holland on the one hand, and Drente on the other. This divergence is partly explained by the difference of soil—which in Drente comprises the maximum of waste lands, and in South Holland the minimum—and partly also by the greater facilities which the seaward provinces enjoy of earning a subsistence, and the greater variety of their industries. The largest towns are Amsterdam, Rotterdam, the Hague, Utrecht, Groningen, Haarlem, Arnhem, Leiden, Nijmegen, Tilburg. Other considerable towns are Dordrecht, Maastricht, Leeuwarden, Zwolle, Delft, 's Hertogenbosch, Schiedam, Deventer, Breda, Apeldoorn, Helder, Enschedé, Gouda, Zaandam, Kampen, Hilversum, Flushing, Amersfoort, Middelburg, Zutphen and Alkmaar. Many of the smaller towns, such as Assen, Enschedé, Helmond, Hengelo, Tiel, Venlo, Vlaardingen, Zaandam, Yerseke, show a great development, and it is a noteworthy fact that the rural districts, taken as a whole, have borne an equal share in the general increase of population. This, taken in conjunction with the advance in trade and shipping, the diminution in emigration, and the prosperity of the savings banks, points to a favourable state in the condition of the people.

Communications.—The roads are divided into national or royal roads, placed directly under the control of the *waterstaat* and supported by the state; provincial roads, under the direct control of the states of the provinces, and almost all supported by the provincial treasuries; communal and polder roads, maintained by the communal authorities and the polder boards; and finally, private roads. The system of national roads, mainly constructed between 1821 and 1827, but still in process of extension, brings into connexion nearly all the towns.

The canal system of Holland is peculiarly complete and extends into every part of the country, giving to many inland towns almost a maritime appearance. The united length of the canals exceeds 1500 m.

Canals.—As a matter of course the smaller streams have been largely utilized in their formation, while the necessity for a comprehensive drainage system has also contributed in no small degree. During the years 1815–1830 a large part of the extensive scheme of construction inaugurated by King William I. was carried out, the following canals, among others, coming into existence in that period: the North Holland ship canal (depth, 16½ ft.) from Amsterdam to den Helder, the Grit canal between Apeldoorn and Hattem, the Willemsvaart connecting Zwolle with the Ysel, the Zuid Willemsvaart, or South William's canal (6½ ft.), from 's Hertogenbosch to Maastricht, and the Tenuzen-Ghent ship canal. After 1849 the canal programme was again taken up by the state, which alone or in conjunction with the provincial authorities constructed the Apeldoorn-Dieren canal (1859–1869), the drainage canals of the "Peel" marsh in North Brabant, and of the eastern provinces, namely, the Deurne canal (1876–1892) from the Maas to Helenaveen, the Almelo (1851–1858) and Overysel (1884–1898) canals from Zwolle, Deventer and Almelo to Koevorden, and the Stieltjes (1880–1884), and Orange (1853–1858 and 1881–1889) canals in Drente, the North Williams canal (1856–1862) between Assen and Groningen, the Ems (1866–1876) ship canal from Groningen to Delfzijl, and the New Merwede, and enlarged the canal from Harlingen by way of Leeuwarden to the Lauwers Zee. The large ship canals to Rotterdam and Amsterdam, called the New Waterway and the North Sea canal respectively, were constructed in 1866–1872 and 1865–1876 at a cost of 2½ and 3 million pounds sterling, the former by widening the channel of the Scheur north of Rozenburg, and cutting across the Hook of Holland, the latter by utilizing the bed of the Y and cutting through the dunes at Ymuiden. In 1876 an agreement was arrived at with Germany for connecting the important drainage canals in Overysel, Drente and Groningen with the Ems canal system, as a result of which the Almelo-Noordhorn (1884–1888) and other canals came into existence.

The canals differ in character in the different provinces. In Zealand they connect the towns of the interior with the sea or the river mouths; for example, the one from Middelburg to Veere and Flushing (1866–1878), from Goes to the East Scheldt, and from Zierikzee also to the East Scheldt. The South Beveland (1862–1866) canal connects the East and West Scheldt; similarly in South Holland the Voorn canal unites the Haringvliet with the New Maas, which does not allow the passage of large vessels above Brielle; whilst owing to the banks and shallows in front of Hellevoetsluis the New Waterway was cut to Rotterdam. Of another character is the Zederik canal, which unites the principal river of central Holland, the Lek, at Vianen by means of the Lingse with the Merwede at Gorkum. Amsterdam is connected with the Lek and the Zederik canal via Utrecht by the Vecht and the Vaart Rhine (1881–1893; depth 10·2 ft.). Again, a totally different character belongs to the canals in North Brabant, and the east and north-east of Holland where, in the absence of great rivers, they form the only waterways which render possible the drainage of the fens and the export of

peat; and unite the lesser streams with each other. Thus in Overysel, in addition to the canals already mentioned, the Dedemsvaart connects the Vecht with the Zwaarte Water near Hasselt; in Drente the Smildervaart and Drentsche Hoofdvaart unites Assen with Meppel, and receives on the eastern side the drainage canals of the Drente fens, namely, the Orange canal and the Hoogeven Vaart (1850–1860; 1880–1893). Groningen communicates with the Lauwers Zee by the Reitdiep (1873–1876), while the canal to Winschoten and the Stadskanaal, or State canal (1877–1880), bring it into connexion with the flourishing fen colonies in the east of the province and in Drente. In Friesland, finally, besides the ship canal from Harlingen to the Lauwers Zee there are canals from Leeuwarden to the Lemmer, whence there is a busy traffic with Amsterdam; and the Caspar Robles or Kolonels Diap, and the Hoendiep connect it with Groningen.

The construction of railways was long deferred and slowly accomplished. The first line was that between Amsterdam and Haarlem, opened in 1839 by the Holland railway company (*Hollandsch Railways. Yzeren Spoorweg Maatschappij*). In 1845 the state undertook to develop the railway system, and a company of private individuals was formed to administer it under the title of the *Maatschappij tot Exploitatie van Staatspoorwegen*. In 1860, however, the total length of railways was only 208 m., and in that year a parliamentary bill embodying a comprehensive scheme of construction was adopted. By 1872 this programme was nearly completed, and 542 m. of new railway had been added. In 1873 and 1875 a second and a third bill provided for the extension of the railway system at the cost of the state, and, in 1876, 1882 and 1890 laws were introduced readjusting the control of the various lines, some of which were transferred to the Holland railway. The state railway system was completed in 1892, and since that time the utmost that the state has done has been to subsidize new undertakings. These include various local lines such as the line Alkmaar-Hoorn (1898), Ede-Barneveld-Nykerk, Enschedé-Ahaus in Germany (1902), Leeuwarden to Franeker, Harlingen and Dokkum, and the line Zwolle-Almelo (junction at Marienburg) Koevorden-Stadskanaal-Veendam-Delfzijl, connecting all the fen countries on the eastern borders. The electric railway Amsterdam-Zandvoort was opened in 1904. The frame upon which the whole network of the Dutch railways may be said to depend is formed of two main lines from north and south and four transverse lines from west to east. The two longitudinal lines are the railway den Helder via Haarlem (1862–1867),¹ Rotterdam (1839–1847), and Zwaluwe (1869–1877) to Antwerp (1852–1855), belonging to the Holland railway company, and the State railway from Leeuwarden and Groningen (1870) (junction at Meppel, 1867) Zwolle (1866)—Arnhem (1865)—Nijmegen (1870)—Venlo (1883)—Maastricht (1865). The four transverse lines belong to the State and Holland railways alternately and are, beginning with the State railway: (1) the line Flushing (1872)—Rozenaal (1869)—Tilburg (1863)—Bokstel (whence there is a branch line belonging to the North Brabant and Germany railway company via Vechel to Goch in Germany, opened in 1873)—Eindhoven—Venlo and across Prussian border (1866); (2) the line Hook of Holland—Rotterdam (1893)—Dordrecht (1872–1877)—Elat (1882–1885)—Nijmegen (1879)—Cleves, Germany (1865); (3) the line Rotterdam—Utrecht (1866–1869) and Amsterdam—Utrecht—Arnhem (1843–1845) to Emmerich in Germany (1856); this line formerly belonged to the Netherlands-Rhine railway company, but was bought by the state in 1890; and finally (4) the line Amsterdam—Hilversum—Amersfoort—Apeldoorn (1875), whence it is continued (a) via Deventer, Almelo and Hengelo to Salzbieren, Germany (1865); (b) via Zutphen, Hengelo (1865), Enschedé (1866) to Gronau, Germany; (c) via Zutphen (1876) and Ruurlo to Winterswyk (1878). Of these (1) and (2) form the main transcontinental routes in connexion with the steamboat service to England (ports of Queenborough and Harwich respectively). Two other lines of railway, both belonging to the state, also traverse the country west to east, namely, the line Rozenaal—'s Hertogenbosch (1890)—Nijmegen, and in the extreme north, the line from Harlingen through Leeuwarden (1863) and Groningen (1866) to the border at Nieuwe Schans (1869), whence it was connected with the German railways in 1876. The northern and southern provinces are further connected by the lines Amsterdam—Zaandam (1878)—Eukhuizen (1885), whence there is a steam ferry across the Zuider Zee to Stavoren, from where the railway is continued to Leeuwarden (1883–1885); the Netherlands Central railway, Utrecht—Amersfoort—Zwoole—Kampen (1863); and the line Utrecht—'s Hertogenbosch (1868–1869) which is continued southward into Belgium by the lines bought in 1898 from the Grand Central Belge railway, namely, via Tilburg to Turnhout (1867), and via Eindhoven (1866) to Hasselt. In 1892 Greenwich mean time was adopted on the railways and in the post-offices, making a difference of twenty minutes with mean Amsterdam time.

Since 1877 railway communication has been largely supplemented by steam-tramways, which either run along the main roads or across the country on special embankments, while one of them is

¹ The dates indicate the period of construction of the different sections.

carried across the river Yael at Doesburg on a pontoon bridge. The state first began to encourage the construction of these local light railways by means of subsidies in 1893, since when some of the most prominent lines have come into existence, such as Purmerend—Alkmaar (1898), Zutphen—Emmerich (1902), along the Dedemsvaart in Overysel (1902), from 's Hertogenbosch via Utrecht and Eindhoven to Turnhout in Belgium (1898), and especially those connecting the South Holland and Zeeland islands with the railway, namely, between Rotterdam and Numansdorp on the Hollandsch Diep (1898), and from Breda or Bergen-op-Zoom, via Steenberg to St Philipsland, Zierikzee and Broutershaven (1900). An electric tramway connects Haarlem and Zandvoort. The number of passengers carried by the steam-tramways is relatively higher than that of the railways. The value of the goods traffic is not so high, owing, principally, to the want of intercommunication between the various lines on account of differences in the width of the gauge.

Agriculture.—Waste lands are chiefly composed of the barren stretches of heaths found in Drenthe, Overysel, Gelderland and North Brabant. They formerly served to support large flocks of sheep and some cattle, but are gradually transformed by the planting of woods, as well as by strenuous efforts at cultivation. Zeeland and Groningen are the two principal agricultural provinces, and after them follow Limburg, North Brabant, Gelderland and South Holland. The chief products of cultivation on the heavy clay soil are oats, barley and wheat, and on the sand-grounds rye, buckwheat and potatoes. Flax and beetroot are also cultivated on the clay lands. Tobacco, hemp, hops, colza and chicory form special cultures. With the possible exception of oats, the cereals do not suffice for home consumption, and maize is imported in large quantities for cattle-feeding, and barley for the distilleries and breweries. Horticulture and market-gardening are of a high order, and flourish especially on the low fen soil and *geest* grounds along the foot of the dunes in the provinces of North and South Holland. The principal market products are cauliflower, cabbage, onions, asparagus, gherkins, cucumbers, beans, peas, &c. The principal flowers are hyacinths, tulips, crocuses, narcissus and other bulbous plants, the total export of which is estimated at over £200,000. Fruit is everywhere grown, and there is a special cultivation of grapes and figs in the Westland of South Holland. The woods, or rather the plantations, covering 6%, consist of (1) the so-called forest timber (*opgaandhout*; Fr. *arbres de haute futaie*), including the beech, oak, elm, poplar, birch, ash, willow and coniferous trees; and (2) the copse wood (*akkermaal* or *kakhou*), embracing the elder, willow, beech, oak, &c. This forms no unimportant branch of the national wealth.

With nearly 35% of the total surface of the country under permanent pasture, cattle-breeding forms one of the most characteristic industries of the country. The provinces of Friesland, North and South Holland, and Utrecht take the lead as regards both quality and numbers. A smaller, harder kind of cattle and large numbers of sheep are kept upon the heath-lands in the eastern provinces, which also favour the rearing of pigs and bee-culture. Horse-breeding is most important in Friesland, which produces the well-known black breed of horse commonly used in funeral processions. Goats are most numerous in Gelderland and North Brabant. Poultry, especially fowls, are generally kept. Stock-breeding, like agriculture, has considerably improved under the care of the government (state and provincial), which grants subsidies for breeding, irrigation of pasture-lands, the importation of finer breeds of cattle and horses, the erection of factories for dairy produce, schools, &c.

Fisheries.—The fishing industry of the Netherlands may be said to have been in existence already in the 13th century, and in the following century received a considerable impetus from the discovery how to cure herring by William Beukelszoon, a Zeeland fisherman. It steadily declined during the 17th and 18th centuries, however, but again began to revive in the last half of the 19th century. The fisheries are commonly divided into four particular fishing areas, namely, the "deep-sea" fishery of the North Sea, and the "inner" (*binnengatsch*) fisheries of the Wadden, the Zuider Zee, and the South Holland and Zeeland waters. The deep-sea fishery may be further divided into the so-called "great" or "salt-herring" fishery, mainly carried on from Vlaardingen and Maastricht during the summer and autumn, and the "fresh-herring" fishery, chiefly pursued at Scheveningen, Katwijk and Noordwijk. The value of the herring fisheries is enhanced by the careful methods of smoking and salting, the export of salted fish being considerable. In the winter the largest boats are laid up and the remainder take to line-fishing.

Middelharnis, Pernis and Zwartewaal are the centres of this branch of fishery, which yields halibut, cod, ling and haddock. The trawl fisheries of the coast yield sole, plaice, turbot, brill, skate, &c., of which a large part is brought alive to the market. In the Zuider Zee small herring, flat fish, anchovies and shrimps are caught, the chief fishing centres being the islands of Texel, Urk and Wieringen, and the coast towns of Helder, Bunschoten, Huizen, Enkhuizen, Vollandam, Kampen, Harderwyk, Vollenhove. The anchovy fishing which takes place in May, June and July sometimes yields very productive results. Oysters and mussels are obtained on the East Scheldt, and anchovies at Bergen-op-Zoom; while salmon, perch and pike are caught in the Maas, the Lek and the New Merwede. The oyster-beds and salmon fisheries are largely in the hands of the state, which lets them to the highest bidder. Large quantities of eels are caught in the Frisian lakes. The fisheries not only supply the great local demand, but allow of large exports.

Manufacturing Industries.—The mineral resources of Holland give no encouragement to industrial activity, with the exception of the coal-mining in Limburg, the smelting of iron ore in a few furnaces in Overysel and Gelderland, the use of stone and gravel in the making of dikes and roads, and of clay in brick-works and potteries, the quarrying of stone at St Pietersberg, &c. Nevertheless the industry of the country has developed in a remarkable manner since the separation from Belgium. The greatest activity is shown in the cotton industry, which flourishes especially in the Twente district of Overysel, where jute is also worked into sacks. In the manufacture of woollen and linen goods Tilburg ranks first, followed by Leiden, Utrecht and Eindhoven; that of half-woollens is best developed at Roermond and Helmond. Other branches of industry include carpet-weaving at Deventer, the distillation of brandy, gin and liqueurs at Schiedam, Rotterdam and Amsterdam, and beer-brewing in most of the principal towns; shoe-making and leather-tanning in the Langstraat district of North Brabant; paper-making at Apeldoorn, on the Zaan, and in Limburg; the manufacture of earthenware and faience at Maastricht, the Hague and Delft, as well as at Utrecht, Purmerend and Makkum; clay pipes and stearine candles at Gouda; margarine at Osch; chocolate at Weesp and on the Zaan; mat-plaiting and broom-making at Genemuiden and Blokzijl; diamond-cutting and the manufacture of quinine at Amsterdam; and the making of cigars and snuff at Eindhoven, Amsterdam, Utrecht, Kampen, &c. Shipbuilding is of no small importance in Holland, not only in the greater, but also in the smaller towns along the rivers and canals. The principal shipbuilding yards are at Amsterdam, Kinderdijk, Rotterdam and at Flushing, where there is a government dockyard for building warships.

Trade and Shipping.—To obtain a correct idea of the trade of Holland, greater attention than would be requisite in the case of other countries must be paid to the inland traffic. It is impossible to state the value of this in definite figures, but an estimate may be formed of its extent from the number of ships which it employs in the rivers and canals, and from the quantity of produce brought to the public market. In connexion with this traffic there is a large fleet of tug boats; but steam- or petroleum-propelled barges are becoming more common. Some of the lighters used in the Rhine transport trade have a capacity of 3000 tons. A great part of the commercial business at Rotterdam belongs to the commission and transit trade. The other principal ports are Flushing, Terneuzen (for Belgium), Harlingen, Delfzijl, Dordrecht, Zaandam, Schiedam, Groningen, den Helder, Middelburg, Vlaardingen. Among the national mail steamship services are the lines to the East and West Indies, Africa and the United States. An examination of its lists of exports and imports will show that Holland receives from its colonies its spices, coffee, sugar, tobacco, indigo, cinnamon; from England and Belgium its manufactured goods and coals; petroleum, raw cotton and cereals from the United States; grain from the Baltic provinces, Archangel, and the ports of the Black Sea; timber from Norway and the basin of the Rhine, yarn from England, wine from France, hops from Bavaria and Alsace; iron-ore from Spain; while in its turn it sends its colonial wares to Germany, its agricultural produce to the London market, its fish to Belgium and Germany, and its cheese to France, Belgium and Hamburg, as well as England. The bulk of trade is carried on with Germany and England; then follow Java, Belgium, Russia, the United States, &c. In the last half of the 19th century the total value of the foreign commerce was more than trebled.

Constitution and Government.—The government of the Netherlands is regulated by the constitution of 1815, revised in 1848 and 1887, under which the sovereign's person is inviolable and

the ministers are responsible. The age of majority of the sovereign is eighteen. The crown is hereditary in both the male and the female line according to primogeniture; but it is only in default of male heirs that females can come to the throne. The crown prince or heir apparent is the first subject of the sovereign, and bears the title of the prince of Orange. The sovereign alone has executive authority. To him belong the ultimate direction of foreign affairs, the power to declare war and peace, to make treaties and alliances, and to dissolve one or both chambers of parliament, the supreme command of the army and navy, the supreme administration of the state finances and of the colonies and other possessions of the kingdom, and the prerogative of mercy. By the provisions of the same constitution he establishes the ministerial departments, and shares the legislative power with the first and second chambers of parliament, which constitute the states-general and sit at the Hague. The heads of the departments to whom the special executive functions are entrusted are eight in number—ministers respectively of the interior, of "water-staat," trade and industry (that is, of public works, including railways, post-office, &c.), of justice, of finance, of war, of marine, of the colonies and of foreign affairs. There is a department of agriculture, but without a minister at its head. The heads of departments are appointed and dismissed at the pleasure of the sovereign, usually determined, however, as in all constitutional states, by the will of the nation as indicated by its representatives.

The number of members in the first chamber is 50, South Holland sending 10, North Holland 9, North Brabant and Gelderland each 6, Friesland 4, Overysel, Limburg and Groningen each 3, Zeeland, Utrecht and Drente each 2. According to the fundamental law (*Grondwet*) of 1837, they are chosen by the provincial states, not only from amongst those who bear the greatest burden of direct taxation in each province, but also from amongst great functionaries and persons of high rank. Those deputies who are not resident in the Hague are entitled to receive 16s. 8d. a day during the session. The duration of parliament is nine years, a third of the members retiring every three years. The retiring members are eligible for re-election. The members of the second chamber are chosen in the electoral districts by all capable male citizens not under 23 years of age, who pay one or more direct taxes, ranging from a minimum of one guilder (1s. 8d.) towards the income tax. The number of members is 100, Amsterdam returning 9, Rotterdam 5, the Hague 3, Groningen and Utrecht 2 members each. Members must be at least thirty years old, and receive an annual allowance of £166, besides travelling expenses. They only, and the government, have the right of initiating business, and of proposing amendments. Their term is four years, but they are re-eligible. All communications from the sovereign to the states-general and from the states to the sovereign, as well as all measures relating to internal administration or to foreign possessions, are first submitted to the consideration of the council of state, which consists of 14 members appointed by the sovereign, who is the president. The state council also has the right of making suggestions to the sovereign in regard to subjects of legislation and administration.

The provincial administration is entrusted to the provincial states, which are returned by direct election by the same electors as vote for the second chamber. The term is for six years, but one-half of the members retire every three years subject to re-election or renewal. The president of the assembly is the royal commissioner for the province. As the provincial states only meet a few times in the year, they name a committee of deputy-states which manages current general business, and at the same time exercises the right of control over the affairs of the communes. At the head of every commune stands a communal council, whose members must be not under 23 years of age. They are elected for six years (one-third of the council retiring every two years) by the same voters as for the provincial states. Communal franchise is further restricted, however, to those electors who pay a certain sum to the communal rates. The number of councillors varies according to the population between 7 and 45. One of the special duties of the council is the supervision of education. The president of the communal council is the burgomaster, who is named by the sovereign in every instance for six years, and receives a salary varying from £40 to over £600. Provision is made for paying the councillors a certain fee—called

"presence-money"—when required. The burgomaster has the power to suspend any of the council's decrees for 30 days. The executive power is vested in a college formed by the burgomaster and two, three or four magistrates (*wethouders*) to be chosen by and from the members of the council. The provinces are eleven in number.

National Defence.—The home defence system of Holland is a militia with strong cadres based on universal service. Service in the "militia" or 1st line force is for 8 years, in the 2nd line for 7. Every year in the drill season contingents of militiamen are called up for long or short periods of training, and the maximum peace strength under arms in the summer is about 35,000, of whom half are permanent cadres and half militiamen. In 1908 17,300 of the year's contingent were trained for eight months and more, and 5200 for four months. The war strength of the militia is 105,000, that of the second line or reserve 70,000. The defence of the country is based on the historic principle of concentrating the people and their resources in the heart of the country, covered by a wide belt of inundations. The chosen line of defence is marked by a series of forts which control the sluices, extending from Amsterdam, through Muiden, thence along the Vecht and through Utrecht to Gorinchem (Gorkum) on the Waal. The line continues thence by the Hollandsche Diep and Volkerak to the sea, and the coast also is fortified. The army in the colonies numbers in all about 26,000, all permanent troops and for the most part voluntarily enlisted European regulars. The military expenditure in 1908 was £2,331,255. The Dutch navy at home and in Indian waters consists (1909) of 9 small battleships, 6 small cruisers and 80 other vessels, manned by 8600 officers and men of the navy and about 2250 marines. Recruiting is by voluntary enlistment, with contingent powers of conscription amongst the maritime population.

Justice.—The administration of justice is entrusted (1) to the high council (*hooge raad*) at the Hague, the supreme court of the whole kingdom, and the tribunal for all high government officials and for the members of the states-general; (2) to the five courts of justice established at Amsterdam, the Hague, Arnhem, Leeuwarden and 's Hertogenbosch; (3) to tribunals established in each arrondissement; (4) to cantonal judges appointed over a group of communes, whose jurisdiction is restricted to claims of small amount (under 200 guilders), and to breaches of police regulations, and who at the same time look after the interest of minors. The high council is composed of 12 to 14 councillors, a procureur-general and three advocates-general. Criminal and correctional procedure were formerly divided between the courts of justice and the arrondissement tribunals; but this distinction was suppressed by the penal code of 1836, thereby increasing the importance of the arrondissement courts, which also act as court of appeal of the cantonal courts.

Besides the prisons, which include one built on the cellular principle at Breda, the state supports three penal workhouses for drunkards and beggars. There are also the penal colonies at Veenhuizen in Drente, which were brought from the Society of Charity (*Maatschappij van Weldadigheid*) in 1859. The inmates practise agriculture, as well as various industries for supplying all the requirements of the colony. The objection raised against these establishments is that the prisoners do not represent the real vagabondage of the country; but a class of more or less voluntary inmates. Children under 16 years of age are placed in the three state reformatories, and there is an institution for vagabond women at Rotterdam.

Charitable and other Institutions.—Private charities have always occupied a distinguished position in the Netherlands, and the principle of the law of 1854 concerning the relief of the poor is, that the state shall only interfere when private charity fails. All private and religious institutions have to be inscribed before they can collect public funds. In some cases these institutions are organized and administered conjointly with the civil authorities. At the head of the charitable institutions stand the agricultural colonies belonging to the Society of Charity (see DRENTE). Of the numerous institutions for the encouragement of the sciences and the fine arts, the following are strictly national—the Royal Academy of Sciences (1855), the Royal Netherlands Meteorological Institute (1844), the National Academy of the Plastic Arts, the Royal School of Music, the National Archives, besides various other national collections and museums. Provincial scientific societies exist at Middelburg, Utrecht, 's Hertogenbosch and Leeuwarden, and there are private and municipal associations, institutions and collections in a large number of the smaller towns. Among societies of general utility are the Society for Public Welfare (*Maatschappij tot nut van 't algemeen*, 1785), whose efforts have been mainly in the direction of educational reform; the Geographical Society at Amsterdam (1873); Teyler's Stichting or foundation at Haarlem (1778), and the societies for the promotion of industry (1777), and of sciences (1752) in the same town; the Institute of Languages, Geography and Ethnology of the Dutch Indies (1851), and the Indian Society at the Hague, the Royal Institute of Engineers at Delft (1848), the Association for the Encouragement of Music at Amsterdam, &c.

Religion.—Religious conviction is one of the most characteristic traits of the Dutch people, and finds expression in a large number of independent religious congregations. The bond between church

and state which had been established by the synod of Dort (1618) and the organization of the Low-Dutch Reformed Church (*Nederlandsche Hervormde Kerk*) as the national Protestant church, practically came to an end in the revolution of 1795, and in the revision of the Constitution in 1848 the complete religious liberty and equality of all persons and congregations was guaranteed. The present organization of the Reformed Church dates from 1852. It is governed by a general assembly or "synod" of deputies from the principal judicatories, sitting once a year. The provinces are subdivided into "classes," and the classes again into "circles" (*ringen*), each circle comprising from 5 to 25 congregations, and each congregation being governed by a "church council" or session. The provincial synods are composed of ministers and elders deputed by the classes; and these are composed of the ministers belonging to the particular class and an equal number of elders appointed by the local sessions. The meetings of the circles have no administrative character, but are mere brotherly conferences. The financial management in each congregation is entrusted to a special court (*kerkvoogdij*) composed of "notables" and church wardens. In every province there is besides, in the case of the Reformed Church, a provincial committee of supervision for the ecclesiastical administration. For the whole kingdom this supervision is entrusted to a common "collegium" or committee of supervision, which meets at the Hague, and consists of 11 members named by the provincial committee and 3 named by the synod. Some congregations have withdrawn from provincial supervision, and have thus free control of their own financial affairs. The oldest secession from the Orthodox Church is that of the Remonstrants, who still represent the most liberal thought in the country, and have their own training college at Leiden. Towards 1840 a new congregation calling itself the Christian Reformed Church (*Christelijke Gereformeerde Kerk*) arose as a protest against the government and the modern tendencies of the Reformed Church; and for the same reason those who had founded the Free University of Amsterdam (1880) formed themselves in 1886 into an independent body called the *Nederlandsche Gereformeerde Kerk*. In 1892 these two churches united under the name of the Reformed Churches (*Gereformeerde Kerken*) under the doctrine and discipline of Dort. They have a theological seminary at Kampen. Other Protestant bodies are the Walloons, who, though possessing an independent church government, are attached to the Low-Dutch Reformed Church; the Lutherans, divided into the main body of Evangelical Lutherans and a smaller division calling themselves the Re-established or Old Lutherans (*Herstelde Lutherachen*) who separated in 1791 in order to keep more strictly to the Augsburg confession; the Mennonites founded by Menno Simons of Friesland, about the beginning of the 16th century; the Baptists, whose only central authority is the General Baptist Society founded at Amsterdam in 1811; the Evangelical Brotherhood of Hernhutters or Moravians, who have churches and schools at Zeist and Haarlem; and a Catholic Apostolic Church (1867) at the Hague. There are congregations of English Episcopalians at the Hague, Amsterdam and Rotterdam, and German Evangelicals at the Hague (1857) and Rotterdam (1861). In 1853 the Roman Catholic Church, which before had been a mission in the hands of papal legates and vicars, was raised into an independent ecclesiastical province with five dioceses, namely, the archbishopric of Utrecht, and the suffragan bishoprics of Haarlem, Breda, 's Hertogenbosch and Roermond, each with its own seminary. Side by side with the Roman Catholic hierarchy are the congregations of the Old Catholics or Old Episcopalian Church (*Oud Bisschoppelijke Cleren*), and the Jansenists (see JANSENISM). The Old Catholics, with whom the Jansenists are frequently confused, date from the 17th century. Besides an archbishop at Utrecht, the Old Catholics have bishops at Deventer and Haarlem, and a training college at Amersfoort. They numbered in 1905 about 6000 (see UTRACHT). The large Jewish population in Holland had its origin in the wholesale influx of Portuguese Jews at the end of the 16th, and of German Jews in the beginning of the 17th century. In 1870 they were reorganized under the central authority of the Netherlands Israelite Church, and divided into head and "ring" synagogues and associated churches. The Roman Catholic element preponderates in the southern provinces of Limburg, and North Brabant, but in Friesland, Groningen and Drenthe the Baptists and Christian Reformed are most numerous.

Education.—Every grade of education in the Netherlands is under the control and supervision of the state, being administered by a special department under the ministry for the interior. In 1889 the state recognized private denominational schools, and in 1900 passed a law of compulsory attendance. Infant schools, which are generally in the hands of private societies or the municipal authorities, are not interfered with by the state. According to the law of 1889 primary education is carried on in the ordinary and in continuation schools for boys and girls (co-education having been long in vogue). These schools are established in every commune, the state contributing aid at the rate of 25% of the total expenditure. The age of admission is six; and the course is for six years, 7-13 being the legal age limits; the fee, from which poverty exempts, is almost nominal. Nature-study, continued in the secondary schools, is an essential part in the curriculum of these schools, and elementary general history, English, French and German are among

the optional subjects. While the boys are instructed in woodwork, needlework is taught to the girls, its introduction in 1889 having been the first recognition of practical instruction in any form. Continuation schools (*herhalingscholen*) must be organized wherever required, and are generally open for six months in winter, pupils of twelve to fourteen or sixteen attending. Secondary schools were established by the law of 1863 and must be provided by every commune of 10,000 inhabitants; they comprise the Burgher-Day-and-Evening schools and the Higher-Burgher schools. The first named schools being mainly intended for those engaged in industrial or agricultural pursuits, the day classes gradually fell into disuse. The length of the course as prescribed by law is two years, but it is usually extended to three or four years, and the instruction, though mainly theoretical, has regard to the special local industries; the fees, if any, may not exceed one pound sterling per annum. Special mention must be made in this connection of the school of engineering in Amsterdam (1878) and the Academy of Plastic Arts at Rotterdam. The higher-burgher schools have either a three or a five years' course, and the fees vary from £2. 10s. to £5 a year. The instruction given is essentially non-classical and scientific. In both schools certificates are awarded at the end of the course, that of the higher-burgher schools admitting to the natural science and medical branches of university education, a supplementary examination in Greek and Latin being required for other branches. The gymnasia, or classical schools, fall legally speaking under the head of higher education. By the law of 1876, every town of 20,000 inhabitants, unless specially exempted, must provide a gymnasium. A large proportion of these schools are subsidized by the state to the extent of half their net cost. The curriculum is classical and philological, but in the two upper classes there is a bifurcation in favour of scientific subjects for those who wish. The fees vary from £5 to £8 a year, but, owing to the absence of scholarships and bursaries, are sometimes remitted, as in the case of the higher-burgher schools. Among the schools which give specialized instruction, mention must be made of the admirable trade schools (*ambachtsscholen*) established in 1861, and the corresponding industrial schools for girls; the fishery schools and schools of navigation; the many private schools of domestic science, and of commerce and industry, among which the municipal school at Enschedé (1886) deserves special mention; and the school of social work, "Dea Huis," at Amsterdam (1900). For the education of medical practitioners, civil and military, the more important institutions are the National Obstetrical College at Amsterdam, the National Veterinary School at Utrecht, the National College for Military Physicians at Amsterdam and the establishment at Utrecht for the training of military apothecaries for the East and West Indies. The organization of agricultural education under the state is very complete, and includes a state professor of agriculture for every province (as well as professors of horticulture in several cases), "winter schools" of agriculture and horticulture, and a state agricultural college at Wageningen (1876) with courses in home and colonial agriculture. The total fees at this college, including board and lodging, are about £50 a year. According to the law of 1898, the state also maintains or subsidizes experimental or testing-stations. Other schools of the same class are the Gerard Adriaan van Swieten schools of agriculture, gardening and forestry in Drenthe, the school of instruction in butter and cheese making (*smoltbereiding*) at Bolsward and the state veterinary college at Utrecht.

There are three state universities in Holland, namely, Leiden (1575), Groningen (1585) and Utrecht (1634). The ancient Athenaeums of Franeker (1585) and Harderwyk (1603) were closed in 1811, but that of Amsterdam was converted into a municipal university in 1877. In each of these universities there are five faculties, namely, law, theology, medicine, science and mathematics, and literature and philosophy, the courses for which are respectively four, five, eight, and six or seven years for the two last named. The fees amount to 200 florins (£16, 13s. 4d.) per annum and are payable for four years. Two kinds of degrees are conferred, namely, the ordinary (*candidaats*) and the "doctor's" degrees. Pupils from the higher-burgher schools are only eligible for the first. There is also a free (Calvinistic) university at Amsterdam founded in 1880 and enjoying, since 1905, the right of conferring degrees. It has, however, no faculties of law or science. The state polytechnic school at Delft (1864) for the study of engineering in all its branches, architecture and naval construction, has a nominal course of four years, and confers the degree of "engineer." The fees are the same as those of the universities, and as at the universities there are bursaries. A national institution at Leiden for the study of languages, geography and ethnology of the Dutch Indies has given place to communal institutions of the same nature at Delft and at Leiden, founded in 1864 and 1877. The centre of Dutch university life, which is non-residential, is the students' corps, at the head of which is a "senate," elected annually from among the students of four years' standing. Membership of the corps is gained after a somewhat trying novitiate, but is the only passport to the various social and sports societies.

All teachers in the Netherlands must qualify for their profession by examination. Under the act of 1898 they are trained either in the state training-colleges, or in state-aided municipal, and private

denominational colleges; or else by means of state or private state-aided courses of instruction. The age of admission to this class of training is from 14 to 18, and the course is for four years. In the last year practice in teaching is obtained at the primary "practice" school attached to each college, and students are also taught to make models explanatory of the various subjects of instruction after the manner of the Swedish Sloyd (Slöjd) system. Assistant-teachers wishing to qualify as head-teachers must have had two years' practical experience. Pupil-teachers can only give instruction under the supervision of a certificated teacher. The minimum salary of teachers is determined by law. The teaching, which follows the so-called "Heuristic" method, and the equipment of schools of every description, are admirable.

Finance.—The following statement shows the revenue and expenditure of the kingdom for the years 1889, 1900-1901 and 1905—

Revenue.			
Source.	1889.	1901.	1905.
	£	£	£
Excise	3,678,075	4,042,500	4,514,908
Direct taxation	2,300,865	2,900,175	3,135,665
Indirect taxation	2,994,745	1,805,583	1,946,666
Post Office	539,405	865,750	1,103,333
Government telegraphs	106,970	187,375	211,333
Export and Import duties	440,247	801,500	930,912
State domains	213,186	147,000	139,000
Pilot dues	106,079	191,667	200,000
State lotteries	54,609	54,250	52,666
Game and Fisheries	11,660	11,000	11,750
Railways	361,512	349,011
Part paid by East Indies on account of interest and redemption of public debt	321,916
Netherland Bank contribution	160,500
Total ¹	9,475,337	11,394,220	14,017,079

Expenditure.			
Object.	1889.	1901.	1905.
	£	£	£
National Debt	2,727,591	2,906,214	2,899,770
Department of War	1,798,698	1,893,036	2,474,011
" Waterstaat	1,790,291	2,448,339	2,869,951
" Finance	1,537,404	2,092,343	2,297,180
" Marine	1,038,536	1,388,141	1,396,137
" Interior	815,188	1,330,563	1,613,134
" Justice	496,343	529,159	592,073
" Colonies	93,829	109,768	251,150
Dept. of Foreign Affairs	57,312	71,101	82,493
Royal Household	54,166	66,667	66,666
Superior Authorities of the State	52,476	56,792	58,251
Unforeseen Expenditure	1,745	4,166	4,166
Total ¹	10,393,579	12,896,289	14,907,781

The total debt in 1905 amounted to 196,764,266, the annual interest amounting to £3,396,590. During the years 1850-1905, £27,416,651 has been devoted to the redemption of the public debt. The total wealth of the kingdom is estimated at 900 millions sterling. The various provinces and communes have separate budgets. The following table gives a statement of the provincial and communal finances:—

Revenue.			
	1889.	1900.	1905.
	£	£	£
Provincial	722,583	445,333	718,199
Communal	6,132,000	9,311,666	12,750,083

Expenditure.			
	1889.	1900.	1905.
	£	£	£
Provincial	740,333	445,333	702,718
Communal	5,683,800	8,503,250	12,085,250

¹ Including various miscellaneous items not specified in detail.

² Including, besides the ordinary budget, the outlays in payment of annuities, in funding and discharging debt, in railway extension, &c.

Colonies.—The Dutch colonies in the Malay Archipelago have an area of 600,000 sq. m., with a population of 23,000,000, among which are 35,000 Europeans, 319,000 Chinese, 15,000 Arabs, and 10,000 other immigrant Asiatics. The West Indian possessions of Holland include Dutch Guiana or the government of Surinam, and the Dutch Antilles or the government of Curaçoa and its dependencies (St Eustatius, Saba, the southern half of St Martin, Curaçoa, Bonaire and Aruba), a total area of 60,000 sq. m., with 90,000 inhabitants, of whom a small portion are Europeans, and the rest negroes and other people of colour, and Chinese.

BIBLIOGRAPHY.—The chief place is due to the following geographical publications:—Dr H. Blink, *Nederland en zijne Bewoners* (Amsterdam, 1888-1892), containing a copious bibliography; *Tegenwoordige Staat van Nederland* (Amsterdam, 1897); R. Schulling, *Aardrijkskunde van Nederland* (Zwolle, 1884); A. A. Beckman, *De Strijd om het Bestaan* (Zutphen, 1887), a manual on the characteristic hydrography of the Netherlands; and E. Reuch, *Nouvelle géographie universelle* (1879; vol. iv.). The *Gedienboek uitgeven ter gelegenheid van het vijfjig-jarig bestaan van het Koninklijk Instituut van Ingenieurs, 1847-1897* ('s Gravenhage, 1898), is an excellent aid in studying technically the remarkable works on Dutch rivers, canals, sluices, railways and harbours, and drainage and irrigation works. The *Aardrijkskundig Woordenboek van Nederland*, by P. H. Witkamp (Arnhem, 1895), is a complete gazetteer with historical notes, and *Nomina Geographica Neerlandica*, published by the Netherlands Geographical Society (Amsterdam, 1885, &c.), contains a history of geographical names. *Geschiedenis van den Boereestand en den landbouw in Nederland*, H. Blink (Groningen, 1902), and the report on agriculture, published at the Hague by the Royal Commission appointed in 1896, furnish special information in connexion with this subject. Of more general interest are: *Eene halve Eeuwe, 1848-1898*, edited by Dr P. H. Ritter (Amsterdam, 1898), containing a series of articles on all subjects connected with the kingdom during the second half of the 19th century, written by specialists; and *Les Pays Bas* (Leiden, 1899), and *La Hollande géographique, ethnologique, politique, &c.* (Paris, 1900), both works of the same class as the preceding.

Books of travel include some of considerable topographical as well as literary interest, from Lodovico Guicciardini (1567) down to Edmondo de Amicis (*Holland*, translated from the Italian, London, 1883); H. Havard, *Dead Cities of the Zuider Zee, &c.* (translated from the French, London 1876), and D. S. Meldrum, *Holland and the Hollanders* (London, 1896) in the 19th century. Mention may also be made of *Old Dutch Towns and Villages of the Zuider Zee*, by W. J. Tuyn (translated from the Dutch, London, 1901), *Nieuwe Wandelingen door Nederland*, by J. Craandijk and P. A. Schippers (Haarlem, 1888); *Friesland Meres and through the Netherlands*, by H. M. Doughty (London, 1887); *On Dutch Waterways*, by G. C. Davis (London, 1887); *Hollands et hollandais*, by H. Durand (Paris, 1893); and *Holland and Belgium* by Professor N. G. van Kampen (translated from the Dutch, London, 1860), the last three being chiefly remarkable for their fine illustrations. Works of historical and antiquarian interest of a high order are *Merkwaaardige Kasteelen in Nederland*, by J. van Lennep and W. J. Hofdyk (Leiden, 1881-1884); *Noord-Hollandsche Oudheden*, by G. van Arkel and A. W. Weisman, published by the Royal Antiquarian Society (Amsterdam, 1891); and *Oud Holland*, edited by A. D. de Vries and N. de Roever (Amsterdam, 1883-1886), containing miscellaneous contributions to the history of ancient Dutch art, crafts and letters. Natural history is covered by various periodical publications of the Royal Zoological Society "Natura Artis Magistra" at Amsterdam, and the *Natuurlijke Historie van Nederland* (Haarlem, 1856-1863) written by specialists, and including ethnology and flora. Military and naval defence may be studied in *De vesting Holland*, by A. L. W. Seiffardt (Utrecht, 1887), and the *Handbook of the Dutch Army*, by Major W. L. White, R.A. (London, 1896); ecclesiastical history in *The Church in the Netherlands*, by P. H. Ditchfield (London, 1893); and education in vol. viii. of the *Special Reports on Educational Subjects* issued by the Board of Education, London. Statistics are furnished by the annual publication of the Society for Statistics in the Netherlands, Amsterdam.

HISTORY FROM 1579 TO MODERN TIMES³

The political compact known as the Union of Utrecht differed from its immediate predecessors, the Pacification of Ghent, the Union of Brussels and the Perpetual Edict, in its permanence. The confederacy of the northern provinces of the Netherlands which was effected (20th of January 1579) by the exertions of John of Nassau, was destined to be the beginning of a new national life. The foundation was laid on which the Republic of the

Consequences of the Union of Utrecht.

³ For the history of the Netherlands previous to the confederacy of the northern provinces in 1579 see NETHERLANDS.

United Netherlands was to be raised. Its immediate results were far from promising. The falling away of the Walloon provinces and the Catholic nobles from the patriot cause threatened it with ruin. Nothing but the strong personal influence and indefatigable labours of the prince of Orange stood in the way of a more general defection. Everywhere, save in staunch and steadfast Holland and Zeeland, a feeling of wavering and hesitation was spreading through the land. In Holland and Zeeland William was supreme, but elsewhere his aims and his principles were misrepresented and misunderstood. He saw that unaided the patriotic party could not hope to resist the power of Philip II., and he had therefore resolved to gain the support of France by the offer of the sovereignty of the Netherlands to the duke of Anjou. But Anjou was a Catholic, and this fact aroused among the Protestants a feeling that they were being betrayed. But the prince persisted in the policy he felt to be a necessity, and (23rd of Jan. 1581) a treaty was concluded with the duke, by which he, under certain

conditions, agreed to accept the sovereignty of the Netherland provinces, except Holland and Zeeland. These two provinces were unwilling to have any sovereign but William himself, and after considerable hesitation he agreed to become their Count (24th of July 1581). He felt that he was justified in taking this step because of the Ban which Philip had published on the 15th of March 1581, in which Orange had been proclaimed a traitor and miscreant, and a reward offered to any one who would take his life. His practical answer to the king was the act of Abjuration, by which at his persuasion the representatives of the provinces of Brabant, Flanders, Holland, Zeeland, Gelderland and Utrecht, assembled at the Hague, declared that Philip had forfeited his sovereignty over them, and that they held themselves henceforth absolved from their allegiance to him. In a written defence, the famous *Apology*, published later in the year, William replied at great length to the charges that had been brought against him, and carrying the war into the enemy's camp, endeavoured to prove that the course he had pursued was justified by the crimes and tyranny of the king.

The duke of Anjou was solemnly inaugurated as duke of Brabant (February 1582), and shortly afterwards as duke of Gelderland, count of Flanders and lord of Friesland. William had taken up his residence at Antwerp in order to give the French prince his strongest personal support, and while there a serious attempt was made upon his life (March 18th) by a youth named Jean Jaureguy. He fired a pistol at the prince close to his head, and the ball passed under the right ear and out at the left jaw. It was a terrible wound, but fortunately not fatal. Meanwhile Anjou soon grew tired of his dependent position and of the limitations placed upon his sovereignty. He resolved by a secret and sudden attack (17th of January 1583) to make himself master of Antwerp and of the person of Orange. The assault was made, but it proved an utter failure. The citizens resisted stoutly behind barricades, and the French were routed with heavy loss. The "French Fury" as it was called, rendered the position of Anjou in the Netherlands impossible, and made William himself unpopular in Brabant. He accordingly withdrew to Delft. In the midst of his faithful Hollanders he felt that he could still organize resistance, and stem the progress made by Spanish arms and Spanish influence under the able leadership of Alexander of Parma. Antwerp, with St Aldegonde as its burgomaster, was still in the hands of the patriots and barred the way to the sea, and covered Zeeland from invasion. Never for one moment did William lose heart or relax his efforts and vigilance; he felt that with the two maritime provinces secure the national cause need not be despaired of. But his own days had now drawn to their end. The failure of Jaureguy did not deter a young Catholic zealot, by name Balthazar Gérard, from attempting to assassinate the man whom he looked upon as the arch-enemy of

Severely offered to the Duke of Anjou.

The Ban against William of Orange.

The Act of Abjuration.

The Apology.

Attempt on the Life of Orange by Jean Jaureguy.

The French Fury.

God and the king. Under the pretext of seeking a passport, Gérard penetrated into the Prinsenhof at Delft, and firing point blank at William as he left the dining hall, mortally wounded him (10th of July 1584). Amidst general lamentations "the Father of his Country," as he was called, was buried with great state in the Nieuwe Kerk at Delft at the public charge.

But though the great leader was dead, he had not striven or worked in vain. The situation was critical, but there was no panic. Throughout the revolted provinces there was a general determination to continue the struggle to the bitter end. To make head, however, against the victorious advance of Parma, before whose arms all the chief towns of Brabant and Flanders, Bruges, Ghent, Brussels and lastly—after a valiant defence—Antwerp itself had fallen, it was necessary to look for the protection of a foreign ruler. The government, now that the commanding personal influence of William was no more, was without any central authority which could claim obedience. The States-General were but the delegates of a number of sovereign provinces, and amongst these Holland by its size and wealth (after the occupation by the Spaniards of Brabant and Flanders) was predominant. Maurice of Nassau, William's second son, had indeed on his father's death been appointed captain and admiral-general of the Union, president of the Council of State, and stadholder of Holland and Zeeland, but he was as yet too young, only seventeen, to take a leading part in affairs. Count Hohenloo took the command of the troops with the title of lieutenant-general. Two devoted adherents of William of Orange, Paul Buys, advocate of Holland, and Johan van Oldenbarneveldt, pensionary of Rotterdam, were the statesmen who at this difficult juncture took the foremost part in directing the policy of the confederacy. They turned first to France. The sovereignty of the provinces was offered to Henry III., but the king, harassed by civil discords in his own country, declined the dangerous honour (1585). Repelled in this direction, the States-General next turned themselves to England. Elizabeth was alarmed by the successes of the Spanish arms, and especially by the fall of Antwerp; and, though refusing the sovereignty, she agreed to send a force of 5000 foot and 1000 horse to the aid of the Provinces under the command of the earl of Leicester, her expenses being guaranteed by the handing over to her the towns of Flushing, Brill and Rammekens as pledges (10th of August 1585). Leicester, on landing in Holland, was in the presence of the States-General and of Maurice of Nassau invested with the title of governor-general and practically sovereign powers (February 1586).

The new governor had great difficulties to contend with. He knew nothing of the language or the character of the people he was called upon to govern; his own abilities both as general and statesman were mediocre; and he was hampered constantly in his efforts by the niggardliness and changing whims of his royal mistress. In trying to consolidate the forces of the Provinces for united action and to centralize its government, he undoubtedly did his best, according to his lights, for the national cause. But he was too hasty and overbearing. His edict prohibiting all commercial intercourse with the enemy at once aroused against him the bitter hostility of the merchants of Holland and Zeeland, who thrived by such traffic. His attempts to pack the council of State, on which already two Englishmen had seats, with personal adherents and to override the opposition of the provincial states of Holland to his arbitrary acts, at last made his position impossible. The traitorous surrender of Deventer and Zutphen by their English governors, Stanley and York, both Catholics, rendered all Englishmen suspect. The States of Holland under the leadership of Johan van Oldenbarneveldt, took up an attitude of resolute hostility to him, and the States of Holland dominated the States-General. In the midst of these divided councils the important seaport of Sluis was taken by Parma. Utterly discredited, Leicester (6th of August 1587) abandoned the task,

Leicester Government-general.

Maurice of Nassau.

The Sovereignty offered to Henry III. and declined.

Failure and withdrawal of Leicester.

Leicester Government-general.

Leicester Government-general.

in which he had met with nothing but failure, and returned to England.

Nothing could have been worse than the position of the States at the beginning of 1588. Had Parma had a free hand, in all probability he would have crushed out the revolt and reconquered the northern Netherlands. But the attention of the Spanish king was at this time concentrated upon the success of the Invincible Armada.

Johan van Oldenbarnevelt.

The army of Parma was held in readiness for the invasion of England, and the United Provinces had a respite. They were fortunately able to avail themselves of it. The commanding abilities of Oldenbarnevelt, now advocate of Holland, gradually gathered into his hands the entire administration of the Republic. He became indispensable and, as his influence grew, more and more did the policy of the provinces acquire unity and consistency of purpose. At the same time Maurice of

Maurice of Nassau.

Nassau, now grown to man's estate, began to display those military talents which were to gain for him the fame of being the first general of his time. But Maurice was no politician. He had implicit trust in the advocate, his father's faithful friend and counsellor, and for many years to come the statesman and the soldier worked in harmony together for the best interests of their country (see OLDENBARNEVELDT, and MAURICE, prince of Orange). At the side of Maurice, as a wise adviser, stood his cousin William Louis, stadholder of Friesland, a trained soldier and good commander in the field.

After the destruction of the Armada, Parma had been occupied with campaigns on the southern frontier against the French, and the Netherlands had been content to stand on guard against attack. The surprise of Breda by a stratagem (8th of March 1590) was the only military event of importance up to 1591. But the two stadholders had not wasted the time. The States' forces had been reorganized and brought to a high state of military discipline and training.

Campaign of 1591.

In 1591 the States-General, after considerable hesitation, were persuaded by Maurice to sanction an offensive campaign. It was attended by marvellous success. Zutphen was captured on the 20th of May, Deventer on the 20th of June. Parma, who was besieging the fort of Knodsenburg, was forced to retire with loss. Hulst fell after a three days' investment, and finally Nymegen was taken on the 21st of October. The fame of Maurice, a consummate general at the early age of twenty-four, was on all men's lips. The following campaign was signalized by the capture of Steenwyk and Koevorden. On the 8th of December 1592 Parma died, and the States were delivered from their most redoubtable adversary.

Death of Parma.

In 1593 the leaguer of Geertruidenburg put the seal on Maurice's reputation as an invincible besieger. The town fell after an investment of three months. Groningen was the chief fruit of the campaign of 1594. With its dependent district it was formed into a new province under the name of Stadt en Landen. William Louis became the stadholder (see GRONINGEN). The soil of the northern Netherlands was at last practically free from the presence of Spanish garrisons.

The growing importance of the new state was signalized by the conclusion, in 1596, of a triple alliance between England, France and the United Provinces. It was of short duration and purchased by hard conditions, but it implied the recognition by Henry IV. and Elizabeth of the States-General, as a sovereign power, with whom treaties could be concluded. Such a recognition was justified by the brilliant successes of the campaign of 1597. It began with the complete rout of a Spanish force of 4500 men at Turnhout in January, with scarcely any loss to the victors. Then in a succession of sieges Rheinberg, Meurs, Groenlo, Bredevoort, Enschede, Ootmarsum, Oldenzaal and Lingen fell into the hands of Maurice.

The relations of the Netherlands to Spain were in 1598 completely changed. Philip II. feeling death approaching, resolved to marry his elder daughter, the Infanta Isabel Clara Eugenia,

to her cousin, the Cardinal Archduke Albert of Austria, who had been governor-general of the Netherlands since 1596, and to erect the Provinces into an independent sovereignty under their joint rule. The instrument was executed in May; Philip died in September; the marriage took place in November. In case the marriage should have no issue, the sovereignty of the Netherlands was to revert to the king of Spain. The archdukes (such was their official title) did not make their joyeuse entrée into Brussels until the close of 1599. The step was taken too late to effect a reconciliation with the rebel provinces. Peace overtures were made, but the conditions were unacceptable. The States-General never seriously considered the question of giving in their submission to the new sovereigns. The traders of Holland and Zealand had thriven mightily by the war. Their ships had penetrated to the East and West Indies, and were to be found in every sea. The year 1600 saw the foundation of the Chartered East India Company (see DUTCH EAST INDIA COMPANY). The question of freedom of trade with the Indies had become no less vital to the Dutch people than freedom of religious worship. To both these concessions Spanish policy was irreconcilably opposed.

Albert and Isabel, Sovereigns of the Netherlands.

Dunkirk, as a nest of freebooters who preyed upon Dutch commerce, was made the objective of a daring offensive campaign in 1600 by the orders of the States-General under the influence of Oldenbarnevelt in the teeth of the opposition of the stadholders Maurice and William Louis.

The Battle of New-Port.

By a bold march across Flanders, Maurice reached Nieuport on the 1st of July, and proceeded to invest it. The archduke Albert, however, followed hard on his steps with an army of seasoned troops, and Maurice, with his communications cut, was forced to fight for his existence. A desperate combat took place on the dunes between forces of equal strength and valour. Only by calling up his last reserves did victory declare for Maurice. The archduke had to fly for his life. Five thousand Spaniards were killed; seven hundred taken, and one hundred and five standards. To have thus worsted the dreaded Spanish infantry in open fight was a great triumph for the States troops and their general, but it was barren of results. Maurice refused to run further risks and led back his army to Holland. For the following three years all the energies alike of the archdukes and the States-General were concentrated on the siege of Ostend (15th of July 1601-20th of Sept. 1604), the solitary possession of the Dutch in Flanders. The heroic obstinacy of the defence was equalled by the perseverance of the attack, and there was a vast expenditure, especially on the side of the Spaniards, of blood and treasure. At last when reduced to a heap of ruins, Ostend fell before the resolution of Ambrosio de Spinola, a Genoese banker, to whom the command of the besiegers had been entrusted (see SPINOLA). A month before the surrender, however, another and more commodious seaport, Sluis, had fallen into the possession of the States army under Maurice, and thus the loss of Ostend was discounted.

Siege of Ostend.

Spinola proved himself to be a general of a high order, and the campaigns of 1606 and 1607 resolved themselves into a duel of skill between him and Maurice without much advantage accruing to either side. But the archdukes' treasury was now empty, and their credit exhausted; both sides were weary of fighting, and serious negotiations for peace were set on foot. The disposition of the Spaniards to make concessions was further quickened by the destruction of their fleet at Gibraltar by the Dutch admiral Heemskerck, (April 1607). But there were many difficulties in the way. The peace party in the United Provinces headed by Oldenbarnevelt was opposed by the stadholders Maurice and William Louis, the great majority of the military and naval officers, the Calvinist preachers and many leading merchants. The Spaniards on their side were obdurate on the subjects of freedom of trade in the Indies and of freedom of religious worship. At last, after the negotiations had been repeatedly on the point of breaking off, a compromise was effected by the mediation of the envoys of France and England. On the 9th of April 1609

Negotiations for Peace.

a truce for twelve years was agreed upon. On all points the Dutch demands were granted. The treaty was concluded with the Provinces, "in the quality of free States over whom the archdukes made no pretensions." The *uti possidetis* as regards territorial possession was recognized. Neither the granting of freedom of worship to Roman Catholics nor the word "Indies" was mentioned, but in a secret treaty King Philip undertook to place no hindrance in the way of Dutch trade, wherever carried on.

One of the immediate results of this triumph of his policy was the increase of Oldenbarneveldt's influence and authority in the government of the Republic. But though Maurice and his other opponents had reluctantly yielded to the advocate's skilful diplomacy and persuasive arguments, a soreness remained between the statesman and the stadholder which was destined never to be healed. The country was no sooner relieved from the pressure of external war than it was torn by internal discords. After a brief interference in the affairs of Germany, where the intricate question of the Cleves-Jülich succession was already preparing the way for the Thirty Years' War, the United Provinces became immersed in a hot and absorbing theological struggle with which were mixed up important political issues. The province

of Holland was the arena in which it was fought out. Two professors of theology at Leiden, Jacobus Arminius (see ARMINIUS) and Franciscus Gomarus, became the leaders of two parties, who differed from one another upon certain tenets of the abstruse doctrine of predestination. Gomarus supported the orthodox Calvinist view; Arminius assailed it. The Arminians appealed to the States of Holland (1610) in a Remonstrance in which their theological position was defined. They were henceforth known as "Remonstrants"; their opponents were styled "Contra-Remonstrants."

The advocate and the States of Holland took sides with the Remonstrants, Maurice and the majority of the States-General (four provinces out of seven) supported the Contra-Remonstrants. It became a question of the extent of the rights of sovereign princes under the Union. The States-General wished to summon a national synod, the States of Holland refused their assent, and made levies of local militia (*waard-gelders*) for the maintenance of order. The States-General (9th of July 1618) took up the challenge, and the prince of Orange, as captain-general, was placed at the head of a commission to go in the first place to Utrecht, which supported Oldenbarneveldt, and then to the various cities of

Holland to insist on the disbanding of the *waard-gelders*. On the side of Maurice, whom the army obeyed, was the power of the sword. The opposition collapsed; the recalcitrant provincial states were purged, and the leaders of the party of state rights—the advocate himself, Hugo de Groot (see GROTIUS), pensionary of Rotterdam, and Hoogerbeets, pensionary of Leiden, were arrested and thrown into prison. The whole proceedings were illegal, and the illegality was consummated by the prisoners being brought before a special tribunal of 24 judges, nearly all of whom were personal enemies of the accused. The trial was merely a preliminary to condemnation. The advocate was sentenced to death, and executed (13th of May 1619) in the Binnenhof at the Hague. The sentences of Grotius and Hoogerbeets were commuted to perpetual imprisonment.

Meanwhile the National Synod had been summoned and had met at Dort on the 13th of November 1618. One hundred members, many of them foreign divines, composed this great assembly, who after 154 sittings gave their seal to the doctrines of the Netherlands Confession and the Heidelberg Catechism. The Arminians were condemned, their preachers deprived, and the Remonstrant party placed under a ban (6th of May 1619).

In 1621 the Twelve Years' Truce came to an end, and war broke out once more with Spain. Maurice, after the death of Oldenbarneveldt, was supreme in the land, but he missed sorely the wise counsels of the old statesman whose tragic end

he had been so largely instrumental in bringing about. He and Spinola found themselves once more at the head of the armies in the field, but the health of the stadholder was undermined, and his military genius was under a cloud. Deeply mortified by his failure to relieve Breda, which was blockaded by Spinola, Maurice fell seriously ill, and died on the 23rd of April 1625. He was succeeded in his dignities by his younger brother

Frederick Henry (see FREDERICK HENRY, prince of Orange), who was appointed stadholder of Holland, Zeeland, Utrecht, Overijssel and Gelderland, captain and adjutant-general of the Union and head of the Council of State. Frederick Henry was as a general scarcely inferior to Maurice, and a far more able statesman. The moderation of his views and his conciliatory temper did much to heal the wounds left by civil and religious strife, and during his time the power and influence of the stadholderate attained their highest point. Such was his popularity and the confidence he inspired that in 1631 his great offices of state were declared hereditary, in favour of his five-year-old son, by the *Acte de Survivance*. He did much to justify the trust placed in him, for the period of Frederick Henry is the most brilliant in the history of the Dutch Republic. During his time the East India Company, which had founded the town of Batavia in Java as their administrative capital, under a succession of able governors almost monopolized the trade of the entire East-India Company, made many conquests and established a network of factories and trade posts stretching from the Cape of Good Hope to Japan (see DUTCH EAST INDIA COMPANY). The West India Company, erected in 1621, though framed on the same model, aimed rather at waging war on the enemies' commerce than in developing their own. Their fleets for some years brought vast booty into the company's coffers. The Mexican treasure ships fell into the hands of Piet Heyn, the boldest of their admirals, in 1628; and they were able to send armies across the ocean, conquer a large part of Brazil, and set up a flourishing Dutch dominion in South America (see DUTCH WEST INDIA COMPANY). The operations of these two great chartered companies occupy a place among memorable events of Frederick Henry's stadholderate, they are therefore mentioned here, but for further details the special articles must be consulted.

When Frederick Henry stepped into his brother's place, he found the United Provinces in a position of great danger and of critical importance. The Protestants of Germany were on the point of being crushed by the forces of the Austrian Habsburgs and the Catholic League. It lay with the Netherlands to create a diversion in the favour of their co-religionists by keeping the forces of the Spanish Habsburgs fully occupied. But to do so with their flank exposed to imperialist attack from the east, was a task involving grave risks and possible disaster. In these circumstances, Frederick Henry saw the necessity of securing French aid. It was secured by the skilful diplomacy of Francis van Aarsens (*q.v.*) but on hard conditions. Richelieu required the assistance of the Dutch fleet to enable him to overcome the resistance of the Huguenot stronghold of La Rochelle. The far-sighted stadholder, despite popular opposition, by his powerful personal influence induced the States-General to grant the naval aid, and thus obtain the French alliance on which the safety of the republic depended.

The first great military success of Frederick Henry was in 1629. His capture of Hertogenbosch (Bois-le-duc), hitherto supposed to be impregnable, after a siege of five months was a triumph of engineering skill. Wesel also was taken by surprise this same year. In 1631 a large Spanish fleet carrying a picked force of 6000 soldiers, for the invasion of Zeeland, was completely destroyed by the Dutch in the Slaak and the troops made prisoners. The campaign of the following year was made memorable by the siege of Maestricht. This important frontier town lying on both sides of the river Meuse was taken by the prince of Orange in the teeth of two relieving armies, Spanish

Renewal of the war.

Death of Maurice.

The period of Frederick Henry.

The East and West India Companies.

Policy of Frederick Henry.

The Twelve Years' Truce.

Theological strife in Holland.

Arminius and Gomarus.

Remonstrants and Contra-Remonstrants.

Waard-gelders.

Oldenbarneveldt executed.

Synod of Dort.

Siege of Hertogenbosch and Maestricht.

and Imperialist, whose united forces were far larger than his own. This brilliant feat of arms was the prelude to peace negotiations, which led to a lengthy exchange of diplomatic notes. No agreement, however, was reached. The death of the Infanta Isabel in November 1633, and the reversion of the Netherlands to the sovereignty of the king of Spain, rendered all efforts to end the war, for the time being, fruitless.

At this juncture a strengthening of the French alliance seemed to the prince not merely expedient, but necessary. He had to contend against a strong peace party in Holland headed by the pensionary Pauw, but with the aid of the diplomatic skill of Aarsens all opposition was overcome. Pauw was replaced as pensionary by Jacob Cats, and the objections of Richelieu were met and satisfied. A defensive and offensive alliance with France was concluded early in 1635 against the king of Spain, and each party bound itself not to make a peace or truce without the assent of the other. A large French force was sent into the Netherlands and placed under the command of the prince of Orange. The military results of the alliance were during the first two campaigns inconsiderable. The Cardinal Infant Ferdinand had been appointed governor of the Netherlands, and he proved himself an excellent general, and there were dissensions in the councils of the allies. In 1637 the stadholder was able to add to his fame as an invincible besieger of cities. His failure to relieve Breda had hastened the death of Maurice.

It fell in 1625 into the hands of Spinola after a blockade of eleven months; it was now retaken by Frederick Henry after a siege of eleven weeks, in the face of immense difficulties. The reluctance of the States of Holland, and of Amsterdam in particular, to grant adequate supplies caused the campaigns of 1638 and 1639 to be in the main defensive and dilatory. An attempted attack on Antwerp was foiled by the vigilance of the Cardinal Infant. A body of 6000 men under Count William of Nassau were surprised and utterly cut to pieces. The year 1639, which had begun with abortive negotiations, and in which the activity of the stadholder had been much hampered by ill-health, was not to end, however, without a signal triumph of the Dutch arms, but it was to be on sea and not on land. A magnificent Spanish armada consisting of 77 vessels, manned by 24,000 soldiers and sailors under the command of Admiral Oquendo, were sent to the Channel in September with orders to drive the Dutch from the narrow seas and land a large body of troops at Dunkirk. Attacked by

a small Dutch fleet under Admiral Marten Tromp, the Spaniards sheltered themselves under the English Downs by the side of an English squadron. Tromp kept watch over them until he had received large reinforcements, and then (21st of October) boldly attacked them as they lay in English waters. Oquendo himself with seven vessels escaped under cover of a fog; all the rest of the fleet was destroyed. This crushing victory assured to the Dutch the command of the sea during the rest of the war. The naval power of Spain never in fact recovered from the blow.

The triumph of Tromp had, however, a bad effect on public feeling in England. The circumstances under which the battle of the Downs was won were galling to the pride of the English people, and intensified the growing unfriendliness between two nations, one of whom possessed and the other claimed supremacy upon the seas. The prosperity of the world-wide Dutch commerce was looked upon with eyes of jealousy across the Channel. Disputes had been constantly recurring between Dutch and English traders in the East Indies and elsewhere, and the seeds were already sown of that stern rivalry which was to issue in a series of fiercely contested wars. But in 1639-1640 civil discords in England stood in the way of a strong foreign policy, and the adroit Aarsens was able so "to sweeten the bitterness of the pill" as to bring King Charles not merely to "overlook the scandal of the Downs," but to consent to the marriage of the princess

royal with William, the only son of the stadholder. The wedding of the youthful couple (aged respectively 14 and 10 years) took place on the 12th of May 1641 (see WILLIAM II., prince of Orange). This royal alliance gave added influence and position to the house of Orange-Nassau.

About this time various causes brought about a change in the feelings which had hitherto prevented any possibility of peace between Spain and the United Netherlands. The revolt of Portugal (December 1640) weakened the Spanish power, and involved the loss to Spain of the Portuguese colonies. But it was in the Portuguese colonies that the conquests of the Dutch East and West India Companies had been made, and the question of the Indies as between Netherlander and Spaniard assumed henceforth quite a different complexion. Aarsens, the strongest advocate of the French alliance, passed away in 1641, and his death was quickly followed by those of Richelieu and Louis XIII. The victory of Condé at Rocroy opened the eyes of Frederick Henry to the danger of a French conquest of the Belgian provinces; and, feeling his health growing enfeebled, the prince became anxious before his death to obtain peace and security for his country by means of an accommodation with Spain. In 1643 negotiations were opened which, after many delays and in the face of countless difficulties, were at length, four years later, to terminate successfully.

The course of the *pourparlers* would doubtless have run more smoothly but for the infirm health and finally the death of the prince of Orange himself. Frederick Henry expired on the 14th of March 1647, and was buried by the side of his father and brother in Delft. In his last campaigns he had completed with signal success the task which, as a military commander, he had set himself,—of giving to the United Provinces a thoroughly defensible frontier of barrier fortresses. In 1644 he captured Sas de Ghent; in 1645 Hulst. That portion of Flanders which skirts the south bank of the Scheldt thus passed into the possession of the States, and with it the complete control of all the waterways to the sea.

The death of the great stadholder did not, however, long delay the carrying out of the policy on which he had set his heart, of concluding a separate peace with Spain behind the back of France, notwithstanding the compact of 1635 with that power. A provisional draft of a treaty had already been drawn up before the demise of Frederick Henry, and afterwards, despite the strenuous opposition of the new prince of Orange (who, under the *Acte de Survivance*, had inherited all his father's offices and dignities) and of two of the provinces, Zeeland and Utrecht, the negotiations were by the powerful support of the States of Holland and of the majority of the States-General, quickly brought to a successful issue. The treaty was signed at Münster on the 30th of January 1648. It was a peace practically dictated by the Dutch, and involved a complete surrender of everything for which Spain had so long fought. The United Provinces were recognized as free and independent, and Spain dropped all her claims; the *uti possidetis* basis was adopted in respect to all conquests; the Scheldt was declared entirely closed—a clause which meant the ruin of Antwerp for the profit of Amsterdam; the right to trade in the East and West Indies was granted, and all the conquests made by the Dutch from the Portuguese were ceded to them; the two contracting parties agreed to respect and keep clear of each other's trading grounds; each was to pay in the ports of the other only such tolls as natives paid. Thus, triumphantly for the revolted provinces, the eighty years' war came to an end. At this moment the republic of the United Netherlands touched, perhaps, the topmost point of its prosperity and greatness.

No sooner was peace concluded than bitter disputes arose between the provincial States of Holland and the prince of Orange, supported by the other six provinces, upon the question of the disbanding of the military forces. William was a young man (he was twenty-one at the time of his father's death) of

the feelings which had hitherto prevented any possibility of peace between Spain and the United Netherlands. The revolt of Portugal (December 1640) weakened the Spanish power, and involved the loss to Spain of the Portuguese colonies. But it was in the Portuguese colonies that the conquests of the Dutch East and West India Companies had been made, and the question of the Indies as between Netherlander and Spaniard assumed henceforth quite a different complexion. Aarsens, the strongest advocate of the French alliance, passed away in 1641, and his death was quickly followed by those of Richelieu and Louis XIII. The victory of Condé at Rocroy opened the eyes of Frederick Henry to the danger of a French conquest of the Belgian provinces; and, feeling his health growing enfeebled, the prince became anxious before his death to obtain peace and security for his country by means of an accommodation with Spain. In 1643 negotiations were opened which, after many delays and in the face of countless difficulties, were at length, four years later, to terminate successfully.

The course of the *pourparlers* would doubtless have run more smoothly but for the infirm health and finally the death of the prince of Orange himself. Frederick Henry expired on the 14th of March 1647, and was buried by the side of his father and brother in Delft. In his last campaigns he had completed with signal success the task which, as a military commander, he had set himself,—of giving to the United Provinces a thoroughly defensible frontier of barrier fortresses. In 1644 he captured Sas de Ghent; in 1645 Hulst. That portion of Flanders which skirts the south bank of the Scheldt thus passed into the possession of the States, and with it the complete control of all the waterways to the sea.

the highest abilities and of soaring ambition. He was totally opposed to the peace with Spain, and wished to bring about a speedy resumption of the war. With this view he entered into secret negotiations for a French alliance which, as far as can be gathered from extant records, had for its objects the conquest and partition by the allies of the Belgic provinces, and joint action in England on behalf of Charles II. As a preliminary step William aimed at a centralization of the powers of government in the United Provinces in his own person. He saw clearly the inherent defects of the existing federation, and he wished to remedy a system which was so complicated as to be at times almost unworkable. The States-General were but the delegates, the stadholders the servants, of a number of sovereign provinces, each of which had different historical traditions and a different form of government, and one of which—Holland—in wealth and importance outweighed the other six taken together. Between the States of Holland and the States-General there was constant jealousy and friction. And yet strangely enough the States of Holland themselves were not really representative of the people of that province, but only of the limited, self-coopting burgher aristocracies of certain towns, each of which with its rights and liberties had a quasi-independence of its own. Foremost among these was the great commercial capital, Amsterdam, whose rich burgher patriciate did not scruple on occasion to defy the authority of the States-General, the stadholder and even of the States of Holland themselves.

The form of Government in the United Provinces.

The position of Holland and Amsterdam.

The States of Holland had, in the years that followed the truce of 1609, measured their strength with that of the States-General, but the issue had been decided conclusively in favour of the federal authority by the sword of Maurice. The party and the principles of Oldenbarneveldt, however, though crushed, were not extinguished, and though Frederick Henry by his personal influence and prudent statesmanship had been able to surmount the difficulties placed in his way, he had had to encounter at times strong opposition, and had been much hampered in the conduct both of his campaigns and of his policy. With the conclusion of the peace of Munster and the death of the veteran stadholder the struggle for predominance in the Union between the Orangefederalist and the Hollander States-rights parties was certain to be renewed. The moment seemed to be favourable for the assertion of provincial sovereignty because of the youth and inexperience of the new prince of Orange. But William II., though little more than a boy, was endowed with singular capacity and great strength of will, and he was intent upon ambitious projects, the scope of which has been already indicated. The collision came, which was perhaps inevitable. The States-General in the disbanding of the forces wished to retain the *cadres* of the regiments complete in case of a renewal of the war. The States of Holland objected, and, although the army was a federal force, gave orders for the general disbanding of the troops in the pay of the province. The officers refused to obey any orders but those of the council of State of the Union. The provincial states, on their part, threatened them with loss of pay. At this juncture the States-General, as in 1618, appointed a commission headed by the prince of Orange to visit the towns of Holland, and provide for the maintenance of order and the upholding of the Union. Both parties put themselves in the wrong, the province by refusing its quota to the federal war-sheet, the generality by dealing with individual towns instead of with the states of the province. The visitation was a failure. The town councils, though most of them willing to receive William in his capacity as stadholder, declined to give a hearing to the commission. Amsterdam refused absolutely to admit either stadholder or commission. In these circumstances William resolved upon strong measures. Six leading members of the States of Holland were seized (30th of July 1650) and imprisoned in Loevenstein Castle, and troops under the command of William Frederick, stadholder of Fries-

The position in 1650.

The question of disbanding the forces.

The Prisoners of Loevenstein.

land, were sent to surprise Amsterdam. But the town council had been warned, and the gates were shut and guarded. The *coup d'état* nevertheless was completely successful. The anti-Orange party, remembering the fate of Oldenbarneveldt, were stricken with panic at the imprisonment of their leaders. The States of Holland and the town council of Amsterdam gave in their submission. The prisoners were released, and public thanks were rendered to the prince by the various provincial states for "his great trouble, care and prudence." William appeared to be master of the situation but his plans for future action were never to be carried into effect. Busily engaged in secret negotiations with France, he had retired to his hunting seat at Dieren, when he fell ill with smallpox on the 27th of October. A few days later he expired at the Hague (6th of November), aged but twenty-four years. A week after his death, his widow, the princess Mary of England, gave birth to a son who, as William III., was to give added lustre to the house of Orange.

Sudden Death of William II.

The anti-Orange particularist party, which had just suffered decisive defeat, now lifted up its head again. At the instance of Holland a Grand Assembly was summoned, consisting of delegates from all the provinces, to consider the state of the Union, the army and religion. It met at the Hague on the 18th of January 1651. The conclusions arrived at were that all sovereign powers resided in the provinces, and that to them severally, each within its own borders, belonged the control of the military forces and of religion. There was to be no captain-general of the Union. All the provinces, except Friesland and Groningen, which remained true to William Frederick of Nassau-Dietz, agreed to leave the office of stadholder vacant. The practical result was the establishment of the hegemony of Holland in the Union, and the handing over of the control of its policy to the patrician oligarchies who formed the town councils of that province.

The Grand Assembly.

Such a system would have been unworkable but for the fact that with the revival of the political principles of Oldenbarneveldt, there was found a statesman of commanding ability to fill the office in which the famous advocate of Holland had for so many years been "minister of all affairs" in the forming state. The title of advocate had indeed been replaced by that of grand pensionary (*Grand Pensionaris*), but the duties assigned to the office remained the same, the only change of importance being that the advocate was appointed for life, the grand pensionary for a term of five years. The grand pensionary was nominally the paid servant of the States of Holland, but his functions were such as to permit a man of talent and industry in the stadholderless republic to exercise control in all departments of policy and of government. All correspondence passed through his hands, he wrote all despatches, conducted the debates over which he presided, kept the minutes, drafted the resolutions, and was *ex officio* the leader and spokesman of the delegates who represented the Province of Holland in the States-General. Such was the position to which John de Witt, a young man of twenty-eight years of age, belonging to one of the most influential patrician families of Dordrecht (his father, Jacob de Witt, was one of the prisoners of Loevenstein) was appointed in 1653. From that date until 1672 it was his brain and his will that guided the affairs of the United Netherlands. He was supreme in the States of Holland, and Holland was dominant in the States-General (see JOHN DE WITT).

The office of Grand Pensionary.

John de Witt.

The death of William II. had left the Dutch republic at the very highest point of commercial prosperity, based upon an almost universal carrying trade, and the strictest system of monopoly. Friction and disputes had frequently arisen between the Dutch and the English traders in different parts of the world, and especially in the East Indies, culminating in the so-called "Massacre of Amboyna"; and the strained relations between the two nations would, but for the civil discords in England, have probably led to active hostilities during the reign of Charles I. With the accession of Cromwell to power the breach

Disputes between English and Dutch Traders.

was widened. A strong party in the Provinces were unfriendly to the Commonwealth, and insults were offered in the Hague to the English envoys. The parliament replied by passing the memorable Navigation Act (Oct. 1651), which struck a deadly blow at the Dutch carrying trade. It was the beginning of that struggle for supremacy upon the seas which was to end, after

Naval struggle with England. three great wars, in the defeat of the weaker country. The first English war lasted from May 1652 to April 1654, and within fifteen months twelve sea-fights took place, which were desperately contested and with varying success. The leaders on both sides—the Netherlanders Tromp (killed in action on the 10th of August 1653) and de Ruyter, the Englishmen Blake and Monk—covered themselves with equal glory. But the losses to Dutch trade were so serious that negotiations for peace were set on foot by the burgher party of Holland, and Cromwell being not unwilling, an agreement

was reached in the Treaty of Westminster, signed on the 5th of April 1654. The Dutch conceded the striking of the flag and compensation for English claims against the Dutch in the East Indies and elsewhere. The act of Seclusion, which barred the young prince of Orange from holding the office of stadholder and of captain-general, had been one of the conditions on which Cromwell had insisted. The consent of the States-General was refused, but by a secret treaty Holland, under the influence of de Witt, accepted it in their own name as a sovereign province. The popular feeling throughout the United Provinces was strongly antagonistic to the act of Seclusion, by which at the dictation of a foreign power a ban of exclusion was pronounced against the house of Orange-Nassau, to which the republic owed its independence.

Peace of Westminster. In 1658, the States-General interfered to save the Danes from Charles Gustavus of Sweden. In 1659 a treaty of peace was concluded between France, England and the United Provinces with a view to the settlement of the Danonish Swedish question, which ended in securing a northern peace in 1660, and in keeping the Baltic open for Dutch trade. The foreign affairs of the republic were throughout these years ably conducted by de Witt, and the position of Dutch colonial expansion in the Eastern seas made secure and firm. An advantageous peace with Portugal was made in 1662.

Act of Seclusion. Meanwhile the Commonwealth in England had been followed in 1660 by the restoration of the monarchy. To conciliate the new king the act of Seclusion was repealed, and the education of the young prince of Orange was undertaken by the States of Holland under the superintendence of de Witt. But Charles owed a grudge against Holland, and he was determined to gratify it. The Navigation Act was re-enacted, old grievances revived, and finally the Dutch colony of New Netherland was seized in time of peace (1664) and its capital, New Amsterdam, renamed New York. War broke out in 1665, and was marked by a series of terrific battles. On the 13th of June 1665 the Dutch admiral Obdam was completely defeated by the English under the duke of York. The four days' fight (11th-14th of June 1666) ended in a hard-won victory by de Ruyter over Monk, but later in this year (August 3rd) de Ruyter was beaten by Ayscue and forced to take refuge in the Dutch harbours. He had his revenge, for on the 22nd of June 1667 the Dutch fleet under de Ruyter and Cornelius de Witt made their way up the Medway as far as Chatham and burnt the English fleet as it lay at anchor. Negotiations between the two countries were already in progress and this event hastened a settlement. The peace of Breda was signed (31st of July 1667) on terms on the whole favourable to the Dutch. New Netherland was retained by England in exchange for Suriname. In the following year by the efforts of Sir William Temple the much vaunted Triple Alliance was concluded between Great Britain, the United Provinces and Sweden to check the ambitious designs of Louis XIV. The instability of Charles II., who sold himself to Louis by the treaty of Dover (1670), speedily rendered it of no effect, and left the

War with Sweden. United Provinces to face unaided the vengeance of the French king. From 1668 to 1672 Louis made ready to destroy the Dutch, and so well had his diplomacy served him that they were left without a friend in Europe. In 1672 the storm broke: the English without a declaration of war tried, unsuccessfully, to intercept the Dutch Mediterranean fleet; and the French at the same time set forth in apparently irresistible strength to overcome the despised traders of Holland. The States were ill-prepared on land though their fleet was strong and ready; party spirit had become intensely bitter as the prince of Orange (see WILLIAM III.) grew to man's estate, and the ruling burgher party, knowing how great was the popularity of William, especially in the army, had purposely neglected their land forces. Town after town fell before the French armies, and to de Witt and his supporters there seemed to be nothing left but to make submission and accept the best terms that Louis XIV. would grant. The young prince alone rose to the height of the occasion, and set his face against such cowardly counsels, and he had the enthusiastic support of the great majority of the people. Amidst general acclamation William was elected stadholder, first of Zeeland, then of Holland, and was appointed captain-general of the Union (June 1672). Meanwhile the fleet under de Ruyter had encountered a combined English and French force in Solebay (7th of June), and after a desperate fight, in which the French had but slackly supported their allies, had more than held its own. William, in his turn, with an army wholly insufficient to meet the French in the open field, was able to persuade his countrymen to open the dikes and by flooding the land to prevent its occupation by the enemy. The courage and resourcefulness of their youthful leader inspired the people to make heroic sacrifices for their independence, but unfortunately such was the revulsion of feeling against the grand pensionary, that he himself and his brother Cornelius were torn in pieces by an infuriated mob at the Hague (20th of August).

Second English war. William, now supreme in the States, while on land struggling with chequered success against the superior forces of the French, strove by his diplomacy, and not in vain, to gain allies for the republic. The growing power of France caused alarm to her neighbours, and Sweden, Denmark, Spain and the emperor lent a willing ear to the persuasions of the stadholder and were ready to aid his efforts to curb the ambition of Louis. On sea in 1673 de Ruyter, in a series of fiercely contested battles, successfully maintained his strenuous and dogged conflict against the united English and French fleets. In England the war was exceedingly unpopular, and public opinion forced Charles II. to conclude peace. The treaty of Westminster, which provided that all conquests should be restored, was signed on the 14th of February 1674. The French now found themselves threatened on many sides, and were reduced to the defensive. The prince, however, suffered a defeat at Seneff, and was in 1674 prevented from invading France. The war, nevertheless, during the following years was on the whole advantageous to the Dutch. In 1676 a Dutch squadron fought two hard but indecisive battles with a superior French force, off Stromboli (8th of January) and of Messina (22nd of April). In the last-named fight Admiral de Ruyter was badly wounded and died (29th of April). 1677 negotiations for peace went on, and were forwarded by the marriage, at the close of the year, of William of Orange with his cousin the princess Mary, daughter of the duke of York. At last (August 1678) a peace was concluded at Nymwegen by which the Dutch secured the integrity and independence of their country. All the conquests made by the French were given up.

Peace of Breda. The aggressive policy of Louis XIV. in the years that followed the peace of Nymwegen enabled William to lay the foundations of the famous confederacy which changed the whole aspect

The Triple Alliance.

United Provinces to face unaided the vengeance of the French king.

From 1668 to 1672 Louis made ready to destroy the Dutch, and so well had his diplomacy served him that they were left without a friend in Europe. In 1672 the storm broke: the English without a declaration of war tried, unsuccessfully, to intercept the Dutch Mediterranean fleet; and the French at the same time set forth in apparently irresistible strength to overcome the despised traders of Holland. The States were ill-prepared on land though their fleet was strong and ready; party spirit had become intensely bitter as the prince of Orange (see WILLIAM III.) grew to man's estate, and the ruling burgher party, knowing how great was the popularity of William, especially in the army, had purposely neglected their land forces. Town after town fell before the French armies, and to de Witt and his supporters there seemed to be nothing left but to make submission and accept the best terms that Louis XIV. would grant. The young prince alone rose to the height of the occasion, and set his face against such cowardly counsels, and he had the enthusiastic support of the great majority of the people. Amidst general acclamation William was elected stadholder, first of Zeeland, then of Holland, and was appointed captain-general of the Union (June 1672). Meanwhile the fleet under de Ruyter had encountered a combined English and French force in Solebay (7th of June), and after a desperate fight, in which the French had but slackly supported their allies, had more than held its own. William, in his turn, with an army wholly insufficient to meet the French in the open field, was able to persuade his countrymen to open the dikes and by flooding the land to prevent its occupation by the enemy. The courage and resourcefulness of their youthful leader inspired the people to make heroic sacrifices for their independence, but unfortunately such was the revulsion of feeling against the grand pensionary, that he himself and his brother Cornelius were torn in pieces by an infuriated mob at the Hague (20th of August).

The French invasion. William III. Stadholder and Captain-general. English and French force in Solebay (7th of June), and after a desperate fight, in which the French had but slackly supported their allies, had more than held its own. William, in his turn, with an army wholly insufficient to meet the French in the open field, was able to persuade his countrymen to open the dikes and by flooding the land to prevent its occupation by the enemy. The courage and resourcefulness of their youthful leader inspired the people to make heroic sacrifices for their independence, but unfortunately such was the revulsion of feeling against the grand pensionary, that he himself and his brother Cornelius were torn in pieces by an infuriated mob at the Hague (20th of August).

The third English war. William, now supreme in the States, while on land struggling with chequered success against the superior forces of the French, strove by his diplomacy, and not in vain, to gain allies for the republic. The growing power of France caused alarm to her neighbours, and Sweden, Denmark, Spain and the emperor lent a willing ear to the persuasions of the stadholder and were ready to aid his efforts to curb the ambition of Louis. On sea in 1673 de Ruyter, in a series of fiercely contested battles, successfully maintained his strenuous and dogged conflict against the united English and French fleets. In England the war was exceedingly unpopular, and public opinion forced Charles II. to conclude peace. The treaty of Westminster, which provided that all conquests should be restored, was signed on the 14th of February 1674. The French now found themselves threatened on many sides, and were reduced to the defensive. The prince, however, suffered a defeat at Seneff, and was in 1674 prevented from invading France. The war, nevertheless, during the following years was on the whole advantageous to the Dutch. In 1676 a Dutch squadron fought two hard but indecisive battles with a superior French force, off Stromboli (8th of January) and of Messina (22nd of April). In the last-named fight Admiral de Ruyter was badly wounded and died (29th of April). 1677 negotiations for peace went on, and were forwarded by the marriage, at the close of the year, of William of Orange with his cousin the princess Mary, daughter of the duke of York. At last (August 1678) a peace was concluded at Nymwegen by which the Dutch secured the integrity and independence of their country. All the conquests made by the French were given up.

Murder of the Brothers de Witt. William, now supreme in the States, while on land struggling with chequered success against the superior forces of the French, strove by his diplomacy, and not in vain, to gain allies for the republic. The growing power of France caused alarm to her neighbours, and Sweden, Denmark, Spain and the emperor lent a willing ear to the persuasions of the stadholder and were ready to aid his efforts to curb the ambition of Louis. On sea in 1673 de Ruyter, in a series of fiercely contested battles, successfully maintained his strenuous and dogged conflict against the united English and French fleets. In England the war was exceedingly unpopular, and public opinion forced Charles II. to conclude peace. The treaty of Westminster, which provided that all conquests should be restored, was signed on the 14th of February 1674. The French now found themselves threatened on many sides, and were reduced to the defensive. The prince, however, suffered a defeat at Seneff, and was in 1674 prevented from invading France. The war, nevertheless, during the following years was on the whole advantageous to the Dutch. In 1676 a Dutch squadron fought two hard but indecisive battles with a superior French force, off Stromboli (8th of January) and of Messina (22nd of April). In the last-named fight Admiral de Ruyter was badly wounded and died (29th of April). 1677 negotiations for peace went on, and were forwarded by the marriage, at the close of the year, of William of Orange with his cousin the princess Mary, daughter of the duke of York. At last (August 1678) a peace was concluded at Nymwegen by which the Dutch secured the integrity and independence of their country. All the conquests made by the French were given up.

Peace of Westminster. The aggressive policy of Louis XIV. in the years that followed the peace of Nymwegen enabled William to lay the foundations of the famous confederacy which changed the whole aspect

Peace of Nymwegen.

of European politics. The league of Augsburg (1686), which followed the revocation of the edict of Nantes, placed Orange at the head of the resistance to French domination.

League of Augsburg.

The league was formed by the emperor, Spain, Sweden, the United Provinces and by several German states. In England William and Mary were looked upon as the natural successors to the throne on the death of James II., and William kept up close relations with the malcontents in Church and State, who disliked the arbitrary and papistical policy of his father-in-law. But with the birth of a prince of Wales the situation was changed, and William determined to intervene actively in English affairs. His opportunity came when Louis XIV., having declared war against the Empire, had invaded the Palatinate. The opposition of Amsterdam to an English expedition, in the absence of danger from the side of France, was overcome. The Revolution of 1688 ensued, and England became, under William's strong rule, the chief member of the Great Coalition against French aggression. In the Grand Alliance of 1689-1690 he was accused of sacrificing Dutch to English interests, but there can be no doubt that William loved his native country better than his adopted one, and was a true patriot. If the United Provinces suffered in prosperity through their close relations with and subordination to Great Britain during a long series of years, it was due not to the policy of William, but to the fact that the territory of the republic was small, open to attack by great military powers, and devoid of natural resources. The stadholder's authority and popularity continued unimpaired, despite of his frequent absences in England. He had to contend, like his predecessors, with the perennial hostility of the burgher aristocracy of Amsterdam, and at times with other refractory town councils, but his power in the States during his life was almost autocratic. His task was rendered lighter by the influence and ability of Heinsius, the grand pensionary of Holland, a wise and prudent statesman, whose tact and moderation in dealing with the details and difficulties of internal administration were conspicuous. The stadholder gave to Heinsius his fullest confidence, and the pensionary on his part loyally supported William's policy and placed his services ungrudgingly at his disposal (see HEINSIUS).

Revolution of 1688.

The conduct of the war by the allies was far from successful. In 1690 (July 1st) Waldeck was defeated by Luxembourg at Fleurus; and the Anglo-Dutch fleet was so severely handled by Tourville (10th July) off Beachy Head that for two years the command of the sea remained in the possession of the French. A striking victory off Cape la Hogue (29th of May 1692) restored, however, supremacy to the allies. On land the combined armies fared ill. In 1691 the French took Mons, and in 1692 Namur, in which year after a hard-fought battle William was defeated at Steenkirk and in 1693 at Neerwinden. But William's military genius never shone so brightly as in the hour of defeat; he never knew what it was to be beaten, and in 1695 his recapture of Namur was a real triumph of skill and resolution. At last, after long negotiations, exhaustion compelled the French king to sign the peace of Ryswick in 1697, in which William was recognized by France as king of England, the Dutch obtaining a favourable commercial treaty, and the right to garrison the Netherland barrier towns. This peace, however, did no more than afford a breathing space during which Louis XIV. prepared for a renewal of the struggle. The great question of the Spanish succession was looming in all men's eyes, and though partition treaties between the interested powers were concluded in 1698 and 1700, it is practically certain that the French king held himself little bound by them. In 1701 he elbowed the Dutch troops out of the barrier towns; he defied England by recognizing James III. on the death of his father; and it was clear that another war was imminent when William III. died in 1702.

William and Heinsius.

The peace of Ryswick.

War with France.

Death of William III.

In 1672 the stadholdership in five provinces had been made

hereditary in the family of the prince of Orange, but William died childless, and the republican burgher party was strong enough to prevent the posts being filled up. William had wished that his cousin, Count John William Friso of Nassau, stadholder of Friesland and Groningen, should succeed him, but his extreme youth and the jealousy of Holland against a "Frisian" stood in the way of his election. The result was a want of unity in counsel and action among the provinces, Friesland and Groningen standing aloof from the other five, while Holland and Zeeland had to pay for their predominance in the Union by being left to bear the bulk of the charges. Fortunately there was no break of continuity in the policy of the States, the chief conduct of affairs remaining, until his death in 1702, in the capable and tried hands of the grand pensionary Heinsius, who had at his side a number of exceptionally experienced and wise counsellors—among these Simon van Slingeland, for forty-five years (1680-1725) secretary of the council of state, and afterwards grand pensionary of Holland (1727-1736), and Francis Fagel, who succeeded his father in 1699 as recorder (*Griffier*) of the States-General, and held that important office for fifty years. The tradition of William III. was thus preserved, but with the loss of the firm hand and strong personality of that great ruler the United Provinces were relegated to a subordinate place in the councils of the nations, and with the gradual decadence of its navy the Dutch republic ceased to rank as a power to be reckoned with.

In the War of the Spanish Succession, which broke out in 1702, Dutch troops took part in the campaigns of Marlborough and Eugene, and had their share in winning the great victories of Blenheim (1704), Ramillies (1706), Oudenarde (1708) and Malplaquet (1709). At the peace of Utrecht, concluded in 1713, the interests of the Netherlands were but half-heartedly supported by the English plenipotentiaries, and the French were able to obtain far more favourable terms than they had the power to exact. But they were compelled to abandon all claim to the Spanish Netherlands, which were formally handed over to the United Provinces, as trustees, to be by them, after the conclusion of a satisfactory barrier treaty, given up to the emperor, and be known henceforth as the Austrian Netherlands.

The peace of Utrecht taught the Dutch that the great powers around them, while ready to use their resources for war, would not scruple to abandon them when they wanted peace; they, therefore, determined henceforth to stand clear of all foreign complications. With 1713 the influence of the United Netherlands upon European politics comes almost to an end.

The ruling party in the States took an active part in securing George I. on the throne of England; and they succeeded in coming to an agreement both with France and with Austria over the difficulties connected with the barrier towns, and were thus able in tranquillity to concentrate their energies upon furthering the interests of their trade. Under the close oligarchical rule of the patrician families, who filled all offices in the town councils, the States of Holland, in which the influence of Amsterdam was dominant, and which in their turn exercised predominance in the States-General, became more and more an assembly of "shopkeepers" whose policy was to maintain peace for the sake of the commerce on which they thrived. For thirty years after the peace of Utrecht the Provinces kept themselves free from entanglement in the quarrels of their neighbours. The foundation of the Ostend East India Company (see OSTEND COMPANY), however, by the emperor Joseph II. in 1723, at once aroused the strong opposition of the Amsterdam merchants who looked upon this invasion of their monopoly with alarm, and declared that the Ostend Company had been set up in contravention to the terms of Article V. of the treaty of Munster. In maintaining this position the States had the support of England, but it was not until 1731 that they succeeded in obtaining the suppression of the company by consenting to

Stadholders Government.

War of the Spanish Succession.

Treaty of Utrecht.

Peace policy.

Ostend East India Company.

guarantee the Pragmatic Sanction of Charles VI. This step led in 1743 to their being involved in the War of the Austrian Succession, and thus being drawn into hostilities with France, which invaded the barrier country.

In 1744 they formed with Great Britain, Austria and Saxony, a Quadruple Alliance, and put a contingent of troops in the field. The Dutch took an active part in the campaign of 1745 and suffered heavily at Fontenoy, after which battle Marshal Saxe overran the Austrian Netherlands. The French captured all the barrier towns, and in 1747 entered Dutch Flanders and made an easy conquest.

The United Provinces, as in 1672, seemed to lie at the mercy of their enemies, and as in that eventful year, popular feeling broke down the opposition of the burgher oligarchies, and turned to William IV., prince of Orange, as the saviour of the state. John William Friso had died young in 1711, leaving a posthumous son, William Charles Henry Friso, who was duly elected stadholder by the two provinces, Friesland and Groningen, which were always faithful to his family, and in 1722 he became also, though with very limited powers, stadholder of Gelderland. The other provinces, however, under pressure from Holland, bound themselves not to elect stadholders, and they refused to revive the office of captain-general of the Union. By the conquest of Dutch Flanders Zeeland was threatened, and the states of that province, in which there were always many Orange partisans, elected (April 1747) William stadholder, captain-general and admiral of Zeeland. The example once given was infectious, and was followed in rapid succession by Holland, Utrecht and Overysel. Finally the States-General (May 4) appointed the prince, who was the first member of his family to be stadholder of all the seven provinces, captain and admiral-general of the Union, and a little later these offices were declared hereditary in both the male and female lines.

William IV., though not a man of great ability, was sincerely anxious to do his utmost for securing the maintenance of peace, and the development of the resources and commercial prosperity of the country, and his powerful dynastic connexions (he had married Anne, eldest daughter of George II.) gave him weight in the councils of Europe. The peace of Aix-la-Chapelle, in 1748, in which the influence of Great Britain was exerted on behalf of the States, though it nominally restored the old condition of things, left the Provinces crippled by debt, and fallen low from their old position among the nations. At first the stadholder's efforts to promote the trade and welfare of the country were hampered by the distrust and opposition of Amsterdam, and other strongholds of anti-Orange feeling, and just as his good intentions were becoming more generally recognized, William unfortunately died, on the 22nd of October 1751, aged forty years, leaving his three-year-old son, William V., heir to his dignities. The princess Anne of England became regent, but she had a difficult part to play, and on the outbreak of the Seven Years' War in which the Provinces were determined to maintain neutrality, her English leanings brought much unpopularity upon her. She died in 1759, and for the next seven years the regency passed into the hands of the States, and the government was practically stadholderless.

In 1766 William V. was declared to be of age; and his accession to power was generally welcomed. He was, however, a weak man, without energy or resolution, and he allowed himself to be entirely led by his old guardian the duke of Brunswick, and by his wife Frederica Wilhelmina of Prussia, a woman of marked ability, to whom he entirely deferred. In the American War of Independence William's sympathies were strongly on the English side, while those of the majority of the Dutch people were with the revolted colonies. It is, however, certain that nothing would have driven the Provinces to take part in the war but for the overbearing attitude of the British government with regard to the right of neutral shipping upon the seas, and the heavy losses sustained

by Dutch commerce at the hands of British privateers. The famous agreement, known as the "Armed Neutrality," with which in 1780 the States of the continent at the instigation of Catherine II. of Russia replied to the maritime claims put forward by Great Britain drew the Provinces once more into the arena of European politics.

Every effort was made by the English to prevent the Dutch from joining the league, and in this they were assisted by the stadholder, but at last the States-General, though only by the bare majority of four provinces against three, determined to throw in their lot with the opponents of England.

Nothing could have been more unfortunate, for the country was not ready for war, and party spirit was too strong for united action to be taken or vigorous preparations to be made. When war broke out Dutch commerce was destroyed, and the Dutch colonies were at the mercy of the English fleet without the possibility of a blow being struck in their defence. An indecisive, but bravely fought action with Admiral Parker at the Dogger Bank showed, however, that the Dutch seamen had lost none of their old dogged courage, and did much to soothe the national sense of humiliation. In the negotiations of the Treaty of Paris (1783) the Dutch found themselves abandoned by their allies, and compelled to accept the disadvantageous but not ungenerous terms accorded to them by Great Britain. They had to sacrifice some of their East Indian possessions and to concede to the English freedom of trade in the Eastern seas.

One result of this humiliating and disastrous war was the strengthening of the hands of the anti-Orange burgher-regents, who had now arrogated to themselves the name of "patriots." It was they, and not the stadholder, who had been mainly responsible for the Provinces joining "the Armed Neutrality," but the consequences of the war, in which this act had involved them, was largely visited upon the prince of Orange. The "patriot" party did their utmost to curtail his prerogatives, and harass him with petty insults, and at last the Prussian king was obliged to interfere to save his niece, who was even more unpopular than her weak husband, from being driven from the country. In 1784 the emperor Joseph II. took advantage of the dissensions in the Provinces to raise the question of the opening of the Scheldt. He himself was, however, no more prepared for attack than the Republic for defence, but the Dutch had already sunk so low, that they agreed to pay a heavy indemnity to induce the Austrians to drop a demand they were unable to enforce. To hold the mouth of the Scheldt and prevent at all costs a revival of Antwerp as a commercial port had been for two centuries a cardinal point of Dutch policy. This difficulty removed, the agitation of the "patriots" against the stadholderate form of government increased in violence, and William speedily found his position untenable. An insult offered to the prince of Orange in 1787 led to an invasion of the country by a Prussian army. Amsterdam capitulated, the country was occupied, and the patriot leaders declared incapable of holding any office. The Orange party was completely triumphant, and William V., under the protection of Prussia and England, with which states the United Provinces were compelled to ally themselves, was restored to power. It was, however, impossible to make the complicated and creaking machinery of the constitution of the worn-out republic of the United Netherlands work smoothly, and in all probability it would have been within a very short time replaced by an hereditary monarchy, had not the cataclysm of the French Revolution swept it away from its path, never to be revived.

When war broke out between the French revolutionary government and the coalition of kings, the Provinces remained neutral as long as they could. It was not till Dumouriez had overran all the Austrian Netherlands in 1792, and had thrown open the passage of the Scheldt, that they were drawn into the war. The patriot party sided with

War of the Austrian Succession.

Revolution of 1747.

William IV.

Peace of Aix-la-Chapelle.

Death of William IV.

Anne of England Regent.

The Armed Neutrality.

War with England.

Peace of Paris.

The "Patriot" Party.

Intervention of the King of Prussia.

Difficulty with the Emperor.

Prussian invasion.

Restoration to power of William V.

The French invaded the Netherlands.

Geschiedenis der, Nederlandsche Letterkunde (2 vols. 1831); C. Busken Huet, *Het Land van Rembrandt-studien over de Noordnederlandsche beschaving in de 17e eeuw* (2 vols., 1886); L. D. Petit, *Repertorium der verhandelingen en bijdragen betreffende de geschiedenis des Vaterlands in tijdschriften en mengel werken tot op 1900 verschenen*, 2 parts (1905); other parts of this valuable *repertorium* are in course of publication. (C. E.)

HOLLAND, COUNTY AND PROVINCE OF.—The first mention of Holland in any document is found in an imperial gift brief dated May 2nd, 1064. In this the phrase "*omnis comitatus in Hollandi*" occurs, but without any further description of the locality indicated. A comparison with other documentary evidence, however, leads to the identification of Holland with the *forestium Merweda*, or the bush-grown fenland lying between the Waal, the old Meuse and the Merwe. It is the district surrounding the town of Dordrecht. A portion of the original Holland was submerged by a great inundation in 1421, and its modern appellation of Biesbosch (reed-forest) is descriptive of what must have been the condition of the entire district in early times. The word Holland is indeed by many authorities thought to be a corruption of Holt-land (it was sometimes so spelt by 13th-century writers) and to signify wood-land. The earliest spelling is, however, Holland, and it is more probable that it means lowlying-land (hol=hollow), a derivation which is equally applicable to the district in Lincolnshire which bears the same name.

The title count of Holland appears to have been first borne by the Frisian count Dirk III., who founded Dordrecht (about 1015) and made it his residence (see below). It was not, however, till late in the 11th century that his successors adopted the style "*Hollandensis comes*" as their territorial designation (it is found for the first time on a seal of Dirk V. 1083), and that the name Holland became gradually extended northwards to connote all the land subject to the rule of the counts between Texel and the Maas.

The beginnings of the history of this feudal state (the later Holland) centre round the abbey of Egmont in whose archives its records have been preserved. In 922 Charles the

Dirk I. Simple gave in full possession to a count in Frisia, Dirk by name (a shortened form of Diederic, Latin Theodoricus), "the church of Egmont with all that belonged to it from Swithardeshage to Kinhem." This man, usually known as Dirk I., died about 939 and was succeeded by his son of the same name. Among the records of the abbey of Egmont is a document by which the emperor Arnulf gave to a certain count Gerolf the same land "between Swithardeshage and Kinhem," afterwards held by Dirk I. It is generally assumed that this Gerolf was his father, otherwise their deed of gift would not have been preserved among the family papers. Dirk II. was the founder of the abbey of Egmont. His younger son Egbert became archbishop of Treves. His elder son Arnulf married Liutgardis, daughter of Siegfried of Luxemburg and sister-in-law of the emperor Henry II. He obtained from the emperor Otto III., with whom he was in great favour

Extent of his domain. in 983, a considerable extension of territory, that now covered by the Zuider Zee and southward down to Nijmegen. In the deed of gift he is spoken of as holding the three countships of Maasland, Kinhem or Kennemerland and Texla or Texel; in other words his rule extended over the whole country from the right bank of the Maas or Meuse to the Vlie. He appears also to have exercised authority at Ghent. He died in 988. Arnulf was count till 993, when he was slain in battle against the west Frisians, and was succeeded by his twelve-year-old son Dirk III. During the guardianship of his mother, Liutgardis, the boy was despoiled of almost all his possessions, except Kennemerland and Maasland.

Dirk III. But no sooner was he arrived at man's estate than Dirk turned upon his enemies with courage and vigour. He waged war successfully with Adelbold, the powerful bishop of Utrecht, and made himself master not only of his ancestral possessions, but of the district on the Meuse known as the Bushland of Merweda (*forestium Merweda*), hitherto subject to

the see of Utrecht. In the midst of this marshy tract, at a point commanding the courses of the Meuse and the Waal, he built a castle (about 1015) and began to levy tolls. Around this castle sprang up the town of Thuredrecht or Dordrecht. The possession of this stronghold was so injurious to the commerce of Tiel, Cologne and the Rhemish towns with England that complaints were made by the bishop of Utrecht and the archbishop of Cologne to the emperor. Henry II. took the part of the complainants and commissioned Duke Godfrey of Lorraine to chastise the young Frisian count. Duke Godfrey invaded Dirk's lands with a large army, but they were impeded by the swampy nature of the country and totally defeated with heavy loss (July 29, 1018). The duke was himself taken prisoner. The result was that Dirk was not merely confirmed in his possession of Dordrecht and the Merweda Bushland (the later Holland) but also of the territory of a vassal of the Utrecht see, Dirk Bavo by name, which he conquered. This victory of 1018 is often regarded as the true starting-point of the history of the county of Holland. Having thus established his rule in the south, Dirk next proceeded to bring into subjection the Frisians in the north. He appointed his brother Siegfried or Sikka as governor over them. In his later years Dirk went upon a pilgrimage to the Holy Land from which he returned in 1034; and ruled in peace until his death in 1039.

His son, Dirk IV., was one of the most enterprising of his warlike and strenuous race. He began the long strife with the counts of Flanders, as to the lordship over Walcheren and other islands of Zealand; the quarrel was important, as dealing with the borderland between French and German overlordship. This strife, which lasted 400 years, did not at first break out into actual warfare, because both Dirk and Baldwin V. of Flanders had a common danger in the emperor Henry III., who in 1046 occupied the lands in dispute. Dirk allied himself with Godfrey the Bearded of Lorraine, who was at war with the emperor, and his territory was invaded by a powerful imperial fleet and army (1047). But Dirk entrenched himself in his stronghold at Vlaardingen, and when winter came on he surrounded and cut off with his light boats a number of the enemy's ships, and destroyed a large part of their army as they made their way amidst the marches, which impeded their retreat. He was able to recover what he had lost and to make peace on his own terms. Two years later he was again assailed by a coalition headed by the archbishop of Cologne and the bishop of Utrecht. They availed themselves of a very hard winter to penetrate into the land over the frozen water. Dirk offered a stout resistance, but, according to the most trustworthy account, was enticed into an ambuscade and was killed in the fight (1049). He died unmarried and was succeeded by his brother Floris I.

Floris, like his predecessors, was hard-fighting and tenacious. He gradually recovered possession of his ancestral lands. He found a formidable adversary in the able and warlike William, who, becoming bishop of Utrecht in 1054, was determined to recover the lost possessions of his see; and in 1058, in alliance with Hanno, archbishop of Cologne, Egbert, margrave of Brandenburg, the bishop of Liège and others, invaded the Frisian territory. At first success attended the invaders and many places fell into their hands, but finally they were surprised and defeated near Dordrecht. The counts of Guelders and Louvain were among the prisoners that fell into the hands of Floris. The attack was renewed in 1061. In a battle at Nederhemert Floris met with his death in the hour of victory. He is said to have been killed as, wearied with pursuing, he lay asleep under a tree. He was succeeded by his son, Dirk V., a child, under the guardianship of his mother, Gertrude of Saxony. Bishop William seems now to have seized his opportunity and occupied all the territory that he claimed. In this he was confirmed by two charters of the emperor Henry IV. (April 30 and May 2, 1064). Among the possessions thus assigned to him is found *comitatus omnis*

Foundations of Dordrecht.

Defeat of Godfrey of Lorraine.

Beginning of the County of Holland.

Dirk IV.

Quarrel with Flanders about Zealand.

Floris I.

Dirk V.

in Holland cum omnibus ad bannum regalem pertinentibus. An examination of these documents shows the possessions of Dirk as *in Westfinge et circa oras Rheni, i.e.* west of the Vlie and around the mouths of the Rhine. Gertrude and her son appear to have withdrawn to the islands of Frisia (Zeeland), leaving William in undisturbed occupation of the disputed lands. In 1063 Gertrude contracted a marriage with Robert, the second son of Baldwin V. of Flanders, a man famous for his adventurous career (see FLANDERS). On his marriage his father

Robert the Frisian guardian to his stepson.

invested him with Imperial Flanders, as an apage including the islands of Frisia (Zeeland) west of the Scheldt. He now became guardian to his stepson, in whose inheritance lay the islands east of the Scheldt. Robert thus, in his own right and that of Dirk, was ruler of all Frisia (Zeeland), and thus became known among his Flemish countrymen as Robert the Frisian. The death of his brother Baldwin VI. in 1070 led to civil war in Flanders, the claim of Robert to the guardianship of his nephew Arnulf being disputed by Richilde, the widow of Baldwin. The issue was decided by the decisive victory of Robert at Cassel (February 1071) when Arnulf was killed and Richilde taken prisoner (see FLANDERS). While Robert was thus engaged in Flanders, an effort was made to recover "the County of Holland" and other lands now held by William of Utrecht. The people rose in revolt, but by command of the emperor Henry IV. were speedily brought back under episcopal rule by an army under the command of Godfrey the Hunchback, duke of Lower Lorraine. Again in 1076, at the request of the bishop, Duke Godfrey visited his domains in the Frisian borderland. At Delft, of which town tradition makes Godfrey the founder, the duke was treacherously murdered (February 26, 1076). William of Utrecht died on the 17th of the following April.

Godfrey the Hunchback of Lorraine conquers Holland.

Dirk V., now grown to man's estate, was not slow to take advantage of the favourable juncture. With the help of Robert (his stepfather) he raised an army, besieged Conrad, the successor of William, in the castle of Ysselmonde and took him prisoner. The bishop purchased his liberty by surrendering all claim to the disputed lands. Henceforth the Frisian counts became definitively known as counts of Holland. Dirk V. died in 1091 and was succeeded by his son Floris II. the Fat. This count had a peaceful and prosperous reign of thirty-one years.

After his death (1122) his widow, Petronilla of Saxony, governed in the name of Dirk VI., who was a minor. The accession of her half-brother, Lothaire of Saxony, to the imperial throne on the death of Henry V. greatly strengthened her position. The East Frisian districts, Oostergoo and Westergoo, were by Lothaire transferred from the rule of the bishops of Utrecht to that of the counts of Holland (1125). These Frisians proved very troublesome subjects to Dirk VI. In 1132 they rose in insurrection under the leadership of Dirk's own brother, Floris the Black. The emperor Conrad III. (1138), who was of the rival house of Hohenstaufen, gave back these Frisian districts to the bishop; it was in truth somewhat of an empty gift. The Frisian peasants and fisher folk loved their independence, and were equally refractory to the rule of any distant overlord, whether count or bishop. Dirk VI. was succeeded in 1157 by Floris III.

Floris III. reversed the traditional policy of his house by allying himself with the Hohenstaufens. He became a devoted adherent and friend of Frederick Barbarossa. He had troubles with West Friesland and Groningen, and a war with the count of Flanders concerning their respective rights in West Zeeland, in which he was beaten. In 1170 a great flood caused immense devastation in the north and helped to form the Zuider Zee. In 1180 Floris accompanied Frederick Barbarossa upon the third Crusade, of which he was a distinguished leader. He died in 1190 at Antioch of pestilence. His son, Dirk VII., had a stormy, but on the whole successful reign. Contests with the Flemings in West

Floris III.

Dirk VII.

Zeeland and with the West Frisians, stirred up to revolt by his brother William, ended in his favour. The brothers were reconciled and William was made count of East Friesland. In 1202, however, Dirk was defeated and taken prisoner by the duke of Brabant, and had to purchase peace on humiliating terms. He only survived his defeat a short time and died early in 1204, leaving as his only issue a daughter, Ada, 17 years of age. The question of female succession thus raised was not likely to be accepted without a challenge by William. It had been the intention of Dirk VII. to secure the recognition of his daughter's rights by appointing his brother her guardian. His widow Alida, however, an ambitious woman of strong character, as soon as her husband was dead, hurried on a marriage between Ada and Count Louis of Loon; and attempted with the nobles of Holland, who now for the first time make their appearance as a power in the country, to oppose the claim which William had made to the countship as heir in the male line. A struggle ensued. William was supported by the Zealanders *William I.* and Ada was forced to fly to England. William, by a treaty concluded with Louis of Loon in 1206, became undisputed count. He took an active part in the events of his time. He fought by the side of the emperor Otto IV. in the great battle of Bouvines in 1214 (see PHILIP AUGUSTUS), and was taken prisoner. Two years later he accompanied Louis, the eldest son of Philip Augustus, in his expedition against King John of England. William is perhaps best known in history by his taking part in the fourth Crusade. He distinguished himself greatly at the capture of Damietta (1219). He did not long survive his return home, dying in 1222. The earliest charters conveying civic privileges in the county of Holland date from his reign—those of Geertruidenberg (1213) and of Dordrecht (1220). His son Floris IV., being a minor, succeeded *Floris IV.* him under the guardianship of his maternal uncle, Gerard III. of Gelderland. He maintained in later life close relations of friendship with Gerard, and supported him in his quarrel with the bishop of Utrecht (1224-1226). Floris was murdered in 1235 at a tournament at Corbie in Picardy by the count of Clermont. Another long minority followed his death, during which his brother Otto, bishop of Utrecht, acted as guardian to his nephew William II.

William II. became a man of mark. Pope Innocent IV., having deposed the emperor Frederick II., after several princes had refused to allow themselves to be nominated in the place of the Hohenstaufen, caused the young count of Holland to be elected king of the Romans (1247) by an assembly composed chiefly of German ecclesiastics. William took Aachen in 1248 and was there crowned king; and after Frederick's death in 1250, he had a considerable party in Germany. He brought a war with Margaret of Flanders (Black Margaret) to a successful conclusion (1253). He was on the point of proceeding to Rome to be crowned emperor, when in an expedition against the West Frisians he perished, going down, horse and armour, through the ice (1256). Like so many of his predecessors he left his inheritance to a child. Floris V. was but two years old on his father's death; and he was destined during a reign of forty years to leave a deeper impress upon the history of Holland than any other of his counts. Floris was a man of chivalrous character and high capacity, and throughout his reign he proved himself an able and beneficent ruler. Alike in his troubles with his turbulent subjects and in the perennial disputes with his neighbours he pursued a strong, far-sighted and successful policy. But his active interest in affairs was not limited to the Netherlands. He allied himself closely with Edward I. of England in his strife with France, and secured from the English king great trading advantages for his people; the staple of wool was placed at Dort (Dordrecht) and the Hollanders and Zealanders got fishing rights on the English coast. So intimate did their relations become that Floris sent his son John to be educated at the court of Edward with a view to his marriage with an English princess. To

William II.

Elected King of the Romans.

Floris V.

Alliance with Edward I. of England.

balance the power of the nobles he granted charters to many of the towns. Floris made himself master of Amstelland and Gooiland; and Amsterdam, destined to become the chief commercial town of Holland, counts him the founder of its greatness. Its earliest extant charter dates from 1275. In 1296 Floris forsook the alliance of Edward I. for that of Philip IV. of France, probably because Edward had given support to Guy, count of Flanders, in his dynastic dispute with John of Avesnes, count of Hainaut, Floris's nephew (see FLANDERS). The real motives of his policy will, however, never be known, for shortly afterwards a conspiracy of disaffected nobles, headed by Gijbsrecht van Amstel, Gerard van Velzen and Wolfert van Borselen, was formed against him. He was by them basely murdered in the castle of Muident (June 27, 1296). The tragic event has been immortalized in dramas from the pens of Holland's most famous writers (see VONDEL, HOOPT). The burghers and people, who knew him to be their best friend, took such vengeance on his slayers as permanently to reduce the power of the nobles.

John I., his son, was in England when his father was murdered; he was but 15 years of age, feeble in body and mind. He was married to Eleanor, daughter of Edward I. His reign was a struggle between John of Avesnes, the young count's guardian and next heir, and Wolfert van Borselen, who had a strong following in Zeeland. In 1299 van Borselen was killed, and a few months later John I. died. John of Avesnes was at once recognized as his successor by the Hollanders. Thus with John I. ended the first line of counts, after a rule of nearly 400 years. Europe has perhaps never seen an abler series of princes than these fourteen lineal descendants of Dirk I. Excepting the last there is not a weak man among them. Physically handsome and strong, model knights of the days of chivalry, hard fighters, wise statesmen, they were born leaders of men; always ready to advance the commerce of the country, they were the supporters of the growing towns, and likewise the pioneers in the task of converting a land of marshes and swamps into a fertile agricultural territory rich in flocks and herds. As individuals they had their failings, but one and all were worthy members of a high-souled race.

John of Avesnes, who took the title of John II., was the son of John of Avesnes, count of Hainaut, and Alida, sister of William II. of Holland. On his succession to the countship the Hollanders were willing to receive him, but the Zealanders were hostile; and a long struggle ensued before his authority was generally recognized. In 1301 Bishop William of Utrecht invaded Amstelland, but was killed in battle. John made use of his victory to secure the election of his brother Guy as bishop in his place. A war with the Flemings followed, in which the Flemings were at first victorious, but after a struggle of many vicissitudes they were at length driven out of Holland and Zeeland in 1304. John II. died in that year and was succeeded by his son William III., surnamed the Good (1304-1337). In his reign the long-standing quarrel with Flanders, which had during a century and a half caused so many wars, was finally settled by the treaty of 1323, by which the full possession of West Zeeland was granted to William, who on his part renounced all claim in Imperial Flanders. The Amstelland with its capital, Amsterdam, which had hitherto been held as a fief of Utrecht, was by William, on the death of his uncle Bishop Guy, finally annexed to Holland. This count did much to encourage civic life and to develop the resources of the country. He had close relations through marriage with the three principal European dynasties of his time. His wife was Jeanne of Valois, niece of the French king; in 1323 the emperor Louis the Bavarian wedded his daughter Margaret; and in 1328 his third daughter, Philippa of Hainaut, was married to Edward III. of England. By their alliance William III. occupied a position of much dignity and influence, which he used to further the interests and increase the welfare

of his hereditary lands. He was in all respects a great prince and a wise and prudent statesman. He was succeeded by his son, William IV., who was the ally of his brother-in-law, Edward III., in his French wars. He was fond of adventure, and in 1343 made a journey to the Holy Land in disguise, and on his way took part in an expedition of the knights of the Teutonic Order against the infidel Wends and Lithuanians. He was killed in battle against the Frisians in 1345. He left no children, and the question as to the succession now brought on Holland a period of violent civil commotions. His inheritance was claimed by his eldest sister, the empress Margaret, as well as by Philippe of Hainaut, or in other words, by Edward III. of England. Margaret came in person and was duly recognized as countess in Holland, Zeeland and Hainaut; but returned to her husband after appointing her second son (the eldest, Louis, renounced his rights) Duke William of Bavaria, as stadholder in her place. William was but sixteen, and disorder and confusion soon reigned in the land. The sudden death of the emperor in 1347 added to the difficulties of his position. In 1349 Margaret was induced to resign her sovereignty, and the stadholder became count under the title of William V. This was the time of the formation of the famous of the parties in Holland, known as Kabbeljaus (Cods) and Hooks (Hooks); the former, the burgher party, were the supporters of William (possibly the name was derived from the light blue, scaly looking Bavarian coat of arms), the latter the party of the disaffected nobles, who wanted to catch and devour the fat burgher fish. In 1350 such was the disorder in the land that Margaret, at the request of the nobles, came to Holland to take into her own hands the reins of government. The struggle between the nobles and the cities broke out into civil war. Edward III. came to Margaret's aid, winning a sea-fight off Veere in 1351; a few weeks later the Hooks and their English allies were defeated by William and the Cods at Vlaardingen—an overthrow which ruined Margaret's cause. Edward III. shortly afterwards changed sides, and the empress saw herself compelled (1354) to come to an understanding with her son, he being recognized as count of Holland and Zeeland, she of Hainaut. Margaret died two years later, leaving William, who had married Matilda of Lancaster, in possession of the entire Holland-Hainaut inheritance (July 1356). His tenure of power was, however, very brief. Before the close of 1357 he showed such marked signs of insanity that his wife, with his own consent and the support of both parties, invited Duke Albert of Bavaria, younger brother of William V., to be regent, with the title of Ruward (1358).

William lived in confinement for 31 years. Albert died in 1404, having ruled the land well and wisely for 46 years, first as Ruward, then as count. Despite outbreaks from time to time of the Hook and Cod troubles, he was able to make his authority respected, and to help forward in many ways the social progress of the country. The influence of the towns was steadily on the increase, and their government began to fall into the hands of the burgher patrician class, who formed the Cod party. Opposed to them were the nobility and the lower classes, forming the Hook party. In Albert's latter years a fresh outbreak of civil war (1392-1395) was caused by the count's espousing the side of the Cods, while the Hooks had the support of his eldest son, William. Albert was afterwards reconciled to his son, who succeeded him as William VI. in 1404. On his accession to power William upheld the Hooks, and secured their ascendancy. His reign was much troubled with civil discords, but he was a brave soldier, and was generally successful in his enterprises. He died in 1417, leaving an only child, a daughter, Jacqueline (or Jacoba), who had in her early youth been married to John, heir to the throne of France. At a gathering held at the Hague (August 15, 1416) the nobles and representatives of the cities of Holland and Zeeland had promised at William's request to support his daughter's claims to the succession. But John of France died (April 1417), and William VI.

Albert of Bavaria, younger brother of William V., to be regent, with the title of Ruward (1358). William lived in confinement for 31 years. Albert died in 1404, having ruled the land well and wisely for 46 years, first as Ruward, then as count. Despite outbreaks from time to time of the Hook and Cod troubles, he was able to make his authority respected, and to help forward in many ways the social progress of the country. The influence of the towns was steadily on the increase, and their government began to fall into the hands of the burgher patrician class, who formed the Cod party. Opposed to them were the nobility and the lower classes, forming the Hook party. In Albert's latter years a fresh outbreak of civil war (1392-1395) was caused by the count's espousing the side of the Cods, while the Hooks had the support of his eldest son, William. Albert was afterwards reconciled to his son, who succeeded him as William VI. in 1404. On his accession to power William upheld the Hooks, and secured their ascendancy. His reign was much troubled with civil discords, but he was a brave soldier, and was generally successful in his enterprises. He died in 1417, leaving an only child, a daughter, Jacqueline (or Jacoba), who had in her early youth been married to John, heir to the throne of France. At a gathering held at the Hague (August 15, 1416) the nobles and representatives of the cities of Holland and Zeeland had promised at William's request to support his daughter's claims to the succession. But John of France died (April 1417), and William VI.

of his hereditary lands. He was in all respects a great prince and a wise and prudent statesman. He was succeeded by his son, William IV., who was the ally of his brother-in-law, Edward III., in his French wars. He was fond of adventure, and in 1343 made a journey to the Holy Land in disguise, and on his way took part in an expedition of the knights of the Teutonic Order against the infidel Wends and Lithuanians. He was killed in battle against the Frisians in 1345. He left no children, and the question as to the succession now brought on Holland a period of violent civil commotions. His inheritance was claimed by his eldest sister, the empress Margaret, as well as by Philippe of Hainaut, or in other words, by Edward III. of England. Margaret came in person and was duly recognized as countess in Holland, Zeeland and Hainaut; but returned to her husband after appointing her second son (the eldest, Louis, renounced his rights) Duke William of Bavaria, as stadholder in her place. William was but sixteen, and disorder and confusion soon reigned in the land. The sudden death of the emperor in 1347 added to the difficulties of his position. In 1349 Margaret was induced to resign her sovereignty, and the stadholder became count under the title of William V. This was the time of the formation of the famous of the parties in Holland, known as Kabbeljaus (Cods) and Hooks (Hooks); the former, the burgher party, were the supporters of William (possibly the name was derived from the light blue, scaly looking Bavarian coat of arms), the latter the party of the disaffected nobles, who wanted to catch and devour the fat burgher fish. In 1350 such was the disorder in the land that Margaret, at the request of the nobles, came to Holland to take into her own hands the reins of government. The struggle between the nobles and the cities broke out into civil war. Edward III. came to Margaret's aid, winning a sea-fight off Veere in 1351; a few weeks later the Hooks and their English allies were defeated by William and the Cods at Vlaardingen—an overthrow which ruined Margaret's cause. Edward III. shortly afterwards changed sides, and the empress saw herself compelled (1354) to come to an understanding with her son, he being recognized as count of Holland and Zeeland, she of Hainaut. Margaret died two years later, leaving William, who had married Matilda of Lancaster, in possession of the entire Holland-Hainaut inheritance (July 1356). His tenure of power was, however, very brief. Before the close of 1357 he showed such marked signs of insanity that his wife, with his own consent and the support of both parties, invited Duke Albert of Bavaria, younger brother of William V., to be regent, with the title of Ruward (1358).

William lived in confinement for 31 years. Albert died in 1404, having ruled the land well and wisely for 46 years, first as Ruward, then as count. Despite outbreaks from time to time of the Hook and Cod troubles, he was able to make his authority respected, and to help forward in many ways the social progress of the country. The influence of the towns was steadily on the increase, and their government began to fall into the hands of the burgher patrician class, who formed the Cod party. Opposed to them were the nobility and the lower classes, forming the Hook party. In Albert's latter years a fresh outbreak of civil war (1392-1395) was caused by the count's espousing the side of the Cods, while the Hooks had the support of his eldest son, William. Albert was afterwards reconciled to his son, who succeeded him as William VI. in 1404. On his accession to power William upheld the Hooks, and secured their ascendancy. His reign was much troubled with civil discords, but he was a brave soldier, and was generally successful in his enterprises. He died in 1417, leaving an only child, a daughter, Jacqueline (or Jacoba), who had in her early youth been married to John, heir to the throne of France. At a gathering held at the Hague (August 15, 1416) the nobles and representatives of the cities of Holland and Zeeland had promised at William's request to support his daughter's claims to the succession. But John of France died (April 1417), and William VI.

Albert of Bavaria, younger brother of William V., to be regent, with the title of Ruward (1358). William lived in confinement for 31 years. Albert died in 1404, having ruled the land well and wisely for 46 years, first as Ruward, then as count. Despite outbreaks from time to time of the Hook and Cod troubles, he was able to make his authority respected, and to help forward in many ways the social progress of the country. The influence of the towns was steadily on the increase, and their government began to fall into the hands of the burgher patrician class, who formed the Cod party. Opposed to them were the nobility and the lower classes, forming the Hook party. In Albert's latter years a fresh outbreak of civil war (1392-1395) was caused by the count's espousing the side of the Cods, while the Hooks had the support of his eldest son, William. Albert was afterwards reconciled to his son, who succeeded him as William VI. in 1404. On his accession to power William upheld the Hooks, and secured their ascendancy. His reign was much troubled with civil discords, but he was a brave soldier, and was generally successful in his enterprises. He died in 1417, leaving an only child, a daughter, Jacqueline (or Jacoba), who had in her early youth been married to John, heir to the throne of France. At a gathering held at the Hague (August 15, 1416) the nobles and representatives of the cities of Holland and Zeeland had promised at William's request to support his daughter's claims to the succession. But John of France died (April 1417), and William VI.

Albert of Bavaria, younger brother of William V., to be regent, with the title of Ruward (1358). William lived in confinement for 31 years. Albert died in 1404, having ruled the land well and wisely for 46 years, first as Ruward, then as count. Despite outbreaks from time to time of the Hook and Cod troubles, he was able to make his authority respected, and to help forward in many ways the social progress of the country. The influence of the towns was steadily on the increase, and their government began to fall into the hands of the burgher patrician class, who formed the Cod party. Opposed to them were the nobility and the lower classes, forming the Hook party. In Albert's latter years a fresh outbreak of civil war (1392-1395) was caused by the count's espousing the side of the Cods, while the Hooks had the support of his eldest son, William. Albert was afterwards reconciled to his son, who succeeded him as William VI. in 1404. On his accession to power William upheld the Hooks, and secured their ascendancy. His reign was much troubled with civil discords, but he was a brave soldier, and was generally successful in his enterprises. He died in 1417, leaving an only child, a daughter, Jacqueline (or Jacoba), who had in her early youth been married to John, heir to the throne of France. At a gathering held at the Hague (August 15, 1416) the nobles and representatives of the cities of Holland and Zeeland had promised at William's request to support his daughter's claims to the succession. But John of France died (April 1417), and William VI.

Albert of Bavaria, younger brother of William V., to be regent, with the title of Ruward (1358). William lived in confinement for 31 years. Albert died in 1404, having ruled the land well and wisely for 46 years, first as Ruward, then as count. Despite outbreaks from time to time of the Hook and Cod troubles, he was able to make his authority respected, and to help forward in many ways the social progress of the country. The influence of the towns was steadily on the increase, and their government began to fall into the hands of the burgher patrician class, who formed the Cod party. Opposed to them were the nobility and the lower classes, forming the Hook party. In Albert's latter years a fresh outbreak of civil war (1392-1395) was caused by the count's espousing the side of the Cods, while the Hooks had the support of his eldest son, William. Albert was afterwards reconciled to his son, who succeeded him as William VI. in 1404. On his accession to power William upheld the Hooks, and secured their ascendancy. His reign was much troubled with civil discords, but he was a brave soldier, and was generally successful in his enterprises. He died in 1417, leaving an only child, a daughter, Jacqueline (or Jacoba), who had in her early youth been married to John, heir to the throne of France. At a gathering held at the Hague (August 15, 1416) the nobles and representatives of the cities of Holland and Zeeland had promised at William's request to support his daughter's claims to the succession. But John of France died (April 1417), and William VI.

Albert of Bavaria, younger brother of William V., to be regent, with the title of Ruward (1358). William lived in confinement for 31 years. Albert died in 1404, having ruled the land well and wisely for 46 years, first as Ruward, then as count. Despite outbreaks from time to time of the Hook and Cod troubles, he was able to make his authority respected, and to help forward in many ways the social progress of the country. The influence of the towns was steadily on the increase, and their government began to fall into the hands of the burgher patrician class, who formed the Cod party. Opposed to them were the nobility and the lower classes, forming the Hook party. In Albert's latter years a fresh outbreak of civil war (1392-1395) was caused by the count's espousing the side of the Cods, while the Hooks had the support of his eldest son, William. Albert was afterwards reconciled to his son, who succeeded him as William VI. in 1404. On his accession to power William upheld the Hooks, and secured their ascendancy. His reign was much troubled with civil discords, but he was a brave soldier, and was generally successful in his enterprises. He died in 1417, leaving an only child, a daughter, Jacqueline (or Jacoba), who had in her early youth been married to John, heir to the throne of France. At a gathering held at the Hague (August 15, 1416) the nobles and representatives of the cities of Holland and Zeeland had promised at William's request to support his daughter's claims to the succession. But John of France died (April 1417), and William VI.

about a month later, leaving the widowed Jacqueline at 17 years of age face to face with a difficult situation. She was at first welcomed in Holland and Zeeland, but found her claims opposed by her uncle, John of Bavaria, supported by the Cod party. Every one from whom she might have expected help betrayed her in turn, her second husband John IV. of Brabant, her third husband Humphrey of Gloucester, her cousin Philip the Good of Burgundy, all behaved shamefully to her. Her romantic and sad life has rendered the courageous and accomplished Jacqueline the most picturesque figure in the whole history of Holland. She struggled long against her powerful kinsfolk, nor did she know happiness till near the end of her life, when she abandoned the unequal strife, and found repose with Francis of Borsele, Ruward of Holland, her fourth husband. Him Philip the Good, duke of Burgundy, craftily seized; and thereby in 1433 the Duchess Jacqueline was compelled to cede her rights over the counties of Holland and Hainaut. Consequently at her death in 1436, as she left no children, Philip succeeded to the full and undisputed possession of her lands. He had already acquired by inheritance, purchase or force almost all the other Netherland states; and now, with the extinction of the Bavarian line of counts, Holland ceased to have an independent existence and became an outlying province of the growing Burgundian power (see **BURGUNDY**). During the years that followed the accession to the sovereignty of Duke Philip, Holland plays but an insignificant part. It was governed by a stadholder, and but small respect was shown for its chartered rights and privileges. The quarrels between the Hook and Cod factions still continued, but the outbreaks of civil strife were quickly repressed by the strong hand of Philip. Holland during this time contented herself with growing material prosperity. Her herring fishery, rendered more valuable by the curing process discovered or introduced by Benkelssoon, brought her increasing wealth, and her fishermen were already laying the foundations of her future maritime greatness. It was in the days of Duke Philip that Lorenz Koster of Haarlem contributed his share to the discovery of printing. During the reign of Charles the Bold (1467-1477) the Hollanders, like the other subjects of that warlike prince, suffered much from the burden of taxation. An outbreak at Hoorn was by Charles sternly repressed. The Hollanders were much aggrieved by the establishment of a high court of justice for the entire Netherlands at Mechlin. (1474). This was regarded as a serious breach of their privileges. The succession of Mary of Burgundy led to the granting to Holland as to the other provinces of the Netherlands, of the Great Privilege of March 1477, which restored the most important of their ancient rights and liberties (see **NETHERLANDS**). A high court of justice was established for Holland, Zeeland and Friesland, and the use of the native language was made official. The Hook and Cod troubles again disturbed the country. Hook uprisings took place at Leiden and Dordrecht and had to be repressed by armed force.

Accession of the Burgundian Dynasty.

Philip the Good.

Flourishing state of Holland.

Charles the Bold.

Mary of Burgundy.

Maximilian of Austria.

Philip II. the Fair.

By the sudden death of the Duchess Mary in 1482 her possessions, including the county of Holland, passed to her infant son, Philip, under the guardianship of his father the Archduke Maximilian of Austria. Thus the Burgundian dynasty was succeeded by that of the Habsburgs. During the regency of Maximilian the turbulence of the Hooks caused much strife and unrest in Holland. Their leaders, Francis of Brederode and John of Naaldwijk, seized Rotterdam and other places. Their overthrow finally ended the strife between Hooks and Cods. The "Bread and Cheese War," an uprising of the peasants in North Holland caused by famine, is a proof of the misery caused by civil discords and oppressive taxation. In 1494, Maximilian having been elected emperor, Philip was declared of age. His assumption of the government was greeted with joy in Holland, and in his reign the province enjoyed rest

and its fisheries benefited from the commercial treaty concluded with England. The story of Holland during the long reign of his son and successor Charles III. (1506-1555), better known as the emperor Charles V., belongs to the general history of the Netherlands (see **NETHERLANDS**). On the abdication of Charles, his son Philip II. of Spain became Philip III., count of Holland, the ruler whose arbitrary rule in church and state brought about the revolt of the Netherlands. His appointment of William, prince of Orange, as stadholder of Holland and Zeeland was destined to have momentous results to the future of those provinces (see **WILLIAM THE SILENT**). The capture of Brill and of Flushing in 1572 by the Sea-Beggars led to the submission of the greater part of Holland and Zeeland to the authority of the prince of Orange, who, as stadholder, summoned the states of Holland to meet at Dordrecht. This act was the beginning of Dutch independence. From this time forward William made Holland his home. It became the bulwark of the Protestant faith in the Netherlands, the focus of the resistance to Spanish tyranny. The sieges of Haarlem, Alkmaar and Leiden saved Holland from being overwhelmed by the armies of Alva and Requesens and stemmed the tide of Spanish victory. The act of federation between Holland and Zeeland brought about by the influence of William was the germ of the larger union of Utrecht between the seven northern provinces in 1579. But within the larger union the inner and closer union between Holland and Zeeland continued to subsist. In 1580, when the sovereignty of the Netherlands was offered to the duke of Anjou, the two maritime provinces refused to acquiesce, and forced William to accept the title of count of Holland and Zeeland. In the following year William in the name of the two provinces solemnly abjured the sovereignty of the Spanish king (July 24). After the assassination of William (1584) the title of count of Holland was never revived.

The Emperor Charles V. (Charles III.).

Philip III.

William of Orange Stadholder.

The revolt of the Netherlands.

Union of Utrecht.

Abjuration of Philip's Sovereignty.

In the long struggle of the united provinces with Spain, which followed the death of Orange, the brunt of the conflict fell upon Holland. More than half the burden of the charges of the war fell upon this one province; and with Zeeland it furnished the fleets which formed the chief defence of the country. Hence the importance attached to the vote of Holland in the assembly of the States-General. That vote was given by deputies at the head of whom was the advocate (in later times called the grand pensionary) of Holland, and who were responsible to, and the spokesmen of, the provincial states. These states, which met at the Hague in the same building as the States-General, consisted of representatives of the burgher oligarchies (regents) of the principal towns, together with representatives of the nobles, who possessed one vote only. The advocate was the paid minister of the states. He presided over their meetings, kept their minutes and conducted all correspondence, and, as stated above, was their spokesman in the States-General. The advocate (or grand pensionary) of Holland therefore, if an able man, had opportunities for exercising a very considerable influence, becoming in fact a kind of minister of all affairs. It was this influence as exerted by the successive advocates of Holland, Paul Buys and Johan van Oldenbarneveldt, which rendered abortive the well-meant efforts of the earl of Leicester to centralize the government of the United Provinces. After his departure (1587) the advocate of Holland, Oldenbarneveldt, became the indispensable statesman of the struggling republic. The multiplicity of his functions gave to the advocate an almost unlimited authority in the details of administration, and for thirty years the conduct of affairs remained in his hands (see **OLDENBARNEVELDT**). This meant the undisputed hegemony of Holland in the federation, in other words of the burgher oligarchies who controlled the town corporations of the province, and especially of Amsterdam. This authority of Holland was, however, more than counterbalanced

William of Orange Stadholder.

The revolt of the Netherlands.

Union of Utrecht.

Abjuration of Philip's Sovereignty.

Government of Holland.

Johan van Oldenbarneveldt.

by the extensive powers with which the stadholder prince of Orange were invested; and the chief crises in the internal history of the Dutch republic are to be found in the struggles for supremacy between two, in reality, different principles of government. On the one side the principle of provincial sovereignty which gave to the voice of Holland a preponderating weight that was decisive; on the other side the principle of national sovereignty personified in the princes of Orange, to whom the States-General and the provincial states delegated executive powers that were little less than monarchical.

The conclusion of the twelve years' truce in 1609 was a triumph for Oldenbarneveldt and the province of Holland over the opposition of Maurice, prince of Orange. In 1617 the outbreak of the religious dispute between the Remonstrant and Contra-remonstrant parties brought on a life and death struggle between the sovereign province of Holland and the States-General of the union. The sword of Maurice decided the issue in favour of the States-General. The claims of Holland were overthrown and the head of Oldenbarneveldt fell upon the scaffold (1619).

The stadholder, Frederick Henry of Orange, ruled with well-nigh monarchical authority (1623-1647), but even he at the height of his power and popularity had always to reckon with the opposition of the states of Holland and of Amsterdam, and many of his plans of campaign were thwarted by the refusal of the Hollanders to furnish supplies. His son William II. was but 21 years of age on succeeding to the stadholdership, and the states of Holland were sufficiently powerful to carry through the negotiations for the peace of Münster (1648) in spite of his opposition. A life and death conflict again ensued, and once more in 1650 the prince of Orange by armed force crushed the opposition of the Hollanders. The sudden death of William in the hour of his triumph caused a complete revolution in the government of the republic. He left no heir but a posthumous infant, and the party of the burgher regents of Holland was once more in the ascendant. The office of stadholder was abolished, and John de Witt, the grand pensionary (Road-Pensionaris) of Holland, for two decades held in his hands all the threads of administration, and occupied the same position of undisputed authority in the councils of the land as Oldenbarneveldt had done at the beginning of the century. Amsterdam during this period was the centre and head of the United Provinces. The principle of provincial sovereignty was carried to its extreme point in the separate treaty concluded with Cromwell in 1654, in which the province of Holland agreed to exclude for ever the prince of Orange from the office of stadholder of Holland or captain-general of the union. In 1672 another revolution took place. John de Witt was murdered, and William III. was called to fill the office of dignity and authority which had been held by his ancestors of the house of Orange, and the stadholdership was declared to be hereditary in his family. But William died without issue (see WILLIAM III.) and a stadholderless period, during which the province of Holland was supreme in the union, followed till 1737. This change was effected smoothly, for though William had many differences with Amsterdam, he had in Anthony Heinsius (van der Heim), who was grand pensionary of Holland from 1690 to his death in 1720, a statesman whom he thoroughly trusted, who worked with him in the furtherance of his policy during life and who continued to carry out that policy after his death. In 1737 there was once more a reversion to the stadholdership in the person of William IV., whose powers were strengthened and declared hereditary both in the male and female line in 1747. But until the final destruction of the federal republic by the French armies, the perennial struggle went on between the Holland or federal party (*Staatsgezinden*) centred at Amsterdam—out of which grew the patriot party under William V.—and the Orange or unionist party (*Oranjesgezinden*), which was strong in the smaller provinces and had much popular support among

Constitution of the States of Holland.

The Grand Pensionary.

College of Deputed Councillors.

College of Deputed Councillors.

College of Deputed Councillors.

the lower classes. The French conquest swept away the old condition of things never to reappear; but allegiance to the Orange dynasty survived, and in 1813 became the rallying point of a united Dutch people. At the same time the leading part played by the province of Holland in the history of the republic has not been unrecognized, for the country ruled over by the sovereigns of the house of Orange is always popularly, and often officially, known as Holland.

The full title of the states of Holland in the 17th and 18th centuries was: *de Edele Groot Mogende Heeren Staaten van Holland en Westfriesland*. After 1608 this assembly consisted of nineteen members, one representing the nobility (*ridderschap*), and eighteen, the towns. The member for the nobles had precedence and voted first. The interests of the country districts (*het platte land*) were the peculiar charges of the member for the nobles. The nobles also retained the right of appointing representatives to sit in the College of Deputed Councillors, in certain colleges of the admiralty, and upon the board of directors of the East India Company, and to various public offices. The following eighteen towns sent representatives: South Quarter—(1) Dordrecht, (2) Haarlem, (3) Delft, (4) Leiden, (5) Amsterdam, (6) Gouda, (7) Rotterdam, (8) Gorinchem, (9) Schiedam, (10) Schoonhoven, (11) Brill; North Quarter—(12) Alkmaar, (13) Hoorn, (14) Enkhuizen, (15) Edam, (16) Monnikendam, (17) Medemblik, (18) Furmerend. Each town (as did also the nobles) sent as many representatives as they pleased, but the nineteen members had only one vote each. Each town's deputation was headed by its pensionary, who was the spokesman on behalf of the representatives. Certain questions such as peace and war, voting of subsidies, imposition of taxation, changes in the mode of government, &c., required unanimity of votes. The grand pensionary (*Road-Pensionaris*) was at once the president and chief administrative officer of the states. He presided over all meetings, conducted the business, kept the minutes, and was charged with the maintenance of the rights of the states, with the execution of their resolutions and with the entire correspondence. Nor were his functions only provincial. He was the head and the spokesman of the deputation of the states to the States-General of the union; and in the stadholderless period the influence of such grand pensionaries of Holland as John de Witt and Anthony Heinsius enabled the complicated and intricate machinery of government in a confederacy of many sovereign and semi-sovereign authorities without any recognized head of the state, to work with comparative smoothness and a remarkable unity of policy. This was secured by the indisputable predominance in the union of the province of Holland. The policy of the states of Holland swayed the policy of the generality, and historical circumstances decreed that the policy of the states of Holland during long and critical periods should be controlled by a succession of remarkable men filling the office of grand pensionary. The states of Holland sat at the Hague in the months of March, July, September and November. During the periods of prorogation the continuous oversight of the business and interests of the province was, however, never neglected. This duty was confided to a body called the College of Deputed Councillors (*het Kollegie der Gekommitteerde Raden*), which was itself divided into two sections, one for the south quarter, another for the north quarter. The more important—that for the south quarter—consisted of ten members, (1) the senior member of the nobility, who sat for life, (2) representatives (for periods of three years) of the eight towns: Dordrecht, Haarlem, Delft, Leiden, Amsterdam, Gouda, Rotterdam and Gorinchem, with a tenth member (usually elected biennially) for the towns of Schiedam, Schoonhoven and Brill conjointly. The grand pensionary presided over the meetings of the college, which had the general charge of the whole provincial administration, especially of finance, the carrying out of the resolutions of the states, the maintenance of defences, and the upholding of the privileges and liberties of the land. With particular regard to this last-

College of Deputed Councillors.

College of Deputed Councillors.

College of Deputed Councillors.

named duty the college deputed two of its members to attend all meetings of the states-general, to watch the proceedings and report at once any proposals which they held to be contrary to the interests or to infringe upon the rights of the province of Holland. The institution of the College of Deputed Councillors might thus be described as a vigilance committee of the states in perpetual session. The existence of the college, with its many weighty and important functions, must never be lost sight of by students who desire to have a clear understanding of the remarkable part played by the province of Holland in the history of the United Netherlands. (G. E.)

HOLLAND, a city of Ottawa county, Michigan, U.S.A., on Macatawa Bay (formerly called Black Lake), near Lake Michigan, and 25 m. W.S.W. of Grand Rapids. Pop. (1890) 3945; (1900) 7790, of whom a large portion were of Dutch descent; (1904) 8966; (1910) 10,490. It is served by the Père Marquette Railroad, by steamboat lines to Chicago and other lake ports, and by electric lines connecting with Grand Rapids, Saugatuck, and the neighbouring summer resorts. On Macatawa Bay are Ottawa Beach, Macatawa Park, Jenison Park, Central Park, Castle Park and Waukezoo. In the city itself are Hope College (co-educational; founded in 1851 and incorporated as a college in 1866), an institution of the (Dutch) Reformed Church in America; and the Western Theological Seminary (1869; suspended 1877-1884) of the same denomination. Holland is a grain and fruit shipping centre, and among its manufactures are furniture, leather, grist mill products, iron, beer, pickles, shoes, beet sugar, gelatine, biscuit (Holland rusk), electric and steam launches, and pianos. In 1908 seven weekly, one daily, and two monthly papers (four denominational) were published at Holland, five of them in Dutch. The municipality owns its water-works and electric-lighting plant. Holland was founded in 1847 by Dutch settlers, under the leadership of the Rev. A. C. Van Raalte, and was chartered as a city in 1867. In 1871 much of it was destroyed by a forest fire.

HOLLAND, a cloth so called from the country where it was first made. It was originally a fine plain linen fabric of a brownish colour—unbleached flax. Several varieties are now made: hollands, pale hollands and fine hollands. They are used for aprons, blinds, shirts, blouses and dresses.

HOLLAR, WENZEL or **WENGESLAUS** [VACLAV HOLAR] (1607-1677), Bohemian etcher, was born at Prague on the 13th of July 1607, and died in London, being buried at St Margaret's church, Westminster, on the 28th of March 1677. His family was ruined by the capture of Prague in the Thirty Years' War, and young Hollar, who had been destined for the law, determined to become an artist. The earliest of his works that have come down to us are dated 1625 and 1626; they are small plates, and one of them is a copy of a Virgin and Child by Dürer, whose influence upon Hollar's work was always great. In 1627 he was at Frankfort, working under Matthew Merian, an etcher and engraver; thence he passed to Strassburg, and thence, in 1633, to Cologne. It was there that he attracted the notice of the famous amateur Thomas, earl of Arundel, then on an embassy to the imperial court; and with him Hollar travelled to Vienna and Prague, and finally came in 1637 to England, destined to be his home for many years. Though he lived in the household of Lord Arundel, he seems to have worked not exclusively for him, but to have begun that slavery to the publishers which was afterwards the normal condition of his life. In his first year in England he made for Stent, the printseller, the magnificent View of Greenwich, nearly a yard long, and received thirty shillings for the plate,—perhaps a twentieth part of what would now be paid for a single good impression. Afterwards we hear of his fixing the price of his work at fourpence an hour, and measuring his time by a sandglass. The Civil War had its effect on his fortunes, but none on his industry. Lord Arundel left England in 1642, and Hollar passed into the service of the duke of York, taking with him a wife and two children. With other royalist artists, notably Inigo Jones and Faithorne, he stood the long and eventful siege of Basing House; and as we have some hundred plates from his hand dated during the years

1643 and 1644 he must have turned his enforced leisure to good purpose. Taken prisoner, he escaped or was released, and joined Lord Arundel at Antwerp, and there he remained eight years, the prime of his working life, when he produced his finest plates of every kind, his noblest views, his marvellous "muffs" and "shells," and the superb portrait of the duke of York. In 1652 he returned to London, and lived for a time with Faithorne the engraver near Temple Bar. During the following years were published many books which he illustrated:—Ogilby's *Virgil* and *Homer*, Stapylton's *Jesuald*, and Dugdale's *Warwickshire, St Paul's* and *Monasticon* (part i.). The booksellers continued to impose on the simple-minded foreigner, pretending to decline his work that he might still further reduce the wretched price he charged them. Nor did the Restoration improve his position. The court did nothing for him, and in the great plague he lost his young son, who, we are told, might have rivalled his father as an artist. After the great fire he produced some of his famous "Views of London"; and it may have been the success of these plates which induced the king to send him, in 1668, to Tangier, to draw the town and forts. During his return to England occurred the desperate and successful engagement fought by his ship the "Mary Rose," under Captain Kemphorne, against seven Algerine men-of-war,—a brilliant affair which Hollar etched for Ogilby's *Africa*. He lived eight years after his return, still working for the booksellers, and retaining to the end his wonderful powers; witness the large plate of Edinburgh (dated 1670), one of the greatest of his works. He died in extreme poverty, his last recorded words being a request to the bailiffs that they would not carry away the bed on which he was dying.

Hollar's variety was boundless; his plates number some 2740, and include views, portraits, ships, religious subjects, heraldic subjects, landscapes, and still life in a hundred different forms. No one that ever lived has been able to represent fur, or shells, or a butterfly's wing as he has done. His architectural drawings, such as those of Antwerp and Strassburg cathedrals, and his views of towns, are mathematically exact, but they are pictures as well. He could reproduce the decorative works of other artists quite faultlessly, as in the famous chalice after Mantegna's drawing. His *Theatrum mudiernum* and similar collections reproduce for us with literal truth the outward aspects of the people of his day; and his portraits, a branch of art in which he has been unfairly disparaged, are of extraordinary refinement and power.

Almost complete collections of Hollar's works exist in the British Museum and in the library at Windsor Castle. Two admirable catalogues of his plates have been made, one in 1745 (2nd ed. 1759) by George Vertue, and one in 1853 by Parthey. The latter, published at Berlin, is a model of German thoroughness and accuracy.

HOLLES, DENZIL HOLLES, BARON (1599-1680), English statesman and writer, second son of John Holles, 1st earl of Clare (c. 1564-1637), by Anne, daughter of Sir Thomas Stanhope, was born on the 31st of October 1599. The favourite son of his father and endowed with great natural abilities, Denzil Holles grew up under advantageous circumstances. Destined to become later one of the most formidable antagonists of King Charles's arbitrary government, he was in early youth that prince's playmate and intimate companion. The earl of Clare was, however, no friend to the Stuart administration, being especially hostile to the duke of Buckingham; and on the accession of Charles to the throne the king's offers of favour were rejected. In 1624 Holles was returned to parliament for Mitchell in Cornwall, and in 1628 for Dorchester. He had from the first a keen sense of the humiliations which attended the foreign policy of the Stuart kings. Writing to Strafford, his brother-in-law, on the 29th of November 1627, he severely censures Buckingham's conduct of the expedition to the Isle of Rhé; "since England was England," he declared, "it received not so dishonourable a blow"; and he joined in the demand for Buckingham's impeachment in 1628. To these discontents were now added the abuses arising from the king's arbitrary administration. On the 2nd of March 1629, when Sir John Finch, the speaker, refused to put Sir John Elliot's Protestations and was about to adjourn the House by the king's

command, Holles with another member thrust him back into the chair and swore "he should sit still till it pleased them to rise." Meanwhile Eliot, on the refusal of the speaker to read the Protestations, had himself thrown them into the fire; the usher of the black rod was knocking at the door for admittance, and the king had sent for the guard. But Holles, declaring that he could not render the king or his country better service, put the Protestations to the House from memory, all the members rising to their feet and applauding. In consequence a warrant was issued for his arrest with others on the following day. They were prosecuted first in the Star Chamber and subsequently in the King's Bench. When brought upon his *habeas corpus* before the latter court Holles offered with the rest to give bail, but refused sureties for good behaviour, and argued that the court had no jurisdiction over offences supposed to have been committed in parliament. On his refusal to plead he was sentenced to a fine of 1000 marks and to imprisonment during the king's pleasure. Holles had at first been committed and remained for some time a close prisoner in the Tower of London. The "close" confinement, however, was soon changed to a "safe" one, the prisoner then having leave to take the air and exercise, but being obliged to maintain himself at his own expense. On the 29th of October Holles, with Eliot and Valentine, was transferred to the Marshalsea. His resistance to the king's tyranny did not prove so stout as that of some of his comrades in misfortune. Among the papers of the secretary Sir John Coke is a petition of Holles, couched in humble and submissive terms, to be restored to the king's favour;¹ having given the security demanded for his good behaviour, he was liberated early in 1630, and on the 30th of October was allowed bail. Being still banished from London he retired to the country, paying his fine in 1637 or 1638. The fine was repaid by the parliament in July 1644, and the judgment was revised on a writ of error in 1668. In 1638 we find him, notwithstanding his recent experiences, one of the chief leaders in his country of the resistance to ship money, though it would appear that he subsequently made submission.

Holles was a member of the Short and Long Parliaments assembled in 1640. According to Laud he was now "one of the great leading men in the House of Commons," and in Clarendon's opinion he was "a man of more accomplished parts than any of his party" and of most authority. He was not, however, in the confidence of the republican party. Though he was at first named one of the managers for the impeachment of Strafford, Holles had little share in his prosecution. According to Laud he held out to Strafford hopes of saving his life if he would use his influence with the king to abolish episcopacy, but the earl refused, and Holles advised Charles that Strafford should demand a short respite, of which he would take advantage to procure a commutation of the death sentence. In the debate on the attainder he spoke on behalf of Strafford's family, and later obtained some favours from the parliament for his eldest son. In all other matters in parliament Holles took a principal part. He was one of the chief movers of the Protestation of the 3rd of May 1641, which he carried up to the Lords, urging them to give it their approval. Although, according to Clarendon, he did not wish to change the government of the church, he showed himself at this time decidedly hostile to the bishops. He took up the impeachment of Laud to the House of Peers, supported the Londoners' petition for the abolition of episcopacy and the Root and Branch Bill, and afterwards urged that the bishops impeached for their conduct in the affair of the late canons should be accused of treason. He showed equal energy in the affairs of Ireland at the outbreak of the rebellion, supported strongly the independence and purity of the judicial bench, and opposed toleration of the Roman Catholics. On the 9th of July 1641 he addressed the Lords on behalf of the queen of Bohemia, expressing great loyalty to the king and royal family and urging the necessity of supporting the Protestant religion everywhere. Together with Pym, Holles drew up the Grand Remonstrance, and made a vigorous speech in its support on

¹ *Hist. MSS. Comm.*, *MSS. of Earl Cowper*, i. 422.

the 22nd of November 1641, in which he argued for the right of one House to make a declaration, and asserted: "If kings are misled by their counsellors we may, we must tell them of it." On the 15th of December he was a teller in the division in favour of printing it. On the great subject of the militia he also showed activity. He supported Hezilriges' Militia Bill of the 7th of December 1641, and on the 31st of December he took up to the king the Commons' demand for a guard under the command of Essex. "Holles's force and reputation," said Sir Ralph Verney, "are the two things that give the success to all actions." After the failure of the attempt by the court to gain over Holles and others by offering them posts in the administration, he was one of the "five members" impeached by the king.² Holles at once grasped the full significance of the king's action, and after the triumphant return to the House of the five members, on the 11th of January, threw himself into still more pronounced opposition to the arbitrary policy of the crown. He demanded that before anything further was done the members should be cleared of their impeachment; was himself leader in the impeachment of the duke of Richmond; and on the 31st of January, when taking up the militia petition to the House of Lords, he adopted a very menacing tone, at the same time presenting a petition of some thousands of supposed starving artificers of London, congregated round the House. On the 15th of June he carried up the impeachment of the nine Lords who had deserted the parliament; and he was one of the committee of safety appointed on the 4th of July.

On the outbreak of the Civil War (see GREAT REBELLION) Holles, who had been made lieutenant of Bristol, was sent with Bedford to the west against the marquess of Hertford, and took part in the unsuccessful siege of the latter at Sherborne Castle. He was present at Edgehill, where his regiment of Puritans recruited in London was one of the few which stood firm and saved the day for the parliament. On the 13th of November his men were surprised at Brentford during his absence, and routed after a stout resistance. In December he was proposed for the command of the forces in the west, an appointment which he appears to have refused. Notwithstanding his activity in the field for the cause of the parliament, the appeal to arms had been distasteful to Holles from the first. As early as September he surprised the House by the marked abatement of his former "violent and fiery spirit," and his changed attitude did not escape the taunts of his enemies, who attributed it scornfully to his disaster at Brentford or to his new wife. He probably foresaw that, to whichever side victory fell, the struggle could only terminate in the suppression of the constitution and of the moderate party on which all his hopes were based. His feelings and political opinions, too, were essentially aristocratic, and he regarded with horror the transference of the government of the state from the king and the ruling families to the parliamentary leaders. He now advocated peace and a settlement of the disputes by concessions on both sides; a proposal full of danger because impracticable, and one therefore which could only weaken the parliamentary resistance and prolong the struggle. He warmly supported the peace negotiations on the 21st of November and the 22nd of December, and his attitude led to a breach with Pym and the more determined party. In June 1643 he was accused of complicity in Waller's plot, but swore to his innocence; and his arrest with others of the peace party was even proposed in August, when Holles applied for a pass to leave the country. The king's successes, however, for the moment put a stop to all hopes of peace; and in April 1644 Holles addressed the citizens of London at the Guildhall, calling upon them "to join with their purses, their persons, and their prayers together" to support the army of Essex. In November Holles and White-locke headed the commission appointed to treat with the king at Oxford. He endeavoured to convince the royalists of the necessity of yielding in time, before the "new party of hot men" should gain the upper hand. Holles and White-locke had a

² The speech of January 5 attributed to him and printed in *Thomason Tracts*, E 199 (55), is a forgery.

private meeting with the king, when at Charles's request they drew up the answer which they advised him to return to the parliament. This interview was not communicated to the other commissioners or to parliament, and though doubtless their motives were thoroughly patriotic, their action was scarcely compatible with their position as trustees of the parliamentary cause. Holles was also appointed a commissioner at Uxbridge in January 1645 and endeavoured to overcome the crucial difficulty of the militia by postponing its discussion altogether. As leader of the moderate (or Presbyterian) party Holles now came into violent antagonism with Cromwell and the army faction. "They hated one another equally"; and Holles would not allow any merit in Cromwell, accusing him of cowardice and attributing his successes to chance and good fortune. With the support of Essex and the Scottish commissioners Holles endeavoured in December 1644 to procure Cromwell's impeachment as an incendiary between the two nations, and "passionately" opposed the self-denying ordinance. In return Holles was charged with having held secret communications with the king at Oxford and with a correspondence with Lord Digby; but after a long examination by the House he was pronounced innocent on the 19th of July 1645. Determined on Cromwell's destruction, he refused to listen to the prudent counsels of Sir Anthony Ashley Cooper, who urged that Cromwell was too strong to be resisted or provoked, and on the 20th of March 1647 drew up in parliament a hasty proclamation declaring the promoters of the army petition enemies to the state; in April challenging Ireton to a duel.

The army party was now thoroughly exasperated against Holles. "They were resolved one way or other to be rid of him," says Clarendon. On the 16th of June 1647 eleven members including Holles were charged by the army with various offences against the state, followed on the 23rd by fresh demands for their impeachment and for their suspension, which was refused. On the 26th, however, the eleven members, to avoid violence, asked leave to withdraw. Their reply to the charges against them was handed into the House on the 19th of July, and on the 20th Holles took leave of the House in *A grave and learned speech*. . . . After the riot of the apprentices on the 26th, for which Holles disclaimed any responsibility, the eleven members were again (30th of July) recalled to their seats, and Holles was one of the committee of safety appointed. On the flight of the speaker, however, and part of the parliament to the army, and the advance of the latter to London, Holles, whose party and policy were now entirely defeated, left England on the 22nd of August for Sainte-Mère Eglide in Normandy. On the 26th of January 1648 the eleven members, who had not appeared when summoned to answer the charges against them, were expelled. Not long afterwards, however, on the 3rd of June, these proceedings were annulled; and Holles, who had then returned and was a prisoner in the Tower with the rest of the eleven members, was discharged. He returned to his seat on the 14th of August.

Holles was one of the commissioners appointed to treat with the king at Newport on the 18th of September 1648. Aware of the plans of the extreme party, Holles threw himself at the king's feet and implored him not to waste time in useless negotiations, and he was one of those who stayed behind the rest in order to urge Charles to compliance. On the 1st of December he received the thanks of the House. On the occasion of Pride's Purge on the 6th of December Holles absented himself and escaped again to France. From his retirement there he wrote to Charles II. in 1651, advising him to come to terms with the Scots as the only means of effecting a restoration; but after the alliance he refused Charles's offer of the secretaryship of state. In March 1654 Cromwell, who in alarm at the plots being formed against him was attempting to reconcile some of his opponents to his government, sent Holles a pass "with notable circumstances of kindness and esteem." His subsequent movements and the date of his return to England are uncertain, but in 1656 Cromwell's resentment was again excited against him as the supposed author of a tract, really written by Clarendon.

He appears to have been imprisoned, for his release was ordered by the council on the 2nd of September 1659.

Holles took part in the conference with Monk at Northumberland House, when the Restoration was directly proposed, and with the secluded members took his seat again in parliament on the 21st of February 1660. On the 23rd of February he was chosen one of the council to carry on the government during the interregnum; on the 2nd of March the votes passed against him and the sequestration of his estates were repealed, and on the 7th he was made *custos rotulorum* for Dorsetshire. He took a leading part in bringing about the Restoration, was chairman of the committee of seven appointed to prepare an answer to the king's letter, and as one of the deputed Lords and Commons he delivered at the Hague the invitation to Charles to return. He preceded Charles to England to prepare for his reception, and was sworn of the privy council on the 5th of June. He was one of the thirty-four commissioners appointed to try the regicides in September and October. On the 20th of April 1661 he was created Baron Holles of Iffeld in Sussex, and became henceforth one of the leading members of the Upper House.

Holles, who was a good French scholar, was sent as ambassador to France on the 7th of July 1663. He was ostentatiously English, and a zealous upholder of the national honour and interests; but his position was rendered difficult by the absence of home support. On the 27th of January 1666 war was declared, but Holles was not recalled till May. Pepsy's remarks on the 14th of November: "Sir G. Cartaret tells me that just now my Lord Holles had been with him and wept to think in what a condition we are fallen." Soon afterwards he was employed on another disagreeable mission in which the national honour was again at stake, being sent to Breda to make a peace with Holland in May 1667. He accomplished his task successfully, the articles being signed on the 21st of June.

On the 12th of December he protested against Lord Clarendon's banishment and was nearly put out of the council in consequence. In 1668 he was manager for the Lords in the celebrated Skinner's case, in which his knowledge of precedents was of great service, and on which occasion he published the tract *The Grand Question concerning the Judicature of the House of Peers* (1669). Holles, who was honourably distinguished by Charles as a "stiff and sullen man," and as one who would not yield to solicitation, now became with Halifax and Shaftesbury a leader in the resistance to the domestic and foreign policy of the court. Together with Halifax he opposed both the arbitrary Conventicle Act of 1670 and the Test Oath of 1675, his objection to the latter being chiefly founded on the invasion of the privileges of the peers which it involved; and he defended with vigour the right of the Peers to record their protests. On the 7th of January 1676 Holles with Halifax was summarily dismissed from the council. On the occasion of the Commons petitioning the king in favour of an alliance with the Dutch, Holles addressed a Letter to Van Beuninghen at Amsterdam on "Love to our Country and Hatred of a Common Enemy," enlarging upon the necessity of uniting in a common defence against French aggression and in support of the Protestant religion. "The People are strong but the Government is weak," he declares; and he attributes the cause of weakness to the transference of power from the nobility to the people, and to a succession of three weak princes. "Save what (the Parliament) did, we have not taken one true step nor struck one true stroke since Queen Elizabeth." He endeavoured to embarrass the government this year in his tract on *Some Considerations upon the Question whether the parliament is dissolved by its prorogation for 15 months*. It was held by the Lords to be seditious and scandalous; while for publishing another pamphlet written by Holles entitled *The Grand Question concerning the Prorogation of this Parliament* (otherwise *The Long Parliament dissolved*) the corrector of the proof sheets was committed to the Tower and fined £1000. In order to bring about the downfall of Danby (afterwards duke of Leeds) and the disbanding of the army, which he believed to be intended for the suppression of the national liberties, Holles at this time (1677-1679) engaged, as did many others, in a

dangerous intrigue with Courtin and Barillon, the French envoys, and Louis XIV.; he refused, however, the latter's presents on the ground that he was a member of the council, having been appointed to Sir William Temple's new modelled cabinet in 1679. Barillon described him as at this period in his old age "the man of all England for whom the different cabals have the most consideration," and as firmly opposed to the arbitrary designs of the court. He showed moderation in the Popish Plot, and on the question of the exclusion followed Halifax rather than Shaftesbury. His long and eventful career closed by his death on the 17th of February 1680.

The character of Holles has been drawn by Burnet, with whom he was on terms of friendship. "Hollis was a man of great courage and of as great pride. . . . He was faithful and firm to his side and never changed through the whole course of his life. . . . He argued well but too vehemently; for he could not bear contradiction. He had the soul of an old stubborn Roman in him. He was a faithful but a rough friend, and a severe but fair enemy. He had a true sense of religion; and was a man of an unblameable course of life and of a sound judgment when it was not biased by passion."¹ Holles was essentially an aristocrat and a Whig in feeling, making Cromwell's supposed hatred of "Lords" a special charge against him; regarding the civil wars rather as a social than as a political revolution, and attributing all the evils of his time to the transference of political power from the governing families to the "meanest of men." He was an authority on the history and practice of parliament and the constitution, and besides the pamphlets already mentioned was the author of *The Case Stated concerning the Judicature of the House of Peers in the Point of Appeals* (1675); *The Case Stated of the Jurisdiction of the House of Lords in the point of Impositions* (1676); *Letter of a Gentleman to his Friend showing that the Bishops are not to be judges in Parliament in Cases Capital* (1679); *Lord Holles his Remains, being a 2nd letter to a Friend concerning the judicature of the Bishops in Parliament*. . . .² He also published *A True Relation of the unjust accusation of certain French gentlemen* (1671), an account of Holles's intercession on their behalf and of his dispute with Lord Chief Justice Keeling; and he left *Memoirs*, written in exile in 1649, and dedicated "to the unparalleled Couple, Mr Oliver St John . . . and Mr Oliver Cromwell . . ." published in 1699 and reprinted in Baron Massey's *Select Tracts relating to the Civil Wars*, i. 189. Several speeches of Holles were printed and are extant, and his Letter to Van Beuninghen has been already quoted.

Holles married (1) in 1628 Dorothy, daughter and heiress of Sir Francis Ashley; (2) in 1642 Jane, daughter and co-heiress of Sir John Shirley of Iffeld in Sussex and widow of Sir Walter Covert of Slougham, Sussex; and (3) in 1666 Esther, daughter and co-heiress of Gideon Le Lou of Columbiers in Normandy, widow of James Richer. By his first wife he left one son, Francis, who succeeded him as 2nd baron. He had no children by his other wives, and the peerage became extinct in the person of his grandson Denzil, 3rd Baron Holles, in 1694, the estates devolving on John Holles (1662-1711), 4th earl of Clare and duke of Newcastle.

Holles's brother, JOHN HOLLES, 2nd earl of Clare (1595-1666), was member of parliament for East Retford in three parliaments before succeeding to the peerage in 1637. He took some part in the Civil War, but "he was very often of both parties, and never advantaged either." The earldom of Clare, which had been granted in 1624 by James I. to his father, John Holles, in return for the payment of £5000, became merged in the dukedom of Newcastle in 1694, when John Holles, the 4th earl, was created duke of Newcastle.

Holles's Life has been written by C. H. Firth in the *Dictionary of National Biography*; by Horace Walpole in *Royal and Noble Authors*, ii. 28; by Guizot in *Monks's Contemporaries* (Eng. trans., 1851); and by A. Collins in *Historical Collections of Noble Families* (1752), and in the *Biographia Britannica*. See also S. R. Gardiner,

¹ Burnet's *History of His Own Times*, vi. 257, 268.

² The rough draft, apparently in Holles's handwriting, is in *Egerton MSS.* ff. 136-149.

History of England (1883-1884), and *History of the Great Civil War* (1893); Lord Clarendon, *History of the Rebellion*, edited by W. D. Macray; G. Burnet, *History of His Own Time* (1833); and B. Whitelock, *Memorials* (1732). (P. C. Y.)

HOLLOWAY, THOMAS (1800-1883), English patent-medicine vendor and philanthropist, was born at Devonport, on the 22nd of September 1800, of humble parents. Until his twenty-eighth year he lived at Penzance, where he assisted his mother and brother in the baker's shop which his father, once a warrant officer in a militia regiment, had left them at his death. On coming to London he made the acquaintance of Felix Albinolo, an Italian, from whom he obtained the idea for the ointment which was to carry his name all over the world. The secret of his enormous success in business was due almost entirely to advertisement, in the efficacy of which he had great faith. He soon added the sale of pills to that of the ointment, and began to devote the larger part of his profits to advertising. Holloway's first newspaper announcement appeared on the 15th of October 1837, and in 1842 his yearly expenses for publicity had reached the sum of £5000; this expenditure went on steadily increasing as his sales increased, until it had reached the figure of £50,000 per annum at the time of his death. It is, however, chiefly by the two princely foundations—the Sanatorium and the College for Women at Egham (*q.v.*), endowed by Holloway towards the close of his life—that his name will be perpetuated, more than a million sterling having been set apart by him for the erection and permanent endowment of these institutions. In the deed of gift of the college the founder credited his wife, who died in 1875, with the advice and counsel that led him to provide what he hoped might ultimately become the nucleus of a university for women. The philanthropic and somewhat eccentric donor (he had an unconcealed prejudice against doctors, lawyers and parsons) died of congestion of the lungs at Sunninghill on the 26th of December 1883.

HOLLY (*Ilex Aquifolium*), the European representative of a large genus of trees and shrubs of the natural order Ilicineae, containing about 170 species. The genus finds its chief development in Central and South America; it is well developed in Asia, especially the Chinese-Japanese area, and has but few species in Europe, Africa and Australia. In Europe, where *I. Aquifolium* is the sole surviving species, the genus was richly represented during the Miocene period by forms at first South American and Asiatic, and later North American in type (Schimper, *Pflanzl. veget.* iii. 204, 1874). The leaves are generally leathery and evergreen, and are alternate and stalked; the flowers are commonly dioecious, are in axillary cymes, fascicles or umbellules, and have a persistent four- to five-lobed calyx, a white, rotate four- or rarely five- or six-cleft corolla, with the four or five stamens adherent to its base in the male, sometimes hypogynous in the female flowers, and a two- to twelve-celled ovary; the fruit is a globose, very seldom ovoid, and usually red drupe, containing two to sixteen one-seeded stones.

The common holly, or Hulver (apparently the *αἰλαορπος* of Theophrastus; ¹ Ang.-Sax. *holen* or *holegn*; Mid. Eng. *holyn* or *holin*, whence *holm* and *holm-tree*; ² Welsh, *celyn*; Ger. *Stechpalme*, *Hulse*, *Hulst*; O. Fr. *houz*; and Fr. *houiz*); ³ *I. Aquifolium*, is an evergreen shrub or low tree, having smooth, ash-coloured bark, and wavy, pointed, smooth and glossy leaves, 2 to 3 in. long, with a spinous margin, raised and cartilaginous below, or, as commonly on the upper branches of the older trees, entire

¹ *Hist. Plant.* i. 9. 3. iii. 3. 1. and 4. 6. *et passim*. On the *aquifolium* or *aquifolia* of Latin authors, commonly regarded as the holly, see A. de Grandaagne, *Hist. Nat. de Plâns*, bk. xvi., "Notes," pp. 199, 206.

² The term "holm," as indicative of a prevalence of holly, is stated to have entered into the names of several places in Britain. From its superficial resemblance to the holly, the tree *Quercus Ilex*, the evergreen oak, received the appellation of "holm-oak."

³ Skeat (*Etymolog. Dict.*, 1879) with reference to the word holly remarks: "The form of the base KUL (= Teutonic HUL) is probably connected with Lat. *culmen*, a peak, *culmus*, a stalk; perhaps because the leaves are 'pointed.'" Grimm (*Deut. Wörterb.* Bd. iv.) suggests that the term *Hulst*, as the O.H.G. *Hulst*, applied to the butcher's broom, or knee-holly, in the earliest times used for hedges, may have reference to the holly as a protecting (*hüllender*) plant.

—a peculiarity alluded to by Southey in his poem *The Holly Tree*. The flowers, which appear in May, are ordinarily dioecious, as in all the best of the cultivated varieties in nurseries (*Gard. Chron.*, 1877, i. 146). Darwin (*Diff. Forms of Flow.*, 1877, p. 297) says of the holly: "During several years I have examined many plants, but have never found one that was really hermaphrodite." Shirley Hibberd, however (*Gard. Chron.*, 1877, ii. 777), mentions the occurrence of "flowers bearing globose anthers well furnished with pollen, and also perfect ovaries." In his opinion, *I. Aquifolium* changes its sex from male to female with age. In the female flowers the stamens are destitute of pollen, though but slightly or not at all aborter than in the male flowers; the latter are more numerous than the female, and have a smaller ovary and a larger corolla, to which the filaments adhere for a greater length. The corolla in male plants falls off entire, whereas in fruit-bearers it is broken into separate



Ilex Aquifolium. Shoot bearing leaves and fruit about $\frac{1}{2}$ nat. size.

1. Flower with abortive stamens.
2. Flower with abortive pistil.
3. Floral diagram showing arrangement of parts in horizontal section.
4. Fruit.
5. Fruit cut transversely showing the four one-seeded stones.

segments by the swelling of the young ovary. The holly occurs in Britain, north-east Scotland excepted, and in western and southern Europe, from as high as 62° N. lat. in Norway to Turkey and the Caucasus and in western Asia. It is found generally in forest glades or in hedges, and does not flourish under the shade of other trees. In England it is usually small, probably on account of its destruction for timber, but it may attain to 60 or 70 ft. in height, and Loudon mentions one tree at Claremont, in Surrey, of 80 ft. Some of the trees on Bleak Hill, Shropshire, are asserted to be 14 ft. in girth at some distance from the ground (*N. and Q.*, 5th ser., xii. 508). The holly is abundant in France, especially in Brittany. It will grow in almost any soil not absolutely wet, but flourishes best in rather dry than moist sandy loam. Beckmann (*Hist. of Insect.*, 1846, i. 193) says that the plant which first induced J. di Castro to search for alum in Italy was the holly, which is there still considered to indicate that its habitat is aluminiferous. The holly is propagated by means of the seeds, which do not normally germinate until their second year, by whip-grafting and budding, and by cuttings of the matured summer shoots, which, placed in sandy soil and kept under cover of a hand-glass in sheltered situations, generally strike root in spring. Transplantation should be performed in damp weather in September and October, or, according to some writers, in spring or on mild days in winter, and care should be taken that the roots are not dried by exposure to the air. It is

rarely injured by frosts in Britain, where its foliage and bright red berries in winter render it a valuable ornamental tree. The yield of berries has been noticed to be less when a warm spring, following on a wet winter season, has promoted excess of growth. There are numerous varieties of the holly. Some trees have yellow, and others white or even black fruit. In the fruitless variety *laurifolia*, "the most floriferous of all hollies" (Hibberd), the flowers are highly fragrant; the form known as *femina* is, on the other hand, remarkable for the number of its berries. The leaves in the unarmed varieties *aureo-marginata* and *albomarginata* are of great beauty, and in *ferox* they are studded with sharp prickles. The holly is of importance as a hedge-plant, and is patient of clipping, which is best performed by the knife. Evelyn's holly hedge at Say's Court, Deptford, was 400 ft. long, 9 ft. high and 5 ft. in breadth. To form fences, for which Evelyn recommends the employment of seedlings from woods, the plants should be 9 to 12 in. in height, with plenty of small fibrous roots, and require to be set 1 to 1½ ft. apart, in well-manured and weeded ground and thoroughly watered.

The wood of the holly is even-grained and hard, especially when from the heartwood of large trees, and almost as white as ivory, except near the centre of old trunks, where it is brownish. It is employed in inlaying and turning, and, since it stains well, in the place of ebony, as for teapots handles. For engraving it is inferior to box. When dry it weighs about 47½ lb. per cub. ft. From the bark of the holly bird-lime is manufactured. From the leaves are obtainable a colouring matter named *ilicanthin*, *ilicic acid*, and a bitter principle, *ilicic*, which has been variously described by different analytical chemists. They are eaten by sheep and deer, and in parts of France serve as a winter fodder for cattle. The berries provoke in man violent vomiting and purging, but are eaten with immunity by thrushes and other birds. The larvae of the moths *Sphinx ligustri* and *Phaeopteryx naevana* have been met with on holly. The leaves are mined by the larva of a fly, *Phytomyza ilicis*, and both on them and the tops of the young twigs occurs the plant-louse *Aphis ilicis* (Kaltenbach, *Pflanzenkunde*, 1874, p. 427). The custom of employing holly and other plants for decorative purposes at Christmas is one of considerable antiquity, and has been regarded as a survival of the usages of the Roman Saturnalia, or of an old Teutonic practice of hanging the interior of dwellings with evergreens as a refuge for sylvan spirits from the inclemency of winter. A Border proverb defines an habitual story-teller as one that "lees never but when the hollen is green." Several popular superstitions exist with respect to holly. In the county of Rutland it is deemed unlucky to introduce it into a house before Christmas Eve. In some English rural districts the prickly and non-prickly kinds are distinguished as "he" and "she" holly; and in Derbyshire the tradition obtains that according as the holly brought at Christmas into a house is smooth or rough, the wife or the husband will be master. Holly that has adorned churches at that season is in Worcestershire and Herefordshire much esteemed and cherished, the possession of a small branch with berries being supposed to bring a lucky year; and Lonicerus mentions a notion in his time vulgarly prevalent in Germany that consecrated twigs of the plant hung over a door are a protection against thunder.

Among the North American species of *Ilex* are *I. opaca*, which resembles the European tree, the Inkberry, *I. (Prinos) glabra*, and the American Black Alder, or Winterberry, *I. (Prinos) verticillata*. Hooker (*Fl. of Brit. India*, i. 598, 606) enumerates twenty-four Indian species of *Ilex*. The Japanese *I. crenata*, and *I. latifolia*, a remarkably hardy plant, and the North American *I. Cassine*, are among the species cultivated in Britain. The leaves of several species of *Ilex* are used by dyers. The member of the genus most important economically is *I. paraguayensis*, the prepared leaves of which constitute Paraguay tea, or MATÉ (q.v.). Knee holly is *Ruscus aculeatus*, or butcher's broom (see BROOM); sea holly, *Eryngium maritimum*, an umbelliferous plant; and the mountain holly of America, *Nemopanthes canadensis*, also a member of the order Illicineae.

Besides the works above mentioned, see Loudon, *Arboretum*, ii. 506 (1844).

HOLLYHOCK (from M.E. *holi*—doubtless because brought from the Holy Land, where it is indigenous (Wedg.)—and A.-S.

hoc, a mallow), *Althaea rosea*, a perennial plant of the natural order *Malvaceae*, a native of the East, which has been cultivated in Great Britain for about three centuries. The ordinary hollyhock is single-blossomed, but the florists' varieties have all double flowers, of white, yellow, rose, purple, violet and other tints, some being almost black. The plant is in its prime about August, but by careful management examples may be obtained in blossom from July to as late as November. Hollyhocks are propagated from seed, or by division of the root, or by planting out in rich sandy soil, in a close frame, with a gentle bottom heat, single eyes from woodshoots, or cuttings from outgrowths of the old stock or of the lateral offsets of the spike. The seed may be sown in October under cover, the plants obtained being potted in November, and kept under glass till the following April, or, if it be late-gathered, in May or June, in the open ground, whence, if required, the plants are best removed in October or when. In many gardens, when the plants are not disturbed, self-sown seedlings come up in abundance about April and May. Seedlings may also be raised in February or March, by the aid of a gentle heat, in a light and rich moist soil; they should not be watered till they have made their second leaves, and when large enough for handling should be pricked off in a cold frame; they are subsequently transferred to the flower-bed. Hollyhocks thrive best in a well-trenched and manured sandy loam. The spikes as they grow must be staked; and water and, for the finest blossoms, liquid manure should be liberally supplied to the roots. Plants for exhibition require the side growths to be pinched out; and it is recommended, in cold, bleak or northerly localities, when the flowering is over, and the stalks have been cut off 4 to 6 in. above the soil, to earth up the crowns with sand. Some of the finest double-flowered kinds of hollyhock do not bloom well in Scotland. The plant is susceptible of great modification under cultivation. The forms now grown are due to the careful selection and crossing of varieties. It is found that the most diverse varieties may be raised with certainty from plants growing near together.

The young shoots of the hollyhock are very liable to the attacks of slugs, and to a disease occasioned by a fungus, *Puccinia malvacearum*, which is a native of Chile, attained notoriety in the Australian colonies, and finally, reaching Europe in 1869, threatened the extermination of the hollyhock, the soft parts of the leaves of which it destroys, leaving the venation only remaining. It has been found especially hurtful to the plant in dry seasons. It is also parasitic on the wild mallows. The disease appears on the leaves as minute hard pale-brown pustules, filled with spores which germinate without a resting-period, but when produced late in the season may last as resting-spores until next spring. Spraying early in the season with Bordeaux mixture is an effective preventive, but the best means of treatment is to destroy all leaves as soon as they show signs of being attacked, and to prevent the growth of other host-plants such as mallows, in the neighbourhood. In hot dry seasons, red-spider injures the foliage very much, but may be kept at bay by syringing the plants frequently with plenty of clean water.

HOLLY SPRINGS, a city and the county-seat of Marshall county, Mississippi, U.S.A., in the N. part of the state, 45 m. S.E. of Memphis. Pop. (1890) 2246; (1900) 2815 (1559 negroes); (1910) 2192. Holly Springs is served by the Illinois Central and the Kansas City, Memphis & Birmingham (Frisco System) railways. The city has broad and well-shaded streets, and a fine court-house and court-house square. It is the seat of Rust University (opened in 1867), a Methodist Episcopal institution for negroes; of the Mississippi Synodical College (1905; Presbyterian), for white girls; and of the North Mississippi Agricultural Experiment Station. The principal industries are the ginning, compressing and shipping of cotton, and the manufacture of cotton-seed oil, but the city also manufactures pottery and brick from clay obtained in the vicinity, and has an ice factory, bottling works and marble works. The municipality owns and operates its water-works and electric-lighting plant. Holly Springs was founded in 1837 and was chartered as a city in 1896. Early in December 1862 General Grant

established here a large depot of supplies designed for the use of the Federal army while on its march toward Vicksburg, but General Earl Van Dorn, with a brigade of cavalry, surprised the post at daylight on the 20th of this month, burned the supplies and took 1500 prisoners. Holly Springs was the home and is the burial-place of Edward Cary Walthall (1831-1898), a Democratic member of the United States Senate in 1885-1894 and in 1895-1898.

HOLMAN, JAMES (1786-1857), known as the "Blind Traveller," was born at Exeter on the 15th of October 1786. He entered the British navy in 1798 as first-class volunteer, and was appointed lieutenant in April 1807. In 1810 he was invalided by an illness which resulted in total loss of sight. In consideration of his helpless circumstances he was in 1812 appointed one of the royal knights of Windsor, but the quietness of such a life harmonized so ill with his active habits and keen interests that he requested leave of absence to go abroad, and in 1819, 1820 and 1821 journeyed through France, Italy, Switzerland, the parts of Germany bordering on the Rhine, Belgium and the Netherlands. On his return he published *The Narrative of a Journey through France, &c.* (London, 1822). He again set out in 1822 with the design of making the circuit of the world, but after travelling through Russia into Siberia, he was suspected of being a spy, was arrested when he had managed to penetrate 1000 m. beyond Smolensk, and after being conducted to the frontiers of Poland, returned home by Austria, Saxony, Prussia and Hanover. He now issued *Travels through Russia, Siberia, &c.* (London, 1825). Shortly afterwards he again set out to accomplish by a somewhat different method the design which had been frustrated by the Russian authorities; and an account of his remarkable achievement was published in four volumes in 1834-1835, under the title of *A Voyage round the World, including Travels in Africa, Asia, Australasia, America, &c., from 1827 to 1832*. His last journeys were through Spain, Portugal, Moldavia, Montenegro, Syria and Turkey; and he was engaged in preparing an account of this tour when he died in London on the 29th of July 1857.

HOLMES, OLIVER WENDELL (1809-1894), American writer and physician, was born on the 29th of August 1809 at Cambridge, Mass. His father, Abiel Holmes (1763-1837), was a Calvinist clergyman, the writer of a useful history, *Annals of America*, and of much very dull poetry. His mother (the second wife of Abiel) was Sarah Wendell, of a distinguished New York family. Through her Dr Holmes was descended from Governors Thomas Dudley and Simon Bradstreet of Massachusetts, and from her he derived his cheerfulness and vivacity, his sympathetic humour and wit. From Phillips (Andover) Academy he entered Harvard in the "famous class of '29," made further illustrious by the charming lyrics which he wrote for the anniversary dinners from 1851 to 1889, closing with the touching "After the Curfew." After graduation he studied law perfunctorily for a year and dabbled in literature, winning the public ear by a spirited lyric called forth by the order to destroy the old frigate *Constitution*. These verses were sung all over the land, and induced the Navy Department to revoke its order and save the old ship. Turning next to medicine, and convinced by a brief experience in Boston that he liked it, he went to Paris in March 1833. He studied industriously under Louis and other famous physicians and surgeons in France, and in his vacations visited the Low Countries, England, Scotland and Italy. Returning to Boston at the close of 1835, filled with a high professional ambition, he sought practice, but achieved only moderate success. Social, brilliant in conversation, and a writer of gay little poems, he seemed to the grave Bostonians not sufficiently serious. He won prizes, however, for professional papers, and lectured on anatomy at Dartmouth College. He wrote two papers on homoeopathy, which he attacked with trenchant wit; also a valuable paper on the malarial fevers of New England. In 1843 he published his essay on the *Contagiousness of Puerperal Fever*, which stirred up a fierce controversy and brought upon him bitter personal abuse; but he maintained his position with dignity, temper and judgment; and in time he was honoured

as the discoverer of a beneficent truth. The volume of his medical essays holds some of his most sparkling wit, his shrewdest observation, his kindest humanity. In 1840 he married Amelia Lee Jackson, daughter of the Hon. Charles Jackson (1775-1855), formerly associate justice of the State supreme judicial court, a lady of rare charm alike of mind and character. She died in the winter of 1887-1888. Their first-born child, Oliver Wendell Holmes, afterwards became chief justice of that same bench on which his grandfather sat. In 1847 Dr Holmes was appointed professor of anatomy and physiology in the Medical School of Harvard University, the duties involving the giving of instruction also in kindred departments, so that, as he said, he occupied "not a chair, but a settee in the school." He delivered the anatomical lectures until November 1882, and in later years these were his only link with the medical profession. They were fresh, witty and lively; and the students were sent to him at the end of the day, when they were fagged, because he alone could keep them awake. In later years he made few finished contributions to medical knowledge; his eager and impetuous temperament caused him to leave more patient investigators to push to ultimate results the suggestions thrown out by his fertile and imaginative mind.

In 1836, being in that year the Phi Beta Kappa poet at Harvard University, he published his first volume of *Poems*, which afterwards reached a second edition. Among these earlier lyrics was "The Last Leaf," one of the most delicate combinations of pathos and humour in literature. His collected poetry fills three volumes. In 1856-1857 a Boston publishing house (Phillips, Sampson, and Co.) invited James Russell Lowell to edit a new magazine, which he agreed to do on condition that he could secure the assistance of Dr Holmes. By this urgent invitation the Doctor was equally surprised and flattered, for heretofore he had stood rather outside the literary coterie of Cambridge and Boston. He accepted with pleasure, and at once threw himself into the enterprise with zeal. He christened it *The Atlantic Monthly*; and, as Mr Howells afterwards said, he "not only named but made" it, for in each number of its first volume there appeared one of the papers of the *Autocrat of the Breakfast Table*. The opening of the *Autocrat*—"I was just going to say when I was interrupted"—is explained by the fact that in the old *New England Magazine* (1831 to 1833) the Doctor had published two *Autocrat* papers, which, by his wish, have never been reprinted. In the commercial panic of 1857 the new magazine would inevitably have failed had it not been for these fascinating essays. Their originality of conception, their wit and humour, their expression of New Englandism, all combined to make them so popular that the most harassed merchant in that gloomy winter purchased them as a dose of cheering medicine. Thus Dr Holmes made *The Atlantic Monthly*, which in return made him. A success so immediate and so splendid settled the rest of his career; he ceased to be a physician and became an author. These twelve papers were immediately (1858) published as a volume. No sooner was the *Autocrat* silent than the *Professor* (1859) succeeded him at the breakfast table. The *Professor* was preferred by more thoughtful readers, though it has hardly been so widely popular as the *Autocrat*. Its theology, which seemed in those days audacious, frightened many of the strict and old-fashioned religionists of New England, though to-day it seems mild enough. Twelve years later, in 1871, the Landlady had another boarder, who took the vacant chair—the *Poet* (published 1872). But here Holmes fell a little short. In these three books, especially in the *Autocrat* and the *Professor*, the Doctor wrote as he talked at many a dinner table in Boston, but less well. The animation and clash of talk roused him. The dinners of the Saturday Club are among Boston's proudest traditions, as they were the chief pleasure of Dr Holmes's life. There he met Emerson, Longfellow, Whittier, Lowell, Sumner, Agassiz, Motley, and many other charming talkers, and among them all he was admitted to be the best.

There were characters and incidents, but hardly a story, in the *Autocrat* and the *Professor*. Holmes had an ambition for

more sustained work, and in 1861 his novel, *Elsie Venner*, at first called *The Professor's Story*, was published. The book was illuminated throughout by admirable pictures of character and society in the typical New England town. But the rattlesnake element was unduly extravagant, and in other respects the book was open to criticism as a work of art. It was written with the same purpose which informed the greatest part of the Doctor's literary work, and which had already been scented and nervously condemned by the religious world. By heredity the Doctor was a theologian; no other topic enchained him more than did the stern and merciless dogmas of his Calvinist forefathers. His humanity revolted against them, his reason condemned them, and he set himself to their destruction as his task in literature. The religious world of his time was still so largely under the control of old ideas that he was assailed as a freethinker and a subverter of Christianity; though before his death opinions had so changed that the bitterness of the attacks upon him seemed incredible, even to some of those who had most vehemently made them. None the less, undaunted and profoundly earnest, he returned, six years later, to the same line of thought in his second novel, *The Guardian Angel* (published 1867). This, though less well known than *Elsie Venner*, is in many respects better. No more lifelike and charming picture of the society of the New England country-town of the middle third of the 19th century has ever been drawn, and every page sparkles with wit and humour. In 1884 and 1885 it was followed, still in the same line, by *A Morbid Antipathy*, a production inferior to its predecessors.

Holmes generally held himself aloof from politics, and from those "causes" of temperance, abolition and woman's rights which enthralled most of his contemporaries in New England. The Civil War, however, aroused him for the time; finding him first a strenuous Unionist, it quickly converted him into an ardent advocate of emancipation. His interest was enhanced by the career of his elder son Oliver (see below), who was three times severely wounded, and finally rose to the rank of lieutenant-colonel in the Northern army. He wrote some ringing war lyrics, and in 1863 delivered the Fourth of July oration in Boston, which showed a mastery appreciation of the stirring public questions of the day. In 1878 Dr Holmes wrote a memoir of the historian John Lothrop Motley, an affectionate tribute to one who had been his dear friend. In 1884 he contributed the life of Emerson to the American "Men of Letters" series. He admired the "Sage of Concord," but was not quite in intellectual sympathy with him. Both were Liberals in thought, but in widely different ways. But in spite of this handicap the volume proved very popular. In 1888 he began the papers which he happily christened *Over the Tea Cups*. As a *tour de force* on the part of a man of nearly fourscore years they are very remarkable.

After his return from Paris in 1835 Dr Holmes lived in Boston, with summer sojournings at Pittsfield and Beverly Farms, and occasional trips to neighbouring cities, until 1886. He then undertook a four months' journey in Europe, and in England had a sort of triumphal progress. On his return he wrote *Our Hundred Days in Europe* (1887), a courteous recognition of the hospitality and praise which had been accorded to him. During this visit Cambridge University made him Doctor of Letters, Edinburgh University made him Doctor of Laws, and Oxford University made him Doctor of Civil Law. Already, in 1880, Harvard University had made him Doctor of Laws. He died on the 7th of October 1894, and was buried from King's Chapel, Boston, in the cemetery of Mount Auburn.

His eldest son Oliver Wendell (b. 1847), who graduated from Harvard in 1861 and fought in the Civil War, retiring from the army as brevet lieutenant-colonel in 1864, took up the study of law and was admitted to the bar in Boston in 1866. He was for some years editor of the *American Law Review*, and after being professor in the Harvard Law School in 1882 was appointed in the same year a judge of the Massachusetts supreme court, rising to be chief justice in 1890. In 1902 he was made a judge of the United States Supreme Court. His work on *The Common Law* (1881) and his edition (1873) of Kent's *Commentaries*

are his principal publications; and he became widely recognized as one of the great jurists of his day.

BIBLIOGRAPHY.—Holmes's *Complete Works*, in 13 volumes, were published at Boston in 1891. See J. T. Morse, *Life and Letters of Oliver Wendell Holmes* (London, 1896); G. B. Ives, *Bibliography* (Boston, 1907); and the bibliography in P. K. Foley's *American Authors* (Boston, 1897). An essay by Sir Leslie Stephen is prefixed to the "Golden Treasury" edition (1903) of *The Autocrat of the Breakfast Table*. See also monographs by William Sloane Kennedy (Boston, 1882); Emma E. Brown (Boston, 1884). (J. T. Mo.)

HOLMFIRTH, an urban district in the Holmfirth parliamentary division of the West Riding of Yorkshire, England, and on Holme and the Ribble, 6 m. S. of Huddersfield, and on the Lancashire and Yorkshire railway. Pop. (1901) 8977. The valley, walled by bold hills, is very picturesque. In 1852 great destruction was wrought in the town by the bursting of a reservoir in the vicinity. The large industrial population is employed in woolen manufactories, and in the neighbouring stone quarries.

-HOLOCAUST (Gr. *ἁλόκαυστος*, or *ἁλόκαυτος*, wholly burnt), strictly a sacrifice wholly destroyed by fire, such as the sacrifices of the Jews, described in the Pentateuch as "whole burnt offerings" (see **SACRIFICE**). The term is now often applied to a catastrophe on a large scale, whether by fire or not, or to a massacre or slaughter.

HolocENE (from Gr. *ἅλος*, whole, *καίνος*, recent), in geology, the time division which embraces the youngest of all the formations; it is equivalent to the "Recent" of some authors. The name was proposed in 1860 by P. Gervais. The oldest deposits that may be included are those containing neolithic implements; deposits of historic times should also be grouped here; presumably the youngest are those to be chronicled by the last man. The Holocene formations obviously include all the varieties of deposits which are accumulating at the present day: the gravels and alluvia of rivers; boulder clays, moraines and fluvioglacial deposits; estuarine, coastal and abyssal deposits of the sea, and their equivalents in lakes; scree, taluses, wind-borne dust and sand and desert formations; chemical deposits from saline waters; peat, diatomite, marls, foraminiferal and other ooze; coral, algal and shell banks, and other organic deposits; mud, lava and dust deposits of volcanic origin and extrusions of asphalt and pitch; to all these must be added the works of man.

HOLROYD, SIR CHARLES (1861—), British artist, was born in Leeds on the 9th of April 1861. He received his art education under Professor Legros at the Slade School, University College, London, where he had a distinguished career. After passing six months at Newlyn, where he painted his first picture exhibited in the Royal Academy, "Fishermen Mending a Sail" (1885), he obtained a travelling scholarship and studied for two years in Italy, a sojourn which greatly influenced his art. At his return, on the invitation of Legros, he became for two years assistant-master at the Slade School, and there devoted himself to painting and etching. Among his pictures may be mentioned "The Death of Torrigiano" (1886), "The Satyr King" (1889), "The Supper at Emmaus," and, perhaps his best picture, "Pan and Peasants" (1893). For the church of Aveley, Essex, he painted a triptych altarpiece, "The Adoration of the Shepherds," with wings representing "St Michael" and "St Gabriel," and designed as well the window, "The Resurrection." His portraits, such as that of "G. F. Watts, R.A.," in the Legros manner, show much dignity and distinction. Sir Charles Holroyd has made his chief reputation as an etcher of exceptional ability, combining strength with delicacy, and a profound technical knowledge of the art. Among the best known are the "Monte Oliveto" series, the "Icarus" series, the "Monte Subasio" series, and the "Eve" series; together with the plates, "The Flight into Egypt," "The Prodigal Son," "A Barn on Tadworth Common" (etched in the open air), and "The Storm." His etched heads of "Professor Legros," "Lord Courtney" and "Night," are admirable alike in knowledge and in likeness. His principal dry-point is "The Bather." In all his work Holroyd displays an impressive sincerity, with a fine sense of composition, and of style, allied to independent and modern feeling. He was appointed the first keeper of the National Gallery of British Art

(Tate Gallery), and on the retirement of Sir Edward Poynter in 1906 he received the directorship of the National Gallery. He was knighted in 1903. His *Michael Angelo Bismarck* (London, Duckworth, 1903) is a scholarly work of real value.

HOLSTEIN, FRIEDRICH VON (1837-1909), German statesman, for more than thirty years head of the political department of the German Foreign Office. Holstein's importance began with the dismissal of Bismarck in 1890. The new chancellor, Caprivi, was ignorant of foreign affairs; and Holstein, as the repository of the Bismarckian tradition, became indispensable. This reluctance to emerge into publicity has been ascribed to the part he had played under Bismarck in the Armin affair, which had made him powerful enemies; it was, however, possibly due to a shrinking from the responsibility of office. Yet the weakness of his position lay just in the fact that he was not ultimately responsible. He protested against the despatch of the "Kruger telegram," but protested in vain. On the other hand, where his ideas were acceptable, he was generally able to realize them. Thus it was almost entirely due to him that Germany acquired Kiao-chau and asserted her interests in China, and the acquisition of Samoa was also largely his work. If the skill and pertinacity with which Holstein carried through his plans in these matters was learned in the school of Bismarck, he had not acquired Bismarck's faculty for foreseeing their ulterior consequences. This is true of his Chinese policy, and true also of his part in the Morocco crisis. The emperor William II.'s journey to Tangier was undertaken on his advice, as a protest against the supposed attempt at the isolation of Germany; but of the later developments of German policy in the Morocco question he did not approve, on the ground that the result would merely be to strengthen the Anglo-French *entente*; and from the 12th of March 1906 onwards he took no active part in the matter. To the last he believed that the position of Germany would remain unsafe until an understanding had been arrived at with Great Britain, and it was this belief that determined his attitude towards the question of the fleet, "beside which," he wrote in February 1909, "all other questions are of lesser account." His views on this question were summarized in a memorandum of December 1907, of which Herr von Rath gives a *résumé*. He objected to the programme of the German Navy League on three main grounds: (1) the ill-feeling likely to be aroused in South Germany, (2) the inevitable dislocation of the finances through the huge additional charges involved, (3) the suspicion of Germany's motives in foreign countries, which would bind Great Britain still closer to France. As for the idea that Germany's power would be increased, this—he wrote in reply to a letter from Admiral Gölster—was "a simple question of arithmetic"; for how would the sea-power of Germany be relatively increased if for every new German ship Great Britain built two? Herr von Holstein retired on the resignation of Prince Bülow, and died on the 8th of May 1909.

See Hermann von Rath, "Erinnerungen an Herrn von Holstein" in the *Deutsche Revue* for October 1909. He is also frequently mentioned *passim* in Prince Chlodwig Hohenlohe's *Memoirs*.

HOLSTEIN, formerly a duchy of Germany. Until about 1110 the county of Holstein formed part of the duchy of Saxony, and it was made a duchy in 1472. From 1460 to 1864 it was ruled by members of the house of Oldenburg, some of whom were also kings of Denmark. It is now the southern part of the Prussian province of Schleswig-Holstein. (See **SCHLESWIG-HOLSTEIN**, and for history **SCHLESWIG-HOLSTEIN QUESTION**.)

HOLSTEIN, KARL CHRISTIAN JOHANN (1825-1897), German theologian, was born at Güstrow, Mecklenburg, on the 31st of March 1825, and educated at Leipzig, Berlin and Rostock, where in 1852 he became a teacher of religion in the Gymnasium. In 1870 he went to Bern as professor of New Testament studies, passing thence in 1876 to Heidelberg, where he remained until his death on the 26th of January 1897. Holstein was an adherent of the Tübingen school, and held to Baur's views on the alleged antagonism between Petrinism and Paulinism.

Among his writings are *Zum Evangelium d. Paulus und d. Petrus* (1867); *Das Evangelium des Paulus dargestellt* (1880); *Die synoptischen Evangelien nach der Form ihres Inhalts* (1886).

HOLSTENIUS, LUCAS, the Latinized name of Luc Holste (1596-1661), German humanist, geographer and theological writer, was born at Hamburg. He studied at Leiden university, where he became intimate with the most famous scholars of the age—J. Meursius, D. Heinsius and P. Cluverius, whom he accompanied on his travels in Italy and Sicily. Disappointed at his failure to obtain a post in the gymnasium of his native town, he left Germany for good. Having spent two years in Oxford and London, he went to Paris. Here he obtained the patronage of N. de Peiresc, who recommended him to Cardinal Francesco Barberini, papal nuncio and the possessor of the most important private library in Rome. On the cardinal's return in 1627 he took Holstenius to live with him in his palace and made him his librarian. Although converted to Roman Catholicism in 1625, Holstenius showed his liberal-mindedness by strenuously opposing the strict censorship exercised by the Congregation of the Index. He was appointed librarian of the Vatican by Innocent X., and was sent to Innsbruck by Alexander VII. to receive Queen Christina's abjuration of Protestantism. He died in Rome on the 2nd of February 1661. Holstenius was a man of unwearied industry and immense learning, but he lacked the persistency to carry out the vast literary schemes he had planned. He was the author of notes on Cluver's *Italia antiqua* (1624); an edition of portions of Porphyrius (1630), with a dissertation on his life and writings, described as a model of its kind; notes on Eusebius *Against Hierocles* (1628), on the Sayings of the later Pythagoreans (1638), and the *De diis et mundo* of the neo-Platonic Sallustius (1638); *Nolae et castigationes in Stephani Byzantini ethnica* (first published in 1684); and *Codex regularum, Collection of the Early Rules of the Monastic Orders* (1661). His correspondence (*Epistolae ad diversos*, ed. J. F. Boissonade, 1817) is a valuable source of information on the literary history of his time.

See N. Wilckens, *Leben des gelehrten Lucas Holstenii* (Hamburg, 1723); Johann Moller, *Cimbria literata*, iii. (1744).

HOLSTER, a leather case to hold a pistol, used by a horseman and properly fastened to the saddle-bow, but sometimes worn in the belt. The same word appears in Dutch, from which the English word probably directly derives. The root is *hel-* or *hul-* to cover, and is seen in the O. Eng. *heolster*, a place of shelter or concealment, and in "hull" a sheath or covering. The German word for the same object, *holster*, is, according to the *New English Dictionary*, from a different root.

HOLT, SIR JOHN (1642-1710), lord chief justice of England, was born at Thame, Oxfordshire, on the 30th of December 1642. His father, Sir Thomas Holt, possessed a small patrimonial estate, but in order to supplement his income had adopted the profession of law, in which he was not very successful, although he became sergeant in 1677, and afterwards for his political services to the "Tories" was rewarded with knighthood. After attending for some years the free school of the town of Abingdon, of which his father was recorder, young Holt in his sixteenth year entered Oriol College, Oxford. He is said to have spent a very dissipated youth, and even to have been in the habit of taking purses on the highway, but after entering Gray's Inn about 1660 he applied himself with exemplary diligence to the study of law. He was called to the bar in 1663. An ardent supporter of civil and religious liberty, he distinguished himself in the state trials which were then so common by the able and courageous manner in which he supported the pleas of the defendants. In 1685-1686 he was appointed recorder of London, and about the same time he was made king's sergeant and received the honour of knighthood. His giving a decision adverse to the pretensions of the king to exercise martial law in time of peace led to his dismissal from the office of recorder, but he was continued in the office of king's sergeant in order to prevent him from becoming counsel for accused persons. Having been one of the judges who acted as assessors to the peers in the Convention parliament, he took a leading part in arranging the constitutional change by which William III. was called to the throne, and after his accession he was appointed lord chief justice of the King's Bench. His merits as a judge are the more apparent and the more remarkable

when contrasted with the qualities displayed by his predecessors in office. In judicial fairness, legal knowledge and ability, clearness of statement and unbending integrity he has had few if any superiors on the English bench. Over the civil rights of his countrymen he exercised a jealous watchfulness, more especially when presiding at the trial of state prosecutions, and he was especially careful that all accused persons should be treated with fairness and respect. He is, however, best known for the firmness with which he upheld his own prerogatives in opposition to the authority of the Houses of Parliament. On several occasions his physical as well as his moral courage was tried by extreme tests. Having been requested to supply a number of police to help the soldiery in quelling a riot, he assured the messenger that if any of the people were shot he would have the soldiers hanged, and proceeding himself to the scene of riot he was successful in preventing bloodshed. While steadfast in his sympathies with the Whig party, Holt maintained on the bench entire political impartiality, and always held himself aloof from political intrigue. On the retirement of Somers from the chancellorship in 1700 he was offered the great seal, but declined it. His death took place in London on the 5th of March 1710. He was buried in the chancel of Redgrave church.

Reports of Cases determined by Sir John Holt (1681-1710) appeared at London in 1738; and *The Judgments delivered in the case of Ashby v. White and others, and in the case of John Paty and others, printed from original MSS.*, at London (1837). See *Burnet's Own Times*; *Taller*, No. xiv.; a *Life*, published in 1764; *Welsby, Lives of Eminent English Judges of the 17th and 18th Centuries* (1846); *Campbell's Lives of the Lord Chief Justices*; and *Foss, Lives of the Judges*.

HOLTEI, KARL EDUARD VON (1798-1880), German poet and actor, was born at Breslau on the 24th of January 1798, the son of an officer of Hussars. Having served in the Prussian army as a volunteer in 1815, he shortly afterwards entered the university of Breslau as a student of law; but, attracted by the stage, he soon forsook academic life and made his debut in the Breslau theatre as Mortimer in Schiller's *Maria Stuart*. He led a wandering life for the next two years, appearing less on the stage as an actor than as a reciter of his own poems. In 1821 he married the actress Luise Rogée (1800-1825), and was appointed theatre-poet to the Breslau stage. He next removed to Berlin, where his wife fulfilled an engagement at the Court theatre. During his sojourn here he produced the vaudevilles *Die Wiener in Berlin* (1824), and *Die Berliner in Wien* (1825), pieces which enjoyed at the time great popular favour. In 1825 his wife died; but soon after her death he accepted an engagement at the Königstädter theatre in Berlin, when he wrote a number of plays, notably *Lenore* (1829) and *Der alte Feldherr* (1829). In 1830 he married Julie Holzbecher (1800-1839), an actress engaged at the same theatre, and with her played in Darmstadt. Returning to Berlin in 1831 he wrote for the composer Franz Gläser (1798-1861) the text of the opera *Des Adlers Horst* (1835), and for Ludwig Devrient the drama, *Der dumme Peter* (1837). In 1833 Holtei again went on the stage and toured with his wife to various important cities, Hamburg, Leipzig, Dresden, Munich and Vienna. In the last his declamatory powers as a reciter, particularly of Shakespeare's plays, made a furore, and the poet-actor was given the appointment of manager of the Josefstädter theatre in the last-named city. Though proud of his successes both as actor and reciter, Holtei left Vienna in 1836, and from 1837 to 1839 conducted the theatre in Riga. Here his second wife died, and after wandering through Germany reciting and accepting a short engagement at Breslau, he settled in 1847 at Graz, where he devoted himself to a literary life and produced the novels *Die Vagabunden* (1851), *Christian Lammfell* (1853) and *Der letzte Komödiant* (1863). The last years of his life were spent at Breslau, where being in poor circumstances he found a home in the *Kloster der barmherzigen Brüder*, and here he died on the 12th of February 1880.

As a dramatist Holtei may be said to have introduced the "vaudeville" into Germany; as an actor, although remaining behind the greater artists of his time, he contrived to fascinate his audience by the dramatic force of his exposition of character; as a reciter, especially of Shakespeare, he knew no rival. August

Lewald said of Holtei that by the energy of his poetic conception and plastic force he brought his audience round to his own ideas; and he added, "an eloquence such as his I have never met with in any other German."

Holtei was not only a stage-poet but a lyric-writer of great charm. Notable among such productions are *Schlesische Gedichte* (1830; 20th ed., 1893), *Gedichte* (5th ed., 1861), *Stimmen des Waldes* (2nd ed., 1854). Mention ought also to be made of Holtei's interesting autobiography, *Viersig Jahre* (8 vols., 1843-1850; 3rd ed., 1862) with the supplementary volume *Noch ein Jahr in Schlesien* (1864).

Holtei's *Theater* appeared in 6 vols. (1867); his *Erzählende Schriften*, 39 vols. (1861-1866). See M. Kurnick, *Karl von Holtei, ein Lebensbild* (1880); F. Wehl, *Zeit und Menschen* (1889); O. Storch, *K. von Holtei* (1898).

HÖLTY, LUDWIG HEINRICH CHRISTOPH (1748-1776), German poet, was born on the 21st of December 1748 at the village of Mariensee in Hanover, where his father was pastor. In 1769 he went to study theology at Göttingen. Here he formed a close friendship with J. M. Miller, J. H. Voss, H. Boie, the brothers Stolberg and others, and became one of the founders of the famous society of young poets known as the *Göttinger Dichterbund* or *Hain*. When in 1774 he left the university he had abandoned all intention of becoming a clergyman; but he was not destined to enter any other profession. He died of consumption on the 1st of September 1776 at Hanover. Höly was the most gifted lyric poet of the Göttingen circle. He was influenced both by Uz and Klopstock, but his love for the Volkslied and his delight in nature preserved him from the artificiality of the one poet and the unworldliness of the other. A strain of melancholy runs through all his lyrics. His ballads are the pioneers of the rich ballad literature on English models, which sprang up in Germany during the next few years. Among his most familiar poems may be mentioned *Üb' immer Treu' und Redlichkeit, Tanzt dem schönen Mai entgegen, Rosen auf dem Weg gestreut, and Wer wollte sich mit Grillen plagen*.

Höly's *Gedichte* were published by his friends Count Friedrich Leopold zu Stolberg and J. H. Voss (Hamburg, 1783); a new edition, enlarged by Voss, with a biography (1804); a more complete but still imperfect edition by F. Voigts (Hanover, 1857). The first complete edition was that of Karl Halm (Leipzig, 1870), who had access to MSS. not hitherto known. See H. Ruete, *Höly, sein Leben und Dichten* (Guben, 1883), and A. Sauer, *Der Göttinger Dichterbund*, vol. ii. (Stuttgart, 1894), where an excellent selection of Höly's poetry will be found.

HOLTZENDORFF, JOACHIM WILHELM FRANZ PHILIPP VON (1829-1889), German jurist, born at Vietmannsdorf, in the Mark of Brandenburg, on the 14th of October 1829, was descended from a family of the old nobility. He was educated at Berlin and at Pforta, afterwards studying law at the universities of Bonn, Heidelberg and Berlin. The struggles of 1848 inspired him with youthful enthusiasm, and he remained for the rest of his life a strong advocate of political liberty. In 1852 he graduated LL.D. at Berlin; in 1857 he became a Privatdocent, and in 1860 he was nominated a professor extraordinary. The predominant party in Prussia regarded his political opinions with mistrust, and he was not offered an ordinary professorship until February 1873, after he had decided to accept a chair at the university of Munich. At Munich he passed the last nineteen years of his life. During the thirty years that he was professor he successively taught several branches of jurisprudence, but he was chiefly distinguished as an authority on criminal and international law. He was especially well fitted for organizing collective work, and he has associated his name with a series of publications of the first value. While acting as editor he often reserved for himself, among the independent monographs of which the work was composed, only those on subjects distasteful to his collaborators on account of their obscurity or lack of importance. Among the compilations which he superintended may be mentioned his *Encyclopädie der Rechtswissenschaft* (Leipzig, 1870-1871, 2 vols.); his *Handbuch des deutschen Strafrechts* (Berlin, 1871-1877, 4 vols.), and his *Handbuch des Völkerrechts auf Grundlage europäischer Staatspraxis* (Berlin, 1885-1890, 4 vols.). Among

his many independent works may be mentioned: *Das irische Gefängnisssystem* (Leipzig, 1859), *Frankrische Rechtsanstände* (Leipzig, 1859), *Die Deportation als Strafmittel* (Leipzig, 1859), *Die Kürzungsfähigkeit der Freiheitsstrafen* (Leipzig, 1861), *Die Reform der Staatsanwaltschaft in Deutschland* (Berlin, 1864), *Die Umgestaltung der Staatsanwaltschaft* (Berlin, 1865), *Die Principien der Politik* (Berlin, 1869), *Das Verbrechen des Mordes und die Todesstrafe* (Berlin, 1875), *Rumänien's Uferrechte an der Donau* (Leipzig, 1883; French edition, 1884). He also edited or assisted in editing a number of periodical publications on legal subjects. From 1866 to the time of his death he was associated with Rudolf Ludwig Carl Virchow in editing *Sammlung gemeinverständlicher wissenschaftlicher Vorträge* (Berlin). Von Holtzendorff died at Munich on the 4th of February 1889.

HOLTZMANN, HEINRICH JULIUS (1832-), German Protestant theologian, son of Karl Julius Holtzmann (1804-1877), was born on the 17th of May 1832 at Karlsruhe, where his father ultimately became prelate and counsellor to the supreme consistory. He studied at Berlin, and eventually (1874) was appointed professor ordinarius at Strassburg. A moderately liberal theologian, he became best known as a New Testament critic and exegete, being the author of the *Commentary on the Synoptics* (1889; 3rd ed., 1902), the *Johannine books* (1890; 2nd ed., 1893), and the *Acts of the Apostles* (1901), in the series *Handkommentar zum Neuen Testament*. On the question of the relationship of the Synoptic Gospels, Holtzmann in his early work, *Die synoptischen Evangelien, ihr Ursprung und geschichtlicher Charakter* (1863), presents a view which has been widely accepted, maintaining the priority of Mark, deriving Matthew in its present form from Mark and from Matthew's earlier "collection of Sayings," the Logia of Papias, and Luke from Matthew and Mark in the form in which we have them.

Other noteworthy works are the *Lehrbuch der histor-kritischen Einleitung in das Neue Testament* (1885, 3rd ed., 1892) and the *Lehrbuch der neutestamentlichen Theologie* (2 vols., 1896-1897). He also collaborated with R. Zöfel in the preparation of a small *Lexikon für Theologie und Kirchenwesen* (1882; 3rd ed., 1895), and in 1893 became editor of the *Theol. Jahrbücher*.

HOLUB, EMIL (1847-1902), Bohemian traveller in south-central Africa, was born at Holitz, eastern Bohemia, on the 7th of October 1847. He was educated at Prague University, where he graduated M.D. In 1872 he went to the Kimberley diamond-fields, and with the money earned by his practice as a surgeon undertook expeditions into the northern Transvaal, Mashonaland and through Bechuanaland to the Victoria Falls, making extensive natural history collections, which he brought to Europe in 1879 and distributed among over a hundred museums and schools. In 1883 he went back to South Africa with his wife, intending to cross the continent to Egypt. In June 1886 the party crossed the Zambezi west of the Victoria Falls, and explored the then almost unknown region between that river and its tributary the Kafue. When beyond the Kafue the camp was attacked by the Mashukulumbwe, and Holub was obliged to retrace his steps. He returned to Austria in 1887 with a collection of great scientific interest, of over 13,000 objects, now in various museums. Holub died at Vienna on the 21st of February 1902.

His principal works are: *Eine Culturskizze des Marutse-Mambanda-reichs* (Vienna, 1879); *Sieben Jahre in Südafrika, &c.* (2 vols., Vienna, 1880-1881), of which an English translation appeared; *Die Colonisation Afrikas* (Vienna, 1882); and *Vom der Kapstadt ins Land der Maschukulumbwe* (2 vols., Vienna, 1818-1890).

HOLY, sacred, devoted or set apart for religious worship or observance; a term characteristic of the attributes of perfection and sinlessness of the Persons of the Trinity, as the objects of human worship and reverence, and hence transferred to those human persons who, either by their devotion to a spiritual ascetic life or by their approximation to moral perfection, are considered worthy of reverence. The word in Old English was *hālig*, and is common to other Teutonic languages; cf. Ger. and Dutch *heilig*, Swed. *helig*, Dan. *hellig*. It is derived from *hāl*, hale, whole, and cognate with "health." The *New English Dictionary* suggests that the sense-development may be from "whole," i.e. inviolate, from "health,

well-being," or from "good-omen," "augury." It is impossible to get behind the Christian uses, in which from the earliest times it was employed as the equivalent of the Latin *sacer* and *sanctus*.

HOLY ALLIANCE, THE. The famous treaty, or declaration, known by this name was signed in the first instance by Alexander I., emperor of Russia, Francis I., emperor of Austria, and Frederick William III., king of Prussia, on the 26th of September 1815, and was proclaimed by the emperor Alexander the same day at a great review of the allied troops held on the Champ des Vertus near Paris. The English version of the text is as follows:—

In the name of the Most Holy and Indivisible Trinity.

Holy Alliance of Sovereigns of Austria, Prussia and Russia.

Their Majesties the Emperor of Austria, the King of Prussia, and the Emperor of Russia, having, in consequence of the great events which have marked the course of the three last years in Europe, and especially of the blessings which it has pleased Divine Providence to shower down upon those States which place their confidence and their hope on it alone, acquired the intimate conviction of the necessity of settling the steps to be observed by the Powers, in their reciprocal relations, upon the sublime truths which the Holy Religion of our Saviour teaches;

Government and Political Relations.

They solemnly declare that the present Act has no other object than to publish, in the face of the whole world, their fixed resolution, both in the administration of their respective States, and in their political relations with every other Government, to take for their sole guide the precepts of that Holy Religion, namely, the precepts of Justice, Christian Charity and Peace, which, far from being applicable only to private concerns, must have an immediate influence on the councils of Princes, and guide all their steps, as being the only means of consolidating human institutions and remedying their imperfections. In consequence, their Majesties have agreed on the following Articles:—

Principles of the Christian Religion.

Art. I. Conformably to the words of the Holy Scriptures which command all men to consider each other as brethren, the Three contracting Monarchs will remain united by the bonds of a true and indissoluble fraternity, and, considering each other as fellow countrymen, they will, on all occasions and in all places, lend each other aid and assistance; and, regarding themselves towards their subjects and armies as fathers of families, they will lead them, in the same spirit of fraternity with which they are animated, to protect Religion, Peace and Justice.

Fraternity and Affection.

Art. II. In consequence, the sole principle of force, whether between the said Governments or between their Subjects, shall be that of doing each other reciprocal service, and of testifying by unalterable good will the mutual affection with which they ought to be animated, to consider themselves all as members of one and the same Christian nation; the three allied Princes looking on themselves as merely delegated by Providence to govern three branches of the One family, namely, Austria, Prussia and Russia, thus confessing that the Christian world, of which they and their people form a part, has in reality no other Sovereign than Him to whom alone power really belongs, because in Him alone are found all the treasures of love, science and infinite wisdom, that is to say, God, our Divine Saviour, the Word of the Most High, the Word of Life. Their Majesties consequently recommend to their people, with the most tender solicitude, as the sole means of enjoying that Peace which arises from a good conscience, and which alone is durable, to strengthen themselves every day more and more in the principles and exercise of the duties which the Divine Saviour has taught to mankind.

Accession of Foreign Powers.

Art. III. All the Powers who shall choose solemnly to avow the sacred principles which have dictated the present Act, and shall acknowledge how important it is for the happiness of nations, too long agitated, that these truths should henceforth exercise over the destinies of mankind all the influence which belongs to them, will be received with equal ardour and affection into this Holy Alliance.

The credit for inspiring this singular document was claimed by the Baroness von Krüdener (*q.v.*); in any case it was the outcome of the tsar's mood of evangelical exaltation, and was in its inception perfectly sincere. Neither Frederick William nor Francis signed willingly, the latter remarking that "if it was a question of politics, he must refer it to his chancellor, if of religion, to his confessor." Metternich called it a "loud-sounding nothing," Castlereagh, "a piece of sublime mysticism and nonsense." None the less, in accordance with its last article, the signatures of all the European sovereigns were invited to the

instrument, the pope and the Ottoman sultan alone being excepted. The prince regent courteously declined to sign, on the constitutional ground that all acts of the British crown required the counter-signature of a minister, but he sent a letter expressing his "entire concurrence with the principles laid down by the 'august sovereigns' and stating that it would always be his endeavour to regulate his conduct by their 'sacred maxims.'" With these exceptions, all the European sovereigns sooner or later appended their names.

In popular parlance, which has found its way into the language of serious historians, the "Holy Alliance" soon became synonymous with the combination of the great powers by whom Europe was ruled in concert during the period of the congresses, and associated with the policy of reaction which gradually dominated their counsels. For the understanding of the inner history of the diplomacy of this period, however, a clear distinction must be drawn between the Holy Alliance and the Grand, or Quadruple (Quintuple) Alliance. The Grand Alliance was established on definite treaties concluded for definite purposes, of which the chief was the preservation of peace on the basis of the territorial settlement of 1815. The Holy Alliance was a general treaty—hardly indeed a treaty at all—which bound its signatories to act on certain vague principles for no well-defined end; and in its essence it was so far from necessarily reactionary that the emperor Alexander at one time declared that it involved the grant of liberal constitutions by princes to their subjects. Its main significance was due to the persistent efforts of the tsar to make it the basis of the "universal union," or general confederation of Europe, which he wished to substitute for the actual committee of the great powers, efforts which were frustrated by the vigorous diplomacy of Castlereagh, acting as the mouthpiece of the British government (see *EUROPE: History*; ALEXANDER I. of Russia; LONDONDERRY, ROBERT STEWART, 2ND MARQUIS OF).

As a diplomatic instrument the Holy Alliance never, as a matter of fact, became effective. None the less, its principles and the fact of its signature powerfully affected the course of European diplomacy during the 19th century. It strongly influenced the emperor Nicholas I. of Russia, to whom the brotherhood of sovereigns by divine right was an article of faith, inspiring the principles of the convention of Berlin (between Russia, Austria and Prussia) in 1833, and the tsar's intervention in 1849 to crush the Hungarian insurrection on behalf of his brother of Austria. That it had become synonymous with a conspiracy against popular liberties was, however, a mere accident of the point of view of those who interpreted its principles. It was capable of other and more noble interpretations, and it was avowedly the inspiration of the famous rescript of the emperor Nicholas II., embodied in the circular of Count Muraviev to the European courts (August 4th, 1898), which issued in the first international peace conference at the Hague in 1899. (W. A. P.)

HOLYHEAD (Caergybi, the fort of Cybi, the saint mentioned by Matthew Arnold as meeting St Seiriol of Penmon, Anglesey), a seaport and market-town of Anglesey, N. Wales, situated on the small Holy Island, at the western end of the county. Pop. of urban district (1901) 10,079. Here the London and North-Western railway has a terminus, 263½ m. from London by rail. Holy Island is connected with Anglesey by an embankment, ½ m. long, over which pass the railway and main road, the tide flowing fast under the central piers. Once a small fishing village, the town has since William IV.'s reign acquired importance as the Dublin mail steam station. Its magnificent harbour of refuge was begun in 1847 and opened in September 1873. The east breakwater scheme, which would have covered the Platter's rocks—still very troublesome—and the Skinner's, was abandoned for buoys which mark the spots. The north breakwater is 7860 ft. long (instead of 5360, as originally planned). The roadstead (400 acres) and enclosed area (267 acres) together make a magnificent shelter for shipping. The rubble mound of the breakwater was very costly to the railway company, as time after time it was swept away by storms. On it is a central

wall of some 38 ft. above low water, and on the wall a promenade sheltered by a parapet. The lighthouse is at the end of the breakwater, of which the whole cost was nearly 1½ million sterling. Additional works, begun in 1873 by the company, to extend the old harbour and lengthen the quay by 4000 ft., were opened by King Edward VII. (as prince of Wales) in 1880. These cost another half million. George IV. passed through Holyhead in 1821 on his way to Ireland, and there is a commemorative tablet on the old harbour pier. The church is said to occupy the site of the old monastery (6th or early 7th century) of St Cybi, of whom there is a rude figure in the porch. The churchyard wall, 6 ft. thick, is possibly partly Roman. On the south of the harbour is an obelisk in memory of Captain Skinner, of the steam packets, washed overboard in 1833. Pen Caerwybi rises perpendicularly from the sea to the height of 710 ft., at some 2 m. from the town; it is a mass of serpentine rocks, off which lie the North and South Stacks, each with a lighthouse with a revolving light, visible for 20 m., and 197 ft. above high water on the South Stack. On the hill are traces of British fortification, including a circular building, probably a Roman watch-tower. Coasting trade and fishing, with some shipbuilding and the Irish traffic, occupy most of the inhabitants.

See Hon. W. Stanley's *Holy Island and Holyhead*.

HOLY ISLAND, or **LINDISFARNE**, an irregularly shaped island in the North Sea, 2 m. from the coast of Northumberland, in which county it is included. Pop. (1901) 405. It is joined to the mainland at low water by flat sands, over which a track, marked by wooden posts and practicable for vehicles, leads to the island. There is a station on the North-Eastern railway at Beal, 9 m. S.E. of Berwick, opposite the island, but 1½ m. inland. The island measures 3 m. from E. to W. and 1½ N. to S., extreme distances. Its total area is 105½ acres. On the N. it is sandy and barren, but on the S. very fertile and under cultivation. Large numbers of rabbits have their warrens among the sands, and, with fish, oysters and agricultural produce, are exported. There are several fresh springs on the island, and in the north-east is a lake of 6 acres. At the south-west angle is the little fishing village (formerly much larger) which is now a favourite summer watering-place. Here is the harbour, offering good shelter to small vessels. Holy Island derives its name from a monastery founded on it by St Aidan, and restored in 1082 as a cell of the Benedictine monastery at Durham. Its ruins, still extensive and carefully preserved, justify Scott's description of it as a "solemn, huge and dark-red pile." An islet, lying off the S.W. angle, has traces of a chapel upon it, and is believed to have offered a retreat to St Cuthbert and his successors. The castle, situated east of the village, on a basaltic rock about 90 ft. high, dates from c. 1500.

When St Aidan came at the request of King Oswald to preach to the Northumbrians he chose the island of Lindisfarne as the site of his church and monastery, and made it the head of the diocese which he founded in 635. For some years the see continued in peace, numbering among its bishops St Cuthbert, but in 793 the Danes landed on the island and burnt the settlement, killing many of the monks. The survivors, however, rebuilt the church and continued to live there until 883, when, through fear of a second invasion of the Danes, they fled inland, taking with them the body of St Cuthbert and other holy relics. The church and monastery were again destroyed and the bishop and monks, on account of the exposed situation of the island, determined not to return to it, and settled first at Chester-le-Street and finally at Durham. With the fall of the monastery the island appears to have become again untenanted, and probably continued so until the prior and convent of Durham established there a cell of monks from their own house. The inhabitants of Holy Island were governed by two bailiffs at least as early as the 14th century, and, according to J. Raine in his *History of North Durham* (1852), are called "burgesses or freemen" in a private paper dated 1728. In 1323 the bailiffs and community of Holy Island were commanded to cause all ships of the burthen of thirty tons or over to go to Ereswell with their ships provisioned for a month at least and under

double manning to be ready to set out on the king's service. Towards the end of the 16th century the fort on Holy Island was garrisoned for fear of foreign invasion by Sir William Read, who found it very much in need of repair, the guns being so decayed that the gunners "dare not give fire but by trayne," and the master gunner had been "miserably slain" in discharging one of them. During the Civil Wars the castle was held for the king until 1646, when it was taken and garrisoned by the parliamentarians. The only other historical event connected with the island is the attempt made by two Jacobites in 1715 to hold it for the Pretender.

HOLYOAKE, GEORGE JACOB (1817-1906), English secularist and co-operator, was born at Birmingham, on the 13th of April 1817. At an early age he became an Owenite lecturer, and in 1841 was the last person convicted for blasphemy in a public lecture, though this had no theological character and the incriminating words were merely a reply to a question addressed to him from the body of the meeting. He nevertheless underwent six months' imprisonment, and upon his release invented the inoffensive term "secularism" as descriptive of his opinions, and established the *Reasoner* in their support. He was also the last person indicted for publishing an unstamped newspaper, but the prosecution dropped upon the repeal of the tax. His later years were chiefly devoted to the promotion of the co-operative movement among the working classes. He wrote the history of the Rochdale Pioneers (1857), *The History of Co-operation in England* (1875; revised ed., 1906), and *The Co-operative Movement of To-day* (1891). He also published (1892) his autobiography, under the title of *Sixty Years of an Agitator's Life*, and in 1905 two volumes of reminiscences, *Bygones worth Remembering*. He died at Brighton on the 22nd of January 1906.

See J. McCabe, *Life and Letters of G. J. Holyoake* (2 vols., 1908); C. W. F. Goss, *Descriptive Bibliography of the Writings of G. J. Holyoake* (1908).

HOLYOKE, a city of Hampden county, Massachusetts, U.S.A., in a bend of the Connecticut river, about 8 m. N. of Springfield. Pop. (1880) 21,915; (1890) 35,637; (1900) 45,712; (1910 census) 57,730. Of the total population in 1900, 18,921 were foreign-born, including 6991 French-Canadians, 5650 Irish, 1602 Germans and 1118 English; and 33,626 were of foreign parentage (both parents foreign-born), including 12,370 of Irish and 11,050 of French-Canadian parentage. The city's area is about 17 sq. m. The city is served by the Boston & Maine, and the New York, New Haven & Hartford railways, and by an interurban line. Holyoke is characteristically an industrial and mercantile city; it has some handsome public buildings (the city hall and the public library, founded in 1870, being especially noteworthy) and attractive environs. Holyoke is the railway station for Mt Holyoke College, in South Hadley, about 4 m. N. by E. of Holyoke; the city is connected with South Hadley by an electric line. Just above Holyoke the Connecticut leaves the rugged highlands through a rift between Mt Tom (1214 ft.; ascended by a mountain-railway from Holyoke) and Mt Holyoke (954 ft.), and begins a meandering valley course, falling (in the Hadley Falls) in great volume some 60 ft. in about 1½ m. The water-power was unutilized until 1849, when a great dam (1017 ft. long) was completed, which enabled vast power to be developed along a series of canals laid out from the river. This was, in its day, a colossal undertaking; and its success transformed Holyoke from a farming village into a great manufacturing centre—in 1900 and 1905 the ninth largest of the commonwealth. In 1900 a stone dam (1020 ft.), said to be the second largest in New England, was completed at a cost of about \$750,000. Cotton manufactures first, and later paper products were chief in importance, and Holyoke now leads all the cities in the United States in the manufacture of fine paper. In 1905 the total value of all factory products was \$30,731,332, of which \$10,680,255 (or 34.6% of the total) represented paper and wood pulp; \$5,019,817, cotton goods; \$1,318,409, woollen goods; \$1,756,473, book binding and blank books, and \$2,222,759, foundry and machine-shop

products. Silk and worsted goods are other important manufactures. Opposite Holyoke, in Hampshire county, is South Hadley Falls. The municipality owns and operates the gas and electric-lighting plants and the water works (the water-supply being derived from natural ponds, some of which are outside the city limits), and owns and leases (to the New York, New Haven & Hartford railroad) a railway extending (10-3 m.) to Westfield, Mass. Holyoke was originally a part of Springfield, and after 1774 of West Springfield. In 1850 it was incorporated as a township, and in 1873 was chartered as a city.

HOLYSTONE, a soft kind of sandstone used by sailors for scrubbing and cleaning the decks of ships. The origin of the word is doubtful. Some authorities hold that it arose from the general practice of scrubbing the decks for Sunday service; while others think the name arises from the fact that the stone so employed is naturally porous and full of holes. A small flint or stone having a natural hole in it, and worn as a charm, is also called a holystone.

HOLY WATER, technically the water with which Christian believers sign the cross on their foreheads on entering or leaving church. The edict of Gratian lays down that it should be exorcized and blessed by the priest and sprinkled with exorcized salt. This rite is found in the Gelasian, Gregorian and other sacramentaries. In the East the water was blessed once a month, in the Latin Church it is now blessed every Sunday. In the 4th century in the East it was usual to wash the hands on entering the church (see **ABLUTION**).

In the early church water was not expressly consecrated for baptisms and other lustrations. "Water," says Tertullian in his tract on baptism, "was the abode at the first of the divine Spirit, being more acceptable then (to God) than the other elements." He pictures the world in the beginning: "total darkness, formless as yet, without tending of stars, the melancholy abyss, the earth unprepared, the heaven undeveloped. The liquid alone an ever perfect material, smiling, simple, pure in its own right, as a worthy vehicle underlay the God." Water was similarly pure in itself in the old Persian religion.

The *Canons of Hippolytus*, or Egyptian church order, of about A.D. 250, give no prayer for consecration of founts, but enact that "at cock crow the baptismal party shall take their stand near waving water, pure, prepared, sacred, of the sea." The *Teaching of the Apostles*, c. 100, merely insists on "living," that is, clear and running water. The ancient feeling, especially Jewish, was that in lustrations the same water must not pass twice over the body. A stagnant pool was useless. Bubbling waters too seemed to have a spirit in them.

Either because running water was not always at hand, or as part of the growing tendency of the church to multiply ceremonies, rituals arose late in the 3rd century for consecrating water. The sacramentary of Serapion, c. 350, provides a prayer asking that the divine Word may descend into the water and hallow it, as of old it hallowed the Jordan. In the Roman order of baptism the priest prays that "the fount may receive the grace of the only begotten Son from the holy Spirit, and that the latter may impregnate with hidden admixture of His light this water prepared for the regeneration of mankind, to the end that man through a sanctification conceived from the immaculate womb of the divine fount, may emerge a heavenly offspring reborn as a new creature." The water is then exorcized and evil spirits warned off, and lastly blessed. During the prayer the priest twice signs the water with the cross, and once blows upon it.

The first mention of a special consecration of water for other ends than baptism is in the *Acts of Thomas* (? A.D. 200); it is for the purgation of a youth already baptized who had killed his mistress because she would not live chastely with him. The apostle prays: "Fountain sent unto us from Rest, Power of Salvation from that Power proceeding which overcomes and subjects all to its own will, come and dwell within these waters, that the *Charisma* (gift) of the holy Spirit may be fully perfected through them." The youth then washes his hands, which on touching the sacrament had withered up, and is healed.

The church shared the universal belief that holiness or the holy

Spirit is quasi-material and capable of being held in suspense in water, just as sin is a half material infection, absorbed and carried away by it. So Tertullian writes: "The water which carried the Spirit of God (probably regarded as a shadow or reflection-soul) borrowed holiness from that which was carried upon it; for every underlying matter must needs absorb and take up the quality of that matter which overhangs it; especially does a corporeal so absorb a spiritual, as this can easily penetrate and settle into it owing to the subtlety of its substance."

"Water," he continues, "was generically hallowed by the Spirit of God brooding over it at creation, and therefore all special waters are holy, and at once obtain the sacrament of sanctification when God is invoked (over them.) For the Spirit from heaven instantly supervenes and is upon the waters, hallowing them out of itself, and being so hallowed they drink up a power of hallowing."

What is done in material semblance, he then argues, is repeated in the unseen medium of the Spirit. The stains of idolatry, vice and fraud are not visible on the flesh, yet they resemble real dirt. "The waters are medicated in a manner through the intervention of the angel, and the Spirit is corporeally washed in the water and the flesh is spiritually purified in the same."

Tertullian believed that an angel was sent down, when God was invoked, like that which stirred the pool of Bethesda. As regards rival Isiac and Mithraic baptisms, he asserts that their waters are destitute of divine power; nay, are rather tenanted by the devil who in this matter sets himself to rival God. "Without any religious rite at all," he urges, "unclean spirits brood upon waters, aspiring to repeat that primordial gestation of the divine Spirit." And he instances the "darkling springs and lonely rivers which are said to snatch, to wit by force of a harmful spirit." In the sequel he defines the rôle of the angel of baptism who does not infuse himself in waters, already holy from the first; but merely presides over the washing of the faithful, and ensures their being made pure for the reception of the holy Spirit in the rite of confirmation which immediately follows. "The devil who till now ruled over us, we leave behind overwhelmed in the water."

From all this we conclude that what is poetry to us—akin to the folk-lore of water-sprites, naiads, helpies, river-gods and water-worship in general—was to Tertullian and to the generations of believers who fashioned the baptismal rites, ablutions and beliefs of the church, nothing less than grim reality and unquestionable fact.

See John, marquess of Bute, and E. A. Wallis Budge, *The Blessing of the Waters* (London, 1901); E. B. Tylor, *Primitive Culture* (London, 1903).

HOLY WEEK (*ἑβδομαὶ μεγάλα, ἄγια* or *τῶν ἁγίων, ἡεροφαγίας, ἔσρατος*, also *ἡμέραι παθμάτων, ἡμέραι σταυρώσεως*; *hebdomas* [or *septimana*] *major, sancta, authentica* [i.e. *canonizata*, du Cange], *ultima, poenosa, lacrimosa, nigra, inofficiosa, muta, crucis, lamentationum, indulgentiae*), in the Christian ecclesiastical year the week immediately preceding Easter. The earliest allusion to the custom of marking this week as a whole with special observances is to be found in the *Apostolical Constitutions* (v. 18, 19), dating from the latter half of the 3rd century A.D. Abstinence from wine and flesh is there commanded for all the days, while for the Friday and Saturday an absolute fast is enjoined. Dionysius Alexandrinus also, in his canonical epistle (260 A.D.), refers to the six fasting days (*ἕξ τῶν ἡμερῶν ἡμέραι*) in a manner which implies that the observance of them had already become an established usage in his time. There is some doubt about the genuineness of an ordinance attributed to Constantine, in which abstinence from public business was enforced for the seven days immediately preceding Easter Sunday, and also for the seven which followed it; the *Codex Theodosianus*, however, is explicit in ordering that all actions at law should cease, and the doors of all courts of law be closed during those fifteen days (l. ii. tit. viii.). Of the particular days of the "great week" the earliest to emerge into special prominence was naturally Good Friday. Next came the *Sabbatum Magnum* (Holy Saturday or Easter Eve) with its vigil, which

in the early church was associated with an expectation that the second advent would occur on an Easter Sunday.

For details of the ceremonial observed in the Roman Catholic Church during this week, reference must be made to the *Missal* and *Breviary*. In the Eastern Church the week is marked by similar practices, but with less elaboration and differentiation of rite. See also EASTER, GOOD FRIDAY, MAUNDY THURSDAY, PALM SUNDAY and PASSION WEEK.

HOLYWELL (*Treflynon*, well-town), a market town and contributory parliamentary borough of Flintshire, N. Wales, situated on a height near the left bank of the Dee estuary, 196 m. from London by the London & North-Western railway (the station being 2 m. distant). Pop. of urban district (1901) 2652. The parish church (1769) has some columns of an earlier building, interesting brasses and strong embattled tower. The remains of Basingwerk Abbey (*Maes glas*, green field), partly Saxon and partly Early English, are near the station. It is of uncertain origin but was used as a monastery before 1119. In 1131 Ranulph, 2nd earl of Chester, introduced the Cistercians. In 1535, when its revenues were £150, 7s. 3d., it was dissolved, but revived under Mary I. and used as a Roman Catholic burial place in 1647. Scarcely any traces remain of Basingwerk castle, an old fort. Small up to the beginning of the 19th century, Holywell has increasingly prospered, thanks to lime quarries, lead, copper and zinc mines, smelting works, a shot manufactory, copper, brass, iron and zinc works; brewing, tanning and mineral water, flannel and cement works. St Winifred's holy well, one of the wonders of Wales, sends up water at the rate of 21 tons a minute, of an almost unvarying temperature, higher than that of ordinary spring water. To its curative powers many crutches and *ex voto* objects, hung round the well, as in the Lourdes Grot, bear ample witness. The stones at the bottom are slightly reddish, owing to vegetable substances. The well itself is covered by a fine Gothic building, said to have been erected by Margaret, countess of Richmond and mother of Henry VII., with some portions of earlier date. The chapel (restored) is used for public service. Catholics and others visit it in great numbers. There are swimming baths for general use. In 1870 a hospice for poorer pilgrims was erected. Other public buildings are St Winifred's (Catholic) church and a convent, a town hall and a market-hall. The export trade is expedited by quays on the Dee.

HOLYWOOD, a seaport of county Down, Ireland, on the east shore of Belfast Lough, 43 m. N.E. from Belfast by the Belfast & County Down railway. Its pleasant situation renders it a favourite residential locality of the wealthier classes in Belfast. There was a religious settlement here from the 7th century, which subsequently became a Franciscan monastery. The old church dating from the late 12th or early 13th century marks its site. A Solemn League and Covenant was signed here in 1644 for the defence of the kingdom, and the document is preserved at Belfast.

HOLZMINDEN, a town of Germany, in the duchy of Brunswick, on the right bank of the Weser, at the foot of the Sollinger Mountains, at the junction of the railways Scherfede-Holz-minden and Soest-Bürsum, 56 m. S.W. of Brunswick. Pop. (1905) 9938. It has an Evangelical and a Roman Catholic church, a gymnasium, an architectural school and a school of engineering. The prosperity of the town depends chiefly on agriculture and the manufacture of iron and steel wares, and of chemicals, but weaving and the making of pottery are also carried on, and there are baryta mills and polishing-mills for sandstone. By means of the Weser it carries on a lively trade. Holzminden obtained municipal rights from Count Otto of Eberstein in 1245, and in 1410 it came into the possession of Brunswick.

HOLZTROMPETE (Wooden Trumpet), an instrument somewhat resembling the Alpenhorn (*q.v.*) in tone-quality, designed by Richard Wagner for representing the natural pipe of the peasant in *Tristan and Isolde*. This instrument is not unlike the cor anglais in rough outline, being a conical tube of approximately the same length, terminating in a small globular bell, but having neither holes nor keys; it is blown through a cup-shaped mouthpiece made of horn. The Holztrompete is in

the key of C; the scale is produced by overblowing, whereby the upper partials from the 2nd to the 6th are produced. A single piston placed at a third of the distance from the mouth-piece to the bell gives the notes D and F. Wagner inserted a note in the score concerning the cor anglais for which the part was originally scored, and advised

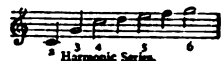

the use of oboe or clarinet to reinforce the latter, the effect intended being that of a powerful natural instrument, unless a wooden instrument with a natural scale be specially made for the part, which would be preferable. The Holztrompete was used at Munich for the first performance of *Tristan and Isolde*, and was still in use there in 1897. At Bayreuth it was also used for the *Tristan* performances at the festivals of 1886 and 1889, but in 1891 W. Heckel's clarina, an instrument partaking of the nature of both oboe and clarinet, was substituted for the Holztrompete and has been retained ever since, having been found more effective.¹ (K. S.)

HOMAGE (from *homo*, through the Low Lat. *hominaticum*, which occurs in a document of 1035), one of the ceremonies used in the granting of a fief, and indicating the submission of a vassal to his lord. It could be received only by the suzerain in person. With head uncovered the vassal humbly requested to be allowed to enter into the feudal relation; he then laid aside his sword and spurs, ungirt his belt, and kneeling before his lord, and holding his hands extended and joined between the hands of his lord, uttered words to this effect: "I become your man from this day forth, of life and limb, and will hold faith to you for the lands I claim to hold of you." The oath of fealty, which could be received by proxy, followed the act of homage; then came the ceremony of investiture, either directly on the ground or by the delivery of a turf, a handful of earth, a stone, or some other symbolical object. Homage was done not only by the vassal to whom feudal lands were first granted but by every one in turn by whom they were inherited, since they were not granted absolutely but only on condition of military and other service. An infant might do homage, but he did not thus enter into full possession of his lands. The ceremony was of a preliminary nature, securing that the fief would not be alienated; but the vassal had to take the oath of fealty, and to be formally invested, when he reached his majority. The obligations involved in the act of homage were more general than those associated with the oath of fealty, but they provided a strong moral sanction for more specific engagements. They essentially resembled the obligations undertaken towards a Teutonic chief by the members of his "comitatus" or "gefolge," one of the institutions from which feudalism directly sprang. Besides *homagium ligensum*, there was a kind of homage which imposed no feudal duty; this was *homagium per paragium*, such as the dukes of Normandy rendered to the kings of France, and as the dukes of Normandy received from the dukes of Brittany. The act of liege homage to a particular lord did not interfere with the vassal's allegiance as a subject to his sovereign, or with his duty to any other suzerain of whom he might hold lands.

The word is also used of the body of tenants attending a manorial court, or of the court in a court baron (consisting of the tenants that do homage and make inquiries and presentments, termed a *homage jury*).

HOMBERG, WILHELM (1652-1715), Dutch natural philosopher, was the son of an officer of the Dutch East India Company, and was born at Batavia (Java) on the 8th of January 1652. Coming to Europe with his family in 1670, he studied law at Jena and Leipzig, and in 1674 became an advocate at Magdeburg. In that town he made the acquaintance of Otto von Guericke, and under his influence determined to devote himself to natural science. He, therefore, travelled in various parts of Europe for study, and after graduating in medicine at Wittenberg, settled in Paris in 1682. From 1685 to 1690 he practised as a physician at Rome; then returning to Paris in 1691, he was elected a member of the Academy of Sciences and appointed director of

¹ Communicated by Madame Wagner, December 29th, 1897.

his chemical laboratory. Subsequently he became teacher of physics and chemistry (1702), and private physician (1705) to the duke of Orleans. His death occurred at Paris on the 14th of September 1715. Homberg was not free from alchemical tendencies, but he made many solid contributions to chemical and physical knowledge, recording observations on the preparation of Kunkel's phosphorus, on the green colour produced in flames by copper, on the crystallization of common salt, on the salts of plants, on the saturation of bases by acids, on the freezing of water and its evaporation *in vacuo*, &c. Much of his work was published in the *Recueil de l'Académie des Sciences* from 1692 to 1714. The *Sal Sedativum Hombergi* is boracic acid, which he discovered in 1702, and "Homberg's phosphorus" is prepared by fusing sal-ammoniac with quick lime.

HOMBURG-VOR-DER-HÖHE, a town and watering-place of Germany, in the Prussian province of Hesse-Nassau, prelatly situated at the south-east foot of the Taunus Mountains, 12 m. N. of Frankfort-on-Main, with which it is connected by rail. Pop. (1905) 13,740. Homburg consists of an old and a new town, the latter, founded by the landgrave of Hesse-Homburg Frederick II. (d. 1708), being regular and well-built. Besides the palatial edifices erected in connexion with the mineral water-cure, there are churches of various denominations, Lutheran, Roman Catholic, Russian-Greek and Anglican, schools and benevolent institutions. On a neighbouring hill stands the palace of the former landgraves, built in 1680 and subsequently enlarged and improved. The White Tower, 183 ft. in height, is said to date from Roman times, and certainly existed under the lords of Eppstein, who held the district in the 12th century. The palace is surrounded by extensive grounds, laid out in the manner of an English park. The eight mineral springs which form the attraction of the town to strangers belong to the class of saline acidulous chalybeates and contain a considerable proportion of carbonate of lime. Their use is beneficial for diseases of the stomach and intestines, and, externally, for diseases of the skin and rheumatism. The establishments connected with the springs are arranged on a scale of great magnificence, and include the Kurhaus (built 1841-1843), with a theatre, the Kaiser Wilhelmsbad and the Kurhausbad. They lie grouped round a pretty park which also furnishes the visitors with facilities for various recreations, such as lawn tennis, croquet, polo and other games. The industries of Homburg embrace iron founding and the manufacture of leather and hats, but they are comparatively unimportant, the prosperity of the town being almost entirely due to the annual influx of visitors, which during the season from May to October inclusive averages 12,000. In the beautiful neighbourhood lies the ancient Roman castle of Saalburg, which can be reached by an electric tramway.

Homburg first came into repute as a watering-place in 1834, and owing to its gaming-tables, which were set up soon after, it rapidly became one of the favourite and most fashionable health-resorts of Europe. In 1849 the town was occupied by Austrian troops for the purpose of enforcing the imperial decree against gambling establishments, but immediately on their withdrawal the bank was again opened, and play continued unhecked until 1872, when the Prussian government refused to renew the lease for gambling purposes, which then expired. As the capital of the former landgraviate of Hesse-Homburg, the town shared the vicissitudes of that state.

Homburg is also the name of a town in Bavaria. Pop. (1900) 4785. It has a Roman Catholic and an Evangelical church, and manufactures of iron goods. In the neighbourhood are the ruins of the castles of Karlsberg and of Hohenburg. The family of the counts of Homburg became extinct in the 15th century. The town came into the possession of Zweibrücken in 1755 and later into that of Bavaria.

See Supp. *Bad Homburg* (7th ed., Homburg, 1903); Baumstark, *Bad Homburg und seine Heilquellen* (Wiesbaden, 1901); Schiek, *Homburg und Umgebung* (Homburg, 1896); Will, *Der Kurort Homburg, seine Mineralquellen* (Homburg, 1886); Hoeben, *Bad Homburg und sein Heilapparat* (Homburg, 1901); and N. E. Yorke-Davies, *Homburg and its Waters* (London, 1897).

HOME, EARLS OF. Alexander Home or Hume, 1st earl of Home (c. 1566-1619), was the son of Alexander, 5th Lord Home (d. 1575), who fought against Mary, queen of Scots, at Carberry Hill and at Langside, but was afterwards one of her most stalwart supporters, being taken prisoner when defending Edinburgh castle in her interests in 1573 and probably dying in captivity. He belonged to an old and famous border family, an early member of which, Sir Alexander Home, was killed at the battle of Verneuil in 1424. This Sir Alexander was the father of Sir Alexander Home (d. 1456), warden of the marches and the founder of the family fortunes, whose son, another Sir Alexander (d. 1491), was created a lord of parliament as Lord Home in 1473, being one of the band of nobles who defeated the forces of King James III. at the battle of Sauchieburn in 1488. Other distinguished members of the family were: the first lord's grandson and successor, Alexander, 2nd Lord Home (d. 1506), chamberlain of Scotland; and the latter's son, Alexander, 3rd Lord Home (d. 1516), a person of great importance during the reign of James IV., whom he served as chamberlain. He fought at Flodden, but before the death of the king he had led his men away to plunder. During the minority of the new king, James V., he was engaged in quarrelling with the regent, John Stewart, duke of Albany, and in intriguing with England. In September 1516 he was seized, was charged with treachery and beheaded, his title and estates being restored to his brother George in 1522. George, who was killed in September 1547 during a skirmish just before the battle of Pinkie, was the father of Alexander, the 5th lord.

Alexander Home became 6th Lord Home on his father's death in August 1575, and took part in many of the turbulent incidents which marked the reign of James VI. He was warden of the east marches, and was often at variance with the Hepburns, a rival border family whose head was the earl of Bothwell; the feud between the Homes and the Hepburns was an old one, and it was probably the main reason why Home's father, the 5th lord, sided with the enemies of Mary during the period of her intimacy with Bothwell. Home accompanied James to England in 1603 and was created earl of Home in 1605; he died in April 1619.

His son James, the 2nd earl, died childless in 1633 when his titles passed to a distant kinsman, Sir James Home of Coldingknows (d. 1666), a descendant of the 1st Lord Home. This earl was in the Scottish ranks at the battle of Preston and lost his estates under the Commonwealth, but these were restored to him in 1661. His descendant, William, the 8th earl (d. 1761) fought on the English side at Prestonpans, and from his brother Alexander, the 9th earl (d. 1786), the present earl of Home is descended. In 1875 Cospatrik Alexander, the 11th earl (1799-1881), was created a peer of the United Kingdom as Baron Douglas, and his son Charles Alexander, the 12th earl (b. 1834), took the additional name of Douglas. The principal strongholds of the Homes were Douglas castle in Haddington and Home castle in Berwickshire.

See H. Drummond, *Histories of Noble British Families* (1846).

HOME, DANIEL DUNGLAS (1833-1886), Scottish spiritualist, was born near Edinburgh on the 20th of March 1833, his father being said to be a natural son of the 10th earl of Home, and his mother a member of a family credited with second sight. He went with his mother to America, and on her death was adopted by an aunt. In the United States he came out as a spiritualistic medium, though, it should be noted, he never sought to make money out of his exhibitions. In 1855 he came to England and gave numerous sances, which were attended by many well-known people. Robert Browning, the poet, went to one of these, but without altering his contempt for spiritualism, and he subsequently gave his impression of Home in the unflattering poem of "Sludge the Medium" (1864); Home, nevertheless, had many disciples, and gave sances at several European courts. He became a Roman Catholic, but was expelled from Rome as a sorcerer. In 1866 Mrs Lyon, a wealthy widow, adopted him as her son, and settled £60,000 upon him. Repenting, however, of her action, she brought a suit for the return of her money,

on the ground that it had been obtained by "spiritual" influence. It was held that the burden of establishing the validity of the gift lay on Home, and as he failed to do so the case was decided against him. He continued, however, to give sances, mostly on the Continent, and in 1871 appeared before the tsar of Russia and two Russian scientists, who attested the phenomena evoked. Returning to England he submitted to a series of experiments designed to test his pretensions before Professor (subsequently Sir William) Crookes, which the latter declared to be thoroughly genuine; and Professor von Boutlerow, of the Russian Academy of Science, after witnessing a similar series of experiments, expressed the same opinion. Home published two volumes of *Incidents of my Life* and *Lights and Shadows of Spiritualism*. He married successively two well-connected Russian ladies. He died at Auteuil, France, on the 21st of June 1886.

HOME, JOHN (1722-1808), Scottish dramatic poet, was born on the 22nd of September 1722 at Leith, where his father, Alexander Home, who was distantly related to the earls of Home, filled the office of town-clerk. He was educated at the grammar school of his native town, and at the university of Edinburgh, where he graduated M.A. in 1742. Though he showed a fondness for the profession of arms, he studied divinity, and was licensed by the presbytery of Edinburgh in 1745. In the same year he joined as a volunteer against the Pretender, and was taken prisoner at the battle of Falkirk (1746). With many others he was carried to the castle of Doune in Perthshire, but soon effected his escape. In July 1746 Home was presented to the parish of Athelstaneford, Haddingtonshire, vacant by the death of Robert Blair, the author of *The Grave*. He had leisure to visit his friends and became especially intimate with David Hume who belonged to the same family as himself. His first play, *Agis*, a tragedy, founded on Plutarch's narrative, was finished in 1747. He took it to London and submitted it to Garrick for representation at Drury Lane, but it was rejected as unsuitable for the stage. The tragedy of *Douglas* was suggested to him by hearing a lady sing the ballad of *Gil Morrice* or *Child Maurice* (F. J. Child, *Popular Ballads*, ii. 263). The ballad supplied him with the outline of a simple and striking plot. After five years' labour he completed his play, which he took to London for Garrick's opinion. It also was rejected, but on his return to Edinburgh his friends resolved that it should be brought out in that city. It was produced on the 14th of December 1756 with overwhelming success, in spite of the opposition of the presbytery, who summoned Alexander Carlyle to answer for having attended its representation. Home wisely resigned his charge in 1757, after a visit to London, where *Douglas* was brought out at Covent Garden on the 14th of March. Peg Woffington played Lady Randolph, a part which found a later exponent in Mrs Siddons. David Hume summed up his admiration for *Douglas* by saying that his friend possessed "the true theatric genius of Shakespeare and Otway, refined from the unhappy barbarism of the one and licentiousness of the other." Gray, writing to Horace Walpole (August, 1757), said that the author "seemed to have retrieved the true language of the stage, which has been lost for these hundred years," but Samuel Johnson held aloof from the general enthusiasm, and averred that there were not ten good lines in the whole play (Boswell, *Life*, ed. Croker, 1848, p. 390). In 1758 Home became private secretary to Lord Bute, then secretary of state, and was appointed tutor to the prince of Wales; and in 1760 his patron's influence procured him a pension of £300 per annum and in 1763 a sinecure worth another £300. Garrick produced *Agis* at Drury Lane on the 21st of February 1758. By dint of good acting and powerful support, according to Genest (*Short Account* &c., iv. 513 seq.), the piece kept the stage for eleven days, but it was lamentably inferior to *Douglas*. In 1760 his tragedy, *The Siege of Aquileia*, was put on the stage, Garrick taking the part of Aemilius. In 1760 his tragedy of *The Fatal Discovery* had a run of nine nights; *Alonzo* also (1773) had fair success in the representation; but his last tragedy, *Alfred* (1778), was so coolly received that he gave up writing for the stage. In 1778 he joined a regiment formed by the duke of Buccleuch.

He sustained severe injuries in a fall from horseback which permanently affected his brain, and was persuaded by his friends to retire. From 1767 he resided either at Edinburgh or at a villa which he built at Kilduff near his former parish. It was at this time that he wrote his *History of the Rebellion of 1745*, which appeared in 1802. Home died at Merchiston Bank, near Edinburgh, on the 5th of September 1808, in his eighty-sixth year.

The *Works of John Home* were collected and published by Henry Mackenzie in 1822 with "An Account of the Life and Writings of Mr John Home," which also appeared separately in the same year, but several of his smaller poems seem to have escaped the editor's observation. These are—"The Fate of Caesar," "Verses upon Inveraray," "Epistle to the Earl of Eglintoun," "Prologue on the Birthday of the Prince of Wales, 1759" and several "Epigrams," which are printed in vol. ii. of *Original Poems by Scottish Gentlemen* (1762). See also Sir W. Scott, "The Life and Works of John Home" in the *Quarterly Review* (June, 1827). *Douglas* is included in numerous collections of British drama. Voltaire published his *Le Caffé, ou l'Ecossoise* (1760), *Londres* (really Geneva), as a translation from the work of Mr Hume, described as *pasteur de l'église d'Edimbourg*, but Home seems to have taken no notice of the mystification.

HOMEL, or **GOMEL**, a town of Russia, in the government of Mogilev, and 132 m. by rail S.S.E. of the town of Mogilev, on the Sozh, a tributary of the Dnieper. Pop. (1900) 45,081, nearly half of whom are Jews. It is an important junction of the railways from Vilna to Odessa and from Orel to Poland, and is in steamer communication with Kiev and Mogilev. In front of Prince Paskevich's castle stands an equestrian statue of the Polish general Joseph Poniatowski, and in the cathedral is the tomb of the chancellor Nikolai Petrovich Rumantsev, by Canova. The town carries on a brisk trade in hops, corn and timber; there are also paper-pulp mills and oil factories. Homel was founded in the 12th century, and after changing hands several times between Poles and Russians was annexed to Russia in 1772. In 1648 it suffered at the hands of the Cossack chieftain Bogdan Chmielnicki.

HOME OFFICE, a principal government department in the United Kingdom, the creation of which dates from 1782, when the conduct of foreign affairs, which had previously been divided between the northern and southern secretaries, was handed over to the northern department (see **FOREIGN OFFICE**). The home department retained control of Irish and colonial affairs, and of war business until 1794, when an additional secretary of state was re-appointed. In 1801 the colonial business was transferred from the home department, which now attends only to domestic affairs. The head of the department, the principal secretary of state for home affairs, or home secretary, is a member of the government for the time being, and of the cabinet, receiving a salary of £5000 a year. He is the proper medium of communication between the sovereign and the subject, and receives petitions addressed to the crown. He is responsible for the maintenance of the king's peace and attends to the administration of criminal justice, police and prisons, and through him the sovereign exercises his prerogative of mercy. Within his department is the supervision of lunatic asylums, reformatories and industrial schools, and it is his duty to see after the internal well-being of the country, to enforce the rules made for the health or safety of the community generally, and especially of those classes employed in special trades or dangerous occupations. He is assisted by a permanent under-secretary, a parliamentary secretary and several assistant under-secretaries.

See Anson, *Law and Custom of the Constitution* (1907).

HOMER (*Ὅμηρος*), the great epic poet of Greece. Many of the works once attributed to him are lost; those which remain are the two great epics, the *Iliad* and the *Odyssey*, thirty-three *Hymns*, a mock epic (the *Battle of the Frogs and Mice*), and some pieces of a few lines each (the so-called *Epigrams*).

Ancient Accounts of Homer.—Of the date of Homer probably no record, real or pretended, ever existed. Herodotus (ii. 53) maintains that Hesiod and Homer lived not more than 400 years

¹ This article was thoroughly revised by Dr D. B. Monro before his death in 1905; a few points have since been added by Mr. T. W. Allen.

before his own time, consequently not much before 850 B.C. From the controversial tone in which he expresses himself it is evident that others had made Homer more ancient; and accordingly the dates given by later authorities, though very various, generally fall within the 10th and 11th centuries B.C. But none of these statements has any claim to the character of external evidence.

The extant lives of Homer (edited in Westermann's *Vitarum Scriptores Graeci minores*) are eight in number, including the piece called the *Contest of Hesiod and Homer*. The longest is written in the Ionic dialect, and bears the name of Herodotus, but is certainly spurious. In all probability it belongs to the time which was fruitful beyond all others in literary forgeries, viz. the 2nd century of our era.¹ The other lives are certainly not more ancient. Their chief value consists in the curious short poems or fragments of verse which they have preserved—the so-called *Epigrams*, which used to be printed at the end of editions of Homer. These are easily recognized as "Popular Rhymes," a form of folk-lore to be met with in most countries, treasured by the people as a kind of proverbs.² In the Homeric *epigrams* the interest turns sometimes on the characteristics of particular localities—Smyrna and Cyme (*Epigr.* iv.), Erythrae (*Epigr.* vi., vii.), Mt. Ida (*Epigr.* x.), Neon Teichos (*Epigr.* i.); others relate to certain trades or occupations—potters (*Epigr.* xiv.), sailors, fishermen, goat herds, &c. Some may be fragments of longer poems, but evidently they are not the work of any one poet. The fact that they were all ascribed to Homer merely means that they belong to a period in the history of the Ionian and Aeolian colonies when "Homer" was a name which drew to itself all ancient and popular verse.

Again, comparing the "epigrams" with the legends and anecdotes told in the Lives of Homer, we can hardly doubt that they were the chief source from which these Lives were derived. Thus in *Epigr.* iv. we find a blind poet, a native of Aeolian Smyrna, through which flows the water of the sacred Meles. Here is doubtless the source of the chief incident of the Herodotean life—the birth of Homer "Son of the Meles." The epithet Aeolian implies high antiquity, inasmuch as according to Herodotus Smyrna became Ionian about 688 B.C. Naturally the Ionians had their own version of the story—a version which made Homer come out with the first Athenian colonists.

The same line of argument may be extended to the *Hymns*, and even to some of the lost works of the post-Homeric or so-called "Cyclic" poets. Thus:—

1. The hymn to the Delian Apollo ends with an address of the poet to his audience. When any stranger comes and asks who is the sweetest singer, they are to answer with one voice, the "blind man that dwells in rocky Chios; his songs deserve the prize for all time to come." Thucydides, who quotes this passage to show the ancient character of the Delian festival, seems to have no doubt of the Homeric authorship of the hymn. Hence we may most naturally account for the belief that Homer was a Chian.

2. The *Margites*—a humorous poem which kept its ground as the reputed work of Homer down to the time of Aristotle—began with the words, "There came to Colophon an old man, a divine singer, servant of the Muses and Apollo." Hence doubtless the claim of Colophon to be the native city of Homer—a claim supported in the early times of Homeric learning by the Colophonian poet and grammarian Antimachus.

3. The poem called the *Cypris* was said to have been given by Homer to Stasinus of Cyprus as a daughter's dowry. The connexion with Cyprus appears further in the predominance given in the poem to Aphrodite.

4. The *Little Iliad* and the *Phocais*, according to the Herodotean life, were composed by Homer when he lived at Phocaea, with a certain Thestorides, who carried them off to Chios and there gained fame by reciting them as his own. The name Thestorides occurs in *Epigr.* v.

¹ See a paper in the *Diss. Philol. Halenses*, ii. 97-219.

² Compare the *Popular Rhymes of Scotland*, published by Robert Chambers.

5. A similar story was told about the poem called the *Taking of Oechalia* (Ὀχάλιας Ἰλίου), the subject of which was "one of the exploits of Heracles. It passed under the name of Creophylus, a friend or (as some said) a son-in-law of Homer; but it was generally believed to have been in fact the work of the poet himself.

6. Finally the *Thebaid* always counted as the work of Homer. As to the *Epigoni*, which carried on the Theban story, some doubt seems to have been felt.

These indications render it probable that the stories connecting Homer with different cities and islands grew up after his poems had become known and famous, especially in the new and flourishing colonies of Aeolis and Ionia. The contention for Homer, in short, began at a time when his real history was lost, and he had become a sort of mythical figure, an "eponymous hero," or personification of a great school of poetry.

An interesting confirmation of this view from the negative side is furnished by the city which ranked as chief among the Asiatic colonies of Greece, viz. Miletus. No legend claims for Miletus even a visit from Homer, or a share in the authorship of any Homeric poem. Yet Arctinus of Miletus was said to have been a "disciple of Homer," and was certainly one of the earliest and most considerable of the "Cyclic" poets. His *Aethiopsis* was composed as a sequel to the *Iliad*; and the structure and general character of his poems show that he took the *Iliad* as his model. Yet in his case we find no trace of the disputed authorship which is so common with other "Cyclic" poems. How has this come about? Why have the works of Arctinus escaped the attraction which drew to the name of Homer such epics as the *Cypris*, the *Little Iliad*, the *Thebaid*, the *Epigoni*, the *Taking of Oechalia* and the *Phocais*. The most obvious account of the matter is that Arctinus was never so far forgotten that his poems became the subject of dispute. We seem through him to obtain a glimpse of an early post-Homeric age in Ionia, when the immediate disciples and successors of Homer were distinct figures in a trustworthy tradition—when they had not yet merged their individuality in the legendary "Homer" of the Epic Cycle.

Recitation of the Poems.—The recitation of epic poetry was called in historical times "rhapsody" (ῥαψῳδία). The word ῥαψῳδία is post-Homeric, but was known to Pindar, who gives two different explanations of it—"singer of stiched verse" (ῥαψῳδῶν ἐπιείκων ἀοιδῶν), and "singer with the wand" (ῥαβδός). Of these the first is etymologically correct (except that it should rather be "stitcher of verse"); the second was suggested by the fact, for which there is early evidence, that the reciter was accustomed to hold a wand in his hand—perhaps, like the sceptre in the Homeric assembly, as a symbol of the right to a hearing.³

The first notice of rhapsody meets us at Sicily, in the reign of Cleisthenes (600-560 B.C.), who "put down the rhapsodists on account of the poems of Homer, because they are all about Argos and the Argives" (*Hdt.* v. 67). This description applies very well to the *Iliad*, in which Argos and Argives occur on almost every page. It may have suited the *Thebaid* still better, but there is no need to understand it only of that poem, as Grote does. The incident shows that the poems of the Ionic Homer had gained in the 6th century B.C., and in the Doric parts of the Peloponnese, the ascendancy, the national importance and the almost canonical character which they ever afterwards retained.

At Athens there was a law that the Homeric poems should be recited (ῥαψῳδεῖσθαι) on every occasion of the Panathenaea. This law is appealed to as an especial glory of Athens by the orator Lycurgus (*Leocr.* 102). Perhaps therefore the custom of public recitation was exceptional,⁴ and unfortunately we do not know when or by whom it was introduced. The Platonic dialogue *Hipparchus* attributes it to Hipparchus, son of Peisistratus. This, however, is part of the historical romance of

³ Compare the branch of myrtle at an Athenian feast (*Aristoph., Nub.*, 1364).

⁴ The *Iliad* was also recited at the festival of the Brauronia, at Brauron in Attica (*Hesych. s.v. Βραυρωνίαι*).

which the dialogue mainly consists. The author makes (perhaps willfully) all the mistakes about the family of Peisistratus which Thucydides notices in a well-known passage (vi. 54-59). In one point, however, the writer's testimony is valuable. He tells us that the law required the rhapsodists to recite "taking each other up in order (ἐξ ὑπολήψεως ἐφεξῆς), as they still do." This recurs in a different form in the statement of Diogenes Laertius (i. 2. 57) that Solon made a law that the poems should be recited "with prompting" (ἐξ ὑποβολῆς). The question as between Solon and Hipparchus cannot be settled; but it is at least clear that a due order of recitation was secured by the presence of a person charged to give the rhapsodists their cue (ὑποβάλλων). It was necessary, of course, to divide the poem to be recited into parts, and to compel each contending rhapsodist to take the part assigned to him. Otherwise they would have chosen favourite or show passages.

The practice of poets or rhapsodists contending for the prize at the great religious festivals is of considerable antiquity, though apparently post-Homeric. It is brought vividly before us in the Hymn to Apollo (see the passage mentioned above), and in two Hymns to Aphrodite (v. and ix.). The latter of these may evidently be taken to belong to Salamis in Cyprus and the festival of the Cyprian Aphrodite, in the same way that the Hymn to Apollo belongs to Delos and the Delian gathering. The earliest trace of such contests is to be found in the story of Thamyris, the Thracian singer, who boasted that he could conquer even the Muses in song (*Il.* ii. 594 ff.).

Much has been made in this part of the subject of a family or clan (γένος) of Homeridae in the island of Chios. On the one hand, it seemed to follow from the existence of such a family that Homer was a mere "eponymus," or mythical ancestor; on the other hand, it became easy to imagine the Homeric poems handed down orally in a family whose hereditary occupation it was to recite them, possibly to add new episodes from time to time, or to combine their materials in new ways, as their poetical gifts permitted. But, although there is no reason to doubt the existence of a family of "Homeridae," it is far from certain that they had anything to do with Homeric poetry. The word occurs first in Pindar (*Nem.* 2. 2), who applies it to the rhapsodists ('Ὀμηρίδας πατριῶν ἐπίων ὁδοῖοι). On this a scholiast says that the name "Homeridae" denoted originally descendants of Homer, who sang his poems in succession, but afterwards was applied to rhapsodists who did not claim descent from him. He adds that there was a famous rhapsodist, Cynaethus of Chios, who was said to be the author of the Hymn to Apollo, and to have first recited Homer at Syracuse about the 60th Olympiad. Nothing here connects the Homeridae with Chios. The statement of the scholiast is evidently a mere inference from the patronymic form of the word. If it proves anything, it proves that Cynaethus, who was a Chian and a rhapsodist, made no claim to Homeric descent. On the other hand our knowledge of Chian Homeridae comes chiefly from the lexicon of Harpocration, where we are told that Acusilaus and Hellanicus said that they were so called from the poet; whereas Seleucus pronounced this to be an error. Strabo also says that the Chians put forward the Homeridae as an argument in support of their claim to Homer. These Homeridae, then, belonged to Chios, but there is no indication of their being rhapsodists. On the contrary, Plato and other Attic writers use the word to include interpreters and admirers—in short, the whole "spiritual kindred"—of Homer. And although we hear of "descendants of Creophylus" as in possession of the Homeric poems, there is no similar story about descendants of Homer himself. Such is the evidence on which so many inferences are based.

The result of the notices now collected is to show that the early history of epic recitation consists of (1) passages in the Homeric hymns showing that poets contended for the prize at the great festivals, (2) the passing mention in Herodotus of rhapsodists at Sicyon, and (3) a law at Athens, of unknown date, regulating the recitation at the Panathenaea. Let us now compare these data with the account given in the Homeric poems. The word "rhapsode" does not yet exist; we hear only of the

"singer" (δοῦβς), who does not carry a wand or laurel-branch, but the lyre (φάρμαγξ), with which he accompanies his "song." In the *Iliad* even the epic "singer" is not met with. It is Achilles himself who sings the stories of heroes (κλέα ἀνδρῶν) in his tent, and Patroclus is waiting (*respondere paratus*), to take up the song in his turn (*Il.* ix. 191). Again we do not hear of poetical contests (except in the story of Thamyris already mentioned) or of recitation of epic poetry at festivals. The *Odyssey* gives us pictures of two great houses, and each has its singer. The song is on a subject taken from the Trojan war, at some point chosen by the singer himself, or by his hearers. Phemius pleases the suitors by singing of the calamitous return of the Greeks; Demodocus sings of a quarrel between Ulysses and Achilles, and afterwards of the wooden horse and the capture of Troy.

It may be granted that the author of the *Odyssey* can hardly have been just such a singer as he himself describes. The songs of Phemius and Demodocus are too short, and have too much the character of improvisations. Nor is it necessary to suppose that epic poetry, at the time to which the picture in the *Odyssey* belongs, was confined to the one type represented. Yet in several respects the conditions under which the singer finds himself in the house of a chieftain like Odysseus or Alcinoüs are more in harmony with the character of Homeric poetry than those of the later rhapsodic contests. The subdivision of a poem like the *Iliad* or *Odyssey* among different and necessarily unequal performers must have been injurious to the effect. The highly theatrical manner of recitation which was fostered by the spirit of competition, and by the example of the stage, cannot have done justice to the even movement of the epic style. It is not certain indeed that the practice of reciting a long poem by the agency of several competitors was ancient, or that it prevailed elsewhere than at Athens; but as rhapsodists were numerous, and popular favour throughout Greece became more and more confined to one or two great works, it must have become almost a necessity. That it was the mode of recitation contemplated by the author of the *Iliad* or *Odyssey* it is impossible to believe.

The difference made by substituting the wand or branch of laurel for the lyre of the Homeric singer is a slighter one, though not without significance. The recitation of the Hesiodic poems was from the first unaccompanied by the lyre, i.e. they were confessedly *said*, not *sung*; and it was natural that the example should be extended to Homer. For it is difficult to believe that the Homeric poems were ever "sung" in the strict sense of the word. We can only suppose that the lyre in the hands of the epic poet or reciter was in reality a piece of convention, a "survival" from the stage in which narrative poetry had a lyrical character. Probably the poets of the Homeric school—that which dealt with war and adventure—were the genuine descendants of minstrels whose "lays" or "ballads" were the amusement of the feasts in an earlier heroic age; whereas the Hesiodic compositions were non-lyrical from the first, and were only in verse because that was the universal form of literature.

It seems, then, that if we imagine Homer as a singer in a royal house of the Homeric age, but with more freedom regarding the limits of his subject, and a more tranquil audience than is allowed him in the rapid movement of the *Odyssey*, we shall probably not be far from the truth.

Time and Place of Homer.—The oldest direct references to the *Iliad* and *Odyssey* are in Herodotus, who quotes from both poems (ii. 53). The quotation from the *Iliad* is of interest because it is made in order to show that Homer supported the story of the travels of Paris to Egypt and Sidon (whereas the Cyclic poem called the *Cypria* ignored them), and also because the part of the *Iliad* from which it comes is cited as the "Aristeia of Diomedes." This was therefore a recognized part of the poem.

The earliest mention of the name of Homer is found in a fragment of the philosopher Xenophanes (of the 6th century B.C., or possibly earlier), who complains of the false notions implanted through the teaching of Homer. The passage shows, not merely that Homer was well known at Colophon in the time of Xenophanes, but also that the great advance in moral and

religious ideas which forced Plato to banish Homer from his republic had made itself felt in the days of the early Ionic philosophers.

Failing external testimony, the time and place of the Homeric poems can only be determined (if at all) by internal evidence. This is of two main kinds: (a) evidence of history, consisting in a comparison of the political and social condition, the geography, the institutions, the manners, arts and ideas of Homer with those of other times; (b) evidence of language, consisting in a comparison with later dialects, in respect of grammar and vocabulary. To these may be added, as occasionally of value, (c) much evidence of the direct influence of Homer upon the subsequent course of literature and art.

(a) The political condition of Greece in the earliest times known to history is separated from the Greece of Homer by an interval which can hardly be overestimated. The great national names are different instead of Achaeans, Argives, Danaï, we find Hellenes, subdivided into Dorians, Ionians, Aeolians—names either unknown to Homer, or mentioned in terms more significant than silence. At the dawn of Greek history Mycenae is no longer the seat of empire; new empires, politics and civilizations have grown up—Sparta with its military discipline, Delphi with its religious supremacy, Miletus with its commerce and numberless colonies, Aeolis and Ionia, Sicily and Magna Graecia.

While the political centre of Homeric Greece is at Mycenae, the real centre is rather to be found in Boeotia. The Catalogue of the Ships begins with Boeotia; the list of Boeotian towns is much the longest; and they sail, not from the bay of Argos, but from the Boeotian harbour of Aulis. This position is not due to its chiefs, who are all of inferior rank. The importance of Boeotia for Greek civilization is further shown by the ancient worship of the Muses on Mount Helicon, and the fact that the oldest poet whose birthplace was known was the Boeotian Hesiod. Next to Boeotia and the neighbouring countries, it appears that the Peloponnesus, Crete and Thessaly were the most important seats of Greek population.

In the Peloponnesus the face of things was completely altered by the Dorian conquest, no trace of which is found in Homer. The only Dorians known in Homer are those that the *Odyssey* (xix. 177) places in Crete. It is difficult to connect them with the Dorians of history.

The eastern shores of the Aegean, which the earliest historical records represent to us as the seat of a brilliant civilization, giving way before the advance of the great military empires (Lydia and afterwards Persia), are almost a blank in Homer's map. The line of settlements can be traced in the Catalogue from Crete to Rhodes, and embraces the neighbouring islands of Cos and Calymnos. The colonization of Rhodes by Telemachus is related (*Il.* ii. 661 ff.), and seems to mark the farthest point reached in the Homeric age. Between Rhodes and the Troad Homer knows of but one city, Miletus—which is a Carian ally of Troy—and the mouth of one river, the Cayster. Even the Cyclades—Naxos, Paros, Melos—are unknown to the Homeric world. The disposition of the Greeks to look to the west for the centres of religious feeling appears in the mention of Dodona and the Dodonaean Zeus, put in the mouth of the Thessalian Achilles.

To the north we find the Thracians, known from the stories of Thamyris the singer (*Il.* ii. 595), and Lycurgus, the enemy of the young god Dionysus (*Il.* vi. 130). Here the Trojan empire begins. It does not appear, however, that the Trojans are thought of as people of a different language. As this is expressly said of the Carians, and of the Trojan allies who were "summoned from afar," the contrary rather is implied regarding Troy itself.

The mixed type of government described by Homer—consisting of a king guided by a council of elders, and bringing all important resolutions before the assembly of the fighting men—does not seem to have been universal in Indo-European communities, but to have grown up in many different parts of the world under the stress of similar conditions. The king is the commander in war, and the office probably owed its existence to military necessities. It is not surrounded with any special

sacredness. There were ruling families, laying claim to divine descent, from whom the king was naturally chosen, but his own fitness is the essence of his title. The aged Laertes is set aside; the young Telemachus does not succeed as a matter of course. Nor are any very definite rights attached to the office. Each tribe in the army before Troy was commanded by its own king (or kings); but Agamemnon was supreme, and was "more a king" (*βασιλεύς*) than any other. The assembly is summoned on all critical occasions, and its approval is the ultimate sanction. A king therefore stands in almost as much need of oratory as of warlike skill and prowess. Even the division of the spoil is not made in the *Iliad* by Agamemnon, but by "the Achaeans" (*Il.* i. 162, 368). The taking of Briseis from Achilles was an arbitrary act, and against all rule and custom. The council is more difficult to understand. The "elders" (*γέροντες*) of the *Iliad* are the same as the subordinate "kings"; they are summoned by Agamemnon to his tent, and form a small council of nine or ten persons. In Troy we hear of elders of the people (*δηγογέροντες*) who are with Priam, and are men past the military age. So in Ithaca there are elders who have not gone to Troy with the army. It would seem therefore that the meeting in Agamemnon's tent was only a copy or adaptation of the true constitutional "council of elders," which indeed was essentially unfitted for the purposes of military service. The king's palace, if we may judge from Tiryns and Mycenae, was usually in a strong situation on an "acropolis." In the later times of democracy the acropolis was reserved for the temples of the principal gods.

Priesthood in Homer is found in the case of particular temples, where an officer is naturally wanted to take charge of the sacred inclosure and the sacrifices offered within it. It is perhaps an accident that we do not hear of priests in Ithaca. Agamemnon performs sacrifice himself, not because a priestly character was attached to the kingly office, but simply because he was "master in his own house."

The conception of "law" is foreign to Homer. The later words for it (*νόμος, ῥήτρα*) are unknown, and the terms which he uses (*ἔθος* and *θεμις*) mean merely "custom." Judicial functions are in the hands of the elders, who "have to do with suits" (*δικαστέω*), and "uphold judgments" (*θεμιστὰς ἐρῶνται*). On such matters as the compensation in cases of homicide, it is evident that there were no rules, but merely a feeling, created by use and wont, that the relatives of the slain man should be willing to accept payment. The sense of anger which follows a violation of custom has the name of "Nemesis"—righteous displeasure.

As there is no law in Homer, so there is no morality. That is to say, there are no general principles of action, and no words which indicate that acts have been classified as good or bad, right or wrong. Moral feeling, indeed, existed and was denoted by "Aidos"; but the numerous meanings of this word—shame, veneration, pity—show how rudimentary the idea was. And when we look to practice we find that cruel and even treacherous deeds are spoken of without the least sense that they deserve censure. The heroes of Homer are hardly more moral agents than the giants and enchanters of a fairy tale.

The religious ideas of Homer differ in some important points from those of later Greece. The Apollo of the *Iliad* has the character of a local Asiatic deity—"ruler of Chryse and goodly Cilla and Tenedos." He may be compared with the Clarian and the Lycian god, but he is unlike the Apollo of Dorian times, the "deliverer" and giver of oracles. Again, the worship of Dionysus, and of Demeter and Persephone, is mainly or wholly post-Homeric. The greatest difference, however, lies in the absence of hero-worship from the Homeric order of things. Castor and Polydeuces, for instance, are simply brothers of Helen who died before the expedition to Troy (*Il.* iii. 243.)

The military tactics of Homer belong to the age when the chariot was the principal engine of warfare. Cavalry is unknown, and the battles are mainly decided by the prowess of the chiefs. The use of the trumpet is also later. It has been supposed indeed that the art of riding was known in Homer's own time, because it occurs in comparisons. But the riding which he

describes (*Il.* xv. 679) is a mere exhibition of skill, such as we may see in a modern circus. And though he mentions the trumpet (*Il.* xviii. 219), there is nothing to show that it was used, as in historical times, to give the signal for the charge.

The chief industries of Homeric times are those of the carpenter (*τέκτων*), the worker in leather (*σικυροθύμιος*), the smith or worker in metal (*χαλκικός*)—whose implements are the hammer and pincers—and the potter (*κεραμικός*); also spinning and weaving, which were carried on by the women. The fine arts are represented by sculpture in relief, carving in wood and ivory, embroidery. Statuary is later; it appears to have come into existence in the 7th century¹ about the time when casting in metal was invented by Rhoecus of Samos. In general, as was well shown by A. S. Murray,² Homeric art does not rise above the stage of *decoration*, applied to objects in common use; while in point of style it is characterized by a richness and variety of ornament which is in the strongest contrast to the simplicity of the best periods. It is the work, in short, not of artists but of skilled workmen; the ideal artist is "Daedalus," a name which implies mechanical skill and intricate workmanship, not beauty of design.

One art of the highest importance remains. The question whether writing was known in the time of Homer was raised in antiquity, and has been debated with especial eagerness ever since the appearance of Wolf's *Prolegomena*. In this case we have to consider not merely the indications of the poems, but also the external evidence which we possess regarding the use of writing in Greece. This latter kind of evidence is much more considerable now than it was in Wolf's time. (See WRITING elsewhere in these volumes.)

The oldest known stage of the Greek alphabet appears to be represented by inscriptions of the islands of Thera, Melos and Crete, which are referred to the 40th Olympiad (620 B.C.). The oldest specimen of a distinctively Ionian alphabet is the famous inscription of the mercenaries of Psammetichus, in Upper Egypt, as to which the only doubt is whether the Psammetichus in question is the first or the second, and consequently whether the inscription is to be dated Ol. 40 or Ol. 47. Considering that the divergence of two alphabets (like the difference of two dialects) requires both time and familiar use, we may gather from these facts that writing was well known in Greece early in the 7th century B.C.³

The rise of prose composition in the 6th century B.C. has been thought to mark the time when memory was practically superseded by writing as a means of preserving literature—the earlier use of letters being confined to short documents, such as lists of names, treaties, laws, &c. This conclusion, however, is by no means necessary. It may be that down to comparatively late times poetry was not commonly read, but was recited from memory. But the question is—From what time are we to suppose that the preservation of long poems was generally secured by the existence of written copies? Now, without counting the Homeric poems—which doubtless had exceptional advantages in their fame and popularity—we find a body of literature dating from the 8th century B.C. to which the theory of oral transmission is surely inapplicable. In the Trojan cycle alone we know of the two epics of Arctinus, the *Little Iliad* of Lesches, the *Cypris*, the *Nostoi*. The Theban cycle is represented by the *Thebaid* (which Callinus, who was of the 7th century, ascribed to Homer) and the *Epigoni*. Other ancient epics—ancient enough to have passed under the name of Homer—are the *Taking of Oechalia*, and the *Phocæans*. Again, there are the numerous works attributed to Hesiod and other

¹ *Contemporary Review*, vol. xxiii, p. 218 ff.

² The fact that the Phœnician Vau (Ϝ) was retained in the Greek alphabets, and the vowel *o* added, shows that when the alphabet was introduced the sound denoted by *Ϝ* was still in full vigour. Otherwise *Ϝ* would have been used for the vowel *o*, just as the Phœnician consonant *Yod* became the vowel *u*. But in the Ionic dialect the sound of *Ϝ* died out soon after Homer's time, if indeed it was still pronounced then. It seems probable therefore that the introduction of the alphabet is not later than the composition of the Homeric poems.

poets of the didactic, mythological and quasi-historical schools—Eumelus of Corinth, Cynaethon of Sparta, Agias of Troezen, and many more. The preservation of this vast mass can only be attributed to writing, which must therefore have been in use for two centuries or more before there was any considerable prose literature. Nor is this in itself improbable.

The further question, whether the *Iliad* and *Odyssey* were originally written, is much more difficult. External evidence does not reach back so far, and the internal evidence is curiously indecisive. The only passage which can be interpreted as a reference to writing occurs in the story of Bellerophon, told by Glaucus in the sixth book of the *Iliad*. Proetus, king of Corinth, sent Bellerophon to his father-in-law the king of Lycia, and gave him "baneful tokens" (*σήμερα λυγρὰ*, i.e. tokens which were messages of death), "scratching on a folded tablet many spirit-destroying things, and bade him show this to his father-in-law, that he might perish." The king of Lycia asked duly (on the tenth day from the guest's coming) for a token (*ἴσθαι σήμερον ἔσθαι*), and then knew what Proetus wished to be done. In this account there is nothing to show exactly how the message of Proetus was expressed. The use of writing for the purpose of the token between "guest-friends" (*tesera hospitalis*) is certainly very ancient. Mommsen (*Röm. Forsch.* i. 338 ff.) aptly compares the use in treaties, which are the oldest species of public documents. But we may suppose that tokens of some kind—like the marks which the Greek chiefs make on the lots (*Il.* vii. 175 ff.)—were in use before writing was known. In any system of signs there were doubtless means of recommending a friend, or giving warning of the presence of an enemy. There is no difficulty, therefore, in understanding the message of Proetus without alphabetical writing. But, on the other hand, there is no reason for so understanding it.

If the language of Homer is so ambiguous where the use of writing would naturally be mentioned, we cannot expect to find more decisive references elsewhere. Arguments have been founded upon the descriptions of the blind singers in the *Odyssey*, with their songs inspired directly by the Muse; upon the appeals of the poet to the Muses, especially in such a place as the opening of the Catalogue; upon the Catalogue itself, which is a kind of historical document put into verse to help the memory; upon the shipowner in the *Odyssey*, who has "a good memory for his cargo," &c. It may be answered, however, that much of this is traditional, handed down from the time when all poetry was unwritten. Moreover it is one thing to recognize that a literature is essentially oral in its form, characteristic of an age which was one of hearing rather than of reading, and quite another to hold that the same literature was preserved entirely by oral transmission.

The result of these various considerations seems to be that the age which we may call the Homeric—the age which is brought before us in vivid outlines in the *Iliad* and *Odyssey*—lies beyond the earliest point to which history enables us to penetrate. And so far as we can draw any conclusion as to the author (or authors) of the two poems, it is that the whole debate between the cities of Aeolis and Ionia was wide of the mark. The author of the *Iliad*, at least, was evidently a European Greek who lived before the colonization of Asia Minor; and the claims of the Asiatic cities mean no more than that in the days of their prosperity these were the chief seats of the fame of Homer.

This is perhaps the place to consider whether the poems are to be regarded as possessing in any degree the character of historical record. The question is one which in the absence of satisfactory criteria will generally be decided by taste and predilection. A few suggestions, however, may be made.

1. The events of the *Iliad* take place in a real locality, the general features of which are kept steadily in view. There is no doubt about Sigeum and Rhoeteum, or the river Scamander, or the islands Imbros, Lemnos and Tenedos. It is at least remarkable that a legend of the national interest of the "tale of Troy" should be so definitely localized, and that in a district which was never famous as a seat of Greek population. It may be urged, too, that the story of the *Iliad* is singularly free from the exaggerated and marvellous character which belongs as a rule to the legends of primitive peoples. The apple of discord, the arrows of Philoctetes, the invulnerability of Achilles, and similar fancies, are the additions of later poets. This

sobriety, however, belongs not to the whole *Iliad*, but to the events and characters of the war. Such figures as Bellerophon, Nobe, the Amazons, which are thought of as traditions from an earlier generation, show the marvellous element at work.

2. Certain persons and events in the story have a distinctly mythical stamp. Helen is a figure of this kind. There was another story according to which she was carried off by Theseus, and recovered by her brothers the Dioscuri. There are even traces of a third version, in which the Messenian twins, Idas and Lynceus, appear.

3. The analogy of the French epic, the *Chansons de Roland*, favours the belief that there was some nucleus of fact. The defeat of Roncevaux was really suffered by a part of Charlemagne's army. But the Saracen army is purely mythical, the true enemy having been the Gascons. If similarly we leave, as historical, the plain of Troy, and the name Agamemnon, we shall perhaps not be far wrong.

(b) The dialect of Homer is an early or "primitive" form of the language which we know as that of Attica in the classical age of Greek literature. The proof of this proposition is to be obtained chiefly by comparing the grammatical formation and the syntax of Homer with those of Attic. The comparison of the vocabulary is in the nature of things less conclusive on the question of date. It would be impossible to give the evidence in full without writing a Homeric grammar, but a few specimens may be of interest.

1. The first aorist in Greek being a "weak" tense, i.e. formed by a suffix (-α), whereas the second aorist is a "strong" tense, distinguished by the form of the root-syllable, we expect to find a constant tendency to diminish the number of second aorists in use. No new second aorists, we may be sure, were formed any more than new "strong" tenses, such as *came* or *sang*, can be formed in English. Now in Homer there are upwards of 80 second aorists (not reckoning aorists of "Verbs in α", such as *ἔταρα*, *ἔθω*), whereas in all Attic prose not more than 30 are found. In this point therefore the Homeric language is manifestly older. In Attic poets, it is true, the number of such aorists is much larger than in prose. But here again we find that they bear witness to Homer. Of the poetical aorists in Attic the larger part are also Homeric. Others are not really Attic at all, but borrowed from earlier Aeolic and Doric poetry. It is plain, in short, that the later poetical vocabulary was separated from that of prose mainly by the forms which the influence of Homer had saved from being forgotten.

2. While the whole class of "strong" aorists diminished, certain smaller groups in the class disappeared altogether. Thus we find in Homer, but not in the later language:—

(a) The second aorist middle without the "thematic" ε or ο: as *ἔβλητο*, was struck; *ἔθλιτο*, perished; *ἔλιτο*, leaped.

(b) The aorist formed by reduplication: as *ἔββαε*, taught; *ἔλαβεν*, to seize. These constitute a distinct formation, generally with a "causative" meaning; the solitary Attic specimen is *ἔγαγος*.

3. It had long been known that the subjunctive in Homer often takes a short vowel (e.g. in the plural, -εσσι instead of -ουσι, -εσσι, and in the Mid. -ουσι, &c. instead of -ουσαι, &c.). This was generally said to be done by "poetic licence," or *metri gratia*. In fact, however, the Homeric subjunctive is almost quite "regular," though the rule which it obeys is a different one from the Attic. It may be summed up by saying that the subjunctive takes ω or η when the indicative has ο or ε, and not otherwise. Thus Homer has *ἔμω, ἔω γα, ἔω-ωσθε, ἔω γα*. The later *ἔω-ωσθε* was at first a solecism; an attempt to conjugate a "verb in μ" like the "verbs in α." It will be evident that under this rule the perfect and first aorist subjunctive should always take a short vowel; and this accordingly is the case, with very few exceptions.

4. The article (ὁ, ἡ, τό) in Homer is chiefly used as an independent pronoun (*he, she, it*), a use which in Attic appears only in a few combinations (such as *ὁ ἄλλος . . . ὁ ἄλλος, the one . . . the other*). This difference is parallel to the relation between the Latin *ille* and the article of the Romance languages.

5. The prepositions offer several points of comparison. What the grammarians called "tmesis," the separation of the preposition from the verb with which it is compounded, is peculiar to Homer. The true account of the matter is that in Homer the place of the preposition is not rigidly fixed, as it was afterwards. Again, "with" is in Homer *σύν* (with the dative), in Attic prose *σύν* with the genitive. Here Attic poetry is intermediate; the use of *σύν* is retained as a piece of poetical tradition.

6. In addition to the particle *καί*, Homer has another, *καὶ*, hardly distinguishable in meaning. The Homeric uses of *καί* and *καὶ* are different in several respects from the Attic, the general result being that the Homeric syntax is more elastic. And yet it is perfectly definite and precise. Homer uses no constructions loosely or without corresponding differences of meaning. His rules are equally strict with those of the later language, but they are not the same rules. And they differ chiefly in this, that the less common combinations of the earlier period were disused altogether in the later.

7. In the vocabulary the most striking difference is that many words appear from the metre to have contained a sound which they

afterwards lost, viz. that which is written in some Greek alphabets by the "digamma" Ϝ. Thus the words *ἔβαλε*, *ἔδωκε*, *ἔργον*, *ἔσπευ*, and many others must have been written at one time *ἔβαλε*, *ἔδωκε*, *ἔργον*, *ἔσπευ*, *ἔσπευ*, *ἔσπευ*. This letter, however, died out earlier in Ionic than in most dialects, and there is no proof that the Homeric poems were ever written with it.

These are not, speaking generally, the differences that are produced by the gradual divergence of dialects in a language. They are rather to be classed with those which we find between the earlier and the later stages of every language which has had a long history. The Homeric dialect has passed into New Ionic and Attic by gradual but ceaseless development of the same kind as that which brought about the change from Vedic to classical Sanskrit, or from old high German to the present dialects of Germany.

The points that have been mentioned, to which many others might be added, make it clear that the Homeric and Attic dialects are separated by differences which affect the whole structure of the language, and require a considerable time for their development. At the same time there is hardly one of these differences which cannot be accounted for by the natural growth of the language. It has been thought indeed that the Homeric dialect was a mixed one, mainly Ionic, but containing Aeolic and even Doric forms; this, however, is a mistaken view of the processes of language. There are doubtless many Homeric forms which were unknown to the later Ionic and Attic, and which are found in Aeolic or other dialects. In general, however, these are *older* forms, which must have existed in Ionic at one time, and may very well have belonged to the Ionic of Homer's time. So too the digamma is called "Aeolic" by grammarians, and is found on Aeolic and Doric inscriptions. But the letter was one of the original alphabet, and was retained universally as a numeral. It can only have fallen into disuse by degrees, as the sound which it denoted ceased to be pronounced. The fact that there are so many traces of it in Homer is a strong proof of the antiquity of the poems, but no proof of admixture with Aeolic.

There is one sense, however, in which an admixture of dialects may be recognized. It is clear that the variety of forms in Homer is too great for any actual spoken dialect. To take a single instance: it is impossible that the genitives in -ου and in -ου should both have been in everyday use together. The form in -ου must have been poetical or literary, like the old English forms that survive in the language of the Bible. The origin of such double forms is not far to seek. The effect of dialect on style was always recognized in Greece, and the dialect which had once been adopted by a particular kind of poetry was ever afterwards adhered to. The Epic of Homer was doubtless formed originally from a spoken variety of Greek, but became literary and conventional with time. It is Homer himself who tells us, in a striking passage (*Il. iv. 437*), that all the Greeks spoke the same language—that is to say, that they understood one another, in spite of the inevitable local differences. Experience shows how some one dialect in a country gains a literary supremacy to which the whole nation yields. So Tuscan became the type of Italian, and Anglian of English. But as soon as the dialect is adopted, it begins to diverge from the colloquial form. Just as modern poetical Italian uses many older grammatical forms peculiar to itself, so the language of poetry, even in Homeric times, had formed a deposit (so to speak) of archaic grammar. There were doubtless poets before Homer, as well as brave men before Agamemnon; and indeed the formation of a poetical dialect such as the Homeric must have been the work of several generations. The use of that dialect (instead of Aeolic) by the Boeotian poet Hesiod, in a kind of poetry which was not of the Homeric type, tends to the conclusion that the literary ascendancy of the epic dialect was anterior to the *Iliad* and *Odyssey*, and independent of the influence exercised by these poems.

What then was the original language of Homer? Where and when was it spoken? [The answer given to this question by Aug. Fick (in 1883) and still held, with modifications, by some European scholars can no longer be maintained. Fick's original statement was that in or about the 6th century B.C.

the poems, which had originally worn an Aeolic dress, were transposed into Ionic. To this it is easily answered that such an event is not only unique in history, but contrary to all that we know of the Greek genius. At the period in question an Aeolic literature, the lyrics of Sappho and Alcaeus, were in existence. If it was found necessary to transpose the Aeolic Homer, why did the Aeolic lyric verse escape? If, however, as is the view of some of Fick's followers, the transposition took place several centuries earlier, before species of literature had appropriated particular dialects, then the linguistic facts upon which Fick relied to distinguish the "Aeolic" and "Ionic" elements in Homer disappear. We have no means of knowing what the Aeolic and Ionic of say the 9th century were, or if there were such dialects at all. Certain prominent historical differences between Aeolic and Ionic (the digamma and α) are known to be unoriginal. The view that Homer underwent at any time a passage from one dialect to another may be dismissed. The tendency of modern dialectologists is to divide the Greek dialects into Dorian and non-Dorian. The non-Dorian dialects, Ionic, Attic and the various forms of Aeolic, are regarded as relatively closely akin, and go by the common name "Achaean." They formed the common language of Greece before the Doric invasion. As the scene which Homer depicts is pre-Dorian Greece, it is reasonable to call his language Achaean. The historical divergences of Achaean into Aeolian and Ionic were later than the Migration, and were due to the well-known effects of change of soil and air.

To what local variety of Achaean Homeric Greek belonged it is idle to ask. Thessaly, Boeotia and Mycenae have equal claims. It seems clearer that when once this local variety of Achaean had been used by poets of eminence as their vehicle for national history, it established its right to be considered the one poetical language of Hellas. As the dialect of the Arno in Italy, of Castille in Spain, by the virtue of the genius of the singers who used them, became literary "Italian" and "Spanish," so this variety of Achaean elevated itself to the position of the *volgare illustre* of Greece.] (T. W. A.)

(c) The influence of Homer upon the subsequent course of Greek literature is a large subject, even if we restrict it to the centuries which immediately followed the Homeric age. It will be enough to observe that in the earliest elegiac poets, such as Archilochus, Tyrtaeus and Theognis, reminiscences of Homeric language and thought meet us on every page. If the same cannot be said of the ancient epic poems, that is because of the extreme scantiness of the existing fragments. Much, however, is to be gathered from the arguments of the Trojan part of the Epic Cycle (preserved in the *Codex Venetus* of the *Iliad*, a full discussion of which will be found in the *Journal of Hellenic Studies*, 1884, pp. 1-40). An examination of these arguments throws light on two chief aspects of the relation between Homer and his "cyclic" successors.

1. The later poets sought to complete the story of the Trojan war by supplying the parts which did not fall within the *Iliad* and *Odyssey*—the so-called *ante-homeric* and *post-homeric*. They did so largely from hints and passing references in Homer. Thus the successive episodes of the siege related at length in the *Little Iliad*, and ending with the story of the Wooden Horse, are nearly all taken from passages in the *Odyssey*. Much the same may be said of the *Nosti*.

2. With this process of expansion and development (so to speak) of Homeric themes is combined the addition of new characters. Such, in the *Little Iliad* (e.g.), are the story of the Palladium and of the treachery of Sinon. Such, too, in the *Cypria* are the new legendary figures—Palamedes, Iphigenia, Telephus, Laocoon. These new elements in the narrative are evidently due not only to the natural growth of legend in a people highly endowed with imagination, but in a large proportion also to the new

races and countries with which the Greeks came into contact, as well as to their own rapid advance in wealth and civilization. It will be observed that the two poems of Arctinus are remarkable for the proportion of new matter of the latter kind. The *Aethiopsis* shows us the allies of Troy reinforced by two peoples that are evidently creations of oriental fancy, the Amazons and Memnon with his Ethiopians. The *Ilu Persu*, again, was the oldest authority for the story of Laocoon and of the consequent escape of Aeneas—a story which connected a surviving branch of the house of Priam with the later inhabitants of the Troad. On the other hand the fate of Creusa (*sed me magna deum genetrix his detinet oris*) is a link with the worship of Cybele. The journey of Calchas to Colophon and his death there, as told in the *Nosti*, is another instance of the kind. These facts point to a familiarity with the Greek colonies in Asia which contrasts strongly with the silence of the *Iliad* and *Odyssey*.

Study of Homer.—The Homeric Question.—The critical study of Homer began in Greece almost with the beginning of prose writing. The first name is that of Theagenes of Rhegium, contemporary of Cambyses (525 B.C.), who is said to have founded the "new grammar" (the older "grammar" being the art of reading and writing), and to have been the inventor of the allegorical interpretations by which it was sought to reconcile the Homeric mythology with the morality and speculative ideas of the 6th century B.C. The same attitude in the "ancient quarrel of poetry and philosophy" was soon afterwards taken by Anaxagoras; and after him by his pupil Metrodorus of Lampsacus, who explained away all the gods, and even the heroes, as elementary substances and forces (Agamemnon as the upper air, &c.).

The next writers on Homer of the "grammatical" type were Stesimbrotus of Thasos (contemporary with Cimon) and Antimachus of Colophon, himself an epic poet of mark. The *Thesaid* of Antimachus, however, was not popular, and seems to have been a great storehouse of mythological learning rather than a poem of the Homeric school.

Other names of the pre-Socratic and Socratic times are mentioned by Xenophon, Plato and Aristotle. These were the "ancient Homeric" (of ἄγχατορ 'Ομηρολογος), who busied themselves much with the hidden meanings of Homer; of whom Aristotle says, with his profound insight, that they see the small likenesses and overlook the great ones (*Metaph.* xii.).

The text of Homer must have attracted some attention when Antimachus came to be known as the "corrector" (διορθωτής) of a distinct edition (ἰδοθεύς). Aristotle is said himself to have made a recension for the use of Alexander the Great. This is unlikely. His remarks on Homer (in the *Poetics* and elsewhere) show that he had made a careful study of the structure and leading ideas of the poems, but do not throw much light on the text.

The real work of criticism became possible only when great collections of manuscripts began to be made by the princes of the generation after Alexander, and when men of learning were employed to sift and arrange these treasures. In this way the great Alexandrian school of Homeric criticism began with Zenodotus, the first chief of the museum, and was continued by Aristophanes and Aristarchus. In Aristarchus ancient philology culminated, as philosophy had done in Socrates. All earlier learning either passed into his writings, or was lost; all subsequent research turned upon his critical and grammatical work.

The means of forming a judgment of the Alexandrian criticism are scanty. The literary form which preserved the works of the great historians was unfortunately wanting, or was not sufficiently valued, in the case of the grammarians. Abridgments and newer treatises soon drove out the writings of Aristarchus and other founders of the science. Moreover, a recension could not be reproduced without new errors soon creeping in. Thus we find that Didymus, writing in the time of Cicero, does not quote the readings of Aristarchus as we should quote a *textus receptus*. Indeed, the object of his work seems to have been to determine what those readings were. Enough, however, remains to show that Aristarchus had a clear notion of the chief problems of philology (except perhaps those concerning etymology). He saw, for example, that it was not enough to find a meaning for the archaic words (the γλῶσσαι, as they were called), but that common words (such as ἴσθαι, φέρειν) had their Homeric uses, which were to be gathered by due induction. In the same spirit he looked upon the ideas and beliefs of Homer as a consistent whole, which might be determined from the evidence of the poems. He noticed especially the difference between the stories known to Homer and those given by later poets, and made many comparisons between Homeric and later manners, arts and institutions. Again, he was sensible of the paramount value of manuscript authority, and appears to have introduced no readings from mere conjecture. The frequent mention in the Scholia of "better" and "inferior" texts may indicate a classification made by him or by the general opinion of critics. His use of the "obelus" to distinguish spurious verses, which made so large a part of his fame

¹ See D. B. Monro's *Homer's Odyssey*, books xiii.-xxiv. (Oxford, 1901, p. 455 sqq.), and the abstract of his paper on the Homeric Dialect read to the Congress of Historical Sciences at Rome, 1903: *Atti del Congresso internazionale di scienze storiche*, ii. 152, 153, 1905. "Il Dialetto omerico."

in antiquity, has rather told against him with modern scholars.¹ It is chiefly interesting as a proof of the confusion in which the text must have been before the Alexandrian times; for it is impossible to understand the readiness of Aristarchus to suspect the genuineness of verses unless the state of the copies had pointed to the existence of numerous interpolations. On this matter, however, we are left to conjecture.

Our knowledge of Alexandrian criticism is derived almost wholly from a single document, the famous *Iliad* of the library of St Mark in Venice (*Codex Venetus* 454, or *Ven. A*), first published by the French scholar Vilvoison in 1788 (*Scholium antiquissimum ad Homerum Iliadem*). This manuscript, written in the 10th century, contains (1) the best text of the *Iliad*, (2) the critical marks of Aristarchus and (3) Scholia, consisting mainly of extracts from four grammatical works, viz. Didymus (contemporary of Cicero) on the recension of Aristarchus, Aristonicus (fl. 24 B.C.) on the critical marks of Aristarchus, Herodian (fl. A.D. 160) on the accentuation, and Nicanor (fl. A.D. 127) on the punctuation, of the *Iliad*.

These extracts present themselves in two distinct forms. One series of scholia is written in the usual way, on a margin reserved for the purpose. The other consists of brief scholia, written in very small characters (but of the same period) on the narrow space left vacant round the text. Occasionally a scholium of this kind gives the substance of one of the longer extracts; but as a rule they are distinct. It would seem, therefore, that after the manuscript was finished the "marginal scholia" were discovered to be extremely defective, and a new series of extracts was added in a form which interfered as little as possible with the appearance of the book.²

The mention of the Venetian Scholia leads us at once to the Homeric controversy; for the immortal *Prolegomena* of F. A. Wolf³ appeared a few years after Vilvoison's publication, and was founded in great measure upon the fresh and abundant materials which it furnished. Not that the "Wolfian theory" of the Homeric poems is directly supported by anything in the Scholia; the immediate object of the *Prolegomena* was not to put forward that theory, but to elucidate the new and remarkable conditions under which the text of Homer had to be settled, viz. the discovery of an *apparatus criticus* of the 2nd century B.C. The questions regarding the original structure and early history of the poems were raised (forced upon him, it may be said) by the critical problem; but they were really originated by facts and ideas of a wholly different order.

The 18th century, in which the spirit of classical correctness had the most absolute dominion, did not come to an end before a powerful reaction set in, which affected not only literature but also speculation and politics. In this movement the leading ideas were concentrated in the word Nature. The natural condition of society, natural law, natural religion, the poetry of nature, gained a singular hold, first on the English philosophers from Hume onwards, and then (through Rousseau chiefly) on the general drift of thought and action in Europe. In literature the effect of these ideas was to set up a false opposition between nature and art. As political writers imagined a patriarchal innocence prior to codes of law, so men of letters sought in popular unwritten poetry the freshness and simplicity which were wanting in the prevailing styles. The blind minstrel was the counterpart of the noble savage. The supposed discovery of the poems of Ossian fell in with this train of sentiment, and created an enthusiasm for the study of early popular poetry. Homer was soon drawn into the circle of inquiry. Blackwell (Professor of Greek at Aberdeen) had insisted, in a book published in 1735, on the "naturalness" of Homer; and Wood (*Essay on the Original Genius of Homer*, London, 1769) was the first who maintained that Homer composed without the help of writing, and supported his thesis by ancient authority, and also by the parallel of Ossian. Both these books were translated into German, and their ideas passed into the popular philosophy of the day. Everything in short was ripe for the reception of a book that brought together, with mastery ease and vigour, the old and the new Homeric learning, and drew from it the historical proof that Homer was no single poet, writing according to art and rule, but a name which stood for a golden age of the true spontaneous poetry of genius and nature.

The part of the *Prolegomena* which deals with the original form of the Homeric poems occupies pp. xl-cix. (in the first edition). Wolf shows how the question of the date of writing meets us on the

threshold of the textual criticism of Homer and accordingly enters into a full discussion, first of the external evidence, then of the indications furnished by the poems. Having satisfied himself that writing was unknown to Homer, he is led to consider the real mode of transmission, and finds this in the Rhapsodists, of whom the Homeridae were an hereditary school. And then comes the conclusion to which all this has been tending: "the die is cast"—the *Iliad* and *Odyssey* cannot have been composed in the form in which we know them without the aid of writing. They must therefore have been, as Bentley had said, "a sequel of songs and rhapsodies," "loose songs not collected together in the form of an epic poem till about 500 years after." This conclusion he then supports by the character attributed to the "Cyclic" poems (whose want of unity showed that the structure of the *Iliad* and *Odyssey* must be the work of a later time), by one or two indications of imperfect connexion, and by the doubts of ancient critics as to the genuineness of certain parts. These, however, are matters of conjecture. "Historia loquitur." The voice of antiquity is unanimous in declaring that "Pseisistratus first committed the poems of Homer to writing, and reduced them to the order in which we now read them."

The appeal of Wolf to the "voice of all antiquity" is by no means borne out by the different statements on the subject. According to Heraclides Ponticus (pupil of Plato), the poetry of Homer was first brought to the Peloponnesus by Lycurgus, who obtained it from the descendants of Creophylus (*Polit. fr. 2*). Plutarch in his *Life of Lycurgus* (c. 4) repeats this story, with the addition that there was already a faint report of the poems in Greece, and that certain detached fragments were in the possession of a few persons. Again, the Platonic dialogue *Hipparchus* (which though not genuine is probably earlier than the Alexandrian times) asserts that Hipparchus, son of Pseisistratus, first brought the poems to Athens, and obliged the rhapsodists at the Panathenaea to follow the order of the text, "as they still do," instead of reciting portions chosen at will. The earliest authority for attributing any work of the kind to Pseisistratus is the well-known passage of Cicero (*De Orat.* 3. 34: "Quis doctor sistem temporibus illis, aut cuius eloquentia litteris instructor fuisse traditur quam Pseistrati? qui primus Homeri libros, confusos antea, sic disposuisse dicitur ut nunc habemus"). To the same effect Pausanias (vii. p. 594) says that the change of the name Demos to Gomoessa (in *Il.* ii. 573) was thought to have been made by "Pseisistratus or one of his companions," when he collected the poems, which were then in a fragmentary condition. Finally, Diogenes Laertius (i. 57) says that Solon made a law that the poems should be recited with the help of a prompter so that each rhapsodist should begin where the last left off; and he argues from this that Solon did more than Pseisistratus to make Homer known. The argument is directed against a certain Diuchidas of Megara, who appears to have maintained that the verses about Athens in the Catalogue (*Il.* ii. 546-556) were interpolated by Pseisistratus. The passage is unfortunately corrupt, but it is at least clear that in the time of Solon, according to Diogenes, there were complete copies of the poems, such as could be used to control the recitations. Hence the account of Diogenes is quite irreconcilable with the notices on which Wolf relied.

It is needless to examine the attempts which have been made to harmonize these accounts. Such attempts usually start with the tacit assumption that each of the persons concerned—Lycurgus, Solon, Pseisistratus, Hipparchus—must have done something for the text of Homer, or for the regulation of the rhapsodists. But we have first to consider whether any of the accounts come to us on such evidence that we are bound to consider them as containing a nucleus of truth.

In the first place, the statement that Lycurgus obtained the poems from descendants of Creophylus must be admitted to be purely mythical. But if we reject it, have we any better reason for believing the parallel assertion in the Platonic *Hipparchus*? It is true that Hipparchus is undoubtedly a real person. On the other hand it is evident that the Pseisistratidee soon became the subject of many fables. Thucydides notices as a popular mistake the belief that Hipparchus was the eldest son of Pseisistratus, and that consequently he was the reigning "tyrant" when he was killed by Aristogiton. The Platonic *Hipparchus* follows this erroneous version, and may therefore be regarded as representing (at best) mere local tradition. We may reasonably go further, and see in this part of the dialogue a piece of historical romance, designed to put the "tyrant" family in a favourable light, as patrons of literature and learning.

Again, the account of the *Hipparchus* is contradicted by Diogenes Laertius, who says that Solon provided for the due recitation of the Homeric poems. The only good authorities as to this point are the orators Lycurgus and Isocrates, who mention the law prescribing the recitation, but do not say when or by whom it was enacted. The inference seems a fair one, that the author of the law was really unknown.

With regard to the statements which attribute some work in connexion with Homer to Pseisistratus, it was noticed by Wolf that Cicero, Pausanias and the others who mention the matter do so nearly in the same words, and, therefore, appear to have drawn from a common source. This source was in all probability an epigram quoted in two of the short lives of Homer, and there said to have been inscribed on the statue of Pseisistratus at Athens. In it Pseisistratus is made to say of himself that he "collected Homer, who was formerly sung

¹ See the chapter in Cobet's *Miscellanea critica*, pp. 225-239.

² The existence of two groups of the Venetian Scholia was first noticed by Jacob La Roche, and they were first distinguished in the edition of W. Dindorf (Oxford, 1875). There is also a group of Scholia, chiefly exegetical, a collection of which was published by Vilvoison from a MS. Ven. 453 (c. xi.) in his edition of 1788, and has been again edited by W. Dindorf (Oxford, 1877). The most important collection of this group is contained in the *Codex Troadicus* (Burney 86 a. xi.) of the British Museum, edited by E. Maass, (Oxford, 1887-1888). The vast commentary of Eustathius of the 12th century marks a third stage in the progress of ancient Homeric learning.

³ *Prolegomena ad Homerum, sive de operum Homericorum prisca et genuina forma varietate mutationibus et probabilis ratione emendandi*, scripsit Frid. Aug. Wolfius, volumen i. (1795).

in fragments, for the golden poet was a citizen of ours, since we Athenians founded Smyrna. The other statements repeat these words with various minor additions, chiefly intended to explain how the poems had been reduced to this fragmentary condition, and how Peisistratus set to work to restore them. Thus all the authority for the work of Peisistratus "reduces itself to the testimony of a single anonymous inscription" (Nitzsch p. 40). Now, what is the value of that testimony? It is impossible of course to believe that a statue of Peisistratus was set up at Athens in the time of the free republic. The epigram is almost certainly a mere literary exercise. And what exactly does it say? Only that Homer was recited in fragments by the rhapsodists, and that these partial recitations were made into a continuous whole by Peisistratus; which does not necessarily mean more than that Peisistratus did what other authorities ascribe to Solon and Hipparchus, viz. regulated the recitation.

Against the theory which sees in Peisistratus the author of the first complete text of Homer we have to set the absolute silence of Herodotus, Thucydides, the orators and the Alexandrian grammarians. And it can hardly be thought that their silence is accidental. Herodotus and Thucydides seem to tell us all that they know of Peisistratus. The orators Lycurgus and Isocrates make a great deal of the recitation of Homer at the Panathenaea, but know nothing of the poems having been collected and arranged at Athens, a fact which would have redounded still more to the honour of the city. Finally, the Scholia on the *Ven.* A contain no reference or allusion to the story of Peisistratus. As these Scholia are derived in substance from the writings of Aristarchus, it seems impossible to believe that the story was known to him. The circumstance that it is referred to in the *Schol. Troadica* and in Eustathius, gives additional weight to this argument.

The result of these considerations seems to be that nothing rests on good evidence beyond the fact that Homer was recited by law at the Panathenaea festival. The rest of the story is probably the result of gradual expansion and accretion. It was inevitable that later writers should speculate about the authorship of such a law, and that it should be attributed with more or less confidence to Solon or Peisistratus or Hipparchus. The choice would be determined in great measure by political feeling. It is probably not an accident that Dieuchidas, who attributed so much to Peisistratus, was a Megarian. The author of the *Hipparchus* is evidently influenced by the anti-democratic tendencies in which he only followed Plato. In the times to which the story of Peisistratus can be traced, the 1st century B.C., the substitution of the "tyrant" for the legislator was extremely natural. It was equally natural that the importance of his work as regards the text of Homer should be exaggerated. The splendid patronage of letters by the successors of Alexander, and especially the great institutions which had been founded at Alexandria and Pergamum, had made an impression on the imagination of learned men which was reflected in the current notions of the ancient despots. It may even be suspected that anecdotes in praise of Peisistratus and Hipparchus were a delicate form of flattery addressed to the reigning Ptolemy. Under these influences the older stories of Lycurgus bringing Homer to the Peloponnesus, and Solon providing for the recitation at Athens, were thrown into the shade.

In the later Byzantine times it was believed that Peisistratus was aided by seventy grammarians, of whom Zenodotus and Aristarchus were the chief. The great Alexandrian grammarians had become figures in a new mythology. It is true that Tzetzes, one of the writers from whom we have this story, gives a better version, according to which Peisistratus employed four men, viz. Onomacritus, Zopyrus of Heraclea, Orpheus of Croton, and one whose name is corrupt (written *ερωδωγιδος*). Many scholars (among them Ritschl) accept this account as probable. Yet it rests upon no better evidence than the other.

The effect of Wolf's *Prolegomena* was so overwhelming that, although a few protests were made at the time, the true Homeric controversy did not begin till after Wolf's death (1824). His speculations were thoroughly in harmony with the ideas and sentiment of the time, and his historical arguments, especially his long array of testimonies to the work of Peisistratus, were hardly challenged.

The first considerable antagonist of the Wolfian school was G. W. Nitzsch, whose writings cover the years 1828-1862, and deal with every side of the controversy. In the earlier part of his *Meletemata* (1830) he took up the question of written or unwritten literature, on which Wolf's whole argument turned, and showed that the art of writing must be anterior to Peisistratus. In the later part of the same series of discussions (1837), and in his chief work (*Die Sagenpoesie der Griechen*, 1852), he investigated the structure of the Homeric poems, and their relation to the other epics of the Trojan cycle. These epics had meanwhile been made the subject of a work which for exhaustive learning and delicacy of artistic perception has few rivals in the history of philology, the *Epic Cycle* of F. G. Welcker. The confusion which previous scholars had made between the ancient post-Homeric poets (Arctinus, Lesches, &c.) and the learned mythological writers (such as the "scriptor cyclicus" of Horace) was first cleared up by Welcker. Wolf had argued that if the cyclic writers had known the *Iliad* and *Odyssey* which we possess, they would have imitated the unity of structure which distinguishes these two poems. The result of Welcker's labours was to show that

the Homeric poems had influenced both the form and the substance of epic poetry.

In this way there arose a conservative school who admitted more or less freely the absorption of pre-existing lays in the formation of the *Iliad* and *Odyssey*, and also the existence of considerable interpolations, but assigned the main work of formation to prehistoric times, and to the genius of a great poet. Whether the two epics were by the same author remained an open question; the tendency of this group of scholars was decidedly towards separation. Regarding the use of writing, too, they were not unanimous. K. O. Müller, for instance, maintained the view of Wolf on this point, while he strenuously combated the inference which Wolf drew from it.

The *Prolegomena* bore on the title-page the words "Volumen I.;" but no second volume ever appeared, nor was any attempt made by Wolf himself to carry his theory further. The first important steps in that direction were taken by Gottfried Hermann, chiefly in two dissertations, *De interpolationibus Homeri* (Leipzig, 1832), and *De iteratis Homeri* (Leipzig, 1840), called forth by the writings of Nitzsch. As the word "interpolation" implies, Hermann did not maintain the hypothesis of a congeries of independent "lays." Feeling the difficulty of supposing that all the ancient minstrels sang of the "wrath of Achilles" or the "return of Ulysses" (leaving out even the capture of Troy itself), he was led to assume that two poems of no great compass dealing with these two themes became so famous at an early period as to throw other parts of the Trojan story into the background, and were then enlarged by successive generations of rhapsodists. Some parts of the *Iliad*, moreover, seemed to him to be older than the poem on the wrath of Achilles, and thus in addition to the "Homeric" and "post-Homeric" matter he distinguished a "pre-Homeric" element.

The conjectures of Hermann, in which the Wolfian theory found a modified and tentative application, were presently thrown into the shade by the more trenchant method of Lachmann, who (in two papers read to the Berlin Academy in 1837 and 1841) sought to show that the *Iliad* was made up of sixteen independent "lays," with various enlargements and interpolations, all finally reduced to order by Peisistratus. The first book, for instance, consists of a lay on the anger of Achilles (1-347), and two continuations, the return of Chryseis (430-492) and the scenes in Olympus (548-629, 693-611). The second book forms a second lay, but several passages, among them the speech of Ulysses (278-332), are interpolated. In the third book the scenes in which Helen and Priam take part (including the making of the truce) are pronounced to be interpolations; and so on. Regarding the evidence on which these sweeping results are founded, opinions will vary. The degree of smoothness or consistency which is to be expected on the hypothesis of a single author will be determined by taste rather than argument. The dissection of the first book, for instance, turns partly on a chronological inaccuracy which might well escape the poet as well as his hearers. In examining such points we are apt to forget that the contradictions by which a story is shown to be untrue are quite different from those by which a confessedly untrue story would be shown to be the work of different authors.

Structure of the Iliad.—The subject of the *Iliad*, as the first line proclaims, is the "anger of Achilles." The manner in which this subject is worked out will appear from the following summary in which we distinguish (1) the plot, *i.e.* the story of the quarrel, (2) the main course of the war, which forms a sort of underplot, and (3) subordinate episodes.

- I. Quarrel of Achilles with Agamemnon and the Greek army.—Agamemnon, having been compelled to give up his prize Chryseis, takes Briseis from Achilles.—Thereupon Achilles appeals to his mother Thetis, who obtains from Zeus a promise that he will give victory to the Trojans until the Greeks pay due honour to her son.—Meanwhile Achilles takes no part in the war.
- II. Agamemnon is persuaded by a dream sent from Zeus to take the field with all his forces.
His attempt to test the temper of the army nearly leads to their return.
Catalogue of the army (probably a later addition).
- III. Trojan muster—Trojan catalogue.
Meeting of the Armies—Paris challenges Menelaus—Truce made.
"Teichoscopy," Helen pointing out to Priam the Greek leaders.
- IV. The duel—Paris is saved by Aphrodite.
Truce broken by Pandarus.
Advance of the armies—Battle.
- V. Aristeia of Diomedes—his combat with Aphrodite
- VI. —Meeting with Glaucus—Visit of Hector to the city, and offering of a peplos to Athena.
- (1-311)
(312-529)
VII. Visit of Hector to Paris—to Andromache.
Return of Hector and Paris to the field.
Duel of Ajax and Hector.
Truce for burial of dead.
- VIII. The Greeks build a wall round their camp.
Battle—The Trojans encamp on the field.

- LX. Agamemnon sends an embassy by night, offering Achilles restitution and full amends—Achilles refuses.
- X. Doloneia—Night expedition of Odysseus and Diomedes (in all probability added later).
- XI. Aristeia of Agamemnon—he is wounded—Wounding of Diomedes and Odysseus.
- Achilles sends Antilochus to inquire about Machaon.
- XII. Storming of the wall—the Trojans reach the ships.
- XIII. Zeus ceases to watch the field—Poseidon secretly comes to the aid of the Greeks.
- XIV. Sleep of Zeus, by the contrivance of Hera.
- XV. Zeus awakened—Restores the advantage to the Trojans—Ajax alone defends the ships.
- XVI. Achilles is persuaded to allow Patroclus to take the field. Patroclus drives back the Trojans—kills Sarpedon—he is himself killed by Hector.
- XVII. Battle for the body of Patroclus—Aristeia of Menelaus.
- XXVIII. News of the death of Patroclus is brought to Achilles—Thetis comes with the Nereids—promises to obtain new armour for him from Hephaestus. The shield of Achilles described.
- XIX. Reconciliation of Achilles—His grief and desire to avenge Patroclus.
- XX. The gods come down to the plain—Combat of Achilles with Aeneas and Hector, who escape.
- XXI. The Scamander is choked with slain—rises against Achilles, who is saved by Hephaestus.
- XXII. Hector alone stands against Achilles—his flight round the walls—he is slain.
- XXIII. Burial of Patroclus—Funeral games.
- XXIV. Priam ransoms the body of Hector—his burial.

Such is the "action" (*πρᾶξις*) which in Aristotle's opinion showed the superiority of Homer to all later epic poets. But the proof that his scheme was the work of a great poet does not depend merely upon the artistic unity which excited the wonder of Aristotle. A number of separate "lays" might conceivably be arranged and connected by a man of poetical taste in a manner that would satisfy all requirements. In such a case, however, the connecting passages would be slight and weak. Now, in the *Iliad* these passages are the finest and most characteristic. The element of connexion and unity is the story of the "wrath of Achilles"; and we have only to look at the books which give the story of the wrath to see how essential they are. Even if the ninth book is rejected (as Grote proposed), there remain the speeches of the first, sixteenth and nineteenth books. These speeches form the cardinal points in the action of the *Iliad*—the framework into which everything else is set; and they have also the best title to the name of Homer.

The further question, however, remains,—What shorter narrative piece fulfilling the conditions of an independent poem has Lachmann succeeded in disengaging from the existing *Iliad*? It must be admitted that when tried by this test his "lays" generally fail. The "quarrel of the chiefs," the "muster of the army," the "duel of Paris and Menelaus," &c., are excellent beginnings, but have no satisfying conclusion. And the reason is not far to seek. The *Iliad* is not a history, nor is it a series of incidents in the history, of the siege. It turns entirely upon a single incident, occupying a few days only. The several episodes of the poem are not so many distinct stories, each with an interest of its own. They are only parts of a single main event. Consequently the type of epic poem which would be produced by an aggregation of shorter lays is not the type which we have in the *Iliad*. Rather the *Iliad* is itself a single lay which has grown with the growth of poetical art to the dimensions of an epic.

But the original nucleus and parts of the incidents may be the work of a single great poet, and yet other episodes may be of different authorship, wrought into the structure of the poem in later times. Various theories have been based on this supposition. Grote in particular held that the original poem, which he called the *Achilleids*, did not include books ii.-vii., ix., x., xxiii., xxiv. Such a view may be defended somewhat as follows.

Of the books which relate the events during the absence of Achilles from the Greek ranks (ii.-xv.), the last five are directly related to the main action. They describe the successive steps by which the Greeks are driven back, first from the plain to the rampart, then to their ships. Moreover, three of the chief heroes, Agamemnon, Diomedes, and Ulysses, are wounded, and

this circumstance, as Lachmann himself admitted, is steadily kept in mind throughout. It is otherwise with the earlier books (especially ii.-vii.). The chief incidents in that part of the poem—the panic rush to the ships, the duels of Paris and Menelaus, and of Hector and Ajax, the Aristeia of Diomedes—stand in no relation to the mainspring of the poem, the promise made by Zeus to Thetis. It is true that in the thirteenth and fourteenth books the purpose of Zeus is thwarted for a time by other gods; but in books ii.-vii. it is not so much thwarted as ignored. Further, the events follow without sufficient connexion. The truce of the third book is broken by Pandarus, and Agamemnon passes along the Greek ranks with words of encouragement, but without a hint of the treachery just committed. The Aristeia of Diomedes ends in the middle of the sixth book; he is uppermost in all thoughts down to ver. 311, but from this point, in the meetings of Hector with Helen and Andromache, and again in the seventh book when Hector challenges the Greek chiefs, his prowess is forgotten. Once more, some of the incidents seem to belong properly to the beginning of the war. The joy of Menelaus on seeing Paris, Priam's ignorance of the Greek leaders, the speeches of Agamemnon in his review of the ranks (in book iv.), the building of the wall—all these are in place after the Greek landing, but hardly in the ninth year of the siege.

On the other hand, it may be said, the second book opens with a direct reference to the events of the first, and the mention of Achilles in the speech of Thersites (ii. 239 sqq.) is sufficient to keep the main course of events in view. The Catalogue is connected with its place in the poem by the lines about Achilles (686-694). When Diomedes is at the height of his Aristeia Helenus says (*Il.* vi. 99), "We did not so fear even Achilles." And when in the third book Priam asks Helen about the Greek captains, or when in the seventh book nine champions come forward to contend with Hector, the want of the greatest hero of all is sufficiently felt. If these passages do not belong to the period of the wrath of Achilles, how are we to account for his conspicuous absence?

Further, the want of smoothness and unity which is visible in this part of the *Iliad* may be due to other causes than difference of date or authorship. A national poet such as the author of the *Iliad* cannot always choose or arrange his matter at his own will. He is bound by the traditions of his art, and by the feelings and expectations of his hearers. The poet who brought the exploits of Diomedes into the *Iliad* doubtless had his reasons for doing so, which were equally strong whether he was the poet of the Achilleids or a later Homerid or rhapsodist. And if some of the incidents (those of the third book in particular) seem to belong to the beginning of the war, it must be considered that poetically, and to the hearers of the *Iliad*, the war opens in the third book, and the incidents are of the kind that is required in such a place. The truce makes a pause which heightens the interest of the impending battle; the duel and the scene on the walls are effective in bringing some of the leading characters on the stage, and in making us acquainted with the previous history. The story of Paris and Helen especially, and the general position of affairs in Troy, is put before us in a singularly vivid manner. The book in short forms so good a *prologue* to the action of the war that we can hardly be wrong in attributing it to the genius which devised the rest of the *Iliad*.

The case against the remaining books is of a different kind. The ninth and tenth seem like two independent pictures of the night before the great battle of xi.-xvii. Either is enough to fill the space in Homer's canvas; and the suspicion arises (as when two Platonic dialogues bear the same name) that if either had been genuine, the other would not have come into existence. If one of the two is to be rejected it must be the tenth, which is certainly the less Homeric. It relates a picturesque adventure, conceived in a vein more approaching that of comedy than any other part of the *Iliad*. Moreover, the language in several places exhibits traces of post-Homeric date. The ninth book, on the other hand, was rejected by Grote, chiefly on the grounds that the embassy to Achilles ought to have put an end to the quarrel, and that it is ignored in later passages, especially in the speeches

of Achilles (xi. 609; xvi. 72, 85). His argument, however, rests on an assumption which we are apt to bring with us to the reading of the *Iliad*, but which is not borne out by its language, viz. that there was some definite atonement demanded by Achilles, or due to him according to the custom and sentiment of the time. But in the *Iliad* the whole stress is laid on the anger of Achilles, which can only be satisfied by the defeat and extreme peril of the Greeks.¹ He is influenced by his own feeling, and by nothing else. Accordingly, in the ninth book, when they are still protected by the rampart (see 348 sqq.), he rejects gifts and fair words alike; in the sixteenth he is moved by the tears and entreaties of Patroclus, and the sight of the Greek ships on fire; in the nineteenth his anger is quenched in grief. But he makes no conditions, either in rejecting the offers of the embassy or in returning to the Greek army. And this conduct is the result, not only of his fierce and inexorable character, but also (as the silence of Homer shows) of the want of any general rules or principles, any code of morality or of honour, which would have required him to act in a different way.

Finally, Grote objected to the two last books that they prolong the action of the *Iliad* beyond the exigencies of a coherent scheme. Of the two, the twenty-third could more easily be spared. In language, and perhaps in style and manner, it is akin to the tenth; while the twenty-fourth is in the pathetic vein of the ninth, and like it serves to bring out new aspects of the character of Achilles.

Dr E. Kammer has given some strong reasons for doubting the genuineness of the passage in book xx. describing the duel between Achilles and Aeneas (79-352). The incident is certainly very much out of keeping with the vehement action of that part of the poem, and especially with the moment when Achilles returns to the field, eager to meet Hector and avenge the death of his friend. The interpolation (if it is one) is probably due to local interests. It contains the well-known prophecy that the descendants of Aeneas are to rule over the Trojans,—pointing to the existence of an Aenead dynasty in the Troad. So, too, the legend of Anchises in the Hymn to Aphrodite is evidently local; and Aeneas becomes more prominent in the later epics, especially the *Cypris* and the *Ilion stips* of Arctinus.

Structure of the Odyssey.—In the *Odyssey*, as in the *Iliad*, the events related fall within a short space of time. The difficulty of adapting the long wanderings of Ulysses to a plan of this type is got over by the device—first met with in the *Odyssey*—of making the hero tell the story of his own adventures. In this way the action is made to begin almost immediately before the actual return of Ulysses. Up to the time when he reaches Ithaca it moves on three distinct scenes: we follow the fortunes of Ulysses, of Telemachus on his voyage in the Peloponnesus, and of Penelope with the suitors. The art with which these threads are woven together was recognized by Wolf himself, who admitted the difficulty of applying his theory to the "admirabilis summa et compages" of the poem. Of the comparatively few attempts which have been made to dissect the *Odyssey*, the most moderate and attractive is that of Professor A. Kirchhoff of Berlin.²

According to Kirchhoff, the *Odyssey* as we have it is the result of additions made to an original nucleus. There was first of all a "Return of Odysseus," relating chiefly the adventures with the Cyclops, Calypso and the Phaeacians; then a continuation, the scene of which lay in Ithaca, embracing the bulk of books xiii.-xxiii. The poem so formed was enlarged at some time between Ol. 30 and Ol. 50 by the stories of books x.-xii. (Circe, the Sirens, Scylla, &c.), and the adventures of Telemachus. Lastly, a few passages were interpolated in the time of Peisistratus.

The proof that the scenes in Ithaca are by a later hand than the ancient "Return" is found chiefly in a contradiction discussed by Kirchhoff in his sixth dissertation (pp. 135 sqq., ed. 1869). Sometimes Ulysses is represented as aged and worn by toil, so that Penelope, for instance, cannot recognize him; sometimes he is really in the prime of heroic vigour, and his appearing as a beggarly old man is the work of Athena's wand. The first of these representations is evidently natural, considering the twenty eventful years that have passed; but the second, Kirchhoff holds, is the Ulysses of Calypso's

island and the Phaeacian court. He concludes that the aged Ulysses belongs to the "continuation" (the change wrought by Athena's wand being a device to reconcile the two views), and hence that the continuation is the work of a different author.

Ingenious as this is, there is really very slender ground for Kirchhoff's thesis. The passages in the second half of the *Odyssey* which describe the appearance of Ulysses do not give two well-marked representations of him. Sometimes Athena disguises him as a decrepit beggar, sometimes she bestows on him supernatural beauty and vigour. It must be admitted that we are not told exactly how long in each case the effect of these changes lasted. But neither answers to his natural appearance, or to the appearance which he is imagined to present in the earlier books. In the palace of Alcinoüs, for instance, it is noticed that he is vigorous but "marred by many ills" (*Od.* viii. 137); and this agrees with the scenes of recognition in the latter part of the poem.

The arguments by which Kirchhoff seeks to prove that the stories of books x.-xii. are much later than those of book ix. are not more convincing. He points out some resemblances between these three books and the Argonautic fables, among them the circumstance that a fountain Artacia occurs in both. In the Argonautic story this fountain is placed in the neighbourhood of Cyzicus, and answers to an actual fountain known in historical times. Kirchhoff argues that the Artacia of the Argonautic story must have been taken from the real Artacia, and the Artacia of the *Odyssey* again from that of the Argonautic story. And as Cyzicus was settled from Miletus, he infers that both sets of stories must be comparatively late. It is more probable, surely, that the name Artacia occurred independently (as most geographical names are found to occur) in more than one place. Or it may be that the Artacia of the *Odyssey* suggested the name to the colonists of Cyzicus, whence it was adopted into the later versions of the Argonautic story. The further argument that the *Nostoi* recognized a son of Calypso by Ulysses but no son of Circe, consequently that Circe was unknown to the poet of the *Nostoi*, rests (in the first place) upon a conjectural alteration of a passage in Eustathius, and, moreover, has all the weakness of an argument from silence, in addition to the uncertainty arising from our very slight knowledge of the author whose silence is in question. Finally, when Kirchhoff finds traces in books x.-xii. of their having been originally told by the poet himself instead of being put in the mouth of his hero, we feel that inaccuracies of this kind are apt to creep in wherever a fictitious story is thrown into the form of an autobiography.

Inquiries conducted with the refinement which characterizes those of Kirchhoff are always instructive, and his book contains very many just observations; but it is impossible to admit his main conclusions. And perhaps we may infer that no similar attempt can be more successful. It does not indeed follow that the *Odyssey* is free from interpolations. The *Nestus* of book xi. may be later (as Lauer maintained), or it may contain additions, which could easily be inserted in a description of the kind. And the last book is probably by a different hand, as the ancient critics believed. But the unity of the *Odyssey* as a whole is apparently beyond the reach of the existing weapons of criticism.

Chorizontes.—When we are satisfied that each of the great Homeric poems is either wholly or mainly the work of a single poet, a question remains which has been matter of controversy in ancient as well as modern times—Are they the work of the same poet? Two ancient grammarians, Xenodorus and Hellanicus, were known as the "separators" (*oi χωρίζοντες*); and Aristarchus appears to have written a treatise against their heresy. In modern times some of the greatest names have been on the side of the "Chorizontes."

If, as has been maintained in the preceding pages, the external evidence regarding Homer is of no value, the problem now before us may be stated in this form: Given two poems of which nothing is known except that they are of the same school of poetry, what is the probability that they are by the same author? We may find a fair parallel by imagining two plays drawn at hazard from the works of the great tragic writers. It is evident that the burden of proof would rest with those who held them to be by the same hand.

The arguments used in this discussion have been of very various calibre. The ancient Chorizontes observed that the messenger of Zeus is Iris in the *Iliad*, but Hermes in the *Odyssey*; that the wife of Hephaestus is one of the Charites in the *Iliad*, but Aphrodite in the *Odyssey*; that the heroes in the *Iliad* do not eat fish; that Crete has a hundred cities according to the *Iliad*, and only ninety according to the *Odyssey*; that *πρωτόγονοι* is used in the *Iliad* of place, in the *Odyssey* of time, &c. Modern scholars have added to the list, especially by making careful comparisons of the two poems in respect of vocabulary and

¹ On this point see a paper by Professor Packard in the *Trans. of the American Philological Association* (1876).

² *Die Composition der Odyssee* (Berlin, 1869). A full discussion of this book is given by Dr E. Kammer, *Die Einheit der Odyssee* (Leipzig, 1873).

grammatical forms. Nothing is more difficult than to assign the degree of weight to be given to such facts. The difference of subject between the two poems is so great that it leads to the most striking differences of detail, especially in the vocabulary. For instance, the word φόβος, which in Homer means "flight in battle" (not "fear"), occurs thirty-nine times in the *Iliad*, and only once in the *Odyssey*; but then there are no battles in the *Odyssey*. Again, the verb ἄγγυμι, "to break," occurs forty-eight times in the *Iliad*, and once in the *Odyssey*,—the reason being that it is constantly used of breaking the armour of an enemy, the gate of a city, the hostile ranks, &c. Once more, the word ἄντρος, "darkness," occurs fourteen times in the *Iliad*, once in the *Odyssey*. But in every one of the fourteen places it is used of "darkness" coming over the sight of a fallen warrior. On the other side, if words such as δαδάμωτος, "a bath," χέρριψι, "a basin for the hands," λέσχη, "a place to meet and talk," &c., are peculiar to the *Odyssey*, we have only to remember that the scene in the *Iliad* is hardly ever laid within any walls except those of a tent. These examples will show that mere statistics of the occurrence of words prove little, and that we must begin by looking to the subject and character of each poem. When we do so, we at once find ourselves in the presence of differences of the broadest kind. The *Iliad* is much more historical in tone and character. The scene of the poem is a real place, and the poet sings (as Ulysses says of Demodocus) as though he had been present himself, or had heard from one who had been. The supernatural element is confined to an interference of the gods, which to the common eye hardly disturbs the natural current of affairs. The *Odyssey*, on the contrary, is full of the magical and romantic—"speciosa miracula," as Horace called them. Moreover, these marvels—which in their original form are doubtless as old as anything in the *Iliad*, since in fact they are part of the vast stock of popular tales (*Märchen*) diffused all over the world—are mixed up in the *Odyssey* with the heroes of the Trojan war. This has been especially noticed in the case of the story of Polyphemus, one that is found in many countries, and in versions which cannot all be derived from Homer. W. Grimm has pointed out that the behaviour of Ulysses in that story is senseless and foolhardy, utterly beneath the wise and much-enduring Ulysses of the Trojan war. The reason is simple; he is not the Ulysses of the Trojan war, but a being of the same world as Polyphemus himself—the world of giants and ogres. The question then is—How long must the name of Ulysses have been familiar in the legend (*Sage*) of Troy before it made its way into the tales of giants and ogres (*Märchen*), where the poet of the *Odyssey* found it?

Again, the Trojan legend has itself received some extension between the time of the *Iliad* and that of the *Odyssey*. The story of the Wooden Horse is not only unknown to the *Iliad*, but is of a kind which we can hardly imagine the poet of the *Iliad* admitting. The part taken by Neoptolemus seems also to be a later addition. The tendency to amplify and complete the story shows itself still more in the Cyclic poets. Between the *Iliad* and these poets the *Odyssey* often occupies an intermediate position.

This great and significant change in the treatment of the heroic legends is accompanied by numerous minor differences (such as the ancients remarked) in belief, in manners and institutions, and in language. These differences bear out the inference that the *Odyssey* is of a later age. The progress of reflection is especially shown in the higher ideas entertained regarding the gods. The turbulent Olympian court has almost disappeared. Zeus has acquired the character of a supreme moral ruler; and although Athena and Poseidon are adverse influences in the poem, the notion of a direct contest between them is scrupulously avoided. The advance of morality is shown in the more frequent use of terms such as "just" (δικαίος), "piety" (δολή), "insolence" (ἕβρις), "god-fearing" (θεοφύσις), "pure" (ἀγνός); and also in the plot of the story, which is distinctly a contest between right and wrong. In matters bearing upon the arts of life it is unsafe to press the silence of the *Iliad*. We may note, however,

the difference between the house of Priam, surrounded by distinct dwellings for his many sons and daughters, and the houses of Ulysses and Alcinoüs, with many chambers under a single roof. The singer, too, who is so prominent a figure in the *Odyssey* can hardly be thought to be absent from the *Iliad* merely because the scene is laid in a camp.

Style of Homer.—A few words remain to be said on the style and general character of the Homeric poems, and on the comparisons which may be made between Homer and analogous poetry in other countries.

The cardinal qualities of the style of Homer have been pointed out once for all by Matthew Arnold. "The translator of Homer," he says, "should above all be penetrated by a sense of four qualities of his author—that he is eminently rapid; that he is eminently plain and direct, both in the evolution of his thought and in the expression of it, that is, both in his syntax and in his words; that he is eminently plain and direct in the substance of his thought, that is, in his matter and ideas; and, finally, that he is eminently noble" (*On Translating Homer*, p. 9).

The peculiar rapidity of Homer is due in great measure to his use of the hexameter verse. It is characteristic of early literature that the evolution of the thought—that is, the grammatical form of the sentence—is guided by the structure of the verse; and the correspondence which consequently obtains between the rhythm and the grammar—the thought being given out in lengths, as it were, and these again divided by tolerably uniform pauses—produces a swift flowing movement, such as is rarely found when the periods have been constructed without direct reference to the metre. That Homer possesses this rapidity without falling into the corresponding faults—that is, without becoming either "jerky" or monotonous—is perhaps the best proof of his unequalled poetical skill. The plainness and directness, both of thought and of expression, which characterize Homer were doubtless qualities of his age; but the author of the *Iliad* (like Voltaire, to whom Arnold happily compares him) must have possessed the national gift in a surpassing degree. The *Odyssey* is in this respect perceptibly below the level of the *Iliad*.

Rapidity or ease of movement, plainness of expression and plainness of thought, these are not the distinguishing qualities of the great epic poets—Virgil, Dante, Milton. On the contrary, they belong rather to the humbler epico-lyrical school for which Homer has been so often claimed. The proof that Homer does not belong to that school—that his poetry is not in any true sense "ballad-poetry"—is furnished by the higher artistic structure of his poems (already discussed), and as regards style by the fourth of the qualities distinguished by Arnold—the quality of nobleness. It is his noble and powerful style, sustained through every change of idea and subject, that finally separates Homer from all forms of "ballad-poetry" and "popular epic."¹

But while we are on our guard against a once common error, we may recognize the historical connexion between the *Iliad* and *Odyssey* and the "ballad" literature which undoubtedly preceded them in Greece. It may even be admitted that the swift-flowing movement, and the simplicity of thought and style, which we admire in the *Iliad* are an inheritance from the earlier "lays"—the κλέα ἀνδρῶν such as Achilles and Patroclus sang to the lyre in their tent. Even the metre—the hexameter verse—may be assigned to them. But between these lays and Homer we must place the cultivation of epic poetry as an art.² The pre-Homeric lays doubtless furnished the elements of such a poetry—the alphabet, so to speak, of the art; but they must have been refined and transmuted before they formed poems like the *Iliad* and *Odyssey*.

A single example will illustrate this. In the scene on the walls of Troy, in the third book of the *Iliad*, after Helen has pointed out Agamemnon, Ulysses and Ajax in answer to Priam's

¹ "As a poet Homer must be acknowledged to excel Shakespeare in the truth, the harmony, the sustained grandeur, the satisfying completeness of his images" (Shelley, *Essays*, &c., i. 31, ed. 1852).

² "The old English balladist may stir Sir Philip Sidney's heart like a trumpet, and this is much; but Homer, but the few artists in the grand style, can do more—they can refine the raw natural man, they can transmute him" (*On Translating Homer*, p. 61).

questions, she goes on unmasked to name Idomeneus. Lachmann, whose mind is full of the ballad manner, fastens upon this as an irregularity. "The unskilful transition from Ajax to Idomeneus, about whom no question had been asked," he cannot attribute to the original poet of the lay (*Betrachtungen*, p. 15, ed. 1865). But, as was pointed out by A. Römer¹ this is exactly the variation which a poet would introduce to relieve the primitive ballad-like sameness of question and answer; and moreover it forms the transition to the lines about the Dioscuri by which the scene is so touchingly brought to a close.

Analogies.—The development of epic poetry (properly so called) out of the oral songs or ballads of a country is a process which in the nature of things can seldom be observed. It seems clear, however, that the hypothesis of epics such as the *Iliad* and *Odyssey* having been formed by putting together or even by working up shorter poems finds no support from analogy.

Narrative poetry of great interest is found in several countries (such as Spain and Servia), in which it has never attained to the epic stage. In Scandinavia, in Lithuania, in Russia, according to Gaston Paris (*Histoire poétique de Charlemagne*, p. 9), the national songs have been arrested in a form which may be called intermediate between contemporary poetry and the epic. The true epics are those of India, Persia, Greece, Germany, Britain and France. Most of these, however, fail to afford any useful points of comparison, either from their utter unlikeness to Homer, or because there is no evidence of the existence of anterior popular songs. The most instructive, perhaps the only instructive, parallel is to be found in the French "chansons de geste," of which the *Chanson de Roland* is the earliest and best example. These poems are traced back with much probability to the 10th century. They are epic in character, and were recited by professional *jongleurs* (who may be compared to the *daoud* of Homer). But as early as the 7th century we come upon traces of short lays (the so-called *cantilènes*) which were in the mouths of all and were sung in chorus. It has been held that the *chansons de geste* were formed by joining together "bunches" of these earlier *cantilènes*, and this was the view taken by Léon Gautier in the first edition of *Les Épopées françaises* (1865). In the second edition, of which the first volume appeared in 1878, he abandoned this theory. He believes that the epics were generally composed under the influence of earlier songs. "Our first epic poets," he says, "did not actually and materially patch together pre-existent *cantilènes*. They were only inspired by these popular songs; they only borrowed from them the traditional and legendary elements. In short, they took nothing from them but the ideas, the spirit, the life; they 'found' (ils ont trouvé) all the rest" (p. 80). But he admits that "some of the old poems may have been borrowed from tradition, without any intermediary" (*ibid.*); and when it is considered that the traces of the "*cantilènes*" are slight, and that the degree in which they inspired the later poetry must be a matter of impression rather than of proof, it does not surprise us to find other scholars (notably Paul Meyer) attaching less importance to them, or even doubting their existence.²

When Léon Gautier shows how history passes into legend, and legend again into romance, we are reminded of the difference

¹ *Die exegetischen Scholien der Ilias*, p. vii.

² "On comprend que des chants populaires nés d'un événement éclatant, victorieux ou défaits, puissent contribuer à former la tradition, à en arrêter les traits; ils peuvent aussi devenir le centre de légendes qui se forment pour les expliquer; et de la sorte leur substance au moins arrive au poète épique qui l'introduit dans sa composition. Voilà ce qui a pu se produire pour des chants très-courts, dont il est d'ailleurs aussi difficile d'affirmer que de nier l'existence. Mais on peut expliquer la formation des *chansons de geste* par une autre hypothèse" (Meyer, *Recherches sur l'épopée française*, p. 65). "Ce qui a fait naître la théorie des chants 'lyrico-épiques' ou des *cantilènes*, c'est le système de Wolf sur les poèmes homériques, et de Lachmann sur les *Nibelungen*. Mais, au moins en ce qui concerne ce dernier poème, le système est détruit. . . . On tire encore argument des romances espagnoles, qui, dit-on, sont des '*cantilènes*' non encore arrivées à l'épopée. . . . Et c'est le malheur de cette théorie: faute de preuves directes, elle cherche des analogies au dehors; en Espagne, elle trouve des '*cantilènes*,' mais pas d'épopée; en Allemagne, une épopée, mais pas de *cantilènes*!" (*Ibid.* p. 66).

noticed above between the *Iliad* and the *Odyssey*, and between Homer and the early Cyclic poems. And the peculiar degradation of Homeric characters which appears in some poets (especially Euripides) finds a parallel in the later *chansons de geste*.³

The comparison of Homer with the great literary epics calls for more discursive treatment than would be in place here. Some external differences have been already indicated. Like the French epics, Homeric poetry is indigenous, and is distinguished by this fact, and by the ease of movement and the simplicity which result from it, from poets such as Virgil, Dante and Milton. It is also distinguished from them by the comparative absence of underlying motives or sentiment. In Virgil's poetry a sense of the greatness of Rome and Italy is the leading motive of a passionate rhetoric, partly veiled by the "chosen delicacy" of his language. Dante and Milton are still more faithful exponents of the religion and politics of their time. Even the French epics are pervaded by the sentiment of fear and hatred of the Saracens. But in Homer the interest is purely dramatic. There is no strong antipathy of race or religion; the war turns on no political event; the capture of Troy lies outside the range of the *Iliad*. Even the heroes are not the chief national heroes of Greece. The interest lies wholly (so far as we can see) in the picture of human action and feeling.

BIBLIOGRAPHY.—A complete bibliography of Homer would fill volumes. The following list is intended to include those books only which are of first-rate importance.

The *editio princeps* of Homer, published at Florence in 1488, by Demetrius Chalcondylas, and the Aldine editions of 1504 and 1517, have still some value beyond that of curiosity. The chief modern critical editions are those of Wolf (Halle, 1794-1795; Leipzig, 1804-1807); Spitzner (Gotha, 1832-1836); Bekker (Berlin, 1843; Bonn, 1858); La Roche (*Odyssey*, 1867-1868; *Iliad*, 1873-1876, both at Leipzig); Ludwig (*Odyssey*, Leipzig, 1889-1891; *Iliad*, 2 vols., 1901 and 1907); W. Leaf (*Iliad*, London, 1886-1888; 2nd ed. 1900-1902); Merry and Riddell (*Odyssey* I-xii., 2nd ed., Oxford, 1886); Monro (*Odyssey* xiii.-xxiv. with appendices, Oxford, 1901); Monro and Allen (*Iliad*), and Allen (*Odyssey*, 1908, Oxford). The commentaries of Barnes, Clarke and Ernesti are practically superseded; but Heyne's *Iliad* (Leipzig, 1802) and Nitzsch's commentary on the *Odyssey* (books I-xii., Hanover, 1826-1840) are still useful. Nagebach's *Anmerkungen zur Ilias* (A, B 1-483. I) is of great value, especially the third edition (by Autenrieth, Nuremberg, 1864). The unique *Scholium Veneto* on the *Iliad* were first made known by Villosion (*Homeri Ilias ad veteris codicis Veneti fidem recensita, Scholia in eam antiquissima ex eodem codice et alijs nunc primum edita, cum Asteriscis, Obeliscis, alijsque signis criticis*, Joh. Baptista Caspar d'Ansse de Villosion, Venice, 1788); reprinted, with many additions from other MSS., by Bekker (*Scholium in Homeri Iliadem*, Berlin, 1825-1826). A new edition has been published by the Oxford Press (*Scholium Graeca in Homeri Iliadem*, ed. Gul. Dindorfius); six volumes have appeared (1875-1888), the last two edited by Professor E. Maass. The vast commentary of Eustathius was first printed at Rome in 1542; the last edition is that of Stallbaum (Leipzig, 1827). The Scholia on the *Odyssey* were published by Buttman (Berlin, 1821), and with greater approach to completeness by W. Dindorf (Oxford, 1855). Although Wolf at once perceived the value of the Venetian Scholia on the *Iliad*, the first scholar who thoroughly explored them was C. Lehrs (*De Aristarchi studiis Homericis*, Königberg, 1833; 2nd ed., Leipzig, 1865). Of the studies in the same field which have appeared since, the most important are: Aug. Nauck, *Aristophanis Byzantii fragmenta* (Halle, 1848); L. Friedländer, *Aristonici vel epulorum Iliados reliquiae* (Göttingen, 1853); M. Schmidt, *Didymi Chalcenteri fragmenta* (Leipzig, 1854); L. Friedländer, *Nicanoris vel Iliados scripturae reliquiae* (Berlin, 1857); Aug. Lentz, *Herodiani Technici reliquiae* (Leipzig, 1867); J. La Roche, *Die homerische Textkritik im Alterthum* (Leipzig, 1866) and *Homerische Untersuchungen* (Leipzig, 1869); Ad. Kömer, *Die Werke der Aristarcher im Cod. Venet. A.* (Munich, 1875); A. Ludwig, *Aristarch's Homerische Textkritik* (2 vols. Leipzig, 1884-1885); and *Die Homeruloga als vor-Alexandrinisch erweisen* (Leipzig, 1898).

The literature of the "Homeric Question" begins practically with Wolf's *Prolegomena* (Halle, 1795). Of the earlier books Wood's *Essay on the Original Genus and Writings of Homer* is the most interesting. Wolf's views were skillfully popularized in W. Müller's *Homerische Vorschule* (2nd ed., Leipzig, 1836). G. Hermann's dissertations *De interpolationibus Homeri* (1832) and *De iteratis apud Homerum* (1840) are reprinted in his *Opuscula*. Lachmann's two papers (*Betrachtungen über Homers Ilias*) were edited together by M. Haupt (2nd ed., Berlin, 1865). Besides the somewhat voluminous writings of Nitzsch, and the discussions contained in the histories of Greek literature by K. O. Müller, Bernhardt, Ulrich and Th. Bergk, and in Grote's *History of Greece*, see Welcker, *Der epische*

³ A. Lang, *Contemporary Review*, vol. xvii., N.S., p. 588.

Cyclus oder die homerischen Dichter (Bonn, 1835-1849); on Proclus and the Cycle reference may also be made to Wilamowitz-Möllendorf p. 328 seq.; E. Beche, *Rhein. Mus.* (1891), xxvi, p. 593 seq.; O. Immich, *Festschrift Th. Gomperz dargebracht* (1902), p. 237 sq.; Laur, *Geschichte der homerischen Poesie* (Berlin, 1851); Sengenbusch, two dissertations prefixed to the two volumes of W. Dindorf's *Homer in der Teubner series* (1855-1856); Friedländer, *Die homerische Kritik von Wolf bis Grote* (Berlin, 1853); Nutzhorn, *Die Entstehungsweise der homerischen Gedichte, mit Vorwort von J. N. Madvig* (Leipzig, 1869); E. Kammer, *Zur homerischen Frage* (Königsberg, 1870); and *Die Einheit der Odyssee* (Leipzig, 1873); A. Kirchhoff, *Die Composition der Odyssee* (Berlin, 1869); Volkmann, *Geschichte und Kritik der Wolf'schen Prolegomena* (Leipzig, 1874); K. Sittl, *Die Wiederholungen in der Odyssee* (München, 1882); U. v. Wilamowitz-Möllendorf, *Homerische Untersuchungen* (Berlin, 1884); O. Seck, *Die Quellen der Odyssee* (Berlin, 1887); F. Blass, *Die Interpolationen in der Odyssee* (Leipzig, 1905). The interest taken in the question by English students is sufficiently shown in the writings of W. E. Gladstone, F. A. Paley, Henry Hayman (in the Introduction to his *Odyssey*), P. Geddes, R. C. Jebb and A. Lang (see especially the latter's *Homer and his Age*, 1907).

The Homeric dialect must be studied in the books (such as those of G. Curtius) that deal with Greek on the comparative method. The best special work is the brief *Griechische Formenlehre* of H. L. Ahrens (Göttingen, 1852). Other important works are those of Aug. Fick: *Die homerische Odyssee in der ursprünglichen Sprachform wiederhergestellt* (Göttingen, 1883); *Die homerische Ilias* (i-iii., 1886); W. Schulze, *Quaestiones epicae* (Götterslohe, 1892). On Homeric syntax the chief book is B. Delbrück's *Syntactische Forschungen* (Halle, 1871-1879), especially vols. i. and iv.; on metre, &c., Hartel's *Homerische Studien* (i-iii., Vienna); Knös, *De digamma Homericæ quaestiones* (Upsala, 1872-1873-1878); Thumb, *Zur Geschichte des griech. Digamma, Indogermanische Forschungen* (1893), ix, 294 seq. The papers reprinted in Bekker's *Homerische Blätter* (Bonn, 1803-1872) and Cobet's *Miscellanea Critica* (Leiden, 1876) are of the highest value. Hoffmann's *Quaestiones Homericae* (Clausen, 1842) is a useful collection of facts. Buttman's *Lexilogus*, as an example of method, is still worth study.

The antiquities of Homer—using the word in a wide sense—may be studied in the following books: Völcker, *Über homerische Geographie und Weltkunde* (Hanover, 1830); Nägelsbach's *Homerische Theologie* (2nd ed., Nuremberg, 1861); H. Brunn, *Die Kunst bei Homer* (Munich, 1868); W. W. Lloyd, *On the Homeric Design of the Shield of Achilles* (London, 1854); Buchholz, *Die homerischen Realien* (Leipzig, 1871-1873); W. Helbig, *Das homerische Epos aus den Denkmälern erläutert* (Leipzig, 1884; 2nd ed., *ibid.*, 1887); W. Reichel, *Über homerische Waffen* (Vienna, 1894); C. Robert, *Studien zur Ilias* (Berlin, 1901); W. Ridgeway, *The Early Age of Greece* (Cambridge, 1901); V. Bérard, *Les Phéniciens et l'Odyssee* (Paris, 1902-1903); C. Robert, "Topographische Probleme der Ilias," in *Hermes*, xlii, 1907, pp. 78-112.

Among other aids should be mentioned the *Index Homericus* of Seber (Oxford, 1780); Prendergast's *Concordance to the Iliad* (London, 1875); Dunbar's *id.* to the *Odyssey* and *Hymns* (Oxford, 1880); Erhwein's *Verbum Homericum* (Leipzig, 1891); Gehring, *Index Homericus* (Leipzig, 1891); the *Lexicon Homericum*, edited by H. Ebeling (Leipzig, 1880-1885) and the facsimile of the cod. Ven. A (Sijthoff; Leiden, 1901), with an introduction by D. Compagnotti. (D. B. M.)

HOMER, WINSLOW (1836-1910), American painter, was born in Boston, U.S.A., on the 24th of February 1836. At the age of nineteen he was apprenticed to a lithographer. Two years later he opened a studio in Boston, and devoted much of his time to making drawings for wood-engravers. In 1859 he removed to New York, where he studied in the night-school of the National Academy of Design. During the American Civil War he was with the troops at the front, and contributed sketches to *Harper's Weekly*. The war also furnished him with the subjects for the first two pictures which he exhibited (1863), one of which was "Home, Sweet Home." His "Prisoners from the Front"—perhaps his most generally popular picture—was exhibited in New York in 1865, and also in Paris in 1867, where he was spending the year in study. Among his other paintings in oil are "Snap the Whip" (which was exhibited at the Philadelphia Centennial Exhibition of 1876, and, in company with "The Country Schoolroom," at the Paris Salon the following year), "Eating Water-melon," "The Cotton Pickers," "Visit from the Old Mistress, Sunday Morning," "The Life-Line" and "The Coming of the Gale." His genius, however, has perhaps shown better in his works in water-colour, among which are his marine studies painted at Gloucester, Mass., and his "Inside the Bar," "The Voice from the Cliffs" (pictures of English fishermen), "Tynemouth," "Wrecking of a Vessel" and "Lost on the

Grand Banks." His work, which principally consists of *genre* pictures, is characterized by strength, rugged directness and unmistakable freshness and originality, rather than by technical excellence, grace of line or beauty of colour. He was little affected by European influences. His types and scenes, apart from his few English pictures, are distinctly American—soldiers in blue, New England children, negroes in the land of cotton, Gloucester fishermen and stormy Atlantic seas. Besides being a member of the Society of Painters in Water-color, New York, he was elected in 1864 an associate and the following year a member of the National Academy of Design.

HOMESTEAD, a borough of Allegheny county, Pennsylvania, U.S.A., on the Monongahela river, 8 m. S.E. of Pittsburg. Pop. (1890) 7911; (1900) 12,554, of whom 3604 were foreign-born and 640 were negroes; (U.S. census, 1910) 18,713. It is served by the Pennsylvania and the Pittsburg & Lake Erie railways, and by the short Union Railroad, which connects with the Ressemer & Lake Erie and the Wabash railways. The borough has a Carnegie library and the C.M. Schwab Manual Training School. Partly in Homestead but chiefly in the adjoining borough of Munhall (and therefore not reported as in Homestead by the U.S. Census) is one of the largest plants in the United States for the manufacture of steel used in the construction of bridges and steel-frame buildings and of steel armour-plate, and this is its chief industry; among Homestead's other manufactures are glass and fire-bricks. The water-works are owned and operated by the municipality. Homestead was first settled in 1871, and it was incorporated in 1880. In 1892 a labour strike lasting 143 days and one of the most serious in the history of the United States was carried on here by the National Amalgamated Association of Iron and Steel Workers of the United States against the Carnegie Steel Company. The arrival (on the 6th of July) of a force of about 200 Pinkerton detectives from New York and Chicago resulted in a fight in which about 10 men were killed, and to restore order two brigades of the state militia were called out. See STRIKES AND LOCKOUTS.

HOMESTEAD AND EXEMPTION LAWS, laws (principally in the United States) designed primarily either to aid the head of a family to acquire title to a place of residence or to protect the owner against loss of that title through seizure for debt. These laws have all been enacted in America since about the middle of the 19th century, and owe their origin to the demand for a population of the right sort in a new country, to the conviction that the freeholder rather than the tenant is the natural supporter of popular government, to the effort to prevent insolvent debtors from becoming useless members of society, and to the belief that such laws encourage the stability of the family.

By the cessions of several of the older states, and by various treaties with foreign countries, public lands have been acquired for the United States in every state and territory of the Union except the original thirteen, and Maine, Vermont, Kentucky, Tennessee and Texas. For a time they were regarded chiefly as a source of revenue, but about 1820, as the need of revenue for the payment of the national debt decreased and the inhabitants of an increasing number of new states became eager to have the vacant lands within their bounds occupied, the demand that the public lands should be disposed of more in the interest of the settler became increasingly strong, and the homestead idea originated. Until the advent of railways, however, the older states of the North were opposed to promoting the development of the West in this manner, and soon afterwards the Southern representatives in Congress opposed the general homestead bills in the interests of slavery, so that except in isolated cases where settlers were desired to protect some frontier, as in Florida and Oregon, and to a limited extent in the case of the Pre-emption Act of 1841 (see below), the homestead principle was not applied by the national government until the Civil War had begun. A general homestead bill was passed by Congress in 1860, but this was vetoed by President James Buchanan; two years later, however, a similar bill became a law. The act of 1862 originally provided that any citizen of the United States, or applicant for citizenship, who was the head of a family, or

twenty-one years of age, or, if younger, had served not less than fourteen days in the army or navy of the United States during an actual war, might apply for 160 acres or less of unappropriated public lands, and might acquire title to this amount of land by residing upon and cultivating it for five years immediately following, and paying such fees as were necessary to cover the cost of administration; a homestead acquired in this manner was exempted from seizure for any debt contracted prior to the date of issuing the patent. A commutation clause of this act permitted title to be acquired after only six months of residence by paying \$1.25 per acre, as provided in the Pre-emption Act of 1841. Act of 1872, amended in 1901, allows any soldier or seaman, who has served at least ninety days in the army or navy of the United States during the Civil War, the Spanish-American War or in the suppression of the insurrection in the Philippines, and was honourably discharged, to apply for a homestead, and permits the deduction of the time of such service, or, if discharged on account of wounds or other disability incurred in the line of duty, the full term of his enlistment, from the five years otherwise required for perfecting title, except that in any case he shall have resided upon and cultivated the land at least one year before the passing of title. Since 1866 mineral lands have been for the most part excluded from entry as homesteads.

In accordance with the provisions of the homestead law, 718,930 homesteads, containing 96,495,414 acres, were established in forty-two years, and besides this principal act, Congress has passed several minor ones of a like nature, that is, acts designed to benefit the actual settler who improves the land. Thus the Pre-emption Act of 1841 gave to any head of a family or any single person over twenty-one years of age, who was a citizen of the United States or had declared his intention to become one, permission to purchase not to exceed 160 acres of public lands after he had resided upon and improved the same for six months; the Timber-Culture Act of 1873 allowed title to 160 acres of public prairie-land to be given to any one who should plant upon it 40 acres of timber, and keep the same in good growing condition for ten years; and the Desert-Land Act of 1877 gave to any citizen of the United States, or to any person who had declared his intention to become one, the privilege of acquiring title to 640 acres of such public land as was not included in mineral or timber lands, and would not without irrigation produce an agricultural crop, by paying twenty-five cents an acre and creating for the tract an artificial water-supply. These several land acts, however, invited fraud to such an extent that in time they promoted the establishment of large land holdings by ranchmen and others quite as much as they encouraged settlement and cultivation, and so great was this evil that in 1891 the Timber-Culture and Pre-emption Acts were repealed, the total amount of land that could be acquired by any one person under the several land laws was limited to 320 acres, the Desert-Land Act was so amended as to require an expenditure of at least three dollars an acre for irrigation, and the original Homestead Act was so amended as to disqualify any person who was already proprietor of more than 160 acres in any state or Territory of the Union for acquiring any more land under its provisions; and in 1896 a residence of fourteen months was required before permitting commutation or the purchase of title. But even these measures were inadequate to prevent fraud. In 1894 Congress, in what is known as the Carey Act, donated to California, Oregon, Nevada, Washington, Idaho, Montana, Utah, Wyoming, Arizona, New Mexico and the Dakotas so much of 1,000,000 acres each of desert-lands as each should cause to be irrigated, reclaimed and occupied within ten years,¹ not less than 20 acres of each 160 acres to be cultivated by actual settlers; and in several of these states and territories irrigating companies have been formed and land offered to settlers in amounts not exceeding 160 acres to each, on terms requiring the settler to purchase ample and perpetual water-rights. In 1902, Congress appropriated the proceeds of the sales of public lands in these states and territories to form a reclamation fund to be used for

¹ In 1901 it was provided that the ten years should date from the segregation of the lands from the public domain.

the construction and maintenance of irrigation works, and lands reclaimed by this means are open to homestead entries, the entryman being required to pay for the cost of reclamation in ten equal annual instalments without interest. When Texas was admitted to the Union the disposal of its public lands was reserved to the state, and under its laws every person who is the head of a family and without a homestead may acquire title to 160 acres of land by residing upon and improving it for three years; every unmarried man eighteen years of age or over may acquire title to 80 acres in the same way.

A short time before the National Homestead Act for aiding citizens to acquire homesteads went into operation, some of the state legislatures had passed homestead and exemption laws designed to protect homesteads or a certain amount of property against loss to the owners in case they should become insolvent debtors, and by the close of the century the legislature of nearly every state in the Union had passed a law of this nature. These laws vary greatly. In most states the exemption of a homestead or other property from liability for debts can be claimed only by the head of a family, but in Georgia it may be claimed by any aged or infirm person, by any trustee of a family of minor children, or by any person on whom any woman or girls are dependent for support; and in California, although the head of a family may claim exemption for a homestead valued at \$5000, any other person may claim exemption for a homestead valued at \$1000. In some states exemptions may be claimed either for a farm limited to 40, 80, 160 or 200 acres, or for a house and one or more lots, usually limited in size, in a town, village or city; in other states the homestead for which exemption may be claimed is limited in value, and this value varies from \$500 to \$5000. With the homestead are usually included the appurtenances thereto, and the courts invariably interpret the law liberally; but many states also exempt a specified amount of personal property, including wearing apparel, furniture, provisions, tools, libraries and in some cases domestic animals and stock in trade. A few states exempt no homestead and only a small amount of personal property; Maryland, for example, exempts only \$100 worth of property besides money payable in the nature of insurance, or for relief, in the event of sickness, injury or death. To some debts the exemption does not usually apply; the most common of these are taxes, purchase money, a debt secured by mortgage on the homestead, and debts contracted in making improvements upon it; in Maryland the only exception is a judgment for breach of promise to marry or in case of seduction. If the homestead belongs to a married person, the consent of both husband and wife is usually required to mortgage it. Finally, some states require that the homestead for which exemption is to be claimed shall be previously entered upon record, others require only occupancy, and still others permit the homestead to be designated whenever a claim is presented.

Following the example of either the United States Congress or the state legislatures, the governments of several British colonial states and provinces have passed homestead laws. In Quebec every settler on public lands is allowed, after receiving a patent, an exemption of not to exceed 200 acres from that of his widow, of his, her or their children and descendants in the direct line. In Ontario an applicant for a homestead may have not to exceed 200 acres of unappropriated public land for farming purposes by building a house thereon, occupying it for five years, and bringing at least fifteen acres under cultivation; the exemption of such a homestead from liability to seizure for debts is, however, limited to twenty years from the date of application for the land, and does not extend even during that period to rates or taxes. Manitoba, British Columbia, Queensland, New South Wales, South Australia, West Australia and New Zealand also have liberal homestead and exemption laws.

See J. B. Sanborn, "Some Political Aspects of Homestead Legislation," in *The American Historical Review* (1900); Edward Manson, "The Homestead Acts," in the *Journal of the Society of Comparative Legislation* (London, 1899); S. D. Thompson, *A Treatise on*

Homesteads and Exemptions (San Francisco, 1886); P. Bureau, *Le Homestead ou l'insaisissabilité de la petite propriété foncière* (Paris, 1894), and L. Vacher, *Le Homestead aux États-Unis* (Paris, 1899).

HOMEYER, KARL GUSTAV (1795-1874), German jurist, was born on the 13th of August 1795 at Wolgast in Pomerania. After studying law at the universities of Berlin, Göttingen and Heidelberg (1813-1817), he settled as a *Privatdocent*, in 1821, at the university of Berlin, where he became ordinary professor of law in 1827. His principal works are his edition of the *Sachsenspiegel* (in 3 vols., 1827, 3rd ed., 1861, containing also some other important sources of Saxon or Low German law), which is still unsurpassed in accuracy and sagacity of research, and his book on *Die Haus- und Hofmarken* (1870), in which he has given a history of the use of trade-marks among all the Teutonic nations of Europe, and which is full of important elucidations of the history of law and also contains valuable contributions to the history of art and civilization. In 1850 Homeyer was elected a member of the Berlin Academy of Sciences, in the *Transactions* of which he published various papers exhibiting profound learning (*Über die Heimas*, 1852; *Genealogie der Handschriften des Sachsenspiegels*, 1859; *Die Stadtbücher des Mittelalters*, 1860; *Der Dreissigste*, 1864, &c.). He died on the 20th of October 1874.

HOMICIDE (Lat. *homicidium*), the general and neutral term for the killing of one human being by another. The nature of the responsibility of the slayer to the state and to the relatives of the slain has been one of the chief concerns of all systems of law from the earliest times, and it has been variously considered from the points of view of the sanctity of human life, the interests of the sovereign, the injury to the family of the slain and the moral guilt, *i.e.* the motives and intentions, of the slayer.

The earliest recorded laws (those of Khammurabi) do not contain any sweeping general provision as to the punishment of homicide. The death penalty is freely imposed but not for homicide. "If a man strike a gentleman's daughter that she dies, his own daughter is to be put to death, if a poor man's the slayer pays $\frac{1}{2}$ mina." In the Mosaic law the general command "Thou shalt not kill" of the Decalogue is in terms absolute. In primitive law homicide, however innocent, subjected the slayer to the lawful vengeance of the kindred of the slain, unless he could make some composition with him. This *lex talionis* (a life for a life) resulted: (1) in a course of private justice which still survives in the vendettas of Corsica and Albania, and the blood feuds arising out of "difficulties" in the southern and western parts of the United States; (2) in the recognition of sanctuaries and cities of refuge within which the avenger of blood might not penetrate to kill an innocent manslayer; and (3) in the system of wite, bote and wer, by which the life of every man had its assessed price payable to his chief and his next of kin.

It took long to induce the relatives of the slain to appreciate anything beyond the fact of the death of their kinsman or to discriminate between intentional and accidental homicide. By the laws of Khammurabi (206, 208) striking a man in a quarrel without deadly intent but with fatal effect was treated as a matter for compensation according to the rank of the slain. The Pentateuch discriminates between the man "who lieth in wait for" or "cometh presumptuously" on "his neighbour to slay him with guile" (Exodus xxi. 13, 14), and the man "who killeth his neighbour ignorantly whom he hated not in time past" (Deut. xix. 4). But even killing by misadventure exposed the slayer to the avenger of blood. "As a man goeth into the wood with his neighbour to hew wood, and his hand fetcheth a stroke with the axe to cut down a tree and the head slippeth from the helve and lighteth upon his neighbour that he die: he shall flee into one of these cities (of refuge) and live" (Deut. xix. 5).

Under the early laws of Teutonic and Celtic communities the inconveniences of the blood feud were gradually mitigated (see CRIMINAL LAW) by the system of wite and wer (or eric),

XIII. 13

but the blood feud continued long in Friesland and Lower Saxony, and in parts of Switzerland until the 16th century. In England under the Norman system homicide became a plea of the crown, and the rights of the kindred to private vengeance and to compensation were gradually superseded in favour of the right of the king to forfeitures where the homicide amounted to a crime (felony).

Though homicide was thus made a public offence and not a matter for private vengeance, it took long to discriminate between those forms of homicide which should and those which should not be punished.

The terms of act in English law used to describe criminal homicide are murder (*word, meurtre, murdrum*), manslaughter and *felo de se* (or suicide by a person of sound mind).

The original meaning of the word "murder" seems to have been secret homicide,—"*Murdrum proprie dicitur mors alicujus occultis cuius interfector ignoratur*" (*Dialogus de Scaccario* i. x.); and Glanville says: *Duo sunt genera homicidii. unum est quod dicitur murdrum quod nullo vidente nullo sciente clam perpetratur, ita quod non assignatur clamor popularis* (hue and cry). *est aliud homicidium quod dicitur simplex homicidium*. After the Conquest, and for the protection of the ruling race, a fine (also called *murdrum*) was levied for the king on the hundred or other district in which a stranger was found dead, if the slayer was not brought to justice and the blood kin of the slain did not present Englishry, there being a presumption (in favour of the Exchequer) that the deceased was a Frenchman. After the assize of Clarendon (1166) the distinction between the killing of Normans and Englishmen gradually evaporated and the term murder came to acquire its present meaning of deliberate as distinct from secret homicide. In 1267 it was provided that the murder fine should not be levied in cases of death by "misadventure" (*per infortunium*).¹ But at that date and for long afterwards homicide in self-defence or by misadventure or even while of unsound mind involved at the least a forfeiture of goods, and required a pardon. These pardons, and restitution of the goods, became a matter of course, and the judges appear at a later date to have been in the habit of directing an acquittal in such cases. But it was not until 1828 that the innocence of excusable homicide was expressly declared. The rule is now expressed in s. 7 of the Offences against the Person Act 1861: "No punishment or forfeiture shall be incurred by any person who shall kill another by misfortune, or in his own defence, or in any other manner without felony."

The further differentiation between different degrees of criminal homicide was marked by legislation of Henry VIII. (1531) taking away benefit of clergy in the case of "wilful murder with malice prepensed" (aforethought), and that phrase is still the essential element in the definition of "wilful murder," which is committed "when a person of sound memory and discretion unlawfully killeth any reasonable creature or being and under the king's peace with malice aforethought either express or implied" (3 Co. Inst. 47). The whole development of the substantive law as to murder rests on judicial rulings as to the meaning of malice prepense coupled with the extrajudicial commentaries of Coke, Hale and Foster; for parliament, though often tempted by bills and codes, has never ventured on a legislative definition. Much discussion has ranged round the phrase "malice aforethought," and it has undoubtedly been expanded by judicial decision so as to create what is described as "constructive" murder. According to the view of the criminal code commissioners of 1879 (*Parl. Pap.*, 1879, c. 23, 45, p. 23) the term "malice aforethought" is now a common name for all the following states of mind:—

1. An intent, preceding the act, to kill or do grievous bodily harm to the person or to any other person;
2. Knowledge that the act done is likely to produce such consequences, whether coupled with an intention to produce them or not;
3. An intent to commit any felony; or
4. An intent to resist an officer of police in the execution of his duty.

¹ See *Select Pleas of Crown*, 1 (Selden Society Publ.); Pollock and Maitland, *Hist. Eng. Law*, ii. 458, 476, 478.

The third form of malice aforethought has been much controverted. When it was first recognized as creating a liability for wilful murder almost all felonies were capital offences: but even at the end of the 17th century Lord Holt expressed a view that it should be limited to felonies involving violence or danger to life, e.g. assault with intent to rob, or setting fire to a dwelling-house. And Sir James Stephen's opinion is that, to justify conviction of murder by an act done with intent to commit a felony, the act done must be one dangerous to life or known to be likely to cause death.

Starting with the definition above given, English law still retains so much of its medieval character as to presume all homicide to be "malicious, and therefore murder, unless it is either justified by the command or permission of the law, excused on the ground of accident or self-preservation, or alleviated into manslaughter by being the involuntary consequence of some act not strictly lawful or occasioned by some sudden and sufficiently violent provocation." The truth of the facts alleged in justification, excuse or alleviation, is for the jury to determine: the question whether if true they support the plea for which they are put forward is for the court.

In the administration of the English criminal law as to homicide the consequences of too strict an adherence to the technical definitions of the offences are avoided (a) by the exercise of the jury of their powers to convict of manslaughter only even in cases where they are directed that the offence is murder or nothing; (b) by the report of the judge as to the particular circumstances of each case in which a conviction of murder has been followed by the statutory sentence of death; (c) by the examination of all the evidence in the case by the Home Office in order to enable the secretary of state to determine whether the prerogative of mercy should be exercised.

Homicide is justifiable and not criminal when the killing is done in the execution of the law. The most important case of justifiable homicide is the execution of a criminal in due course of public justice. This condition is most stringently interpreted. "To kill the greatest of malefactors deliberately, unprovoked, and extrajudicially is murder. . . . And further, if judgment of death be given by a judge not authorized by lawful commission, and execution is done accordingly, the judge is guilty of murder" (Stephen's *Commentaries*, book vi. c. iv.). The execution must be carried out by the proper officer or his deputy: any person executing the sentence without such authority, were it the judge himself, would be guilty of murder. And the sentence must be strictly pursued: to execute a criminal by a kind of death other than that to which he has been judicially condemned is murder.

Homicide committed by an officer of justice in the course of carrying out his duty, as such, is also justifiable; e.g. where a felon resists a legal arrest and is killed in the effort to arrest him (see 2 Pollock and Maitland, 476); where officers in dispersing a riotous assemblage kill any of the mob, &c. (see R101). In these cases the homicide must be shown to have been absolutely necessary. Again, homicide is justifiable if committed in the defence of person or property against forcible and heinous crime, such as murder, violent robbery, rape or burglary. In this connexion there has been much discussion as to whether the person attacked is under a duty to retreat: and in substance the justification depends on the continuous necessity of attack or defence in order to prevent the commission by the deceased of the crime threatened.

Homicide is excusable and not criminal at all when committed either by misadventure or in self-defence. In the former case the homicide is excused; where a man in the course of doing some lawful work, accidentally and without intention kills another, e.g. shooting at a mark and undesignedly hitting and killing a man. The act must be strictly lawful, and death by misadventure in unlawful sports is not a case of excusable homicide. Homicide in self-defence is excusable when the slayer is himself in immediate danger of death, and has done all he could to avoid the assault. Accordingly, if he strikes and kills his assailant after the assault is over, this is not excusable homicide. But if the assault has been premeditated, as in the case of a duel, the death of either

antagonist has under English law always been held to be murder and not excusable homicide. The excuse of self-defence covers the case in which a person in defence of others whom it is his duty to protect—children, wife, master, &c.—kills an assailant. It has been considered doubtful whether the plea of self-defence is available to one who has himself provoked a fray, in the course of which he is so pressed by his antagonist that his only resource is to kill him.

In English law the term "manslaughter" is applied to those forms of homicide which though neither justifiable nor excusable are attended by alleviating circumstances which bring them short of wilful murder. The offence is not defined by statute, but only by judicial rulings. Its punishment is as a maximum penal servitude for life, and as a minimum a fine or recognizances to be of good behaviour. The quantum of punishment between the limits above stated is in the discretion of the court, and not, as under continental codes, with fixed minima; and the offence includes acts and omissions of very varying gravity, from acts which only by the charitable appreciation of a jury fall short of wilful murder, to acts or omissions which can only technically be described as criminal, e.g. where one of two persons engaged in poaching, by pure accident gets caught in a hedge so that his gun goes off and kills his fellow-poacher. This may be described as an extreme instance of "constructive crime."

There are two main forms of "manslaughter"—

1. "Voluntary" homicide under grave and sudden provocation or on a sudden quarrel in the heat of passion, without the slayer taking undue advantage or acting in an unusual manner. The substance of the alleviation of guilt lies in the absence of time for cool reflection or the formation of a premeditated design to kill. Under English law the provocation must be by acts and not by words or gestures, and must be serious and not trivial, and the killing must be immediately after provocation and while the slayer has lost his self-control in consequence of the provocation. The provocation need not be by assault or violence, and perhaps the best-recognized example is the slaying by a husband of a man found committing adultery with the slayer's wife. In the case of a sudden quarrel it does not matter who began or provoked the quarrel. This used to be called "chance medley."

2. "Involuntary" homicide as a result of great rashness or gross negligence in respect of matters involving danger to human life, e.g. in driving trains or vehicles, or in dealing with dangerous weapons, or in performing surgical operations, or in taking care of the helpless.

The innumerable modes in which criminal liability for killing others has been adjudged under the English definitions of murder and manslaughter cannot be here stated, and can only be studied by reference to the judicial decisions collected and discussed in *Russell on Crimes* and other English text-books, and in the valuable work by Mr J. D. Mayne on the criminal law of India, in which the English common law rulings are stated side by side with the terms and interpretations of the Indian penal code. Much labour has been expended by many jurists in efforts to create a scientific and acceptable classification of the various forms of unlawful homicide which shall properly define the cases which should be punishable by law and the appropriate punishment. Their efforts have resulted in the establishment in almost every state except the United Kingdom of statutory definitions of the crime, beginning with the French penal code and going down to the criminal code of Japan. In the case of England, as a result of the labours of Sir James Stephen, a code bill was submitted to parliament in 1878. In 1879 a draft code was prepared by Blackburn, Lush and Barry, and was presented to parliament. It was founded on and prepared with Sir J. Stephen, and is a revision of his digest of the criminal law.

After defining homicide and culpable homicide, the draft code (cl. 174) declares culpable homicide to be murder in the following cases: (a) if the offender means to cause the death of the person killed; (b) if the offender means to cause the person killed any bodily injury which is known to the offender to be likely to cause death, and if the offender, whether he does

or does not mean to cause death, is reckless whether death ensues or not; (c) if the offender means to cause death or such bodily injury as aforesaid to one person, so that if that person be killed the offender would be guilty of murder, and by accident or mistake the offender kills another person though he does not mean to hurt the person killed; (d) if the offender for any unlawful object does an act which he knows or ought to have known to be likely to cause death, and thereby kills any person, though he may have desired that his object should be effected without hurting any one.

Further (cl. 175), it is murder (whether the offender means or not death to ensue, or knows or not that death is likely to ensue) in the following cases:—“(a) if he means to inflict grievous bodily injury for the purpose of facilitating the commission of any of the offences hereinafter mentioned, or the flight of the offender upon the commission or attempted commission thereof, and death ensues from his violence; (b) if he administers any stupefying thing for either of the purposes aforesaid and death ensues from the effects thereof; (c) if he by any means wilfully stops the breath of any person for either of the purposes aforesaid and death ensues from such stopping of the breath.” The following are the offences referred to:—“high treason and other offences against the king’s authority, piracy and offences deemed to be piracy, escape or rescue from prison or lawful custody, resisting lawful apprehension, murder, rape, forcible abduction, robbery, burglary, arson.” Cl. 176 reduces culpable homicide to manslaughter if the person who causes death does so “in the heat of passion caused by sudden provocation”; and “any wrongful act or insult of such a nature as to be sufficient to deprive any ordinary person of the power of self-control may be provocation if the offender acts upon it on the sudden, and before there has been time for his passion to cool. Whether any particular wrongful act or insult amounts to provocation and whether the offender was deprived of self-control shall be questions of fact; but no one shall be deemed to give provocation by doing that which he had a legal right to do, or which the offender incited him to do in order to provide an excuse for killing him or doing grievous bodily harm to any person.” Further, “an arrest shall not necessarily reduce the offence from murder to manslaughter because an arrest was illegal, but if the illegality was known to the offender it may be evidence of provocation”; (cl. 177) “culpable homicide not amounting to murder is manslaughter.”

The definitions embodied in these clauses though not yet accepted by the British legislature, have in substance been embodied in the criminal codes of Canada (1892 ss. 227-230), New Zealand (1893, ss. 163-166), Queensland (1899, ss. 300-305), and Western Australia (1902, ss. 275-280).

From the point of view of civil as distinct from criminal responsibility homicide does not by the common law give any cause of action against the person causing the death of another in favour of the wife or blood relations of the deceased. In early law this was otherwise; and the wer or eric of the deceased came historically before the right of chief or state. But under English law the rights of relations, except by way of appeal for felony,¹ were swept aside in favour of the crown, on the principle that every homicide is presumed felonious (murder) unless the contrary is proved, and that in all cases of homicide not justifiable by law a forfeiture was incurred. The rights of the relatives were also defeated by application of the maxim “*actio personalis moritur cum persona*” (“a personal action dies with the person”) to all proceedings for injury to the person or to reputation. In Scotland the old theory was preserved in the law as to assyement.

In England the law was altered at the instance of Lord Campbell in 1846 (9 & 10 V. c. 93) so as to give a right of a claim by the husband, wife, parent or child of a person killed by a wrongful (or even criminal) act, neglect or default by another which would have given the deceased if he had sur-

¹ Appeals remained in the law till 1819, but were long before this disused. In the middle ages they were used as a means of getting compensation.

vived a cause of action against the wrongdoer. The compensation payable is what the surviving relative has lost by the death, and under the Workmen’s Compensation Act 1906 (in all cases to which it applies) the employer is liable even without negligence to compensate the dependants of an employee killed by an accident arising out of and in the course of the employment; and in such cases even if the death was due to serious and wilful misconduct by the employee, compensation is payable.

In the Indian penal code the definitions of murder are so drawn as to limit the offences to cases where it was actually intended to cause death or bodily injury by the acts or omissions of the slayer, and the definition of culpable homicide short of murder is so drawn as to exclude the forms of unintentional manslaughter due to neglect of duty, e.g. in the conduct of trains or ships or vehicles. This last omission was supplied in 1870. The Indian code does not treat as murder either duelling or helping Hindu widows to commit *suttee* (s. 301, exception 5). In most of the British possessions in Asia and in east Africa the Indian definitions of homicide have been adopted. In the rest of the colonies, except South Africa, the law of homicide depends on the English common law as modified by colonial codes or statutes. In South Africa it rests mainly on the Roman Dutch law.

Europe.—In European codes distinctions corresponding to those of the English law are drawn between premeditated and other forms of criminal homicide; but more elaborate distinctions are drawn between the degrees of deliberation or criminality manifested in the slaying, and the minimum or maximum penalty is varied accordingly.

In the French penal code voluntary homicide is called murder (*meurtre*, art. 295): but if committed with premeditation or lying in wait is styled *assassinat* (*guet-apens*) (296-298). Poisoning (even if the poison is not fatal), is specially punished, as is parricide (on the lines of the obsolete English offence of petty treason), and infanticide, i.e. the killing of newly-born infants. Assassination, poisoning and parricide are at present capital offences; but a bill to abolish the death sentence has been laid before the French parliament.

The German code distinguishes between voluntary homicide which is done with deliberation and such homicide committed without deliberation (ss. 211, 212), and provides for mitigation of punishment where the slaying was provoked without fault in the slayer by any wrongful act or serious insult upon the slayer or his relatives by the slain (213). Parricide and infanticide are specially punished (214, 215), as is killing another person at his express and earnest request (216)—an offence which would in England be murder—and it is a separate offence to cause the death of another, the penalty being increased if the offender was peculiarly bound by office, calling or trade to use a care which he did not use (222).

The Italian code punishes as homicide those who with intention to kill cause the death of another (364). The death penalty is not imposed, but scales of punishment are provided to deal with aggravated forms of the offence. Thus *ergastolo* (penal servitude for life) is the punishment in the case of homicide of ascendants and descendants, or with premeditation, or under the sole impulse of brutal ferocity or with gross cruelty (*gravi servizie*), or by means of arson, inundation, drowning and certain other crimes, or to secure the gains or conceal the commission, or to secure immunity from the consequences, of another crime (366). Personal violence resulting in death inflicted without intention to kill is punishable *minore pena* (368), and it is criminal to cause the death of another by imprudence, negligence or lack of skill in an art or profession (*imprudenza nella propria arte o professione*), or by non-observance of regulations, orders or instructions.

The Spanish code has like those of Italy and France special punishments for parricide (417) and for assassination, in which are included killing for reward or promise of reward or by inundation (418), and for aiding another to commit suicide (421). Both the Italian and the Spanish codes afford a special mitigation

to infanticide committed to avoid dishonour to the mother of the infant or her family.

America.—The most notable difference between England and the United States in regard to the law on this subject is the recognition by state legislation of degrees in murder. English law treats all unlawful killing not reducible to manslaughter as of the same degree of guilt in law. American statutes seek to discriminate for purposes of punishment between the graver and the less culpable forms of murder. Thus an act of the legislature of Pennsylvania (22nd of April 1794) declares "all murder which shall be perpetrated by means of poison or by lying in wait or by any other kind of wilful, deliberate and premeditated killing, or which shall be committed in the perpetration of or attempt to perpetrate any arson, rape, robbery or burglary shall be deemed murder of the first degree; and all other kinds of murder shall be deemed murder of the second degree." This legislation has been copied or adopted in many if not most of the other states. There are also statutory degrees of manslaughter in the legislation of some of the states. The differences of legislation, coupled with the power of the jury in some states to determine the sentence, and the limitations on the right of the judges to comment on the testimony adduced, lead to very great differences between the administration of the law as to homicide in the two countries.

AUTHORITIES.—Stephen, *Hist. Cr. Law, Digest Criminal Law; Russell on Crimes* (7th ed., 1909); Archbold, *Criminal Pleading* (23rd ed., 1905); Bishop, *American Criminal Law* (8th ed.); Pollock and Maitland, *Hist. English Law*; Fike, *History of Crime*. (W. F. C.)

HOMILETICS (Gr. *ὁμιλητικός*, from *ὁμιλέω*, to assemble together), in theology the application of the general principles of rhetoric to the specific department of public preaching. It may be further defined as the science that treats of the analysis, classification, preparation, composition and delivery of sermons. The formation during recent years of such lectureships as the "Lyman Beecher" course at Yale University has resulted in increased attention being given to homiletics, and the published volumes of this series are the best contribution to the subject.

The older literature is cited exhaustively in W. G. Blaikie, *For the Work of the Ministry* (1873); and D. P. Kidder, *Treatise on Homiletics* (1864).

HOMILY, a simple religious address, less elaborate than a sermon, and confining itself to the practical exposition of some ethical topic or some passage of Scripture. The word *ὁμιλία* from *ὁμιλέω* (*ἑμοῦ, ἔμω*), meaning communion, intercourse, and especially interchange of thought and feeling by means of words (conversation), was early employed in classical Greek to denote the instruction which a philosopher gave to his pupils in familiar talk (Xenophon, *Memorabilia*, I. ii. 6. 15). This usage of the word was long preserved (Aelian, *Varia Historia*, iii. 19); and the *ὁμιλίαι* of Acts xx. 11 may safely be taken to assign not only a free and informal but also a didactic character to the apostle Paul's discourse in the upper chamber of Troas, when "he talked a long while, even till break of day." That the "talk" on that occasion partook of the nature of the "exposition" (*ἔκθεσις*) of Scripture, which, undertaken by a priest, elder or other competent person, had become a regular part of the service of the Jewish synagogue,¹ may also with much probability be assumed. The custom of delivering expositions or comments more or less extemporaneous on the lessons of the day at all events passed over soon and readily into the Christian Church, as may be gathered from the first *Apology* (c. 67) of Justin Martyr, where we read that, in connexion with the practice of reading portions from the collected writings of the prophets and from the memoirs of the apostles, it had by that time become usual for the presiding minister to deliver a discourse in which "he admonishes the people, stirring them up to an imitation of the good works which have been brought before their notice." This discourse, from its explanatory character, and from the easy conversational manner of its delivery, was for a long time called *ὁμιλία* rather than *λόγος*: it was regarded as part of

¹ See Philo, *Quod omnis probus liber*, sec. 12 (ed. Mangey ii. 458; cf. ii. 630).

the regular duty of the bishop, but he could devolve it, if he thought fit, on a presbyter or deacon, or even on a layman. An early and well-known instance of such delegation is that mentioned by Eusebius in *Hist. Eccl.* vi. 19) in the case of Origen (216 A.D.).² In course of time the exposition of the lesson for the day came more frequently to assume a more elaborate character, and to pass into the category of a *λόγος* or even *φίλοσοφία* or *φιλοσόφημα*; but when it did so the fact was as far as possible denoted by a change of name, the word *ὁμιλία* being reserved for the expository or exegetical lecture as distinguished from the pulpit oration or sermon.³ While the church of the 3rd and 4th centuries could point to a brilliant succession of great preachers, whose discourses were wont to be taken down in shorthand and circulated among the Christian public as edifying reading, it does not appear that the supply of ordinary homiletical talent kept pace with the rapidity of church extension throughout the Roman empire. In the smaller and remoter communities it not uncommonly happened that the minister was totally unqualified to undertake the work of preaching; and though, as is curiously shown by the case of Rome (Sozomen, *Hist. Eccl.* vii. 19), the regular exposition of the appointed lessons was by no means regarded as part of the necessary business of a church, it was generally felt to be advisable that some provision should be made for the public instruction of congregations. Even in Jerome's time (*De Vir. Ill.* c. 115), accordingly, it had become usual to read, in the regular meetings of the churches which were not so fortunate as to possess a competent preacher, the written discourses of celebrated fathers; and at a considerably later period we have on record the canon of at least one provincial council (that of Vaux, probably the third, held in 529 A.D.), positively enjoining that if the presbyter through any infirmity is unable himself to preach, "homilies of the holy fathers" (*homiliae sanctorum patrum*) are to be read by the deacons. Thus the finally fixed meaning of the word homily as an ecclesiastical term came to be a written discourse (generally possessing the sanction of some great name) read in church by or for the officiating clergyman when from any cause he was unable to deliver a sermon of his own. As the standard of clerical education sank during the dark ages, the habit of using the sermons of others became almost universal. Among the authors whose works were found specially serviceable in this way may be mentioned the Venerable Bede, who is credited with no fewer than 140 homilies in the Basel and Cologne editions of his works, and who certainly was the author of many *Homiliae de Tempore* which were much in vogue during the 8th and following centuries. Prior to Charlemagne it is probable that several other collections of homilies had obtained considerable popularity, but in the time of that emperor these had suffered so many mutilations and corruptions that an authoritative revision was felt to be imperatively necessary. The result was the well-known *Homiliarium*, prepared by Paul Wernfried, otherwise known as Paulus Diaconus (q.v.).⁴ It consists of

² Sozomen (*Hist. Eccl.* vii. 19) mentions that in Alexandria in his day the bishop alone was in the custom of preaching; but this, he implies, was a very exceptional state of matters, dating only from the time of Arius.

³ To the more strictly exegetical lectures the names *ἐκθέσεις*, *ἐκθέματα*, *ἐκθέσεις*, *ἑμοῦ*, were sometimes applied. But as no popular discourse delivered from the pulpit could ever be exclusively expository and as on the other hand every sermon professing to be based on Scripture required to be more or less "exegetical" and "textual," it would obviously be sometimes very hard to draw the line of distinction between *ὁμιλία* and *λόγος*. It would be difficult to define very precisely the difference in French between a "conference" and a "sermon"; and the same difficulty seems to have been experienced in Greek by Photius, who says of the eloquent pulpit orations of Chrysostom, that they were *ὁμιλίας* rather than *λόγος*.

⁴ Manuscript copies are preserved at Heidelberg, Darmstadt, Frankfurt, Giessen, Cassel and other places. It was first printed at Spire in 1482. In the Cologne edition of 1530 the title runs—*Homiliae seu maxis sermones sive conciones ad populum, praesentissimorum ecclesiae doctorum Hieronymi, Augustini, Ambrosii, Gregorii, Origenis, Chrysostomi, Bedae, &c., in hunc ordinem dispositae per Alchwinum levitam, idibus inmensis et Carolo M. Rom. Imp. cui a secretis fuit*. Though thus attributed here to Alcuin, who is known to have revised the *Lectionary* or *Comes Hieronymi*, the compilation

176 homilies arranged in order for all the Sundays and festivals of the ecclesiastical year; and probably was completed before the year 780. Though written in Latin, its discourses were doubtless intended to be delivered in the vulgar tongue; the clergy, however, were often too indolent or too ignorant for this, although by more than one provincial council they were enjoined to exert themselves so that they might be able to do so.¹ Hence an important form of literary activity came to be the translation of the homilies approved by the church into the vernacular. Thus we find Alfred the Great translating the homilies of Bede; and in a similar manner arose Ælfric's Anglo-Saxon *Homilies* and the German *Homiliarium* of Otfried of Weissenburg. Such *Homiliaria* as were in use in England down to the end of the 15th century were at the time of the Reformation eagerly sought for and destroyed, so that they are now extremely rare, and the few copies which have been preserved are generally in a mutilated or imperfect form.²

The *Books of Homilies* referred to in the 35th article of the Church of England originated at a convocation in 1542, at which it was agreed "to make certain homilies for stay of such errors as were then by ignorant preachers sparkled among the people." Certain homilies, accordingly, composed by dignitaries of the lower house, were in the following year produced by the prolocutor; and after some delay a volume was published in 1547 entitled *Certain sermons or homilies appointed by the King's Majesty to be declared and read by all parsons, vicars, or curates every Sunday in their churches where they have cure*. In 1563 a second *Book of Homilies* was submitted along with the 39 Articles to convocation; it was issued the same year under the title *The second Tome of Homilies of such matters as were promised and instituted in the former part of Homilies, set out by the authority of the Queen's Majesty, and to be read in every Parish Church agreeably*. Of the twelve homilies contained in the first book, four (the 1st, 2nd, 3rd and 4th) are probably to be attributed to Cranmer, and one (the 12th) possibly to Latimer; one (the 6th) is by Bonner; another (the 5th) is by John Harpsfield, archdeacon of London, and another (the 11th) by Thomas Becon, one of Cranmer's chaplains. The authorship of the others is unknown. The second book consists of twenty-one homilies, of which the 1st, 2nd, 3rd, 7th, 8th, 9th, 16th and 17th have been assigned to Jewel, the 4th to Grindal, the 5th and 6th to Pilkington and the 18th to Parker. See the critical edition by Griffiths, Oxford, 1869. The homilies are not now read publicly, though they are sometimes appealed to in controversies affecting the doctrines of the Anglican Church.

HOMOEOPATHY (from the Greek *ὁμοιος*, like, and *πάθος*, feeling). The distinctive system of therapeutics which bears the name of homoeopathy is based upon the law *similia similibus curentur*,³ the originator of which was S. C. F. Hahnemann, a

of the *Homiliarium* is in the emperor's own commission entrusted to Paul, to whom it is assigned in the earlier printed editions also. A comparison of different editions shows that the contents increased with the ever-growing number of saints' days and festivals, new discourses by later preachers like Bernard being constantly added.

¹ Neander, *Church History*, v. 174 (Eng. trans. of 1851).
² An ancient English metrical homiliarium is preserved in the library of the university of Cambridge. Earlier versions of it have existed, and a portion of perhaps the earliest copy, dating from about the middle of the 13th century, was published in 1862 by Mr J. Small, librarian to the university of Edinburgh.

³ An interesting controversy has been carried on between the members of the homoeopathic school as to the proper construction of the Latin motto which constitutes its acknowledged basis. For many years the verb at the conclusion of the sentence was used in the indicative mood, *curentur*, thus making the sentence a positive one. After extended research it has been discovered that Hahnemann himself never employed the word *curentur* as descriptive of his law of cure, but always wrote *curentur*, which greatly modifies the meaning of the phrase. If the subjunctive mood be used, the motto reads, "Let similars be treated by similars," or "similars should be treated by similars." The reading *similia similibus curentur* was officially adopted as the correct reading of the sentence by the American Institute of Homoeopathy at its session held in Atlantic City, N. J., on the 20th of June 1899; and the words are so inscribed on the monument erected to the memory of Hahnemann and unveiled in Washington, D. C., on the 23rd of June 1900, and also are those carved upon the tomb of Hahnemann in Père-la-Chaise, Paris.

native of Meissen in Germany, who discovered his new principle while he was experimenting with cinchona bark in 1790, and announced it in 1796.⁴ The essential tenets of homoeopathy—with which is contrasted the "allopathy" (ἄλλος, other) of the "orthodox" therapeutics—are that the cure of disease is effected by drugs that are capable of producing in a healthy individual symptoms similar to those of the disease to be treated, and that to ascertain the curative virtues of any drug it must be "proved" upon healthy persons—that is, taken by individuals of both sexes in a state of health in gradually increasing doses. The manifestations of drug action thus produced are carefully recorded, and this record of "drug-diseases," after being verified by repetition on many "provers," constitutes the distinguishing feature of the homoeopathic materia medica, which, while it embraces the sources, preparation and uses of drugs as known to the orthodox pharmacopœia, contains, in addition, the various "provings" obtained in the manner above described.

Besides the promulgation of the doctrine of similars, Hahnemann also enunciated a theory to account for the origin of all chronic diseases, which he asserted were derived either directly or remotely from psora (the itch), syphilis (venereal disease) or sycosis (fig-wart disease). This doctrine, although at first adopted by some of the enthusiastic followers of Hahnemann, was almost immediately discarded by very many who had a firm belief in his law of cure. In the light of advancing science such theories are entirely untenable, and it was unfortunate for the system of medicine which he founded that Hahnemann should have promulgated such an hypothesis. It served as a target for the shafts of ridicule showered upon the system by those who were its opponents, and even at the present time there still exists in the minds of many misinformed persons the conviction that homoeopathy is a system of medicine that bases the origin of all chronic disease on the itch or on syphilis or fig-warts.

Another peculiar feature of homoeopathy is its posology or theory of dose. It may be asserted that homoeopathic posology has nothing more to do with the original law of cure than the psora (itch) theory has, and that it was one of the later creations of Hahnemann's mind. Most homoeopaths believe more or less in the action of minute doses of medicine, but it must not be considered as an integral part of the system. The dose is the corollary, not the principle. Yet in the minds of many, infinitesimal doses of medicine stand for homoeopathy itself, the real law of cure being completely put into the background. The question of dose has also divided the members of the homoeopathic school into bitter factions, and is therefore a matter for careful consideration. Many employ low potencies,⁵ i. e. mother

⁴ Some points of Hahnemann's system were borrowed from previous writers—as he himself, though imperfectly, admits. Not to mention others, he was anticipated by Hippocrates, and especially by Paracelsus (1495-1541). The identical words *similia similibus curentur* occur in the Geneva edition (1658) of the works of Paracelsus, as a marginal heading of one of the paragraphs; and in the "Fragmenta Medica," *Op. Omnia*, i. 168, 169, occurs the following passage:

Simile similibus cura; non contrarium.

"Quisquis enim cum laude agere Medicum volet, is has nugas longe valere jubeat. Nec enim ullus unquam morbus calidus per frigida sanatus fuit, nec frigidus per calida. Simile autem suum simile frequenter curavit, scilicet Mercurius sulphur, et sulphur Mercurium; et sal illa, velut et illa sal. Interdum quidem cum proprietate junctum frigidum sanavit calidum; sed id non factum est ratione frigidi, verum ratione naturae alterius, quam a primo illo omnino diversam facimus."

It is very remarkable that in Hahnemann's enumeration of authors who anticipated him in regard to the doctrine of *Similia*, he makes no mention of the views of Paracelsus, though the very words seem to be taken from the works of that physician. The other point in Hahnemann's doctrine—that medicines should be tried first on healthy persons—he admits to have been enunciated by Haller. Roughly it has been acted on by physicians in all ages, but certainly more systematically since Hahnemann's time. In the most characteristic feature of Hahnemann's practice—"the potentizing," "dynamizing," of medicinal substances—he appears to have been original.

⁵ Two methods of preparing medicines are recognized, one on the decimal, the other on the centesimal scale. The pure tinctures are denominated "mother tinctures," and represented by the Greek φ. To

tinctures, first, second, sixth dilutions, &c., while others use hundred-thousandths and millionths.

Some homoeopaths of the present day still believe with Hahnemann that, even after the material medicinal particles of a drug have been subdivided to the fullest extent, the continuation of the dynamization or trituration or succussion develops a spiritual curative agency, and that the higher the potency, the more subtle and more powerful is the curative action. Hahnemann says (*Organon*, 3rd American edition, p. 101), "It is only by means of the spiritual influence of a morbid agent that our spiritual vital power can be diseased, and in like manner only by the spiritual operation of medicine can health be restored." This is absolutely denied by others. Thus there exist two schools among the adherents of homoeopathy. On the one hand there are the Hahnemannians, the "Purists" or "High Potency" men, who still profess to regard the *Organon* as their Bible, who believe in all the teachings of Hahnemann, who adhere in their prescriptions to the single dose, the single medicine, and the highest possible potency, and regard the doctrine of the spiritual dynamization acquired by trituration and succussion as indubitable. On the other side there are the "Rational" or "Low Potency" men, who believe in the universality of the law of cure, but think that it cannot always be applied, on account of an imperfect materia medica and a lack of knowledge on the part of the physician. They believe that in many cases of severe and acute pain palliatives are required, and that they are free to use all the adjuvants at present known to science for the relief of suffering humanity—massage, balneology, electricity, hygiene, &c. The American Institute of Homoeopathy, the national body of the United States, has adopted the following resolution and ordered it to be published conspicuously in each number of the *Transactions of the society*: "A homoeopathic physician is one who adds to his knowledge of medicine a special knowledge of homoeopathic therapeutics. All that pertains to the great field of medical learning is his by tradition, by inheritance, by right."

It is claimed that the effect produced upon both the laity and the general profession of medicine by the introduction of homoeopathy was salutary in many ways. It diminished the quantity of medicine that was formerly considered necessary for the eradication of disease, and thus revealed the fact that the *vis medicatrix nature* is often sufficient, with occasional and gentle assistance, to cure many diseases, especially those fevers that run a definite and regular course. Corroboration of the law *similia similibus curentur* is seen, according to homoeopaths, in the adoption of the serum therapy, which consists in the treatment of the most malignant diseases (diphtheria, lock-jaw, typhoid fever, tuberculosis, bubonic plague) by introducing into the system a modified form (similar) of those poisons that produce them in the healthy individual. Hahnemann undoubtedly deserves the credit of being the first to break decidedly with the old school of medical practice, in which, forgetful of the teachings of Hippocrates, nature was either overlooked or rudely opposed by wrong and ungentle methods. We can scarcely now estimate the force of character and of courage which was implied in his abandoning the common lines of medicine. More than this, he and his followers showed results in the treatment of disease which compared very favourably with the results of contemporary orthodox practice.

make a first decimal dilution or first decimal trituration, 10 drops of the mother tincture, or 10 grains of a crude substance, are mixed with 90 drops of alcohol, or 90 grains of *saccharum lactis* (sugar of milk) respectively. The liquid is thoroughly shaken, or the powder carefully triturated, and the bottles containing them marked 1 X, meaning first decimal dilution or trituration. To make the 2 X potency, 10 drops or 10 grains of this first dilution or trituration are mixed with 90 drops of pure alcohol, or 90 grains of milk sugar, and are succussed or triturated as above described, and marked 2 X dilution or trituration. This subdivision of particles may be continued to an indefinite degree. On the Hahnemannian or centesimal scale the medicines are prepared in the same manner, the difference being that 1 drop or grain is mixed with 99 drops or grains, to make the first centesimal, which is marked 1 c or 1 simply, and so on for the second and higher dilutions.

Homoeopathy has given prominence to the therapeutical side of medicine, and has done much to stimulate the study of the physiological action of drugs. It has done service in directing more special attention to various powerful drugs, such as aconite, *nux vomica*, belladonna, and to the advantage of giving them in simpler forms than were common before the days of Hahnemann. But in the medical profession homoeopathy nevertheless remains under the stigma of being a dissenting sect. It has been publicly announced that if the homoeopaths would abolish the name "homoeopathy" and remove it from their periodicals, colleges, hospitals, dispensaries and asylums, they would be received within the fold of the regular profession. These conditions have been accepted by a few homoeopaths who have become members of the most prominent medical association in the United States.

Homoeopathy as it exists to-day can, in the opinion of its adherents, stand by itself, and its progress for a century in face of prolonged and determined opposition appears to its upholders to be evidence of its truth. There are still, indeed, in both schools of medical thought, men who stand fast by their old principles. There are homoeopaths who can see nothing but evil in the practice of their brothers of the orthodox school, as there are allopathists who still regard homoeopathy as a humbug and a sham. There are, however, liberal-minded men in both schools, who look upon the adoption of any safe and efficient method of curing disease as the birthright of the true physician, and who allow every man to prescribe for his patients as his conscience may dictate, and, provided he be educated in all the collateral branches of medical science, are ready to exchange views for the good of suffering humanity.

Great Britain.—Homoeopathy is not rapidly extending in Great Britain, and its recognition has been slow. The first notice taken of the new system of therapeutics was by the Medical Society of London in 1826. In 1827 the physician of Prince Leopold of Saxe-Coburg, Dr F. H. F. Quin (1799-1878), who had previously studied homoeopathy in Germany and practised it in Italy, came to England, and it was through his efforts that the system was introduced. Three other physicians, Dr Belluomini, Dr Romani and Dr Tagliani, claimed priority, but careful research established Dr Quin's title. Quin was a successful man professionally and socially, and brought upon himself in a short time the anathema of the Royal College of Physicians. In 1844 Dr William Henderson, professor of pathology in the university of Edinburgh, embraced the Hahnemannian system. A storm of opposition arose, and Professor J. Y. Simpson (the discoverer of chloroform anaesthesia) published a volume, with the alliterative title, *Homoeopathy, its Tenets and Tendencies, Theoretical, Theological, and Therapeutical*. This brochure was answered by Professor Henderson, the title of his book being *Homoeopathy Fairly Represented*. From 1827 to 1837 there were but a dozen practitioners of homoeopathy in London, but during 1837 to 1847 the number increased to between seventy and eighty. In 1857 there were upwards of two hundred practitioners in the kingdom, with thirty-three institutions in which the law of similars was used as a basis of practice. In 1867 the increase was not so rapid, the number being 261. A society was formed about this period for "the protection of homoeopathic practitioners and students," which proved of great value in binding the sect together. In 1870 congresses were established, and annual meetings held, which have continued to the present time. In 1901 there were over three hundred homoeopathic physicians in the British Isles, of whom between seventy and eighty were in London alone. There were seventy-nine chemists, of whom seventeen were located in London, and eighty-two towns and cities in the country contained from one to ten homoeopathic practitioners each, together with many established chemists for dispensing homoeopathic medicines. The British Homoeopathic Society was founded by Quin in 1844, and has numerous members and fellows, besides corresponding members in all portions of the world, including Australia, India and Tasmania. The London Homoeopathic Hospital was founded in 1850, also largely through the efforts of Quin, and a few years afterwards moved to Great Ormond Street. During the cholera epidemic of 1854 the statistics of this hospital showed a mortality of 16.4 % against 51.8 % of other metropolitan charities. The London Homoeopathic Hospital has a convalescent home under its management at Eastbourne. There are also dispensaries in Ealing and West Middlesex, Kensington, Notting Hill and Bayswater. Similar institutions are located in Bath, Birkenhead, Birmingham, Bootle, Bournemouth, Brighton, Bristol, Bromley, Cheltenham, Cheshire, Croydon, Dublin, Eastbourne, Edinburgh, Folkestone, Hastings and St Leonards, Ipswich, Leeds, Leicester, Liverpool, Newcastle, Northampton, Norwich, Oxford, Plymouth, Torquay, Tunbridge Wells, Weston-super-Mare. The homoeopathic journals include the *Homoeopathic World*, the *London Homoeopathic Hospital*

Reports, the Journal of the British Homoeopathic Society, and the British Homoeopathic Review, the last being issued by the British Homoeopathic Association, which was founded in 1900 for the purpose of developing and extending homoeopathy in Great Britain. The *British Journal of Homoeopathy* was first published in 1843, and was edited by Drs Drysdale, Russell and Black. For many years it was the foremost homoeopathic journal in the world. Its motto was *In certis unitis, in dubiis libertas, in omnibus caritas*. One reason why homoeopathy has not advanced as rapidly in the British Isles as in America is said to be the discrimination exercised against it by the General Medical Council, and another is want of cohesion amongst the homoeopaths themselves.

United States.—Homoeopathy was introduced into the United States by Dr Hans Birch Gram, who was born in Boston. His father being Danish, Gram in his eighteenth year went to Copenhagen, where he graduated in 1814. In 1823 he became acquainted with homoeopathy, and brought a knowledge of it to America in 1825 when he settled in New York. The first homoeopathic association was formed in 1833 in Philadelphia, the second in New York, 1834, and homoeopathy became known in the different states somewhat in the following order: New York, 1825; Pennsylvania, 1828; Louisiana, 1836; Connecticut, 1837; Massachusetts, 1837-1838; Maryland, 1837; Delaware, 1837; Kentucky, 1837; Vermont, 1838; Rhode Island, 1839; Ohio, 1839; New Jersey, 1840; Maine, 1840; New Hampshire, 1840; Michigan, 1841; Georgia, 1842; Wisconsin, 1842; Alabama, 1843; Illinois, 1843; Tennessee, 1844; Missouri, 1844; Texas, 1848; Minnesota, 1852; Nebraska, 1862; Colorado, 1863; Iowa, 1871. After 1871 the spread of the system was rapid throughout every state in the Union, and it is in the United States that homoeopathy principally flourishes. There are thousands of homoeopathic physicians, and their clients number several millions. It may be noted that departments of homoeopathy are connected with the universities of Boston, Michigan, Iowa, Minnesota and Kansas City.

Canada.—The early history of homoeopathy can be traced back nearly to 1850 in the province of Quebec. In the Dominion of Canada the various provinces control the licensing of physicians, excepting in Quebec, which is the only province having a separate homoeopathic board of examiners. This is under the control of the Montreal homoeopathic Association, and is known as the College of Homoeopathic Physicians and Surgeons of Montreal. Three examiners are annually appointed by the association. Successful candidates receive the diploma of the college, and are entitled to add to their degree the letters M.C.H.P.S. A certificate of successful examination is forwarded to the lieutenant-governor at Quebec, who, "if satisfied of the loyalty, integrity and good morals of the applicant, may grant him a license to practise surgery, physic and midwifery, or either of them, in the province of Quebec." The word "loyalty" has been decided by the provincial secretary to mean a British subject. This is the only government medical license now issued in the British empire, the others being by provincial boards or colleges of physicians and surgeons. In 1894 there was no homoeopathic institution in the province; at present the Montreal Homoeopathic Hospital is in active operation. Two homoeopathic papers are published monthly—the *Homoeopathic Record* in Montreal, and the *Homoeopathic Messenger* in Toronto. In 1870, in the province of Ontario, the three schools, allopathic, homoeopathic and eclectic, united for examining purposes into one board called the medical council, seventeen members representing the old school and five the other two systems. Finally the eclectic were merged in the old school, the board appointing five of Hahnemann's followers for examining purposes. Grace Hospital at Toronto (erected 1892) was begun as a dispensary in 1887.

Germany.—In 1810 Hahnemann published his *Organon*, which was the starting-point of homoeopathy in Germany. In 1811 an endeavour was made to found an institution in Leipzig in which practitioners might learn the new method of treatment theoretically and practically, but it was not a success, as the entire tide of professional opinion was against the system. In 1829, at the celebration of the fiftieth anniversary of Hahnemann's doctorate, the German Central Society was organized, holding its first meeting in 1830. In the university hospital of Munich some experiments were made to test the efficacy of homoeopathic medicines, but these were not successful. In 1831 the government prohibited homoeopaths from dispensing their own medicines; this was a severe blow to the system. In 1834 there was a division among the homoeopaths themselves, which much retarded the progress of the school. A homoeopathic hospital was established about this time (January 1833) in Leipzig, but there was such constant wrangling among the physicians connected with it that its sphere of usefulness was curtailed, and it was finally converted into a dispensary. The Baden Homoeopathic Society was established in 1834. The homoeopathic hospital in Munich was established in 1836, but suffered a similar fate to that of Leipzig, and was converted into a dispensary. The rather equivocal success of these hospitals in Saxony and Bavaria was in direct contrast to the fate of two newly established hospitals in Austria, one in Vienna and the other in Linz, which were very successful, and aroused great interest both among physicians and laymen. During the political confusion of 1846 and 1849 there was complete stagnation of everything medical in Germany. But during all these years, though the public institutions were few,

the literature on homoeopathic subjects became very extensive, and exercised a significant influence upon the system in all parts of the world. Hahnemann died in 1843, and on the 10th of August 1851 a bronze monument to him was unveiled at Leipzig. The Leipzig dispensary lived thirty-three years. From 1842 to 1874 there were treated in this institution 65,106 patients. In 1901 there were about 250 homoeopathic physicians in Germany; they appeared to be strongest at Berlin, in the province of Brandenburg, in Pomerania and Westphalia, Saxony, Hessen and in Württemberg.

Austria-Hungary.—Homoeopathy was introduced into Austria about 1817, and in 1819 its practice was forbidden by law. Shortly afterwards the physician attending the archduke John became a homoeopath. In 1825 the doctrine was introduced into Vienna. To test the efficacy of the system Francis I. ordered that experiments be made with homoeopathic medicines, and for this purpose a ward furnished with twelve beds was allotted. The results were satisfactory to the new system, and it made gigantic strides in Vienna. During the cholera epidemic of 1836 an increased impetus was given to the new school by the reported brilliant successes of the treatment. Societies were founded and journals published. In 1846 a second hospital was founded. In 1850 a third hospital was opened, and clinical lectures upon the system were delivered. In 1873 the Society of Homoeopathic Physicians was formed. Between the years 1873 and 1893 homoeopathy declined. In 1901, in thirty-seven cities and towns there were to be found about fifty physicians and two hospitals, and it was estimated that about seventy-five more were scattered in Moravia, Bohemia, Tirol, Salzburg and the coast provinces. There is a professorship of homoeopathy at the University of Budapest, and homoeopathic clinics are held at the new Rochus Hospital in Ulloi Street, and also in the homoeopathic department of the Hospital Bethesda of the Reformed Community. The Elizabeth Hospital, exclusively homoeopathic, has existed for many years.

Russia.—The homoeopathic system was introduced into Russia in 1823. In 1825 great impetus was given to the new doctrine by the conversion of Dr Bigel, physician to the grand duke Constantine. In 1829 the grand duke ordered a series of experiments to be conducted to prove the truth or fallacy of homoeopathy, and they demonstrated the success of the new school. In 1841 a hospital was established in Moscow, and in 1849 similar institutions were founded in Nizhny-Novgorod. Since then homoeopathy has been steadily practised, and has penetrated to the remotest parts of Russia. In 1881 the civil engineers proposed to commemorate the virtues of the emperor Alexander II. by the erection of a hospital; a committee for collecting funds was created, and \$8,064 roubles were handed to the Charity Society of the followers of homoeopathy at St Petersburg for the erection and founding of a homoeopathic hospital. The foundation stone of the edifice was laid on 19th June 1893, the emperor Alexander III. giving 5000 roubles. The inauguration of a new dispensary and a pharmacy took place on the 19th of April 1898, and the hospital itself, intended originally for fifty beds, was opened on the 1st of November 1898. There are sixteen free beds, three of them being in the name of the emperor Nicholas, the empress Maria Feodorovna, and the emperor Alexander III. On the 28th of January 1899 an imperial edict was issued granting the rights of public service to the doctors of the hospital and dispensaries of the Charity Society, thus placing them on an equality with the doctors of the prevailing medical school.

France.—Homoeopathy was first introduced into France in 1830 by Count de Guidi, doctor of medicine, doctor of science, and inspector of the university, who practised in Lyons. About the same year Dr Antoine Petroz, widely known by his *Grand dictionnaire des sciences médicales*, began practising homoeopathy in Paris, and his establishment became the headquarters of the new system there. In 1835 Hahnemann himself came to the capital. In 1832 the homoeopathic method of treating disease was introduced into the Hospice de Choisy, and in 1842 into the hospital of Carentan. Tessier practised the new doctrine in his wards in the Hospital St Marguerite, and in the Children's Hospital up to the year 1862, when he retired. The first homoeopathic society was established in 1832 (the Société Gallicain), Hahnemann becoming president in 1835; in 1845 the Société de Médecine Homéopathique was organized; and in 1860 the two were united for the better interests of the school. In 1901 there were at Paris three hospitals—the Hospital St Jacques with fifty-five beds, the Hahnemann Hospital with thirty-five beds, and the new Protestant Hospital for Children with twenty-five beds. At Lyons there is the Hospital St Luc. The medical journals include *L'Art médical*, *La Revue homéopathique belge*, *Journal belge d'homéopathie*, *La Thérapeutique Intégrale*, *La Revue homéopathique française*. In the year 1900 the medical officers of the republic having supervision over the medical department of the International Exhibition officially recognized the members of the homoeopathic school, and arranged for the proper accommodation and reception of the International Congress of Homoeopathic Physicians held in June. On the 30th of that month, with appropriate ceremonies, the remains of Hahnemann were removed from the cemetery of Montmartre and deposited in Père-la-Chaise, and a monument bearing a suitable inscription was erected to the memory of the founder of homoeopathy.

Italy.—The Austrians when they entered Naples in 1821 brought homoeopathy into Italy, the general in command of the army being

a devoted friend of Hahnemann. In 1828 Dr Count Sebastian de Guidi came from Lyons and assisted in spreading the doctrine. During the period from 1830 to 1860 many physicians practised homoeopathy, and the literature on the subject became extensive. A homoeopathic clinic was established and a ward opened in Trinity Hospital at Naples, and a homoeopathic physician was appointed to the count of Syracuse. During the severe cholera epidemics of 1854, 1855, 1865 the success of homoeopathic treatment of that disease was so marked under the care of Dr Rubini that the attention of the authorities was directed to the system. In 1860 the homoeopathic practice was introduced into the Spedale della Cesarea, and since that period homoeopathy has been recognized with more or less favour in most of the cities. The Italian Homoeopathic Institute is recognized by royal warrant as an established institution, and its regulations are approved by the government. In Turin the legal seat of the Homoeopathic Institute, there is a hospital under the management of the State Association. The homoeopathic medical press consists of the *Revista Omiopatica*, established in 1855, and *L'Omopatico in Italia*, the organ of the Italian Homoeopathic Institute, which first appeared in 1884.

Spain.—Homoeopathy was introduced into Spain in 1829 by a physician to the Royal Commission sent by the king of Naples to attend the marriage of Maria Christina with Don Ferdinand VII. Shortly after this, a merchant of Cadiz visited Hahnemann in Coethen, and was cured of a serious disorder; he returned to Spain with a supply of homoeopathic literature, and immediately sent a medical student to Leipzig to study the new system. In 1843 many cases of cholera were treated homoeopathically in Madrid. The civil war, which did not terminate until 1849, arrested all medical investigation in Spain, but in 1843 there still existed in Madrid five pharmacies and a number of homoeopathic physicians. About this time Dr Tosi Nuñez returned from an investigation of the new system with Hahnemann, and owing to his success in the treatment of disease was created one of the physicians of the bed-chamber to the queen, who soon afterwards conferred upon him the title of *marquis*, with the *grand crosses* of the Charles III., and of the Civil Order of Beneficencia. This recognition by high authority gave an impetus to homoeopathy which has continued ever since.

Denmark.—Homoeopathy was unknown in Denmark until the year 1821, when Hans Christian Lund, a medical practitioner, adopted it. Hahnemann, however, had been both before and after that time consulted by Danae, and consequently homoeopathic therapeutics was recognized in different parts of the country. Lund translated many of Hahnemann's works into Danish, as well as those of other eminent members of the new school. (W. T. H.)

HOMONYM (Gr. *ὁμόνομος*, having the same name, from *ὄμος*, same, alike, and *νόμος*, name), a term in philology for those words which differ in sense but are alike either in sound or spelling or both. Words alike only in spelling but not in sound, e.g. "bow," are sometimes called *homographs*; and words alike only in sound but not in spelling, e.g. "meat," "meet," *homophones*. Skeat (*Etymol. Dict.*) gives a list of English homonyms.

HOMS, or **HUMS** (anc. *Emesa* or *Emessa*, near the Hittite *Kadesh*), a town of Syria, on the right bank of the Orontes, and capital of a sanjak in the vilayet of Syria (Damascus). Pop. 30,000 (20,000 Moslem, 10,000 Christian). The importance of the place arises from its command of the great north road from Egypt, Palestine and Damascus by the Orontes valley. Invading armies from the south have often been opposed near Homs, from the time of Rameses II., who had to fight the battle of Kadesh, to that of Ibrahim Pasha, who broke the first line of Ottoman defence in 1831 by his victory there. Ancient *Emesa*, in the district of Apamea, was a very old Syrian city, devoted to the worship of Baal, the sun god, of whose great temple the emperor Heliogabalus was originally a priest (A.D. 218). As a centre of native influences it was overawed by the Seleucid foundation of Apamea; but it opposed the Roman advance. There Aurelian crushed, in A.D. 272, the Syrian national movement led by Zenobia. Caracalla made it a Roman colony, and later it became the capital of a small province, *Phoenicia Libanensis* or *ad Libanum*. About 630 it was captured by the Moslem leader, Khalid ibn Walid, who is buried there. It now became the capital of a *jund*, or military district, which under the Omayyad Caliphs extended from Palmyra to the sea. Under the Arabs it was one of the largest cities in Syria, with walls and a strong citadel, which stood on a hill, occupying perhaps the site of the great sun temple. The ruins of this castle, blown up by Ibrahim Pasha, are still the most conspicuous feature of Homs, and contain many remains of ancient buildings. Its men were noted for their courage in war, and its

women for their beauty. The climate was extolled for its excellence, and the land for its fertility. A succession of gardens bordered the Orontes, and the vineyards were remarkable for their abundant yield of grapes. When the place capitulated the great church of St John was divided between the Christians and Moslems, an arrangement which apparently lasted until the arrival of the Turks. At the end of the 11th century it fell into crusading hands, but was recovered by the Moslems under Saladin in 1187. Its decay probably dates from the invasion of the Mongols (1260), who fought two important battles with the Egyptians (1281 and 1299) in its vicinity. The construction of a carriage road to Tripoli led to a partial revival of prosperity and to an export of cereals and fruit, and this growth has, in turn, been accentuated by the railway, which now connects it with Aleppo and the Damascus-Beirut line. The district is well planted with mulberries and produces much silk, most of which is worked up on the spot. (D. G. H.)

HO-NAN, a central province of China, bounded N. partly by the Hwang-ho (which it crosses to the west of Ho-nan Fu, forming an arm northwards between the provinces of Shan-si and Chih-li), on the W. by Shen-si, on the S. by Hu-peh, and on the E. by Ngan-hui. It occupies an area of 81,000 sq. m., with a population of about 22,000,000, and contains nine prefectural cities. Its capital is K'ai-feng Fu. The prefecture of Hwai-k'ing, north of the Hwang-ho, consists of a fertile plain, "rendered park-like by numerous plantations of trees and shrubs, among which thick bosquets of bamboo contrast with the gloomy groves of cypress." All kinds of cereals grow luxuriantly, and the general productiveness of the district is indicated by the extreme denseness of the population. The most noticeable feature in that portion of the province which is properly called Ho-nan is the Fu-niu Shan range, which runs east and west across this part of the province. Coal is found on the south of the Hwang-ho in the districts of Ho-nan Fu, the ancient capital, Lushan and Ju Chow. The chief products of the province are, however, agricultural, especially in the valley of the Tang-ho and Pai-ho, which is an extensive and densely populated plain running north and south from the Fu-niu Shan. Cotton is also grown extensively and forms the principal article of export, and a considerable quantity of wild silk is produced from the Fu-niu Shan. Three roads from the east and south unite at Ho-nan Fu, and one from the west. The southern road leads to Ju Chow, where it forks, one branch going to Shi-ki-chên, connecting the trade from Fan-cheng, Han-kow, and the Han river generally, and the other to Chow-kia-k'ow near the city of Ch'en-chow Fu, at the confluence of the three rivers which unite to form the Sha-ho; the second road runs parallel with the Hwang-ho to K'ai-feng Fu; the third crosses the Hwang-ho at Mêngch'ing Hien, and passes thence in a north-easterly direction to Hwai-k'ing Fu, Sew-wu Hien and Wei-hui Fu, at which place it joins the high road from Peking to Fan-cheng; and the western road follows the southern bank of the Hwang-ho for 250 m. to its great bend at the fortified pass known as the Tung-kwan, where it joins the great wagon road leading through Shan-si from Peking to Si-gan Fu. Ho-nan is now traversed north to south by the Peking-Hankow railway (completed 1905). The line crosses the Hwang-ho by Yung-tse and runs east of the Fu-niu Shan. Branch lines serve Ho-nan Fu and K'ai-feng Fu.

HONAVAR, or **ONORE**, a seaport of British India, in the North Kanara district of Bombay. Pop. (1901) 6929. It is mentioned as a place of trade as early as the 16th century, and is associated with two interesting incidents in Anglo-Indian history. In 1670, the English factors here had a bull-dog which unfortunately killed a sacred bull, in revenge for which they were all murdered, to the number of eighteen persons, by an enraged mob. In 1784 it was bravely defended for three months by Captain Torriano and a detachment of sepoy against the army of Tippoo Sultan.

HONDA, or **SAN BARTOLOMEO DE HONDA**, a town of the department of Tolima, Colombia, on the W. bank of the Magdalena river, 580 m. above its mouth. In 1906 Mr F. Loraine Petre

estimated the population at 7000. It is about 650 ft. above sea-level and stands at the entrance to a narrow valley formed by spurs of the Central Cordillera, through which a picturesque little stream, called the Guali, flows into the Magdalena. The town overlooks the rapids of the Magdalena, and is shut in closely by spurs of the Eastern and Central Cordilleras. The climate is hot and damp and the temperature frequently rises to 102° F. in the shade. Honda dates back to the beginning of the 17th century, and has been one of the important centres of traffic in South America for three hundred years. Within the city there is an iron bridge across the Guali, and there is a suspension bridge across the Magdalena at the head of the rapids. A railway 18 m. long connects with the landing place of La Dorada, or Las Yeguas, where the steamers of the lower Magdalena discharge and receive their cargoes (the old landing at Carocali nearer the rapids having been abandoned), and with Arrancaplumas, 1½ m. above, where navigation of the upper river begins. Up to 1908 the greater part of the traffic for Bogotá crossed the river at this point, and was carried on mule-back over the old *camino real*, which was at best only a rough bridle-path over which transportation to Bogotá (67 m. distant) was laborious and highly expensive; now the transshipment is made to smaller steamboats on the upper river for carriage to Girardot, 93 m. distant, from which place a railway runs to the Bogotá plateau. Honda was nearly destroyed by an earthquake in 1808.

HONDECOETER, MELCHIOR D' (c. 1636-1695), Dutch painter, was born at Utrecht, it is said, about 1636, and died at Amsterdam on the 3rd of April 1695. Old historians say that, being the grandson of Gillis and son of Gisbert d'Hondecoeter, as well as nephew of J. B. Weenix, he was brought up by the last two to the profession of painting. Of Weenix we know that he married one Josina d'Hondecoeter in 1638. Melchior was, therefore, related to Weenix, who certainly influenced his style. As to Gillis and Gisbert some points still remain obscure, and it is difficult to accept the statement that they stood towards each other in the relation of father and son, since both were registered as painters at Utrecht in 1637. Both it appears had practised art before coming to Utrecht, but where they resided or what they painted is uncertain. Unhappily pictures scarcely help us to clear up the mystery. In the Fürstenberg collection at Donaueschingen there is a "Concert of Birds" dated 1620, and signed with the monogram G. D. H.; and we may presume that G. D. H. is the man whose "Hen and Chickens in a Landscape" in the gallery of Rotterdam is inscribed "G. D. Hondecoeter, 1652"; but is the first letter of the monogram to stand for Gillis or Gisbert? In the museums of Dresden and Cassel landscapes with sportsmen are catalogued under the name of Gabriel de Heusch (?), one of them dated 1520, and certified with the monogram G. D. H., challenging attention by resemblance to a canvas of the same class inscribed G. D. Hond. in the Berlin Museum. The question here is also whether G. means Gillis or Gisbert. Obviously there are two artists to consider, one of whom paints birds, the other landscapes and sportsmen. Perhaps the first is Gisbert, whose son Melchior also chose birds as his peculiar subject. Weenix too would naturally teach his nephew to study the feathered tribe. Melchior, however, began his career with a different speciality from that by which he is usually known. Mr de Stuers affirms that he produced sea-pieces. One of his earliest works is a "Tub with Fish," dated 1655, in the gallery of Brunswick. But Melchior soon abandoned fish or fowl. He acquired celebrity as a painter of birds only, which he represented not exclusively, like Fyt, as the gamekeeper's perquisite after a day's shooting, or stock of a poulterer's shop, but as living beings with passions, joys, fears and quarrels, to which naturalists will tell us that birds are subject. Without the brilliant tone and high finish of Fyt, his Dutch rival's birds are full of action; and, as Bürger truly says, Hondecoeter displays the maternity of the hen with as much tenderness and feeling as Raphael the maternity of Madonnas. But Fyt was at home in depicting the coat of deer and dogs as well as plumage. Hondecoeter cultivates a

narrower field, and seldom goes beyond a cock-fight or a display of mere bird life. Very few of his pictures are dated, though more are signed. Amongst the former we should note the "Jackdaw deprived of his Borrowed Plumes" (1671), at the Hague, of which Earl Cadogan has a variety; or "Game and Poultry" and "A Spaniel hunting a Partridge" (1672), in the gallery of Brussels; or "A Park with Poultry" (1686) at the Hermitage of St Petersburg. Hondecoeter, in great favour with the magnates of the Netherlands, became a member of the painters' academy at the Hague in 1650. William III. employed him to paint his menagerie at Loo, and the picture, now at the Hague museum, shows that he could at a pinch overcome the difficulty of representing India's cattle, elephants and gazelles. But he is better in homelier works, with which he adorned the royal chateaux of Bensberg and Oranienstein at different periods of his life (Hague and Amsterdam). In 1688 Hondecoeter took the freedom of the city of Amsterdam, where he resided till his death. His earliest works are more conscientious, lighter and more transparent than his later ones. At all times he is bold of touch and sure of eye, giving the motion of birds with great spirit and accuracy. His masterpieces are at the Hague and at Amsterdam. But there are fine examples in private collections in England, and in the public galleries of Berlin, Caen, Carlsruhe, Cassel, Cologne, Copenhagen, Dresden, Dublin, Florence, Glasgow, Hanover, London, Lyons, Montpellier, Munich, Paris, Rotterdam, Rouen, St Petersburg, Stuttgart and Vienna.

HONDURAS, a republic of Central America, bounded on the N. by the Caribbean Sea, E. by Nicaragua, S. by Nicaragua, the Pacific Ocean and Salvador, and W. by Guatemala. (For map see CENTRAL AMERICA.) Pop. (1905) 500,136; area, about 46,500 sq. m. Honduras is said to owe its name, meaning in Spanish "depths," to the difficulty experienced by its original Spanish explorers in finding anchorage off its shores; Cape Gracias à Dios (Cape "Thanks to God") is the name bestowed, for analogous reasons, on its easternmost headland, which shelters a small harbour, now included in Nicaragua. Modern navigators are not confronted by the same difficulty; for, although the north coast is unbroken by any remarkable inlet except the Carataska Lagoon, a land-locked lake on the east, with a narrow entrance from the sea, there are many small bays and estuaries, such as those of Puerto Cortes, Omoa, Ulua, La Ceiba and Trujillo, which serve as harbours. The broad basin of the Caribbean Sea, bounded by Honduras, Guatemala and British Honduras, is known as the bay or gulf of Honduras. Several islets and the important group of the Bay Islands (*q.v.*) belong to the republic. On the Pacific the Hondurian littoral is short but of great commercial value; for it consists of a frontage of some 60 m. on the Bay of Fonseca (*q.v.*), one of the finest natural harbours in the world. The islands of Tigre, Sacate Grande and Gueguensi, in the bay, belong to Honduras.

The frontier which separates the republic from Nicaragua extends across the continent from E.N.E. to W.S.W. It is defined by the river Segovia, Wanks or Coco, for about one-third of the distance; it then deflects across the watershed on the east and south of the river Choluteca, crosses the main Nicaraguan Cordillera (mountain chain) and follows the river Negro to the Bay of Fonseca. The line of separation from Salvador is irregularly drawn, first in a northerly and then in a westerly direction; beginning at the mouth of the river Goasoran, in the Bay of Fonseca, it ends 12 m. W. of San Francisco city. At this point begins the Guatemalan frontier, the largest section of which is delimited along the crests of the Sierra de Merendon. On the Caribbean seaboard the estuary of the Motagua forms the boundary between Honduras and Guatemala.

Physical Features.—The general aspect of the country is mountainous; its southern half is traversed by a continuation of the main Nicaraguan Cordillera. The chain does not, in this republic, approach within 50 or 60 m. of the Pacific; nor does it throughout maintain its general character of an unbroken range, but sometimes turns back on itself, forming interior basins or valleys, within which are collected the headwaters of the streams that traverse the country in the direction of the Atlantic Ocean. Nevertheless, viewed from the

Pacific, it presents the appearance of a great natural wall, with many volcanic peaks towering above it and with a lower range of mountains intervening between it and the sea. It would almost seem that at one time the Pacific broke at the foot of the great mountain barrier, and that the subordinate coast range was subsequently thrust up by volcanic forces. At one point the main range is interrupted by a great transverse valley or plain known as the plain of Comayagua, which has an extreme length of about 40 m., with a width of from 5 to 15 m. From this plain the valley of the river Humuya extends north to the Atlantic, and the valley of the Goascoran extends south to the Pacific. These three depressions collectively constitute a great transverse valley reaching from sea to sea, which was pointed out soon after the conquest as an appropriate course for inter-oceanic communication. The mountains of the northern half of Honduras are not volcanic in character and are inferior in altitude to those of the south, which sometimes exceed 10,000 ft. The relief of all the highlands of the Atlantic watershed is extremely varied; its culminating points are probably in the mountain mass about the sources of the Choluteca, Sulaco and Roman, and in the Sierra de Pija, near the coast. Farther eastward the different ranges are less clearly marked and the surface of the country resembles a plateau intersected by numerous watercourses.

The rivers of the Atlantic slope of Honduras are numerous and some of them of large size and navigable. The largest is the Ulua, with its tributary the Humuya. It rises in the plain of Comayagua and flows north to the Atlantic; it drains a wide expanse of territory, comprehending nearly one-third of the entire state, and probably discharges a greater amount of water into the sea than any other river of Central America, the Segovia excepted. It may be navigated by steamers of light draught for the greater part of its course. The Rio Roman or Aguan is a large stream falling into the Atlantic near Trujillo, with a total length of about 120 m. Its largest tributary is the Rio Mangualil, celebrated for its gold washings, and it may be ascended by boats of light draft for 80 m. Rio Tinto, Negro or Black River, called also Poyer or Poyas, is a considerable stream, navigable by small vessels for about 60 m. Some English settlements were made on its banks during the 18th century. The Patuca rises near the frontier of Nicaragua, and enters the Atlantic east of the Brus or Brewer lagoon. The Segovia is the longest river in Central America, rising within 50 m. of the Bay of Fonseca, and flowing into the Caribbean Sea at Cape Gracias a Dios (see NICARAGUA). Three considerable rivers flow into the Pacific—the Goascoran, Nacaome and Choluteca, the last named having a length of about 150 m. The Goascoran, which almost interlocks with the Humuya, in the plain of Comayagua, has a length of about 80 m. The lake of Yojoa or Taulébe is the only large inland lake in Honduras, and is about 25 m. in length, by 6 to 8 in breadth. Its surface is 2050 ft. above the sea. It has two outlets on the south, the rivers Jaitique and Sacapa, which unite about 15 m. from the lake; and it is drained on the north by the Rio Blanco, a narrow, deep stream falling into the Ulua. It has also a feeder on the north, in the form of a subterranean stream of beautiful clear water, which here comes to the surface. The Caratasca or Caratasca lagoon is a shallow salt-water lake connected by a narrow channel with the Atlantic, and near the mouth of the Segovia. It contains several large sandy islands.

Honduras resembles the neighbouring countries in the general character of its geological formations, fauna and flora. Here, as in other Central American states, there are but two seasons, the wet, from May to November, and the dry, from November to May. On the moist lowlands of the Atlantic coast the climate is oppressive, but on the highlands of the interior it is delightful. At Tegucigalpa, on the uplands, a year's observations showed the maximum temperature to be 90° F. in May, and the minimum to be 50° F. in December, the range of variation during the whole year being within 40° F.

See also CENTRAL AMERICA: *Geology, Fauna, Flora, Climate.*

Inhabitants.—The inhabitants of Honduras are in many cases of the Indian or aboriginal type, and the European element is very small, although it shares in the social, political and economic preponderance of the Spanish-speaking half-castes (*Ladinos* or *Mestizos*), who are the most numerous section of the population. Throughout the country there are many interesting relics of the native civilization which was destroyed by the Spanish invaders in the 16th century. In the eastern portion of the state, between the Rio Roman, Cape Gracias a Dios, and the Segovia river, the country is almost exclusively occupied by native Indian tribes, known under the general names of Xicaques and Poyas. In many districts the Indians are known as Lencas, a generic name which includes several tribes akin to the Mayans of Guatemala. Portions of all of these tribes have accepted the Roman Catholic religion, and live in peaceful neighbourhood and good understanding with the white inhabitants. There are, however, considerable numbers, probably about 90,000 in all, who live among the mountains,

and still conform closely to the aboriginal modes of life. They all cultivate the soil, and are good and industrious labourers. A small portion of the coast, above Cape Gracias, is occupied by the Sambos, a mixed race of Indians and negroes, which, however, is fast disappearing. Spreading along the entire north coast are the Caribs, a vigorous race, descendants of the Caribs of St Vincent, one of the Windward Islands. These, to the number of 5000, were deported in 1796 by the English and landed on the island of Roatan. They still retain their native language, although it tends to disappear and be replaced by Spanish and a bastard dialect of English; they are active, industrious and provident, forming the chief reliance of the mahogany cutters on the coast. A portion of them, who have a mixture of negro blood, are called the Black Caribs. They profess the Roman Catholic religion, but retain many of their native rites and superstitions. In the departments of Gracias, Comayagua and Choluteca are many purely Indian towns.

The aggregate population, according to an official estimate made in 1905, is 500,136, but a complete and satisfactory census cannot be taken throughout the country, since the ignorant masses of the people, and especially the Indians, avoid a census as in some way connected with military conscription or taxation. The bulk of the Spanish population exists on the Pacific slope of the continent, while on the Atlantic declivity the country is uninhabited or but sparsely occupied by Indian tribes, of which the number is wholly unknown. In 1905 there were fewer than 11 inhabitants per sq. m., but all the available data tend to show that the population increases rapidly, owing to the continuous excess of births over deaths. The first census, taken in 1791, gave the total population as only 95,500. There is little emigration or immigration.

Chief Towns.—The capital is Tegucigalpa (pop. 1905, about 35,000); other important towns are Juticalpa (18,000), Comayagua (8000), and the seaports of Amapala (4000), Trujillo (4000), and Puerto Cortes (2500). These are described in separate articles. The towns of Nacaome, La Esperanza, Choluteca and Santa Rosa have upwards of 10,000 inhabitants.

Communications.—Means of communication are very defective. In 1905 the only railway in the country was that from Puerto Cortes to La Pimienta, a distance of 57 m. This is a section of the proposed inter-oceanic railway for which the external debt of the republic was incurred. For the completion of the line concessions, one after another, were granted, and expired or were revoked. Other railways are projected, including one along the Atlantic coast, an extension from La Pimienta to La Brea on the Pacific, and a line from Tegucigalpa to the port of San Lorenzo. The capital is connected with other towns by fairly well made roads, which, however, are not kept in good repair. In the interior generally, all travelling and transport are by mules and ox-carts over roads which defy description.

Honduras joined the Postal Union in 1879. The telegraph service is conducted by the government and is inefficient. Telephones are in use in Tegucigalpa and a few of the more important towns.

Commerce and Industry.—Although grants of land for mining and agricultural purposes are readily made by the state to companies and individual capitalists, the economic development of Honduras has been a very slow process, impeded as it has been by political disturbances and in modern times by national bankruptcy, heavy import and export duties, and the scarcity of both labour and capital. The natural wealth of the country is great and consists especially in its vegetable products. The mahogany and cedar of Honduras are unsurpassed, but reckless destruction of these and of other valuable cabinet-woods and dye-woods has much reduced the supply available for export. Rubber-planting, a comparatively modern industry, has proved successful, and tends to supplement the almost exhausted stock of wild rubber. Of still greater importance are the plantations of bananas, especially in the northern maritime province of Atlantida, where coco-nuts are also grown. Coffee, tobacco, sugar, oranges, lemons, maize and beans are produced in all parts, rice, cocoa, indigo and wheat over more limited areas. Cattle and pigs are bred extensively; cattle are exported to Cuba, and dairy-farming is carried on with success. Sheep-farming is almost an unknown industry. Turtle and fish are obtained in large quantities off the Atlantic seaboard. In its mineral resources Honduras ranks first among the states of Central America. Silver is worked by a British company, gold by an American company. Gold-washing was practised in a primitive manner even before the Spanish conquest, and in the 18th century immense quantities of gold and silver were obtained by the Spaniards from mines near Tegucigalpa. Opals, platinum, copper, lead, zinc, nickel, antimony, iron, lignite and coal have been found, but the causes already enumerated have

prevented the exploitation of any of these minerals on a large scale, and the total value of the ores exported was only £174,800 in 1904 and £239,426 in 1905. The total value of the exports in a normal year ranges from about £300,000 to £600,000, and that of the imports from £450,000 to £550,000. Apart from minerals the most valuable commodity exported is bananas (£209,263 in 1909); coco-nuts, timber, hides, deer-skins, feathers, coffee, mrsaparilla and rubber are items of minor importance. Nearly 90% of the exports are shipped to the United States, which also send to Honduras more than half of its imports. These chiefly consist of cotton goods, hardware and provisions. The manufacturing industries of Honduras include the plaiting of straw hats, cigar-making, brick-making and the distillation of spirits.

Finance.—Owing to the greater variety of its products and the possession of a metallic currency, Honduras is less affected by fluctuations of exchange than the neighbouring republics, in which little except paper money circulates. The monetary unit is the silver peso or dollar of 100 cents, which weighs 25 grammes, .900 fine, and is worth about 1s. 8d.; the gold dollar is worth about 4s. The principal coins in circulation are the 1-cent copper piece, 5, 10, 20, 25 and 50 cents, and 1 peso silver pieces, and 1, 5, 10 and 20 dollar gold pieces. The metric system of weights and measures, adopted officially on the 1st of April 1897, has not supplanted the older Spanish standards in general use. There is only one bank in the republic, the *Banco de Honduras*, with its head office at Tegucigalpa. Its bills are legal tender for all debts due to the state.

In July 1900 the foreign debt of Honduras, with arrears of interest, amounted to £22,470,510, of which more than £17,000,000 were for arrears of interest. The principal was borrowed between 1867 and 1870, chiefly for railway construction; but it was mainly devoted to other purposes and no interest has been paid since 1872. The republic is thus practically bankrupt. The revenue, derived chiefly from customs and from the spirits, gunpowder and tobacco monopolies, reached an average of about £265,000 during the five years 1901-1905; the expenditure in normal years is about £250,000. The principal spending departments are those of war, finance, public works and education.

Constitution and Government.—The constitution of Honduras, promulgated in 1839 and frequently amended, was to a great extent recast in 1880. It was again remodelled in 1894, when a new charter was proclaimed. This instrument gives the legislative power to a congress of deputies elected for four years by popular vote, in the ratio of one member for every 10,000 inhabitants. Congress meets on the 1st of January and sits for sixty consecutive days. The executive is entrusted to the president, who is nominated and elected for four years by popular vote, and is re-eligible for a second but not for a third consecutive term. He is assisted by a council of ministers representing the departments of the interior, war, finance, public works, education and justice. For purposes of local administration the republic is divided into sixteen departments. The highest judicial power is vested in the Supreme Court, which consists of five popularly elected judges; there are also four Courts of Appeal, besides subordinate departmental and district tribunals. The active army consists of about 500 regular soldiers and 20,000 militia, recruited by conscription from all able-bodied males between the ages of twenty and thirty. Service in the reserve is obligatory for a further period of ten years.

Religion and Education.—Roman Catholicism is the creed of a very large majority of the population; but the constitution grants complete liberty to all religious communities, and so Church is supported by public funds or receives any other special privilege. Education is free, secular and compulsory for children between the ages of seven and fifteen. There are primary schools in every convenient centre, but the percentage of illiterates is high, especially among the Indians. The state maintains a central institute and a university at Tegucigalpa, a school of jurisprudence at Comayagua, and colleges for secondary education, with special schools for teachers, in each department. The annual cost of primary education is about £11,000.

History.—It was at Cape Honduras that Columbus first landed on the American continent in 1502, and took possession of the country on behalf of Spain. The first settlement was made in 1524 by order of Hernando Cortes, who had heard rumours of rich and populous empires in this region, and sent his lieutenant Christobal de Olid to found a Spanish colony. Olid endeavoured to establish an independent principality, and, in order to resume control of the settlers, Cortes was compelled to undertake the long and arduous march across the mountains of southern Mexico and Guatemala. In the spring of 1525 he reached the colony and founded the city which is now Puerto Cortes. He entrusted the administration to a new governor,

whose successors were to be nominated by the king, and returned to Mexico in 1526. By 1539, when Honduras was incorporated in the captaincy-general of Guatemala, the mines of the province had proved to be the richest as yet discovered in the New World and several large cities had come into existence. The system under which Honduras was administered from 1539 to 1821, when it repudiated the authority of the Spanish crown, the effects of that system, the part subsequently played by Honduras in the protracted struggle for Central American unity, and the invasion by William Walker and his fellow-adventurers (1856-1860), are fully described under CENTRAL AMERICA.

War and revolution had stunted the economic growth of the country and retarded every attempt at social or political reform; its future was mortgaged by the assumption of an enormous burden of debt in 1869 and 1870. A renewal of war with Guatemala in 1871, and a revolution three years later in the interests of the ex-president Medina, brought about the intervention of the neighbouring states and the provisional appointment to the presidency of Marco Aurelio Soto, a nominee of Guatemala. This appointment proved successful and was confirmed by popular vote in 1877 and 1880, when a new constitution was issued and the seat of government fixed at Tegucigalpa. Fresh outbreaks of civil war occurred frequently between 1883 and 1903; the republic was bankrupt and progress again at a standstill. In 1903 Manuel Bonilla, an able, popular and experienced general, gained the presidency and seemed likely to repeat the success of Soto in maintaining order. As his term of office drew to a close, and his re-election appeared certain, the supporters of rival candidates and some of his own dissatisfied adherents intrigued to secure the co-operation of Nicaragua for his overthrow. Bonilla welcomed the opportunity of consolidating his own position which a successful war would offer; José Santos Zelaya, the president of Nicaragua, was equally ambitious; and several alleged violations of territory had embittered popular feeling on both sides. The United States and Mexican governments endeavoured to secure a peaceful settlement without intervention, but failed. At the outbreak of hostilities in February 1907 the Hondurian forces were commanded by Bonilla in person and by General Sotero Barahona his minister of war. One of their chief subordinates was Lee Christmas, an adventurer from Memphis, Tennessee, who had previously been a locomotive-driver. Honduras received active support from his ally, Salvador, and was favoured by public opinion throughout Central America. But from the outset the Nicaraguans proved victorious, largely owing to their remarkable mobility. Their superior naval force enabled them to capture Puerto Cortes and La Ceiba, and to threaten other cities on the Caribbean coast; on land they were aided by a body of Hondurian rebels, who also established a provisional government. Zelaya captured Tegucigalpa after severe fighting, and besieged Bonilla in Amapala. Lee Christmas was killed. The surrender of Amapala on the 11th of April practically ended the war. Bonilla took refuge on board the United States cruiser "Chicago." A noteworthy feature of the war was the attitude of the American naval officers, who landed marines, arranged the surrender of Amapala, and prevented Nicaragua prolonging hostilities. Honduras was now evacuated by the Nicaraguans and her provisional government was recognized by Zelaya. Miguel R. Davila was president in 1908 and 1909.

BIBLIOGRAPHY.—Official documents such as the annual presidential message and the reports of the ministries are published in Spanish at Tegucigalpa. Other periodical publications which throw much light on the movement of trade and politics are the British Foreign Office reports (London, annual), United States consular reports (Washington, monthly), bulletins of the Bureau of American Republics (Washington), and reports of the Council of the Corporation of Foreign Bondholders (London, annual). For a more comprehensive account of the country and its history, the works of K. Sapper, E. G. Squier, A. H. Keane and T. Child, cited under CENTRAL AMERICA, are important. See also E. Pelletier, *Honduras et ses ports: documents officiels sur le chemin-de-fer interoceanique* (Paris, 1860); E. G. Squier, *Honduras: Description, Historical and Statistical* (London, 1870); C. Charles, *Honduras* (Chicago, 1890); *Handbook of Honduras*, published by the Bureau of American

Republics (1802); T. R. Lombard, *The New Honduras* (New York, 1887); H. Jahnay, *La République de Honduras* (Antwerp, 1898); Perry, *Directorio nacional de Honduras* (New York, 1898); H. G. Bourgeois, *Breve noticia sobre Honduras* (Tegucigalpa, 1900).

HONE, NATHANIEL (1718-1784), British painter, was the son of a merchant at Dublin, and without any regular training acquired in his youth much skill as a portrait-painter. Early in his career he left Dublin for England and worked first in various provincial towns, but ultimately settled in London, where he soon made a considerable reputation. His oil-paintings were decidedly popular, but he gained his chief success by his miniatures and enamels, which he executed with masterly capacity. He became a member of the Incorporated Society of Artists and afterwards a foundation member of the Royal Academy; but he had several disagreements with his fellow-members of that institution, and on one occasion they rejected two of his pictures, one of which was regarded as a satire on Reynolds and the other on Angelica Kauffman. Most of his contributions to the Academy exhibitions were portraits. The quality of his work varied greatly, but the merit of his miniatures and enamels entitles him to a place among the ablest artists of the British school. He executed also a few mezzotint plates of reasonable importance, and some etchings. His portrait, painted by himself two years before his death, is in the possession of the Royal Academy.

HONE, WILLIAM (1780-1842), English writer and bookseller, was born at Bath on the 3rd of June 1780. His father brought up his children with the sectarian narrowness that so frequently produces reaction. Hone received no systematic education, and was taught to read from the Bible only. His father having removed to London in 1783, he was in 1790 placed in an attorney's office. After two and a half years spent in the office of a solicitor at Chatham he returned to London to become clerk to a solicitor in Gray's Inn. But he disliked the law, and had already acquired a taste for free-thought and political agitation. Hone married in 1800, and started a book and print shop with a circulating library in Lambeth Walk. He soon removed to St Martin's Churchyard, where he brought out his first publication, *Shaw's Gardener* (1806). It was at this time that he and his friend, John Bone, tried to realize a plan for the establishment of popular savings banks, and even had an interview on the subject with the president of the Board of Trade. This scheme, however, failed. Bone joined him next in a bookseller's business; but Hone's habits were not those of a tradesman, and bankruptcy was the result. He was in 1811 chosen by the booksellers as auctioneer to the trade, and had an office in Ivy Lane. Independent investigations carried on by him into the condition of lunatic asylums led again to business difficulties and failure, but he took a small lodging in the Old Bailey, keeping himself and his now large family by contributions to magazines and reviews. He hired a small shop, or rather box, in Fleet Street but this was on two separate nights broken into, and valuable books lent for show were stolen. In 1815 he started the *Traveller* newspaper, and endeavoured vainly to exculpate Eliza Fenning, a poor girl, apparently quite guiltless, who was executed on a charge of poisoning. From February 1 to October 25, 1817, he published the *Reformer's Register*, writing in it as the serious critic of the state abuses, which he soon after attacked in the famous political squibs and parodies, illustrated by George Cruikshank. In April 1817 three *ex-officio* informations were filed against him by the attorney-general, Sir William Garrow. Three separate trials took place in the Guildhall before special juries on the 18th, 19th and 20th of December 1817. The first, for publishing Wilkes's *Catechism of a Ministerial Member* (1817), was before Mr Justice Abbot (afterwards Lord Tenterden); the second, for parodying the litany and libelling the prince regent, and the third, for publishing the *Sinecurist's Creed* (1817), a parody on the Athanasian creed, were before Lord Ellenborough (q.v.). The prosecution took the ground that the prints were calculated to injure public morals, and to bring the prayer-book and even religion itself into contempt. But there can be no doubt that the real motives of the prosecution were

political; Hone had ridiculed the habits and exposed the corruption of the prince regent and of other persons in power. He went to the root of the matter when he wished the jury "to understand that, had he been a publisher of ministerial parodies, he would not then have been defending himself on the floor of that court." In spite of illness and exhaustion Hone displayed great courage and ability, speaking on each of the three days for about seven hours. Although his judges were biased against him he was acquitted on each count, and the result was received with enthusiastic cheers by immense crowds within and without the court. Soon after the trials a subscription was begun which enabled Hone to get over the difficulties caused by his prosecution. Among Hone's most successful political satires were *The Political House that Jack built* (1810), *The Queen's Matrimonial Ladder* (1820), in favour of Queen Caroline, *The Man in the Moon* (1820), *The Political Showman* (1821), all illustrated by Cruikshank. Many of his squibs are directed against a certain "Dr Slop," a nickname given by him to Dr (afterwards Sir John) Stoddart, of *The Times*. In researches for his defence he had come upon some curious and at that time little trodden literary ground, and the results were shown by his publication in 1820 of his *Apocryphal New Testament*, and in 1823 of his *Ancient Mysteries Explained*. In 1826 he published the *Every-day Book*, in 1827-1828 the *Table-Book*, and in 1829 the *Year-Book*; all three were collections of curious information on manners, antiquities and various other subjects. These are the works by which Hone is best remembered. In preparing them he had the approval of Southey and the assistance of Charles Lamb, but pecuniarily they were not successful, and Hone was lodged in King's Bench prison for debt. Friends, however, again came to his assistance, and he was established in a coffee-house in Gracechurch Street; but this, like most of his enterprises, ended in failure. Hone's attitude of mind had gradually changed to that of extreme devoutness, and during the latter years of his life he frequently preached in Weigh House Chapel, Eastcheap. In 1830 he edited *Strutt's Sports and Pastimes*, and he contributed to the first number of the *Penny Magazine*. He was also for some years sub-editor of the *Patriot*. He died at Tottenham on the 6th of November 1842.

HONE (in O. Eng. *hōn*, cognate with Swed. *hōn*; the root appears in Skt. *śāna*, *śa* to sharpen), a variety of finely siliceous stone employed for whetting or sharpening edge tools, and for abrading steel and other hard surfaces. Synonyms are hone-stone, whetstone, oilstone and sharpening stone. Hones are generally prepared in the form of flat slabs or small pencils or rods, but some are made with the outline of the special instrument they are designed to sharpen. Their abrading action is due to the quartz or silica which is always present in predominating proportion, some kinds consisting of almost pure quartz, while in others the siliceous element is very intimately mixed with aluminous or calcareous matter, forming a uniform compact stone, the extremely fine siliceous particles of which impart a remarkably keen edge to the instruments for the sharpening of which they are applied. In some cases the presence of minute garnets or magnetite assists in the cutting action. Hones are used either dry, with water, or with oil, and generally the object to be sharpened is drawn with hand pressure backward and forward over the surface of the hone; but sometimes the stone is moved over the cutting edge.

The coarsest type of stone which can be included among hones is the bat or scythe stone, a porous fine-grained sandstone used for sharpening scythes and cutters of mowing machines, and for other like purposes. Next come the ragstones, which consist of quartzose mica-schist, and give a finer edge than any sandstone. Under the head of oilstones or hones proper the most famous and best-known qualities are the German razor hone, the Turkey oilstone, and the Arkansas stone. The German razor hone, used, as its name implies, chiefly for razors, is obtained from the slate mountains near Ratisbon, where it forms a yellow vein of from 1 to 18 in. in the blue slate. It is sawn into thin slabs, and these are cemented to slabs of slate which serve as a support. Turkey oilstone is a close-grained bluish stone

containing from 70 to 75% of silica in a state of very fine division, intimately bleached with about 20 to 25% of calcite. It is obtained only in small pieces, frequently flawed and not tough, so that the slabs must have a backing of slate or wood. It is one of the most valuable of all whetstones, abrading the hardest steel, and possessing sufficient compactness to resist the pressure required for sharpening graters. The stone comes from the interior of Asia Minor, whence it is carried to Smyrna. Of Arkansas stones there are two varieties, both found in the same district, Garland and Saline counties, Arkansas, United States. The finer kind, known as Arkansas hone, is obtained in small pieces at the Hot Springs, and the second quality, distinguished as Washita stone, comes from Washita or Ouachita river. The hone yields on analysis 98% of silica, with small proportions of alumina, potash and soda, and mere traces of iron, lime, magnesia and fluorine. They are white in colour, extremely hard and keen in grit, and not easily worn down or broken. Geologically the materials are called novaculites, and are supposed to be metamorphosed sandstone silt, chert or limestone resulting from the permeation through the mass of heated alkaline siliceous waters. The finer kind is employed for fine cutting instruments, and also for polishing steel pivots of watch-wheels and similar minute work, the second and coarser quality being used for common tools. Both varieties are largely exported from the United States in the form of blocks, slips, pencils, rods and wheels. Other honestones are obtained in the United States from New York, New Hampshire, Vermont, Ohio (Deerlick stone) and Indiana (Hindustan or Orange stone). Among honestones of less importance in general use may be noted the Charley Forest stone—or Whittle Hill honestone—a good substitute for Turkey oilstone; Water of Ayr stone, Scotch stone, or snake stone, a pale grey carboniferous shale hardened by igneous action, used for tools and for polishing marble and copper-plates; Idwal or Welsh oilstone, used for small articles; and cutlers' greenstone from Snowdon, very hard and close in texture, used for giving the last edge to lancets.

HONEY (Chin. 蜜; Sansk. *madhu*, mead, honey; cf. A.S. *medo*, *medu*, mead; Gr. μέλι, in which θ or δ is changed into λ; Lat. *mel*; Fr. *miel*; A.S. *hunig*; Ger. *Honig*),¹ a sweet viscid liquid, obtained by bees (see **BEES**, *bee-keeping*) chiefly from the nectaries of flowers, i.e. those parts of flowers specially constructed for the elaboration of honey, and, after transportation to the hive in the proventriculus or crop of the insects, discharged by them into the cells prepared for its reception. Whether the nectar undergoes any alteration within the crop of the bee is a point on which authors have differed. Some wasps, e.g. *Myrapietra scutellaris*² and the genus *Nectarina*, collect honey. A honey-like fluid, which consists of a nearly pure solution of uncrystallizable sugar having the formula $C_6H_{12}O_6$ after drying in vacuo, and which is used by the Mexicans in the preparation of a beverage, is yielded by certain inactive individuals of *Mymecocystus mexicanus*, Wesmæl, the honey-ants or pouched ants (*hormigas mieleras* or *mochileras*) of Mexico.³ The abdomen in these insects, owing to the distensibility of the membrane connecting its segments, becomes converted into a globular thin-walled sac by the accumulation within it of the nectar supplied to them by their working comrades (Wesmæl, *Bull. de l'Acad. Roy. de Brux.* v. 766, 1838). By the Rev. H. C. M'Cook, who discovered the insect in the Garden of the Gods, Colorado, the honey-bearers were found hanging by their feet, in groups of about thirty, to the roofs of special chambers in their underground nests, their large globular abdomens causing them to resemble "bunches of small Delaware grapes" (*Proc. Acad. Nat. Sci. Philad.*, 1870, p. 197). A bladder-like formation on the metathorax of another ant, *Crematogaster inflatus* (F. Smith, *Cat. of Hymenoptera*, pt. vi. pp. 136 and 200, pl. ix. fig. 1),

¹ The term honey in its various forms is peculiar to the Teutonic group of languages, and in the Gothic New Testament is wanting, the Greek word being there translated *melih*.

² See A. White, in *Ann. and Mag. Nat. Hist.* vii. 315, pl. 4.

³ Wetherill (*Chem. Gaz.* xi. 72, 1853) calculates that the average weight of the honey is 8.2 times that of the body of the ant, or 0.3942 grammes.

which has a small circular orifice at each posterior lateral angle, appears to possess a function similar to that of the abdomen in the honey-ant.

It is a popular saying that where is the best honey there also is the best wool; and a pastoral district, since it affords a greater profusion of flowers, is superior for the production of honey to one under tillage.⁴ Dry warm weather is that most favourable to the secretion of nectar by flowers. This they protect from rain by various internal structures, such as papillae, cushions of hairs and spurs, or by virtue of their position (in the raspberry, drooping), or the arrangement of their constituent parts. Dr A. W. Bennett (*How Flowers are Fertilised*, p. 31, 1873) has remarked that the perfume of flowers is generally derived from their nectar; the blossoms of some plants, however, as ivy and holly, though almost scentless, are highly nectariferous. The exudation of a honey-like or saccharing fluid, as has frequently been attested, is not a function exclusively of the flowers in all plants. A sweet material, the manna of pharmacy, e.g. is produced by the leaves and stems of a species of ash, *Fraxinus Ormus*; and honey-secreting glands are to be met with on the leaves, petioles, phyllodes, stipules (as in *Vicia sativa*), or bractæ (as in the *Marcgraviaceae*) of a considerable number of different vegetable forms. The origin of the honey-yielding properties manifested specially by flowers among the several parts of plants has been carefully considered by Darwin, who regards the saccharine matter in nectar as a waste product of chemical changes in the sap, which, when it happened to be excreted within the envelopes of flowers, was utilized for the important object of cross-fertilization, and subsequently was much increased in quantity, and stored in various ways (see *Cross and Self Fertilization of Plants*, pp. 402 sq., 1876). It has been noted with respect to the nectar of the fuchsia that it is most abundant when the anthers are about to dehisce, and absent in the unexpanded flower.

Pettigrew is of opinion that few bees go more than 2 m. from home in search of honey. The number of blossoms visited in order to meet the requirements of a single hive of bees must be very great; for it has been found by A. S. Wilson ("On the Nectar of Flowers," *Brit. Assoc. Rep.*, 1878, p. 567) that 125 heads of common red clover, which is a plant comparatively abundant in nectar, yield but one gramme (15.432 grains) of sugar; and as each head contains about 60 florets, 7,500,000 distinct flower-tubes must on this estimate be exhausted for each kilogramme (2.204 lb) of sugar collected. Among the richer sources of honey are reckoned the apple, asparagus, asters, barberry, basswood (*Tilia americana*), and the European lime or linden (*T. europæa*), beans, bonsets (*Eupatorium*), borage, broom, buckwheat, catnip, or catmint (*Nepeta Cataria*), cherry, clove, clover, cotton, crocus, currant, dandelion, eucalyptus, figwort (*Scrophularia*), furze, golden-rod (*Solidago*), gooseberry, hawthorn, heather, hepatica, horehound, hyacinth, lucerne, maple, mignonette, mint, motherwort (*Leonurus*), mustard, onion, peach, pear, poplar, quince, rape, raspberry, sage, silver maple, snapdragon, sour-wood (*Oxydendron arboreum*, D.C.), strawberry, sycamore, teasel, thyme, tulip-tree (more especially rich in pollen), turnip, violet and willow, and the "honey-dew" of the leaves of the whitethorn (Bonner), oak, linden, beech and some other trees.

Honey contains dextroglucose and laevoglucose (the former practically insoluble, the latter soluble in $\frac{1}{2}$ pt. of cold strong alcohol), cane-sugar (according to some), mucilage, water, wax, essential oil, colouring bodies, a minute quantity of mineral matter and pollen. By a species of fermentation, the cane-sugar is said to be gradually transformed into inverted sugar (laevoglucose with dextroglucose). The pollen, as a source of nitrogen, is of importance to the bees feeding on the honey. It may be obtained for examination as a sediment from a mixture of honey and water. Other substances which have been discovered in honey are mannite (Guibourt), a free acid which precipitates the salts of silver and of lead, and is soluble in water and alcohol (Calloux), and an uncrystallizable sugar, nearly related to inverted sugar (Soubeiran, *Compt. Rend.* xxviii. 774-775, 1849). Brittany honey contains *convain*, a ferment which determines its active decomposition (Wurtz, *Dict. de Chem.* ii. 430). In the honey of *Polybia apicipennis*, a wasp

⁴ Compare Isa. vii. 15, 22, where curdled milk (A.V. "butter") and honey as exclusive articles of diet are indicative of foreign invasion, which turns rich agricultural districts into pasture lands or uncultivated wastes.

of tropical America, cane-sugar occurs in crystals of large size (Karsten, *Pogg. Ann.*, C. 550). Dr J. Campbell Brown ("On the Composition of Honey," *Analyst* iii. 267, 1878) is doubtful as to the presence of cane-sugar in any one of nine samples, from various sources, examined by him. The following average percentage numbers are afforded by his analyses: laevulose, 36.45; dextrose, 36.57; mineral matter, .15; water expelled at 100° C., 18.5, and at a much higher temperature, with loss, 7.81: the wax, pollen and insoluble matter vary from a trace to 2.1%. The specific gravity of honey is about 1.41. The rotation of a polarized ray by a solution of 16.26 grammes of crude honey in 100 c.c. of water is generally from -3.2° to -5° at 60° F.; in the case of Greek honey it is nearly -5.5° . Almost all pure honey, when exposed for some time to light and cold, becomes more or less granular in consistency. Any liquid portion can be readily separated by straining through linen. Honey sold out of the comb is commonly clarified by beating and skimming; but according to Bonner it is always best in its natural state. The *mel depuratum* of British pharmacy is prepared by heating honey in a water-bath, and straining through flannel previously moistened with warm water.

The term "virgin-honey" (A.-S., *huniglear*) is applied to the honey of young bees which have never swarmed, or to that which flows spontaneously from honeycomb with or without the application of heat. The honey obtained from old hives, considered inferior to it in quality, is ordinarily darker, thicker and less pleasant in taste and odour. The yield of honey is less in proportion to weight in old than in young or virgin combs. The far-famed honey of Narbonne is white, very granular and highly aromatic; and still finer honey is that procured from the Corbières Mountains, 6 to 9 m. to the south-west. The honey of Gâtinais is usually white, and is less odorous and granulates less readily than that of Narbonne. Honey from white clover has a greenish-white, and that from heather a rich golden-yellow hue. What is made from honey-dew is dark in colour, and disagreeable to the palate, and does not candy like good honey. "We have seen aphide honey from sycamores," says F. Cheshire (*Pract. Bee-keeping*, p. 74), "as deep in tone as walnut liquor, and where much of it is stored the value of the whole crop is practically nil." The honey of the stingless bees (*Meliponia* and *Trigona*) of Brazil varies greatly in quality according to the species of flowers from which it is collected, some kinds being black and sour, and others excellent (F. Smith, *Trans. Ent. Soc.*, 3d ser., i. pt. vi., 1865). That of *Apis Peronii*, of India and Timor, is yellow, and of very agreeable flavour and is more liquid than the British sorts. *A. unicolor*, a bee indigenous to Madagascar, and naturalized in Mauritius and the island of Réunion, furnishes a thick and syrupy, peculiarly scented green honey, highly esteemed in Western India. A rose-coloured honey is stated (*Gard. Chron.*, 1870, p. 1698) to have been procured by artificial feeding. The fine aroma of Maltese honey is due to its collection from orange blossoms. Narbonne honey being harvested chiefly from Labiate plants, as rosemary, an imitation of it is sometimes prepared by flavouring ordinary honey with infusion of rosemary flowers.

Adulterations of honey are starch, detectable by the microscope, and by its blue reaction with iodine, also wheaten flour, gelatin, chalk, gypsum, pipe-clay, added water, cane-sugar and common syrup, and the different varieties of manufactured glucose. Honey sophisticated with glucose containing copperas as an impurity is turned of an inky colour by liquids containing tannin, as tea. Elm leaves have been used in America for the flavouring of imitation honey. Stone jars should be employed in preference to common earthenware for the storage of honey, which acts upon the lead glaze of the latter.

Honey is mildly laxative in properties. Some few kinds are poisonous, as frequently the reddish honey stored by the Brazilian wasp *Neclarina* (*Polistes*, Latr.) *Lecheguana*, Shuck., the effects of which have been vividly described by Aug. de Saint-Hilaire,² the spring honey of the wild bees of East Nepaul, said to be rendered noxious by collection from rhododendron

¹ *Mémoires du Muséum*, xi. 313 (1824).

² *Id.* xii. 293, pl. xii. fig. B (1825). The honey, according to Lassaigue (*ib.* ix. 319), is almost entirely soluble in alcohol.

flowers (Hooker, *Himalayan Journals*, i. 190, ed. 1855), and the honey of Trebizond, which from its source, the blossoms, it is stated, of *Azalea pontica* and *Rhododendron ponticum* (perhaps to be identified with Pliny's *Aegalethron*), acquires the qualities of an irritant and intoxicant narcotic, as described by Xenophon (*Anab.* iv. 8). Pliny (*Nat. Hist.* xii. 45) describes as noxious a livid-coloured honey found in Persia and Gaetulia. Honey obtained from *Kalmia latifolia*, L., the calico bush, mountain laurel or spoon-wood of the northern United States, and allied species, is reputed deleterious; also that of the sour-wood is by some good authorities considered to possess undeniable griping properties; and G. Bidie (*Madras Quart. Journ. Med. Sci.*, Oct. 1861, p. 399) mentions urtication, headache, extreme prostration and nausea, and intense thirst among the symptoms produced by a small quantity only of a honey from Coorg jungle. A South African species of *Euphorbia*, as was experienced by the missionary Moffat (*Miss. Lab.* p. 32, 1849), yields a poisonous honey. The nectar of certain flowers is asserted to cause even in bees a fatal kind of vertigo. As a demulcent and flavouring agent, honey is employed in the *oxymel*, *oxymel scillae*, *mel boracis*, *confectio piperis*, *conf. scammonii* and *conf. terebinthinae* of the *British Pharmacopoeia*. To the ancients honey was of very great importance as an article of diet, being almost their only available source of sugar. It was valued by them also for its medicinal virtues; and in recipes of the Saxon and later periods it is a common ingredient.³ Of the eight kinds of honey mentioned by the great Indian surgical writer Susruta, four are not described by recent authors, viz. *argha* or wild honey, collected by a sort of yellow bee; *chhatra*, made by tawny or yellow wasps; *audlaka*, a bitter and acrid honey-like substance found in the nest of white ants; and *dala* or unprepared honey occurring on flowers. According to Hindu medical writers, honey when new is laxative, and when more than a year old astringent (U. C. Dutt, *Mat. Med. of the Hindus*, p. 277, 1877). Cerumel, formed by mixing at a gentle heat one part by weight of yellow wax with four of clarified honey, and straining, is used in India and other tropical countries as a mild stimulant for ulcers in the place of animal fats, which there rapidly become rancid and unfit for medicinal purposes. The *Koran*, in the chapter entitled "The Bee," remarks with reference to bees and their honey: "There proceedeth from their bellies a liquor of various colour, wherein is a medicine for men" (Sale's *Koran*, chap. xvi.). Pills prepared with honey as an excipient are said to remain undurated, however long they may be kept (*Med. Times*, 1857, i. 269). Mead, of yore a favourite beverage in England (vol. iv. p. 264), is made by fermentation of the liquor obtained by boiling in water combs from which the honey has been drained. In the preparation of sack-mead, an ounce of hops is added to each gallon of the liquor, and after the fermentation a small quantity of brandy. Methoglin, or hydromel, is manufactured by fermenting with yeast a solution of honey flavoured with boiled hops (see Cooley, *Cyclop.*). A kind of mead is largely consumed in Abyssinia (vol. i. p. 64), where it is carried on journeys in large horns (Stern, *Wanderings*, p. 317, 1862). In Russia a drink termed *lipex* is made from the delicious honey of the linden. The *mulsum* of the ancient Romans consisted of honey, wine and water boiled together. The *darre*, or *piment*, of Chaucer's time was wine mixed with honey and spices, and strained till clear; a similar drink was *bracket*, made with wort of ale instead of wine. L. Maurial (*L'Insectologie Agricole* for 1868, p. 206) reports unfavourably as to the use of honey for the production of alcohol; he recommends it, however, as superior to sugar for the thickening of liqueurs, and also as a means of sweetening imperfectly ripened vintages. It is occasionally employed for giving strength and flavour to ale. In ancient Egypt it was valued as an embalming material; and in the East, for the preservation of fruit, and the making of cakes, sweetmeats,

³ For a list of fifteen treatises concerning honey, dating from 1625 to 1868, see Waring, *Biol. Therap.* ii. 559, New Syd. Soc. (1879). On sundry ancient uses for honey, see Bockmann, *Hist. of Insect.* i. 287 (1846).

and other articles of food, it is largely consumed. Grafts, seeds and birds' eggs, for transmission to great distances, are sometimes packed in honey. In India a mixture of honey and milk, or of equal parts of curds, honey and clarified butter (Sansk., *madhu-parka*), is a respectful offering to a guest, or to a bridegroom on his arrival at the door of the bride's father; and one of the purificatory ceremonies of the Hindus (Sansk., *madhu-prāsana*) is the placing of a little honey in the mouth of a newborn male infant. Honey is frequently alluded to by the writers of antiquity as food for children; it is not to this, however, as already mentioned, that Isa. vii. 15 refers. Cream or fresh butter together with honey, and with or without bread, is a favourite dish with the Arabs.

Among the observances at the Fandràna or New Year's Festival, in Madagascar, is the eating of mingled rice and honey by the queen and her guests; in the same country honey is placed in the sacred water of sprinkling used at the blessing of the children previous to circumcision (Sibree, *The Great African Is.* pp. 210, 314, 1880). Honey was frequently employed in the ancient religious ceremonies of the heathen, but was forbidden as a sacrifice in the Jewish ritual (Lev. ii. 11). With milk or water it was presented by the Greeks as a libation to the dead (*Odys.* xi. 27; Eurip. *Orest.* 115). A honey-cake was the monthly food of the fabled serpent-guardian of the Acropolis (Herod. viii. 41). By the aborigines of Peru honey was offered to the sun.

The Hebrew word translated "honey" in the authorized version of the English Bible is *debash*, practically synonymous with which are *ja'ar* or *ja'arith had-debesh* (1 Sam. xix. 25-27; cf. Cant. v. 1) and *nopheth* (Ps. xix. 10, &c.), rendered "honey-comb." *Debesh* denotes bee-honey (as in Deut. xxxiii. 13 and Jud. xiv. 8); the manna of trees, by some writers considered to have been the "wild honey," eaten by John the Baptist (Matt. iii. 4); the syrup of dates or the fruits themselves; and probably in some passages (as Gen. xlii. 11 and Ex. xxvii. 17) the syrupy boiled juice of the grape, resembling thin molasses, in use in Palestine, especially at Hebron, under the name of *dibs* (see Kitto, *Cyclop.*, and E. Robinson, *Bibl. Res.* ii. 81). Josephus (*B. J.*, iv. 8, 3) speaks highly of a honey produced at Jericho, consisting of the expressed juice of the fruit of palm trees; and Herodotus (iv. 194) mentions a similar preparation made by the Cypriotes in North Africa, where it is still in use. The honey most esteemed by the ancients was that of Mount Hybla in Sicily, and of Mount Hymettus in Attica (iii. 59). Mahaffy (*Rambles in Greece*, p. 148, 2nd ed., 1878) describes the honey of Hymettus as by no means so good as the produce of other parts of Greece—not to say of the heather hills of Scotland and Ireland. That of Thebes, and more especially that of Corinth, which is made in the thorny hills towards Cleonæ, he found much better (cf. xi. 88). Honey and wax, still largely obtained in Corsica (vi. 440), were in olden times the chief productions of the island. In England, in the 13th and 14th centuries, honey sold at from about 7d. to 1s. 2d. a gallon, and occasionally was disposed of by the swarm or hive, or *ruscha* (Rogers, *Hist. of Agric. and Prices in Eng.*, i. 418). At Wrexham, Denbigh, Wales, two honey fairs are annually held, one on the Thursday next after the 1st of September, and the other—the more recently instituted and by far the larger—on the Thursday following the first Wednesday in October. In Hungary the amounts of honey and of wax are in favourable years respectively about 190,000 and 12,000 cwt., and in unfavourable years, as, e.g. 1874, about 12,000 and 3000 cwt. The hives there in 1870 numbered 617,407 (or 40 per 1000 of the population, against 45 in Austria). Of these 365,711 were in Hungary Proper, and 91,348 (87 per 1000 persons) in the Military Frontier (Klelet, *Übersicht der Bevölk. Ungarns*, 1871; Schwicker, *Statistik d. K. Ungarns*, 1877). In Poland the system of bee-keeping introduced by Dolinowski has been found to afford an average of 40 lb of honey and wax and two new swarms per hive; the common peasant's hive yielding, with two swarms, only 3 lb of honey and wax. In forests and places remote from villages in Podolia and parts of Volhynia, as many as 1000 hives may be seen in one apiary. In the district of Ostrolenka, in the government of Plock, and in the woody region of Polesia, in Lithuania, a method is practised of rearing bees in excavated trunks of trees (Stanton, "On the Treatment of Bees in Poland," *Technologist*, vi. 45, 1866). When, in August, in the loftier valleys of Bormio, Italy, flowering ceases, the bees in their wooden hives are by means of spring-carts transported at night to lower regions, where they obtain from the buckwheat crops the inferior honey which serves them for winter consumption (*ib.* p. 38).

In Palestine, "the land flowing with milk and honey" (Ex. iii. 17; Numb. xiii. 27), wild bees are very numerous, especially in the

¹ In Sanskrit, *madhu-kulya*, a stream of honey, is sometimes used to express an overflowing abundance of good things (Monier Williams, *Sansk.-Eng. Dict.*, p. 736, 1872).

wilderness of Judæa, and the selling of their produce, obtained from crevices in rocks, hollows in trees and elsewhere, is with many of the inhabitants a means of subsistence. Commenting on 1 Sam. xiv. 26, J. Roberts (*Oriental Illustr.*) remarks that in the East "the forests literally flow with honey; large combs may be seen hanging on the trees, as you pass along, full of honey." In Galilee, and at Bethlehem and other places in Palestine, bee-keeping is extensively carried on. The hives are sun-burnt tubes of mud, about 4 ft. in length and 8 in. in diameter, and, with the exception of a small central aperture for the passage of the bees, closed at each end with mud. These are laid together in long rows, or piled pyramidally, and are protected from the sun by a covering of mud and of boughs. The honey is extracted, when the ends have been removed, by means of an iron hook. (See Tristram, *Nat. Hist. of the Bible*, pp. 322 sqq., and ed., 1868). Apiculture in Turkey is in a very rude condition. The Bali-dagh, or "Honey Mount," in the plain of Troy, is so called on account of the numerous wild bees tenanted the caves in its precipitous rocks to the south. In various regions of Africa, as on the west, near the Gambia, bees abound. Cameron was informed by his guides that the large quantities of honey at the cliffs by the river Makanyazi were under the protection of an evil spirit, and not one of his men could be persuaded to gather any (*Across Africa*, i. 266). On the precipitous slopes of the Teesta valley, in India, the procuring of honey from the pendulous bees'-nests, which are sometimes large enough to be conspicuous features at a mile's distance, is the only means by which the idle poor raise their annual rent (Hooker, *Him. Journ.* ii. 41).

To reach the large combs of *Apis dorsata* and *A. testacea*, the natives of Timor, by whom both the honey and young bees are esteemed delicacies, ascend the trunks of lofty forest trees by the use of a loop of creeper. Protected from the myriads of angry insects by a small torch only, they detach the combs from the under surface of the branches, and lower them by slender cords to the ground (Wallace, *Journ. Linn. Soc.*, Zool., vol. xi.). (F. H. B.)

HONEYCOMB, a cloth, so called because of the particular arrangement of the crossing of the warp and weft threads which form cells somewhat similar to those of the real honeycomb. They differ from the latter in that they are rectangular instead of hexagonal. The bottom of the cell is formed by those threads and picks which weave "plain," while the ascending sides of the figure are formed by the gradually increasing length of float of the warp and weft yarns.

The figure shows two of the commonest designs which are used for these cloths, design A being what is often termed the "perfect honeycomb"; in the figure it will be seen that the highest number of successive white squares is seven, while the corresponding highest number of successive black squares is five. Two of each of these maximum floats form the top or highest edges of the cell, and the number of successive like squares decreases as the bottom of the cell is reached when the floats are one of black and one of white (see middle of design, &c.). The weave produces a reversible cloth, and it is extensively used for the embellishment of quilts and other fancy goods. It is also largely used in the manufacture of cotton and linen towels. B is, for certain purposes, a more suitable weave than A, but both are very largely used for the latter class of goods.

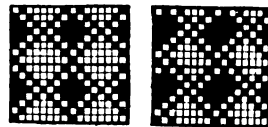

A

B

HONEY-EATER, or **HONEY-SUCKER**, names applied by many writers in a very loose way to a large number of birds, some of which, perhaps, have no intimate affinity; here they are used in a more restricted sense for what, in the opinion of a good many recent authorities,² should really be deemed the family *Meliphagidae*—excluding therefrom the *Nectariniidae* or **SUN-BIRDS** (*q.v.*) as well as the genera *Promerops* and *Zosterops* with whatever allies they may possess. Even with this restriction, the extent of the family must be regarded as very indefinite, owing to the absence of materials sufficient for arriving at a satisfactory conclusion, though the existence of such a family is probably indisputable. Making allowance, then, for the imperfect light in which they must at present be viewed, what are here called *Meliphagidae* include some of the most characteristic forms of the ornithology of the great Australian region—members of the family inhabiting almost every part of it, and a single species only, *Ptilotis limbata*, being said to occur outside its limits. They all possess, or are supposed to possess, a long

² Among them especially A. R. Wallace, *Geogr. Distr. Animals*, ii. 275.

protrusible tongue with a brush-like tip, differing, it is believed, in structure from that found in any other bird—*Promerops* perhaps excepted—and capable of being formed into a suctorial tube, by means of which honey is absorbed from the nectary of flowers, though it would seem that insects attracted by the honey furnish the chief nourishment of many species, while others undoubtedly feed to a greater or less extent on fruits. The *Meliphagidae*, as now considered, are for the most part small birds, never exceeding the size of a missel thrush; and they have been divided into more than 20 genera, containing above 200 species, of which only a few can here be particularized. Most of these species have a very confined range, being found perhaps only on a single island or group of islands in the region, but there are a few which are more widely distributed—such as *Glycyphila rufifrons*, the white-throated¹ honey-eater, found over the greater part of Australia and Tasmania. In plumage they vary much. Most of the species of *Ptilotis* are characterized by a tuft of white, or in others of yellow, feathers springing from behind the ear. In the greater number of the genus *Myzomela*² the males are recognizable by a gorgeous display of crimson or scarlet, which has caused one species, *M. sanguinolenta*, to be known as the soldier-bird to Australian colonists; but in others no brilliant colour appears, and those of several genera have no special ornamentation, while some have a particularly plain appearance. One of the most curious forms is *Prothemadera*—the tui or parson-bird of New Zealand, so called from the two tufts of white feathers which hang beneath its chin in great contrast to its dark silky plumage, and suggest a likeness to the bands worn by ministers of several religious denominations when officiating.³ The bell-bird of the same island, *Anthornis melanura*—whose melody excited the admiration of Cook the morning after he had anchored in Queen Charlotte's Sound—is another member of this family, and unfortunately seems to be fast becoming extinct. But it would be impossible here to enter much further into detail, though the wattle-birds, *Anthochaera*, of Australia have at least to be named. Mention, however, must be made of the friar-birds, *Tropidorhynchus*, of which nearly a score of species, five of them belonging to Australia, have been described. With their stout bills, mostly surmounted by an excrescence, they seem to be the most abnormal forms of the family, and most of them are besides remarkable for the baldness of some part at least of their head. They assemble in troops, sitting on dead trees, with a loud call, and are very pugnacious, frequently driving away hawks and crows. A. R. Wallace (*Malay Archipelago*, ii. 150-153) discovered the curious fact that two species of this genus—*T. bowrensis* and *T. subcornutus*—respectively inhabiting the islands of Bouru and Ceram, were the object of natural "mimicry" on the part of two species of oriole of the genus *Mimeta*, *M. bourensis* and *M. forsteni*, inhabiting the same islands, so as to be on a superficial examination identical in appearance—the honey-eater and the oriole of each island presenting exactly the same tints—the black patch of bare skin round the eyes of the former, for instance, being copied in the latter by a patch of black feathers, and even the protuberance on the beak of the *Tropidorhynchus* being imitated by a similar enlargement of the beak of the *Mimeta*. The very reasonable explanation which Wallace offers is that the pugnacity of the

¹ The young of this species has the throat yellow.

² W. A. Forbes published a careful monograph of this genus in the *Proceedings of the Zoological Society* for 1879, pp. 256-279.

³ This bird, according to Sir Walter Buller (*Birds of New Zealand*, p. 88), while uttering its wild notes, indulges in much gesticulation, which adds to the suggested resemblance. It has great power of mimicry, and is a favourite cage-bird both with the natives and colonists. On one occasion, says Buller, he had addressed a large meeting of Maories on a matter of considerable political importance, when "immediately on the conclusion of my speech, and before the old chief to whom my arguments were chiefly addressed had time to reply, a tui, whose netted cage hung to a rafter overhead, responded in a clear, emphatic way, 'Tito' (Gale). The circumstance naturally caused much merriment among my audience, and quite upset the gravity of the venerable old chief, Nepia Taratoa. 'Friend,' said he, laughing, 'your arguments are very good; but my *mokosi* is a very wise bird, and he is not yet convinced!'"

former has led the smaller birds of prey to respect it, and it is therefore an advantage for the latter, being weaker and less courageous, to be mistaken for it. (A. N.)

HONEY-GUIDE, a bird so called from its habit of pointing out to man and to the ratel (*Mellivora capensis*) the nests of bees. Stories to this effect have been often told, and may be found in the narratives of many African travellers, from Bruce to Livingstone. But Layard says (*B. South Africa*, p. 242) that the birds will not infrequently lead any one to a leopard or a snake, and will follow a dog with vociferations, though its noisy cry and antics unquestionably have in many cases the effect signified by its English name. If not its first discoverer, Sparrman, in 1777, was the first who described and figured this bird, which he met with in the Cape Colony (*Phil. Trans.*, lxxvii. 42-47, pl. i.), giving it the name of *Cuculus indicator*, its zygodactylous feet with the toes placed in pairs—two before and two behind—including the belief that it must be referred to that genus. Vieillot in 1816 elevated it to the rank of a genus, *Indicator*; but it was still considered to belong to the family *Cuculidae* (its asserted parasitical habits lending force to that belief) by all systematists except Blyth and Jerdon, until it was shown by Blanford (*Obs. Geol. and Zool. Abyssinia*, pp. 308, 309) and Sclater (*Ibis*, 1870, pp. 176-180) that it was more allied to the barbets, *Capitonidae*, and, in consequence, was then made the type of a distinct family, *Indicatoridae*. In the meanwhile other species had been discovered, some of them differing sufficiently to warrant Sundevall's foundation of a second genus, *Prodotiscus*, of the group. The honey-guides are small birds, the largest hardly exceeding a lark in size, and of plain plumage, with what appears to be a very sparrow-like bill. Bowdler Sharpe, in a revision of the family published in 1876 (*Orn. Miscellany*, i. 192-209), recognizes ten species of the genus *Indicator*, to which another was added by Dr Reichenow (*Journ. für Ornithologie*, 1877, p. 110), and two of *Prodotiscus*. Four species of the former, including *I. sparrmani*, which was the first made known, are found in South Africa, and one of the latter. The rest inhabit other parts of the same continent, except *I. archipelagicus*, which seems to be peculiar to Borneo, and *I. xanthonotus*, which occurs on the Himalayas from the borders of Afghanistan to Bhutan. The interrupted geographical distribution of this genus is a very curious fact, no species having been found in the Indian or Malayan peninsula to connect the outlying forms with those of Africa, which must be regarded as their metropolis. (A. N.)

HONEY LOCUST, the popular name of a tree, *Gleditsia triacanthos*, a member of the natural order Leguminosae, and a native of the more eastern United States of North America. It reaches from 75 to 140 ft. in height with a trunk 2 or 3, or sometimes 5 or 6 ft. in diameter, and slender spreading branches which form a broad, flattish crown. The branchlets bear numerous simple or three-forked (whence the species-name *triacanthos*) sharp stiff spines, 3 to 4 in. long, at first red in colour, then chestnut brown; they are borne above the leaf-axils and represent undeveloped branchlets; sometimes they are borne also on the trunk and main branches. The long-stalked leaves are 7 to 8 in. long with eight to fourteen pairs of narrowly oblong leaflets. The flowers, which are of two kinds, are borne in racemes in the leaf-axils; the staminate flowers in larger numbers. The brown pods are often 12 to 18 in. long, have thin, tough walls, and contain a quantity of pulp between the seeds; they contract spirally when drying. The tree was first cultivated in Europe towards the end of the 17th century by Bishop Compton in his garden at Fulham, near London, and is now extensively planted as an ornamental tree. The name of the genus commemorates Johann Gottlieb Gleditsch (1714-1786), a friend of Linnaeus, and the author of one of the earliest works on scientific forestry.

HONEYMOON, the first month after marriage. Lord Avebury in his *Origin of Civilization* suggests that the seclusion usually associated with this period is a survival of marriage by capture, and answers to the period during which the husband kept his wife in retirement, to prevent her from appealing to her relatives

for release. Others suggest that as the moon commences to wane as soon as it is at its full, so does the mutual affection of the wedded pair, the "honeymoon" (with this derivation) not necessarily referring to any definite period of time.

HONEYSUCKLE (Mid. Eng., *honyssode*, i.e. any plant from which honey may be sucked.—cl. A.-S. *huni-suge*, privet; Ger. *Geissblatt*; Fr. *chèvrefeuille*), botanical name *Lonicera*, a genus of climbing, erect or prostrate shrubs, of the natural order *Caprifoliaceae*, so named after the 16th-century German botanist Adam Lonicer. The British species is *L. Periclymenum*, the woodbine; *L. Caprifolium* and *L. Xylostemum* are naturalized in a few counties in the south and east of England. Some of the garden varieties of the woodbine are very beautiful, and are held in high esteem for their delicious fragrance, even the wild plant, with its pale flowers, compensating for its sickly looks "with never-dying odours." The North American sub-evergreen *L. sempervirens*, with its fine heads of blossoms,



Honeysuckle.—(a) Flowering branch; ring two on a peduncle. (b) flower, nat. size; (c) fruit, slightly reduced.

There are numerous other species, many of them introduced to our gardens, and well worth cultivating in shrubberies or as climbers on walls and bowers, either for their beauty or the fragrance of their blossoms.

In the western counties of England, and generally by agriculturists, the name honeysuckle is applied to the meadow clover, *Trifolium pratense*. Another plant of the same family (Leguminosae) *Hedysarum coronarium*, a very handsome hardy biennial often seen in old-fashioned collections of garden plants, is commonly called the French honeysuckle. The name is moreover applied with various affixes to several other totally different plants. Thus white honeysuckle and false honeysuckle are names for the North American *Azalea viscosa*; Australian or heath honeysuckle is the Australian *Banksia serrata*, Jamaica honeysuckle, *Passiflora laurifolia*, dwarf honeysuckle the widely spread *Cornus suecica*, Virgin Mary's honeysuckle the European *Pulmonaria officinalis*, while West Indian honeysuckle is *Tecoma capensis*, and is also a name applied to *Desmodium*.

The wood of the fly honeysuckle is extremely hard, and the clear portions between the joints of the stems, when their pith has been removed, were stated by Linnaeus to be utilized in Sweden for making tobacco-pipes. The wood is also employed to make teeth for rakes; and, like that of *L. tatarica*, it is a favourite material for walking-sticks.

Honeysuckles (*Lonicera*) flourish in any ordinary garden soil, but are usually sadly neglected in regard to pruning. This should be done about March, cutting out some of the old wood, and shortening back some of the younger growths of the preceding year.

(J. Ws.)

HONFLEUR, a seaport of north-western France, in the department of Calvados, 57 m. N.E. of Caen by rail. Pop. (1906) 8735. The town is situated at the foot of a semicircle of hills, on the south shore of the Seine estuary, opposite Havre, with which it communicates by steamboat. Honfleur, with its dark narrow lanes and old houses, has the typical aspect of an old-fashioned seaport. The most noteworthy of its buildings is the church of St Catherine, constructed entirely of timber work, with the exception of the façade added in the 18th century, and consisting of two parallel naves, of which the more ancient is supposed to date from the end of the 15th century. Within the church are several antique statues and a painting by J. Jordaens—"Jesus in the Garden of Gethsemane." The church tower stands on the other side of a street. St Leonard's dates from the 17th century, with the exception of its fine ogival portal and rose-window belonging to the 16th, and its octagonal tower erected in the 18th. The ruins of a 16th-century castle known as the Lieutenantance and several houses of the same period are also of antiquarian interest. The hôtel de ville contains a library and a museum. On the rising ground above the town is the chapel of Notre-Dame-de-Grâce, a shrine much resorted to by pilgrim sailors, which is said to have been founded in 1034 by Robert the Magnificent of Normandy and rebuilt in 1606. The town has a tribunal and a chamber of commerce and a communal college. The port, which is protected from the west winds by the height known as the Côte de Grâce, consists of the tidal harbour and four floating basins—The West basin, dating from the 17th century, and the Centre, East and Carnot basins. A reservoir affords the means of sluicing the channel and supplying the basins. The surface available for vessels is about 27 acres. Numerous fishing and coasting vessels frequent the harbour. In 1907 there entered 375 vessels, of 133,872 tons, more than half this tonnage being British. The exports go mainly to England and include poultry, butter, eggs, cheese, chocolate, vegetables, fruit, seeds and purple ore. There is regular communication by steamer with Southampton. Timber from Scandinavia, English coal and artificial manures form the bulk of the imports. There are important saw-mills, as well as shipbuilding yards, manufactories of chemical manures and iron foundries.

Honfleur dates from the 11th century and is thus four or five hundred years older than its rival Havre, by which it was supplanted during the 18th century. During the Hundred Years' War it was frequently taken and re-taken, the last occupation by the English ending in 1440. In 1562 the Protestant forces got possession of it only after a regular siege of the suburb of St Leonard; and though Henry IV. effected its capture in 1590 he had again to invest it in 1594 after all the rest of Normandy had submitted to his arms. In the earlier years of the 17th century Honfleur colonists founded Quebec, and Honfleur traders established factories in Java and Sumatra and a fishing establishment in Newfoundland.

HONG-KONG (properly HIAO-KIANG, the place of "sweet lagoons"), an important British island-possession, situated off the south-east coast of China, opposite the province of Kwang-tung, on the east side of the estuary of the Si-kiang, 38 m. E. of Macao and 75 S.E. of Canton, between 22° 0' and 22° 1' N., and 114° 5' and 114° 18' E. It is one of a small cluster named by the Portuguese "Ladrones" or Thieves, on account of the notorious habits of their old inhabitants. Extremely irregular in outline, it has an area of 29 sq. m., measuring 10½ m. in extreme length from N.E. to S.W., and varying in breadth from 2 to 5 m. A good military road about 22 m. long encircles the island. From the mainland it is separated by a narrow channel, which at Hong-Kong roads, between Victoria, the island capital, and Kowloon Point, is about 1 m. broad, and which narrows at Ly-co-mun Pass to little over a ¼ m. The southern coast in particular is deeply indented; and there two bold peninsulas, extending for several miles into the sea, form two capacious natural harbours, namely, Deep Water Bay, with the village of Stanley to the east, and Tytam Bay, which has a safe, well-protected entrance showing a depth of

deepened its entrance from 27 ft. to 30 ft. Six miles to the W. is the much more spacious Pearl Harbor (a U. S. Naval Station), the bar at the entrance of which was removed (1903) by the U. S. government. Pearl Harbor and the harbour of Honolulu are the only safe ports in the archipelago. The streets of Honolulu are wide, and are macadamized with crushed or broken lava. The business houses are mostly of brick or stone, and range from two to six storeys in height. About most of the residences there are many tropical trees, flowering shrubs and plants. Wood is the most common material of which the residences are built, a large portion of these residences are one-storey cottages; broad verandahs are common; and of the more pretentious residences the *lanai*, a semi-outdoor drawing-room with conservatories adjoining, is a notable feature. Throughout the city there is a marked absence of poverty and squalor. There are good hotels in the city and its suburbs. The government buildings are extensive and have a pleasing appearance; that of the executive, in a beautiful park, was formerly the royal palace and still contains many relics of royalty. Facing the judiciary building is a heroic statue in bronze of Kamehameha the Great. About 2 m. W. of the business centre of the city is the Bernice Pauahi Bishop Museum, a fine stone building on a commanding site, and containing a large collection of Hawaiian and Polynesian relics and curios, especially Hawaiian feather-work, and notable collections of fish and of Hawaiian land shells and birds. Four miles S.E. of the business centre, at the foot of Diamond Head, is Waikiki sea-beach, noted for its surf-riding, boating and bathing, and Kapiolani Park, a pleasure resort, near which is a famous aquarium of tropical fishes. Honolulu has other parks, a fine Botanical Garden, created by the Bureau of Agriculture, several public squares, several hospitals, a maternity home, the Lunalilo Home for aged Hawaiians, an asylum for the insane, several schools of high rank both public and private—notably Oahu College on the E. edge of the city, first founded as a school for the children of missionaries in 1841; the Honolulu High School, founded in 1833 as the Oahu Charity School, to teach English to the half whites; the Royal School, which was founded in 1840 for the sons of chiefs; and the Normal School, housed in what was in 1906 the most expensive building on the island of Oahu—a library containing about 14,000 volumes and the collections of the Hawaiian Historical Society, a number of benevolent, literary, social and political societies, and an art league, and is the see of both an Anglican and a Roman Catholic bishop. In 1907 the Pacific Scientific Institution for the advancement of scientific knowledge of the Pacific, its islands and their people, was established here. Among the clubs of the city are the Pacific Club, founded in 1853 as the British Club, the Scottish Thistle Club (1801), of which Robert Louis Stevenson was a member; the Hawaii Yacht Club, and the Polo, Country and University Clubs. There are various journals and periodicals, five languages being represented. The chief industries are the manufacture of machinery (especially machinery for sugar-refineries) and carriages, rice-milling and ship-building. Honolulu's total exports for the fiscal year 1908 were valued at \$42,238,455, and its imports at \$19,985,724. There is a privately owned electric street car service in the city. The water-works and electric-lighting plant are owned and operated by the Territorial government, and to the plentiful water-supply is partly due the luxuriant vegetation of the city. Honolulu's safe harbour, discovered in 1794, made it a place of resort for vessels (especially whalers) and traders from the beginning of the 19th century. Kamehameha I. (the Great) lived here from 1803 until 1811. In 1816 was built a fort which stood until 1857. In 1820 the city became the principal residence of the sovereign and soon afterwards of foreign consuls, and thus practically the seat of government. In 1907 an act was passed by which the former county of Oahu, including the island of Oahu and the small islands adjacent, was made a municipal corporation under the name of the "city and county of Honolulu"; this act came into effect on the 1st of January 1909.

HONORIUS, the name of four popes and one antipope (Honorius II.; *i.e.* 2 below).

1. **HONORIUS I.**, pope from 625 to 638, was of a noble Roman family, his father Petronius having been consul. He was very active in carrying on the work of Gregory the Great, especially in England, Bede (*Hist. Eccl.* ii. 17) gives a letter of his to King Edwin of Northumbria, in which he admonishes him diligently to study Gregory's writings; and it was at Edwin's request that Honorius conferred the pallium on the bishops of Canterbury and York (*ib.* ii. 18). He also admonished the Irish for not following the custom of the Catholic Church in the celebration of Easter (*ib.* ii. 19), and commissioned Birinus to preach Christianity in Wessex (*ib.* iii. 7). It is, however, in connexion with the Monothelite heresy that Honorius is most remembered, his attitude in this matter having acquired fresh importance during the controversy raised by the promulgation of the dogma of papal infallibility in 1870. In his efforts to consolidate the papal power in Italy, Honorius had been hampered by the schism of "the three chapters" in Istria and Venetia, a schism that was ended by the deposition in 628 of the schismatic patriarch Fortunatus of Aquileia-Grado and the elevation of a Roman sub-deacon to the patriarchate. It is suggested that help rendered to him in this matter by the emperor Heraclius, or by the Greek exarch, may have inclined the pope to take the emperor's side in the Monothelite controversy, which broke out shortly afterwards in consequence of the formula proposed by the emperor with a view to reconciling the Monophysites and the Catholics. However that may be, he joined the patriarchs of Constantinople and Alexandria in supporting the doctrine of "one will" in Christ, and expounded this view forcibly, if somewhat obscurely, in two letters to the patriarch Sergius (Epist. 4 and 5 in Migne, *Patrologia. Ser. Lat.* lxxx. 470, 474). For this he was, more than forty years after his death (October 638), anathematized by name along with the Monothelite heretics by the council of Constantinople (First Trullan) in 681; and this condemnation was subsequently confirmed by more than one pope, particularly by Leo II. See Hefele, *Die Irrlehre des Honorius u. die vatikanische Lehre der Unfehlbarkeit* (1871), who, however, modified his view in his *Concilien-geschichte* (1877). Honorius I. was succeeded by Severinus.

See the articles by R. Zöpffel and G. Krüger in Herzog-Hauck, *Realencyklopädie* (ed. 1900), and by T. Grisar in Wetzler and Welte's *Kirchenlexikon* (Freiburg, 1889). In addition to the bibliographies there given see also U. Chevalier, *Répertoire des sources hist., etc., Bio-bibliographie*, s. "Honorius I." (Paris, 1905) (W. A. F.)

2. **HONORIUS II.** (d. 1072), antipope, was the name taken by Peter Cadalus, who was born at Verona and became bishop of Parma in 1046. After the death of Pope Nicholas II. in July 1061 he was chosen pope by some German and Lombard bishops at Basel in opposition to Alexander II., who had been elected by the party led by Hildebrand, afterwards Pope Gregory VII. Taking the name of Honorius II., Cadalus was thus the representative of those who were opposed to reforms in the Church. Early in 1062 he advanced towards Rome, and though his supporters defeated the forces of his rival outside the city, he soon returned to Parma to await the decision of the advisers of the young German king, Henry IV., whose mother Agnes had supported his election. About this time, however, Agnes was deprived of her power, and the chief authority in Germany passed to Anno, archbishop of Cologne, who was hostile to Cadalus. Under these circumstances the antipope again marched towards Rome in 1063 and entered the city, but was soon forced to take refuge in the castle of St Angelo. The ensuing war between the rival popes lasted for about a year, and then Cadalus left Rome as a fugitive. Refusing to attend a council held at Mantua in May 1064, he was deposed, and he died in 1072, without having abandoned his claim to the papal chair.

See the article on Honorius II. in Hauck's *Realencyklopädie*, Band viii. (Leipzig, 1900). (A. W. H.)

3. **HONORIUS II.** (Lamberto Scannabecchi), pope from the 15th of December 1124 to the 13th of February 1130, a native of Fagnano near Imola, of considerable learning and great religious zeal, successively archdeacon at Bologna, cardinal-priest of Sta Prassede under Urban II., cardinal-bishop of Ostia and Velletri under Paschal II., shared the exile of Gelasius II.

in France, and helped Calixtus II. to conclude the Concordat of Worms (1122), which settled the investiture contest. He owed his election in large measure to force employed by the Frangipani, but was consecrated with general consent on the 21st of December 1124. By means of a close alliance with that powerful family, he was enabled to maintain peace at Rome, and the death of Emperor Henry V. (1125) further strengthened the papal position. He recognized the Saxon Lothair III. as king of the Romans and later as emperor, and excommunicated his rival, Conrad of Hohenstaufen. He sanctioned the Præmonstratensian order and that of the Knights Templars. He excommunicated Count William of Normandy for marriage in prohibited degree; brought to an end, through the influence of Bernard of Clairvaux, the struggle with Louis VI. of France; and arranged with Henry I. for the reception of papal legates in England. He laid claim as feudal overlord to the Norman possessions in southern Italy (July 1127), and excommunicated the claimant, Duke Roger of Sicily, but was unable to prevent the foundation of the Neapolitan monarchy, for Duke Roger defeated the papal army and forced recognition in August 1128. Honorius appealed to Lothair for assistance, but died before it arrived. His successor was Innocent II.

The chief sources for the life of Honorius II. are his "Epistolæ et Privilegia," in J. P. Migne, *Patrol. Lat.* vol. 166, and the *Vitæ* of Cardinals Pandulf and Boso in J. M. Watterich, *Pontif. Roman. vitæ*, vol. 2 (Leipzig, 1862); also "Codice diplomatico e bollario di Onorio II." in *Fr. Liverani opere*, vol. 4 (Macerata, 1859), and Jauffe-Wattenbach, *Regesta pontif. Roman.* (1885-1888).

See J. Langen, *Geschichte der römischen Kirche von Gregor VII. bis Innocenz III.* (Bonn, 1893); F. Gregorovius, *Rome in the Middle Ages*, vol. 4, trans. by Mrs G. W. Hamilton (London, 1896); H. H. Milman, *Latin Christianity*, vol. 4 (London, 1899); *Fr. Liverani*, "Lamberto da Fiagnano" in *Opere*, vol. 3 (Macerata, 1859); A. Wagner, *Die unteritalischen Normannen und das Papsttum 1086-1150* (Breslau, 1895); E. Bernheim, *Zur Geschichte des Wormser Concordats* (Göttingen, 1878); Volkmar, "Das Verhältnis Lothars III. zur Investiturstreitfrage," in *Forschungen zur deutschen Geschichte*, vol. 26. (C. H. H.A.)

4. HONORIUS III. (Cencio Savelli), pope from the 18th of July 1216 to the 18th of March 1227, a highly-educated and pious Roman, successively canon of Sta Maria Maggiore, cardinal-deacon of Sta Lucia in Silice, vice-chancellor, chamberlain and cardinal-priest of St. Giovanni e Paolo, was the successor of Innocent III. He made peace with Frederick II., in accordance with which the emperor was crowned with his wife Constance in St Peter's on the 22nd of November 1220, and swore to accord full liberty to the church and to undertake a crusade. Honorius was eager to carry out the decrees of the Lateran Council of 1215 against the Albigenses and to further the crusade proclaimed by his predecessor. He crowned Peter of Courtenay emperor of Byzantium in April 1217; espoused the cause of the young Henry III. of England against the barons; accepted the Isle of Man as a perpetual fief; arbitrated differences between Philip II. of France and James of Aragon; and made special ecclesiastical regulations for the Scandinavian countries. He sanctioned the Dominican order (22nd of November 1216), making St Dominic papal major-domo in 1218; approved the Franciscan order by bull of the 29th of November 1223; and authorized many of the tertiary orders. He maintained, on the whole, a tranquil rule at Rome; but Frederick II.'s refusal to interrupt his reforms in Sicily in order to go on the crusade gave the pope much trouble. Honorius died in 1227, before the emperor had fulfilled his oath, and was succeeded by Gregory IX.

Honorius III. left many writings which have been collected and published by Abbé Horoy in the *Medii ævi bibliotheca patristica*, vols. i.-ii. (Paris, 1879-1883). Among them are five books of decretals, compiled about 1226; a continuation of the *Liber Pontificalis*; a life of Gregory VII.; a coronation form; and a large number of sermons. His most important work is the *Liber censuum Romanæ ecclesiæ*, written in 1192 and containing a record of the income of the Roman Church and of its relations with secular authorities. The last named is admirably edited by P. Fabre in *Bibliothèque des écoles françaises d'Athènes et de Rome* (Paris, 1892). The letters of Honorius are in F. Liverani, *Spicilegium Liberianum* (1863). There are good *Regesta* in Latin and Italian, edited by F. Pressutti (Rome, 1888, &c.).

See J. Clausen, *Papst Honorius III.* (1895); P. T. Maas, *Die Päpste Honorius III. und Innocenz IV. a fronte dell' Imperatore Federico II. nel secolo XIII.* (1884); F. Gregorovius, *Rome in the Middle Ages*, vol. 5, trans. by Mrs G. W. Hamilton (London, 1900-1902); K. L. von Helldorff, *Conciliengeschichte*, vol. 5, 2nd ed.; H. H. Milman, *Latin Christianity*, vol. 5 (London, 1899); T. Frantz, *Der grosse Kampf zwischen Kaiser und Papsttum zur Zeit des Hohenstaufen Friedrich II.* (Berlin, 1903); W. Norden, *Das Papsttum u. Byzanz* (Berlin, 1903); M. Tangl, *Die päpstlichen Kanzleiordnungen von 1200-1500* (Innsbruck, 1894); Caillomer, *Le Pape Honorius III. et le droit civil* (Lyons, 1881); F. Vernet, *Études sur les sermons d'Honorius III.* (Lyons, 1888). There is an excellent article, with exhaustive bibliography, by H. Schulz in Hauck's *Realencyclopädie*, 3rd edition. (C. H. H.A.)

5. HONORIUS IV. (Jacopo Savelli), pope from the 2nd of April 1285 to the 3rd of April 1287, a member of a prominent Roman family and grand-nephew of Honorius III., had studied at the university of Paris, been made cardinal-deacon of Sta Maria in Cosmedin, and succeeded Martin IV. Though aged and so crippled that he could not stand alone he displayed remarkable energy as pope. He maintained peace in the states of the Church and friendly relations with Rudolph of Habsburg, and his policy in the Sicilian question was more liberal than that of his predecessor. He showed special favours to the mendicant orders and formally sanctioned the Carmelites and Augustinian Eremites. He was the first pope to employ the great banking houses in northern Italy for the collection of papal dues. He died at Rome and was succeeded by Nicholas IV.

See M. Bouquet, *Recueil des historiens des Gaules et de la France*, new ed., vols. 26-27 (Paris, 1894), for the chief sources; A. Potthast, *Regesta pontif. Roman.*, vol. 2 (Berlin, 1875); M. Prou, "Les registres d'Honorius IV." in *Bibliothèque des écoles françaises d'Athènes et de Rome* (Paris, 1888); B. Pawlicki, *Papst Honorius IV.* (Münster, 1896); F. Gregorovius, *Rome in the Middle Ages*, vol. 5, trans. by Mrs G. W. Hamilton (London, 1900-1902). (C. H. H.A.)

HONORIUS, FLAVIUS (384-423), son of Theodosius I., ascended the throne as "emperor of the West" in 395. The history of the first thirteen years of the reign of Honorius is inseparably connected with the name of Stilicho (q.v.), his guardian and father-in-law. During this period the revolt of the African prince Gildo was suppressed (398); Italy was successfully defended against Alaric, who was defeated at Pollentia (402) and Verona (403); and the barbarian hordes under the Goth Radagaisus were destroyed (406). After the downfall and murder of Stilicho (408), the result of palace intrigues, the emperor was under the control of incompetent favourites. In the same year Rome was besieged, and in 410, for the second time in its history, taken and sacked by Alaric, who for a short time set up the city prefect Attalus as a rival emperor, but soon deposed him as incapable. Alaric died in the same year, and in 412 Honorius concluded peace with his brother-in-law and successor, Ataulphus (Adolphus), who married the emperor's sister Placidia and removed with his troops to southern Gaul. A number of usurpers laid claim to the throne, the most important of whom was Constantine. In 409 Britain and Armorica declared their independence, which was confirmed by Honorius himself, and were thus practically lost to the empire. Honorius was one of the feeblest emperors who ever occupied the throne, and the dismemberment of the West was only temporarily averted by the efforts of Stilicho, and, later, of Constantius, a capable general who overthrew the usurpers and was rewarded with a share in the government. It was only as a supporter of the orthodox church and persecutor of the heathen that Honorius displayed any energy. In 399 the exercise of the pagan cult was prohibited, and the revenues of the temples, which were to be appropriated for the use of the public or pulled down, were confiscated to defray the expenses of the army. Honorius was equally severe on heretics, such as the Donatists and Manichæans. He is also to be credited with the abolition of the gladiatorial shows in 404 (although there is said to be evidence of their existence later), a reduction of the taxes, improvements in criminal law, and the reorganization of the *defensores civitatum*, municipal officers whose duty it was to defend the rights of the people and set forth their grievances. Honorius at first established his court at Milan, but, on the

report of the invasion of Italy, fled to Ravenna, where he resided till his death on the 27th of August 423.

See Gibbon, *Decline and Fall*, chs. 28-33; J. B. Bury, *Later Roman Empire*, i. chs. 1-5, ii. chs. 4, 6; E. A. Freeman, "Tyrants of Britain, Gaul and Spain" in *Eng. Hist. Review* (January 1886); T. Hodgkin, *Italy and her Invaders* (Oxford, 1892), i. chs. 13, 15-18.

HONOUR (Lat. *honor* or *honor*, *honoris*; in English the word was spelled with or without the *u* indifferently until the 17th century, but during the 18th century it became fashionable to spell the word "honour"; Johnson's and Webster's Dictionaries stereotyped the English and American spellings respectively), a term which may be defined as respect, esteem or deference paid to, or received by, a person in consideration of his character, worth or position; also the state or condition of the person exciting the feeling or expression of such esteem; particularly a high personal character coupled with conduct in accordance with or controlled by a nice sense of what is right and true and due to the position so held. Further, the word is commonly used of the dignities, distinctions or titles, granted as a mark of such esteem or as a reward for services or merit, and quite generally of the credit or renown conferred by a person or thing on the country, town or particular society to which he or it belongs. The standard of conduct may be laid down not only by a scrupulous sense of what is due to lofty personal character but also by the conventional usages of society, hence it is that debts which cannot be legally enforced, such as gambling debts, are called "debts of honour." Similarly in the middle ages and later, courts, known as "courts of honour," sat to decide questions such as precedence, disputes as to coat armour &c. (see CHIVALRY); such courts, chiefly military, are found in countries where duelling has not fallen into desuetude (see DUEL). In the British House of Lords, when the peers sit to try another peer on a criminal charge or at an impeachment, on the question being put whether the accused be guilty or not, each peer, rising in his place in turn, lays his right hand on his breast and returns his verdict "upon my honour." As a title of address, "his honour" or "your honour" is applied in the United States of America to all judges, in the United Kingdom only to county court judges. In university or other examinations, those who have won particular distinction, or have undergone with success an examination of a standard higher than that required for a "pass" degree, are said to have passed "with honours," or an "honours" examination or to have taken an "honours degree." In many games of cards the ace, king, queen and knave of trumps are the "honours."

Funeral or military honours are paid to a dead officer or soldier. The usual features of such a burial are as follows: the coffin is carried on a gun-carriage and attended by troops; it is covered by the national flag, on which rests the soldier's head-dress, sword or bayonet; if the deceased had been a mounted soldier, his charger follows with the boots reversed in the stirrups; three volleys are fired over the grave after committal, and "last post" or another call is sounded on the bugles or a roll on the drums is given.

A military force is said to be accorded "the honours of war" when, after a specially honourable defence, it has surrendered its post, and is permitted by the terms of capitulation to march out with colours flying, bands playing, bayonets fixed, &c. and retaining possession of the field artillery, horses, arms and baggage. The force remains free to act as combatants for the remainder of the war, without waiting for exchange or being considered as prisoners. Usually some point is named to which the surrendering troops must be conveyed before recommencing hostilities; thus, during the Peninsular War, at the Convention of Cintra 1808, the French army under Junot was conveyed to France by British transports before being free to rejoin the combatant troops in the Peninsula. By far the most usual case of the granting of the "honours of war" is in connexion with the surrender of a fortress. Of historic examples may be mentioned the surrender of Lille by Marshal Bouffiers to Prince Eugene in 1708, that of Huningen by General Joseph Barbagnère (1772-1830) to the Austrians in 1815, and that of

Belfort by Colonel P. Denfert Rochereau to the Germans in 1871.

In English law the term "honour" is used of a seigniorship of several manors held under one baron or lord paramount. The formation of such lordships dates back to the Anglo-Saxon period, when jurisdiction of sac and soc was frequently given in the case of a group of estates lying close together. The system was encouraged by the Norman lords, as tending to strengthen the principles of feudal law, but the legislation of Henry II., which increased the power of the central administration, undoubtedly tended to discourage the creation of new honours. Frequently, they escheated to the crown, retaining their corporate existence and their jurisdictions; they then either remained in the possession of the king or were regranted, diminished in extent. Although an honour contained several manors, one court day was held for all, but the various manors retained their separate organizations, having their "quasi several and distinct courts."

HONOURABLE (Fr. *honorable*, from Lat. *honorabilis*, worthy of honour), a style or title of honour common to the United Kingdom, the British colonies and the United States of America. The terms *honorabilis* and *honorabilitas* were in use in the middle ages rather as a form of politeness than as a stereotyped style; and though Gibbon assimilates the late Roman title of *clarissimus* to "honourable," as applied to the lowest of the three grades of rank in the imperial hierarchy, the analogy was good even in his day only in so far as both styles were applicable to those who belonged to the less exalted ranks of the titled classes, for the title "honourable" was not definitely confined to certain classes until later. As a formal address it is found frequently in the *Paston Letters* (15th century), but used loosely and interchangeable with other styles; thus John, Viscount Beaumont, is addressed alternately as "my worshipful and reverent Lord" (ii. 88, ed. 1904) and as "my right honourable Lord" (ii. 118), while John Paston, a plain squire, is "my right honourabyl maister." More than two centuries later Selden, in his *Titles of Honor* (1672), does not include "honourable" among the courtesy titles given to the children of peers. The style was, in fact, used extremely loosely till well on into the 18th century. Thus we find in the registers of Westminster Abbey records of the burial (in 1710) of "The Hon. George Churchill, Esq.," who was only a son of Sir Winston Churchill, and of "The Hon. Sir William Godolphin," who had only been created a baronet; in 1717 was buried "The Hon. Colonel Henry Cornwall," who was only an esquire and the son of one; in 1743 a rear-admiral was buried as "The Hon. Sir John Jennings, Kt.," in 1746 "The Hon. Major-General Lowther," whose father was only a Dublin merchant; and finally, in 1747, "The Hon. Lieutenant-General Guest," who is said to have begun life as an hostler. From this time onwards the style of "honourable" tended to become more narrowly applied; but the whole matter is full of obscurity and contradictions. The baronets, for instance, allege that they were usually styled "the honourable" until the end of the 18th century, and in 1835 they petitioned for the style as a prefix to their names. The *Heralds' College* officially reported on the petition (31st of October 1835) that the evidence did not prove the right of baronets to the style, and that its use "has been no more warranted by authority than when the same style has been applied to Field Officers in the Army and others." They added that "the style of the Honourable is given to the *Judges* and to the *Barons of the Exchequer* with others because by the Decree of 10 James I., for settling the place and precedence of the Baronets, the Judges and Barons of the Exchequer were declared to have place and precedence before the younger sons of Viscounts and Barons." This seems to make the style a consequence of the precedence; yet from the examples above given it is clear that it was applied, e.g. in the case of field officers, where no question of precedence arose. It is not, indeed, until 1874 that we have any evidence of an authoritative limitation of the title. In this year the wives of lords of appeal, life peers, were granted style and precedence as baronesses; but it was provided that their children were not "to assume or use

the prefix Honourable, or to be entitled to the style, rank or precedence of the children of a Baron." In 1898, however, this was revoked, and it was ordained "that such children shall have and enjoy on all occasions the style and title enjoyed by the children of hereditary Barons together with the rank and precedence, &c." By these acts of the Crown the prefix of "honourable" would seem to have been restricted and stereotyped as a definite title of honour; yet in legal documents the sons of peers are still styled merely "esquire," with the addition of "commonly called, &c." This latter fact points to the time when the prefix "honourable" was a mark of deference paid by others rather than a style assumed by right, and relics of this doubtless survive in the United Kingdom in the conventions by which an "honourable" does not use the title on his visiting card and is not announced as such.

As to the actual use and social significance of the style, the practice in the United Kingdom differs considerably from that in the colonies or in the United States. In the United Kingdom marquesses are "most honourable"; earls, viscounts and barons "right honourable," a style also borne by all privy councillors, including the lord mayor of London and lord provost of Edinburgh during office. The title of "honourable" is in the United Kingdom, except by special licence of the Crown (*e.g.* in the case of retired colonial or Indian officials), mainly confined to the sons and daughters of peers, and is the common style of the younger sons of earls and of the children of viscounts, barons and legal life peers. The eldest sons of dukes, marquesses and earls bear "by courtesy" their father's second title, the younger sons of dukes and marquesses having the courtesy title Lord prefixed to their Christian name; while the daughters of dukes, marquesses and earls are styled Lady. The title of "honourable" is also given to all present or past maids of honour, and to the judges of the high court being lords justices or lords of appeal (who are "right honourable"). A county court judge is, however, "his honour." The epithet is also applied to the House of Commons as a body and to individual members during debate ("the honourable member for X."). Certain other corporate bodies have, by tradition or grant, the right to bear the style; *e.g.* the Honourable Irish Society, the Inns of Court (Honourable Society of the Inner Temple, &c.) and the Honourable Artillery Company; the East India Company also had the prefix "honourable." The style may not be assumed by corporate bodies at will, as was proved in the case of the Society of Baronets, whose original style of "Honourable" Society was dropped by command.

In the British colonies the title "honourable" is given to members of the executive and legislative bodies, to judges, &c., during their term of service. It is sometimes retained by royal licence after a certain number of years' service.

In the United States of America the title is very widespread, being commonly given to any one who holds or has held any office of importance in state or nation, more particularly to members of Congress or of the state legislatures, judges, justices, and certain other judicial and executive officials. Popular amenity even sometimes extends the title to holders of quite humble government appointments, and consoles with it the defeated candidates for a post. See also the article PRECEDENCE.

HONTHEIM, JOHANN NIKOLAUS VON (1701-1790), German historian and theologian, was born on the 27th of January 1701 at Trier. He belonged to a noble family which had been for many generations connected with the court and diocese of the archbishop-electors, his father, Kaspar von Hontheim, being receiver-general of the archdiocese. At the age of twelve young Hontheim was given by his maternal uncle, Hugo Friedrich von Anethan, canon of the collegiate church of St Simeon (which at that time still occupied the Roman Porta Nigra at Trier), a prebend in his church, and on the 13th of May 1713 he received the tonsure. He was educated by the Jesuits at Trier and at the universities of Trier, Louvain and Leiden, taking his degree of doctor of laws at Trier in 1724. During the following years he travelled in various European countries, spending some time at the German College in Rome; in 1728 he was

ordained priest and, formally admitted to the chapter of St Simeon in 1732, he became a professor at the university of Trier. In 1738 he went to Coblenz as official to the archbishop-electors. In this capacity he had plentiful opportunity of studying the effect of the interference of the Roman Curia in the internal affairs of the Empire, notably in the negotiations that preceded the elections of the emperors Charles VII. and Francis I. in which Hontheim took part as assistant to the electoral ambassador. It appears that it was the extreme claims of the papal nuncio on these occasions and his interference in the affairs of the electoral college that first suggested to Hontheim that critical examination of the basis of the papal pretensions, the results of which he afterwards published to the world under the pseudonym of "Febronius." In 1747, broken down by overwork, he resigned his position as official and retired to St Simeon's, of which he was elected dean in the following year. In May 1748 he was appointed by the archbishop-electors Francis George (von Schönborn) as his suffragan, being consecrated at Mainz, in February 1749, under the title of bishop of Myriophiri in *partibus*. The archbishop of Trier was practically a great secular prince, and upon Hontheim as suffragan and vicar-general fell the whole spiritual administration of the diocese; this work, in addition to that of pro-chancellor of the university, he carried on single-handed until 1778, when Jean Marie Cuchot d'Herbain was appointed his coadjutor. On the 21st of April 1779 he resigned the deanery of St Simeon's on the ground of old age. He died on the 2nd of September 1790 at his château at Montquentin near Orval, an estate which he had purchased. He was buried at first in St Simeon's; but the church was ruined by the French during the revolutionary wars and never restored, and in 1803 the body of Hontheim was transferred to that of St Gervasius.

As a historian Hontheim's reputation rests on his contributions to the history of Trier. He had, during the period of his activity as official at Coblenz, found time to collect a vast mass of printed and MS. material which he afterwards embodied in three works on the history of Trier. Of these the *Historia Trevirensis diplomatica et pragmatica* was published in 3 vols. folio in 1750, the *Prodromus historiae Trevirensis* in 2 vols. in 1757. They give, besides a history of Trier and its constitution, a large number of documents and references to published authorities. A third work, the *Historiae scriptorum et monumentarum Trevirensis amplissima collectio*, remains in MS. at the city library of Trier. These books, the result of an enormous labour in collation and selection in very unfavourable circumstances, entitle Hontheim to the fame of a pioneer in modern historical methods. It is, however, as "Febronius" that Hontheim is best remembered. The character and effect of his book on "the state of the Church and the lawful power of the Roman pontiff" is described elsewhere (see FEBRONIANISM). The author of the book was known at Rome almost as soon as it was published; but it was not till some years afterwards (1778) that he was called on to retract. The terrors of the spiritual power were reinforced by a threat of the archbishop-electors to deprive not only him but all his relations of their offices, and Hontheim, after much wavering and correspondence, signed a submission which was accepted at Rome as satisfactory, though he still refused to admit, as demanded, *ut proinde merito monarchicum ecclesiae regimen a catholicis doctoribus appellatur*. The removal of the censure followed (1781) when Hontheim published at Frankfort what purported to be a proof that his submission had been made of his own free will (*Justini Febronii acti commentarius in suam retractationem, &c.*). This book, however, which carefully avoided all the most burning questions, rather tended to show—as indeed his correspondence proves—that Hontheim had not essentially shifted his standpoint. But Rome left him thenceforth in peace.

See Otto Mejer, *Febronius, Weibischof Johann Nikolaus von Hontheim und sein Widerruf* (Tübingen, 1880), with many original letters. Of later date is the biography by F. X. Kraus in the *Allgemeine deutsche Biographie* (1881), which gives numerous references.

HONTHORST, GERARD VAN (1590-1656), Dutch painter of Utrecht, was brought up at the school of Bloemart, who

exchanged the style of the Franchens for that of the pseudo-Italians at the beginning of the 16th century. Infected thus early with a mania which came to be very general in Holland, Honthorst went to Italy, where he copied the naturalism and eccentricities of Michelangelo da Caravaggio. Home again about 1614, after acquiring a considerable practice in Rome, he set up a school at Utrecht which flourished exceedingly; and he soon became so fashionable that Sir Dudley Carleton, then English envoy at the Hague, recommended his works to the earl of Arundel and Lord Dorchester. At the same time the queen of Bohemia, sister of Charles I. and electress palatine, being an exile in Holland, gave him her countenance and asked him to teach her children drawing; and Honthorst, thus approved and courted, became known to Charles I., who invited him to England. There he painted several portraits, and a vast allegory, now at Hampton Court, of Charles and his queen as Diana and Apollo in the clouds receiving the duke of Buckingham as Mercury and guardian of the king of Bohemia's children. Charles I., whose taste was flattered alike by the energy of Rubens and the elegance of Van Dyck, was thus first captivated by the fanciful mediocrity of Honthorst, who though a poor executant had luckily for himself caught, as Lord Arundel said, "much of the manner of Caravaggio's colouring, then so much esteemed at Rome." It was his habit to transmute every subject into a night scene, from the Nativity, for which there was warrant in the example of Correggio, to the penitence of the Magdalen, for which there was no warrant at all. But unhappily this caprice, though "sublime in Allegri and Rembrandt," was but a phantasm in the hands of Honthorst, whose prosaic pencil was not capable of more than vulgar utterances, and art gained little from the repetition of these quaint vagaries. Sandrart gave the measure of Honthorst's popularity at this period when he says that he had as many as twenty apprentices at one time, each of whom paid him a fee of 100 florins a year. In 1623 he was president of his guild at Utrecht. After that he went to England, returning to settle anew at Utrecht, where he married. His position amongst artists was acknowledged to be important, and in 1626 he received a visit from Rubens, whom he painted as the honest man sought for and found by Diogenes Honthorst. In his home at Utrecht Honthorst succeeded, in preserving the support of the English monarch, for whom he finished in 1631 a large picture of the king and queen of Bohemia "and all their children." For Lord Dorchester about the same period he completed some illustrations of the *Odyssey*; for the king of Denmark he composed incidents of Danish history, of which one example remains in the gallery of Copenhagen. In the course of a large practice he had painted many likenesses—Charles I. and his queen, the duke of Buckingham, and the king and queen of Bohemia. He now became court painter to the princess of Orange, settled (1637) at the Hague, and painted in succession at the Castle of Ryswick and the House in the Wood. The time not consumed in producing pictures was devoted to portraits. Even now his works are very numerous, and amply represented in English and Continental galleries. His most attractive pieces are those in which he cultivates the style of Caravaggio, those, namely, which represent taverns, with players, singers and eaters. He shows great skill in reproducing scenes illuminated by a single candle. But he seems to have studied too much in dark rooms, where the subtleties of flesh colour are lost in the dusky smoothness and uniform redness of tints procurable from farthing dips. Of great interest still, though rather sharp in outline and hard in modelling, are his portraits of the Duke of Buckingham and Family (Hampton Court), the King and Queen of Bohemia (Hanover and Combe Abbey), Mary de Medici (Amsterdam town-hall), 1628, the Stadholders and their Wives (Amsterdam and Hague), Charles Louis and Rupert, Charles I.'s nephews (Louvre, St Petersburg, Combe Abbey and Willin), and Lord Craven (National Portrait Gallery). His early form may be judged by a Lute-player (1614) at the Louvre, the Martyrdom of St John in S. M. della Scala at Rome, or the Liberation of Peter in the Berlin Museum; his latest style is that of the House in the Wood

(1648), where he appears to disadvantage by the side of Jordaeus and others.

Honthorst was succeeded by his brother William, born at Utrecht in 1604, who died, it is said, in 1666. He lived chiefly in his native place, temporarily at Berlin. But he has left little behind except a portrait at Amsterdam, and likenesses in the Berlin Museum of William and Mary of England.

HOOCH, PIETER DE (1629-?1678), Dutch painter, was born in 1629, and died in Amsterdam probably shortly after 1677. He was a native of Rotterdam, and wandered early to Haarlem and the Hague. In 1654 we find him again at Rotterdam, where in that year he married a girl of Delft, Jannetje van der Burch. From 1655 to 1657 he was a member of the painter's guild of Delft, but after that date we have no traces of his doings until about 1668, when his presence is recorded in Amsterdam. His dated pictures prove that he was still alive in 1677, but his death followed probably soon after this year. De Hooch is one of the kindest and most charming painters of homely subjects that Holland has produced. He seems to have been born at the same time and taught in the same school as van der Meer and Maes. All three are disciples of the school of Rembrandt. Houbraken mentions Nicolas Berchem as De Hooch's teacher. De Hooch only once painted a canvas of large size, and that unfortunately perished in a fire at Rotterdam in 1864. But his small pieces display perfect finish and dexterity of hand, combined with great power of discrimination. Though he sometimes paints open-air scenes, these are not his favourite subjects. He is most at home in interiors illuminated by different lights, with the radiance of the day, in different intensities, seen through doors and windows. He thus brings together the most delicate varieties of tone, and produces chords that vibrate with harmony. The themes which he illustrates are thoroughly suited to his purpose. Sometimes he chooses the drawing-room where dames and cavaliers dance, or dine, or sing; sometimes—mostly indeed—he prefers cottages or courtyards, where the housewives tend their children or superintend the labours of the cook. Satin and gold are as familiar to him as camel and fur; and there is no article of furniture in a Dutch house of the middle class that he does not paint with pleasure. What distinguishes him most besides subtle suggestiveness is the serenity of his pictures. One of his most charming was the canvas formerly in the Ashburton collection, now burnt, where an old lady with a dish of apples walks with a child along a street bounded by a high wall, above which gables and a church steeple are seen, while the sun radiates joyfully over the whole. Fine in another way is the "Mug of Beer" in the Amsterdam Museum, an interior with a woman coming out of a pantry and giving a measure of beer to a little girl. The light flows in here from a small closed window; but through the door to the right we look into a drawing-room, and through the open sash of that room we see the open air. The three lights are managed with supreme cunning. Beautiful for its illumination again is the "Music Party," with its contending indoor and outdoor lights, a gem in the late A. Thieme collection at Leipzig. More subtly suggestive, in the museum of Berlin, is the "Mother seated near a Cradle." "A Card Party," dated 1658, at Buckingham Palace, is a good example of De Hooch's drawing-room scenes, counterpart as to date and value of a "Woman and Child" in the National Gallery, and the "Smoking Party," formerly in Lord Enfield's collection. Another very fine example is the "Interior" with two women, bought by Sir Julius Wernher. Other pictures later in the master's career are—the "Lady and Child in a Courtyard," of 1665, in the National Gallery, and the "Lady receiving a Letter," of 1670, in the Amsterdam Museum (Van der Hoop collection).

It is possible to bring together over 250 examples of De Hooch. There are three at St Petersburg, three in Buckingham Palace, three in the National Gallery, two in the Wallace Collection, six in the Amsterdam Museum, some in the Louvre and at Munich and Darmstadt; many others are in private galleries in England. For England was the first country to recognize the merit of De Hooch, who only

began to be valued in Holland in the middle of the 18th century. A celebrated picture at Amsterdam, sold for 450 florins in 1765, fetched 4000 in 1817, and in 1876 the Berlin Museum gave £5400 for a De Hooch at the Schneider sale—"A Dutch Dwelling-room" (820 B).

See Hofstede de Groot's *Catalogue raisonné*, vol. i, London, 1907.

HOOD, JOHN BELL (1831-1879), American soldier, lieutenant-general of the Confederate army, was born at Owingsville, Kentucky, in 1831, and graduated from West Point military academy in 1853. As an officer of the 2nd U.S. cavalry (Colonel Sidney Johnston) he saw service against Indians, and later he was cavalry instructor at West Point. He resigned from the U.S. service in 1861, and became a colonel in the Confederate army. He was soon promoted brigadier-general, and at the battle of Gaines's Mill, where he was wounded, won the brevet of major-general for his gallant conduct. With the famous "Texas brigade" of the Army of Northern Virginia he served throughout the campaign of 1862. At Gettysburg he commanded one of the divisions of Longstreet's corps, receiving a wound which disabled his arm. With Longstreet he was transferred in the autumn of 1863 to the Army of Tennessee. At the battle of Chickamauga (September 19th, 20th) Hood was severely wounded again and his leg was amputated, but after six months he returned to duty undaunted. He remained with the Army of Tennessee as a corps commander, and when the general dissatisfaction with the Fabian policy of General J. E. Johnston brought about the removal of that officer, Hood was put in his place with the temporary rank of general. He had won a great reputation as a fighting general, and it was with the distinct understanding that battles were to be fought that he was placed at the head of the Army of Tennessee. But in spite of skill and courage he was uniformly unsuccessful in the battles around Atlanta. In the end he had to abandon the place, but he forthwith sought to attack Sherman in another direction, and finally invaded Tennessee. His march was pushed with the greatest energy, but he failed to draw the main body of the enemy after him, and, while Sherman with a picked force made his "March to the Sea," Thomas collected an army to oppose Hood. A severe battle was fought at Franklin on the 30th of November, and finally Hood was defeated and his army almost annihilated in the battle of Nashville. He was then relieved at his own request (January 23rd, 1865). After the war he was engaged in business in New Orleans, where he died of yellow fever on the 30th of August 1879. His experiences in the Civil War are narrated in his *Advance and Retreat* (New Orleans, 1880). Hood's reputation as a bold and energetic leader was well deserved, though his reckless vigour proved but a poor substitute for Johnston's careful husbanding of his strength at this declining stage of the Confederacy.

HOOD, SAMUEL HOOD, VISCOUNT (1724-1816), British admiral, was the son of Samuel Hood, vicar of Butleigh in Somerset, and prebendary of Wells. He was born on the 12th of December 1724, and entered the navy on the 6th of May 1741. He served part of his time as midshipman with Rodney in the "Ludlow," and became lieutenant in 1746. He was fortunate in serving under active officers, and had opportunities of seeing service in the North Sea. In 1753 he was made commander of the "Jamaica" sloop, and served in her on the North American station. In 1756, while still on the North American station, he attained to post rank. In 1757, while in temporary command of the "Antelope" (50), he drove a French ship ashore in Audiene Bay, and captured two privateers. His zeal attracted the favourable notice of the Admiralty and he was appointed to a ship of his own. In 1759, when captain of the "Vestal" (32), he captured the French "Bellona" (32) after a sharp action. During the war his services were wholly in the Channel, and he was engaged under Rodney in 1759 in destroying the vessels collected by the French to serve as transports in the proposed invasion of England. In 1778 he accepted a command which in the ordinary course would have terminated his active career. He became commissioner of the dockyard at Portsmouth and governor of the Naval Academy. These posts were generally given to officers who were retiring from the sea. In 1780, on the occasion of the king's visit to

Portsmouth, he was made a baronet. The circumstances of the time were not ordinary. Many admirals declined to serve under Lord Sandwich, and Rodney, who then commanded in the West Indies, had complained of want of proper support from his subordinates, whom he accused of disaffection. The Admiralty was naturally anxious to secure the services of trustworthy flag officers, and having confidence in Hood promoted him rear-admiral out of the usual course on the 26th of September 1780, and sent him to the West Indies to act as second in command under Rodney, to whom he was personally known. He joined Rodney in January 1781, and remained in the West Indies or on the coast of North America till the close of the War of American Independence. The calculation that he would work harmoniously with Rodney was not altogether justified by the results. The correspondence of the two shows that they were far from being on cordial personal terms with one another, but Hood always discharged his duty punctually, and his capacity was so great, and so signally proved, that no question of removing him from the station ever arose. The unfortunate turn taken by the campaign of 1781 was largely due to Rodney's neglect of his advice. If he had been allowed to choose his own position there can be no doubt that he could have prevented the comte de Grasse (1722-1788) from reaching Fort Royal with the reinforcements from France in April (see **ROONEY, LORD**). When the fleet went on to the coast of North America during the hurricane months of 1781 he was sent to serve with Admiral Graves (1725?-1802) in the unsuccessful effort to relieve the army at Yorktown. But his subordinate rank gave him no chance to impart a greater measure of energy to the naval operations. When, however, he returned to the West Indies he was for a time in independent command owing to Rodney's absence in England for the sake of his health. The French admiral, the comte de Grasse, attacked the British islands of St Kitts and Nevis with a much superior force to the squadron under Hood's command. The attempt Hood made in January 1782 to save them from capture, with 22 ships to 29, was not successful, but the series of bold movements by which he first turned the French out of their anchorage at the Basse Terre of St Kitts, and then beat off the attacks of the enemy, were the most brilliant things done by any British admiral during the war. He was made an Irish peer for his share in the defeat of the comte de Grasse on the 9th and 12th of April near Dominica. During the peace he entered parliament as member for Westminster in the fiercely contested election of 1784, was promoted vice-admiral in 1787, and in July of 1788 was appointed to the Board of Admiralty under the second earl of Chatham. On the outbreak of the revolutionary war he was sent to the Mediterranean as commander-in-chief. His period of command, which lasted from May 1793 to October 1794, was very busy. In August he occupied Toulon on the invitation of the French royalists, and in co-operation with the Spaniards. In December of the same year the allies, who did not work harmoniously together, were driven out, mainly by the generalship of Napoleon. Hood now turned to the occupation of Corsica, which he had been invited to take in the name of the king of England by Paoli. The island was for a short time added to the dominions of George III., chiefly by the exertions of the fleet and the co-operation of Paoli. While the occupation of Corsica was being effected, the French at Toulon had so far recovered that they were able to send a fleet to sea. In June Hood sailed in the hope of bringing it to action. The plan which he laid to attack it in the Golfe Jouan in June may possibly have served to some extent as an inspiration, if not as a model, to Nelson for the battle of the Nile, but the wind was unfavourable, and the attack could not be carried out. In October he was recalled to England in consequence of some misunderstanding with the admiralty, or the ministry, which has never been explained. He had attained the rank of full admiral in April of 1794. He held no further command at sea, but in 1796 he was named governor of Greenwich Hospital, a post which he held till his death on the 27th of January 1816. A peerage of Great Britain was conferred on his wife as Baroness Hood of Catherington in

1795, and he was himself created Viscount Hood of Whitley in 1796. The titles descended to his son, Henry (1753-1836), the ancestor of the present Viscount Hood. There are several portraits of Lord Hood by Abbot in the Guildhall and in the National Portrait Gallery. He was also painted by Reynolds and Gainsborough.

There is no good life of Lord Hood, but a biographical notice of him by M'Arthur, his secretary during the Mediterranean command, is in the *Naval Chronicle*, vol. li. Charnock's *Biogr. Nav.* vi., Ralle, *Nap. Biog.* i., may also be consulted. His correspondence during his command in America has been published by the Navy Record Society. The history of his campaigns will be found in the historians of the wars in which he served: for the earlier years, *Beatsen's Naval and Military Memoirs*; for the later, *James's Naval History*, vol. i., for the English side, and for the French, *Troudes, Batailles navales de la France*, ii. and iii., and *Chevalier's Histoire de la marine française pendant la guerre de l'indépendance américaine and Pendant la République.* (D. H.)

HOOD, SIR SAMUEL (1762-1814), British vice-admiral, cousin of Lord Hood and of Lord Bridport, entered the Royal Navy in 1776. His first engagement was the battle off Ushant in 1778, and, soon afterwards transferred to the West Indies, he was present, under the command of his cousin Sir Samuel Hood, at all the actions which culminated in Rodney's victory of April 12th, 1782. After the peace, like many other British naval officers, he spent some time in France, and on his return to England was given the command of a sloop, from which he proceeded in succession to various frigates. In the "Juno" his gallant rescue of some shipwrecked seamen won him a vote of thanks and a sword of honour from the Jamaica assembly. Early in 1793 the "Juno" went to the Mediterranean under Lord Hood, and her captain distinguished himself by an audacious feat of coolness and seamanship in extricating his vessel from the harbour of Toulon, which he had entered in ignorance of Lord Hood's withdrawal. Soon afterwards he was put in command of a frigate squadron for the protection of Levantine commerce, and in 1797 he was given the "Zealous" (74), in which he was present at Nelson's unsuccessful attack on Santa Cruz. It was Captain Hood who conducted the negotiations which relieved the squadron from the consequences of its failure. The part played by the "Zealous" at the battle of the Nile was brilliant. Her first opponent she put out of action in twelve minutes, and, passing on, Hood immediately engaged other ships, the "Guerrier" being left powerless to fire a shot. When Nelson left the coast of Egypt, Hood commanded the blockading force off Alexandria and Rosetta. Later he rejoined Nelson on the coast of the two Sicilies, receiving for his services the order of St Ferdinand.

In the "Venerable" Hood was present at the action of Algeiras and the battle in the Straits of Gibraltar (1801). In the Straits his ship suffered heavily, losing 130 officers and men. A year later Captain Hood was employed in Trinidad as a commissioner, and, upon the death of the flag officer commanding the Leeward station, he succeeded him as Commodore. Island after island fell to him, and soon, outside Martinique, the French had scarcely a foothold in the West Indies. Amongst other measures taken by Hood may be mentioned the garrisoning of Diamond Rock, which he commissioned as a sloop-of-war to blockade the approaches of Martinique (see *James, Naval History*, iii. 245). For these successes he received, amongst other rewards, the K.B. In command next of the squadron blockading Rochefort, Sir Samuel Hood had a sharp fight, on 25th September 1805, with a small French squadron which was trying to escape. Amongst the few casualties on this occasion was the Commodore, who lost an arm. Promoted rear-admiral a few days after this action, Hood was in 1807 entrusted with the operations against Madeira, which he brought to a successful conclusion, and a year later went to the Baltic, with his flag in the "Centaur," to take part in the war between Russia and Sweden. In one of the actions of this war the "Centaur" and "Implacable," unsupported by the Swedish ships (which lay to leeward), cut out the Russian 80-gun ship "Sevolod" from the enemy's line and, after a desperate fight, forced her to strike. The king of Sweden rewarded the admiral with the

Grand Cross of the Order of the Sword. Present in the roads of Corunna at the re-embarkation of the army of Sir John Moore, Hood thence returned to the Mediterranean, where for two years he commanded a division of the British fleet. In 1811 he became vice-admiral. In his last command, that of the East Indies station, he carried out many salutary reforms, especially in matters of discipline and victualling. He died at Madras, 24th December 1814. A lofty column was raised to his memory on a hill near Butleigh, Somersetshire, and in Butleigh Church is another memorial, with an inscription written by Southey.

See *Naval Chronicle*, xvii. 1 (the material was furnished by Hood himself; it does not go beyond 1806).

His elder brother, Captain ALEXANDER HOOD (1758-1798), entered the Royal Navy in 1767, and accompanied Captain Cook in his second voyage round the world. Under Howe and Rodney he distinguished himself in the West Indies, and at the victory of April 12th, 1782, he was in command of one of Rodney's frigates. Under Sir Samuel Hood he then proceeded to the Mona passage, where he captured the French corvette "Cérés." With the commander of his prize, the Baron de Peroy, Hood became very intimate, and during the peace he paid a long visit to France as his late prisoner's guest. In the early part of the Revolutionary war, ill health kept him at home, and it was not until 1797 that he went afloat again. His first experience was bitter; his ship, the "Mars" was unenviably prominent in the mutiny at Spithead. On April 21st, 1798, occurred the famous duel of the "Mars" with the "Hercule," fought in the dusk near the Bec du Raz. The two ships were of equal force, but the "Hercule" was newly commissioned, and after over an hour's fighting at close quarters she struck her flag, having lost over three hundred men. The captain of the "Mars" was mortally wounded early in the fight, and died as the sword of the French captain was being put in his hand. The latter, L'Heritier, also died of his wounds.

See *Naval Chronicle*, vi. 175; Ralle, *Naval Biographies*, iv. 48; *James, Naval History*, and *Chevalier, Hist. de la marine française sous la première république.*

HOOD, THOMAS (1790-1845), British humorist and poet, the son of Thomas Hood, bookseller, was born in London on the 23rd of May 1790. "Next to being a citizen of the world," writes Thomas Hood in his *Literary Reminiscences*, "it must be the best thing to be born a citizen of the world's greatest city." On the death of her husband in 1811 Mrs Hood removed to Islington, where Thomas Hood had a schoolmaster who appreciated his talents, and, as he says, "made him feel it impossible not to take an interest in learning while he seemed so interested in teaching." Under the care of this "decayed dominie," whom he has so affectionately recorded, he earned a few guineas—his first literary fee—by revising for the press a new edition of *Paul and Virginia*. Admitted soon after into the counting-house of a friend of his family, he "turned his stool into a Pegasus on three legs, every foot, of course, being a dactyl or a spondee"; but the ungenial profession affected his health, which was never strong, and he was transferred to the care of his father's relations at Dundee. There he led a healthy outdoor life, and also became a large and indiscriminate reader, and before long contributed humorous and poetical articles to the provincial newspapers and magazines. As a proof of the seriousness with which he regarded the literary vocation, it may be mentioned that he used to write out his poems in printed characters, believing that that process best enabled him to understand his own peculiarities and faults, and probably unconscious that Coleridge had recommended some such method of criticism when he said he thought "print settles it." On his return to London in 1818 he applied himself assiduously to the art of engraving, in which he acquired a skill that in after years became a most valuable assistant to his literary labours, and enabled him to illustrate his various humours and fancies by a profusion of quaint devices, which not only repeated to the eye the impressions of the text, but, by suggesting amusing analogies and contrasts, added considerably to the sense and effect of the work.

In 1821 Mr John Scott, the editor of the *London Magazine*, was killed in a duel, and that periodical passed into the hands of some friends of Hood, who proposed to make him sub-editor. His installation into this congenial post at once introduced him to the best literary society of the time; and in becoming the associate of Charles Lamb, Cary, de Quincey, Allan Cunningham, Proctor, Talfourd, Hartley Coleridge, the peasant-poet Clare and other contributors to the magazine, he gradually developed his own intellectual powers, and enjoyed that happy intercourse with superior minds for which his cordial and genial character was so well adapted, and which he has described in his best manner in several chapters of *Hood's Own*. He had married in 1825, and *Odes and Addresses*—his first work—was written in conjunction with his brother-in-law Mr J. H. Reynolds, the friend of Keats. S. T. Coleridge wrote to Charles Lamb averring that the book must be his work. *The Plea of the Midsummer Fairies* (1827) and a dramatic romance, *Lamia*, published later, belong to this time. *The Plea of the Midsummer Fairies* was a volume of serious verse, in which Hood showed himself a by no means despicable follower of Keats. But he was known as a humorist, and the public, which had learned to expect jokes from him, rejected this little book almost entirely. There was much true poetry in the verse, and much sound sense and keen observation in the prose of these works; but the poetical feeling and lyrical facility of the one, and the more solid qualities of the other, seemed best employed when they were subservient to his rapid wit, and to the ingenious coruscations of his fancy. This impression was confirmed by the series of the *Comic Annual*, dating from 1830, a kind of publication at that time popular, which Hood undertook and continued, almost unassisted, for several years. Under that somewhat frivolous title he treated all the leading events of the day in a fine spirit of caricature, entirely free from grossness and vulgarity, without a trait of personal malice, and with an under-current of true sympathy and honest purpose that will preserve these papers, like the sketches of Hogarth, long after the events and manners they illustrate have passed from the minds of men. But just as the agreeable jester rose into the earnest satirist, one of the most striking peculiarities of his style became a more manifest defect. The attention of the reader was distracted, and his good taste annoyed, by the incessant use of puns, of which Hood had written in his own vindication:—

"However critics may take offence,
A double meaning has double sense."

Now it is true that the critic must be unconscious of some of the subtlest charms and nicest delicacies of language who would exclude from humorous writing all those impressions and surprises which depend on the use of the diverse sense of words. The history, indeed, of many a word lies hid in its equivocal uses; and it in no way derogates from the dignity of the highest poetry to gain strength and variety from the ingenious application of the same sounds to different senses, any more than from the contrivances of rhythm or the accompaniment of imitative sounds. But when this habit becomes the characteristic of any wit, it is impossible to prevent it from degenerating into occasional buffoonery, and from supplying a cheap and ready resource, whenever the true vein of humour becomes thin or rare. Artists have been known to use the left hand in the hope of checking the fatal facility which practice had conferred on the right; and if Hood had been able to place under some restraint the curious and complex machinery of words and syllables which his fancy was incessantly producing, his style would have been a great gainer, and much real earnestness of object, which now lies confused by the brilliant kaleidoscope of language, would have remained definite and clear. He was probably not unconscious of this danger; for, as he gained experience as a writer, his diction became more simple, and his ludicrous illustrations less frequent. In another annual called the *Gem* appeared the poem on the story of "Eugene Aram," which first manifested the full extent of that poetical vigour which seemed to advance just in proportion as his physical health declined. He started a magazine in his own name,

for which he secured the assistance of many literary men of reputation and authority, but which was mainly sustained by his own intellectual activity. From a sick-bed, from which he never rose, he conducted this work with surprising energy, and there composed those poems, too few in number, but immortal in the English language, such as the "Song of the Shirt" (which appeared anonymously in the Christmas number of *Punch*, 1843), the "Bridge of Sighs" and the "Song of the Labourer," which seized the deep human interests of the time, and transported them from the ground of social philosophy into the loftier domain of the imagination. They are no clamorous expressions of anger at the discrepancies and contrasts of humanity, but plain, solemn pictures of conditions of life, which neither the politician nor the moralist can deny to exist, and which they are imperatively called upon to remedy. Woman, in her wasted life, in her hurried death, here stands appealing to the society that degrades her, with a combination of eloquence and poetry, of forms of art at once instantaneous and permanent, and with great metrical energy and variety.

Hood was associated with the *Athenaeum*, started in 1828 by J. Silk Buckingham, and he was a regular contributor for the rest of his life. Prolonged illness brought on straitened circumstances; and application was made to Sir Robert Peel to place Hood's name on the pension list with which the British state so moderately rewards the national services of literary men. This was done without delay, and the pension was continued to his wife and family after his death, which occurred on the 3rd of May 1845. Nine years after a monument, raised by public subscription, in the cemetery of Kensal Green, was inaugurated by Monckton Milnes (Lord Houghton) with a concourse of spectators that showed how well the memory of the poet stood the test of time. Artisans came from a great distance to view and honour the image of the popular writer whose best efforts had been dedicated to the cause and the sufferings of the workers of the world; and literary men of all opinions gathered round the grave of one of their brethren whose writings were at once the delight of every boy and the instruction of every man who read them. Happy the humorist whose works and life are an illustration of the great moral truth that the sense of humour is the just balance of all the faculties of man, the best security against the pride of knowledge and the conceits of the imagination, the strongest inducement to submit with a wise and pious patience to the vicissitudes of human existence. This was the lesson that Thomas Hood left behind him. (H.)

BIBLIOGRAPHY.—The list of Hood's separately published works is as follows: *Odes and Addresses to Great People* (1825); *Whims and Oddities* (two series, 1826 and 1827); *The Plea of the Midsummer Fairies, Hero and Leander, Lycus the Centaur and other Poems* (1827), his only collection of serious verse; *The Dream of Eugene Aram, the Murderer* (1831); *Tynney Hall*, a novel (3 vols., 1834); *The Comic Annual* (1830-1842); *Hood's Own; or, Laughter from Year to Year* (1838, second series, 1861); *Up the Rhine* (1840); *Hood's Magazine and Comic Miscellany* (1844-1848); *National Tales* (2 vols., 1837), a collection of short novelettes; *Whimsicalities* (1844), with illustrations from Leech's designs; and many contributions to contemporary periodicals.

The chief sources of his biography are: *Memorials of Thomas Hood, collected, arranged and edited by his daughter* (1860); his "Literary Reminiscences" in *Hood's Own*; Alexander Elliot, *Hood in Scotland* (1885). See also the memoir of Hood's friend C. W. Dilke, by his grandson Sir Charles Dilke, prefixed to *Papers of a Critic*; and M. H. Spielmann's *History of Punch*. There is an excellent edition of the *Poems of Thomas Hood* (2 vols., 1897), with a biographical introduction of great interest by Canon Alfred Ainger.

HOOD, TOM (1835-1874), English humorist, son of the poet Thomas Hood, was born at Lake-House, Wanstead, Essex, on the 19th of January 1835. After attending University College School and Louth Grammar School he entered Pembroke College, Oxford, in 1853, where he passed all the examinations for the degree of B.A., but did not graduate. At Oxford he wrote his *Farewell to the Swallows* (1853) and *Pen and Pencil Pictures* (1857). He began to write for the *Lisheard Gazette* in 1856, and edited that paper in 1858-1859. He then obtained a position in the War Office, which he filled for five years, leaving in 1865

to become editor of *Fun*, the comic paper, which became very popular under his direction. In 1867 he first issued *Tom Hood's Comic Annual*. In 1861 had appeared *The Daughters of King Daker, and other Poems*, after which he published in conjunction with his sister, Frances Freeling Broderip, a number of amusing books for children. His serious novels, of which *Captain Masters's Children* (1865) is the best, were not so successful. Hood drew with considerable facility, among his illustrations being those of several of his father's comic verses. In private life his geniality and sincere friendliness secured him the affection and esteem of a wide circle of acquaintance. He died on the 20th of November 1874.

A memoir by his sister, F. F. Broderip, is prefixed to the edition of his poems published in 1877.

HOOD OF AVALON, ARTHUR WILLIAM AGLAND HOOD, BARON (1824-1901), English admiral, born on the 14th of July 1824, was the younger son of Sir Alexander Hood of St Andries, Somerset, 2nd baronet, and grandson of Captain Alexander Hood, R.N., who, when in command of the "Mars," fell in action with the French 74-gun ship "Hercule," 21st of April 1798. At the age of twelve Hood entered the navy, and whilst still a boy saw active service on the north coast of Spain, and afterwards on the coast of Syria. After passing through the established course of gunnery on board the "Excellent" in 1844-1845, he went out to the Cape of Good Hope as gunnery mate of the "President," the flagship of Rear-Admiral Dacres, by whom, on the 9th of January 1846, he was promoted to be lieutenant. As gunnery lieutenant he continued in the "President" till 1849; and in the following year he was appointed to the "Arethusa" frigate, then commissioned for the Mediterranean by Captain Symonds, afterwards the well-known admiral of the fleet. The outbreak of the Russian war made the commission a very long one; and on the 27th of November 1854 Hood was promoted to be commander in recognition of his service with the naval brigade before Sebastopol. In 1855 he married Fanny Henrietta, daughter of Sir C. F. Maclean. In 1856 he commissioned the "Acorn" brig for the China station, and arrived in time to take part in the destruction of the junks in Fatshan creek on the 1st of June 1857, and in the capture of Canton in the following December, for which, in February 1858, he received a post-captain's commission. From 1862 to 1866 he commanded the "Pylades" on the North American station, and was then appointed to the command of the "Excellent" and the government of the Royal Naval College at Portsmouth. This was essentially a gunnery appointment, and on the expiration of three years Hood was made Director of Naval Ordnance. He was thoroughly acquainted with the routine work of the office and the established armament of the navy, but he had not the power of adapting himself to the changes which were being called for, and still less of initiating them; so that during his period of office the armament of the ships remained sadly behind the general advance. In June 1874 he was appointed to the command of the "Monarch" in the Channel Fleet, from which he was relieved in March 1876 by his promotion to flag rank. From 1877 to 1879 he was a junior lord of the Admiralty, and from 1880 to 1882 he commanded the Channel Fleet, becoming vice-admiral on 23rd July 1880. In June 1885 he was appointed first sea lord of the Admiralty. The intense conservatism of his character, however, and his antagonistic attitude towards every change, regardless of whether it was necessary or not, had much to do with the alarming state of the navy towards 1889. In that year, on attaining the age of sixty-five, he was placed on the retired list and resigned his post at the Admiralty. After two years of continued ill-health, he died on the 15th of November 1901, and was buried at Butleigh on the 23rd. He had been promoted to the rank of admiral on the 18th of January 1886; was made K.C.B. in December 1885; G.C.B. in September 1889; and in February 1892 was raised to the peerage as Lord Hood of Avalon, but on his death the title became extinct. (J. K. L.)

HOOD, a covering for the head. The word is in O. Eng. *hōd*, cognate with Dutch *hoed* and Ger. *Hut*, hat, both masculine;

"hood" and "hat" are distantly related; they may be connected with the feminine *hoed* or *Hut*, meaning charge, care, Eng. "heed." Some form of hood as a loose covering easily drawn on or off the head has formed a natural part of outdoor costume both for men and women at all times and in all quarters of the globe where climatic conditions called for it. In the middle ages and later both men and women are found wearing it, but with men it tended to be superseded by the hat before it became merely an occasional and additional head-covering in time of bad weather or in particularly rigorous climates. For illustrations and examples of the hood as worn by men and women in medieval and later times see the article **COSTUME**; for the hood or cowl as part of the dress of a religious see **COWL**, and as forming a distinctive mark of degree in academic costume see **ROBES**. The word is applied to many objects resembling a hood in function or shape, such as a folding cover for a carriage to protect the occupants from rain or wind, the belled covering for the head of a hawk trained for falconry, the endmost planks in a ship's bottom at bow or stern, and, in botany and zoology, certain parts of a flower or of the neck of an animal which in arrangement of structure or of colour recall this article of dress.

In architecture a "hood-mould" is a projecting moulding carried outside the arch of a door or window; it is weathered underneath, and when continued horizontally is better known as a dripstone. The ends of the hood-mould are generally stopped on a corbel, plain or carved with heads in European churches, but in those of central Syria terminating in scrolls. Although in its origin the object of the projecting and weathered hood-mould was to protect the face of the wall below from rain, it gives more importance to, and emphasizes, the arch-moulds, so that it is often employed decoratively inside churches.

The suffix "-hood," like the cognate "-head," was originally a substantive meaning rank, status or quality, and was constantly used in combination with other substantives; cf. in O. Eng. *child-hood*, *child-hood*; later it ceased to be used separately and became a mere suffix denoting condition added to adjectives; cf. "falsehood," as well as to substantives.

HOOF, PIETER CORNELISSEN (1581-1647), Dutch poet and historian, was born at Amsterdam on the 16th of March 1581. His father was one of the leading citizens of Holland, both in politics and in the patronage of letters, and for some time burgomaster of Amsterdam. As early as 1598 the young man was made a member of the chamber of rhetoric *In Liefde bloeiende*, and produced before that body his tragedy of *Achilles and Polyxena*, not printed until 1614. In June 1598 he left Holland and proceeded to Paris, where on the 10th of April 1599 he saw the body of Gabrielle d'Estrees lying in state. He went a few months later to Venice, Florence and Rome, and in 1600 to Naples. During his Italian sojourn he made a deep and fruitful study of the best literature of Italy. In July 1600 he sent home to the *In Liefde bloeiende* a very fine letter in verse, expressing his aspirations for the development of Dutch poetry. He returned through Germany, and after an absence of three years and a half found himself in Amsterdam again on the 8th of May 1601. In 1602 he brought out his second tragedy, *Theseus and Ariadne*, printed at Amsterdam in 1614. In 1605 he completed his beautiful pastoral drama *Granida*, not published until 1615. He studied law and history at Leiden from 1606 to 1609, and in June of the latter year received from Prince Maurice of Orange the appointment of steward of Muiden, bailiff of Gooiland, and lord of Weesp, a joint office of great emolument. He occupied himself with repairing and adorning the decayed castle of Muiden, which was his residence during the remainder of his life. There he entertained the poet Vondel, the scholar Barlaeus,¹ Constantin Huygens, Vossius, Laurens Reael and others. Hoof had been a suitor for the hand of Anna Roemer Visscher, and after the death of Roemer Visscher both the sisters visited Muiden. Anna's sympathies were in time diverted to the school of Jacob Cats, but Marie Tesselschade maintained close ties with Hoof, who revised her translation of Tasso. In August 1610 he married Christina van Erp, an

¹ Kaspar van Baerle (1584-1648), professor of rhetoric at Amsterdam, and famous as a Latin poet.

accomplished lady who died in 1623, and four years later he married Eleonora Hellemans. In 1612 Hooft produced his national tragedy of *Goeraerd van Velsen* (pr. 1613), a story of the reign of Count Floris V. In 1614 was performed at Coster's academy Hooft's comedy of *Ware-nar*, an adaptation of the *Asinularia* of Plautus, first printed in 1617. In 1616 he wrote another tragedy, *Baeto*, or *the Origin of the Dutch*, not printed until 1626. It was in 1618 that he abandoned poetry for history, and in 1626 he published the first of his great prose works, the *History of Henry the Great* (Henry IV. of France). His next production was his *Miseries of the Princes of the House of Medici* (Amsterdam, 1638). In 1642 he published at Amsterdam a folio comprising the first twenty books of his *Dutch History*, embracing the period from 1555 to 1585, a magnificent performance, to the perfecting of which he had given fifteen years of labour. The seven concluding books were published posthumously in 1654. His idea of history was gained from Tacitus, whose works he translated. Hooft died on a visit to the Hague, whither he had gone to attend the funeral of Prince Frederick Henry, on the 21st of May 1647, and was buried in the New Church at Amsterdam.

Hooft is one of the most brilliant figures that adorn Dutch literature at its best period. He was the first writer to introduce a modern and European tone into belles lettres, and the first to refresh the sources of native thought from the springs of antique and Renaissance poetry. His lyrics and his pastoral of *Granida* are strongly marked by the influence of Tasso and Sannazaro; his later tragedies belong more exactly to the familiar tone of his native country. But high as Hooft stands among the Dutch poets, he stands higher—he holds perhaps the highest place—among writers of Dutch prose. His historical style has won the warmest eulogy from so temperate a critic as Motley, and his letters are the most charming ever published in the Dutch language. After Vondel, he may on the whole be considered the most considerable author that Holland has produced.

Hooft's poetical and dramatic works were collected in two volumes (1671, 1875) by P. Leendertz. His letters were edited by B. Huydecoper (Leiden, 1738) and by van Vloten (Leiden, 4 vols. 1855). The best original account of Hooft is given by G. Brandt in his *Leven van P. C. Hooft* (1672), and his funeral address (1647), edited together by J. C. Matthes (Groningen, 1874). There is an account of the Muiden circle in Edmund Gosse's *Literatures of Northern Europe*. Many editions exist of his prose works.

HOOGSTRATEN, SAMUEL DIRKZ VAN, Dutch painter, was born, it is said, in 1627 at the Hague, and died at Dort on the 10th of October 1678. This artist, who was first a pupil of his father, lived at the Hague and at Dort till about 1640, when on the death of Dirk Hoogstraten he changed his residence to Amsterdam and entered the school of Rembrandt. A short time afterwards he started as a master and painter of portraits, set out on a round of travels which took him (1651) to Vienna, Rome and London, and finally retired to Dort, where he married in 1656, and held an appointment as "provost of the mint." Hoogstraten's works are scarce; but a sufficient number of them has been preserved to show that he strove to imitate different styles at different times. In a portrait dated 1645 in the Lichtenstein collection at Vienna he imitates Rembrandt; and he continues in this vein as late as 1653, when he produced that wonderful figure of a Jew looking out of a casement, which is one of the most characteristic examples of his manner in the Bevedere at Vienna. A view of the Vienna Hofburg, dated 1652, in the same gallery displays his skill as a painter of architecture, whilst in a piece at the Hague representing a Lady Reading a Letter as she crosses a Courtyard, or a Lady Consulting a Doctor, in the Van der Hoop Museum at Amsterdam, he imitates de Hooch. One of his latest works is a portrait of Mathys van den Brouck, dated 1670, in the gallery of Amsterdam. The scarcity of Hoogstraten's pictures is probably due to his versatility. Besides directing a mint, he devoted some time to literary labours, wrote a book on the theory of painting (1678) and composed sonnets and a tragedy. We are indebted to him for some of the familiar sayings of Rembrandt. He

was an etcher too, and some of his plates are still preserved. His portrait, engraved by himself at the age of fifty, still exists.

HOOK, JAMES CLARKE (1810-1907), English painter, was born in London on the 21st of November 1810. His father, James Hook, a Northumbrian by descent, Judge Arbitrator of Sierra Leone, married the second daughter of Dr Adam Clarke, the commentator on the Bible, who gave to the painter his second name. Young Hook's first taste of the sea was on board the Berwick smacks which took him on his way to Wooler. He drew with rare facility, and determined to become an artist; and accordingly, without any supervision, he set to work for more than a year in the sculpture galleries of the British Museum. In 1836 he was admitted a student of the Royal Academy, where he worked for three years, and elsewhere learned a good deal of the scientific technique of painting from a nephew of Opie. His first picture, called "The Hard Task," was exhibited in 1837, and represented a girl helping her sister with a lesson. Unusual facility in portraiture and a desire to earn his own living took the student into Ireland to paint likenesses of the Waterford family and others; here he produced landscapes of the Vale of Avoca, and much developed his taste for pastoral art; later, he was similarly engaged in Kent and Somersetshire. In 1842 his second exhibited work was a portrait of "Master J. Finch Smith": in this year he gained silver medals at the Royal Academy, and in 1843 he was one of the competitors in the exhibition of cartoons in Westminster Hall, with a 10 by 7 ft. design of "Satan in Paradise." In 1844 the Academy contained a picture of a kind with which his name was long associated, an illustration of the *Decameron*, called "Pamphilus relating his Story," a meadow scene in bright light, with sumptuous ladies, richly clad, reclining on the grass. The British Institution, 1844 and 1845, set forth two of Hook's idylls, subjects taken from Shakespeare and Burns, which, with the above, showed him to be cultivating those veins of romantic sentiment and the picturesque which were then in vogue, but in a characteristically fresh and vigorous manner. "The Song of Olden Times" (Royal Academy, 1845) marked the artist's future path distinctly in most technical respects. It was in this year Hook won the Academy gold medal for an oil picture of "The Finding the Body of Harold." The travelling studentship in painting was awarded to him for "Rizpah watching the Dead Sons of Saul" in 1846; and he went for three years to Italy, having married Miss Rosalie Burton before he left England. Hook passed through Paris, worked diligently for some time in the Louvre, traversed Switzerland, and, though he stayed only part of three years in Italy, gained much from studies of Titian, Tintoret, Carpaccio, Mansueti and other Venetians. Their influence thenceforth dominated the coloration of his pictures, and enabled him to apply the principles to which they had attained to the representation (as Bonington before him had done) of romantic subjects and to those English themes of the land and sea with which the name of the artist is inseparably associated. "A Dream of Ancient Venice" (R.A., 1848)—the first fruit of these Italian studies—"Bayard of Brescia" (R.A., 1849), "Venice" (B.I., 1849) and other works assured for Hook the Associateship of the Royal Academy in 1851. Soon afterwards an incomparable series of English subjects was begun, in many pastorals and fine brilliant idylls of the sea and rocks. "A Rest by the Wayside" and "A Few Minutes to Wait before Twelve o'clock" proved his title to appear, in 1854, as a new and original painter. After these came "A Signal on the Horizon" (1857), "A Widow's Son going to Sea," "The Ship-boy's Letter," "Children's Children are the Crown of Old Men," "A Coast-boy gathering Eggs," a scene at Lundy; the perfect "Luff, Boy!" (1859), about which Ruskin broke into a dithyrambic chant, "The Brook," "Stand Clear!" "O Well for the Fisherman's Boy!" (1860), "Leaving Cornwall for the Whitty Fishing," "Sea Urchins," and a score more as fine as these. The artist was elected a full Academician on the 6th of March 1860, in the place of James Ward. He died on the 14th of April 1907.

See A. H. Palmer, "J. C. Hook, R.A.," *Portfolio* (1868); F. G. Stephens, "J. C. Hook, Royal Academician: His Life and Work," *Art Annual* (London, 1888); P. G. Hamerton, *Etching and Etchers* (London, 1877).

HOOK, THEODORE EDWARD (1788-1841), English author, was born in London on the 22nd of September 1788. He spent a year at Harrow, and subsequently matriculated at Oxford, but he never actually resided at the university. His father, James Hook (1746-1827), the composer of numerous popular songs, took great delight in exhibiting the boy's extraordinary musical and metrical gifts, and the precocious Theodore became "the little pet lion of the green room." At the age of sixteen, in conjunction with his father, he scored a dramatic success with *The Soldier's Return*, a comic opera, and this he rapidly followed up with a series of over a dozen sparkling ventures, the instant popularity of which was hardly dependent on the inimitable acting of John Liston and Charles Mathews. But Hook gave himself up for some ten of the best years of his life to the pleasures of the town, winning a foremost place in the world of fashion by his matchless powers of improvisation and mimicry, and startling the public by the audacity of his practical jokes. His unique gift of improvising the words and the music of songs eventually charmed the prince Regent into a declaration that "something must be done for Hook." The prince was as good as his word, and Hook, in spite of a total ignorance of accounts, was appointed accountant-general and treasurer of the Mauritius with a salary of £2000 a year. For five delightful years he was the life and soul of the island, but in 1817, a serious deficiency having been discovered in the treasury accounts, he was arrested and brought to England on a criminal charge. A sum of about £12,000 had been abstracted by a deputy official, and for this amount Hook was held responsible.

During the tardy scrutiny of the audit board he lived obscurely and maintained himself by writing for magazines and newspapers. In 1820 he launched the newspaper *John Bull*, the champion of high Toryism and the virulent detractor of Queen Caroline. Witty, incisive criticism and pitiless invective secured it a large circulation, and from this source alone Hook derived, for the first year at least, an income of £3000. He was, however, arrested for the second time on account of his debt to the state, which he made no effort to defray. In a sponging-house, where he was confined for two years, he wrote the nine volumes of stories afterwards collected under the title of *Sayings and Doings* (1826-1829). In the remaining twenty-three years of his life he poured forth no fewer than thirty-eight volumes, besides numberless articles, squibs and sketches. His novels are not works of enduring interest, but they are saved from mediocrity by frequent passages of racy narrative and vivid portraiture. The best are *Maxwell* (1830), *Love and Pride* (1833), the autobiographic *Gilbert Gurney* (1836), *Jack Brag* (1837), *Gurney Married* (1838), and *Peregrine Bunce* (1842). Incessant work had already begun to tell on his health, when Hook returned to his old social habits, and a prolonged attempt to combine industry and dissipation resulted in the confession that he was "done up in purse, in mind and in body too at last." He died on the 24th of August 1841. His writings in great part are of a purely ephemeral character; and the greatest triumphs of the improvisatore may be said to have been writ in wine. Putting aside, however, his claim to literary greatness, Hook will be remembered as one of the most brilliant, genial and original figures of Georgian times.

See the Rev. R. H. D. Barham's *Life and Remains of Hook* (3rd ed., 1877); and an article by J. G. Lockhart in the *Quarterly Review* (May 1843).

HOOK, WALTER FARQUHAR (1798-1875), English divine, nephew of the witty Theodore, was born in London on the 13th of March 1798. Educated at Tiverton and Winchester, he graduated at Oxford (Christ Church) in 1821, and after holding an incumbency in Coventry, 1820-1837, and in Leeds, 1837-1850, was nominated dean of Chichester by Lord Derby. He received the degree of D.D. in 1837. His friendship towards the Tractarians exposed him to considerable persecution, but his simple manly character and zealous devotion to parochial

work gained him the support of widely divergent classes. His stay in Leeds was marked by vigorous and far-reaching church extension, and his views on education were far in advance of his time. Among his many writings are *An Ecclesiastical Biography, containing the Lives of Ancient Fathers and Modern Divines* (8 vols., 1845-1852), *A Church Dictionary, The Means of Rendering more Effectual the Education of the People, The Cross of Christ* (1875), *The Church and its Ordinances* (sermons, 4 vols., 1876), and *Lives of the Archbishops of Canterbury* (12 vols., 1860-1876). He died on the 20th of October 1875.

See *Life and Letters of Dean Hook*, by his son-in-law, W. R. W. Stephens (2 vols., 1878).

HOOKEH (the English spelling of the Persian and Hindustani *huggah*, an adaptation of the Arabic *huggah*, a vase or casket, and by transference a pipe for smoking, probably derived from the Arabic *hugg*, a hollow place), a pipe with a long flexible tube attached to a large bowl containing water, often scented, and resting upon a tripod or stand. The smoke of the tobacco is made to pass through the water in the bowl, and is thus cooled before reaching the smoker. The *narghile* of India is in principle the same as that of the hookeh; the word is derived from *nargil*, an Indian name for the coco-nut tree, as when the *narghile* was first made the water was placed in a coco-nut. This receptacle is now often made of porcelain, glass or metal. In the *hubble-bubble* the pipe is so contrived that the water in the bowl makes a bubbling noise while the pipe is being smoked. This pipe is common in India, Egypt and the East generally.

HOOKE, ROBERT (1635-1703), English experimental philosopher, was born on the 18th of July 1635 at Freshwater, in the Isle of Wight, where his father, John Hooke, was minister of the parish. After working for a short time with Sir Peter Lely, he went to Westminster school; and in 1653 he entered Christ Church, Oxford, as servitor. After 1655 he was employed and patronized by the Hon. Robert Boyle, who turned his skill to account in the construction of his air-pump. On the 17th of November 1662 he was appointed curator of experiments to the Royal Society, of which he was elected a fellow in 1663, and filled the office during the remainder of his life. In 1664 Sir John Cutler instituted for his benefit a mechanical lectureship of £50 a year, and in the following year he was nominated professor of geometry in Gresham College, where he subsequently resided. After the Great Fire of 1666 he constructed a model for the rebuilding of the city, which was highly approved, although the design of Sir C. Wren was preferred. During the progress of the works, however, he acted as surveyor, and accumulated in that lucrative employment a sum of several thousand pounds, discovered after his death in an old iron chest, which had evidently lain unopened for above thirty years. He fulfilled the duties of secretary to the Royal Society during five years after the death of Henry Oldenburg in 1677, publishing in 1681-1682 the papers read before that body under the title of *Philosophical Collections*. A protracted controversy with Johann Hevelius, in which Hooke urged the advantages of telescopic over plain sights, brought him little but discredit. His reasons were good; but his offensive style of argument rendered them unpalatable and himself unpopular. Many circumstances concurred to embitter the latter years of his life. The death, in 1687, of his niece, Mrs Grace Hooke, who had lived with him for many years, caused him deep affliction; a law-suit with Sir John Cutler about his salary (decided, however, in his favour in 1696) occasioned him prolonged anxiety; and the repeated anticipation of his discoveries inspired him with a morbid jealousy. Marks of public respect were not indeed wanting to him. A degree of M.D. was conferred on him at Doctors' Commons in 1691, and the Royal Society made him, in 1696, a grant to enable him to complete his philosophical inventions. While engaged on this task he died, worn out with disease, on the 3rd of March 1703 in London, and was buried in St Helen's Church, Bishopsgate Street.

In personal appearance Hooke made but a sorry show. His

figure was crooked, his limbs shrunken; his hair hung in dishevelled locks over his haggard countenance. His temper was irritable, his habits penurious and solitary. He was, however, blameless in morals and reverent in religion. His scientific achievements would probably have been more striking if they had been less varied. He originated much, but perfected little. His optical investigations led him to adopt in an imperfect form the undulatory theory of light, to anticipate the doctrine of interference, and to observe, independently of though subsequently to F. M. Grimaldi (1618-1663), the phenomenon of diffraction. He was the first to state clearly that the motions of the heavenly bodies must be regarded as a mechanical problem, and he approached in a remarkable manner the discovery of universal gravitation. He invented the wheel barometer, discussed the application of barometrical indications to meteorological forecasting, suggested a system of optical telegraphy, anticipated E.F.F. Chladni's experiment of strewing a vibrating bell with flour, investigated the nature of sound and the function of the air in respiration and combustion, and originated the idea of using the pendulum as a measure of gravity. He is credited with the invention of the anchor escapement for clocks, and also with the application of spiral springs to the balances of watches, together with the explanation of their action by the principle *Ut tensio sic vis* (1676).

His principal writings are *Micrographia* (1664); *Lectioes Culinarias* (1674-1679); and *Posthumous Works*, containing a sketch of his "Philosophical Algebra," published by R. Waller in 1705.

HOOKER, JOSEPH (1814-1879), American general, was born in Hadley, Massachusetts, on the 13th of November 1814. He was educated at the military academy at West Point (1833-1837), and on graduating entered the 1st U.S. Artillery. In the war with Mexico (1846-48) he served as a staff officer, and rose by successive brevets for meritorious services to the rank of lieutenant-colonel. In 1853 he left the service and bought a large farm near Sonoma, Cal., which he managed successfully till 1858, when he was made superintendent of military roads in Oregon. Upon the opening of hostilities in the Civil War of 1861-65, he sacrificed his fine estate and offered his sword to the Federal Government. He was commissioned brigadier-general of volunteers on the 17th of May 1861 and major-general on the 5th of May 1862. The engagement of Williamsburg (May 5th) brought him and his subordinate Hancock into prominence, and Hooker received the sobriquet of "Fighting Joe." He was engaged at the battle of Fair Oaks, and did splendid service to the Union army during the "Seven Days." In the campaign of Northern Virginia, under General Pope (August 1862), he led his division with fiery energy at Bristoe Station, Manassas and Chantilly. In the Maryland campaign (September) he was at the head of the I. corps, Army of the Potomac, forced the defile of South Mountain and opened the way for the advance of the army. The I. corps opened the great battle of the Antietam, and sustained a sanguinary fight with the Confederates under Stonewall Jackson. Hooker himself was severely wounded. He was commissioned brigadier-general in the United States army on the 20th of September 1862, and in the battle of Fredericksburg (q.v.), under Burnside, he commanded the centre grand division (III. and V. corps). He had protested against the useless slaughter of his men on that disastrous field, and when Burnside resigned the command Hooker succeeded him. The new leader effected a much-needed re-organization in the army, which had fought many battles without success. In this task, as in subordinate commands in battle, Hooker was excelled by few. But his grave defects as a commander-in-chief were soon to be obvious. By a well-planned and well-executed flanking movement, he placed himself on the enemy's flank, but at the decisive moment he checked the advance of his troops. Lee turned upon him, Jackson surprised and destroyed a whole army corps, and the battle of Chancellorsville (see WILDERNESS), in which Hooker was himself disabled, ended in a retreat to the old position. Yet Hooker had not entirely forfeited the confidence of his men, to whom he was still "Fighting Joe." The second advance of Lee into

Union territory, which led to the battle of Gettysburg, was strenuously resisted by Hooker, who would have inflicted a heavy blow on Lee's scattered forces had he not been condemned to inaction by orders from Washington. Even then Hooker followed the Confederates a day only behind them, until, finding himself distrusted and forbidden to control the movements of troops within the sphere of operations, he resigned the command on the eve of the battle (June 28, 1863). Faults of temper and an excessive sense of responsibility made his continued occupation of the command impossible, but when after a signal defeat Rosecrans was besieged in Chattanooga, and Grant with all the forces of the West was hurried to the rescue, two corps of the Army of the Potomac were sent over by rail, and Hooker, who was at least one of the finest fighting generals of the service, went with them in command. He fought and won the "Battle above the Clouds" on Lookout Mountain which cleared the way for the crowning victory of the army of the Cumberland on Missionary Ridge (see CHATTANOOGA). And in command of the same corps (consolidated as the XX. corps) he took part in all the battles and combats of the Atlanta campaign of 1864. When General McPherson was killed before Atlanta, the command of Grant's old Army of the Tennessee fell vacant. Hooker, who, though only a corps commander, was senior to the other army commanders, Thomas and Schofield, was normally entitled to receive it, but General Sherman feared to commit a whole army to the guidance of a man of Hooker's peculiar temperament, and the place was given to Howard. Hooker thereupon left the army. He was commissioned brevet-major-general in the United States army on the 13th of March 1865, and retired from active service with the full rank of major-general on the 15th of October 1868, in consequence of a paralytic seizure. The last years of his life were passed in the neighbourhood of New York. He died at Garden City, Long Island, on the 31st of October 1879.

HOOKER, SIR JOSEPH DALTON (1817-), English botanist and traveller, second son of the famous botanist Sir W.J. Hooker, was born on the 30th of June 1817, at Halesworth, Suffolk. He was educated at Glasgow University, and almost immediately after taking his M.D. degree there in 1839 joined Sir James Ross's Antarctic expedition, receiving a commission as assistant-surgeon on the "Erebus." The botanical fruits of the three years he thus spent in the Southern Seas were the *Flora Antarctica*, *Flora Novae Zelandiae* and *Flora Tasmaniae*, which he published on his return. His next expedition was to the northern frontiers of India (1847-1851), and the expenses in this case also were partially defrayed by the government. The party had its full share of adventure. Hooker and his friend Dr Campbell were detained in prison for some time by the raja of Sikkim, but nevertheless they were able to bring back important results, both geographical and botanical. Their survey of hitherto unexplored regions was published by the Calcutta Trigonometrical Survey Office, and their botanical observations formed the basis of elaborate works on the rhododendrons of the Sikkim Himalaya and on the flora of India. Among other journeys undertaken by Hooker may be mentioned those to Palestine (1860), Morocco (1871), and the United States (1877), all yielding valuable scientific information. In the midst of all this travelling in foreign countries he quickly built up for himself a high scientific reputation at home. In 1855 he was appointed assistant-director of Kew Gardens, and in 1865 he succeeded his father as full director, holding the post for twenty years. At the early age of thirty he was elected a fellow of the Royal Society, and in 1873 he was chosen its president; he received three of its medals—a Royal in 1854, the Copley in 1887 and the Darwin in 1892. He acted as president of the British Association at its Norwich meeting of 1868, when his address was remarkable for its championship of Darwinian theories. Of Darwin, indeed, he was an early friend and supporter: it was he who, with Lyell, first induced Darwin to make his views public, and the author of *The Origin of Species* has recorded his indebtedness to Hooker's wide knowledge and balanced judgment. Sir Joseph Hooker is the author of numerous

scientific papers and monographs, and his larger books include, in addition to those already mentioned, a standard *Student's Flora of the British Isles* and a monumental work, the *Genera Plantarum*, based on the collections at Kew, in which he had the assistance of Bentham. On the publication of the last part of his *Flora of British India* in 1897 he was created G.C.S.I., of which order he had been made a knight commander twenty years before; and twenty years later, on attaining the age of ninety, he was awarded the Order of Merit.

HOOKER, RICHARD (1553-1600), English writer, author of the *Laws of Ecclesiastical Polity*, son of Richard Vowell or Hooker, was born at Heavitree, near the city of Exeter, about the end of 1553 or beginning of 1554. Vowell was the original name of the family, but was gradually dropped, and in the 15th century its members were known as Vowell *alias* Hooker. At school, not only his facility in mastering his tasks, but his intellectual inquisitiveness and his fine moral qualities, attracted the special notice of his teacher, who strongly recommended his parents to educate him for the church. Though well connected, they were, however, somewhat straitened in their worldly circumstances, and Hooker was indebted for admission to the university to his uncle, John Hooker *alias* Vowell, chamberlain of Exeter, and in his day a man of some literary repute, who induced Bishop Jewel to become his patron and to bestow on him a clerk's place in Corpus Christi College, Oxford. To this Hooker was admitted in 1568. Bishop Jewel died in September 1571, but Dr William Cole, president of the college, from the strong interest he felt in the young man, on account at once of his character and his abilities, spontaneously offered to take the bishop's place as his patron; and shortly afterwards Hooker, by his own labours as a tutor, became independent of gratuitous aid. Two of his pupils, and these his favourite ones, were Edwin Sandys, afterwards author of *Europæe speculum*, and George Cranmer, grand-nephew of the archbishop. Hooker's reputation as a tutor soon became very high, for he had employed his five years at the university to such good purpose as not only to have acquired great proficiency in the learned languages, but to have joined to this a wide and varied culture which had delivered him from the bondage of learned pedantry; in addition to which he is said to have possessed a remarkable talent for communicating knowledge in a clear and interesting manner, and to have exercised a special influence over his pupils' intellectual and moral tendencies. In December 1573 he was elected scholar of his college; in July 1577 he proceeded to M.A., and in September of the same year he was admitted a fellow. In 1579 he was appointed by the chancellor of the university to read the public Hebrew lecture, a duty which he continued to discharge till he left Oxford. Not long after his admission into holy orders, about 1581, he was appointed to preach at St Paul's Cross; and, according to Walton, he was so kindly entertained by Mrs Churchman, who kept the Shunamite's house where the preachers were boarded, that he permitted her to choose him a wife, "promising upon a fair summons to return to London and accept of her choice." The lady selected by her was "her daughter Joan," who, says the same authority, "found him neither beauty nor portion; and for her conditions they were too like that wife's which is by Solomon compared to a dripping house." It is probable that Walton has exaggerated the simplicity and passiveness of Hooker in the matter, but though, as Keble observes with justice, his writings betray uncommon shrewdness and quickness of observation, as well as a vein of keenest humour, it would appear that either gratitude or some other impulse had on this occasion led his judgment astray. After his marriage he was, about the end of 1584, presented to the living of Drayton Beauchamp in Buckinghamshire. In the following year he received a visit from his two pupils, Edwin Sandys and George Cranmer, who found him with the *Odes* of Horace in his hand, tending the sheep while the servant was at dinner, after which, when they on the return of the servant accompanied him to his house, "Richard was called to rock the cradle." Finding him so engrossed by worldly and domestic cares, "they stayed but till the next morning,"

and, greatly grieved at his narrow circumstances and unhappy domestic condition, "left him to the company of his wife Joan."

The visit had, however, results of the highest moment, not only in regard to the career of Hooker, but in regard to English literature and English philosophical thought. Sandys prevailed on his father, the archbishop of York, to recommend Hooker for presentation to the mastership of the Temple, and Hooker, though his "wish was rather to gain a better country living," having agreed after some hesitation to become a candidate, the patent conferring upon him the mastership was granted on the 17th of March 1584/5. The rival candidate was Walter Travers, a Presbyterian and evening lecturer in the same church. Being continued in the lectureship after the appointment of Hooker, Travers was in the habit of attempting a refutation in the evening of what Hooker had spoken in the morning, Hooker again replying on the following Sunday; so it was said "the forenoon sermon spake Canterbury, the afternoon Geneva." On account of the keen feeling displayed by the partisans of both, Archbishop Whitgift deemed it prudent to prohibit the preaching of Travers, whereupon he presented a petition to the council to have the prohibition recalled. Hooker published an *Answer to the Petition of Mr Travers*, and also printed several sermons bearing on special points of the controversy; but, feeling strongly the unsatisfactory nature of such an isolated and fragmentary discussion of separate points, he resolved to compose an elaborate and exhaustive treatise, exhibiting the fundamental principles by which the question in dispute must be decided. It is probable that the work was begun in the latter half of 1586, and he had made considerable progress with it before, with a view to its completion, he petitioned Whitgift to be removed to a country parsonage, in order that, as he said, "I may keep myself in peace and privacy, and behold God's blessing spring out of my mother earth, and eat my own bread without oppositions." His desire was granted in 1591 by a presentation to the rectory of Boscombe near Salisbury. There he completed the volume containing the first four of the proposed *Eight Books of the Laws of Ecclesiastical Polity*. It was entered at Stationers' Hall on the 9th of March 1592, but was not published till 1593 or 1594. In July 1595 he was promoted by the crown to the rectory of Bishopsbourne near Canterbury, where he lived to see the completion of the fifth book in 1597. In the passage from London to Gravesend some time in 1600 he caught a severe cold from which he never recovered; but, notwithstanding great weakness and constant suffering, he "was solicitous in his study," his one desire being "to live to finish the three remaining books of *Polity*." His death took place on the 2nd of November of the same year. A volume professing to contain the sixth and eighth books of the *Polity* was published at London in 1648, but the bulk of the sixth book, as has been shown by Keble, is an entire deviation from the subject on which Hooker proposed to treat, and doubtless the genuine copy, known to have been completed, has been lost. The seventh book, which was published in a new edition of the work by Gauden in 1662, and the eighth book, may be regarded as in substance the composition of Hooker; but, as, in addition to wanting his final revision, they have been very unskillfully edited, if they have not been manipulated for theological purposes, their statements in regard to doubtful matters must be received with due reserve, and no reliance can be placed on their testimony where their meaning contradicts that of other portions of the *Polity*.

The conception of Hooker in his later years, which we form from the various accessible sources, is that of a person of low stature and not immediately impressive appearance, much bent by the influence of sedentary and meditative habits, of quiet and retiring manners, and discoloured in complexion and worn and marked in feature from the hard mental toil which he had expended on his great work. There seems, however, exaggeration in Walton's statement as to the meanness of his dress; and Walton certainly misreads his character when he portrays him as a kind of ascetic mystic. Though he was unworshipful and simple in his desires, and engrossed in the purpose to which he had devoted his life—the "completion of the *Polity*"—his

writings indicate that he possessed a cheerful and healthy disposition, and that he was capable of discovering enjoyment in everyday pleasures, and of appreciating human life and character in a wide variety of aspects. He seems to have had a special delight in outward nature—as he expressed it, he loved "to see God's blessing spring out of his mother earth"; and he spent much of his spare time in visiting his parishioners, his deference towards them, if excessive, being yet mingled with a grave dignity which rendered unwarrantable liberties impossible. As a preacher, though singularly devoid of the qualities which win the applause of the multitude, he always excited the interest of the more intelligent, the breadth and finely balanced wisdom of his thoughts and the fascination of his composition greatly modifying the impression produced by his weak voice and ineffective manner. Partly, doubtless, on account of his dim-sightedness, he never removed his eye from his manuscript, and, according to Fuller, "he may be said to have made good music with his fiddle and stick alone, having neither pronunciation nor gesture to grace his matter."

To accede without explanation to the claim put forth for the *Ecclesiastical Polity* of Hooker, that it marks an epoch in English prose literature and English thought, would both be to do some injustice to writers previous to him, and, if not to overestimate his influence, to misinterpret its character. By no means can his excursions in English prose be regarded as chiefly those of a pioneer; and not only is his intellectual position inferior to that of Shakespeare, Spenser and Bacon,¹ who alone can be properly reckoned as the master spirits of the age, but in reality what effect he may have had upon the thought of his contemporaries was soon disregarded and swept out of sight in the hand-to-hand struggle with Puritanism, and his influence, so far from being immediate and confined to one particular era, has since the reaction against Puritanism been slowly and imperceptibly permeating and colouring English thought. His work is, however, the earliest in English prose of the preserving salt of excellence to adapt it to the mental palate of modern readers. Attempts more elaborate than those of the old chroniclers had been made two centuries previously to employ English prose both for narrative and for discussion; and, a few years before him, Roger Ascham, Sir Thomas More, Latimer, Sir Philip Sidney, the compilers of the prayer book, and various translators of the Bible, had in widely different departments of literature brought to light many samples of the rich wealth of expression that was latent in the language; but Hooker's is the first independent work in English prose of notable power and genius, and the vigour and grasp of its thought are not more remarkable than the felicity of its literary style. Its more usual and obvious excellences are clearness of expression, notwithstanding occasionally complicated methods; great aptness and conciseness in the formation of individual clauses, and such a fine sense of proportion and rhythm in their arrangement as almost conceals the difficulties of syntax by which he was hampered; finished simplicity, notwithstanding a statelyness too uniform and unbroken; a nice discrimination in the choice of words and phrases, so as both to portray the exact shade of his meaning, and to express each of his thoughts with that degree of emphasis appropriate to its place in his composition. In regard to qualities more relating to the matter than the manner we may note the subtle and partly bidden humour; the strong enthusiasm underlying that seemingly calm and passionless exposition of principles which continually led him away from the minutiae of temporary disputes, and has earned for him the somewhat misleading epithet of "judicious;" the solidity of learning, not ostentatiously displayed, but indicated in the character and variety of his illustrations and his comprehensive mastery of all that relates to his subject; the breadth of his conceptions, and the sweep and ease of his movements in the highest regions of thought; the fine poetical descriptions occasionally introduced, in which his eloquence attains a grave, rich and massive harmony that compares not unfavourably with the finest prose of Milton. His manner is, of course, defective in the flexibility and variety characteristic of the best models of English prose literature after the language had been enriched and perfected by long use, and his sentences, constructed too much according to Latin usages, are often tautological and too protracted into long concatenations of clauses; but if, when regarded superficially, his style presents in some respects a stiff and antiquated aspect, it yet possesses an original and innate charm that has retained its freshness after the lapse of nearly three centuries.

The direct interest in the *Ecclesiastical Polity* is now philosophical and political rather than theological, for what theological importance it possessed was rather in regard to the spirit and method in which theology should be discussed than in regard to the decision of strictly theological points. Hooker bases his reasoning on principles which

¹ If Bacon was the author of *The Christian Paradoxes*, his philosophical standpoint in reference to religion was not only less advanced than that of Hooker, but in a sense directly opposed to it.

he discovered in Augustine and Thomas Aquinas, but the intellectual atmosphere of his age was different from that which surrounded them; he was acted upon by new and more various impulses enabling him to imbibe more thoroughly the spirit of Greek thought which was the source of their inspiration, and thus to reach a higher and freer region than scholasticism, and in a sense to inaugurate modern philosophy in England. It may be admitted that his principles are only partially and in some degree capriciously wrought out—that if he is not under the dominion of intellectual tendencies leading to opposite results there are occasional blanks and gaps in his argument where he seems sometimes to be groping after a meaning which he cannot fully grasp; but he is often charged with obscurity simply because readers of various theological schools, beholding in his principles what seem the outline and justification of their own ideas, are disappointed when they find that these outlines instead of acquiring as they narrowly examine them the full and definite form of their anticipations, widen out into a region beyond their notions and sympathies, and therefore from their point of view enveloped in mist and shade. It is the exposition of philosophical principles in the first and second books of the *Polity*, and not the application of these principles in the remaining books that gives the work its standard place in English literature. It was intended to be an answer to the attacks of the Presbyterians on the Episcopalian polity and customs, but no attempt is made directly to oust Presbyterianism from the place it then held in the Church of England. The work must rather be regarded as a remonstrance against the narrow ground chosen by the Presbyterians for their basis of attack, Hooker's exact position being that "a necessity of polity and regiment may be held in all churches without holding any form to be necessary."

The general purpose of his reasoning is to vindicate Episcopacy from objections that had been urged against it, but he attains a result which has other and wider consequences than this. The fundamental principle on which he bases his reasoning is the unity and all-embracing character of law—law "whose seat," he beautifully says, "is the bosom of God, whose voice the harmony of the world." Law—as operative in nature, as regulating each man's individual character and actions, as seen in the formations of societies and governments—is equally a manifestation and development of the divine order according to which God Himself acts, is the expression in various forms of the divine reason. He makes a distinction between natural and positive laws, the one being eternal and immutable, the other varying according to external necessity and expediency; and he includes all the forms of government under laws that are positive and therefore alterable according to circumstances. Their application is to be determined by reason, reason enlightened and strengthened by every variety of knowledge, discipline and experience. The leading feature in his system is the high place assigned to reason, for, though affirming that certain truths necessary to salvation could be made known only by special divine revelation, he yet elevates reason into the criterion by which these truths are to be judged, and the standard to determine what in revelation is temporal and what eternal. "It is not the word of God itself," he says, "which doth or possibly can assure us that we do well to think it His word." At the same time he saves himself from the dangers of abstract and rash theorizing by a deep and absolute regard for facts, the diligent and accurate study of which he makes of the first importance to the proper use of reason. "The general and perpetual voice of men is," he says, "as the sentence of God Himself. For that which all men have at all times learned, nature herself must needs have taught; and God being the author of nature, her voice is but His instrument." Applying his principles to man individually, the foundation of morality is, according to Hooker, immutable, and rests "on that law which God from the beginning hath set Himself to do all things by"; this law is to be discovered by reason; and the perfection which reason teaches us to strive after is stated, with characteristic breadth of conception and regard to the facts of human nature, to be "a triple perfection: first a sensual, consisting in those things which very life itself requireth, either as necessary supplements, or as beauties or ornaments thereof; then an intellectual, consisting in those things which none underneath man is either capable of or acquainted with; lastly, a spiritual or divine, consisting in those things whereunto we tend by supernatural means here, but cannot here attain unto them." Applying his principles to man as a member of a community, he assigns practically the same origin and sanctions to ecclesiastical as to civil government. His theory of government forms the basis of the *Treatise on Civil Government* by Locke, although Locke developed the theory in a way that Hooker would not have sanctioned. The force and justification of government Hooker derives from public approbation, either given directly by the parties immediately concerned, or indirectly through inheritance from their ancestors. "Sixth men," he says, "naturally have no full and perfect power to command whole politic multitudes of men, therefore utterly without our consent we could in such sort be at no man's commandment living. And to be commanded we do consent, when that society whereof we are part hath at any time before consented, without revoking the same after, by the like universal agreement." His theory as he stated it is in various of its aspects and applications liable to objection; but taken as a whole it is the first philosophical statement of the principles which, though disregarded in the succeeding age, have since regulated political progress in England

and gradually modified its constitution. One of the corollaries of his principles is his theory of the relation of church and state, according to which, with the qualifications implied in his theory of government, he asserts the royal supremacy in matters of religion, and identifies the church and commonwealth as but different aspects of the same government.

BIBLIOGRAPHY.—A life of Hooker by Dr Gauden was published in his edition of Hooker's works (London, 1662). To correct the errors in this life Walton wrote another, which was published in the 2nd edition of Hooker's works in 1666. The standard modern edition of Hooker's works is that by Keble, which first appeared in 1836, and has since been several times reprinted (1888 edition, revised by Dean Church and Bishop Paget). The first book of the *Laws of Ecclesiastical Polity* was edited for the Clarendon Press by Dean R. W. Church (1868-1876). (T. F. H.)

HOOKER, THOMAS (1586-1647), New England theologian, was born, probably on the 7th of July 1586, at Marfield, in the parish of Tilton, County of Leicester, England. He graduated B.A. in 1608 and M.A. in 1611 at Emmanuel College, Cambridge, the intellectual centre of Puritanism, remained there as a fellow for a few years, and then preached in the parish of Esher in Surrey. About 1626 he became lecturer to the church of St Mary at Chelmsford, Essex, delivering on market days and Sunday afternoons evangelical addresses which were notable for their moral fervour. In 1629 Archbishop Laud took measures to suppress church lectureships, which were an innovation of Puritanism. Hooker was placed under bond and retired to Little Baddow, 4 m. from Chelmsford. In 1630 he was cited to appear before the Court of High Commission, but he forfeited his bond and fled to Holland, whence in 1633 he emigrated to the Colony of Massachusetts Bay in America, and became pastor at Newtowne (now Cambridge), Mass., of a company of Puritans who had arrived from England in the previous year and in expectation of his joining them were called "Mr Hooker's Company." Hooker seems to have been a leader in the formation of that sentiment of discontent with the Massachusetts government which resulted in the founding of Connecticut. He publicly criticized the limitation of suffrage to church members, and, according to a contemporary historian, William Hubbard (*General History of New England*), "after Mr Hooker's coming over it was observed that many of the freemen grew to be very jealous of their liberties." He was a leader of the emigrants who in 1636 founded Hartford, Connecticut. In a sermon before the Connecticut General Court of 1638, he declared that "the choice of public magistrates belongs unto the people by God's own allowance" and that "they who have the power to appoint officers and magistrates, it is in their power, also, to set the bounds and limitations of the power and place unto which they call them." Though this theory was in advance of the age, Hooker had no idea of the separation of church and state—"the privilege of election, which belongs to the people," he said, must be exercised "according to the blessed will and law of God." He also defended the right of magistrates to convene synods, and in the Fundamental Orders of Connecticut (1639), which he probably framed, the union of church and state is presupposed. Hooker was pastor of the Hartford church until his death on the 7th of July 1647. He was active in the negotiations which preceded the formation of the New England Confederation in 1643. In the same year he attended the meeting of Puritan ministers at Boston, whose object was to defend Congregationalism, and he wrote a *Survey of the Summe of Church Discipline* (1648) in justification of the New England church system. His other works deal chiefly with the experimental phases of religion, especially the experience precedent to conversion. In *The Soule's Humiliation* (1637), he assigns as a test of conversion a willingness of the convert to be damned if that be God's will, thus anticipating the doctrine of Samuel Hopkins in the following century.

See George L. Walker's *Thomas Hooker* (New York, 1891); the appendix of which contains a bibliography of Hooker's published works.

HOOKER, SIR WILLIAM JACKSON (1785-1865), English botanist, was born at Norwich on the 6th of July 1785. His father, Joseph Hooker of Exeter, a member of the same family as the celebrated Richard Hooker, devoted much of his time

to the study of German literature and the cultivation of curious plants. The son was educated at the high school of Norwich, on leaving which his independent means enabled him to travel and to take up as a recreation the study of natural history, especially ornithology and entomology. He subsequently confined his attention to botany, on the recommendation of Sir James E. Smith, whom he had consulted respecting a rare moss. His first botanical expedition was made in Iceland, in the summer of 1809, at the suggestion of Sir Joseph Banks; but the natural history specimens which he collected, with his notes and drawings, were lost on the homeward voyage through the burning of the ship, and the young botanist himself had a narrow escape with his life. A good memory, however, aided him to publish an account of the island, and of its inhabitants and flora (*Tour in Iceland*, 1809), privately circulated in 1811, and reprinted in 1813. In 1810-1811 he made extensive preparations, and sacrifices which proved financially serious, with a view to accompany Sir R. Brownrigg to Ceylon, but the disturbed state of the island led to the abandonment of the projected expedition. In 1811 he spent nine months in botanizing excursions in France, Switzerland and northern Italy, and in the following year he married the eldest daughter of Mr Dawson Turner, banker, of Yarmouth. Settling at Halesworth, Suffolk, he devoted himself to the formation of his herbarium, which became of world-wide renown among botanists. In 1816 appeared the *British Jungermanniaceae*, his first scientific work, which was succeeded by a new edition of William Curtis's *Flora Londinensis*, for which he wrote the descriptions (1817-1828); by a description of the *Plantae cryptogamicæ* of A. von Humboldt and A. Bonpland; by the *Muscologia Britannica*, a very complete account of the mosses of Great Britain and Ireland, prepared in conjunction with Dr T. Taylor (1818); and by his *Musci exotici* (2 vols., 1818-1820), devoted to new foreign mosses and other cryptogamic plants. In 1820 he accepted the regius professorship of botany in Glasgow University where he soon became popular as a lecturer, his style being both clear and ready. The following year he brought out the *Flora Scotica*, in which the natural method of arrangement of British plants was given with the artificial. Subsequently he prepared or edited many works, the more important being the following:—

Botanical Illustrations (1822); *Exotic Flora*, indicating such of the specimens as are deserving cultivation (3 vols., 1822-1827); *Account of Sabine's Arctic Plants* (1824); *Catalogue of Plants in the Glasgow Botanic Garden* (1825); the *Botany of Farry's Third Voyage* (1826); *The Botanical Magazine* (38 vols., 1827-1865); *Icones Filicum*, in concert with Dr E. K. Greville (2 vols., 1829-1831); *British Ferns*, of which several editions appeared, undertaken with Dr G. A. W. Arnott, &c. (1830); *British Flora Cryptogamica* (1833); *Characters of Genera from the British Flora* (1830); *Flora Boreali-Americana* (2 vols., 1840), being the botany of British North America collected in Sir J. Franklin's voyage; *The Journal of Botany* (4 vols., 1830-1842); *Companion to the Botanical Magazine* (2 vols., 1835-1836); *Icones plantarum* (10 vols., 1837-1854); the *Botany of Beechey's Voyage to the Pacific and Behring's Straits* (with Dr Arnott, 1841); the *Genera Filicum* (1842), from the original coloured drawings of F. Bauer, with additions and descriptive letterpress; *The London Journal of Botany* (7 vols., 1842-1848); *Notes on the Botany of the Antarctic Voyage of the Erebus and Terror* (1843); *Species filicum* (5 vols., 1846-1864), the standard work on this subject; *A Century of Orchideæ* (1846); *Journal of Botany and Kew Garden Miscellany* (6 vols., 1849-1857); *Niger Flora* (1849); *Victoria Regia* (1851); *Museums of Economic Botany at Kew* (1855); *Filices exotice* (1857-1859); *The British Ferns* (1861-1862); *A Century of Ferns* (1854); *A Second Century of Ferns* (1860-1861).

It was mainly by Hooker's exertions that botanists were appointed to the government expeditions. While his works were in progress his herbarium received large and valuable additions from all parts of the globe, and his position as a botanist was thus vastly improved. He was made a knight of Hanover in 1836 and in 1841 he was appointed director of the Royal Botanical Gardens at Kew, on the resignation of W. T. Aiton. Under his direction the gardens expanded from 11 to 75 acres, with an arboretum of 270 acres, many new glass-houses were erected, and a museum of economic botany was established. He was engaged on the *Synopsis filicum* with J. G. Baker

when he was attacked by a throat disease then epidemic at Kew, where he died on the 12th of August 1865.

HOOLE, JOHN (1727-1803), English translator and dramatist, son of a watchmaker and machinist, Samuel Hoole, was born at Moorfields, London, in December 1727. He was educated at a private school at Hoddesdon, Hertfordshire, kept by James Bennet, who edited Ascham's English works. At the age of seventeen he became a clerk in the accountants' department of the East India House, and before 1767 became one of the auditors of Indian accounts. His leisure hours he devoted to the study of Latin and especially Italian, and began writing translations of the chief works of the Italian poets. He published translations of the *Jerusalem Delivered* of Tasso in 1763, the *Orlando Furioso* of Ariosto in 1773-1783, the *Dramas* of Metastasio in 1767, and *Rinaldo*, an early work of Tasso, in 1792. Among his plays are: *Cyrus* (1768), *Timanthes* (1770) and *Cleonicé, Princess of Bithynia* (1775), none of which achieved success. The verses of Hoole were praised by Johnson, with whom he was on terms of intimacy, but, though correct, smooth and flowing, they cannot be commended for any other merit. His translation of the *Orlando Furioso* was superseded by the version (1823-1831) of W. S. Rose. Hoole was also the friend of the Quaker poet John Scott of Amwell (1730-1783), whose life he wrote; it was prefixed to Scott's *Critical Essays* (1785). In 1773 he was promoted to be chief auditor of Indian accounts, an office which he resigned in 1785. In 1786 he retired to the parsonage of Abinger, Surrey; and afterwards lived at Tenterden, Kent, dying at Dorking on the 2nd of April 1803.

See *Anecdotes of the Life of the late Mr John Hoole*, by his surviving brother, Samuel Hoole (London, 1803). Some of his plays are reprinted in J. Bell's *British Theatre* (1797).

HOOLIGAN, the generally accepted modern term for a young street ruffian or rowdy. It seems to have been first applied to the young street ruffians of the South-East of London about 1890, but though popular in the district, did not attract general attention till later, when authentic information of its origin was lost, but it appears that the most probable source was a comic song which was popular in the lower-class music-hall in the late 'eighties or early 'nineties, which described the doings of a rowdy family named Hooligan (*i.e.* Irish Houlihan). A comic character with the same name also appears to have been the central figure in a series of adventures running through an obscure English comic paper of about the same date, and also in a similar New York paper, where his confrère in the adventures is a German named Schneider (see *Notes and Queries*, 9th series, vol. ii. pp. 227 and 316, 1898, and 10th series, vol. vii. p. 115, 1901). In other countries the "hooligan" finds his counterpart. The Parisian *Apache*, so self-styled after the North American Indian tribe, is a much more dangerous character; mere rowdiness, the characteristic of the English "hooligan," is replaced by murder, robbery and outrage. An equally dangerous class of young street ruffian is the "hoodlum" of the United States of America; this term arose in San Francisco in 1870, and thence spread. Many fanciful origins of the name have been given, for some of which see *Manchester (N.H.) Notes and Queries*, September 1883 (cited in the *New English Dictionary*). The "plug-ugly" of Baltimore is another name for the same class. More familiar is the Australian "larrikin," which apparently came into use about 1870 in Melbourne. The story that the word represents an Irish policeman's pronunciation of "larking" is a mere invention. It is probably only an adaptation of the Irish "Larry," short for Lawrence. Others suggest that it is a corruption of the slang *Leary Kinchen*, *i.e.* knowing, wide-awake child.

HOOPER, JOHN (d. 1555), bishop of Gloucester and Worcester and martyr, was born in Somerset about the end of the 15th century and graduated B.A. at Oxford in 1519. He is said to have then entered the Cistercian monastery at Gloucester; but in 1538 a John Hooper appears among the names of the Black friars at Gloucester and also among the White friars at Bristol who surrendered their houses to the king. A John Hooper was likewise canon of Wormesley priory in Herefordshire;

but identification of any of these with the future bishop is doubtful. The *Greyfriars' Chronicle* says that Hooper was "sometime a white monk"; and in the sentence pronounced against him by Gardiner he is described as "*olim monachus de Cliva Ordinis Cisterciensis*," *i.e.* of the Cistercian house at Cleve in Somerset. On the other hand, at his deprivation he was not accused, like the other married bishops who had been monks or friars, of infidelity to the vow of chastity; and his own letters to Bullinger are curiously reticent on this part of his history. He there speaks of himself as being the only son and heir of his father and as fearing to be deprived of his inheritance if he adopted the reformed religion. Before 1546 he had secured employment in the household of Sir Thomas Arundell, a man of influential connexions. Hooper speaks of himself at this period as being "a courtier and living too much of a court life in the palace of our king." But he chanced upon some of Zwingli's works and Bullinger's commentaries on St Paul's epistles; and after some molestation in England and some correspondence with Bullinger on the lawfulness of complying against his conscience with the established religion, he determined to secure what property he could and take refuge on the continent. He had an adventurous journey, being twice imprisoned, driven about for three months on the sea, and reaching Strassburg in the midst of the Schmalkaldic war. There he married Anne de Tserclaes, and later on he proceeded by way of Basle to Zürich, where his Zwinglian convictions were confirmed by constant intercourse with Zwingli's successor, Bullinger.

It was not until May 1549, after he had published various works at Zürich, that Hooper again arrived in England. He at once became the principal champion of Swiss Protestantism against the Lutherans as well as the Catholics, and was appointed chaplain to Protector Somerset. Somerset's fall in the following October endangered Hooper's position, and for a time he was in hourly dread of imprisonment and martyrdom, more especially as he had taken a prominent part against Gardiner and Bonner, whose restoration to their sees was now anticipated. Warwick, afterwards duke of Northumberland, however, overcame the reactionaries in the Council, and early in 1550 the Reformation resumed its course. Hooper became Warwick's chaplain, and after a course of Lent lectures before the king he was offered the bishopric of Gloucester. This led to a prolonged controversy; Hooper had already denounced the "Aaronic vestments" and the oath by the saints prescribed in the new Ordinal; and he refused to be consecrated according to its rites. Cranmer, Ridley, Bucer and others urged him to submit in vain; confinement to his house by order of the Council proved equally ineffectual; and it was not until he had spent some weeks in the Fleet prison that the "father of nonconformity" consented to conform, and Hooper submitted to consecration with the legal ceremonies (March 8, 1551).

Once seated in his bishopric Hooper set about his episcopal duties with exemplary vigour. His visitation of his diocese (printed in *English Hist. Rev.* Jan. 1904, pp. 98-121) revealed a condition of almost incredible ignorance among his clergy. Fewer than half could say the Ten Commandments; some could not even repeat the Lord's Prayer in English. Hooper did his best in the time at his disposal; but in less than a year the bishopric of Gloucester was reduced to an archdeaconry and added to Worcester, of which Hooper was made bishop in succession to Nicholas Heath (*q.v.*). He was opposed to Northumberland's plot for the exclusion of Mary from the throne; but this did not save him from speedy imprisonment. He was sent to the Fleet on the 1st of September 1553 on a doubtful charge of debt to the queen; but the real cause was his stanchness to a religion which was still by law established. Edward VI.'s legislation was, however, repealed in the following month, and in March 1554 Hooper was deprived of his bishopric as a married man. There was still no statute by which he could be condemned to the stake, but Hooper was kept in prison; and the revival of the heresy acts in December 1554 was swiftly followed by execution. On the 29th of January 1555, Hooper, Rogers, Rowland Taylor and others were condemned by Gardiner and

In hop gardens a few male plants, usually three or four to an acre, are sometimes planted, that number being deemed sufficient to fertilize the female flowers. The blossoms are produced in August, and the strobiles are fit for gathering from the beginning of September to the middle of October, according to the weather.

The cultivation of hops for use in the manufacture of beer dates from an early period. In the 8th and 9th centuries hop gardens, called "humularia" or "humuleta," existed in France and Germany. Until the 16th century, however, hops appear to have been grown in a very fitful manner, and to a limited extent, generally only for private consumption; but after the beginning of the 17th century the cultivation increased rapidly. The plant was introduced into England from Flanders in 1525; and in America its cultivation was encouraged by legislative enactments in 1657. Formerly several plants were used as well as hops to season ale, hence the name "alehoof" for *Nepeta Glechoma*, and "alecost" for *Balsamita vulgaris*. The sweet gale, *Myrica Gale*, and the sage, *Salvia officinalis*,



FIG. 2.—Fruit of Hop.

were also similarly employed. Various hop substitutes, in the form of powder, have been offered in commerce of late years, most of which appear to have quassia as a chief ingredient. The young tender tops of the hop are in Belgium cut off in spring and eaten like asparagus, and are forced from December to February.

Medical Use.—The principal constituents of the strobiles are lupulin, one of the few liquid alkaloids; lupulinic acid, a bitter crystalline body, soluble in ether, which is without any other pharmacological action than that common to bitter substances; Valerol, a volatile oil which in old hops undergoes a change to the malodorous body valerianic acid; resin; trimethylamine; a peculiar modification of tannin known as humulotannic acid; and a sesqui-terpene. The British pharmacopoeia contains two preparations of the strobiles,—an infusion (dose, 1-2 oz.) and a tincture (dose, ʒ-i drachm). The glands obtained from the strobiles are known in pharmacy as lupulin, a name which tends to confusion with that of the alkaloid. They occur in commerce as a bright yellow-brown powder, seen under a lens to consist of minute glandular particles. The dose of this so-called lupulin is 2-5 grains. From it there is prepared the Tinctura Lupulinae of the United States pharmacopoeia, which is given in doses of 10-60 minims. Furthermore, there are prepared hop pillows,

designed to procure sleep; but these act, when at all, mainly by suggestion. The pharmacological action of hops is determined first by the volatile oil they contain, which has the actions of its class. Similarly the lupulinic acid may act as a bitter tonic. The preparations of hops, when taken internally, are frequently hypnotic, though unfortunately different specimens vary considerably in composition, none of the preparations being standardized. It is by no means certain whether the hypnotic action of hops is due to the alkaloid lupulin or possibly to the volatile oil which they contain. Medical practice, however, is acquainted with many more trustworthy and equally safe hypnotics. The bitter acid of hops may endow beer containing it with a certain value in cases of impaired gastric digestion, and to the hypnotic principle of hops may partly be ascribed—as well as to the alcohol—the soporific action of beer in the case of some individuals.

HOP PRODUCTION IN ENGLAND¹

The cultivation of hops in the British Isles is restricted to England, where it is practically confined to half-a-dozen counties—four in the south-eastern and two in the west-midland districts. In 1901 the English crop was reported by the Board of Agriculture to occupy 51,127 acres. The official returns as to acreage do not extend back beyond 1868, in which year the total area was reported to be 64,488 acres. The largest area recorded since then was 71,789 acres in 1878; the smallest was 44,938 acres in 1907. The extent to which the areas of hops in the chief hop-growing counties vary from year to year is sufficiently indicated in Table I., which shows the annual acreages over a period of thirteen years, 1895 to 1907. The proportions in which the acres of hops are distributed amongst the counties concerned vary but little year by year, and as a rule over 60% belongs to Kent.

TABLE I.—Hop Areas of England 1895 to 1907. Acres.

	Kent.	Hereford.	Sussex.	Worcester.	Hants.	Surrey.
1895	35,018	7553	7489	4024	2875	1783
1896	33,300	6895	5908	3800	2494	1623
1897	31,661	6542	5174	3591	2306	1416
1898	39,941	6651	4829	3567	2263	1313
1899	31,988	7227	4949	3788	2319	1388
1900	31,514	7287	4823	3964	2231	1300
1901	31,242	7497	4800	4029	2133	1232
1902	29,649	6915	4541	3779	2003	969
1903	29,933	6851	4454	3697	1920	901
1904	29,841	6767	4474	3752	1900	877
1905	30,655	6851	4647	3807	1978	843
1906	29,296	6481	4379	3672	1939	777
1907	28,169	6143	4243	3622	1842	744

Less than 200 acres in all are annually grown in the other hop-growing counties of England, these being Shropshire, Gloucestershire and Suffolk.

The average yield per acre in cwt. in the six counties during the decade 1897 to 1906 was as follows:—

TABLE II.

Kent.	Hereford.	Sussex.	Worcester.	Hants.	Surrey.
9.31	7.14	9.41	7.79	8.78	7.23

Table III. shows the average acreage, yield and total home produce of England during the decades 1888-1897 and 1898-1907.

TABLE III.

Periods.	Average Annual Acreage.	Average Annual Yield per acre (cwt.).	Average Annual Home Produce (cwt.).
1888-1897	56,370	7.76	438,215
1898-1907	48,841	8.84	434,567

The wide fluctuations in the home production of hops are worthy of note, as they exercise a powerful influence upon market prices. The largest crop between 1885, the first year in which figures relating to production were collected, and 1907 was

¹ See Report from the Select Committee on the Hop Industry (London, 1908).

that of 776,144 cwt. in 1886, and the smallest that of 281,291 cwt. in 1888, the former being more than 2½ times the size of the latter. The crop of 1899, estimated at 661,373 cwt., was so large that prices receded to an extent such as to leave no margin of profit to the great body of growers, whilst some planters were able to market the crop only at a loss. The calculated annual average yields per acre over the years 1885 to 1907 ranged between 12.76 cwt. in 1899 and 4.81 cwt. in 1888. No other staple crop of British agriculture undergoes such wide fluctuations in yield as are here indicated, the size of the crop produced bearing no relation to the acreage under cultivation. For example, the 71,327 acres in 1885 produced only 509,170 cwt., whereas the 51,843 acres in 1899 produced 661,373 cwt.—19,484 acres less under crop yielded 152,203 cwt. more produce.

Comparing the quantities of home-grown hops with those of imported hops, of the total available for consumption about 70% on the average is home produce and about 30% is imported produce. The imports, however, do not vary so much as the home produce. Table IV. shows the average quantity of imports to and exports (home-grown) from Great Britain during the decades 1877-1886, 1887-1896 and 1897-1906.

TABLE IV.

Periods.	Annual Average Imports (cwt.).	Annual Average Exports (cwt.).
1877-1886	215,219	10,805
1887-1896	194,966	9,437
1897-1906	186,362	14,808

The highest and lowest imports were 266,952 cwt. in 1885 and 145,122 cwt. in 1887, the latter in the year following the biggest home-grown crop on record. On a series of years the largest proportion of imports is from the United States.

During the twenty-five years 1881-1905 the annual values of the hops imported into England fluctuated between the wide limits of £2,962,631 in 1882 and £427,753 in 1887. In five other years besides 1882 the value exceeded a million sterling. The annual average value over the whole period was £921,000, whilst the annual average import was 194,000 cwt., consequently the average value per cwt. was nearly £4, 15s., which is approximately the same as that of the exported product. The quantities and values of the imported hops that are again exported are almost insignificant.

HOP PRODUCTION IN THE UNITED STATES

The distribution of the area of hop-cultivation in the United States showed great changes during the last decades of the 19th and the first decade of the 20th century. During the earlier portion of that period New York was the chief hop-growing state of the Union, but toward the end of it a great extension of hop-growing took place on the Pacific coast (in the states of Oregon, California and Washington), where the richness of the soil and mildness of the climate are favourable to the bines.

The average annual produce of hops in the United States from 1900 to 1906 was 423,471 cwt.; of this quantity 80% was raised in the three states of the Pacific coast, where the yield per acre is much larger than in New York. In the latter state the yield does not appear to exceed 5 or 6 cwt. per acre, whereas in Oregon it is 9 or 10 cwt., and in Washington and California from 12 to 14 cwt. The average annual export (chiefly to Great Britain) in the years from 1899 to 1905 was 108,400 cwt.; the average import (chiefly from Germany) is about 50,000 cwt.

HOP CULTIVATION

As the county of Kent has always taken the lead in hop-growing in England, and as it includes about two-thirds of the hop acreage of the British Isles, the recent developments in hop cultivation cannot be better studied than in that county. They were well summarized by Mr Charles Whitehead in his sketch of the agriculture of Kent,¹ wherein he states that the hop grounds—or hop gardens, as they are called in Kent—of

¹ Jour. Roy. Agric. Soc. 1899.

poor character and least suitable for hop production have been gradually grubbed since 1894, on account of large crops, the importation of hops and low prices. At the beginning of the 19th century there were 290 parishes in Kent in which hops were cultivated. A century later, out of the 413 parishes in the county, as many as 331 included hop plantations. The hops grown in Kent are classified in the markets as "East Kents," "Bastard East Kents," "Mid Kents" and "Wealds," according to the district of the county in which they are produced. The relative values of these four divisions follow in the same order, East Kents making the highest and Wealds the lowest rates. These divisions agree in the main with those defined by geological formations. Thus, "East Kents" are grown upon the Chalk, and especially on the outcrop of the soils of the London Tertiaries upon the Chalk. "Bastard East Kents" are produced on alluvial soil and soils formed by admixtures of loam, clay-loams, chalk, marl and clay from the Gault, Greensand and Chalk formations. "Mid Kents" are derived principally from the Greensand soils and outcrops of the London Tertiaries in the upper part of the district. "Wealds" come from soils on the Weald Clay, Hastings Sand and Tunbridge Wells Sand. As each "pocket" of hops must be marked with the owner's name and the parish in which they were grown, buyers of hops can, without much trouble, ascertain from which of the four divisions hops come, especially if they have the map of the hop-growing parishes of England, which gives the name of each parish. There has been a considerable rearrangement of the hop plantations in Kent within recent years. Common varieties as Colegate's, Jones's, Grapes and Prolifics have been grubbed, and Goldings, Bramlings and other choice kinds planted in their places. The variety known as Fuggle's, a heavy-cropping though slightly coarse hop, has been much planted in the Weald of Kent, and in parts of Mid Kent where the soil is suitable. In very old hop gardens, where there has been no change of plant for fifty or even one hundred years in some instances, except from the gradual process of filling up the places of plants that have died, there has been replanting with better varieties and varieties ripening in more convenient succession; and, generally speaking, the plantations have been levelled up in this respect to suit the demand for bright hops of fine quality. A recent classification² of the varieties of English hops arranges them in three groups: (1) early varieties (e.g. Prolific, Bramling, Amos's Early Bird); (2) mid-season or main-crop varieties (e.g. Farnham Whitebine, Fuggle's, Old Jones's, Golding); (3) late varieties (e.g. Grapes, Colegate's).

The cost of cultivating and preparing the produce of an acre of hop land tends to increase, on account of the advancing rates of wages, the intense cultivation more and more essential, and the necessity of freeing the plants from the persistent attacks of insects and fungi. In 1893 Mr Whitehead estimated the average annual cost of an acre of hop land to be £35, 10s., the following being the items:—

Manure (winter and summer)	£6 10 0
Digging	0 19 0
Dressing (or cutting)	0 6 0
Poling, tying, earthing, ladder-tying, stringing, lewling	2 3 0
Shimming, nidgiting, digging round and hoeing hills	3 0 0
Stacking, stripping, making bines, &c.	0 17 0
Annual renewal of poles	2 10 0
Expense of picking, drying, packing, carriage, sampling, selling, &c., on average crop of, say, 7 cwt. per acre	10 5 0
Rent, rates, taxes, repairs of oast and tacks, interest on capital	6 0 0
Sulphuring	1 0 0
Washing (often two, three or four times)	2 0 0
Total	£35 10 0

Seven years later the average cost per acre in Kent had risen to quite £37.

² J. Percival, "The Hop and its English Varieties." Jour. Roy. Agric. Soc., 1901.

The hops in Kent are usually planted in October or November, the plants being 6 ft. apart each way, thus giving 120 hills or plant-centres per acre. Some planters still grow potatoes or mangels between the rows the first year, as the plants do not bear much until the second year; but this is considered to be a mistake, as it encourages wire-worm and exhausts the ground. Many planters pole hop plants the first year with a single short pole, and stretch coco-nut-fibre string from pole to pole, and grow many hops in the first season. Much of the hop land is ploughed between the rows, as labour is scarce, and the spaces between are dug afterwards. It is far better to dig hop land if possible, the tool used being the Kent spud. The cost of digging an acre ranges from 18s. to 21s. Hop land is ploughed or dug between November and March. After this the plants are "dressed," which means that all the old bine ends are cut off with a sharp curved hop-knife, and the plant centres kept level with the ground.

Manuring.—Manure is applied in the winter, and dug or ploughed in. London manure from stables is used to an enormous extent. It comes by barge or rail, and is brought from the wharves and stations by traction engines; it costs from 7s. 6d. to 9s. per load. Rags, fur waste, sprats, wool waste and shoddy are also put on in the winter. In the summer, rape dust, guano, nitrate of soda and various patent hop manures are chopped in with the Canterbury hoe. Fish guano or desiccated fish is largely used; it is very stimulating and more lasting than some of the other forcing manures.

The recent investigations into the subject of hop-manuring made by Dr Bernard Dyer and Mr F. W. E. Shrivell, at Golden Green, near Tonbridge, Kent, are of interest. In the 1901 report¹ it was stated that the object in view was to ascertain how far nitrate of soda, in the presence of an abundant supply of phosphates and potash, is capable of being advantageously used as a source of nitrogenous food for hops. An idea long persisted among hop-growers that nitrate of soda was an unsafe manure for hops, being likely to produce rank growth of bine at the expense of quality and even quantity of hops. During recent years, however, owing very largely to the results of

Weight of Kilm-dried Fuggle's Hops per Acre.

Plot.	Annual Manuring per Acre.	1896	1897	1898	1899	1900	Average of 5 Years.
		Cwt. 13½	Cwt. 7½	Cwt. 8½	Cwt. 20½	Cwt. 8	
A	Phosphates and potash .	16½	9½	10½	22½	9½	13½
B	Phosphates, potash and 2 cwt. nitrate of soda .	16½	12	12½	23	11	15
C	Phosphates, potash and 4 cwt. nitrate of soda .	15½	13	13	22½	10½	14½
D	Phosphates, potash and 6 cwt. nitrate of soda .	15	13½	15½	23½	11	15½
E	Phosphates, potash and 8 cwt. nitrate of soda .	15	13	15	24½	10½	15½
F	Phosphates, potash and 10 cwt. nitrate of soda .	13	8	9½	24½	10½	13½
X	30 loads (about 15 tons) London dung						

In only one year did the very large dressing of 10 cwt. of nitrate of soda per acre afford any better result than was produced by the less heavy dressing of 8 cwt. per acre, and this was in 1899, a season of such abundance and such low prices that it may be regarded as an abnormal season. If the effect of this one season on the average be eliminated, the best results, as regards quantity, were obtained on plot E, receiving 8 cwt. of nitrate of soda per acre. But plot C, with 4 cwt. only of nitrate of soda per acre, has been on the average not more than ¼ cwt. per acre behind plot E.

Valuations of the hops made by merchants and factors show that, on the whole, the market quality of the produce is very little affected by manuring. Moreover, chemical investigation of the hops appears to indicate that the brewing quality is not in any constant or definite way influenced by the manuring, except where the quantity of nitrate of soda has amounted to the large dressing of 8 cwt. or more per acre, a quantity which in some seasons would seem to have been prejudicial, although in one season it happened that the highest brewing value appertained to a sample grown with as much as 10 cwt. per acre.

The results of modern investigation show that it is very largely to the presence and proportion of soft resin that hops owe their preservative value, although the quality of hops is by no means wholly dependent on this one feature. The resin percentages on the samples grown on the several plots in 1898, 1899 and 1900 were the following:—

Plot.	Annual Manuring per Acre.	1898		1899		1900	
		Total Resin.	Soft Resin.	Total Resin.	Soft Resin.	Total Resin.	Soft Resin.
A	Phosphates and potash	Per Cent. 14.15	9.21	Per Cent. 15.07	8.60	Per Cent. 14.53	8.90
B	Phosphates, potash and 2 cwt. nitrate of soda	14.39	9.20	16.59	8.83	15.09	8.51
C	Phosphates, potash and 4 cwt. nitrate of soda	14.06	9.04	15.87	9.27	14.48	8.16
D	Phosphates, potash and 6 cwt. nitrate of soda	13.57	8.60	14.90	8.70	13.76	7.62
E	Phosphates, potash and 8 cwt. nitrate of soda	14.11	8.85	14.49	8.96	13.30	7.18
F	Phosphates, potash and 10 cwt. nitrate of soda	12.21	7.91	15.47	9.41	12.77	6.77
X	30 loads (about 15 tons) London dung	13.93	8.66	14.92	8.80	14.78	9.07

these experiments, and of corresponding experiments based upon these, which have been carried out abroad, hop farmers have much more freely availed themselves of the aid of this useful manure; and there is little doubt that the distrust of nitrate of soda as a hop manure which has existed in the past has been largely due to the fact that nitrate of soda, like many other nitrogenous manures, has often been misused (1) by being applied without a sufficient quantity of phosphates and potash, or (2) by being applied too abundantly, or (3) by being applied too late in the season, with the result of unduly delaying the ripening period. On most of the experimental plots nitrate of soda (in conjunction with phosphates and potash) has been used as the sole source of nitrogen; but it is, of course, not to be supposed that any hop-grower would use year after year, as is the case on some of the plots, nothing but phosphates, potash and nitrate of soda. Miscellaneous feeding is probably good for plants as well as for animals, and there is a large variety of nitrogenous manures at the disposal of the hop-farmer, to say nothing of what, in its place, is one of the most valuable of all manures, namely, home-made dung. These experiments were begun in 1894 with a new garden of young Fuggle's hops. A series of experimental plots was marked out, each plot being one-sixth of an acre in area. The plots run parallel with one another, there being four rows of hills in each. The climate of the district is very dry.

The table given above shows the annual yield of hops per acre on each plot, and also the average for each plot over the five years 1896-1900.

¹ Six Years' Experiments on Hop Manuring (London, 1901).

The general results seem to show that the purchase of town dung for hops is not economical, unless under specially favourable terms as to cost of conveyance, and that it should certainly not be relied upon as a sufficient manure. Home-made dung is in quite a different position, as not only is it richer, but it costs nothing for railway carriage. As a source of nitrogenous manure, purchased dung is on the whole too expensive. There is a large variety of other nitrogenous manures in the market besides nitrate of soda, such as for instance as Peruvian and Damaland guano, sulphate of ammonia, fish guano, dried blood, rape dust, furriers' refuse, horn shavings, hoof parings, wool dust, shoddy, &c. All of these may in turn be used for helping to maintain a stock of nitrogen in the soil; and the degree to which manures of this kind have been recently applied in any hop garden will influence the grower in deciding as to the quantity of nitrate of soda he should use in conjunction with them, and also to some extent in fixing the date of its application.

Dressings of 8 or 10 cwt. of nitrate of soda per acre, such as are applied annually to plots E and F, would be larger than would be put on where the land has been already dressed with dung or with other nitrogenous manures; and even, in the circumstances under notice, although these plots have on the average beaten the others in weight, the hops in some seasons have been distinctly coarser than those more moderately manured—though in the dry season of 1899 the most heavily dressed plot gave actually the best quality as well as the greatest quantity of produce.

With regard to the application of nitrate of soda in case the season should turn out to be wet, present experience indicates that, on a soil otherwise liberally manured, 4 cwt. of nitrate of soda per acre

applied not too late, would be a thoroughly safe dressing. In the case of neither dung nor any other nitrogenous fertilizers having been recently applied, there seems no reason for supposing that, even in a wet season, 6 cwt. of nitrate of soda per acre applied early would be otherwise than a safe dressing, considering both quantity and quality of produce. In conjunction with dung, or with the early use of other nitrogenous manures, such as fish, guano, rape dust, &c. it would probably be wise not to exceed 4 cwt. of nitrate of soda per acre.

As to the date of application, April or May is the latest time at which nitrate of soda should, in most circumstances, be applied, and probably April is preferable to May. The quantity used should be applied in separate dressings of not more than 2 cwt. per acre each, put on at intervals of a month. Where the quantity of nitrate of soda used is large, and constitutes the whole of the nitrogenous manure employed, the first dressing may, on fairly deep and retentive soils, be given as early as January; or, if the quantity used is smaller, say in February; while February will, in most cases, probably be early enough for the first dressing in the case of lighter soils. The condition of the soil and the degree and distribution of rainfall during both the previous autumn and the winter, as well as in the spring itself, produce such varying conditions that it is almost impossible to frame general rules.

The commonly accepted notion that nitrate of soda is a manure which should be reserved for use during the later period of the growth of the bine appears to be erroneous. The summer months, when the growth of the bine is most active, are the months in which natural nitrification is going on in the soil, converting soil nitrogen and the nitrogen of dung, guano, fish, rape dust, shoddy or other fertilizers into nitrates, and placing this nitrogen at the disposal of the plants; and it appears reasonable, therefore, to suppose that nitrate of soda will be most useful to the hops at the earlier stages of their growth, before the products of that nitrification become abundant. This would especially be so in a season immediately following a wet autumn and winter, which have the effect of washing away into the drains the residual nitrates not utilized by the previous crop.

The necessity, whether dung is used or not, and whatever form of nitrogenous manure is employed, of also supplying the hops with an abundance of phosphates, cannot be too strongly urged. The use of phosphates for hops was long neglected by hop-planters, and even now there are many growers who do not realize the full importance of heavy phosphatic manuring. On soils containing an abundance of lime no better or cheaper phosphatic manure can be used than ordinary superphosphate, of which as much as 10 cwt. per acre may be applied without the slightest fear of harm. But if the soil is not decidedly calcareous—that is to say, if it does not effervesce when it is stirred up with some diluted hydrochloric (muriatic) acid—bone dust, phosphatic guano or basic slag should be used as a source of phosphates, at the rate of not less than 10 cwt. per acre. On medium soils, which, without being distinctly calcareous, nevertheless contain a just appreciable quantity of carbonate of lime, it is probably a good plan to use the latter class of manures, alternately with superphosphate, year and year about; but it is wise policy to use phosphates in *some form or other* every year in every hop garden. They are inexpensive, and without them neither dung, nitrate of soda, ammonia salts nor organic manures can be expected to produce both a full vigorous growth of bine and at the same time a well-matured crop of full-weighted, well-conditioned hops.

The use of potash salts, on most soils, is probably not needed when good dung is freely used; but where this is not the case it is safer in most seasons and on most soils to give a dressing of potash salts. On some soils their aid should on no account be dispensed with.

Experiments in hop-manuring have also been conducted in connexion with the South-Eastern Agricultural College, Wye, Kent. The main results have been to demonstrate the necessity of a liberal supply of phosphates, if the full benefit is to be reaped from applications of nitrogenous manure.

Tying, Poling and Picking.—Tying the bines to the poles or strings is essentially women's work. It was formerly always piecework, each woman taking so many acres to tie, but it is found better to pay the women 1s. 8d. to 2s. per day, that they may all work together, and tie the plants in those grounds where they want tying at once. The new modes of poling and training hop plants have also altered the conditions of tying.

Many improvements have been made in the methods of poling and training hops. Formerly two or three poles were placed to each hop-hill or plant-centre in the spring, and removed in the winter, and this was the only mode of training. Recently systems of training on wires and strings fastened to permanent upright poles have been introduced. One arrangement of wires and strings much adopted consists of stout posts set at the end of every row of hop-hills and fastened with stays to keep them in place. At intervals in each row a thick pole is fixed. From post to post in the rows a wire is stretched at a height of $\frac{1}{2}$ ft. from the ground, another about 6 ft. from the ground, and another

along the tops of the posts, so that there are three wires. Hooks are clipped on these wires at regular intervals, and coco-nut-fibre strings are threaded on them and fastened from wire to wire, and from post to post, to receive the hop bines. The string is threaded on the hooks continuously, and is put on those of the top wire with a machine called a stringer. There are several methods of training hops with posts or stout poles, wire and string, whose first cost varies from £20 to £40 per acre. The system is cheaper in the long run than that of taking down the poles every year, and the wind does not blow down the poles or injure the hops by banging the poles together. In another method, extensively made use of in Kent and Sussex, stout posts are placed at the ends of each row of plants, and, at intervals where requisite, wires are fastened from top to top only of these posts, whilst coco-nut-fibre strings are fixed by pegs to the ground, close to each hop-stock, whence they radiate upwards for attachment to the wires stretching between the tops of the posts. This method is more simple and less expensive than the system first described, its cost being from £24 to £28 per acre. In this case the plants require to be well "lewed," or sheltered, as the strings being so light are blown about by the wind. These methods are being largely adopted, and, together with the practice of putting coco-nut-fibre strings from pole to pole in grounds poled in the old-fashioned manner, are important improvements in hop culture, which have tended to increase the production of hops. Where the old system of poling with two or three poles is still adhered to they are always cresooted, most growers having tanks for the purpose; and, in the new methods of poling, the posts and poles are cresooted, dipped or kyanized.

At Wye College, Kent, different systems of planting and training have been tried, the alleys varying in width from 10 ft. down to 5 ft., and the distance between the hills varying quite as widely, so that the number of hills to the acre has ranged from 120 down to 660. The biggest crop was secured on the plot where hills were 8 ft. apart each way. As a rule, indeed, a wide alley and abundant space between the plants, thus allowing the hops plenty of air and light, produced the best results, besides effecting some saving in the cost of cultivation, as there were only 660 or 680 hills per acre. Of the various methods of training, the umbrella system gave the biggest crop in each of the three years, 1899, 1900, 1901; and it seemed to be the best method, except in seasons when washing was required early, in which case the plants were not so readily cleared of vermin.

Much attention is required to keep the bines in their places on the poles, strings or wire, during the summer. This gives employment to many women, for whose service in this and fruit-picking there is considerable demand, and a woman has no trouble in earning from 1s. 6d. to 1s. 10d. per day from April till September at pleasant and not very arduous labour. The hop-picking follows, and at this women sometimes get 4s. and even 5s. per day. This is the real Kent harvest, which formerly lasted a month or five weeks. Now it rarely extends beyond eighteen days, as it is important to secure the hops before the weather and the aphides, which almost invariably swarm within the bracts of the cones, discolour them and spoil their sale, as brewers insist upon having bright, "coloury" hops. Picking is better done than was formerly the case. The hops are picked more singly, and with comparatively few leaves, and the pickers are of a somewhat better type than the rough hordes who formerly went into Kent for "hopping." Kent planters engage their pickers beforehand, and write to them, arranging the numbers required and the date of picking. Many families go into Kent for pea- and fruit-picking and remain for hop-picking. Without this great immigration of persons, variously estimated at between 45,000 and 65,000, the crops of hops could not be picked; and fruit-farmers also would be unable to get their soft fruit gathered in time without the help of immigrant hands. The fruit-growers and hop-planters of Kent have greatly improved the accommodation for these immigrants.

Concerning the general question as to the advisability or otherwise of cutting the hop bine at the time of picking, A.D.

Hall has ascertained experimentally that if the bine is cut close to the ground at a time when the whole plant is unripe there are removed in the bine and leaves considerable quantities of nitrogen, potash and phosphoric acid which would have returned to the roots if the bine had not been cut until ripe. The plant, therefore, would retain a substantial store of these constituents for the following year's growth if the bine were left. Chemical analyses have shown that about 30 lb of nitrogen per acre may be saved by allowing the bines to remain uncut, this representing practically one-third of the total amount of nitrogen in the hops, leaf and bine together. There are also from 25 lb to 30 lb of potash in the growth, of which nine-tenths would return to the roots, with about half the phosphoric acid and a very small proportion of the lime. It has been demonstrated that by the practice of cutting the bines when the hops are picked the succeeding crop is lessened to the extent of about one-tenth. As to stripping off the leaves and lower branches of the plant, it was found that this operation once reduced the crop 10% and once 20%, but that in the year 1899 it did not affect the crop at all. The inference appears to be that when there is a good crop it is not reduced by stripping, but that when there is less vigour in the plant it suffers the more. Hence, it would seem advisable to study the plant itself in connexion with this matter, and to strip a little later, or somewhat less, than usual when the bine is not healthy.

Drying.—After being picked, the hops are taken in pokes—long sacks holding ten bushels—to the oasts to be dried. The oasts are circular or square kilns, or groups of kilns, wherein the green hops are laid upon floors covered with horsehair, under which are enclosed or open stoves or furnaces. The heat from these is evenly distributed among the hops above by draughts below and round them. This is the usual simple arrangement, but patent processes are adopted here and there, though they are by no means general. The hops are from nine to ten hours drying, after which they are taken off the kiln and allowed to cool somewhat, and are then packed tightly into "pockets" 6 ft. long and 2 ft. wide, weighing 1½ cwt., by means of a hop-pressing machine, which has cogs and wheels worked by hand. Of late years more care has been bestowed by some of the leading growers upon the drying of hops, so as to preserve their qualities and volatilities, and to meet the altered requirements of brewers, who must have bright, well-managed hops for the production of light clear beers for quick draught. The use, for example, of exhaust fans, recently introduced, greatly facilitates drying by drawing a large volume of air through the hops; and as the temperature may at the same time be kept low, the risk of getting over-fired samples is considerably reduced, though not entirely obviated. The adoption of the roller floor is another great advance in the process of hop-drying, for this, used in conjunction with a raised platform for the men to stand on when turning, prevents any damage from the feet of the workmen, and reduces the loss of resin to a minimum. The best results are obtained when exhaust fans and the roller floor are associated together. In such cases the roller floor, which empties its load automatically, pours the hop cones into the receiving sheets in usually as whole and unbroken a condition as that in which they went on to the kiln.

Pests of the Hop Crop.—In recent years the difficulties attendant upon hop cultivation have been aggravated, and the expenses increased, by regularly recurring attacks of aphid blight—due to the insect *Aphis (Phorodon) humuli*—which render it necessary to spray or syringe every hop plant, every branch and leaf, with insecticidal solutions three or four times, and sometimes more often, in each season. Quassia and soft-soap solutions are usually employed; they contain from 4 lb to 8 lb of soft soap, and the extract of from 8 lb to 10 lb of quassia chips to 100 gallons of water. The soft soap serves as a vehicle to retain the bitterness of the quassia upon the bines and leaves, making them repulsive to the aphides, which are thus starved out. Another pest, the red spider, *Tetranychus telarius*—really one of the "spinning mites"—is most destructive in very hot summers. Congregating on the under surfaces of the leaves, the red spiders exhaust the sap and cause the leaves to fall, producing the effect known in Germany as "fire-blast." The hop-wash of soft soap and quassia, so effective against aphid attack, is of little avail

in the case of red spider. Some success, however, has attended the use of a solution containing 8 lb to 10 lb of soft soap to 100 gallons of water, with three pints of paraffin added. It is necessary to apply the washes with great force, in order to break through the webs with which the spiders protect themselves. Hop-washing is done by means of large garden engines worked by hand, but more frequently with horse engines. Resort is sometimes had to steam engines, which force the spraying solution along pipes laid between the rows of hops.

Mould or mildew is frequently the source of much loss to hop-planters. It is due to the action of the fungus *Podosphaera castagnei*, and the mischief is more especially that done to the cones. The only trustworthy remedy is sulphur, employed usually in the form of flowers of sulphur, from 40 lb to 60 lb per acre being applied at each sulphuring. The powder is distributed by means of a machine drawn by a horse between the rows. The sulphur is fed from a hopper into a blast-pipe, whence it is driven by a fan actuated by the travelling wheels, and falls as a dense, wide-spreading cloud upon the hop-bines. The first sulphuring takes place when the plants are fairly up the poles, and is repeated three or four weeks later; and even again if indications of mildew are present. It may be added that sulphur is also successfully employed in the form of an alkaline sulphide, such as solution of "liver of sulphur," a variety of potassium sulphide. (W. Fr.)

HOPE, ANTHONY, the pen-name of ANTHONY HOPKINSON (1863—), British novelist, who was born on the 9th of February 1863, the second son of the Rev. E. C. Hawkins, Vicar of St Bride's, Fleet Street, London. He was educated at Marlborough and Balliol College, Oxford, where he was president of the Union Society, and graduated with first classes in Moderations and Final Schools. He was called to the bar at the Middle Temple in 1877. He soon began contributing stories and sketches to the *St James's Gazette*, and in 1890 published his first novel, *A Man of Mark*. This was followed by *Father Stafford* (1891), *Mr Witt's Widow* (1892), *Change of Air and Sport Royal and Other Stories* (1893). By this time he had attracted by his vivacious talent the attention of editors and readers; but it was not till the following year that he attained a great popular success with the publication (May 1894) of *The Prisoner of Zenda*. This was followed a few weeks later by *The Dolly Dialogues* (previously published in separate instalments in the *Westminster Gazette*). Both books became parents of a numerous progeny. *The Prisoner of Zenda*, owing something to the *Prince Otto* of R. L. Stevenson, established a fashion for what was christened, after its fictitious locality, "Ruritanian romance"; while the *Dolly Dialogues*, inspired possibly by "Gyp" and other French dialogue writers, was the forerunner of a whole school of epigrammatic drawing-room comedy. *The Prisoner of Zenda*, with Mr Alexander as "Rupert Rassendyll," enjoyed a further success in a dramatized form at the St James's Theatre, which did still more to popularize the author's fame. In 1894 also appeared *The God in the Car*, a novel suggested by the ambiguous influence on English society of Cecil Rhodes's career; and *Half a Hero*, a complementary study of Australian politics. The same year saw further the publication of *The Indiscretion of the Duchess*, in the style of the *Dolly Dialogues*, and of another collection of stories named (after the first) *The Secret of Wardale Court*. In 1895 Mr Hawkins published *Count Antonio*, and contributed to *Dialogues of the Day*, edited by Mr Oswald Crawford. *Comedies of Courtship* and *The Heart of the Princess Osra* followed in 1896; *Phroso* in 1897; *Simon Dale* and *Rupert of Hentzau* (sequel of the *Prisoner of Zenda*) 1898; and *The King's Mirror*, a Ruritanian romance with an infusion of serious psychological interest, 1899. The author was advancing from his light comedy and gallant romantic inventions to the graver kind of fiction of which *The God in the Car* had been an earlier essay. *Quisante*, published in 1900, was a study of English society face to face with a political genius of an alien type. *Tristram of Blent* (1901) embodied an ethical study of family pride. *The Intrusions of Peggy* reflected the effects on society of recent financial fashions. In 1904 he published *Double Harness*, and in 1905 *A Servant of the Public*, two novels of modern society, containing somewhat cynical pictures of the condition of marriage. With increasing gravity the novelist sacrificed some of the charm of his earlier irresponsible gaiety and buoyancy; but his art retained its wit and urbanity while

It gained in grip the social conditions of contemporary life. He wrote two plays, *The Adventure of Lady Ursula* (1808) and *Pilkerton's Peerage* (1902), and his later novels include *The Great Miss Driver* (1908) and *Second String* (1909). Mr Hawkins's attractive and cultured style and command of plot give him a high place among the modern writers of English fiction. In 1903 he married Miss Elizabeth Somerville Sheldon of New York.

HOPE, THOMAS (c. 1770-1831), English art-collector, and author of *Anastasis*, born in London about 1770, was the eldest son of John Hope of Amsterdam, and was descended from a branch of an old Scottish family who for several generations were extensive merchants in London and Amsterdam. About the age of eighteen he started on a tour through various parts of Europe, Asia and Africa, where he interested himself especially in architecture and sculpture, making a large collection of the principal objects which attracted his attention. On his return to London about 1796 he purchased a house in Duchess Street, Cavendish Square, which he fitted up in a very elaborate style, from drawings made by himself. In 1807 he published sketches of his furniture, accompanied by letterpress, in a folio volume, entitled *Household Furniture and Interior Decoration*, which had considerable influence in effecting a change in the upholstery and interior decoration of houses, notwithstanding that Byron had referred scornfully to him as "House-furnisher withal, one Thomas high." Hope's furniture designs were in that pseudo-classical manner which is generally called "English Empire." It was sometimes extravagant, and often heavy, but was much more restrained than the wilder and later flights of Sheraton in this style. At the best, however, it was a not very inspiring mixture of Egyptian and Roman motives. In 1809 he published the *Costumes of the Ancients*, and in 1812 *Designs of Modern Costumes*, works which display a large amount of antiquarian research. He was also, as his father had been—the elder Hope's country house near Haarlem was crowded with fine pictures—a magnificent patron of the highest forms of art, and both at his London house and his country seat at Deepdene near Dorking he formed large collections of paintings, sculpture and antiques. Deepdene in his day became a famous resort of men of letters as well as of people of fashion, and among the luxuries suggested by his fine taste was a miniature library in several languages in each bedroom. Thorvaldsen, the Danish sculptor, was indebted to him for the early recognition of his talents, and he also gave frequent employment to Chantrey and Flaxman—it was to his order that the latter illustrated Dante. In 1819 he published anonymously his novel *Anastasis, or Memoirs of a Modern Greek, written at the close of the 18th century*, a work which, chiefly on account of the novel character of its subject, caused a great sensation. It was at first generally attributed to Lord Byron, who told Lady Blessington that he wept bitterly on reading it because he had not written it and Hope had. But, though remarkable for the acquaintance it displays with Eastern life, and distinguished by considerable imaginative vigour and much graphic and picturesque description, its paradoxes are not so striking as those of Lord Byron; and, notwithstanding some eloquent and forcible passages, the only reason which warranted its ascription to him was the general type of character to which its hero belonged. Hope died on the 3rd of February 1831. He was the author of two works published posthumously—the *Origin and Prospects of Man* (1831), in which his speculations diverged widely from the usual orthodox opinions, and an *Historical Essay on Architecture* (1835), an elaborate description of the architecture of the middle ages, illustrated by drawings made by himself in Italy and Germany. He is commonly known in literature as "Anastasis" Hope. He married (1806) Louisa de la Poer Beresford, daughter of Lord Decies, archbishop of Tuam.

HOPEDALE, a township of Worcester county, Massachusetts, U.S.A.; pop. (1905; state census) 2048; (1910) 2188. It is served by the Milford & Uxbridge (electric) street railway, and (for freight) by the Grafton & Upton railway. The town lies in the "dale" between Milford and Mendon, and is cut from N.W. to S.E. by the Mill river, which furnishes good water

power at its falls. The principal manufactures are textiles, boots and shoes, and, of most importance, cotton machinery. The great cotton machinery factories here are owned by the Draper Company. Hopedale has a public park on the site of the Ballou homestead, with a bronze statue of Adin Ballou; a memorial church erected by George A. and Eben S. Draper; the Bancroft Memorial Library, given by Joseph B. Bancroft in memory of his wife; and a marble drinking fountain with statuary by Waldo Story, the gift of Susan Preston Draper, General W. F. Draper's wife. The village is remarkable for the comfortable cottages of the workers.

The history of Hopedale centres round the Rev. Adin Ballou (1803-1890), a distant relative of Hosea Ballou;¹ he left, in succession, the ministry of the Christian Connexion (1823) and that of the Universalist Church (1831), because of his restorationist views. In 1831 he became pastor of an independent church in Mendon. An ardent exponent of temperance, the anti-slavery movement, woman's rights, the peace cause and Christian non-resistance (even through the Civil War), and of "Practical Christian Socialism," it was in the interests of the last cause that he founded Hopedale, or "Fraternal Community No. 1," in Milford, in April 1842, the first compact of the community having been drawn up in January 1841. Thirty persons joined with him, and lived in a single house on a poor farm of 258 acres, purchased in June 1841. Ballou was for several years the president of the community, which was run on the plan that all should have an equal voice as to the use of property, in spite of the fact that there was individual holding of property. The community, however, owned the instruments of production, with the single exception of the important patent rights held by Ebenezer D. Draper. The result was bickering between those who were joint stockholders and those whose only profit came from their manual labour. In a short time the control of the community came into the hands of its richest members, E. D. Draper and his brother, George Draper (1817-1887), who owned three-fourths of the joint stock. In 1856 there was a total deficit of about \$12,000. The Draper brothers bought up the joint stock of the community at par and paid its debts, and the community soon ceased to exist save as a religious society. After George Draper's death the control of the mills passed to his sons. These included General William Franklin Draper (1842-1910), a Republican representative in Congress in 1892-1897 and U.S. ambassador to Italy in 1897-1900, and Eben Sumner Draper (b. 1858), lieutenant-governor of Massachusetts in 1906-1908 and governor in 1909-1911. In 1867 the community was merged with Hopedale parish, a Unitarian organization. Hopedale was separated from Milford and incorporated as a township in 1886.

See Adin Ballou's *History of Milford* (Boston, 1882), his *History of the Hopedale Community*, edited by William S. Heywood (Lowell, 1897), his *Biography* by the same editor (Lowell, 1896) and his *Practical and Christian Socialism* (Hopedale, 1854); George L. Carey, "Adin Ballou and the Hopedale Community" (in the *New World*, vol. vii., 1898); Lewis G. Wilson, "Hopedale and Its Founder" (in *The New England Magazine*, vol. x., 1891); and William F. Draper, *Recollections of a Varied Career* (Boston, 1908).

HOPE-SCOTT, JAMES ROBERT (1812-1873), English barrister and Tractarian, was born on the 15th of July 1812, at Great Marlow, Berkshire, the third son of Sir Alexander Hope, and grandson of the second earl of Hopetoun. He was educated at Eton and Oxford, where he was a contemporary and friend of Gladstone and J. H. Newman, and in 1838 was called to the bar. Between 1840 and 1843 he helped to found Trinity College, Glenalmond. He was one of the leaders of the Tractarian movement and entirely in Newman's confidence. In 1851 he was received with Manning into the Roman Catholic church. At this time he was making a very large income at the Parliamentary bar. He only commenced serious practice in this branch of his profession in 1843, but by the end of 1845 he stood at the head of it and in 1849 was made a Queen's Counsel. In 1847 he married Miss Lockhart, granddaughter of Sir Walter Scott, and on her coming into possession of Abbotsford six years later,

¹ Adin Ballou wrote *An Elaborate History and Genealogy of the Ballous in America* (Providence, R.I., 1888)

assumed the surname of Hope-Scott. He retired from the bar in 1870 and died on the 29th of April 1873.

HOPFEN, HANS VON (1835-1904), German poet and novelist, was born on the 3rd of January 1835, at Munich. He studied law, and in 1858, having shown marked poetical promise, he was received into the circle of young poets whom King Maximilian II. had gathered round him, and thereafter devoted himself to literature. In 1862 he made his debut as an author, with *Lieder und Balladen*, which were published in the *Münchener Dichterbuch*, edited by E. Geibel. After travelling in Italy (1862), France (1863) and Austria (1864), he was appointed, in 1865, general secretary of the "Schillerstiftung," and in this capacity settled at Vienna. The following year, however, he removed to Berlin, in a suburb of which, Lichtenfelde, he died on the 19th of November 1904. Of Hopfen's lyric poems, *Gedichte* (4th ed., Berlin, 1883), many are of considerable talent and originality; but it is as a novelist that he is best known. The novels *Peregretia* (1864); *Verdorben zu Paris* (1868, new ed. 1892); *Arge Sitten* (1866); *Der graue Freund* (1874, 2nd ed., 1876); and *Verfälschte Liebe* (1876, 2nd ed., 1879) are attractive, while of his shorter stories *Tiroler Geschichten* (1884-1885) command most favour.

An autobiographical sketch of Hopfen is contained in K. E. Franzos, *Geschichte des Erstlingswerkes* (1904).

HOPÍ, or MOKÍ (Moquis), a tribe of North American Indians of Shoshonean stock. They are Pueblo or town-building Indians and occupy seven villages on three lofty plateaus of northern Arizona. The first accounts of them date from the expedition of Francisco Vasquez de Coronado in 1540. With the town-building Indians of New Mexico they were then subdued. They shared in the successful revolt of 1542, but again suffered defeat in 1586. In 1680, however, they made a successful revolt against the Spaniards. They weave very fine blankets, make baskets and are expert potters and wood-carvers. Their houses are built of stone set in mortar. Their ceremonies are of an elaborate nature, and in the famous "snake-dance" the performers carry live rattlesnakes in their mouths. They number some 1600. (See also PUEBLO INDIANS.)

For Hopí festivals, see *21st Ann. Report Bureau of Amer. Ethnology* (1899-1900).

HÖPKEN, ANDERS JOHAN, COUNT VON (1712-1789), Swedish statesman, was the son of Daniel Niklas Höpken, one of Arvid Horn's most determined opponents and a founder of the Hat party. When in 1738 the Hats came into power the younger Höpken obtained a seat in the secret committee of the diet, and during the Finnish war of 1741-42 was one of the two commissioners appointed to negotiate with Russia. During the diet of 1746-1747 Höpken's influence was of the greatest importance. It was chiefly through his efforts that the estates issued a "national declaration" protesting against the arrogant attitude of the Russian ambassador, who attempted to dominate the crown prince Adolphus Frederick and the government. This spirited policy restored the waning prestige of the Hat party and firmly established their anti-Muscovite system. In 1746 Höpken was created a senator. In 1751 he succeeded Gustaf Tessin as prime minister, and controlled the foreign policy of Sweden for the next nine years. On the outbreak of the Seven Years' War, he contracted an armed neutrality treaty with Denmark (1756); but in the following year acceded to the league against Frederick II. of Prussia. During the crisis of 1760-1762, when the Hats were at last compelled to give an account of their stewardship, Höpken was sacrificed to party exigencies and retired from the senate as well as from the premiership. On the 22nd of June 1762, however, he was created a count. After the revolution of 1772 he re-entered the senate at the particular request of Gustavus III., but no longer exercised any political influence. His caustic criticism of many of the royal measures, moreover, gave great offence, and in 1780 he retired into private life. Höpken was a distinguished author. The noble style of his biographies and orations has earned for him the title of the Swedish Tacitus. He helped to found the *Vetenskaps Akademi*, and when Gustavus III. in 1786

established the Swedish Academy, he gave Höpken the first place in it.

See L. G. de Geer, *Minne af Grefve A. J. von Höpken* (Stockholm, 1882); Carl Silfverstolpe, *Grefve Höpkens Skrifter* (Stockholm, 1890-1893).

HOPKINS, EDWARD WASHBURN (1857-), American Sanskrit scholar, was born in Northampton, Massachusetts, on the 8th of September 1857. He graduated at Columbia University in 1878, studied at Leipzig, where he received the degree of Ph.D. in 1881, was an instructor at Columbia in 1881-1885, and professor at Bryn Mawr in 1885-1895, and became professor of Sanskrit and comparative philology in Yale University in 1895. He became secretary of the American Oriental Society and editor of its *Journal*, to which he contributed many valuable papers, especially on numerical and temporal categories in early Sanskrit literature. He wrote *Caste in Ancient India* (1881); *Manu's Lawbook* (1884); *Religions of India* (1895); *The Great Epic of India* (1901); and *India Old and New* (1901).

HOPKINS, ESEK (1718-1802), the first admiral of the United States navy, was born at Scituate, Rhode Island, in 1718. He belonged to one of the most prominent Puritan families of New England. At the age of twenty he went to sea, and rapidly came to the front as a good sailor and skilful trader. Marrying, three years later, into a prosperous family of Newport, and thus increasing his influence in Rhode Island, he became commodore of a fleet of seventeen merchantmen, the movements of which he directed with skill and energy. In war as well as peace, Hopkins was establishing his reputation as one of the leading colonial seamen, for as captain of a privateer he made more than one brilliant and successful venture during the Seven Years' War. In the interval between voyages, moreover, he was engaged in Rhode Island politics, and rendered efficient support to his brother Stephen against the Ward faction. At the outbreak of the War of Independence, Hopkins was appointed brigadier-general by Rhode Island, was commissioned, December 1775, by the Continental Congress, commander-in-chief of the navy, and in January 1776 hoisted his flag as admiral of the eight converted merchantmen which then constituted the navy of the United States. His first cruise resulted in a great acquisition of material of war and an indecisive fight with H.M.S. "Glasgow." At first this created great enthusiasm, but criticism soon made itself heard. Hopkins and two of his captains were tried for breach of orders, and, though ably defended by John Adams, were censured by Congress. The commands, nevertheless, were not interfered with, and a prize was soon afterwards named after the admiral by their orders. But the difficulties and mutual distrust continually increased, and in 1777 Congress summarily dismissed Hopkins from his command, on the complaint of some of his officers. Before the order arrived, the admiral had detected the conspiracy against him, and had had the ringleaders tried and degraded by court-martial. But the Congress followed up its order by dismissing him from the navy. For the rest of his life he lived in Rhode Island, playing a prominent part in state politics, and he died at Providence in 1802.

See Edward Field, *Life of Esek Hopkins* (Providence, 1898); also an article by R. Grieve in the *New England Magazine* of November 1897.

HOPKINS, MARK (1802-1887), American educationist, great-nephew of the theologian Samuel Hopkins, was born in Stockbridge, Massachusetts, on the 4th of February 1802. He graduated in 1824 at Williams College, where he was a tutor in 1825-1827, and where in 1830, after having graduated in the previous year at the Berkshire Medical College at Pittsfield, he became professor of Moral Philosophy and Rhetoric. In 1833 he was licensed to preach in Congregational churches. He was president of Williams College from 1836 until 1872. He was one of the ablest and most successful of the old type of college president. His volume of lectures on *Evidences of Christianity* (1846) was long a favourite text-book. Of his other writings, the chief were *Lectures on Moral Science* (1862), *The Law of Love and Love as a Law* (1869), *An Outline Study of Man*

(1873), *The Scriptural Idea of Man* (1883), and *Teachings and Counsels* (1884). Dr Hopkins took a lifelong interest in Christian missions, and from 1857 until his death was president of the American Board of Commissioners for Foreign Missions (the American Congregational Mission Board). He died at Williams-town, on the 17th of June 1887. His son, HENRY HOPKINS (1837-1908), was also from 1903 till his death president of Williams College.

See Franklin Carter's *Mark Hopkins* (Boston, 1899), in the "American Religious Leaders" series, and Leverett W. Spring's *Mark Hopkins, Teacher* (New York, 1888), being No. 4, vol. i., of the "Monographs of the Industrial Educational Association."

Mark Hopkins's brother, ALBERT HOPKINS (1807-1872), was long associated with him at Williams College, where he graduated in 1826 and was successively a tutor (1827-1829), professor of mathematics and natural philosophy (1829-1838), professor of natural philosophy and astronomy (1838-1868) and professor of astronomy (1868-1872). In 1835 he organized and conducted a Natural History Expedition to Nova Scotia, said to have been the first expedition of the kind sent out from any American college, and in 1837, at his suggestion and under his direction, was built at Williams College an astronomical observatory, said to have been the first in the United States built at a college exclusively for purposes of instruction. He died at Williams-town on the 24th of May 1872.

See Albert C. Sewall's *Life of Professor Albert Hopkins* (1879).

HOPKINS, SAMUEL (1721-1803), American theologian, from whom the Hopkinsian theology takes its name, was born at Waterbury, Connecticut, on the 17th of September 1721. He graduated at Yale College in 1741; studied divinity at Northampton, Massachusetts, with Jonathan Edwards; was licensed to preach in 1742, and in December 1743 was ordained pastor of the church in the North Parish of Sheffield, or Housatonic (now Great Barrington), Massachusetts, at that time a small settlement of only thirty families. There he laboured—preaching, studying and writing—until 1769, for part of the time (1751-1758) in intimate association with his old teacher, Edwards, whose call to Stockbridge he had been instrumental in procuring. His theological views having met with much opposition, however, he was finally dismissed from the pastorate on the pretext of want of funds for his support. From April 1770 until his death on the 20th of December 1803, he was the pastor of the First Church in Newport, Rhode Island, though during 1776-1780, while Newport was occupied by the British, he preached at Newburyport, Mass., and at Canterbury and Stamford, Conn. In 1799 he had an attack of paralysis, from which he never wholly recovered. Hopkins's theological views have had a powerful influence in America. Personally he was remarkable for force and energy of character, and for the utter fearlessness with which he followed premises to their conclusions. In vigour of intellect and in strength and purity of moral tone he was hardly inferior to Edwards himself. Though he was originally a slave-holder, to him belongs the honour of having been the first among the Congregational ministers of New England to denounce slavery both by voice and pen; and to his persistent though bitterly opposed efforts are probably chiefly to be attributed the law of 1774, which forbade the importation of negro slaves into Rhode Island, as also that of 1784, which declared that all children of slaves born in Rhode Island after the following March should be free. His training school for negro missionaries to Africa was broken up by the confusion of the American War of Independence. Among his publications are a valuable *Life and Character of Jonathan Edwards* (1799), and numerous pamphlets, addresses and sermons, including *A Dialogue concerning the Slavery of the Africans, showing it to be the Duty and Interest of the American States to emancipate all their African Slaves* (1776), and *A Discourse upon the Slave Trade and the History of the Africans* (1793). His distinctive theological tenets are to be found in his important work, *A System of Doctrines Contained in Divine Revelation, Explained and Defended* (1793), which has had an influence hardly inferior to that exercised by the writings of Edwards himself. They may

be summed up as follows: God so rules the universe as to produce its highest happiness, considered as a whole. Since God's sovereignty is absolute, sin must be, by divine permission, a means by which this happiness of the whole is secured, though that this is its consequence, renders it no less heinous in the sinner. Virtue consists in preference for the good of the whole to any private advantage; hence the really virtuous man must willingly accept any disposition of himself that God may deem wise—a doctrine often called "willingness to be damned." All have natural power to choose the right, and are therefore responsible for their acts; but all men lack inclination to choose the right unless the existing "bias" of their wills is transformed by the power of God from self-seeking into an effective inclination towards virtue. Hence preaching should demand instant submission to God and disinterested goodwill, and should teach the worthlessness of all religious acts or dispositions which are less than these, while recognizing that God can grant or withhold the regenerative change at his pleasure.

The best edition of Hopkins's *Works* is that published in three volumes at Boston in 1852, containing an excellent biographical sketch by Professor Edwards A. Park. In 1854 was published separately Hopkins's *Treatise on the Millennium*, which originally appeared in his *System of Doctrines* and in which he deduced from prophecies in *Daniel* and *Revelation* that the millennium would come "not far from the end of the twentieth century." See also Stephen West's *Sketches of the Life of the Late Reverend Samuel Hopkins* (Hartford, Conn., 1805), Franklin B. Dexter's *Biographical Sketches of the Graduates of Yale College* and Williston Walker's *Ten New England Leaders* (New York, 1901). (W. W.)

HOPKINS, WILLIAM (1793-1866), English mathematician and geologist, was born at Kingston-on-Soar, in Nottinghamshire, on the 2nd of February 1793. In his youth he learned practical agriculture in Norfolk and afterwards took an extensive farm in Suffolk. In this he was unsuccessful. At the age of thirty he entered St Peter's College, Cambridge, taking his degree of B.A. in 1827 as seventh wrangler and M.A. in 1830. In 1833 he published *Elements of Trigonometry*. He was distinguished for his mathematical knowledge, and became eminently successful as a private tutor, many of his pupils attaining high distinction. About 1833, through meeting Sedgwick at Barmouth and joining him in several excursions, he became intensely interested in geology. Thereafter, in papers published by the Cambridge Philosophical Society and the Geological Society of London, he entered largely into mathematical inquiries connected with geology, dealing with the effects which an elevatory force acting from below would produce on a portion of the earth's crust, in fissures, faults, &c. In this way he discussed the elevation and denudation of the Lake district, the Wealden area, and the Bas Boulonnais. He wrote also on the motion of glaciers and the transport of erratic blocks. So ably had he grappled with many difficult problems that in 1850 the Wollaston medal was awarded to him by the Geological Society of London; and in the following year he was elected president. In his second address (1853) he criticized Elie de Beaumont's theory of the elevation of mountain-chains and showed the imperfect evidence on which it rested. He brought before the Geological Society in 1851 an important paper *On the Causes which may have produced changes in the Earth's superficial Temperature*. He was president of the British Association for 1853. His later researches included observations on the conductivity of various substances for heat, and on the effect of pressure on the temperature of fusion of different bodies. He died at Cambridge on the 13th of October 1866.

Obituary by W. W. Smyth, in *Quart. Journ. Geol. Soc.* (1867), p. xxxix.

HOPKINSON, FRANCIS (1737-1791), American author and statesman, one of the signers of the Declaration of Independence, was born in Philadelphia, Pennsylvania, on the 2nd of October 1737. He was a son of Thomas Hopkinson (1709-1751), a prominent lawyer of Philadelphia, one of the first trustees of the College of Philadelphia, now the University of Pennsylvania, and first president of the American Philosophical Society. Francis was the first student to enter the College of Philadelphia.

In one of his latest writings (*Epist.* ii. 2. 42, &c.) Horace gives a further account of his education; but we hear no more of his father, nor is there any allusion in his writings to the existence of any other member of his family or any other relative. After the ordinary grammatical and literary training at Rome, he went (45 B.C.) to Athens, the most famous school of philosophy, as Rhodes was of oratory; and he describes himself while there as "searching after truth among the groves of Academus" as well as advancing in literary accomplishment. His pleasant residence there was interrupted by the breaking out of the civil war. Following the example of his young associates, he attached himself to the cause of Brutus, whom he seems to have accompanied to Asia, probably as a member of his staff; and he served at the battle of Philippi in the post of military tribune. He shared in the rout which followed the battle, and henceforth, though he was not less firm in his conviction that some causes were worth fighting for and dying for, he had but a poor opinion of his own soldierly qualities.

He returned to Rome shortly after the battle, stripped of his property, which formed part of the land confiscated for the benefit of the soldiers of Octavianus and Antony. It may have been at this time that he encountered the danger of shipwreck, which he mentions among the perils from which his life had been protected by supernatural aid (*Carm.* iii. 4. 28). He procured in some way the post of a clerkship in the quaestor's office, and about three years after the battle of Philippi, he was introduced by Virgil and Varius to Maecenas. This was the turning-point of his fortunes. He owed his friendship with the greatest of literary patrons to his personal merits rather than to his poetic fame; for he was on intimate terms with Maecenas before the first book of the *Satires* (his first published work) appeared. He tells us in one of his *Satires* (i. 10. 31) that his earliest ambition was to write Greek verses. In giving this direction to his ambition, he was probably influenced by his admiration of the old iambic and lyrical poets whom he has made the models of his own *Epodes* and *Odes*. His common sense as well as his national feeling fortunately saved him from becoming a second-rate Greek versifier in an age when poetic inspiration had passed from Greece to Italy, and the living language of Rome was a more fitting vehicle for the new feelings and interests of men than the echoes of the old Ionian or Aeolian melodies. His earliest Latin compositions were, as he tells us, written under the instigation of poverty; and they alone betray any trace of the bitterness of spirit which the defeat of his hopes and the hardships which he had to encounter on his first return to Rome may have temporarily produced on him. Some of the *Epodes*, of the nature of personal and licentious lampoons, and the second *Satire* of book i., in which there is some trace of an angry republican feeling, belong to these early compositions. But by the time the first book of *Satires* was completed and published (35 B.C.) his temper had recovered its natural serenity, and, though he had not yet attained to the height of his fortunes, his personal position was one of comfort and security, and his intimate relation with the leading men in literature and social rank was firmly established.

About a year after the publication of this first book of *Satires* Maecenas presented him with a farm among the Sabine hills, near the modern Tivoli. This secured him pecuniary independence; it satisfied the love of nature which had been implanted in him during the early years spent on the Venusian farm; and it afforded him a welcome escape from the distractions of city life and the dangers of a Roman autumn. Many passages in the *Satires*, *Odes* and *Epistles* express the happiness and pride with which the thought of his own valley filled him, and the interest which he took in the simple and homely ways of his country neighbours. The inspiration of the *Satires* came from the heart of Rome; the feeling of many of the *Odes* comes direct from the Sabine hills; and even the meditative spirit of the later *Epistles* tells of the leisure and peace of quiet days spent among books, or in the open air, at a distance from "the smoke, wealth and tumult" of the great metropolis.

The second book of *Satires* was published in 29 B.C.; the

Epodes (spoken of by himself as *iambi*) apparently about a year earlier, though many of them are, as regards the date of their composition, to be ranked among the earliest extant writings of Horace. In one of his *Epistles* (i. 19. 25) he rests his first claim to originality on his having introduced into Latium the metres and spirit of Archilochus of Paros. He may have naturalized some special form of metre employed by that poet, and it may be (as Th. Plütz has suggested) that we should see in the *Epodes* a tone of mockery and parody. But his personal lampoons are the least successful of his works; while those *Epodes* which treat of other subjects in a poetical spirit are inferior in metrical effect, and in truth and freshness of feeling, both to the lighter lyrics of Catullus and to his own later and more carefully meditated *Odes*. The *Epodes*, if they are serious at all, are chiefly interesting as a record of the personal feelings of Horace during the years which immediately followed his return to Rome, and as a prelude to the higher art and inspiration of the first three books of the *Odes*, which were published together about the end of 24 or the beginning of 23 B.C.¹ The composition of these *Odes* extended over several years, but all the most important among them belong to the years between the battle of Actium and 24 B.C. His lyrical poetry is thus, not, like that of Catullus, the ardent utterance of his youth, but the mature and finished workmanship of his manhood. The state of public affairs was more favourable than it had been since the outbreak of the civil war between Caesar and Pompey for the appearance of lyrical poetry. Peace, order and national unity had been secured by the triumph of Augustus, and the enthusiasm in favour of the new government had not yet been chilled by experience of its repressing influence. The poet's circumstances were, at the same time, most favourable for the exercise of his lyrical gift during these years. He lived partly at Rome, partly at his Sabine farm, varying his residence occasionally by visits to Tibur, Praeneste or Baiae. His intimacy with Maecenas was strengthened and he had become the familiar friend of the great minister. He was treated with distinction by Augustus, and by the foremost men in Roman society. He complains occasionally that the pleasures of his youth are passing from him, but he does so in the spirit of a temperate Epicurean, who found new enjoyments in life as the zest for the old enjoyments decayed, and who considered the wisdom and meditative spirit—"the philosophic mind that years had brought"—an ample compensation for the extinct fires of his youth.

About four years after the publication of the three books of *Odes*, the first book of the *Epistles* appeared, introduced, as his *Epodes*, *Satires* and *Odes* had been, by a special address to Maecenas. From these *Epistles*, as compared with the *Satires*, we gather that he had gradually adopted a more retired and meditative life, and had become fonder of the country and of study, and that, while owing allegiance to no school or sect of philosophy, he was framing for himself a scheme of life, was endeavouring to conform to it, and was bent on inculcating it on others. He maintained his old friendships, and continued to form new intimacies, especially with younger men engaged in public affairs or animated by literary ambition. After the death of Virgil he was recognized as pre-eminently the greatest living poet, and was accordingly called upon by Augustus to compose the sacred hymn for the celebration of the secular games in 17 B.C. About four years later he published the fourth book of *Odes* (about 13 B.C.) having been called upon to do so by the emperor, in order that the victories of his stepsons Drusus and Tiberius over the Rhaeti and Vindelici might be worthily celebrated. He lived about five years longer, and during these years published the second book of *Epistles*, and the *Epistle to the Pisos*, more generally known as the "*Ars poetica*." These later *Epistles* are mainly devoted to literary criticism, with the especial object of vindicating the poetic claims of his own age over those of the age of Ennius and the other early

¹ The date is determined by the poem on the death of Quintilius Varus (who died 24 B.C.), and by the reference in *Ode* i. 12 to the young Marcellus (died in autumn 23 B.C.) as still alive. Cf. Wickham's Introduction to the *Odes*.

poets of Rome. He might have been expected, as a great critic and lawgiver on literature, to have exercised a beneficial influence on the future poetry of his country, and to have applied as much wisdom to the theory of his own art as to that of a right life. But his critical *Epistles* are chiefly devoted to a controversial attack on the older writers and to the exposition of the laws of dramatic poetry, on which his own powers had never been exercised, and for which either the genius or circumstances of the Romans were unsuited. The same subordination of imagination and enthusiasm to good sense and sober judgment characterizes his opinions on poetry as on morals.

He died somewhat suddenly on the 17th of November of the year 8 B.C. He left Augustus to see after his affairs, and was buried on the Esquiline Hill, near Maecenas.

Horace is one of the few writers, ancient or modern, who have written a great deal about themselves without laying themselves open to the charge of weakness or egotism. His chief claim to literary originality is not that on which he himself rested his hopes of immortality—that of being the first to adapt certain lyrical metres to the Latin tongue—but rather that of being the first of those whose works have reached us who establishes a personal relation with his reader, speaks to him as a familiar friend, gives him good advice, tells him the story of his life, and shares with him his private tastes and pleasures—and all this without any loss of self-respect, any want of modesty, or breach of good manners, and in a style so lively and natural that each new generation of readers might fancy that he was addressing them personally and speaking to them on subjects of every day modern interest. In his self-portraiture, far from wishing to make himself out better or greater than he was, he seems to write under the influence of an ironical restraint which checks him in the utterance of his highest moral teaching and of his poetical enthusiasm. He affords us some indications of his personal appearance, as where he speaks of the "nigros angusta fronte capillos" of his youth, and describes himself after he had completed his forty-fourth December as of small stature, prematurely grey and fond of basking in the sun (*Epist.* i. 20. 24).

In his later years his health became weaker or more uncertain, and this caused a considerable change in his habits, tastes and places of residence. It inclined him more to a life of retirement and simplicity, and also it stimulated his tendency to self-introspection and self-culture. In his more vigorous years, when he lived much in Roman society, he claims to have acted in all his relations to others in accordance with the standard recognized among men of honour in every age, to have been charitably indulgent to the weakness of his friends, and to have been exempt from petty jealousies and the spirit of detraction. If ever he deviates from his ordinary vein of irony and quiet sense into earnest indignation, it is in denouncing conduct involving treachery or malice in the relations of friends (*Sat.* i. 4. 81, &c.).

He claims to be and evidently aims at being independent of fortune, superior to luxury, exempt both from the sordid cares of avarice and the coarser forms of profligacy. At the same time he makes a frank confession of indolence and of occasional failure in the pursuit of his ideal self-mastery. He admits his irascibility, his love of pleasure, his sensitiveness to opinion, and some touch of vanity or at least of gratified ambition arising out of the favour which through all his life he had enjoyed from those much above him in social station (*Epist.* i. 20. 23). Yet there appears no trace of any unworthy deference in Horace's feelings towards the great. Even towards Augustus he maintained his attitude of independence, by declining the office of private secretary which the emperor wished to force upon him; and he did so with such tact as neither to give offence nor to forfeit the regard of his superior. His feeling towards Maecenas is more like that of Pope towards Bolingbroke than that which a client in ancient or modern times entertains towards his patron. He felt pride in his protection and in the intellectual sympathy which united him with one whose personal qualities had enabled him to play so prominent

and beneficent a part in public affairs. Their friendship was slowly formed, but when once established continued unshaken through their lives.

There is indeed nothing more remarkable in Horace than the independence, or rather the self-dependence, of his character. The enjoyment which he drew from his Sabine farm consisted partly in the refreshment to his spirit from the familiar beauty of the place, partly in the "otia liberrima" from the claims of business and society which it afforded him. His love poems, when compared with those of Catullus, Tibullus and Propertius, show that he never, in his mature years at least, allowed his peace of mind to be at the mercy of any one. They are the expressions of a fine and subtle and often a humorous observation rather than of ardent feeling. There is perhaps a touch of pathos in his reference in the *Odes* to the early death of Cinara, but the epithet he applies to her in the *Epistles*,

"Quem acis immunem Cinaræ placuisse rapaci,"

shows that the pain of thinking of her could not have been very heartfelt. Even when the *Odes* addressed to real or imaginary beauties are most genuine in feeling, they are more the artistic rekindling of extinct fires than the utterance of recent passion. In his friendships he had not the self-forgetful devotion which is the most attractive side of the character of Catullus; but he studied how to gain and keep the regard of those whose society he valued, and he repaid this regard by a fine courtesy and by a delicate appreciation of their higher gifts and qualities, whether proved in literature, or war, or affairs of state or the ordinary dealings of men. He enjoyed the great world, and it treated him well; but he resolutely maintained his personal independence and the equipoise of his feelings and judgment. If it is thought that in attributing a divine function to Augustus he has gone beyond the bounds of a sincere and temperate admiration, a comparison of the *Odes* in which this occurs with the first *Epistle* of the second book shows that he certainly recognized in the emperor a great and successful administrator and that his language is to be regarded rather as the artistic expression of the prevailing national sentiment than as the tribute of an insincere adulation.

The aim of Horace's philosophy was to "be master of oneself," to retain the "mens aequa" in all circumstances, to use the gifts of fortune while they remained, and to be prepared to part with them with equanimity; to make the most of life, and to contemplate its inevitable end without anxiety. Self-reliance and resignation are the lessons which he constantly inculcates. His philosophy is thus a mode of practical Epicureanism combined with other elements which have more affinity with Stoicism. In his early life he professed his adherence to the former system, and several expressions in his first published work show the influences of the study of Lucretius. At the time when the first book of the *Epistles* was published he professes to assume the position of an eclectic rather than that of an adherent of either school (*Epist.* i. 1. 13-19). We note in the passage here referred to, as in other passages, that he mentions Aristippus of Cyrene, rather than Epicurus himself, as the master under whose influence he from time to time insensibly lapsed. Yet the dominant tone of his teaching is that of a refined Epicureanism, not so elevated or purely contemplative as that preached by Lucretius, but yet more within the reach of a society which, though luxurious and pleasure-loving, had not yet become thoroughly frivolous and enervated. His advice is to subdue all violent emotion of fear or desire; to estimate all things calmly—"nil admirari"; to choose the mean between a high and low estate; and to find one's happiness in plain living rather than in luxurious indulgence. Still there was in Horace a robust fibre, inherited from the old Italian race, which moved him to value the dignity and nobleness of life more highly than its ease and enjoyment. In some of the stronger utterances of his *Odes*, where he expresses sympathy with the manlier qualities of character, we recognize the resistant attitude of Stoicism rather than the passive acquiescence of Epicureanism. The concluding stanzas of the address to Lollius (*Ode* iv. 9) exhibit the Epicurean and Stoical view of life so combined as to be more worthy of human dignity than

the genial worldly wisdom of the former school, more in harmony with human experience than the formal precepts of the latter.

It is interesting to trace the growth of Horace in elevation of sentiment and serious conviction from his first ridicule of the paradoxes of Stoicism in the two books of the *Satires* to the appeal which he makes in some of the *Odes* of the third book to the strongest Roman instincts of fortitude and self-sacrifice. A similar modification of his religious and political attitude may be noticed between his early declaration of Epicurean unbelief and the sympathy which he shows with the religious reaction fostered by Augustus; and again between the Epicurean indifference to national affairs and the strong support which he gives to the national policy of the emperor in the first six *Odes* of the third book, and in the fifth and fifteenth of the fourth book. In his whole religious attitude he seems to stand midway between the consistent denial of Lucretius and Virgil's pious endeavour to reconcile ancient faith with the conclusions of philosophy. His introduction into some of his *Odes* of the gods of mythology must be regarded as merely artistic or symbolical. Yet in some cases we recognize the expression of a natural piety, thankful for the blessing bestowed on purity and simplicity of life, and acknowledging a higher and more majestic law governing nations through their voluntary obedience. On the other hand, his allusions to a future life, as in the "domus exilis Plutonia," and the "furvae regna Proserpinae," are shadowy and artificial. The image of death is constantly obtruded in his poems to enhance the sense of present enjoyment. In the true spirit of paganism he associates all thoughts of love and wine, of the meeting of friends, or of the changes of the seasons with the recollection of the transitoriness of our pleasures—

"Nos, ubi decidimus
Quo pias Aeneas, quo dives Tullus et Ancus,
Pulvis et umbra sumus."

Horace is so much of a moralist in all his writings that, in order to enter into the spirit both of his familiar and of his lyrical poetry, it is essential to realize what were his views of life and the influences under which they were formed. He is, though in a different sense from Lucretius, eminently a philosophical and reflective poet. He is also, like all the other poets of the Augustan age, a poet in whose composition culture and criticism were as conspicuous elements as spontaneous inspiration. In the judgment he passes on the older poetry of Rome and on that of his contemporaries, he seems to attach more importance to the critical and artistic than to the creative and inventive functions of genius. It is on the labour and judgment with which he has cultivated his gift that he rests his hopes of fame. The whole poetry of the Augustan age was based on the works of older poets, Roman as well as Greek. Its aim was to perfect the more immature workmanship of the former, and to adapt the forms, manners and metres of the latter to subjects of immediate and national interest. As Virgil performed for his generation the same kind of office which Ennius performed for an older generation, so Horace in his *Satires*, and to a more limited extent in his *Epistles*, brought to perfection for the amusement and instruction of his contemporaries the rude but vigorous designs of Lucilius.

It was the example of Lucilius which induced Horace to commit all his private thoughts, feelings and experience "to his books as to trusty companions," and also to comment freely on the characters and lives of other men. Many of the subjects of particular satires of Horace were immediately suggested by those treated by Lucilius. Thus the "Journey to Brundisium" (*Sat.* i. 3) reproduced the outlines of Lucilius' "Journey to the Sicilian Straits." The discourse of Ocella on luxury (*Sat.* ii. 2) was founded on a similar discourse of Laelius on plutony, and the "Banquet of Nasidienus" (*Sat.* ii. 8) may have been suggested by the description by the older poet of a rustic entertainment. There was more of moral censure and personal aggressiveness in the satire of the older poet. The ironical temper of Horace induced him to treat the follies of society in the spirit of a humorist and man of the world, rather than to assail vice with the severity of a censor; and the greater urbanity of his age or of his disposition restrained in him the direct personality of satire. The names introduced by him to mark types of character such as Nomentanus, Maenius, Pantolabus, &c., are reproduced from the writings of the older poet. Horace also followed Lucilius in the variety of forms which his satire assumes, and especially in the frequent adoption of the form of dialogue, derived from the "dramatic medley" which was the original character of the Roman *Satura*. This form suited the spirit in which Horace regarded the world, and also the dramatic quality of his genius, just as the direct denunciation and elaborate painting of character suited the "sæva indignatio" and the oratorical genius of Juvenal.

Horace's satire is accordingly to a great extent a reproduction in

form, manner, substance and tone of the satire of Lucilius; or rather it is a casting in the mould of Lucilius of his own observation and experience. But a comparison of the fragments of Lucilius with the finished compositions of Horace brings out in the strongest light the artistic originality and skill of the latter poet in his management of metre and style. Nothing can be rougher and harsher than the hexameters of Lucilius, or cruder than his expression. In his management of the more natural trochaic metre, he has shown much greater ease and simplicity. It is one great triumph of Horace's genius that he was the first and indeed the only Latin writer who could bend the stately hexameter to the uses of natural and easy, and at the same time terse and happy, conversational style. Catullus, in his hendecasyllabics, had shown the vivacity with which that light and graceful metre could be employed in telling some short story or describing some trivial situation dramatically. But no one before Horace had succeeded in applying the metre of heroic verse to the uses of common life. But he had one great native mode in the mastery of a terse, refined, ironical and natural conversational style. Terence; and the *Satires* show, not only in allusions to incidents and personages, but in many happy turns of expression very frequent traces of Horace's familiarity with the works of the Roman Menander.

The *Epistles* are more original in form, more philosophic in spirit, more finished and charming in style than the *Satires*. The form of composition may have been suggested by that of some of the satires of Lucilius, which were composed as letters to his personal friends. But letter-writing in prose, and occasionally also in verse, had been common among the Romans from the time of the siege of Corinth; and a practice originating in the wants and convenience of friends temporarily separated from one another by the public service was ultimately cultivated as a literary accomplishment. It was a happy idea of Horace to adopt this form for his didactic writings on life and literature. It suited him as an eclectic and not a systematic thinker, and as a friendly counsellor rather than a formal teacher of his age. It suited his circumstances in the latter years of his life, when his tastes inclined him more to retirement and study, while he yet wished to retain his hold on society and to extend his relations with younger men who were rising into eminence. It suited the class who cared for literature—a limited circle of educated men, intimate with one another, and sharing the same tastes and pursuits. While giving expression to lessons applicable to all men, he in this way seems to address each reader individually, with the urbanity of a friend rather than the solemnity of a preacher. In spirit the *Epistles* are more ethical and meditative than the *Satires*. Like the *Odes* they exhibit the twofold aspects of his philosophy, that of temperate Epicureanism and that of more serious and elevated conviction. In the actual maxims which he lays down, in his apparent belief in the efficacy of addressing philosophical texts to the mind, he exemplifies the truthfulness and limitation of all Roman thought. But the spirit and sentiment of his practical philosophy is quite genuine and original. The individuality of the great Roman moralists, such as Lucretius and Horace, appears not in any difference in the results at which they have arrived, but in the difference of spirit with which they regard the spectacle of human life. In reading Lucretius we are impressed by his earnestness, his pathos, his elevation of feeling; in Horace we are charmed by the serenity of his temper and the favour of a delicate and subtle wisdom. We note also in the *Epistles* the presence of a more philosophic spirit, not only in the expression of his personal convictions and aims, but also in his comments on society. In the *Satires* he paints the outward effects of the passions of the age. He shows us prominent types of character—the miser, the parasite, the legacy-hunter, the parvenu, &c., but he does not try to trace these different manifestations of life to their source. In the *Epistles* he finds the secret spring of the social vices of the age in the desire, and marked in other times as in those of Horace, to become rich too fast, and in the tendency to value men according to their wealth, and to sacrifice the ends of life to a superfluous care for the means of living. The cause of all this aimless restlessness and unreasonable desire is summed up in the words "Strenua nos exercet inertia."

In his *Satires* and *Epistles* Horace shows himself a genuine moralist, a subtle observer and true painter of life, and an admirable writer. But for both of these works he himself disclaims the title of poetry. He rests his claims as a poet on his *Odes*. They reveal an entirely different aspect of his genius, his spirit and his culture. He is one among the few great writers of the world who have attained high excellence in two widely separated provinces of literature. Through all his life he was probably conscious of the "ingeni benigna vena," which in his youth made him the sympathetic student and imitator of the older lyrical poetry of Greece, and directed his latest efforts to poetic criticism. But it was in the years that intervened between the publication of his *Satires* and *Epistles* that his lyrical genius asserted itself as his predominant faculty. At that time he had outlived the coarser pleasures and risen above the harassing cares of his earlier career; a fresh source of happiness and inspiration had been opened up to him in his beautiful Sabine retreat; he had become not only reconciled to the rule of Augustus, but a thoroughly convinced and, so far as his temperaments admitted to enthusiasm, an enthusiastic believer in his beneficence. But it was only after much labour that his original vein of genius obtained a free and abundant outlet. He lays no claim to the "profuse strains of unpremeditated art," with which other great lyrical poets of ancient

and modern times have charmed the world. His first efforts were apparently imitative, and were directed to the attainment of perfect mastery over form, metre and rhythm. The first nine *Odes* of the first book are experiments in different kinds of metre. They and all the other metres employed by him are based on those employed by the older poets of Greece—Alcaeus, Sappho, Archilochus, Alcman, &c. He has built the structure of his lighter *Odes* also on their model, while in some of those in which the matter is more weighty, as in that in which he calls on Calliope "to dictate a long continuous strain," he has endeavoured to reproduce something of the intricate movement, the abrupt transitions, the interpenetration of narrative and reflection, which characterize the art of Pindar. He frequently reproduces the language and some of the thoughts of his masters, but he gives them new application, or stamps them with the impress of his own experience. He brought the metres which he has employed to such perfection that the art perished with him. A great proof of his mastery over rhythm is the skill with which he has varied his metres according to the sentiment which he wishes to express. Thus his great metre, the Alcaic, has a character of stateliness and majesty in addition to the energy and impetus originally imparted to it by Alcaeus. The Sapphic metre he employs with a peculiar lightness and vivacity which harmonize admirably with his gayer moods.

Again in regard to his diction, if Horace has learned his subtlety and moderation from his Greek masters, he has tempered those qualities with the masculine characteristics of his race. No writer is more Roman in the stateliness and dignity, the terseness, occasionally even in the sobriety and bare literalness, of his diction.

While it is mainly owing to the extreme care which Horace gave to form, rhythm and diction that his own prophecy

"Usque ego postera
Crescam laude reorans"

has been so amply fulfilled, yet no greater injustice could be done to him than to rank him either as poet or critic with those who consider form everything in literature. With Horace the mastery over the vehicle of expression was merely an essential preliminary to making a worthy and serious use of that vehicle. The poet, from Horace's point of view, was intended not merely to give refined pleasure to a few, but above all things, to be "utilis urbi." Yet he is saved, in his practice, from the abuse of this theory by his admirable sense, his ironical humour, his intolerance of pretension and pedantry. Opinions will differ as to whether he or Catullus is to be regarded as the greater lyrical poet. Those who assign the palm to Horace will do so, certainly not because they recognize in him richer or equally rich gifts of feeling, conception and expression, but because the subjects to which his art has been devoted have a fuller, more varied, more mature and permanent interest for the world.

AUTHORITIES.—For the life of Horace the chief authorities are his own works and a short ancient biography which is attributed to Suetonius. The *apparatus criticus* is most fully described in O. Keller's preface to vol. I. of the 2nd ed. (1899) of Keller and Holder's recension of Horace's works. This edition also gives by far the largest collection of variants and emendations to the text and of the *testimonia* of ancient writers.

What might have proved the most important manuscript of Horace, the so-called *vetustissimus Blandinius*, is now lost, and we know it only from the account of J. Cruquius who saw it in 1565. The relations of the extant MSS. to each other and the presumed archetype present an intricate problem; and Keller's solution has not proved generally acceptable. See a *résumé* of the controversy *Horaschrift seit 1880* by J. Bick (Leipzig, 1906) and F. Vollmer in *Philologus*, Supp. x, 2, pp. 261-322. Many MSS. of Horace contain ancient scholia which are copied or taken with abridgment from the commentaries of Porphyrio, who lived about A.D. 200, and Helenius Acro, a still earlier grammarian. These scholia also have been collected and edited—the Porphyrio scholia by A. Holder (1902) and the "Acronian" (or pseudo-Acronian) by O. Keller (1902-1904). R. Bentley's epoch-making edition (1711) has been reprinted with an index by Zangmeister (1869). Of the modern commentaries the most useful are those of J. C. Orelli (4th ed., revised by O. Hirschfelder and J. Mewes, 1886-1890, with *index verborum*), and of A. Kiessling (revised by R. Heinze, *Odes*, 1901, 1908, *Satires*, 1906, *Epistles*, 1898). The best complete English commentary is that of E. C. Wickham (2 vols., 1874-1896). Other editions with English notes are those of T. E. Page (*Odes*, 1883), A. Palmer (*Satires*, 1883), A. S. Wilkins (*Epistles*, 1885), J. Gow (*Odes and Epodes*, 1896, *Satires*, 1, 1901), P. Shorey (*Odes and Epodes*, 1898, Boston, U.S.A.), L. Müller's elaborate edition of the *Odes and Epodes* was published posthumously (1900). Of the critical editions Keller and Holder's still holds the field: to this Keller's *Epitome zu Horaz* (1879) is a necessary adjunct. F. Vollmer's text (1907) uses Keller's materials on a new principle. Of illustrated editions H. H. Milman's (1867) and C. W. King's (1869, with text revised by H. A. J. Munro) deserve mention. The best verse translation is that of J. Conington lately reprinted with the Latin text from the recension in Postgate's new *Corpus poetarum*. For further information see Teuffel's *Geschichte der römischen Literatur* (Eng. trans. by G. C. Watt), §§234-240, and M. Schanz's excellent account in his *Geschichte der römischen Literatur*, vol. II, §§ 251-266. (W. Y. S.; J. G*.)

HORAE (Lat. *hora*, hour), the Hours, in Greek mythology *Ἵσπαι*, originally the personification of a series of natural phenomena. In the *Iliad* (v. 749) they are the custodians of the gates of Olympus, which they open or shut by scattering or condensing the clouds; that is, they are weather goddesses, who send down or withhold the fertilizing dew and rain. In the *Odyssey*, where they are represented as bringing round the seasons in regular order, they are an abstraction rather than a concrete personification. The brief notice in Hesiod (*Theog.* 901), where they are called the children of Zeus and Themis, who superintend the operations of agriculture, indicates by the names assigned to them (Eunomia, Dikē, Eirenē, i.e. Good Order, Justice, Peace) the extension of their functions as goddesses of order from nature to the events of human life, and at the same time invests them with moral attributes. Like the Moerae (Fates), they regulate the destinies of man, watch over the newly born, secure good laws and the administration of justice. The selection of three as their number has been supposed to refer to the most ancient division of the year into spring, summer and winter, but it is probably only another instance of the Greek liking for that particular number or its multiples in such connexions (three Moerae, Charites, Gorgons, nine Muses). Order and regularity being indispensable conditions of beauty, it was easy to conceive of the Horae as the goddesses of youthful bloom and grace, inseparably associated with the idea of spring-time. As such they are companions of the Nymphs and Graces, with whom they are often confounded, and of other superior deities connected with the spring growth of vegetation (Demeter, Dionysus). At Athens they were two (or three) in number: Thallo and Carpo, the goddesses of the flowers of spring and of the fruits of summer, to whom Auxo, the goddess of the growth of plants, may be added, although some authorities make her only one of the Graces. In honour of the Horae a yearly festival (Horaea) was celebrated, at which protection was sought against the scorching heat and drought, and offerings were made of boiled meat as less insipid and more nutritious than roast. In later mythology, under Alexandrian influence, the Horae become the four seasons, daughters of Helios and Selene, each represented with the conventional attributes. Subsequently, when the day was divided into twelve equal parts, each of them took the name of Hora. Ovid (*Metam.* ii. 26) describes them as placed at equal intervals on the throne of Phoebus, with whom are also associated the four seasons. Nonnus (5th century A.D.) in the *Dionysiaca* also unites the twelve Horae as representing the day and the four Horae as the seasons in the palace of Helios.

See C. Lehrs, *Populäre Aesthetik* (1856); J. H. Krause, *Die Museen, Grazien, Horae, und Nymphen* (1871); and the articles in Daremberg and Saglio's *Dictionnaire des antiquités*, J. A. Hild; and in Roscher's *Lexikon der Mythologie*, W. Rapp.

HORAPOLLON, of Phaeenbythis in the nome of Panopolis in Egypt, Greek grammarian, flourished in the 4th century A.D. during the reign of Theodosius I. According to Suidas, he wrote commentaries on Sophocles, Alcaeus and Homer, and a work (*Τελευτά*) on places consecrated to the gods. Photius (cod. 279), who calls him a dramatist as well as a grammarian, ascribes to him a history of the foundation and antiquities of Alexandria (unless this is by an Egyptian of the same name, who lived in the reign of Zeno, 474-491). Under the name of Horapollon two books on *Hieroglyphics* are extant, which profess to be a translation from an Egyptian original into Greek by a certain Philippus, of whom nothing is known. The inferior Greek of the translation, and the character of the additions in the second book point to its being of late date; some have even assigned it to the 13th century. Though a very large proportion of the statements seem absurd and cannot be accounted for by anything known in the latest and most fanciful usage, yet there is ample evidence in both the books, in individual cases, that the tradition of the values of the hieroglyphic signs was not yet extinct in the days of their author.

BIBLIOGRAPHY.—Editions by C. Leemans (1835) and A. T. Cory (1840) with English translation and notes; see also G. Rathgeber in Ersch and Gruber's *Allgemeine Encyclopädie*; H. Schäfer, *Zeitschrift für ägyptische Sprache* (1905), p. 72.

HORATHI and CURIATII, in Roman legend, two sets of three brothers born at one birth on the same day—the former Roman, the latter Alban—the mothers being twin sisters. During the war between Rome and Alba Longa it was agreed that the issue should depend on a combat between the two families. Two of the Horatii were soon slain; the third brother feigned flight, and when the Curiatii, who were all wounded, pursued him without concert he slew them one by one. When he entered Rome in triumph, his sister recognized a cloak which he was wearing as a trophy as one she had herself made for her lover, one of the Curiatii. She thereupon invoked a curse upon her brother, who slew her on the spot. Horatius was condemned to be scourged to death, but on his appealing to the people his life was spared (Livy i. 25, 26; Dion. Halic. iii. 13-22). Monuments of the tragic story were shown by the Romans in the time of Livy (the altar of Janus Curiatius near the *sororium tigillum*, the "sister's beam," or yoke under which Horatius had to pass; and the altar of Juno Sororia). The legend was probably invented to account for the origin of the *provocatio* (right of appeal to the people), while at the same time it points to the close connexion and final struggle for supremacy between the older city on the mountain and the younger city on the plain. Their relationship and origin from three tribes are symbolically represented by the twin sisters and the two sets of three brothers.

For a critical examination of the story, see Schwieger, *Römische Geschichte*, bk. xii. 11, 14; Sir G. Cornwall Lewis, *Credibility of Early Roman History*, ch. xi. 15; W. Ihne, *Hist. of Rome*, i.; E. Pais, *Storia di Roma*, i. ch. 3 (1898), and *Ancient Legends of Roman History* (Eng. trans., 1906), where the story is connected with the ceremonies performed in honour of Jupiter Tigillus and Juno Sororia; C. Pascal, *Fatti e legende di Roma antica* (Florence, 1903); O. Gilbert, *Geschichte und Topographie der Stadt Rom im Altertum* (1883-1885).

HORATIUS COCLES, a legendary hero of ancient Rome. With two companions he defended the Sublician bridge against Lars Porsena and the whole army of the Etruscans, while the Romans cut down the bridge behind. Then Horatius threw himself into the Tiber and swam in safety to the shore. A statue was erected in his honour in the temple of Vulcan, and he received as much land as he could plough round in a single day. According to another version, Horatius alone defended the bridge, and was drowned in the Tiber.

There is an obvious resemblance between the legend of Horatius Cocles and that of the Horatii and Curiatii. In both cases three Romans come forward as the champions of Rome at a critical moment of her fortunes, and only one successfully holds his ground. In the one case, the locality is the land frontier, in the other, the boundary stream of Roman territory. E. Pais finds the origin of the story in the worship of Vulcan, and identifies Cocles (the "one-eyed") with one of the Cyclopes, who in mythology were connected with Hephaestus, and later with Vulcan. He concludes that the supposed statue of Cocles was really that of Vulcan, who, as one of the most ancient Roman divinities and, in fact, the protecting deity of the state, would naturally be confounded with the hero who saved it by holding the bridge against the invaders. He suggests that the legend arose from some religious ceremony, possibly the practice of throwing the stuffed figures called Argei into the Tiber from the Pons Sublicius on the ides of May. The conspicuous part played in Roman history by members of the Horatian family, who were connected with the worship of Jupiter Vulcanus, will explain the attribution of the name Horatius to Vulcan-Cocles.

See Livy ii. 10; Dion. Halic. v. 23-25; Polybius vi. 55; Plutarch, *Poplicola*, 16. For a critical examination of the legend, see Schwieger, *Römische Geschichte*, bk. xxi. 18; W. Ihne, *History of Rome*, i.; E. Pais, *Storia di Roma*, i. ch. 4 (1898), and *Ancient Legends of Roman History* (Eng. trans., 1906).

HORDE, a manufacturing town of Germany, in the Prussian province of Westphalia, is 2 m. S.E. from Dortmund on the railway to Soest. Pop. (1905) 28,461. It has a Roman Catholic and an Evangelical church, a synagogue and an old castle dating from about 1300. There are large smelting-works, foundries,

puddling-works, rolling-mills and manufactures of iron and plated wares. In the neighbourhood there are large iron and coal mines. A tramway connects the town with Dortmund.

HOREB, the ancient seat of Yahweh, the tribal god of the Kenites, adopted by His covenant by Israel. This is the name preferred by the Elohist writer (E) whose work is interwoven into the Old Testament narrative, and he is followed by the Deuteronomist school (D). The Yahwistic writer (J), on the other hand, prefers to call the mountain Sinai (q.v.), and so do the priestly writers (P). This latter form became the more usual. There is no ground for distinguishing between Horeb as the range and Sinai as the single mountain, or between Horeb and Sinai as respectively the N. and S. parts of the range.

HOREHOUND (O. Eng. *horkune*, Ger. *Andorn*, Fr. *marrube*). Common or white horehound, *Marrubium vulgare*, of the natural order *Labiatae*, is a perennial herb with a short stout rootstock, and thick stems, about 1 ft. in height, which, as well as their numerous branches, are coated with a white or hoary felt—whence the popular name of the plant. The leaves have long petioles, and are roundish or rhombic-ovate, with a bluntly toothed margin, much wrinkled, white and woolly below and pale green and downy above; the flowers are sessile, in dense whorls or clusters, small and dull-white, with a 10-toothed calyx and the upper lobe of the corolla long and bifid. The plant occurs in Europe, North Africa and West Asia to North-West India, and has been naturalized in parts of America. In Britain, where it is found generally on sandy or dry chalky ground, it is far from common. White horehound contains a volatile oil, resin, a crystallizable bitter principle termed *marrubiin* and other substances, and has a not unpleasant aromatic odour, and a persistent bitter taste. Formerly it was official in British pharmacopoeias; and the infusion, syrup or confection of horehound has long been in popular repute for the treatment of a host of dissimilar affections. Black horehound, *Ballota nigra*, is a hairy perennial herb, belonging to the same order, of foetid odour, is 2 to 3 ft. in height, and has stalked, roundish-ovate, toothed leaves and numerous flowers, in dense axillary clusters, with a green or purplish calyx, and a pale red-purple corolla. It occurs in Europe, North Africa and West Asia, and in Britain south of the Forth and Clyde, and has been introduced into North America.



Horehound.

HORGEN, a small town in the Swiss canton of Zürich, situated on the left or west shore of the Lake of Zürich, and by rail 10½ m. S.E. of the town of Zürich. Pop. (1900) 6883, mostly German-speaking and Protestants. It possesses many industrial establishments of various kinds, and is a centre of the Zürich silk manufacture. It came in 1406 into the possession of Zürich, with which it communicates by means of steamers on the lake, as well as by rail.

HORIZON (Gr. *ὁρίζων*, dividing), the apparent circle around which the sky and earth seem to meet. At sea this circle is well defined, the line being called the sea horizon, which divides the visible surface of the ocean from the sky. In astronomy the horizon is that great circle of the sphere the plane of which is at right angles to the direction of the plumb line. Sometimes a distinction is made between the rational and the apparent horizon; the former being the horizon as determined by a plane through the centre of the earth, parallel to that through the station of an observer. But on the celestial sphere the great circles of these two planes are coincident, so that this distinction is not necessary (see *ASTRONOMY: Spherical*). The Dip of the horizon at sea is the angular depression of the apparent sea

horizon, or circle bounding the visible ocean, below the apparent celestial horizon as above defined. It is due to the rotundity of the earth, and the height of the observer's eye above the water. The dip of the horizon and its distance in sea-miles when the height of the observer's eye above the sea-level is k feet, are approximately given by the formulae: Dip = $0.97 \sqrt{k}$; Distance = $1.17 \sqrt{k}$. The difference between the coefficients 0.97 and 1.17 arises from the refraction of the ray, but for which they would be equal.

HORMAYR, JOSEPH, BARON VON (1782-1848), German statesman and historian, was born at Innsbruck on the 20th of January 1782. After studying law in his native town, and attaining the rank of captain in the Tirolese Landwehr, the young man, who had the advantage of being the grandson of Joseph von Hormayr (1705-1778), chancellor of Tirol, obtained a post in the foreign office at Vienna (1801), from which he rose in 1803 to be court secretary and, being a near friend of the Archduke John, director of the secret archives of the state and court for thirteen months. In 1803 he married Therese Anderler von Hohenwald. During the insurrection of 1809, by which the Tirolese sought to throw off the Bavarian supremacy confirmed by the treaty of Pressburg, Hormayr was the mainstay of the Austrian party, and assumed the administration of everything (especially the composition of proclamations and pamphlets); but, returning home without the prestige of success, he fell, in spite of the help of the Archduke John, into disfavour both with the emperor Francis I. and with Prince Metternich, and at length, when in 1813 he tried to stir up a new insurrection in Tirol, he was arrested and imprisoned at Munkatt. In 1816 some amends were made to him by his appointment as imperial historiographer; but so little was he satisfied with the general policy and conduct of the Austrian court that in 1828 he accepted an invitation of King Louis I. to the Bavarian capital, where he became ministerial councillor in the department of foreign affairs. In 1832 he was appointed Bavarian minister-resident at Hanover, and from 1837 to 1846 he held the same position at Bremen. Together with Count Johann Friedrich von der Decken (1769-1840) he founded the Historical Society of Lower Saxony (Historischer Verein für Niedersachsen). The last two years of his life were spent at Munich as superintendent of the national archives. He died on the 5th of October 1848.

Hormayr's literary activity was closely conditioned by the circumstances of his political career and by the fact that Johannes von Müller (d. 1611) was his teacher: while his access to original documents gave value to his treatment of the past, his record or criticism of contemporary events received authority and interest from his personal experience. But his history of the Tirolese rebellion is far from being impartial; for he always liked to put himself into the first place, and the merits of Andreas Hofer and of other leaders are not sufficiently acknowledged. In his later writings he appears as a keen opponent of the policy of the court of Vienna.

The following are among Hormayr's more important works: *Geschichte des Grafen von Andechs* (1796); *Lexikon für Reisenden in Tirol* (1796); *Kritisch-diplomatische Beiträge zur Geschichte Tirols im Mittelalter* (2 vols., Innsbruck, 1802-1803, new ed., 1805); *Gesch. der gefürst. Grafschaft Tirol* (2 vols., Tübingen, 1806-1808); *Österreichischer Plutarch*, 20 vols., collection of portraits and biographies of the most celebrated administrators, commanders and statesmen of Austria (Vienna, 1807); an edition of Beauchamp's *Histoire de la guerre en Vendée* (1809); *Geschichte Hofers* (1817, 2nd ed., 2 vols., 1845) and other pamphlets; *Archiv für Gesch., Stat., Lit. und Kunst* (20 vols., 1809-1828); *Allgemeine Geschichte der neuesten Zeit vom Tod Friedrichs des Grossen bis zum zweiten Pariser Frieden* (3 vols., Vienna, 1814-1819, 2nd ed., 1891); *Wien, seine Gesch. und Denkwürdigkeiten* (5 vols., Vienna, 1823-1824); together with *Fragmente über Deutschland, in Sonderheit Bayerns Welthandel; Lebensbilder aus dem Befreiungskriege* (3 vols., Jena, 1841-1844, 2nd ed., 1845); *Die goldene Chronik von Hohenschwangau* (Munich, 1842); *Anemones aus dem Tagebuch eines alten Pilgersmanns* (4 vols., Jena, 1845-1847). Together with Medyasanski (1784-1844) he founded the *Taschenbuch für die vaterländ. Gesch.* (Vienna, 1811-1849).

See T. H. Merdau, *Biographische Züge aus dem Leben deutscher Männer* (Leipzig, 1815); Gräffer, *Österreichische National-Encyclopädie*, II. (1835); *Taschenbuch für vaterländische Geschichte* (1836 and 1847); *Neuer Nekrolog der Deutschen* (1848); *Blätter für literarische*

Unterhaltung (1849); Wurzbach, *Österreichisches biographisches Lexikon*, ix. (1863); K. Th. von Heigel in the *Allgemeine deutsche Biographie* (1881) and F. X. Wegele, *Geschichte der deutschen Historiographie* (Munich and Leipzig, 1885); F. v. Krones, *Aus Österreich stillen und bewegten Jahren 1810-1815; Biographie und Briefe an Erzhs. Johann* (Innsbruck, 1892); Hirn, *Tiroler Aufsätze* (1909). (J. Hn.)

HORMIBDAS, pope from 514 to 523 in succession to Symmachus, was a native of Campania. He is known as having succeeded in obtaining the reunion of the Eastern and Western Churches, which had been separated since the excommunication of Acacius in 484. After two unsuccessful attempts under the emperor Anastasius I., Hormisdas had no difficulty in coming to an understanding in 518 with his successor Justin. Legates were despatched to Constantinople; the memorial of the schismatic patriarchs was condemned; and union was resumed with the Holy See.

Details of this transaction have come down to us in the *Collectio Avellana* (*Corpus script. eeccl. Vindobon.*, vol. xxv., Nos. 105-203; cf. Andreas Thiel, *Epp. Rom. Pont. i.* 741 seq.).

HORMIZD, or **HORMIZDAS**, the name of five kings of the Sassanid dynasty (see PERSIA: *Ancient History*). The name is another form of Aburamazda or Ormuzd (Ormazd), which under the Sassanids became a common personal name and was borne not only by many generals and officials of their time (it therefore occurs very often on Persian seals), but even by the pope of Rome noticed above. It is strictly an abbreviation of Hormuzd-dad, "given by Ormuzd," which form is preserved by Agathias iv. 24-25 as name of King Hormizd I. and II. (*Ὁρμιζδάρας*).

1. **HORMIZD I.** (272-273) was the son of Shapur I., under whom he was governor of Khorasan, and appears in his wars against Rome (Trebellius Pollio, *Trig. Tyr.* 2, where Nöldeke has corrected the name Odomastes into Oromastes, i.e. Hormizd). In the Persian tradition of the history of Ardashir I., preserved in a Pahlavi text (Nöldeke, *Geschichte des Artaxschir I. Pápahsén*), he is made the son of a daughter of Mithrak, a Persian dynast, whose family Ardashir had extirpated because the magians had predicted that from his blood would come the restorer of the empire of Iran. Only this daughter is preserved by a peasant; Shapur sees her and makes her his wife, and her son Hormizd is afterwards recognized and acknowledged by Ardashir. In this legend, which has been partially preserved also in Tabari, the great conquests of Shapur are transferred to Hormizd. In reality he reigned only one year and ten days.

2. **HORMIZD II.**, son of Narseh, reigned for seven years five months, 302-309. Of his reign nothing is known. After his death his son Adarnases was killed by the grandees after a very short reign, as he showed a cruel disposition; another son, Hormizd, was kept a prisoner, and the throne reserved for the child with which a concubine of Hormizd II. was pregnant and which received the name Shapur II. Hormizd escaped from prison by the help of his wife in 323, and found refuge at the court of Constantine the Great (Zosim, ii. 27; John of Antioch, fr. 178; Zonar. 13-5). In 363 Hormizd served in the army of Julian against Persia; his son, with the same name, became consul in 366 (Ammian. Marc. 26. 8. 12).

3. **HORMIZD III.**, son of Yazdegerd I., succeeded his father in 457. He had continually to fight with his brothers and with the Ephthalites in Bactria, and was killed by Peroz in 459.

4. **HORMIZD IV.**, son of Chosroes I., reigned 578-590. He seems to have been imperious and violent, but not without some kindness of heart. Some very characteristic stories are told of him by Tabari (Nöldeke, *Geschichte d. Perser und Araber unter den Sasaniden*, 264 ff.). His father's sympathies had been with the nobles and the priests. Hormizd protected the common people and introduced a severe discipline in his army and court. When the priests demanded a persecution of the Christians, he declined on the ground that the throne and the government could only be safe if it gained the goodwill of both concurring religions. The consequence was that he raised a strong opposition in the ruling classes, which led to many executions and confiscations. When he came to the throne he killed his brothers,

according to the oriental fashion. From his father he had inherited a war against the Byzantine empire and against the Turks in the east, and negotiations of peace had just begun with the emperor Tiberius, but Hormizd haughtily declined to cede anything of the conquests of his father. Therefore the accounts given of him by the Byzantine authors, Theophylact, Simocatta (iii. 16 ff.), Menander Protector and John of Ephesus (vi. 22), who give a full account of these negotiations, are far from favourable. In 588 his general, Bahram Chobin, defeated the Turks, but in the next year was beaten by the Romans; and when the king superseded him he rebelled with his army. This was the signal for a general insurrection. The magnates deposed and blinded Hormizd and proclaimed his son Chosroes II. king. In the war which now followed between Bahram Chobin and Chosroes II. Hormizd was killed by some partisans of his son (590).

5. HORMIZD V. was one of the many pretenders who rose after the murder of Chosroes II. (628). He maintained himself about two years (631, 632) in the district of Nisibis. (Ed. M.)

HORMUZ (*Hurmus*, *Ormuz*, *Ormus*), a famous city on the shores of the Persian Gulf, which occupied more than one position in the course of history, and has now long practically ceased to exist. The earliest mention of the name occurs in the voyage of Nearchus (325 B.C.). When that admiral beached his fleet at the mouth of the river Anamis on the shore of Harmozia, a coast district of Carmania, he found the country to be kindly, rich in every product except the olive. The Anamis appears to be the river now known as the Minab, discharging into the Persian Gulf near the entrance of the latter. The name Hormuz is derived by some from that of the Persian god Hormuzd (Ormazd), but it is more likely that the original etymology was connected with *khurma*, "a date"; for the meaning of Mughistan the modern name of the territory Harmozia is "the region of date-palms." The foundation of the city of Hormuz in this territory is ascribed by one Persian writer to the Sassanian Ardashir Babagan (c. 230 A.D.). But it must have existed at an earlier date, for Ptolemy takes note of Ἀρμωζία πόλις (vi. 8).

Hormuz is mentioned by Idrisi, who wrote c. 1150, under the title of Hormuz-al-sahillah, "Hormuz of the shore" (to distinguish it from inland cities of the same name then existing), as a large and well-built city, the chief mart of Kirman. Siraf and Kish (Kais), farther up the gulf, had preceded it as ports of trade with India, but in the 13th century Hormuz had become the chief seat of this traffic. It was at this time the seat also of a petty dynasty of kings, of which there is a history by one of their number (Turán Shah); an abstract of it is given by the Jesuit Teixeira. According to this history the founder of the dynasty was Shah Mohammed Dirhem-Kub ("the Drachma-coiner"), an Arab chief who crossed the gulf and established himself here. The date is not given, but it must have been before 1100 A.D., as Ruknuddin Mahmud, who succeeded in 1246, was the twelfth of the line. These princes appear to have been at times in dependence necessarily on the atabegs of Fars and on the princes of Kirman. About the year 1300 Hormuz was so severely and repeatedly harassed by raids of Tatar horsemen that the king and his people abandoned their city on the mainland and transferred themselves to the island of Jerun (Organa of Nearchus), about 12 m. westward and 4 m. from the nearest shore.

The site of the continental or ancient Hormuz was first traced in modern times by Colonel (Sir Lewis) Pelly when resident at Bushire. It stands in the present district of Minab, several miles from the sea, and on a creek which communicates with the Minab river, but is partially silted up and not now accessible for vessels. There remain traces of a long wharf and extensive ruins. The new city occupied a triangular plain forming the northern part of the island, the southern wall, as its remains still show, being about 2 m. in extent from east to west. A suburb with a wharf or pier, called Turán Bagh (garden of Turán) after one of the kings, a name now corrupted to Trumpak, stood about 3 m. from the town to the south-east.

Odoric gives the earliest notice we have of the new city (c. 1320). He calls it Ormes, a city strongly fortified and abounding in costly wares, situated on an island 5 m. distant from the main, having no trees and no fresh water, unhealthy and (as all evidence confirms) incredibly hot. Some years later it was visited more than once by Ibn Batuta, who seems to speak of the old city as likewise still standing. The new Hormuz, called also Jerun (*i.e.* still retaining the original name of the island), was a great and fine city rising out of the sea, and serving as a mart for all the products of India, which were distributed hence over all Persia. The hills on the island were of rock-salt, from which vases and pedestals for lamps were carved. Near the gate of the chief mosque stood an enormous skull, apparently that of a sperm-whale. The king at this time was Kutbuddin Tahamtan, and the traveller gives a curious description of him, seated on the throne, in patched and dirty raiment, holding a rosary of enormous pearls, procured from the Bahrein fisheries, which at one time or another belonged, with other islands in the gulf and on the Oman shores from Ras-el-had (C. Rosalga of the Portuguese) on the ocean round to Julfar on the gulf, to the princes of Hormuz. Abdurazzak, the envoy of Shah Rukh on his way to the Hindu court of Vijayanagar, was in Hormuz in 1442, and speaks of it as a mart which had no equal, frequented by the merchants of all the countries of Asia, among which he enumerates China, Java, Bengal, Tenasserim, Shahr-I-nao (*i.e.* Siam) and the Maldives. Nikitia, the Russian (c. 1470), gives a similar account; he calls it "a vast emporium of all the world."

In September 1507 the king of Hormuz, after for some time bearing of the terrible foe who was carrying fire and sword along the shores of Arabia, saw the squadron of Alphonso d'Albuquerque appear before his city, an appearance speedily followed by extravagant demands, by refusal of these from the ministers of the young king, and by deeds of matchless daring and cruelty on the part of the Portuguese, which speedily broke down resistance. The king acknowledged himself tributary to Portugal, and gave leave to the Portuguese to build a castle, which was at once commenced on the northern part of the island, commanding the city and the anchorage on both sides. But the mutinous conduct and desertion of several of Albuquerque's captains compelled him suddenly to abandon the enterprise; and it was not till 1514, after the great leader had captured Goa and Malacca, and had for five years been viceroy, that he returned to Hormuz (or Ormuz, as the Portuguese called it), and without encountering resistance to a name now so terrible, laid his grasp again on the island and completed his castle. For more than a century Hormuz remained practically in the dominions of Portugal, though the hereditary prince, paying from his revenues a tribute to Portugal (in lieu of which eventually the latter took the whole of the customs collections), continued to be the instrument of government. The position of things during the Portuguese rule may be understood from the description of Cesare de' Federici, a Venetian merchant who was at Hormuz about 1565. After speaking of the great trade in spices, drugs, silk and silk stuffs, and pearls of Bahrein, and in horses for export to India, he says the king was a Moor (*i.e.* Mahomedan), chosen by and subordinate to the Portuguese. "At the election of the king I was there and saw the ceremonies that they use . . . The old king being dead, the captain of the Portugals chooseth another of the blood-royal, and makes this election in the castle with great ceremony. And when he is elected the captain sweareth him to be true . . . to the K. of Portugal as his lord and governor, and then he giveth him the sceptre regal. After this . . . with great pomp . . . he is brought into the royal palace in the city. The king keeps a good train and hath sufficient revenues. . . . because the captain of the castle doth maintain and defend his right . . . he is honoured as a king, yet he cannot ride abroad with his train, without the consent of the captain first had" (in Hakluyt).¹

¹ In Barros, *Dec. II.* book x. c. 7, there is a curious detail of the revenue and expenditure of the kingdom of Ormuz, which would seem to exhibit the former as not more than £100,000.

The rise of the English trade and factories in the Indian seas in the beginning of the 17th century led to constant jealousies and broils with the Portuguese, and the successful efforts of the English company to open traffic with Persia especially embittered their rivals, to whom the possession of Hormuz had long given a monopoly of that trade. The officers of Shāh Abbās, who looked with a covetous and resentful eye on the Portuguese occupation of such a position, were strongly desirous of the aid of English ships in attacking Hormuz. During 1620 and 1621 the ships of Portugal and of the English company had more than once come to action in the Indian seas, and in November of the latter year the council at Surat had resolved on what was practically maritime war with the Portuguese flag. There was hardly a step between this and the decision come to in the following month to join with "the duke of Shirāz" (Imām Kōlf Khān, the governor of Fars) in the desired expedition against Hormuz. There was some pretext of being forced into the alliance by a Persian threat to lay embargo on the English goods at Jashk; but this seems to have been only brought forward by the English agents when, at a later date, their proceedings were called in question. The English crews were at first unwilling to take part in what they justly said was "no merchandizing business, nor were they engaged for the like," but they were persuaded, and five English vessels aided, first, in the attack of Kishm, where (at the east end of the large island so called) the Portuguese had lately built a fort,¹ and afterwards in that of Hormuz itself. The latter siege was opened on the 18th of February 1622, and continued to the 1st of May, when the Portuguese, after a gallant defence of ten weeks, surrendered. It is to be recollected that Portugal was at this time subject to the crown of Spain, with which England was at peace; indeed, it was but a year later that the prince of Wales went on his wooing adventure to the Spanish court. The irritation there was naturally great, though it is surprising how little came of it. The company were supposed (apparently without foundation) to have profited largely by the Hormuz booty; and both the duke of Buckingham and the king claimed to be "sweetened," as the record phrases it, from this supposed treasure. The former certainly received a large bribe (£10,000). The conclusion of the transaction with the king was formerly considered doubtful; but entries in the calendar of East India papers seem to show that James received an equal sum.²

Hormuz never recovered from this blow. The Persians transferred their establishments to Gombroon on the mainland, about 12 m. to the north-west, which the king had lately set up as a royal port under the name of Bander Abbāsi. The English stipulations for aid had embraced an equal division of the customs duties. This division was apparently recognized by the Persians as applying to the new Bander, and, though the trade with Persia was constantly decaying and precarious, the company held to their factory at Gombroon for the sake of this claim to revenue, which of course was most irregularly paid. In 1683-1684 the amount of debt due to the company in Persia, including their proportion of customs duties, was reckoned at a million sterling. As late as 1690-1691 their right seems to have been admitted, and a payment of 3495 sequins was received by them on this account. The factory at Gombroon lingered on till 1759, when it was seized by two French ships of war under Comte d'Estaing. It was re-established, but at the time of Niebuhr's visit to the gulf a few years later no European remained. Niebuhr mentions that in his time (c. 1765) Mulla 'Alī Shāh, formerly admiral of Nādir Shāh, was established on the island of Hormuz and part of Kishm as an independent chief.

See also Barros, *Asia: Commentaries of Albuquerque*, trans. by Birch (Hak. Society); *Relaciones de Pedro Texeira* (Antwerp, 1610); Narratives in Hakluyt's *Collection* (reprint in 1809, vol. ii.) and in Purchas's *Pilgrims*, vol. ii.; Pietro della Valle, *Persia*, lett. xlii-xlvii.; *Calendar of E. I. Papers*, by Sainsbury, vol. iii.; Ritter, *Erkunde*, xii.; *Jour. Roy. Geog. Soc.*, Kemphorne in vol. v., White-

¹ The attack on Kishm was notable in that one of the two Englishmen killed there was the great navigator Baffin.

² *Colonial Series, E. Indies*, by Sainsbury, vol. iii. *passim*, especially see pp. 296 and 329.

locke in vol. viii., Pelly in vol. xxxiv.; Fraser, *Narrative of a Journey into Khorasan* (1825); Constable and Stiffe, *Persian Gulf Pilot* (1864); Bruce, *Annals of the E. I. Company*, &c. (1810). (H. V.)

The island has a circumference of 16 m. and its longest axis measures 4½ m. The village is in 27° 6' N., 56° 20' E. The Portuguese fort still stands, but is sadly out of repair and much of its western wall has been undermined and washed away by the action of the sea. It is a bastioned fort with orillons and loopholed casemates under the ramparts and was separated from the town by a deep moat, now silted up, cut E.-W. across the isthmus and crossed by a bridge. It has three cisterns for collecting rainwater; two are 17-18 ft. deep, have a capacity of about 60,000 gallons and are covered by arched roofs supported on six stone pillars. The third cistern is smaller and has no roof. Five rusty old iron guns are lying prone on the roof; six others on the strand before the village are used for fastening boats, another serves as a socket for a flagstaff before the representative of the government. The island is under the jurisdiction of the governor of the Persian Gulf ports who resides at Bushire. Of the old city hardly anything stands except a minaret, 70 ft. high, with a winding staircase inside and much worn away at the base, part of a former mosque used by the Portuguese as a lighthouse, but the traces of buildings, massive foundations constructed of stone quarried in the hills on the island, of many cisterns (some say 300), &c. are numerous and extensive. The modern settlement, situated south of the fort on the eastern shore, has a population of about 1000 during the cool season, but less in the hot season, when many people go over to Minab on the mainland to the east. Most of the people live in huts constructed of the branches and leaves of the date palm. They own about sixty small sailing vessels trading to Muscat and other ports and also do some pearl-fishing. At Turan Bagh on the east coast 4½ m. S.E. of the fort are some considerable ruins, irrigation canals, an extensive burial ground and some huts occupied by a few families who cultivate a small garden on a terrace supported by old retaining walls. On a hill near the shore 1½ m. S.E. of the fort is the ruin of a small chapel called "Santa Lucia" on an old map in Astley's *Collection of Voyages*, and on the summit of a salt hill 1½ m. south of the fort are the remains of another chapel called "N.S. de la Pena" on the same map, and a "Monastery" in a sketch of Hormuz made by David Davies, a mate on board the East India Company's ship "Discovery" in 1627. With the exception of the northern part, where the old city stood, and the little patch at Turan Bagh, the island is covered with reddish brown hills with sharp serrated ridges composed of gypsum, rock-salt and clay. These hills, which do not exceed 300 ft. in height, are broken through in four places by conical, whitish peaks of volcanic rocks (greenstone, trachyte); the highest of these peaks with an altitude of 600 ft. is situated almost in the centre of the island.

The island has extensive beds of red ochre in which nodules of very pure hematite are often found. The ochre, here called *gilek*, has been an important article of export for centuries³ and great quantities of it are exported at the present time to England (in 1906-1907, 10,000 tons; local price 27s. the ton). The climate of Hormuz, although hot, is, according to medical experts, the best in the Persian Gulf. Rain falls in January, February and March, and the annual rainfall is said to be about the same as that of Bushire, 12 to 13 in.

Capt. A. W. Stiffe in *Geogr. Mag.* (April 1874); William Foster in *Geogr. Journal* (Aug. 1894); writer's notes taken on island. (A. H.-S.)

HORN, ARVID BERNHARD, Count (1664-1742), Swedish statesman, was born at Vuorentaka in Finland on the 6th of April 1664, of a noble but indigent family. After completing his studies at Åbo, he entered the army and served for several years in the Netherlands, in Hungary under Prince Eugene, and in Flanders under Waldeck (1690-1695). He stood high

³ "Reddle or Red Ochre from the Forest of Dean in Gloucestershire is very little inferior to the Sort brought from the Island of Ormuz in the Persian Gulph and so much valued and used by our Painters under the name of Indian Red" (Sir John Hill, *Theophrastus's History of Stones*, London, 1774).

in the favour of the young Charles XII. and was one of his foremost generals in the earlier part of the great Northern War. In 1704 he was entrusted with his first diplomatic mission, the deposition of Augustus II. of Poland and the election of Stanislaus I., a mission which he accomplished with distinguished ability but absolute unscrupulousness. Shortly afterwards he was besieged by Augustus in Warsaw and compelled to surrender. In 1705 he was made a senator, in 1706 a count and in 1707 governor of Charles XII.'s nephew, the young duke Charles Frederick of Holstein-Gottorp. In 1710 he succeeded Nils Gyldenstolpe as prime minister. Transferred to the central point of the administration, he had ample opportunity of regarding with other eyes the situation of the kingdom, and in consequence of his remonstrances he fell rapidly in the favour of Charles XII. Both in 1710 and 1713 Horn was in favour of summoning the estates, but when in 1714 the diet adopted an anti-monarchical attitude, he gravely warned and ultimately dissolved it. In Charles XII.'s later years Horn had little to do with the administration. After the death of Charles XII. (1718) it was Horn who persuaded the princess Ulrica Leonora to relinquish her hereditary claims and submit to be elected queen of Sweden. He protested against the queen's autocratic behaviour, and resigned both the premiership and his senatorship. He was elected *landmarskalk* at the diet of 1720, and contributed, on the resignation of Ulrica Leonora, to the election of Frederick of Hesse as king of Sweden, whose first act was to restore to him the office of prime minister. For the next eighteen years he so absolutely controlled both the foreign and the domestic affairs of Sweden that the period between 1720 and 1738 has well been called the Horn period. His services to his country were indeed inestimable. His strong hand kept the inevitable strife of the parliamentary factions within due limits, and it was entirely owing to his provident care that Sweden so rapidly recovered from the wretched condition in which the wars of Charles XII. had plunged her. In his foreign policy Horn was extremely wary and cautious, yet without compromising either the independence or the self-respect of his country. He was, however, the promoter of a new principle of administration which in later days proved very dangerous to Sweden under ministers less capable than he was. This was to increase the influence of the diet and its secret committees in the solution of purely diplomatic questions, which should have been left entirely to the executive, thus weakening the central government and at the same time facilitating the interference of foreign Powers in Sweden's domestic affairs. Not till 1731 was there any appearance of opposition in the diet to Horn's "system"; but Horn, piqued by the growing coolness of the king, the same year offered his resignation, which was not accepted. In 1734, however, the opposition was bold enough to denounce his neutrality on the occasion of the war of the Polish Succession, when Stanislaus I., again appeared upon the scene as a candidate for the Polish throne; but Horn was still strong enough to prevent a rupture with Russia. Henceforth he was bitterly but unjustly accused of want of patriotism, and in 1738 was compelled at last to retire before the impetuous onslaught of the triumphant young Hat party. For the rest of his life he lived in retirement at his estate at Ekebyholm, where he died on the 17th of April 1742. Horn in many respects greatly resembled his contemporary Walpole. The peculiar situation of Sweden, and the circumstances of his time, made his policy necessarily opportunistic, but it was an opportunism based on excellent common sense.

See V. E. Svedelius, *Arvid Bernard Horn* (Stockholm, 1879); R. N. Bain, *Gustavus III.*, vol. i. (London, 1894), and *Charles XII.* (1895). C. F. Horn, *A. B. Horn: hans lifnad* (Stockholm, 1852). (R. N. B.)

HORN, PHILIP DE MONTMORENCY, COUNT OF (1518-1568), a man of illustrious descent and great possessions in the Netherlands, became in succession under Charles V. and Philip II. stadtholder of Gelderland, admiral of Flanders and knight of the Golden Fleece. In 1559 he commanded the stately fleet which conveyed Philip II. from the Netherlands to Spain, and he remained at the Spanish court till 1563. On his return he placed himself with the prince of Orange and Count Egmont

at the head of the party which opposed the policy of Cardinal Granvella. When Granvella retired the three great nobles continued to resist the introduction of the Spanish Inquisition and of Spanish despotic rule into the Netherlands. But though Philip appeared for a time to give way, he had made up his mind to visit the opponents of his policy with ruthless punishment. The regent, Margaret, duchess of Parma, was replaced by the duke of Alva, who entered the Netherlands at the head of a veteran army and at once began to crush all opposition with a merciless hand. Orange fled from the country, but Egmont and Horn, despite his warning, decided to remain and face the storm. They were both seized, tried and condemned as traitors, and were executed on the 5th of June 1568 in the great square before the town hall at Brussels.

See biographical notices in A. J. van der Aa, *Biographisch Woordenboek der Nederlanden* (Haarlem, 1851-1879); J. Kok, *Vaderlandsch Woordenboek* (Amsterdam, 1785-1799); also bibliography to chap. vi. vii. and xix. in *Cambridge Modern History*, vol. iii. pp. 798-809 (1904).

HORN, English hero of romance. *King Horn* is a heroic poem or gest of 1546 lines dating from the 13th century. Murry (or Allof), king of Sudene¹ (Surrey and Sussex?) is slain by Saracen pirates who turn his son Horn adrift with twelve other children. The boat drifts to Westernesse² (Cornwall?), where the children are received by King Aylmer (Aethelmaer). Presently Horn is denounced by one of his companions as the lover of the king's daughter Rymenhild (Rimel) and is banished, taking with him a ring, the gift of his bride and a talisman against danger. In Ireland, under the name of Godmod, he serves for seven years, and slays in battle the Saracens who had killed his father. Learning that Rymenhild is to be married against her will to King Mody, he returns to Westernesse disguised as a palmer, and makes himself known to the bride by dropping the ring into the cup she offers him, with the words "Drink to Horn of Horn." He then reconquers his father's kingdom and marries Rymenhild.

The other versions of the story, which are founded on a common tradition, but are not immediately dependent on one another, are: (1) the longer French romance of *Horn et Rymenhild* by "meistre Thomas," describing more complex social conditions than those of the English poem; (2) a slightly shorter Middle English poem, *Horn Child and Maiden Rymild*; (3) the Scottish ballad of "Hind Horn"; (4) a prose romance founded on the French Horn, entitled *Pontus et Sidoine* (Lyons, 1480, Eng. trans. pr. by Wynklyn de Worde, 1511; German trans. Augsburg, 1483).

There is a marked resemblance between the story of Horn and the legend of Havelok the Dane, and it is interesting to note how closely Richard of Ely followed the Horn tradition in the 12th century *De gestis Herewardi Saxonis*. Hereward also loves an Irish princess, flees to Ireland, and returns in time for the bridal feast, where he is presented with a cup by the princess. The orphaned prince who recovers his father's kingdom and avenges his murder, and the maid or wife who waits years for an absent lover or husband, and is rescued on the eve of a forced marriage, are common characters in romance. The second of these motives, with almost identical incidents, occurs in the legend of Henry the Lion, duke of Brunswick; it is the subject of ballads in Swedish, Danish, German, Bohemian, &c., and of a *Historia* by Hans Sachs, though some magic elements are added; it also occurs in the ballad of *Der edle Heringer* (14th century), well known in Sir Walter Scott's translation; in the story of Torello in the *Decameron* of Boccaccio (10th day, 9th tale); and with some variation in the Russian tale of Dobrynya and Nastasya.

King Horn was re-edited for the Early English Text Soc. by C. H. McKnight in 1901; *Horn et Rymenhild* was edited with the English versions for the Bannatyne Club by F. Michel (Paris, 1845); *Horn Child and Maiden Rymild* in J. Ritson's *Metrical Romances*, vol. iii.; and "Hind Horn" in F. J. Child's *English and Scottish*

¹ There was a barrow in the Isle of Purbeck, Dorsetshire, called Hornsbeorh; and there are other indications which point to a possible connexion between Horn and Dorset (see H. L. Ward, *Cat. of Romances*, i. 451).

² Sudene and Westernesse are tentatively identified also with Isle of Man and Wirral (*Cambridge Hist. of Eng. Lit.*, i. 304).

Popular Ballads (vol. i., 1882), with an introductory note on similar legends. See also H. L. Ward, *Catalogue of Romances*, vol. i., where the relation between Havelok and Horn is discussed; *Hist. litt. de la France* (vol. xxii., 1852); W. Söderhjelm, *Sur l'identité du Thomas auteur de Tristan et du Thomas auteur de Horn* (Romania, xv., 1886); T. Wissmann, "King Horn" (1876) and "Das Lied von King Horn" (1881) in Nos. 16 and 45 of *Quellen und Forschungen zur Spr. und Culturgesch. d. german. Völker* (Strassburg and London); *Reinfrid von Braunschweig*, a version of the legend of Henry the Lion, edited by K. Bartsch (Stuttgart, 1871); and a further bibliography in O. Hartenstein, *Studien zur Hornsage* (Heidelberg, 1902).

HORN (a common Teutonic word, cognate with Lat. *cornu*; cf. Gr. *κέρως*). The weapons which project from the heads of various species of animals, constituting what are known as horns, embrace substances which are, in their anatomical structure and chemical composition, quite distinct from each other; and although in commerce also they are known indiscriminately as horn, their uses are altogether dissimilar. These differences in structure and properties were thus indicated by Sir R. Owen:—"The weapons to which the term horn is properly or technically applied consist of very different substances, and belong to two organic systems, as distinct from each other as both are from the teeth. Thus the horns of deer consist of bone, and are processes of the frontal bone; those of the giraffe are independent bones or 'epiphyses' covered by hairy skin; those of oxen, sheep and antelopes are 'apophyses' of the frontal bone, covered by the corium and by a sheath of true horny material; those of the prong-horned antelope consist at their basis of bony processes covered by hairy skin, and are covered by horny sheaths in the rest of their extent. They thus combine the character of those of the giraffe and ordinary antelope, together with the expanded and branched form of the antlers of deer. Only the horns of the rhinoceros are composed wholly of horny matter, and this is disposed in longitudinal fibres, so that the horns seem rather to consist of coarse bristles compactly matted together in the form of a more or less elongated sub-compressed cone." True horny matter is really a modified form of epidermic tissue, and consists of the albuminoid "keratin." It forms, not only the horns of the ox tribe, but also the hoofs, claws or nails of animals generally, the carapace of the tortoises and the armadillos, the scales of the pangolin, porcupine quills, and birds' feathers, &c.

Horn is employed in the manufacture of combs, buttons, the handles of walking-sticks, umbrellas, and knives, drinking-cups, spoons of various kinds, snuff-boxes, &c. In former times it was applied to several uses for which it is no longer required, although such applications have left their traces in the language. Thus the musical instruments and fog signals known as horns indicate their descent from earlier and simpler forms of apparatus made from horn. In the same way powder-horns were spoken of long after they ceased to be made of that substance; to a small extent lanterns still continue to be "glazed" with thin transparent plates of horn.

HORN (Lat. *cornu*; corresponding terms being Fr. *cor*, *trompe*; Ger. *Horn*; Ital. *cornu*), a class of wind instruments primarily derived from natural animal horns (see above), and having the common characteristics of a conical bore and the absence of lateral holes. The word "horn" when used by modern English musicians always refers to the French horn.

Modern horns may be divided into three classes: (1) the short horns with wide bore, such as the bugles (*q.v.*) and the post-horn. (2) The saxhorns (*q.v.*), a family of hybrid instruments designed by Adolphe Sax, and resulting from the adaptation of valves and of a cup-shaped mouthpiece to instruments of the calibre of the bugle. The Flügelhorn family is the German equivalent of the saxhorns. The natural scale of instruments of this class comprises the harmonics from the second to the eighth only. (3) The French horn (Fr. *cor de chasse* or *trompe de chasse*, *cor à pistons*; Ger. *Waldhorn*, *Ventilhorn*; Ital. *corno* or *corno di caccia*), one of the most valuable and difficult wind instruments of the orchestra, having a very slender conical tube wound round in coils upon itself. It consists of four principal parts—the body, the crooks, the slide and the mouthpiece.

(a) The *body* is the main tube, having a bore of the form known as trunco-conical, measuring approximately 7 ft. 4 in. in length, in which the increase in the diameter of the bore is very gradual in proportion to the length, the cone becoming accentuated only near the bell. In the valve horn the bore is only theoretically conical, the extra lengths of tubing attached to the valves being practically cylindrical. The body is coiled spirally, and has at one end a wide-mouthed bell from 11 to 12 in. in diameter having a parabolic curve, and at the other a conical ferrule into which fit the crooks.

(b) The *crooks* (Fr. *corps* or *tons de rechange*; Ger. *Krummbogen*, *Stimmbogen*, *Einsetzbogen*) are interchangeable, spiral tubes, tapering to a diameter of a quarter of an inch at the mouthpiece end and varying in length from 16 in. for the B \flat alto crook to 125 in. for the B \natural basso. Each crook is named according to the fundamental tone which it produces on being added to the body. By lengthening the tube at will the crook lowers the pitch of the instrument, and consequently changes the key in which it stands. Although the harmonic series remains the same for all the crooks, the actual sounds produced by overblowing are lower, the tube being longer, and they now belong to the key of the crook. The principle of the crook was known early in the 17th century; it had been applied to the trumpet, trombone and Jägertrummel¹ before being adapted to the horn. Crooks are merely transposing agents; they are powerless to fill up the gaps in the scale of the horn in order to make it a chromatic or even a diatonic instrument, for they require time for adjustment. The principle of the crook doubtless suggested to Stölzel the system of valves, which is but an instantaneous application of the general principle to the individual notes of the harmonic series, each of which is thereby lowered a semitone, a tone or a tone and a half, as long as the valve remains in operation. The body of the horn without crooks is of the length to produce 8 ft. C., and forms the standard, being known as the alto horn in C, which is the highest key in which the horn is pitched. The notes are sounded as written.

(c) The *mouthpiece* of the horn differs substantially from that of the trumpet.² There is, strictly speaking, no cup, the inside of the mouthpiece being, like the bore of the instrument itself, in the form of a truncated cone or funnel. Like the other parts of this difficult and complex instrument, the proportions of the mouthpiece must bear a certain undefined relation to the length and diameter of the column of air. The choice of a suitable mouthpiece is in fact a test of skill; the shape of the lip of the performer and the more special use he may wish to make of either the higher or the lower harmonics have to be taken into consideration. In orchestral music the part for first horns naturally calls for the use of the higher harmonics, which are more easily obtained by means of a somewhat smaller and shallower mouthpiece³ than that used upon the second horn, which is called upon to dwell more on the lower harmonics.

(d) The *tuning slides* (Fr. *coulisses*; Ger. *Stimmbogen*) consist of a pair of sliding U-shaped tubes fitting tightly into each other, by means of which the instrument can be brought strictly into tune, and which also act as compensators with the crooks. On these tuning slides, placed across the ring formed by the coils of the valve-horn, are fixed the pistons with their extra lengths of tubing; as the connexion of the pistons with the body of the horn is made through the slides, the value of the latter as compensators will be readily understood. Those accustomed to deal with instruments having fixed notes, such as the piano and harp, hardly realize the extreme difficulties which confront both maker and performer in intricate wind instruments such as the horn, on which no sounds can be produced without conscious adjustment of lips and breath, and but few without the additional use of some such contrivance as slide, crook, piston or of the hand in the bell, in the case of the natural or hand horn.

The production of sound in wind instruments has a fourfold object: (1) pitch; (2) range or scale of available notes; (3) quality of tone or *timbre*; (4) dynamic variation, or *Acoustics*, crescendo and diminuendo. The pitch of the horn, as of other wind instruments, depends almost exclusively on the length of the air-column set in vibration, and remains practically uninfluenced by the diameter of the bore. In the case of conical tubes in which the difference in diameter at the two extremities, mouthpiece and bell, is very great, as in the horn, the pitch of the tube will be slightly higher than its theoretical length would warrant.⁴ When, for instance, three tubes of the same length are sounded—No. 1, conical diverging; No. 2,

¹ See Michael Praetorius, *De organographia* (Wolfenbüttel, 1618), tab. viii., where crooks for lowering the key by one tone on trumpet and trombone are pictured.

² See Victor Mahillon, *Les Éléments d'acoustique musicale et instrumentale* (Brussels, 1874), pp. 96, 97, &c.; Friedrich Zamminer, *Die Musik und die musikalischen Instrumente* (Gießen, 1855), p. 310, where diagrams of the mouthpieces are given.

³ See Joseph Fröhlich, *Vollständige theoretisch-praktische Musikschule* (Bonn, 1811), iii. 7, where diagrams of the two mouthpieces for first and second horn are given.

⁴ See Gottfried Weber, "Zur Akustik der Blasinstrumente," in *Allgemeine musikalische Zeitung* (Leipzig, 1816), p. 38.

conical converging in the direction from mouthpiece to bell; No. 3, cylindrical—No. 1 gives a fundamental tone somewhat higher, No. 2 somewhat lower, than No. 3. Victor Mahillon¹ adds that the rate of vibration in such conical tubes as the horn is slightly less than the rate of vibration in ambient air; therefore, as the rate of vibration (i.e. the number of vibrations per second) varies in the inverse ratio with the length of the tube, it follows that the practical length of the horn is slightly less than the theoretical, the difference for the horn in B \flat normal pitch amounting to 13.9 cm. (approximately $5\frac{1}{2}$ in.).

The tube of the horn behaves as an open pipe. E. F. F. Chladni² states that the mouthpiece end is to be considered as open in all wind instruments (excepting reed instruments), even when, as in horns and trumpets, it would seem to be closed by the lips. Victor Mahillon, although apparently holding the opposite view, and considering as closed the tubes of all wind instruments played by means of reeds, whether single or double, or by the lips acting as reeds, gives a new and practical explanation of the phenomenon.³ The result is the same in both cases, for the closed pipe of trunco-conical bore, whose diameter at the bell is at least four times greater than the diameter at the mouthpiece, behaves in the same manner, when set in vibration by a reed, as an open pipe, and gives the consecutive scale of harmonics.⁴

In order to produce sound from the horn, the performer, stretching his lips across the funnel-shaped mouthpiece from rim to rim, blows into the cavity. The lips, vibrating as the breath passes through the aperture between them, communicate pulsations or series of intermittent shocks to the thin stream of air, known as the exciting current, which, issuing from them, strikes the column of air in the tube, already in a state of stationary vibration.⁵ The effect of this series of shocks, without which there can be no sound, upon the column of air confined within the walls of the tube is to produce sound-waves, travelling longitudinally through the tube. Each sound-wave consists of two half-lengths, one in which the air has been compressed or condensed by the impulse or push, the second in which, the push being spent, the air again dilates or becomes rarefied. In an open pipe, the wave-length is theoretically equal to the length of the tube. The pitch of the note depends on the frequency per second with which each vibration or complete sound-wave reaches the drum of the ear. The longer the wave the lower the frequency. The velocity of the wave is independent of its length, being solely conditioned by the rate of vibration of the particles composing the conveying medium: while one individual particle performs one complete vibration, the wave advances one wave-length.⁶ The rate of particle vibration or frequency is therefore inversely proportional to the corresponding wave-length.⁷ Sound-waves generated by the same exciting current travel with the same velocity whatever their length, the difference being the frequency number and therefore the pitch of the note. As long as the performer blows with normal force, the same length of tube produces the same wave-length and therefore the same frequency and pitch. By "blowing with normal force" is understood the proper relative proportions to be maintained between the wind-pressure and the lip-tension—a ratio which is found instinctively by the performer but was only suspected by the older writers.⁸ If the shocks or vibrations initiated by the lips through the medium of the exciting current be sharper owing to the increased tension of the lips, and at the same time succeed each other with greater velocity, the wave-length breaks up, and two, three or more proportionally shorter

complete waves form instead of one, and traverse the pipe within the same space of time, producing sounds proportionally higher by an octave, a twelfth, &c., according to the character of the initiatory disturbance. We may therefore add this proposition: the rate of vibration of a tube varies as the number of segments into which the vibrating column of air within it is divided. In order to obtain the fundamental, the performer's lips must be loose and the wind-pressure gentle but steady, so that the exciting current may issue forth in a broad, slow stream. To set in vibration a column of air some 16 or 17 ft. long is a feat of extreme difficulty; that is why it is quite exceptional to find a horn-player who can sound the fundamental on the low C or B \flat *basso* horn. In the organ, where even a 32 ft. tone is obtained, the wind-pressure and the lip-opening controlling the exciting current are mechanically regulated for each length of pipe—only one note being required from each. In order, therefore, to induce the column of air within the tube to break up and vibrate in aliquot parts, the exciting current must be compressed into an ever finer, tenser and more incisive stream. There is in fact a certain minimum pressure for each degree of tension of the lips below which no harmonic can be produced.

It is often stated that the harmonics are obtained by increasing the tension of the lips and a crescendo by increasing the pressure of the breath.⁹ Victor Mahillon¹⁰ accounts for the harmonics by increased wind-pressure only. It is evident that the greater the tension of the lips, the greater the force of wind required to set them vibrating; therefore the force and velocity of the air must vary with the tension of the lips in order to produce a steady or musical sound. D. J. Blaikley considers that the ratio of increase in lips and breath follows that of the harmonic series. The tension of the lips has the effect of reducing the width of the slit or aperture between them and the width of the exciting current. While increasing its density the energy of the wind must, therefore, either expend itself in increasing the rate of vibration, or frequency of the pulses, which influences the pitch of the note; or else in increasing the extent of excursion or amplitude of the vibrations, which influences the dynamic force of the sound or loudness.¹¹ If the aperture be narrowed without providing a proportional increase of wind-pressure, the harmonic overtone may be heard, but either the intonation will suffer or the intensity of the tone will be reduced, because the force required to set the tenser membrane in vibration is insufficient to give the vibrations the requisite amplitude as well as the frequency. If the force expended be excessive, i.e. more than the maximum required to ensure the increased frequency proportional to the increased tension, the superfluous energy must expend itself in increasing the amplitude of the vibrations so that a note of a greater degree of loudness as well as of higher pitch will be produced. The converse is equally true; the lower the pitch of the note the slower the pulses or vibrations and therefore the looser the lip and the gentler the force of current required to set them vibrating. To draw a parallel from organ-pipes: as long as even wind-pressure is maintained, the mouthpiece being fixed proportional to the length of tube, the pipe gives out one note of unvarying dynamic intensity; increase the pressure of the wind and harmonics are heard, but it is impossible to obtain a crescendo unless the mouthpiece be dispensed with and a free reed (p. 2) adapted.

Reference has already been made above to the difficulty of obtaining the fundamental on tubes of great length and narrow bore like the horn. The useful compass of the horn, therefore, begins with the note that an open pipe half its length would give; the Germans term instruments of such small calibre *half instruments*, and those of wide calibre, such as bugles and tubas, *whole instruments*,¹² since in them the whole of the length of the tube is available in practice.

The harmonic series of the horn, or the open notes obtainable without using valves or crooks, is written as for the alto horn in C of 8 ft. tone, which forms the standard of notation. Notes written in the bass clef are generally, for some unexplained reason, placed an octave lower than the real sounds.

Written. Sounded.

Written and sounded.

Very difficult.

¹ See A. Ganot, *Elementary Treatise on Physics*, translated by E. Atkinson (16th ed., London, 1902), p. 266, § 282. "In the horn different notes are produced by altering the distance of the lips." Such a vague and misleading statement is worse than useless. See also Poynting and Thomson, *op. cit.* p. 113.

² "Le Cor," p. 22; p. 11, § 18; pp. 6 and 7, § 8.

³ The phraseology alone is here borrowed from Sedley Taylor, (*op. cit.* p. 55), who does not enter into the practical application of the theory he expounds so clearly.

⁴ See Dr. Emil Schalkhant's article on musical instruments, § iv. of *Bericht der Beurtheilungs Commission bei der Allg. Deutschen Industrie Ausstellung, 1854* (Munich, 1855), pp. 169-170; also F. Zaminer, *op. cit.*

¹ *Les Instruments de musique au musée du Conservatoire royal de musique de Bruxelles*, "Instruments à vent," ii., "Le Cor, son histoire, sa théorie, sa construction" (Brussels and London, 1907), p. 28.

² *Die Akustik* (Leipzig, 1802), p. 86, § 72.

³ *Op. cit.* p. 13, § 20, and p. 15, §§ 24 and 25. This apparent discrepancy between an early and a modern authority on the acoustics of wind instruments is easily explained. Chladni, when speaking of open and closed pipes, refers to the standard cylindrical and rectangular organ-pipes, Mahillon, on the other hand, draws a distinction in favour of the conical pipe, demonstrating in a practical manner how, given a certain calibre, the conical pipe must overblow the harmonics of the open pipe, whatever the method of producing the sound.

⁴ See Gottfried Weber, *loc. cit.*

⁵ See Ernst Heinrich and Wilhelm Weber, *Wellenlehre* (Leipzig, 1825), p. 519, § 281, and *A Text-Book of Physics*, part. ii., "Sound," by J. H. Poynting and J. J. Thomson (London, 1906), pp. 104 and 105.

⁶ See Sedley Taylor, *Sound and Music* (1896), p. 21.





⁷ *Id.* pp. 23-25.

⁸ See Gottfried Weber, *op. cit.*, pp. 39-41, and Ernst H. and Wilhelm Weber, *op. cit.* p. 522, end of § 285.

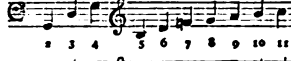

All the crooks, a list of the principal of which is appended, therefore necessarily give real sounds lower than the above series according to their individual length.

French horns are made with either two or three valves. To the first valve is attached sufficient length of tubing to lower the pitch of the instrument a tone, so that any note played upon the horn in F

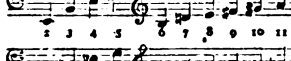
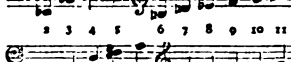
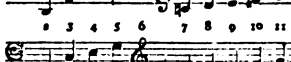
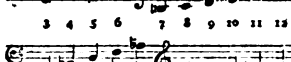
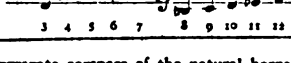
Table of Principal Crooks now in Use.¹

Key of Crook.	Actual Sounds of Range of Useful Harmonics.		Length of Crook in Inches.	Transposes to
B \flat alto		2nd to 10th	16	major 2nd lower
A \natural		2nd to 10th	22 $\frac{1}{2}$	minor 3rd ..
A \flat		2nd to 10th	29 $\frac{1}{2}$	major 3rd ..
G		2nd to 12th	36 $\frac{1}{2}$	perfect 4th ..
F		2nd to 16th	52 $\frac{1}{2}$	perfect 5th ..
E		2nd to 16th	61	minor 6th ..
E \flat		2nd to 16th	70 $\frac{1}{2}$	major 6th ..
D		2nd to 16th	80	minor 7th ..
C basso		3rd to 16th	101	8 ^{va} ..
B \flat basso		3rd to 16th	125	major 9th ..

The practical aggregate compass of the natural horns from B \flat basso at the service of composers therefore ranges (actual sounds)

from  or with 3 valves  from

By means of hand-stopping, i.e. the practice of thrusting the hand into the bell in order to lower the sound by a tone or a semitone, or by the adaptation of valves to the horn, this compass may be rendered chromatic almost throughout the range.

The principle of the valve as applied to wind instruments differs entirely from that of keys. The latter necessitate lateral holes bored through the tube, and when the keys are raised the vibrating column of air within the tube and the ambient air without are set in communication, with the result that the vibrating column is shortened and the pitch of the note raised. The valve system consists of valves or pistons attached to additional lengths of tubing, the effect of which is invariably to lower the pitch, except in the case of valve systems specified as "ascending," tried by John Shaw and Adolphe Sax. Insuperable practical difficulties led to the abandonment of these systems, which in any case were the exception and not the rule. The valves, placed upon the U-shaped slides in the centre of the horn, are worked by means of pistons or levers, opening or closing the windways at will, so that when they are in operation the vibrating column of air no longer takes its normal course along the main tube and directly through the slides, but makes a detour through the extra length of tubing before completing its course. Thus the valves, unlike the keys, do not open any communication with the ambient air. Even authoritative writers² have confused the two principles, believing them to be one and the same.

¹ The measurements are for the high philharmonic pitch $a = 452.4$. V. Mahillon, "Le cor" (p. 32), gives a table of the lengths of crooks in metres.

² Robert Eitner, editor of the *Monatshefte für Musikwissenschaft*, published therein an article in 1881, p. 41 seq., "Wer hat die Ventil-

trumpete erfunden," in which, after referring to the *Klappenwaldhorn* and *Trompete* (keyed horn and trumpet) made by Weidinger and played in public in 1802 and 1813 respectively, he goes on to state that Schilling in his *Lexicon* makes the comical mistake of looking upon the *Klappentrompete* (keyed trumpet) and *Ventiltrompete* (valve trumpet) as different instruments. He accordingly sets matters right, as he thinks, by according to Weidinger the honour of the invention of valves, hitherto wrongfully attributed to Stölzel; and in the *Quellenlexikon* (1904) he leaves out Stölzel's name, and names Weidinger as the inventor of the *Klappen* or *Ventil*, referring readers for further particulars to his article, just quoted, in the *Monatshefte*.

The invention of the valve, although a substantial improvement,

was found to fall short of perfection in its operation on the tubes of wind instruments so soon as the possibility of using the three valves in combination to produce six different positions or series of harmonics was realized, and for the following reason. In order to deepen the pitch one tone by means of valve 1, a length of tubing exactly proportional to the length of the main tube must be thrown into communication with the latter. If, in addition to valve 1, valve 3 be depressed, a further drop in pitch of $1\frac{1}{2}$ tone should be effected; but as the length of tubing added by depressing valve 3 is calculated in proportion to the main tube, and the latter has already been lengthened by depressing valve 1, therefore the additional length supplied by opening valve 3 is now too short to produce a drop of a minor third strictly in tune, and all notes played while valves 1 and 3 are depressed will be too sharp. Means of compensating slight errors in intonation are provided in the U-shaped slides mentioned above.

The *timbre* of the natural horn is mellow, sonorous and rich in harmonics; it is quite distinctive and bears but little resemblance to that of the other members of the brass wind. In listening to its sustained notes one receives the impression of the tone being breathed out as by a voice, whereas the trumpet and trombone produce the effect of a rapid series of concussions, and in the tuba and cornet the concussions, although still striking, are softened as by padding. The *timbre* of the hand-stopped notes is veiled and suggestive of mystery; so characteristic is the *timbre* that passages in the *Rheingold* heard when the magic power of the Tarnhelm reveals itself sound meaningless if the weird chords are played by means of the valves instead of by hand-stopping. The *timbre* of the piston notes is more resonant than that of the open notes, partaking a little of the character of the trombone, which is probably due to the fact that the strictly conical bore of the natural horn has been replaced by a mixed cylindrical and conical as in trumpet and trombone.

The form of the mouthpiece (*q.v.*) at the point where it joins the main bore of the tube must also exercise a certain influence on the form of vibration, which it helps to modify in conjunction with the conformation of each individual horn-player's lip. In the horn the cup of the mouthpiece is shaped like a funnel, the bore converging insensibly into the narrow end of the main conical bore without break or sharp edges as in the mouthpieces, more properly known as cup-shaped, of trumpet and bombard.

The brilliant sonorosity and roundness of the *timbre* of the horn are due to the strength and predominance of the partial tones up to the 7th or 8th. The prevalence of the higher harmonics from the 10th to the 16th, in which the partial tones lie very close together, determines the harsh quality of the trumpet *timbre*, which may be easily imitated on the horn by forcing the sound production and using a trumpet mouthpiece, and by raising the bell, an effect which is indicated by composers by the words "Raise the Bells."¹

The origin of the horn must be sought in remote prehistoric times, when, by breaking off the tip of a short animal horn, one or at best two notes, powerful, rough, unsteady, only *History.* barely approximating to definite musical sounds, were obtained. This was undoubtedly the archetype of the modern families of brass wind instruments, and from it evolved the trumpet, the bugle and the tuba no less than the horn. The common characteristics which link together these widely different modern families of instruments are: (1) the more or less pronounced conical bore, and (2) the property possessed in a greater or lesser degree of producing the natural sounds by what has been termed overblowing the harmonic overtones. If we follow the evolution of the animal horn throughout the centuries, the ultimate development leads us not to the French horn but to the bugle and tuba.

Before civilization had dawned in classic Greece, Egypt, Assyria and the Semitic races were using wind instruments of wood and metal which had left the primitive ram or bugle horn far behind. Even in northern Europe, during the Bronze age (c. 1000 B.C.), prehistoric man had evolved for himself the prototype of the Roman *cornu*, a bronze horn of wide conical bore, bent in the shape of a G. One of these instruments, known among the modern Scandinavian races as *luurs* or *lurs*, found in the peat beds of Denmark and now preserved in the Museum of Northern Antiquities in Copenhagen, has a length of 9.1 m. (about 6 ft. 4 in.). The U-shaped mouthpiece joint is neatly joined to the remainder of the crescent-tube by means of a bronze ring; the bell, which must have rested on the shoulder, consists merely of a flat rim set round the end of the tube. There is therefore no graceful curve in the bell as in the French horn. An exact facsimile of this prehistoric horn has been made by Victor Mahillon of Brussels, who finds that it was in the key of E \flat and easily produces the first eight harmonics of that key. It stands, therefore,

an octave higher than the modern horn in E \flat (which measures some 13 ft.), but on the *sur* the fundamental E \flat can be reached owing to the wider calibre of the bore.²

Among the Romans the wind instruments derived from the horn were well represented, and included well-developed types which do not differ materially from the natural instruments of modern times. The *buccina* developed directly into the trumpet and trombone during the middle ages, losing no characteristic of importance but the bell form, which was performed abandoned when the art of bending hollow tubes was lost after the fall of the Roman Empire. The name clung through all the changes in form and locality to the one type, and still remains at the present day in the German *Posaune* (trombone). There were four instruments known by the name of *cornu* among the Romans: (1) the short animal horn used by shepherds; (2) the longer, semicircular horn, used for signals, and (3) the still longer *cornu*, bent and carried like the *buccina*, which had the wide bore of the modern tuba. But whereas on the *buccina* the higher harmonics were easily obtained, on the *cornu* the natural scale consisted of the first eight harmonics only. The *cornu*, although shorter than the *buccina*, had a deeper pitch and more sonorous tone, for, owing to the wider calibre of the bore, the fundamental was easily reached. In the reliefs on Trajan's Column, where the two instruments may be compared, the wider curve of the *buccina* forms a ready means of identification. In addition to these was (4) the small instrument like the medieval hunting-horn or post-horn, with the single spiral turn similar to one which figures as service badge in many British infantry regiments,³ such as the first battalion of the King's Own Light Infantry. A terra-cotta model, slightly broken, but with the spiral intact, was excavated at Ventoux in France and is at present preserved in the department of Greek and Roman antiquities at the British Museum, having been acquired from the collection of M. Morel.

The *lituus*, or cavalry trumpet of the Romans, consisted of a cylindrical tube, to which was attached a bent horn or conical bell, the whole in the shape of a J. The long, straight Roman tuba was similar to the large, bent *cornu* so far as bore and capabilities were concerned, but more unwieldy. All these wind instruments seem to have been used during the classic Greek and Roman periods merely to sound fanfares, and therefore, in spite of the high degree of perfection to which they attained as instruments, they scarcely possess any claim to be considered within the domain of music. They were signalling instruments, mainly used in war, in hunting and in state or civic ceremonial. Vegetius (A.D. 386) describes these instruments, and gives detailed instructions for the special traditional uses of tuba, *buccina* and *cornu* in the military camp: "Semitrivialia sunt, quae per tubam, aut cornua, aut buccinam dantur. Tuba quae directa est appellatur buccina, quae in semet ipsam aereo circulo flexitur. Cornu quod ex uris agrestibus, argento nescim, temperaturum arte, et spiritu, quem canentis flatus emittit auditor. It will be seen that Vegetius demands a skilled horn-player. These service instruments may all be identified in the celebrated bas-reliefs of Trajan's Column⁴ (fig. 1) and of the Triumphal arch of Augustus at Susa.⁵

Interesting evidence of a collegium cornicinum (guild of horn-players) is furnished by an altar stone in the Roman catacombs, erected to the memory of one "M. Julius victor ex Collegio Laticornium Cornicinum," on which are carved a *lituus*, a *cornu* and a pan's pipe, the *cornu* being similar to those on Trajan's Column.

All three Roman instruments, the tuba, the *buccina* and the *cornu*, had well-formed mouthpieces, differing but little from the modern cup-shaped form in use on the trumpet, the trombone, the tuba, &c.⁶ It would seem that even the short horn is the 4th

¹ See Victor Mahillon, *Catal. descriptif des instruments de musique, &c.*, vol. ii p. 388, No. 1156, where an illustration is given. See also Dr August Hammerich (French translation by E. Beauvair), "Über altnordische Luren" in *Vierteljahrsschrift für Musik-Wissenschaft* x. (1894).

² See Major J. H. L. Archer, *The British Army Records* (London, 1888), pp. 402, &c.

³ *De re militari*, iii. 5 (Basel, 1532). The successive editions and translations of this classic, both manuscript and printed, throughout the middle ages afford useful evidence of the evolution of these three wind instruments.

⁴ See Wilhelm Froehner, *La Colonne Trajane d'après le surmoulage exécuté à Rome en 1861-1862* (Paris, 1872-1874). On pl. 51 is a *cornu* framing the head of a cornic or horn-player. See also the fine plates in Conrad Cichorus, *Die Reliefs der Traianssäule* (Berlin, 1896, &c.).

⁵ Ermanno Ferrero, *L'Arc d'Auguste à Susa* (Segusio, 9-8 B.C.) (Turin, 1901).

⁶ See the mouthpiece on the Pompeian *buccina* preserved in the museum at Naples, reproduced in the article *BUCCINA*. The museums of the conservatoires of Paris and Brussels and the Collection Kraus in Florence possess facsimiles of these instruments; see Victor Mahillon, *Catalogue*, vol. ii. p. 30. Cf. also the pair of bronze Etruscan *cornua*, No. 2734 in the department of Greek and Roman antiquities at the British Museum, which possess well-preserved cup-shaped mouthpieces.

⁷ See Hector Berlioz, *A Treatise on Modern Instrumentation and Orchestration*, translated by Mary Cowden Clarke, new edition revised by Joseph Bennett (1882), p. 141.

century was provided with a mouthpiece,¹ judging from a carved specimen on an ivory *capra* or *pyxis* dating from the period immediately preceding the fall of the Roman Empire, preserved among the precious relics at Xanten.

After the fall of the Roman Empire, when instrumental music had fallen into disrepute and had been placed under a ban by the church,



From Conrad Cichorius, *Die Reliefs der Trojanerstadt*, by permission of Georg Reimer.
FIG. 1.—Roman Cornua and Buccina.

the art of playing upon such highly-developed instruments gradually died out in western Europe. With the disappearance of the civilization and culture of the Romans, the skilled crafts also gradually vanished, and the art of making metal pipes of delicate calibre and of bending them was completely forgotten, and had to be reacquired step by step during the middle ages from the more enlightened East. The names of the instruments and representations of them survived in MSS. and monuments of art, and as long as the West was content to turn to late Roman and Romano-Christian art for its models, no difficulties were created for the future archaeologist. By the time the Western races had begun to express themselves and to develop their own characteristics, in the 11th century, the arts of Persia, Arabia and the Byzantine Empire had laid their mark upon the West, and confusion of models, and more especially of names, ensued. The greatest confusion of all was created by the numerous translations and glosses of the Bible and by the attempts of miniaturists to illustrate the principal scenes. In Revelation, for instance (ch. viii.), the seven angels with their trumpets are diversely represented with long tubas, with curved horns of various lengths, and with the buisine, busaun or posaune, the descendant of the buccina.

We know from the colouring used in illuminated MSS., gold and pale blue, that horns were made of metal early in the middle ages. The metal was not cast in moulds but hammered into shape. Viollet-le-Duc² reproduces a miniature from a MS. of the end of the 13th century (Paris, Bibliothèque du corps Législatif), in which two metal-workers are shown hammering two large horns.

The early medieval horns had no mouthpieces, the narrow end being merely finished with a rim on which the lips rested. The tone



FIG. 2.—Medieval Hunting-Horn with the bugle-horn or bull's horn was extensively used as a signal instrument on land and sea (see BUGLE), by the night-watchmen in cities, in the watch tower of the feudal castle and by foresters and

huntsmen. The hunting horn was generally represented as small in the hunting scenes which abound in illuminated MSS. and early printed books; it was crescent-shaped and was worn slung by a leather strap over one shoulder and resting on the opposite hip. When played it was held with the wide end curving upwards in front of the huntsman's head. A kind of tablature for the horn was in use in France in the 14th century; an example of it is here reproduced (fig. 2) from a 14th-century French MS. treatise on *venerie*.³ Only one note is indicated, the various calls and signals being based chiefly on rhythm, and the notes being left to the taste and skill of the huntsman. The interpretation⁴ of the *Cornure de chasse de veus* seen in the figure is as follows:

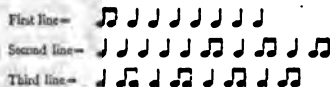

In the first poem is given a list of these signs with the names by which they were known in *venerie*.

In the 16th century in England the hunting-horn sometimes had a spiral turn in the centre, half-way between mouthpiece and bell end; the extra length was apparently added solely in order to lower the pitch, the higher harmonics not being used for the hunting calls. In George Turbeville's *Noble Arte of Venerie* (1576, facsimile reprint, Oxford, 1908) the "measures of blowing according to the order which is observed at these days in this Realme of Englande" are given for the horn in D. One of these, given in fig. 3, is the English 16th-century hunting call, corresponding to the 14th-century French *Cornure de chasse de veus* given above.

When the Game hath begun Court. With hunt which.

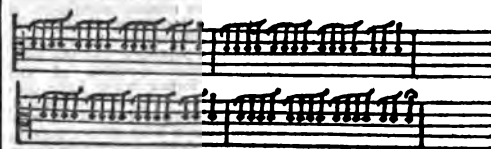

From Turbeville's *Noble Arte of Venerie* (1576), by permission of the Clarendon Press.
FIG. 3.—Hunting Call.

The hunting-horn, whether in its simplest form or with the one spiral, was held with the bell upwards on a level with the huntsman's head or just above it.⁵

A horn of the same fine calibre as the French horn, 3 or 4 ft. in length, slightly bent to take the curve of the body, was in use in Italy, it would seem, in the 15th century.⁶ It was held slanting across the body with the bell already slightly parabolic, at arm's length to the left side.

The hunting- and post-horns were favourite emblems on medieval coats of arms, more especially in Germany⁷ and Bohemia.

It is necessary at this point to draw attention to the fact that the French horn is a hybrid having affinities with both trumpet and primitive animal horn, or with *buccina* and *cornu*, and that both types, although frequently misnamed and confused by medieval writers and miniaturists, subsisted side by side, evolving independently until they merged in the so-called French horn. Both *buccina* and *cornu* after the fall of the Roman Empire, while Western arts and

¹ *Le Trésor de vénerie par Hardouin, seigneur de Fontaines-Gubrin* (edited by H. Michelant, Metz, 1856); the first part was edited by Jérôme Fichon (Paris, 1855), with an historical introduction by Bottée de Toulmon.

² As worked out by Edward Buhle, *op. cit.*, p. 23.

³ See Turbeville, *op. cit.*, also J. du Fouilloux, *La Vénerie* (Paris, 1628), p. 70; cf. also editions of 1650 and of 1562, where the horn is called *trumpet*, used with the verb *corner*; Juliana Berners, *Boke of St. Albans* (1496), the frontispiece of which is a hunting scene showing a horn of very wide bore, without bell. Only half the instrument is visible.

⁴ See "Reliure italienne du xv^e siècle en argent niellé. Collection du Baron Nathaniel de Rothschild, Vienne," in *Gazette archéologique* (Paris, 1880), xiii. p. 295, pl. 38, where other instruments are also represented.

⁵ See Jost Amman, *Wappen und Stammbuch* (1589). A reprint in facsimile has been published by Georg Hirth as vol. iii. of *Liedhaber Bibliothek* (Munich, 1881). See arms of Sultzbeger aus Tirol (p. 52), "Ein Jägerhörnia," and of the Herzog von Wirtenberg; cf. the latter with the arms of Wurtemberg in pl. xxii. vol. ii. of Gelre's *Wappenboek ou armorial de 1334 à 1372* (miniatures of coats of arms in facsimile), edited by Victor Bouton (Paris, 1883).

¹ See Bock, "Gebrauch der Hörner im Mittelalter," in Gustav Heider's *Mittelalterliche Kunstdenkmäler Österreichs* (Stuttgart, 1858-1860).

² *Dictionnaire raisonné du mobilier français* (Paris, 1889), ii. p. 246.

³ Engelbertus Admontensis in *De Musica Scriptores*, by Martin Gerbert, Bd. ii. lib. ii. cap. 29; and Edward Buhle, *Die Musikalischen Instrumente in den Miniaturen des frühen Mittelalters*, pt. 1, "Die Blasinstrumente" (Leipzig, 1903), p. 16.

crafts were in their infancy, were made straight, being then known as the busine or straight trumpet (busaun or posaun in Germany), and the long horn, *Herhorn*, slightly curved.¹

From two medieval representations of instruments like the Roman cornu one might be led to conclude that the instrument had been revived and was in use from the 14th century. A wooden bas-relief on the under part of the seats of the choir of Worcester cathedral,² said to date from the 14th century, shows a musician in a robe with long sleeves of fur playing the horn (fig. 4). The tube



FIG. 4.—Medieval Circular Horn.



FIG. 5.—Medieval Circular Horn, 1589. example is German, and figures in the

arms of the city of Frankfort-on-Main.³ Here in the two opposite corners are two cherubs playing immense cornua. The bore of the instruments (fig. 5) is of a calibre suggestive of the contrabass tuba; the circle formed is of a diameter sufficiently large to accommodate the youthful performer in a sitting posture; the bell is the fore-runner of that of the modern saxophone, shaped like a gloxinea; the mouthpiece is cup-shaped. It is possible, of course, that these two examples are attempts to reproduce the classic instrument, but the figures of the musicians and the feeling of the whole scheme of ornamentation seem to render such an explanation improbable. Moreover, Sebastian Virdung,⁴ writing on musical instruments at the beginning of the 16th century, gives a drawing of a cornu coiled round lightly, the tubing being probably soldered together at certain points. Virdung calls this instrument a *Jägerhorn*, and the short hunting-horn *Acherhorn* (Ackerhorn—the synonym of the modern Waldhorn). The scale of the former could have consisted only of the first eight harmonics, including the fundamental, which would be easily obtained on an instrument of such a large calibre. Mersenne,⁵ a century and a quarter later, gives a drawing of the same kind of horn among his *cors de chasse*, but does not in his description display his customary intimate knowledge of his subject; it may be that he was dealing at second-hand with an instrument of which he had had little practical experience. Praetorius⁶ gives as *Jägerhorn* only the simple forms of crescent-shaped horns with a single spiral; the spirally-wound horn of Virdung is replaced by a new instrument—the *Jägertrummel* (huntsman's trumpet)—of the same form, but less cumbersome, of cylindrical bore excepting at the bell end and having a crook inserted between the mouthpiece and the main coils. The tube, which could not have been less than 8 ft. long, produced the harmonic series of the cavalry trumpet from the 3rd to the 12th. The restrictions placed upon the use of the cavalry trumpet would have rendered it unavailable for use in the hunting-field, but the snake-shaped model, as Praetorius describes it, was a decided improvement on the horn, although inferior in resonance to the cavalry model. Here then are the materials for the fusion of the trumpet and hunting-horn into the natural or hand-horn of the 17th and 18th centuries. There is evidence, however, that a century earlier, *i.e.* at the end of the 15th century, the art of bending a brass tube of the delicate proportions of the French horn, which is still a test of fine workmanship, had been successfully practised. In an illustrated edition of Virgil's works published in Strassburg in 1502 and emanating from Grüninger's office, Brant being responsible for the illustrations, the lines (*Aen.* viii. 1-2) "Ut belli signum Laurenti Turnus ab arce Extulit: et rauco streperunt cornua cantu" are illustrated by two soldiers, one with the sackbut (posaune), the descendant of the buccina), the other with a horn wound spirally round his body in three coils, which appear to have a conical bore from the funnel-shaped mouthpiece to the bell which extends at the back of the head

horizontally over the left shoulder (fig. 6). There is ample room for the performer's head and shoulders to pass through the circle; the length of the tube could not therefore have been much less than 16 ft. long, equivalent to the horn in C or B \flat basso. In the same book (pl. cccii.) is another horn, smaller, differing slightly in the disposition of the coils and held like the modern horn in front.

These horns were not used for hunting but for war in conjunction with the draw-trumpet. Brant could not have imagined these instruments, and must have seen the originals or at least drawings of them; the instruments probably emanated from the famed workshops of Nuremberg, being intended mainly for use in Italy, and had not been generally adopted in Germany. The significance of these drawings of natural horns in a German work of the dawn of the 16th century will not be lost. It disposes once and for all of the oft-repeated fable that the hunting-horn first assumed its present form in France about 1680, a statement accepted without question by authorities of all countries, but without reference to any *pièce justificative* other than the story of the Bohemian Count Spörken first quoted by Gerber,⁷ and Virgil's Works repeated in most musical works without the Virgil's Works context. The account which gave rise to this statement had been published in 1782 again in a book by Faustinus Prochaska:⁸ "Vix Parisiis infandi cornua venatoria inventa ars quum delectata suavitate cantus duos ex hominibus sibi obnoxia ac instituendos curavit. Id principium apud nos artis, qua hodie Bohemi excellere putantur." In a preceding passage after the count's name, Franz Anton, Graf von Spörken, are the words "anno saeculi superioris octogesimo quum iter in externas provincias suscepisset." &c. There is no reference here to the invention of the horn in Paris or to the folding of the tube spirally, but only to the manner of eliciting sound from the instrument. Count Spörken, accustomed to the medieval hunting fanfares in which the tone of the horn approximated to the blare of the trumpet, was merely struck by the musical quality of the true horn tone elicited in Paris, and gave France the credit of the so-called invention, which probably more properly belonged to Italy. The account published by Prochaska a hundred years after, without reference to the source from which it was obtained, finds no corroboration from French sources. Had the French really made any substantial improvement in the hunting-horn at the end of the 17th century, transforming it from the primitive instrument into an orchestral instrument, it would only be reasonable to expect to find some evidence of this, considering the importance attached to the art of music at the court of Louis XIV., whose musical establishments, the *Chapelle Musique*,⁹ la *Musique de la Chambre du Roi* and la *Musique de la Grande Écurie*, included the most brilliant French artists. One would expect to find horns of that period by French makers among the relics of musical instruments in the museums of Europe. This does not seem to be the case. Moreover, in Diderot and d'Alembert's *Encyclopédie* (1767) the information given under the heading *trompe ou cor de chasse grand et petit* is very vague, and contains no hint of any special merit due to France for any improvement in construction. Among the plates (vol. v., pl. vii.) is given an illustration of a horn very similar to the instruments made in England and Germany nearly a century earlier, but with a funnel-shaped mouthpiece. Dr Julius Rühlmann states that there are two horns by Rauh, bearing the date 1703,¹⁰ in the Bavarian National Museum in Munich,¹¹ but although fine examples, one in silver, the other in brass (fig. 6) but although they turn out on inquiry¹² to bear no date whatever. Rühlmann's statement in the same article, that in the arms of the family of Wartenberg-Kolb (now extinct), which goes back to 1160, there is a hunting-horn coiled round in a complete circle is also misleading.



FIG. 6.—Spirally Coiled Horn from repeated in most musical works without the Virgil's Works context.

¹ *Historisch-biographisches Lexicon der Tonkünstler* (Leipzig, 1790-1792 and 1812-1814).

² *De saecularibus Liberalium Artium in Bohemia et Moravia factis commentarius* (Prague, 1784), p. 401.

³ See Ernest Thoinan, *Les Origines de la chapelle musique des souverains de France* (Paris, 1864); F. J. Fétis, "Recherches sur la musique des rois de France, et de quelques princes depuis Philippe le Bel jusqu'à la fin du règne de Louis XIV.," *Revue musicale* (Paris, 1832), xii, pp. 193, 217, 233, 241, 257; Castil-Blaze, *La Chapelle musique des rois de France* (Paris, 1882); Michel Brenet, "Deux comptes de la chapelle musique des rois de France," *Intern. Mus. Ges.*, Smbd. vi., i, pp. 1-32; J. Ecorcheville, "Quelques documents sur la musique de la grande écurie du roi," *Intern. Mus. Ges.*, Smbd. ii. 4 (Leipzig, 1901), pp. 608-642.

⁴ *Neue Zeitschrift f. Musik* (Leipzig, 1870), p. 309.

⁵ See *Die Sammlung der Musikinstrumente des bayerischen Nat. Museum* by K. A. Biedlmeil (Munich, 1883), Nos. 105 and 106.

⁶ Communication from Dr Georg Hagen, assistant director.

⁷ For illustrations see autotype facsimile of Utrecht Psalter, 9th century; British Museum, Add. MS. 10,546, Pa. 150, 9th century; Add. MS. 24, 109, 10th century; Eadwine Psalter, Trin. Coll. Camb., 11th century, and Cotton MS., Nero, D.IV., 8th century; also Edward Buhle, *op. cit.*, pl. ii. and pp. 12-24.

⁸ See John Carter, *Specimens of Ancient Sculpture and Paintings* (London, 1780-1794), i, p. 53 (plates unnumbered); also reproduced in H. Lavoix, *Histoire de la musique* (Paris, 1884).

⁹ See Jost Amman, *op. cit.*

¹⁰ *Musica getuscht und ausgesetzt* (Basel, 1511), p. 30. The names are not given under the drawings, but the above is the order in which they occur, which is probably reversed.

¹¹ *Harmonia universelle* (Paris, 1636), p. 245.

¹² *Synagoga Musicum* (Wolfenbüttel, 1618), pl. vii. No. 11, p. 39.

The horn (a post-horn) did not appear in the arms of the family in question until 1699, when the first peer Casimir Johann Friedrich was created hereditary Post-Master. The influence of such erroneous statements in the work of noted writers is far-reaching. Inquiries at the department of National Archives in Paris concerning Raoux, the founder of the afterwards famous firm of horn-makers whose model with pistons is used in the British military bands and at Kneller Hall, proved fruitless. Fétis states that he worked during the second half of the 18th century. Albert Choquet¹ states that he has seen a trumpet by Raoux, "seul ordinaire du Roy, Place du Louvre" dated 1695. The inscriptions on the horns in question are: For No. 105, a silver horn of the simplest form of construction in D, "Fait à Paris par Raoux"; for No. 106, a brass horn engraved with a crown on an ermine mantle with the initials C. A. (Carl Albert), "Fait à Paris par Raoux, seul ordinaire du Roy, Place du Louvre."

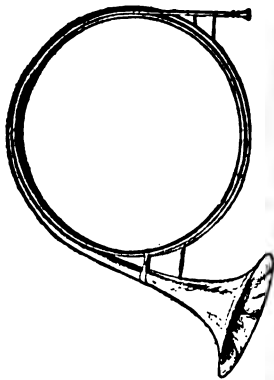

From a Photo by K. Teufel.

FIG. 7.—Early Raoux Horn (Munich).

Both horns measure across the coils 56 cm. and across the bell 27½. They are practically the same as the *cors de chasse* now in use in French and Belgian military bands, the large diameter of the coil enabling the performer to carry it over his shoulder. The orchestral horn was given a narrower diameter in order to facilitate its being held in front of the performer in a convenient position for stopping the bell with the right hand. No. 107 in the same collection, a horn of German construction, bears the inscription "Macht Jacob Schmid in Nürnberg" and the trademark "J. S." with a bird. A horn in E♭ of French make, having fleur-de-lys stamped on the rim of the bell, and measuring only 15 in. across the coils to the exterior edge of the bell—therefore a very small horn—is preserved in the Grand Ducal Museum at Darmstadt.² A horn in F♯ (probably F in modern high pitch), having the rim ornamented as above and the inscription "Fait à Paris, Carlin, ordinaire du Roy," readily gives the harmonics from the 3rd to the 12th.³ The extreme width is 20 in.⁴ Carlin, who lived at rue Croix des Petits Champs, died about 1780. The earliest dated horn extant is believed to be the one preserved in the Hohenzollern Museum in Sigmaringen, "Machts Wilhelm Haas, Nürnberg, 1688."⁵ Another early German horn engraved "Machts Heiner, Rich. Pfeiffer in Leipzig, 1697,"⁶ formerly in Paul de Wit's museum in Leipzig and now transferred with the rest of the collection to Cologne, is of similar construction.

The horn must have been well known at this time in England, for there are 17th-century horns of English manufacture still extant, one, for instance, in the collection of the Rev. F. W. Galpin by William Bull, dated 1699.⁷ In 1701 Clagget⁸ invented a contrivance by means of which two horns in different keys could be coupled and played by means of one mouthpiece, a valve or key opening the passage into the airways of one or the other of these horns at the will of the performer. Another horn of English manufacture about 1700 was exhibited at the South Kensington Museum in 1872, bearing No. 337 in the catalogue, in which unfortunately no details are given. Enough examples have been quoted to show that, judging from the specimens extant, Germany was not behind France, if not actually ahead, in the manufacture of early natural horns. Data are wanting concerning the instruments of Italy;

¹ See Musée du Conservatoire National de Musique. *Catalogue des instruments de musique* (Paris, 1884), p. 147.

² See Captain C. R. Day, *Descriptive Catalogue of the Musical Instruments exhibited at the Military Exhibition* (London, 1890), p. 147, No. 307.

³ See V. Mahillon, *Catal.* vol. i. No. 468.

⁴ See Captain C. R. Day, *Catal.* No. 309, p. 148.

⁵ For an illustration see *Catalogue of the Special Exhibition of Ancient Musical Instruments at South Kensington Museum 1872* (London, 1873), p. 25, No. 332.

⁶ See *Katalog der musikhistorischen Museen von Paul de Wit* (Leipzig, 1904), p. 142, No. 564, where it is classified as a Jägertrumpete after Praetorius; it has a trumpet mouthpiece.

⁷ For an illustration see F. J. Crowest, *English Music*, p. 449, No. 12.

⁸ See Ignatz and Anton Beck in *Boheisches Musik-Lexikon* by Felix J. Lipowski (Munich, 1811), p. 26, note.

they would probably prove to be the earliest of all, and as brass wind instruments are perishable are perhaps for that very reason unrepresented at the present day.

The horn at the present stage in its evolution was also well represented among the illustrations of the musical literature in Germany⁹ during the first half of the 18th century, and references to it are frequent.

The earliest orchestral music for the horn occurs in the operas of Cavalli and Cesti, leaders of the Venetian Opera in the 17th century. Already in 1639 Cavalli in his opera *Le Nozze de Tito e Pele* (act i. sc. 1) introduced a short scena. *Musik.*

"Chiamata alla Caccia" in C major for four horns on a basso continuo. An examination of the scoring in C clefs on the first, second, third and fourth lines shows, by the use of the note

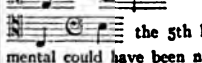
 in the bass part and in the second tenor of

 the 5th harmonic of the series, that the fundamental could have been no other than the 16-ft. C; the highest

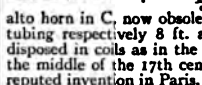
note in the treble part is , the 12th harmonic of the 8-ft. alto horn in C, now obsolete. It is clear therefore that horns with tubing respectively 8 ft. and 16 ft. long, which must have been disposed in coils as in the present day, were in use in Italy before the middle of the 17th century, fifty years before the date of their reputed invention in Paris.

In the same opera, act i. sc. 4, "Coro di Cavalieri" is a stirring call to arms of elemental grandeur, in which occur the words: "all' armi, o la guerrieri corai e tamburi e trombe, ogni campo ogni canto, armi rimbombe." There are above the voice parts four staves with treble and C clef signatures above the bass, and, although no instruments are indicated, the music written thereon, which alternates with the voices but does not accompany them, can have been intended for no instruments but trumpets and horns, thus carrying out the indications in the text. The horn is here once again put to the same use as the Roman cornu, and associated in like manner with the descendant of the buccina in a call to arms. It may be purely a coincidence that the early illustration of a horn with the tubing wound in coils round the body in the Strassburg Virgil mentioned above was put to the same use and associated with the same instrument.

Cesti's operas likewise contain many passages evidently intended for the horn, although the instruments are not specified in the score, which was nothing unusual at the time. Lulli composed the incidental music for a ballet, *La Princesse d'Élide*, which formed part of Molière's divertissement, "Les plaisirs de l'île enchantée," written for a great festival at Versailles on the 7th of May 1664. A copy of the music for this ballet, made about 1680, is preserved in the library of the Fitzwilliam Museum, Cambridge. The music contains a piece entitled "Les violons et les cors de chasse," written in the same style as Cavalli's scena; there are but two staves, and on both the music is characteristic of the horn, with which the

violins would play in unison. The piece finishes on B♭ 

and to play this note as the second of the harmonic series, the fundamental not being obtainable, the tube of the horn must have been over 17 ft. long. Among Philidor's copies of Lulli's ballets preserved in the library of the Paris Conservatoire of Music (vol. xlvii., p. 61) is a more complete copy of the above. The second number is an "Air des valets de chiens et des chasseurs avec les cors de chasse," which is substantially the same as the one in the Fitzwilliam Museum, but set for five horns in B♭. Here again the use of D, the fifth note of the harmonic series, indicates that the

fundamental was  a tone lower than the C horn

scored for by Cavalli, and known as B♭ basso. Victor Mahillon¹⁰ considers that the music reveals the fact that it was written for horns in B♭, 35 degrees (chromatic semitones) above 32-ft. C, or  having a wave-length of 1.475 m. To this statement

it is not possible to subscribe. The quintette required four horns in B♭ over 8 ft. long and one B♭ basso about 17 ft. long. It is obvious that the present custom of placing the bass notes of the horn on the

⁹ See, for instance, frontispiece of Walther's *Musikalisches Lexikon* (Leipzig, 1732); J. F. B. C. Majer's *Musik-Saal* (Nuremberg, 1741, 2nd ed.), p. 54; Joh. Christ. Kolb, *Pinacotheca Davidica* (Augsburg, 1711); Ps. xci.: "Componenti Musicali per il cembalo Dr Theofilo Muffat, organista di sua. Sacra Maesta Carlo VI. Imp." (1690), title-page in *Denkmäler d. Tonkunst in Oesterreich*, Bd. iii.

¹⁰ See Hugo Goldschmidt, "Das Orchester der italienischen Oper im 17. Jahrhundert," *Intern. Mus. Ges.*, Smbd. ii. 1, p. 73.

¹¹ See "Le Cor," pp. 23 and 24, and *Dictionnaire de l'acad. des beaux arts*, vol. iv., art. "Cor."

F clef an octave too low, as is now customary, had not yet been adopted, for in that case the bass horn would in several bars be playing above the tenor.

In 1647 Cardinal Mazarin, wishing to create in France a taste for Italian opera, had procured from Italy an orchestra, singers and mise-en-scène. That he was not entirely successful in making Paris appreciate Italian music is beside the mark; he developed instead a demand for French opera, to which Lulli proved equal. The great similarity in the style of the horn *scène* by Cavalli and Lulli may perhaps provide a clue to the mysterious and sudden apparition of the natural horn in France, where nothing was known of the hybrid instrument thirty years before, when Mersenne¹ wrote his careful treatise on musical instruments.

The orchestral horn had been introduced from Italy. It is not difficult to understand how the horn came to be called the French horn in England; the term only appears after Gerber and other writers had repeated the story of Count Spörken introducing the musical horn into Bohemia.² By this time the firm of Raoux, established in Paris a hundred years, had won for itself full recognition of its high standard of workmanship in the making of horns.

This use of the horn by Lulli in the one ballet seems to be an isolated instance; no other has yet been quoted. The introduction of the natural horn into the orchestra of the French opera did not occur until much later in 1735 in André Campra's *Achille et Deidamie*, and then only in a fanfare. In the meantime the horn had already won a place in most of the rising opera houses and dual orchestras³ of Germany, and had been introduced by Handel into the orchestra in London in his *Water-music* composed in honour of George I.

Although the Italians were undoubtedly the first to introduce the horn into the orchestra, it figured at first only as the characteristic instrument of the chase, suggesting and accompanying hunting scenes or calls to arms. For a more independent use of the horn in the orchestra we must turn to Germany. Reinhard Keiser, the founder of German opera, at the end of the 17th century in Hamburg, introduced two horns in C into the opening chorus of his opera *Ottavio* in 1705, where the horns are added to the string quartet and the oboes; they play again in act i. sc. 3, and in act ii. sc. 6 and 9. The compass used by the composer for the horns in C alto is the following:—



Wilhelm Kleeft draws attention to the characterization, which differed in the three acts. In *Henrico* (1711), in *Diana* (1712) and in *L'inganno Fedele* (1714) F horns were used. This called forth from Mattheson⁴ his much-quoted eulogium, the earliest description of the orchestral horn: "Die lieblich pompösen Waldhörner sind bei itziger Zeit sehr en vogue kommen, weil sie theils nicht so rude von Natur sind als die Trompeten, teils auch weil sie mit mehr Facilität können tractiret werden. Die brauchbarsten haben F und mit den Trompeten aus dem C gleichen *Ambitus*. Sie klingen auch dicker und füllen besser aus als die überläubende und schreyende Clarinen, weil sie um eine ganze quinte tiefer stehen."

Lotti in his *Gioie in Argo*, given in Dresden, 1717, scored for two horns in C, writing for them *solí* in the aria for tenor⁵ (act iii. sc. 1). Examples of C. H. Graun's⁶ scoring for horns in F and G respectively in *Polydorus* (1728-1729) and in *Iphigenia* (1731) show the complete emancipation of the instrument from its original limitations; it serves not only as melody instrument but also to enrich the harmony and emphasize the rhythm. A comparison of the early scores of Cavalli and Lulli with those of Handel's *Wasser-farmusik*⁷ (1717) and of *Rademisto*, performed in London in 1720,

¹ Mersenne's drawings of *cors de chasse* are very crude; they have no bell and are all of the large calibre suggestive of the primitive animal horn. He mentions nevertheless that they were not only used for signals and fanfares but also for little concerted pieces in four parts for horns alone, or with oboes, at the conclusion of the hunt.

² See William Tans'ur Senior, *The Elements of Musick* (London, 1772); Br. V. Dictionary under "Horn." Also *Scale of Horn* in the hand of Samuel Wesley; in Add. MS. 35011, fol. 166, Brit. Mus.

³ A horn-player, Johann Theodor Zedelmayer, was engaged in 1706 at the Saxon court at Weissenfels; see *Neue-Mitteilungen aus dem Gebiete histor. antiq. Forschungen*, Bd. xv. (2) (Halle, 1882), p. 503; also Wilhelm Kleeft, "Das Orchester der Hamburger Oper, 1678-1738," *Intern. Mus. Ges.*, Smbd. i. 2, p. 280, where the appearance of the horn in the orchestras of Germany is traced.

⁴ *Das neu-eröffnete Orchester*, i. 267.

⁵ See Moritz Fürstenau, *Zur Geschichte der Musik und des Theaters zu Dresden* (Dresden, 1861-1862), vol. ii. p. 60.

⁶ See "Carl Heinrich Graun als Opernkompunist," by Albert Mayer-Reinach, *Intern. Mus. Ges.*, Smbd. i. 3 (Leipzig, 1900), pp. 516-517 and 523-524, where musical examples are given.

⁷ Cf. Chrysander, *Haendel*, ii. 146.

shows the rapid progress made by the horn, even at a time when its technique was still necessarily imperfect.

While Bach was conductor of the prince of Anhalt-Cöthen's orchestra (1717-1723), it is probable that horns in several keys were used. In Dresden two Bohemian horn-players, Johann Adalbert Fischer and Franz Adam Säum, were added to the court orchestra in 1711.⁸ In Vienna the addition is stated to have taken place in 1712 at the opera.⁹ It is probable that as in Paris so in Vienna there were solitary instances in which the horn was heard in opera without attracting the attention of musicians long before 1712, for instance in Cesti's *Il Pompo d'Oro*, printed in Vienna in 1667 and 1668 and performed for the wedding ceremonies of Kaiser Leopold and Margareta, infanta of Spain. A horn in E (former F pitch) in the museum of the Brussels conservatoire bears the inscription "Machts Michael Leicham Schneider in Wien, 1713."¹⁰ Fürstenau¹¹ gives a further list of operas in Vienna during the first two decades of the 18th century.

It will be well before the next stage in the evolution is approached to consider the compass of the natural horn. The pedal octave from the fundamental to the 2nd harmonic was altogether wanting; the next octave contained only the 2nd and 3rd harmonics or the octave and its fifth; in the third octave, the 8ve, its major 3rd, 5th and minor 7th; in the fourth octave, a diatonic scale with a few accidentals was possible. It will be seen that the compass was very limited on any individual horn, but by grouping horns in different keys, or by changing the crooks, command was gained by the composer over a larger number of open notes.

An important period in the development of the horn has now been reached. Anton Joseph Hampel is generally credited¹² with the innovation of adapting the crooks to the middle of the body of the horn instead of near the mouthpiece, which greatly improved the quality of the notes obtained by means of the crooks. The crooks fitted into the two branches of U-shaped tubes, thus forming slides which acted as compensators. Hampel's *Inventionshorn*, as it is called in Germany (*Fr. cor harmonique*), is said to date from 1753,¹³ the first instrument having been made for him by Johann Werner, a brass instrument-maker of Dresden. The same invention is also attributed to Hattenhof of Hanau.¹⁴ Others again mention Michael Wögel¹⁵ of Carlsruhe and Rastadt, probably confusing his adaptation of the *Invention* or *Maschine*, as the slide contrivance was called in Germany, to the trumpet in 1780. The *Inventionshorn*, although embodying an important principle which has also found its application in all brass wind instruments with valves as a means of correcting defective intonation, did not add to the compass of the horn. At some date before 1762 it would seem that Hampel¹⁶ also discovered the principle on which hand-stopping is founded.

By hand-stopping (*Fr. sons boucheés*, *Ger. gestöplte Töne*) is understood the practice of inserting the hand with palm outstretched and

⁸ See Moritz Fürstenau, *op. cit.* ii. 58.

⁹ See Ludwig von Köchel, *Die kaiserliche Hofkapelle in Wien* (Vienna, 1869), p. 80.

¹⁰ See Victor Mahillon, *Catalogue descriptif*, vol. ii. No. 1160, p. 389.

¹¹ *Op. cit.* ii. 60.

¹² The Department of State Archives for Saxony in Dresden possesses no documents which can throw any light upon this point, but, through the courtesy of the director, the following facts have been communicated. Two documents concerning Anton Joseph Hampel are extant: (1) An application by his son, Johann Michael Hampel, to the elector Friedrich August III. of Saxony, dated Dresden, April 3, 1771, in which he prays that the post of his father as horn-player in the court orchestra—in which he had already served as deputy for his invalid father—may be awarded to him. (2) A petition from the widow, Aloisia Ludevica Hampelin, to the elector, bearing the same date (April 3, 1771), wherein she announces the death of her husband on the 30th of March 1771, who had been in the service of the house of Saxony thirty-four years as horn-player, and prays for the grant of a monthly pension for herself and her three delicate daughters, as she finds herself in the most unfortunate circumstances. There is no allusion in either letter to any musical merit of the deceased.

¹³ There is an instrument of this early type, supposed to date from the middle of the 18th century, in Paul de Wit's fine collection of musical instruments formerly in Leipzig and now transferred to Cologne; see *Katalog*, No. 645, p. 148.

¹⁴ See *Dictionnaire de l'acad. des beaux arts*, vol. iv. (Paris), article "Cor."

¹⁵ See Dr. Gustav Schilling, *Universal Lexikon der Tonkunst* (Stuttgart, 1840), Bd. vi., "Trompete"; also Capt. C. R. Day, pp. 139 and 151, where the term *Invention* is quite misunderstood and misapplied. See Gottfried Weber in *Coecilia* (Mains, 1835), Bd. xvii.

¹⁶ Gerber in the first edition of his *Lexikon* does not mention Hampel or award him a separate biographical article; we may therefore conclude that he was not personally acquainted with him, although Hampel was still a member of the electoral orchestra in Dresden during Gerber's short career in Leipzig. In the edition of 1812 Gerber renders him full justice.

fingers drawn together, forming a long, shallow cup, into the bell of the horn; the effect is similar to that produced in wood wind instruments, termed *d'amore*, by the pear-shaped bell with a narrow opening, i.e. a veiled mysterious quality, and, according to the arrangement of the hand and fingers (which cannot be taught theoretically, being inter-dependent on other acoustic conditions), a drop in pitch which enables the performer merely to correct the faulty intonation of difficult harmonics or to lower the pitch exactly a semitone or even a full tone by inserting the hand well up the bore of the bell. J. Fröhlich¹ gives drawings of the two principal positions of the hand in the horn. The same phenomenon may be observed in the flute by closing all the holes, so that the fundamental note of the pipe speaks, and then gradually bringing the palm of the hand nearer the open end of the flute. As a probable explanation may be offered the following suggestion. The partial closing of the opening of the bell removes the boundary of ambient air, which determines the ventral segment of the half wave-length some distance beyond the normal length; this boundary always lies beyond the end of the tube, thus accounting for the discrepancy between the theoretical length of the air-column and the practical length actually given to the tube.² Hampel is also said to have been the first to apply the *sordina* (Fr. *sourdine*) or mute, already in use in the 17th century for the trumpet,³ to the horn. The original mutes did not affect the pitch of the instrument, but only the tone, and when properly constructed may be used with the valve horn to produce the mysterious veiled quality of the hand-stopped notes. No satisfactory scientific explanation of the modifications in the pitch effected by the partial obstruction of the bell, whether by the hand or by means of certain mechanical devices, has as yet been offered. D. J. Blaikley suggests that in cases when the effect of hand-stopping appears to be to raise the pitch of the notes of the harmonic series, the real result of any contraction of the bell mouth (as by the insertion of the hand) is always a flattening of pitch accompanied by the introduction of a distorted or inharmonic scale, of such a character that for instance, the *c*, *d*, *e*, or 8th, 9th and 10th notes of the original harmonic scale become not the *c#* *d#* *e#* of a fundamental raised a semitone, but *D*, *E*, and *F* due to the 9th, 10th and 11th notes of a disturbed or distorted scale having a fundamental lower than that of the normal horn.

With regard to the discovery of this method of obtaining a chromatic compass for the horn, which rendered the instrument very popular with composers, instrumentalists and the public, and procured for it a generally accredited position in the orchestra, the following is the sum of evidence at present available. In the Kgl. öffentlichen Bibliothek, Dresden, is preserved, amongst the musical MSS., an autograph volume of 152 pages, entitled *Leçon pro Cornu*, bearing the signature A. J. Hampel, the name being filled in in pencil by a different hand. There is no introduction, no letter-press of any description belonging to the MS. method for the horn, nor is any book or pamphlet explaining the Inventionhorn or the method of hand-stopping by Hampel extant or known to have existed. He has apparently left no record of his accomplishment. A few typical extracts copied and selected from the original MS., courteously communicated by the director of the Royal Library, Hofrath, P. E. Richter (a practical musician and performer on horn and trumpet), do not prove conclusively that they were intended to be played on hand-stopped horns, with the exception, perhaps,



p. 133, No. 21.



p. 133, No. 22.

of the A. 13th harmonic from C, which could not easily be obtained except by hand-stopping on the hand-horn. On the blank sheet preceding the exercises is an inscription in the hand of Moritz Fürstenau, former custodian of the Royal Private Musical Collection (incorporated with the public library in 1896): "Anton Joseph Hampel, by whom these exercises for the horn were written, was a celebrated horn-player, a member of the Orchestra of the Electoral Prince of Saxony. He invented the so-called Inventionhorn. Cf. *Neues biog.-lit. Lexicon der Tonkünstler* by Gerber, pt. i. col. 493; also *Zur Gesch. der Musik u. des Theaters am Hofe zu Dresden*, by M. Fürstenau, Bd. ii." It will be seen that Fürstenau gives Gerber as his authority for the attribution of the invention to Hampel, although he searched the archives, to which he had free access, for material for his book.

¹ *Vollständige theoretisch-praktische Musikschule* (Bonn, 1811), pt. iii. p. 7.

² See Victor Mahillon, "Le Cor," p. 28; Chladni, *op. cit.* p. 87.

³ See Fröhlich, *op. cit.* 7; and Gerber, *Lexikon* (ed. 1812), p. 493.

⁴ "Le Cor," pp. 34 and 35.

⁵ See Praetorius and Mersenne, *op. cit.*; the latter gives an illustration of the trumpet mute.

The first possessor of the MS., Franz Schubert (1796-1828), musical director of the Italian opera in Dresden, wrote the following note in pencil on the last page of the cover: "Franz Schubert. The complete school of horn-playing by the Kgl. Polnischen u. Kurfürstl. Cammermusicus Anton Joseph Hampel, a celebrated virtuoso, invented by himself in 1762." Judging from the standard of modern technique, there are many passages in the "Leçon" which could not be played without artificially humouring the production of harmonics with the lips, and it is an open question to what extent this method of correcting intonation and of altering the pitch was practised in the 18th century. When, therefore, Franz Schubert states that the method was invented by Hampel, we may take this as indirectly confirming Gerber's statements. Further confirmation is obtained from the text of a work on the horn written by Heinrich Domnich⁶ (b. 1760), the son of a celebrated horn-player of Würzburg contemporary with Hampel. Domnich junior settled eventually in Paris, where he was appointed first professor of the horn at the Conservatoire. According to him the mute (*sourdine*) of metal, wood or cardboard in the form of a hollow cone, having a hole in the base, was used to soften the tone of the horn without altering the pitch. But Hampel, substituting for this the pad of cotton wool used for a similar purpose with the oboe, found with surprise that its effect in the bell of the horn was to raise the pitch a semitone (see D. J. Blaikley's explanation above). By this means, says Domnich, a diatonic and chromatic scale was obtained. Later Hampel substituted the hand for the pad. Domnich duly ascribes to Hampel the credit of the Inventionhorn, but erroneously states that it was Haltenhoff of Hanau who made the first instrument. Domnich further explains that Hampel, who had not practised the *bourché* notes in his youth, only made use of them in slow music, and that the credit of making practical use of the discovery was due to his pupil Giovanni Punto (Joh. Stich) the celebrated horn virtuoso, who was a friend of Domnich's.

It may be well to draw attention to the fact that hand-stopping was not possible so long as the tube of horn was folded in a circle wide enough to be worn round the body. The reduction of the diameter of the orchestral horn in order to allow the performer to hold the instrument in front of him, thus bringing the bell in front of the right arm in a convenient position for hand-stopping, must have preceded the discovery of hand-stopping. In the absence of contrary evidence we may suppose that the change was effected for the more convenient arrangement and manipulation of the slides or *Inventionen*. So radical a change in the compass of the horn could not occur and be adopted generally without leaving its mark on the horn music of the period; this change does not occur, as far as we know, before the last decades of the 18th century. The rapid acceptance in other countries of Hampel's discovery of hand-stopping is evidenced by a passage from a little English work on music, published in London in 1772 but bearing at the end of the preface the date June 1766:⁷ "Some eminent Proficients have been so dexterous as very nearly to perform all the defective notes of the scale on the Horn by management of Breath and by a little stopping the bell with their hands."

Hampel's success gave a general impetus to the inventive faculty of musical instrument makers in Europe. At first the result was negative. Köbel's attempt must, however, be mentioned, if only to correct a misconception. Köbel, a Bohemian horn virtuoso at the imperial Russian court from 1754, spent many years in vain endeavours to improve his instrument. At last, in 1760, he applied keys to the horn or the bugle, calling it *Klappenhorn* (the bugle is known in Germany as *Signal* or *Buglehorn*). Köbel's experiment did not become widely known or adopted during his lifetime, but Anton Weidinger, court trumpeter at Vienna, made a keyed trumpet⁸ in 1807, which attracted attention in musical circles and gave a fresh impetus in experimenting with keys upon brass instruments. In 1813 Joseph Weidinger, the twelve-year-old son of the above, gave a concert in Vienna on the *Klappenwaldhorn*⁹ (or keyed French horn), about which little seems to be known. Victor Mahillon¹⁰ describes such an instrument, but ascribes the invention to Köbel; there was but one key placed on the bell, which on being opened had the effect of raising the pitch of the instrument a whole tone. By alternately using the harmonic open notes on the normal length of the tube, and then by the action of the key shortening the air column, the following diatonic scale was obtained in the third octave:



⁶ *Méthode de premier et de second cor* (Paris, c. 1807). The passage in question was discovered and courteously communicated by Hofrath P. E. Richter of the Royal Library, Dresden. There is no copy of Domnich's work in the British Museum.

⁷ See William Tans'ur Senior, *op. loc. cit.*

⁸ See *Allgemeine musikalische Zeitung* (Leipzig), Nov. 1802, p. 158, and Jan. 1803, p. 245; and E. Hanalick, *Geschichte des Concertwesens in Wien* (Vienna, 1869), p. 119.

⁹ See *Allgem. mus. Ztg.*, 1815, p. 844.

¹⁰ "Le Cor," pp. 34-35.

In 1812 Dikhuht,³ horn-player in the orchestra of the grand-duke of Baden at Mannheim, constructed a horn in which a slide on the principle of that of the trombone was intended to replace hand-stopping and to lower the pitch at will a semitone.



FIG. 8.—Modern Horn (Boosey & Co.) attempts to solve the difficulty, made with varying success by makers of brass instruments, are described under VALVE, BOMBARDON and CORNET.⁴ (K. S.)

HORNBEAM (*Carpinus betulus*), a member of a small genus of trees of the natural order Corylaceae. The Latin name *Carpinus* has been thought to be derived from the Celtic *car*, wood, and *pin* or *pen*, head, the wood of hornbeams having been used for yokes of cattle (see Loudon, *Ency. of Pl.* p. 792, new ed. 1855, and Littré, *Dict. ii.* 556). The common hornbeam, or yoke-elm, *Carpinus betulus* (Ger. *Hornbaum* and *Hornbuche*, Fr. *charme*), is indigenous in the temperate parts of western Asia and of Asia Minor, and in Europe, where it ranges as high as 55° and 56° N. lat. It is common in woods and hedges in parts of Wales and of the south of England. The trunk is usually flattened, and twisted as though composed of several stems united; the bark is smooth and light grey; and the leaves are in two rows, 2 to 3 in. long, elliptic-ovate, doubly toothed, pointed, numerous ribbed, hairy below and opaque, and not glossy as in the beech, have short stalks and when young are plaited. The stipules of the leaves act as protecting scale-leaves in the winter-bud and fall when the bud opens in spring. The flowers appear with the leaves in April and May. The male catkins are about 2½ in. long, and have pale-yellow anthers, bearing tufts of hairs at the apex; the female attain a length in the fruiting stage of 2 to 4 in., with bracts 1 to 1½ in. long. The green and angular fruit or "nut" ripens in October; it is about ½ in. in length, is in shape like a small chestnut, and is enclosed in leafy, 3-lobed bracts. The hornbeam thrives well on stiff, clayey, moist soils, into which its roots penetrate deeply; on chalk or gravel it does not flourish. Raised from seed it may become a tree 40 to as much as 70 ft. in height, greatly resembling the beech, except

¹ See the description of the instrument and of other attempts to obtain the same result by Gottfried Weber, "Wichtige Verbesserung des Horns." in *Allg. musik. Ztg.* (Leipzig, 1812), pp. 758, 82; also 1815, pp. 637 and 638 (the regent or keyed bugle).

² See *Allg. musik. Ztg.*, 1815, May, p. 309, the first announcement of the invention in a paragraph by Captain G. B. Bierey.

³ *Ibid.*, 1817, p. 814, by F. Schneider, and Dec. p. 358; 1818, p. 531. An announcement of the invention and of a patent granted for the same for ten years, in which Blümel is for the first time associated with Stölzel as co-inventor. See also *Cæcilia* (Mainz, 1835), Bd. xvii. pp. 73 seq., with illustrations, an excellent article by Gottfried Weber on the valve horn and valve trumpet.

⁴ For a very complete exposition of the operation of valves in the horn, and of the mathematical proportions to be observed in construction, see Victor Mahillon's "Le Cor," also the article by Gottfried Weber in *Cæcilia* (1835), to which reference was made above. A list of horn-players of note during the 18th century is given by C. Gottlieb Murr in *Journal f. Kunstgeschichte* (Nuremberg, 1776), vol. ii. p. 27. See also a good description of the style of playing of the virtuoso J. Nisle in 1767 in Schubart, *Aesthetik d. Tonkunst*, p. 161, and *Leben u. Gesinnungen* (1791), Bd. ii. p. 92; or in L. Schiedermair, "Die Blüthezeit d. Ottingen-Wallensteinischen Hofkapelle." *Intern. Mus. Ges. Smbd.* ix. (1), 1907, pp. 83-130.

in its rounder and closer head. It is, however, rarely grown as a timber-tree, its chief employment being for hedges. "In the single row," says Evelyn (*Sylva*, p. 29, 1664), "it makes the noblest and the stateliest hedges for long Walks in *Gardens or Parks*, of any Tree whatsoever whose leaves are deciduous." As it bears clipping well, it was formerly much used in geometric gardening. The branches should not be lopped in spring, on account of their tendency to bleed at that season. The wood of the hornbeam is white and close-grained, and polishes ill, is of considerable tenacity and little flexibility, and is extremely tough and hard to work—whence, according to Gerard, the name of the tree. It has been found to lose about 8% of its weight by drying. As a fuel it is excellent; and its charcoal is much esteemed for making gunpowder. The inner part of the bark of the hornbeam is stated by Linnaeus to afford a yellow dye. In France the leaves serve as fodder. The tree is a favourite with hares and rabbits, and the seedlings are apt to be destroyed by mice. Pliny (*Nat. Hist.* xxvi. 26), who describes its wood as red and easily split, classes the hornbeam with maples.

The American hornbeam, blue or water beech, is *Carpinus americana* (also known as *C. caroliniana*); the common hop-hornbeam, a native of the south of Europe, is a member of a closely allied genus, *Ostrya vulgaris*, the allied American species, *O. virginiana*, is also known as ironwood from its very hard, tight, close-grained wood.

HORNBILL, the English name long generally given to all the birds of the family *Bucerotidae* of modern ornithologists, from the extraordinary horn-like excrescence (*epithema*) developed on the bill of most of the species, though to which of them it was first applied seems doubtful. Among classical authors Pliny had heard of such animals, and mentions them (*Hist. Nat.* lib. x. cap. lxx.) under the name of *Tragopon*; but he deemed their existence fabulous, comparing them with *Pegasi* and *Gryphones*—in the words of Holland, his translator (vol. i. p. 296)—"I think the same of the Tragoponades, which many men affirm to be greater than the *Ægle*; having crooked horns like a Ram on either side of the head, of the colour of yron, and the head onely red." Yet this is but an exaggerated description of some of the species with which doubtless his informants had an imperfect acquaintance. Medieval writers found Pliny's bird to be no fable, for specimens of the beak of one species or another seem occasionally to have been brought to Europe, where they were preserved in the cabinets of the curious, and thus Aldrovandus was able to describe pretty fairly and to figure (*Ornithologia*, lib. xii. cap. xx. tab. x. fig. 7) one of them under the name of "*Rhinoceros Avis*," though the rest of the bird was wholly unknown to him. When the exploration of the East Indies had extended farther, more examples reached Europe, and the "*Corvus Indicus cornutus*" of Bontius became fully recognized by Willughby and Ray, under the title of the "Horned Indian Raven or *Topon* called the Rhinocerot Bird." Since the time of those excellent ornithologists our knowledge of the hornbills has been steadily increasing, but up to the third quarter of the 19th century there was a great lack of precise information, and the publication of D. G. Elliot's "*Monograph of the Bucerotidae*," then supplied a great want. He divides the family into two sections, the *Bucerotinae* and the *Bucconinae*. The former group contains most of the species, which are divided into many genera. Of these, the most remarkable is *Rhinoplax*, which seems properly to contain but one species, the *Buceros vigil*, *B. scutatus* or *B. gealatus* of authors, commonly known as the helmet-hornbill, a native of Sumatra and Borneo. This is easily distinguished by having the front of its nearly vertical and slightly convex *epithema* composed of a solid mass of horn² instead of a thin coating of the light

² Apparently correlated with this structure is the curious thickening of the "prosencephalic median septum" of the cranium as also of that which divides the "prosencephalic" from the "mesencephalic chamber," noticed by Sir R. Owen (*Cat. Osteol. Ser. Mus. Roy. Coll. Surg. England*, i. 287); while the solid horny mass is further strengthened by a backing of bony prods, directed forwards and meeting its base at right angles. This last singular arrangement is not perceptible in the skull of any other species examined by the present writer.

and cellular structure found in the others. So dense and hard is this portion of the "helmet" that Chinese and Malay artists carve figures on its surface, or cut it transversely into plates, which from their agreeable colouring, bright yellow with a scarlet rim, are worn as brooches or other ornaments. This bird, which is larger than a raven, is also remarkable for its long graduated tail, having the middle two feathers nearly twice the length of the rest. Nothing is known of its habits. Its head was figured by George Edwards in the 18th century, but little else had been seen of it until 1801, when John Latham described the plumage from a specimen in the British Museum, and the first figure of the whole bird, from an example in the Museum at Calcutta, was published by General Hardwicke in 1823 (*Trans. Linn. Society*, xiv. pl. 23). Yet more than twenty years elapsed before French naturalists became acquainted with it.

In the *Bucconinae* we have only the genus *Bucorvus*, or *Bucorax* as some call it, confined to Africa, and containing at



Great Indian Hornbill (*B. bicornis*). (After Tickell's drawing in the Zoological Society's library.)

least two and perhaps more species, distinguishable by their longer legs and shorter toes, the ground-hornbills of English writers, in contrast to the *Bucerotinae* which are chiefly arboreal in their habits, and when not flying move by short leaps or hops, while the members of this group walk and run with facility. From the days of James Bruce at least there are few African travellers who have not met with and in their narratives more or less fully described one or other of these birds, whose large size and fearless habits render them conspicuous objects.

As a whole the hornbills, of which more than 50 species have been described, form a very natural and in some respects an isolated group, placed by Huxley among his *Coccygomorphae*. It has been suggested that they have some affinity with the hoopoes (*Upupidae*), and this view is now generally accepted. Their supposed alliance to the toucans (*Rhamphastidae*) rests only on the apparent similarity presented by the enormous beak, and is contradicted by important structural characters. In many of their habits, so far as these are known, all hornbills seem to be much alike, and though the modification in the form of the beak, and the presence or absence of the extraordinary

excrescence,¹ whence their name is derived, causes great diversity of aspect among them, the possession of prominent eyelashes (not a common feature in birds) produces a uniformity of expression which makes it impossible to mistake any member of the family. Hornbills are social birds, keeping in companies, not to say flocks, and living chiefly on fruits and seeds; but the bigger species also capture and devour a large number of snakes, while the smaller are great destroyers of insects. The older writers say that they eat carrion, but further evidence to that effect is required before the statement can be believed. Almost every morsel of food that is picked up is tossed into the air, and then caught in the bill before it is swallowed. They breed in holes of trees, laying large white eggs, and when the hen begins to sit the cock plasters up the entrance with mud or clay, leaving only a small window through which she receives the food he brings her during her incarceration.

This remarkable habit, almost simultaneously noticed by Dr Mason in Burma, S. R. Tickell in India, and Livingstone in Africa, and since confirmed by other observers, especially A. R. Wallace² in the Malay Archipelago, has been connected by A. D. Bartlett (*Proc. Zool. Society*, 1860, p. 142) with a peculiarity as remarkable, which he was the first to notice. This is the fact that hornbills at intervals of time, whether periodical or irregular is not yet known, cast the epithelial layer of their gizzard, that layer being formed by a secretion derived from the glands of the proventriculus or some other upper part of the alimentary canal. The epithelium is ejected in the form of a sack or bag, the mouth of which is closely folded, and is filled with the fruit that the bird has been eating. The announcement of a circumstance so extraordinary naturally caused some hesitation in its acceptance, but the essential truth of Bartlett's observations was abundantly confirmed by Sir W. H. Flower and especially by Dr J. Murie. These castings form the hen bird's food during her confinement. (A. N.)

HORNBLLENDE, an important member of the amphibole group of rock-forming minerals. The name is an old one of German origin, and was used for any dark-coloured prismatic crystals from which metals could not be extracted. It is now applied to the dark-coloured aluminous members of the monoclinic amphiboles, occupying in this group the same position that augite occupies in the pyroxene group. The monoclinic crystals are prismatic in habit with a six-sided cross-section; the angle between the prism-faces (*M*), parallel to which there are perfect cleavages, is 55° 40'. The colour (green, brown or black) and the specific gravity (3.0-3.3) vary with the amount of iron present. The pleochroism is always strong, and the angle of optical extinction on the plane of symmetry (α in the figure) varies from 0° to 37°. The chemical composition is expressed by mixtures in varying proportions of the molecules $\text{Ca}(\text{Mg}, \text{Fe})_2(\text{SiO}_3)_4$, $(\text{Mg}, \text{Fe})(\text{Al}, \text{Fe})_2\text{SiO}_6$ and $\text{NaAl}(\text{SiO}_3)_2$. Numerous varieties have been distinguished by special names: edenite, from Edenville in New York, is a pale-coloured aluminous amphibole containing little iron; pargasite, from Pargas near Abo in Finland, a green or bluish-green variety; common hornblende includes the greenish-black and black kinds containing more iron. The dark-coloured porphyritic crystals of basalts are known as basaltic hornblende.

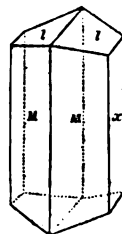

Hornblende occurs as an essential constituent of many kinds

¹ Buffon, as was his manner, enlarges on the cruel injustice done to these birds by Nature in encumbering them with this deformity, which he declares must hinder them from getting their food with ease. The only corroboration his perverted view receives is afforded by the observed fact that hornbills, in captivity at any rate, never have any fat about them.

² In *The Malay Archipelago* (i. 213), Wallace describes a nestling hornbill (*B. bicornis*) which he obtained as "a most curious object, as large as a pigeon, but without a particle of plumage on any part of it. It was exceedingly plump and soft, and with a semi-transparent skin, so that it looked more like a bag of jelly, with head and feet stuck on, than like a real bird."

of igneous rocks, such as hornblende-granite, syenite, diorite, hornblende-andesite, basalt, &c.; and in many crystalline schists, for example, amphibolite and hornblende-schist which are composed almost entirely of this mineral. Well-crystallized specimens are met with at many localities, for example: brilliant black crystals (syntagmatite) with augite and mica in the sanidine bombs of Monte Somma, Vesuvius; large crystals at Arendal in Norway, and at several places in the state of New York; isolated crystals from the basalts of Bohemia. (L. J. S.)

HORN-BOOK, a name originally applied to a sheet containing the letters of the alphabet, which formed a primer for the use of children. It was mounted on wood and protected with transparent horn. Sometimes the leaf was simply pasted against the slice of horn. The wooden frame had a handle, and it was usually hung at the child's girdle. The sheet, which in ancient times was of vellum and latterly of paper, contained first a large cross—the criss-cross—from which the horn-book was called the Christ Cross Row, or criss-cross-row. The alphabet in large and small letters followed. The vowels then formed a line, and their combinations with the consonants were given in a tabular form. The usual exorcism—"in the name of the Father and of the Sonne and of the Holy Ghost, Amen"—followed, then the Lord's Prayer, the whole concluding with the Roman numerals. The horn-book is mentioned in Shakespeare's *Love's Labour's Lost*, v. 1, where the *ba*, the *a*, *e*, *i*, *o*, *u*, and the horn, are alluded to by Moth. It is also described by Ben Jonson—

"The letters may be read, through the horn,
That make the story perfect."

HORNBY, SIR GEOFFREY THOMAS PHIPPS (1825-1895), British admiral of the fleet, son of Admiral Sir Phipps Hornby, the first cousin and brother-in-law of the 13th earl of Derby, by a daughter of Lieut.-General Burgoyne, commonly distinguished as "Saratoga" Burgoyne, was born on the 20th of February 1825. At the age of twelve he was sent to sea in the flagship of Sir Robert Stopford, with whom he saw the capture of Acre in November 1840. He afterwards served in the flagship of Rear-Admiral Joceline Percy at the Cape of Good Hope, was flag-lieutenant to his father in the Pacific, and came home as a commander. When the Derby ministry fell in December 1852 young Hornby was promoted to be captain. Early in 1853 he married, and as the Derby connexion put him out of favour with the Aberdeen ministry, and especially with Sir James Graham, the first lord of the Admiralty, he settled down in Sussex as manager of his father's property. He had no appointment in the navy till 1858, when he was sent out to China to take command of the "Tribune" frigate and convey a body of marines to Vancouver Island, where the dispute with the United States about the island of San Juan was threatening to become very bitter. As senior naval officer there Hornby's moderation, temper and tact did much to smooth over matters, and a temporary arrangement for joint occupation of the island was concluded. He afterwards commanded the "Neptune" in the Mediterranean under Sir William Fanshawe Martin, was flag-captain to Rear-Admiral Dacres in the Channel, was commodore of the squadron on the west coast of Africa, and, being promoted to rear-admiral in January 1869, commanded the training squadron for a couple of years. He then commanded the Channel Fleet, and was for two years a junior lord of the Admiralty. It was early in 1877 that he went out as commander-in-chief in the Mediterranean, where his skill in manœuvring the fleet, his power as a disciplinarian, and the tact and determination with which he conducted the foreign relations at the time of the Russian advance on Constantinople, won for him the K.C.B. He returned home in 1880 with the character of being perhaps the most able commander on the active list of the navy. His later appointments were to the Royal Naval College as president, and afterwards to Portsmouth as commander-in-chief. On hauling down his flag he was appointed G.C.B., and in May 1888 was promoted to be admiral of the fleet. From 1886 he was principal naval aide-de-camp to Queen Victoria, and in that capacity, and as an admiral of the fleet, was appointed

on the staff of the German emperor during his visits to England in 1889 and 1890. He died, after a short illness, on the 3rd of March 1895. By his wife, who predeceased him, he left several children, daughters and sons, one of whom, a major in the artillery, won the Victoria Cross in South Africa in 1900.

His life was written by his daughter, Mrs Fred. Egerton, (1896).
HORNCASTLE, a market-town in the S. Lindsey or Horncastle parliamentary division of Lincolnshire, England, at the foot of a line of low hills called the Wolds, at the confluence of the Bain and Waring streams; the terminus of a branch line of the Great Northern railway, 130 m. N. from London. Pop. of urban district (1901) 4038. The church of St Mary is principally Decorated and Perpendicular, with some Early English remains and an embattled western tower. Queen Elizabeth's grammar school was founded in 1562. Other buildings are an exchange, a court-house and a dispensary founded in 1789. The prosperity of the town is chiefly dependent on agriculture and its well-known horse fairs. Brewing and malting are carried on, and there is some trade in coal and iron.

Remains have been found here which may indicate the existence of a Roman village. The manor of Horncastle (Hornecastre) belonged to Queen Edith in Saxon times and was royal demesne in 1086 and the head of a large soke. In the reign of Stephen it apparently belonged to Alice de Cundi, a partisan of the empress Maud, and passing to the crown on her death it was granted by Henry III. to Gerbald de Escald, from whom it descended to Ralph de Rhodes, who sold it to Walter Mauclerc, bishop of Carlisle in 1230. The see of Carlisle retained it till the reign of Edward VI. when it was granted to Edward, Lord Clinton, but was recovered in the following reign. In 1230 Henry III. directed the men of Horncastle to render a reasonable aid to the bishop, who obtained the right to try felons, hold a court leet and have free warren. An inquisition of 1275 shows that the bishop had then, besides the return of writs, the assize of bread and ale and waifs and strays in the soke. Horncastle was a centre of the Lincolnshire rebellion of 1536. Royalist troops occupied the town in 1643, and were pursued through its streets after the battle fought at Winceby. It was never a municipal or parliamentary borough, but during the middle ages it was frequently the residence of the bishops of Carlisle. Its prosperity has always depended largely on its fairs, the great horse fair described by George Borrow in *Romany Rye* being granted to the bishop in 1230 for the octave of St Lawrence, together with the fair on the feast of St Barnabas. The three other fairs are apparently of later date.

See George Weir, *Historical and Descriptive Sketches of the Town and Soke of Horncastle in the County of Lincoln and of Several Places adjacent* (London, 1820).

HORN DANCE, a medieval dance, still celebrated during the September "wakes" at Abbots Bromley, a village on the borders of Needwood Forest, Staffordshire. Six or seven men, each wearing a deer's skull with antlers, dance through the streets, pursued by a comrade who bestrides a mimic horse, and whips the dancers to keep them on the move. The horn-dance usually takes place on the Monday after Wakes Sunday, which is the Sunday next after the 4th of September. Originally the dance took place on a Sunday.

See *Strand Magazine* for November 1896; also *Folk-lore*, vol. vii. (1896), p. 381.

HORNE, GEORGE (1730-1792), English divine, was born on the 1st of November 1730, at Otham near Maidstone, and received his education at Maidstone school and University College, Oxford. In 1749 he became a fellow of Magdalen, of which college he was elected president in 1768. As a preacher he early attained great popularity, and was, albeit unjustly, accused of Methodism. His reputation was helped by several clever if somewhat wrong-headed publications, including a satirical pamphlet entitled *The Theology and Philosophy of Cicero's Somnium Scipionis* (1751), a defence of the Hutchinsonians in *A Fair, Candid and Impartial State of the Case between Sir Isaac Newton and Mr Hutchinson* (1753), and critiques upon William Law (1758) and Benjamin Kennicott (1760). In 1771 he published his well-known *Commentary on the Psalms*,

a series of expositions based on the Messianic idea. In 1776 he was chosen vice-chancellor of his university; in 1781 he was made dean of Canterbury, and in 1790 was raised to the see of Norwich. He died at Bath on the 17th of January 1792.

His collected *Works* were published with a *Memoir* by William Jones in 1799.

HORNE, RICHARD HENRY, or **HENGIST** (1803-1884), English poet and critic, was born in London on New Year's Day 1803. He was intended for the army, and entered at Sandhurst, but receiving no commission, he left his country and joined the Mexican navy. He served in the war against Spain, and underwent many adventures. Returning to England, he became a journalist, and in 1836-1837 edited *The Monthly Repository*. In 1837 he published two tragedies, *Cosmo de Medici* and *The Death of Marlowe*, and in 1841 a *History of Napoleon*. The book, however, by which he lives is his epic of *Orion*, which appeared in 1843. It was published originally at a farthing, was widely read, and passed through many editions. In the next year he set forth a volume of critical essays called *A New Spirit of the Age*, in which he was assisted by Elizabeth Barrett (Mrs Browning), with whom, from 1839 to her marriage in 1846, he conducted a voluminous correspondence. In 1852 he went to Australia in company with William Howitt, and did not return to England until 1869. He received a Civil List pension in 1874, and died at Margate on the 13th of March 1884. Horne possessed extraordinary versatility, but, except in the case of *Orion*, he never attained to a very high degree of distinction. That poem, indeed, has much of the quality of fine poetry; it is earnest, vivid and alive with spirit. But Horne early drove his talent too hard, and continued to write when he had little left to say. In criticism he had insight and quickness. He was one of the first to appreciate Keats and Tennyson, and he gave valuable encouragement to Mrs Browning when she was still Miss Elizabeth Barrett.

HORNE, THOMAS HARTWELL (1780-1862), English theologian and bibliographer, was born in London on the 20th of October 1780, and was educated at Christ's Hospital, with S. T. Coleridge as an elder contemporary. On leaving school he became clerk to a barrister, but showed a keen taste for authorship. As early as 1800 he published *A Brief View of the Necessity and Truth of the Christian Revelation*, which was followed by several minor works on very varied subjects. In 1814, having been appointed librarian of the Surrey Institution, he issued his *Introduction to the Study of Bibliography*. This was followed in 1818 by his long matured work, the *Introduction to the Critical Study of the Holy Scriptures*, which rapidly attained popularity, and secured for its author widespread fame and an honorary M.A. degree from Aberdeen. In 1819 he received ordination from William Howley, bishop of London, and after holding two smaller livings was appointed rector of the united parishes of St Edmund the King and Martyr, and St Nicolas Acons in London. On the breaking up of the Surrey Institution in 1823, he was appointed (1824) senior assistant librarian in the department of printed books in the British Museum. After the project of making a classified catalogue had been abandoned, he took part in the preparation of the alphabetical one, and his connexion with the museum continued until within a few months of his death on the 27th of January 1862.

Horne's works exceed forty in number. The *Introduction*, edited by John Ayre and S. P. Tregelles, reached a 12th edition in 1869; but, owing to subsequent advances in biblical scholarship, it fell into disuse.

HORNELL, a city of Steuben county, New York, U.S.A., on the Canisteo river, 90 m. S.E. of Buffalo. Pop. (1890) 10,996; (1900) 11,918, of whom 1230 were foreign-born; (1910 census) 13,617. Hornell is served by the Erie and the Pittsburg, Shawmut & Northern railways; the latter connects at Wayland (20 m. distant by rail) with the Delaware, Lackawanna & Western railroad. In the city are St Ann's Academy, the St James Mercy Hospital, the Steuben Sanitarium, a public library, and a county court-house—terms of the county court being held here as well as in Bath (pop. in 1905, 3695), the county-seat, and in Corning. Hornell has extensive car shops of the Erie railroad,

and among its manufactures are silk goods (silk gloves being a specially important product), sash, doors and blinds, leather, furniture, shoes, white-goods, wire-fences, foundry and machine shop products, electric motors, and brick and tile. The value of the factory product in 1905 was \$3,162,677, an increase of 30-1% since 1900. The first settlement here was made in 1790, within the district of Erwin (then in Ontario county); after 1796 it was a part of Canisteo township, and the settlement itself was known as Upper Canisteo until 1820, when a new township was formed and named Hornellsville in honour of Judge George Hornell (d. 1813). The village of Hornellsville was incorporated in 1852, and in 1888 was chartered as a city; and by act of the state legislature the name was changed to Hornell in 1906.

See G. H. McMaster, *History of the Settlement of Steuben County* (Bath, New York, 1849).

HORNEMANN, FREDERICK (fl. 1796-1800), German traveller in Africa, was born at Hildesheim. He was a young man when, early in 1796, he offered his services to the African Association of London as an explorer in Africa. By the association he was sent to Göttingen University to study Arabic and otherwise prepare for an expedition into the unknown regions of North Africa from the east. In September 1797 he arrived in Egypt, where he continued his studies. On the invasion of the country by the French he was confined in the citadel of Cairo, to preserve him from the fanaticism of the populace. Liberated by the French, he received the patronage of Bonaparte. On the 5th of September 1798 he joined a caravan returning to the Maghrib from Mecca, attaching himself to a party of Fezzan merchants who accompanied the pilgrims. As an avowed Christian would not have been permitted to join the caravan Hornemann assumed the character of a young mamluk trading to Fezzan. He then spoke, but indifferently, both Arabic and Turkish, and he was accompanied as servant and interpreter by Joseph Freudenburg, a German convert to Islam, who had thrice made the pilgrimage to Mecca. Travelling by way of the oases of Siwa and Aujila, a "black rocky desert" was traversed to Temissa in Fezzan. Murzuk was reached on the 17th of November 1798. Here Hornemann lived till June 1799, going thence to the city of Tripoli, whence in August of the same year he despatched his journals to London. He then returned to Murzuk. Nothing further is known with certainty concerning him or his companion. In Murzuk Hornemann had collected a great deal of trustworthy information concerning the peoples and countries of the western Sahara and central Sudan, and when he left Tripoli it was his intention to go direct to the Hausa country, which region he was the first European definitely to locate. "If I do not perish in my undertaking," he wrote in his journal, "I hope in five years I shall be able to make the Society better acquainted with the people of whom I have given this short description." The British consul at Tripoli heard from a source believed to be trustworthy that about June 1803 Josef (Hornemann's Mahomedan name) was at Cafina, i.e. Katsena, in Northern Nigéria, "in good health and highly respected as a marabout." A report reached Murzuk in 1819 that the traveller had gone to "Noofy" (Nupe), and had died there. Hornemann was the first European in modern times to traverse the north-eastern Sahara, and up to 1910 no other explorer had followed his route across the Jebel-es-Suda from Aujila to Temissa.

The original text of Hornemann's journal, which was written in German, was printed at Weimar in 1801; an English translation, *Travels from Cairo to Mourzouk, &c.*, with maps and dissertations by Major James Rennell, appeared in London in 1802. A French translation of the English work, made by order of the First Consul, and augmented with notes and a memoir on the Egyptian oases by L. Langlès, was published in Paris in the following year. The French version is the most valuable of the three. Consult also the *Proceedings of the African Association* (1810), and the *Geog. Jnl.* Nov. 1906.

HORNER, FRANCIS (1778-1817), British economist, was born at Edinburgh on the 12th of August 1778. After passing through the usual courses at the high school and university of his native city, he devoted five years, the first two in England, to comprehensive but desultory study, and in 1800 was called to the Scottish bar. Desirous, however, of a wider sphere, Horner removed to London in 1802, and occupied the interval

that elapsed before his admission to the English bar in 1807 with researches in law, philosophy and political economy. In February 1806 he became one of the commissioners for adjusting the claims against the nawab of Arcot, and in November entered parliament as member for St Ives. Next year he sat for Wendover, and in 1812 for St Mawes, in the patronage of the marquis of Buckingham. In 1811, when Lord Grenville was organizing a prospective ministry, Horner had the offer, which he refused, of a treasury secretaryship. He had resolved not to accept office till he could afford to live out of office; and his professional income, on which he depended, was at no time proportionate to his abilities. His labours at last began to tell upon a constitution never robust, and in October 1816 his physicians ordered him to Italy, where, however, he sank under his malady. He died at Pisa, on the 8th of February 1817. He was buried at Leghorn, and a marble statue by Chantrey was erected to his memory in Westminster Abbey.

Without the advantages of rank, or wealth, or even of genius, Francis Horner rose to a high position of public influence and private esteem. His special field was political economy. Master of that subject, and exercising a sort of moral as well as intellectual influence over the House of Commons he, by his nervous and earnest rather than eloquent style of speaking, could fix its attention for hours on such dry topics as finance, and coinage, and currency. As chairman of the parliamentary committee for investigating the depreciation of bank-notes, for which he moved in 1810, he extended and confirmed his fame as a political economist by his share in the famous *Bullion Report*. It was chiefly through his efforts that the paper-issue of the English banks was checked, and gold and silver reinstated in their true position as circulating media; and his views on free trade and commerce have been generally accepted at their really high value. Horner was one of the promoters of the *Edinburgh Review* in 1802. His articles in the early numbers of that publication, chiefly on political economy, form his only literary legacy.

See *Memoirs and Correspondence of Francis Horner, M.P.*, published by his brother (see below) in 1843. Also the *Edinburgh and Quarterly Reviews* for the same year; and *Blackwood's Magazine*, vol. 1.

HORNER, LEONARD (1785-1864), Scottish geologist, brother of Francis Horner (above), was born in Edinburgh on the 17th of January 1785. His father, John Horner, was a linen merchant in Edinburgh, and Leonard, the third and youngest son, entered the university of Edinburgh in 1799. There in the course of the next four years he studied chemistry and mineralogy, and gained a love of geology from Playfair's *Illustrations of the Huttonian Theory*. At the age of nineteen he became a partner in a branch of his father's business, and went to London. In 1808 he joined the newly formed Geological Society and two years later was elected one of the secretaries. Throughout his long life he was ardently devoted to the welfare of the society; he was elected president in 1846 and again in 1860. In 1811 he read his first paper "On the Mineralogy of the Malvern Hills" (*Trans. Geol. Soc.* vol. i.) and subsequently communicated other papers on the "Brine-springs at Droitwich," and the "Geology of the S.W. part of Somersetshire." He was elected F.R.S. in 1813. In 1815 he returned to Edinburgh to take personal superintendence of his business, and while there (1821) he was instrumental in founding the Edinburgh School of Arts for the instruction of mechanics, and he was one of the founders of the Edinburgh Academy. In 1827 he was invited to London to become warden of the London University, an office which he held for four years; he then resided at Bonn for two years and pursued the study of minerals and rocks, communicating to the Geological Society on his return a paper on the "Geology of the Environs of Bonn," and another "On the Quantity of Solid Matter suspended in the Water of the Rhine." In 1833 he was appointed one of the commissioners to inquire into the employment of children in the factories of Great Britain, and he was subsequently selected as one of the inspectors. In later years he devoted much attention to the geological history of the

alluvial lands of Egypt; and in 1843 he published his *Life of his brother Francis*. He died in London on the 5th of March 1864.

See *Memoir of Leonard Horner*, by Katherine M. Lyell (1890) (privately printed).

HÖRNES, MORITZ (1815-1868), Austrian palaeontologist, was born in Vienna on the 14th of July 1815. He was educated in the university and graduated Ph.D. He then became assistant in the Vienna mineralogical museum. He was distinguished for his researches on the Tertiary mollusca of the Vienna Basin, and on the Triassic mollusca of Alpine regions. Most of his memoirs were published in the *Jahrbuch der K. K. geol. Reichsanstalt*. In 1864 he introduced the term Neogene to include Miocene and Pliocene, as these formations are not always to be clearly separated: the fauna of the lower division being subtropical and gradually giving place in the upper division to Mediterranean forms. He died in Vienna on the 4th of November 1868. His son Dr Rudolf Hörnes (b. 1850), professor of geology and palaeontology in the university of Graz, has also carried on researches among the Tertiary mollusca, and is author of *Elemente der Palaeontologie* (1884).

HORNFELS (a German word meaning hornstone), the group designation for a series of rocks which have been baked and indurated by the heat of intrusive granitic masses and have been rendered massive, hard, splintery, and in some cases exceedingly tough and durable. Most hornfels are fine-grained, and while the original rocks (such as sandstone, shale and slate, limestone and diabase) may have been more or less fissile owing to the presence of bedding or cleavage planes, this structure is effaced or rendered inoperative in the hornfels. Though they may show banding, due to bedding, &c., they break across this as readily as along it; in fact they tend to separate into cubical fragments rather than into thin plates. The commonest hornfels (the "biotite hornfels") are dark-brown to black with a somewhat velvety lustre owing to the abundance of small crystals of shining black mica. The "lime hornfels" are often white, yellow, pale-green, brown and other colours. Green and dark-green are the prevalent tints of the hornfels produced by the alteration of igneous rocks. Although for the most part the constituent grains are too small to be determined by the unaided eye, there are often larger crystals of garnet or andalusite scattered through the fine matrix, and these may become very prominent on the weathered faces of the rock.

The structure of the hornfels is very characteristic. Very rarely do any of the minerals show crystalline form, but the small grains fit closely together like the fragments of a mosaic; they are usually of nearly equal dimensions and from the resemblance to rough pavement work this has been called *pfaster* structure or pavement structure. Each mineral may also enclose particles of the others; in the quartz, for example, small crystals of graphite, biotite, iron oxides, sillimanite or feldspar may appear in great numbers. Often the whole of the grains are rendered semi-opaque in this way. The minutest crystals may show traces of crystalline outlines; undoubtedly they are of new formation and have originated *in situ*. This leads us to believe that the whole rock has been recrystallized at a high temperature and in the solid state, so that there was little freedom for the mineral molecules to build up well-individualized crystals. The regeneration of the rock has been sufficient to efface most of the original structures and to replace the former minerals more or less completely by new ones. But crystallization has been hampered by the solid condition of the mass and the new minerals are formless and have been unable to reject impurities, but have grown around them.

Slates, shales and clays yield biotite hornfels in which the most conspicuous mineral is black mica, in small scales which under the microscope are transparent and have a dark reddish-brown colour and strong dichroism. There is also quartz, and often a considerable amount of feldspar, while graphite, tourmaline and iron oxides frequently occur in lesser quantity. In these biotite hornfels the minerals, which consist of aluminium silicates, are commonly found; they are usually andalusite and

sillimanite, but kyanite appears also in hornfels, especially in those which have a schistose character. The andalusite may be pink and is then often pleochroic in thin sections, or it may be white with the cross-shaped dark enclosures of the matrix which are characteristic of chiestolite. Sillimanite usually forms exceedingly minute needles embedded in quartz. In the rocks of this group cordierite also occurs, not rarely, and may have the outlines of imperfect hexagonal prisms which are divided up into six sectors when seen in polarized light. In biotite hornfels a faint striping may indicate the original bedding of the unaltered rock and corresponds to small changes in the nature of the sediment deposited. More commonly there is a distinct spotting, visible on the surfaces of the hand specimens. The spots are round or elliptical, and may be paler or darker than the rest of the rock. In some cases they are rich in graphite or carbonaceous matters; in others they are full of brown mica; some spots consist of rather coarser grains of quartz than occur in the matrix. The frequency with which this feature reappears in the less altered slates and hornfels is rather remarkable, especially as it seems certain that the spots are not always of the same nature or origin. "Tourmaline hornfels" are found sometimes near the margins of tourmaline granites; they are black with small needles of schorl which under the microscope are dark brown and richly pleochroic. As the tourmaline contains boron there must have been some permeation of vapours from the granite into the sediments. Rocks of this group are often seen in the Cornish tin-mining districts, especially near the lodes.

A second great group of hornfels are the calc-silicate-hornfels which arise from the thermal alteration of impure limestones. The purer beds recrystallize as marbles, but where there has been originally an admixture of sand or clay lime-bearing silicates are formed, such as diopside, epidote, garnet, sphene, vesuvianite, scapolite; with these phlogopite, various feldspars, pyrites, quartz and actinolite often occur. These rocks are fine-grained, and though often banded are tough and much harder than the original limestones. They are excessively variable in their mineralogical composition, and very often alternate in thin seams with biotite hornfels and indurated quartzites. When perfused with boric and fluoric vapours from the granite they may contain much axinite, fluorite and datolite, but the aluminous silicates (andalusite, &c.) are absent from these rocks.

From diabases, basalts, andesites and other igneous rocks a third type of hornfels is produced. They consist essentially of feldspar with hornblende (generally of brown colour) and pale pyroxene. Sphene, biotite and iron oxides are the other common constituents, but these rocks show much variety of composition and structure. Where the original mass was decomposed and contained calcite, zeolites, chlorite and other secondary minerals either in veins or in cavities, there are usually rounded areas or irregular streaks containing a suite of new minerals, which may resemble those of the calc silicate hornfels above described. The original porphyritic, fluidal, vesicular or fragmental structures of the igneous rock are clearly visible in the less advanced stages of hornfelsing, but become less evident as the alteration progresses.

In some districts hornfelsed rocks occur which have acquired a schistose structure through shearing, and these form transitions to schists and gneisses which contain the same minerals as the hornfels, but have a schistose instead of a hornfels structure. Among these may be mentioned cordierite and sillimanite gneisses, andalusite and kyanite mica schists, and those schistose calc silicate rocks which are known as cipolins. That these are sediments which have undergone thermal alteration is generally admitted, but the exact conditions under which they were formed is not always clear. The essential features of hornfelsing are ascribed to the action of heat, pressure and permeating vapours, regenerating a rock mass without the production of fusion (at least on a large scale). It has been argued, however, that often there is extensive chemical change owing to the introduction of matter from the granite into the rocks surrounding it. The formation of new feldspar in the hornfels is pointed out as

evidence of this. While this "felspathization" may have occurred in a few localities, it seems conspicuously absent from others. Most authorities at the present time regard the changes as being purely of a physical and not of a chemical nature. (J. S. F.)

HORNING, LETTERS OF, a term in Scots law. Originally in Scotland imprisonment for debt was enforceable only in certain cases, but a custom gradually grew up of taking the debtor's oath to pay. If the debtor broke his oath, he became liable to the discipline of the Church. The civil power, further, stepped in to aid the ecclesiastical, and denounced him as a rebel, imprisoning his person and confiscating his goods. The method declaring a person a rebel was by giving three blasts on a horn and publicly proclaiming the fact; hence the expression, "put to the horn." The subsequent process, the warrant directing a messenger-at-arms to charge the debtor to pay or perform in terms of the letters, was called "letters of horning." This system of execution was simplified by an act of 1837 (Personal Diligence Act), and execution is now usually by diligence (see EXECUTION).

HORNPIPE, originally the name of an instrument no longer in existence, and now the name of an English national dance. The sailors' hornpipe, although the most common, is by no means the only form of the dance, for there is a pretty tune known as the "College Hornpipe," and other specimens of a similar kind might be cited. The composition of hornpipes flourished chiefly in the 18th century, and even Handel did not disdain to use the characteristic rhythm. The hornpipe may be written in $\frac{3}{4}$ or in common time, and is always of a lively nature.

HORNSEY, a municipal borough in the Hornsey parliamentary division of Middlesex, England, suburban to London, 6 m. N. of St Paul's Cathedral, on the Great Northern railway. Pop. (1891) 44,523; (1901) 72,056. It is chiefly occupied by small residences of the working classes. The manor, called in the 13th century *Haringes* (a name which survives as Haringay), belonged from an early date to the see of London, the bishops having a seat here. In 1387 the duke of Gloucester, uncle of Richard II., assembled in Hornsey Park the forces by the display of which he compelled the king to dismiss his minister de la Pole, earl of Suffolk; and in 1483 the park was the scene of the ceremonious reception of Edward V., under the charge of Richard, duke of Gloucester, by Edmund Shaw, lord mayor of London. The parish church of St Mary, Hornsey, retains its Perpendicular tower (c. 1500) and a number of interesting monuments. Finsbury Park, of 150 acres, and other smaller public grounds, are within the borough. Hornsey was incorporated in 1903 under a mayor, 10 aldermen and 30 councillors. Area, 2875 acres.

HOROWITZ, ISIAH (c. 1555-c. 1630), Jewish rabbi and mystic, was born at Prague, and died at Safed, then the home of Jewish Kabbala. His largest work is called *Shelah* (abbreviated from the initials of the full title *Shene sukoth ha-berit*, "Two Tables of the Covenant"). This is a compilation of ritual, ethics and mysticism, and had a profound influence on Jewish life. It has been often reprinted, especially in an abbreviated form.

For an account of the Jewish mystics at Safed see S. Schecter, *Studies in Judaism*, series II. (1908).

HORREUM, the Latin word for a magazine or storehouse for the storage of grain and other produce of the earth, and occasionally for that of agricultural implements. The storehouses of Rome were of the most extensive character, there being no fewer than 290 public horrea at the time of Constantine. They were used for the storage of food and merchandize of all kinds, being part of the great Roman system of providing food for the population, and they were supplied constantly with corn and other provisions from Africa, Spain and elsewhere.

HORROCKS, JEREMIAH (1610-1641), English astronomer, was born in 1610 at Toxteth Park, near Liverpool. His family was poor, and the register of Emmanuel College, Cambridge, testifies to his entry as sizar on the 18th of May 1632. Isolated in his scientific tastes, and painfully straitened in means, he

pursued amid innumerable difficulties his purpose of self-education. His university career lasted three years, and on its termination he became a tutor at Toxteth, devoting to astronomical observations his brief intervals of leisure. In 1636 he met with a congenial spirit in William Crabtree, a draper of Broughton, near Manchester; and encouraged by his advice he exchanged the guidance of Philipp von Lansberg, a pretentious but inaccurate Belgian astronomer, for that of Kepler. He now set himself to the revision of the Rudolphine Tables (published by Kepler in 1627), and in the progress of his task became convinced that a transit of Venus overlooked by Kepler would nevertheless occur on the 24th of November (O.S.) 1639. He was at this time curate of Hoole, near Preston, having recently taken orders in the Church of England, although, according to the received accounts, he had not attained the canonical age. The 24th of November falling on a Sunday, his clerical duties threatened fatally to clash with his astronomical observations; he was, however, released just in time to witness the punctual verification of his forecast, and carefully noted the progress of the phenomenon during half an hour before sunset (3.15 to 3.45). This transit of Venus is remarkable as the first ever observed, that of 1631 predicted by Kepler having been invisible in western Europe. Notwithstanding the rude character of the apparatus at his disposal, Horrocks was enabled by his observation of it to introduce some important corrections into the elements of the planet's orbit, and to reduce to its exact value the received estimate of its apparent diameter.

After a year spent at Hoole, he returned to Toxteth, and there, on the eve of a long-promised visit to his friend Crabtree, he died, on the 3rd of January 1641, when only in his twenty-second year. To the inventive activity of the discoverer he had already united the patient skill of the observer and the practical sagacity of the experimentalist. Before he was twenty he had afforded a specimen of his powers by an important contribution to the lunar theory. He first brought the revolutions of our satellite within the domain of Kepler's laws, pointing out that her apparent irregularities could be completely accounted for by supposing her to move in an ellipse with a variable eccentricity and directly rotatory major axis, of which the earth occupied one focus. These precise conditions were afterwards demonstrated by Newton to follow necessarily from the law of gravitation.

In his speculations as to the physical cause of the celestial motions, his mind, though not wholly emancipated from the tyranny of gratuitous assumptions, was working steadily towards the light. He clearly perceived the significant analogy between terrestrial gravity and the force exerted in the solar system, and by the ingenious device of a circular pendulum illustrated the composite character of the planetary movements. He also reduced the solar parallax to $14''$ (less than a quarter of Kepler's estimate), corrected the sun's semi-diameter to $15' 45''$, recommended decimal notation, and was the first to make tidal observations.

Only a remnant of the papers left by Horrocks was preserved by the care of William Crabtree. After his death (which occurred soon after that of his friend) these were purchased by Dr Worthington, of Cambridge; and from his hands the treatise *Venus in sole visa* passed into those of Hevelius, and was published by him in 1662 with his own observations on a transit of Mercury. The remaining fragments were, under the directions of the Royal Society, reduced by Dr Wallis to a compact form, with the heading *Astronomia Kepleriana defensa et promota*, and published with numerous extracts from the letters of Horrocks to Crabtree, and a sketch of the author's life, in a volume entitled *Jeremie Horroccii opera posthuma* (London, 1672). A memoir of his life by the Rev. Arundell Blount Whatton, prefixed to a translation of the *Venus in sole visa*, appeared at London in 1859.

For additional particulars, see J. E. Bailey's *Palatine Note-Book*, ii. 253, iii. 17; Bailey's "Writings of Horrocks and Crabtree" (from *Notes and Queries*, Dec. 2, 1882); *Notes and Queries*, 3rd series, vol. v., 5th series, vols. ii, iv; Martini's *Biographia Philosophica*, p. 271 (1764); R. Brickel, *Transits of Venus, 1639-1874* (Preston, 1874); *Astronomical Register*, xii. 293; Hevelii, *Mercurius in sole visus*, pp. 116-140; S. Rigaud's *Correspondence of Scientific Men*; Th. Birch, *History of the Royal Society*, i. 386, 395, 470; Sir E. Sherburne's *Sphere of M. Manilius*, p. 92. (1675);

Sir J. A. Picton's *Memorials of Liverpool*, ii. 561; M. Gregoan's *Fragments relative to the Ducky of Lancaster*, p. 166 (1817); *Liverpool Repository*, i. 570 (1826); *Phil. Trans. Abridged*, ii. 12 (1809); C. Hutton's *Phil. and Math. Dictionary* (1815); *Penny Cyclopaedia* (De Morgan); *Nature*, viii. 117, 137; J. B. J. Delambre, *Hist. de l'astronomie moderne*, ii. 495; *Hist. de l'astronomie au XVIII^e siècle*, pp. 28, 61, 74; W. Whewell, *Hist. of the Inductive Sciences*, i. 331. R. Grant, *Hist. of Physical Astronomy*, pp. 420, 545; J. Mädler, *Geschichte der Himmelskunde*, i. 275; M. Marie, *Hist. des Sciences*, iv. 168, vi. 90; J. C. Houzeau, *Bibl. Astr.* ii. 167. (A. M. C.)

HORROCKS, JOHN (1768-1804), British cotton manufacturer, was born at Edgeworth, near Bolton, in 1768. His father was the owner of a small quarry, and John Horrocks spent his early days in dressing and polishing millstones. The Lancashire cotton industry was then in its infancy, but Horrocks was greatly impressed with its future possibilities, and he managed to obtain a few spinning-frames which he erected in a corner of his father's offices. For a time he combined cotton-spinning on a very small scale with stone-working, but finally devoted himself entirely to cotton-spinning, working the frames with his own hands, and travelling through the Lancashire manufacturing districts to sell the yarn. His goods obtained a reputation for quality, and his customers increased so rapidly that in 1791 he removed to Preston, where he began to manufacture cotton shirtings and long-cloths in addition to spinning the cotton yarn. By taking full advantage of the machinery invented for manufacturing textiles, and by rigidly maintaining the quality of his goods, Horrocks rapidly developed his business, and with the aid of the capital of a local banker, whom he took into partnership, erected within a year of his arrival in Preston his first large mill, securing shortly afterwards from the East India Company a monopoly of the manufacture of cottons and muslins for the Indian market. The demand for Horrocks's goods continued to increase, and to cope with the additional work he took first an elder brother and in 1801 a Mr Whitehead and a Mr Miller into partnership, the title of the firm being altered to Horrocks, Miller & Co. In 1802 he entered parliament as tory member for Preston. He died in London in 1804 of brain-fever resulting from over-work.

HORSE (a word common to Teutonic languages in such forms as *hors*, *hros*, *ros*; cf. the Ger. *ross*), a name properly restricted to the domesticated horse (*Equus caballus*) and its wild or half-wild representatives, but in a zoological sense used as a general term for all the members of the family Equidae.

SPECIES

The distinctive characteristics of the family, and its position in the zoological system, are given in the articles EQUIDAE and PERISSODACTYLA. Here attention is concentrated on the leading features of the horse as contrasted with the other members of the same family, and subsequently on the anatomical structure of the former animal. The evolution of the existing representatives of the family from primitive extinct animals is summarized in the article EQUIDAE.

Horse, Wild Horse, Pony.—The horse (*Equus caballus*) is distinguished from the others by the long hairs of the tail being more abundant and growing quite or nearly from the base as well as the end and sides, and also by possessing a small bare callosity on the inner side of the hind leg, just below the "hock" or heel joint, in addition to the one on the inner side of the fore-arm above the carpus or "knee," common to all the genus. The mane is also longer and more flowing, and the ears are shorter, the limbs longer, and the head smaller.

Though existing horses are usually not marked in any definite manner, or only irregularly dappled, or spotted with light surrounded by a darker ring, many examples are met with showing a dark median dorsal streak like that found in all the other members of the genus, and even with dark stripes on the shoulders and legs.

Two distinct types of horse, in many instances largely modified by interbreeding, appear to exist. (1) The northern, or dun type, represented by the dun ponies of Norway (*Equus caballus typicus*), the closely allied Celtic pony (*E. c. celticus*) of Iceland, the

Hebrides, &c., and the wild pony of Mongolia (*E. c. przewalskii*), with which the now extinct tarpan of the Russian steppes appears to have been identical. The prevalent colour is yellow-dun, with dark brown or black mane, tail and legs; in the wild forms the muzzle is often white and the root of the tail short-haired; while the head is relatively large and heavy. No depression exists in the skull in front of the eye. Most of the ordinary horses of N.W. Europe are descended from the dun type, with more or less admixture of Barb blood. (2) The southern, or Barb type, represented by Barbs, Arabs, thoroughbreds, &c. (*E. c. asiaticus* or *hibycus*), in which the typical colour is bay with black "points" and often a white star on the forehead, and the mane and tail are long and full. The skull generally shows a slight depression in front of the socket of the eye, which, although now serving as the attachment for the muscle running to the nostril, may represent the face-gland of the extinct *Hipparion*. Many of the dark-coloured horses of Europe have Barb or Arab blood in their veins, this being markedly the case with the Old English black or Shire horse, the skull of which shows a distinct depression in front of the eye-socket. This depression is still more marked in the extinct Indian *E. sivalensis*, which may have been the ancestral form.

In Europe wild horses were abundant in the prehistoric Neolithic or polished-stone period. Judging from the quantity of their remains found associated with those of the men of that time, the chase of these animals must have been among man's chief occupations, and horses must have furnished him with one of his most important food-supplies. The characters of the bones preserved, and certain rude but graphic representations carved on bones or reindeer's antlers, enable us to know that they were rather small in size and heavy in build, with large heads and rough shaggy manes and tails, much like, in fact, the recently extinct tarpans or wild horses of the steppes of the south of Russia, and the still-surviving Mongolian wild pony or "Przewalski's horse." These horses were domesticated by the inhabitants of Europe before the dawn of history. Horses are now diffused by the agency of man throughout almost the whole of the inhabited parts of the globe, and the great modifications they have undergone in consequence of domestication, crossing, and selective breeding are well exemplified by comparing such extreme forms as the Shetland pony, dwarfed by uncongenial climate, the thoroughbred racer, and the London dray-horse. In Australia, as in America, horses imported by European settlers have escaped into un reclaimed lands and multiplied to a prodigious extent, roaming in vast herds over the wide and uncultivated plains.

Ass, Zebra, Quagga.—The next group is formed by the Asiatic wild asses, or kiangs and onagers, as they might well be called, in order to distinguish them from the wild asses of Africa. These asses have moderate ears, the tail rather long, and the back-stripe dark brown and running from head to tail. On the neck and withers this stripe is formed by the mane. There are two species of Asiatic wild ass, with several varieties. The first and largest has two races, the chigetai (*Equus hemionus*) of Mongolia, and the kiang (*E. h. kiang*) of Tibet, which is a redder animal. The onager (*E. onager*), of which there are several races, is smaller, with a broader dorsal stripe, bordered with white; the colour varying from sandy to greyish. This species ranges from Baluchistan and N.W. India to Persia, Syria and Arabia. These asses inhabit desert plains or open table-land; the kiang dwelling at elevations of about 14,000 ft. They are generally found in herds of from twenty to forty, although occasionally in larger numbers. All are fleet, and traverse rough ground with speed. On the lowlands they feed on dry grasses, and in Tibet on small woody plants. In India and Persia they are difficult to approach, although this is not the case in Tibet. Their sandy or chestnut colouring assimilates them to the horse, and separates them widely from the African wild asses, which are grey. The kiang has also larger and more horse-like hoofs, and the tail is haired higher up, thus approximating to *Equus caballus przewalskii*.

Among the striped species, or zebras and quaggas of Africa,

the large Grévy's zebra (*Equus grevyi*) of Somaliland and Abyssinia stands apart from the rest by the number and narrowness of its stripes, which have an altogether peculiar arrangement on the hind-quarters, the small size of the callosities on the fore-legs, the mane extending on to the withers and enormous rounded ears, thickly haired internally. The large size of the ears and the narrow stripes are in some degree at any rate adaptations to a life on scrub-clad plains.

Next comes the closely allied species with small pointed ears, of which the true quagga (*E. quagga*) of South Africa is now extinct. This animal has the dark stripes limited to the head, neck and shoulders, upon a brown ground. In the typical form, now also extinct, of the bonte-quagga, dauw, or Burchell's zebra (*E. burchelli*), the ground-colour is white, and the stripes cover the body and upper part of the limbs. This was the commonest species in the great plains of South Africa, where it roamed in large herds, often in company with the quagga and numerous antelopes. The species ranges from the Orange river to the confines of Abyssinia, but its more northern representatives show a gradual increase in the striping of the legs, culminating in the north-east African *E. burchelli granti*, in which the stripes extend to the hoofs. The markings, too, are alternately black and white, in place of brown and creamy, with intermediate "shadow stripes," as in the southern races.

Lastly, there is the true or mountain zebra (*E. zebra*), typically from the mountain ranges of Cape Colony, where it is now specially protected, but represented by *E. zebra penricei* in south-west Africa. In its relatively long ears and general build it approaches the African wild asses, from which it chiefly differs by the striping (which is markedly different from that of the quagga-group) and the reversal of the direction of the hairs along the spine.

The African wild ass (*E. asinus*) is the parent of the domesticated breed, and is a long-eared grey animal, with no forelock, and either a shoulder-stripe or dark barrings on the legs. There are two races, of which the Nubian *E. a. africanus* is the smaller, and has a continuous dorsal stripe and a shoulder-stripe but no bars on the legs. The Somali race (*E. a. somaliensis*), on the other hand, is a larger and greyer animal, with an interrupted dorsal and no shoulder-stripe, but distinct leg-barrings.

Hybrids.—There are thus eight modifications of the horse-type at present existing, sufficiently distinct to be reckoned as species by most zoologists, and easily recognizable by their external characters. They are, however, all so closely allied that each will, at least in a state of domestication or captivity, breed with any of the others. Cases of fertile union are recorded between the horse and the quagga, the horse and the bonte-quagga or Burchell's zebra, the horse and the onager and kiang or Asiatic wild asses, the common ass and the zebra, the ass and bonte-quagga, the ass and the onager, the onager and the zebra, and the onager and the bonte-quagga. The two species which are farthest removed in structure, the horse and the ass, produce, as is well known, hybrids or mules, which in certain qualities useful to man excel both their progenitors, and in some countries and for certain kinds of work are in greater requisition than either. Although occasional more or less doubtful instances have been recorded of female mules breeding with the males of one or other of the pure species, it is more than doubtful if any case has occurred of their breeding *inter se*, although the opportunities of doing so must have been great, as mules have been reared in immense numbers for at least several thousands of years. We may therefore consider it settled that the different species of the group are now in that degree of physiological differentiation which enables them to produce offspring with each other, but does not permit of the progeny continuing the race, at all events unless reinforced by the aid of one of the pure forms.

The several members of the group show mental differences quite as striking as those exhibited by their external form, and more than perhaps might be expected from the similarity of their brains. The patience of the ass, the high spirit of the horse, the obstinacy of the mule, have long been proverbial. It is very remarkable that, out of so many species, two only should have

shown any aptitude for domestication, and that these should have been from time immemorial the universal and most useful companions and servants of man, while all the others remain in their native freedom to this day. It is, however, still a question whether this really arises from a different mental constitution causing a natural capacity for entering into relations with man, or whether it may not be owing to their having been brought gradually into this condition by long-continued and persevering efforts when the need of their services was felt. It is possible that one reason why most of the attempts to add new species to the list of our domestic animals in modern times have ended in failure is that it does not answer to do so in cases in which existing species supply all the principal purposes to which the new ones might be put. It can hardly be expected that zebras and bonte-quaggas fresh from their native mountains and plains can be brought into competition as beasts of burden and draught with horses and asses, whose useful qualities have been augmented by the training of thousands of generations of progenitors.

Not infrequently instances occur of domestic horses being produced with a small additional toe with complete hoof, usually on the inside of the principal toe, and, though far more rarely, three or more toes may be present. These malformations are often cited as instances of reversion to the condition of some of the earlier forms of equine animals previously mentioned. In some instances, however, the feet of such polydactyl horses bear little resemblance to those of the extinct *Hipparion* or *Anchitherium*, but look rather as if due to that tendency to reduplication of parts which occurs so frequently as a monstrous condition, especially among domesticated animals, and which, whatever its origin, certainly cannot in many instances, as the cases of entire limbs superadded, or of six digits in man, be attributed to reversion.

ANATOMY

The anatomical structure of the horse has been described in detail in several works mentioned in the bibliography at the end of this section, though these have generally been written from the point of view of the veterinarian rather than of the comparative anatomist. The limits of the present article will only admit of the most salient points being indicated, particularly those in which the horse differs from other Ungulata. Unless otherwise specified, it must be understood that all that is stated here, although mostly derived from observation upon the horse, applies equally well to the other existing members of the group.

Skeleton.—The skull as a whole is greatly elongated, chiefly in consequence of the immense size of the face as compared with the hinder or true cranial portion. The basal line of the cranium from the lower border of the foramen magnum to the incisor border of the palate is nearly straight. The orbit, of nearly circular form, though small in proportion to the size of the whole skull, is distinctly marked, being completely surrounded by a strong ring of bone with prominent edges. Behind it, and freely communicating with it beneath the osseous bridge (the post-orbital process of the frontal) forming the boundary between them, is the small temporal fossa occupying the whole of the side of the cranium proper, and in front is the great flattened expanse of the "check," formed chiefly by the maxilla, giving support to the long row of cheek-teeth, and having a prominent ridge running forward from below the orbit for the attachment of the masseter muscle. The lacrymal occupies a considerable space on the flat surface of the cheek in front of the orbit, and below it the jugal does the same. The latter sends a horizontal or slightly ascending process backwards below the orbit to join the under surface of the zygomatic process of the squamosal, which is remarkably large, and instead of ending as usual behind the orbit, runs forwards to join the greatly developed post-orbital process of the frontal, and even forms part of the posterior and inferior boundary of the orbit, an arrangement not met with in other mammals. The closure of the orbit behind distinguishes the skull of the horse from that of its allies the rhinoceros and tapir, and also from all of the perissodactyles of the Eocene period. In front of the brain cavity, the great tubular nasal cavities are provided with well-developed turbinat bones, and are roofed over by large nasals, broad behind, and ending in front in a narrow decurved point. The opening of the anterior nostrils is prolonged backwards on each side of the face between the nasals and the elongated slender premaxillae. The latter expand in front, and are curved downwards to form the semicircular alveolar border which supports the large incisor teeth. The palate is narrow in the interval between the incisor and molar teeth, in which are situated

the large anterior palatine foramina. Between the molar teeth it is broader, and it ends posteriorly in a rounded excavated border opposite the hinder border of the penultimate molar tooth. It is mainly formed by the maxillae, as the palatines are very narrow. The pterygoids are delicate slender slips of bone attached to the hinder border of the palatines, and supported externally by, and generally welded with, the rough pterygoid plates of the alisphenoid, with no pterygoid fossa between. They slope obliquely forwards, and end in curved, compressed, basular processes. There is a distinct alisphenoid canal for the passage of the internal maxillary artery. The base of the cranium is long and narrow; the alisphenoid is very obliquely perforated by the foramen rotundum, but the foramen ovale is confluent with the large foramen lacerum medium behind. The glenoid surface for the articulation of the mandible is greatly extended transversely, concave from side to side, convex from before backwards in front, and hollow behind, and is bounded posteriorly at its inner part by a prominent post-glenoid process. The squamosal enters considerably into the formation of the temporal fossa, and, besides sending the zygomatic process forwards, it sends down behind the meatus auditorius a post-tympanic process which aids to hold in place the otherwise loose tympano-periotic bone. Behind this the occipital gives off a long paroccipital process.

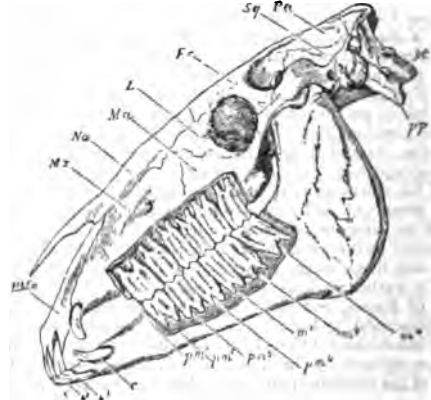

FIG. 1.—Side view of Skull of Horse, with the bone removed so as to expose the whole of the teeth.

- | | |
|---|---|
| PMx, Premaxilla. | c, The canine tooth. |
| Ms, Maxilla. | pm ¹ , The situation of the rudimentary first premolar, which has been lost in the lower, but is present in the upper jaw. |
| Na, Nasal bone. | pm ² , pm ³ , and pm ⁴ , The three fully developed premolar teeth. |
| Ma, Jugal or malar bone. | m ¹ , m ² , and m ³ , The three true molar teeth. |
| L, Lacrymal bone. | |
| Fr, Frontal bone. | |
| Sg, Squamosal bone. | |
| Pa, Parietal bone. | |
| Oc, Occipital condyle. | |
| pp, Paroccipital process. | |
| s ¹ , s ² , and s ³ , The three incisor teeth. | |

The periotic and tympanic are welded together, but not with the squamosal. The former has a wide but shallow floccular fossa on its inner side, and sends backwards a considerable "pars mastoidea," which appears on the outer surface of the skull between the post-tympanic process of the squamosal and the occipital. The tympanic forms a tubular meatus auditorius externus directed outwards and slightly backwards. It is not dilated into a distinct bulb, but ends in front in a pointed rod-like process. It completely embraces the truncated cylindrical tympanohyal, which is of great size, corresponding with the large development of the whole anterior arch of the hyoid. This consists mainly of a long and compressed stylohyal, expanded at the upper end, where it sends off a triangular posterior process. The basi-hyal is remarkable for the long, median, pointed, compressed "glossohyal" process, which it sends forward from its anterior border into the base of the tongue. A similar but less developed process is found in the rhinoceros and tapir. The lower jaw is large, especially the region of the angle, which is expanded and flattened, giving great surface for the attachment of the masseter muscle. The condyle is greatly elevated above the alveolar border; its articular surface is very wide transversely, and narrow and convex from before backwards. The coronoid process is slender, straight, and inclined backwards. The horizontal ramus, long, straight, and compressed, gradually narrows towards the symphysis, where it expands laterally to form with the ankylous opposite ramus the wide, semicircular, shallow alveolar border for the incisor teeth.

The vertebral column consists of seven cervical, eighteen dorsal six lumbar, five sacral, and fifteen to eighteen caudal vertebrae.

There may be nineteen rib-bearing vertebrae, in which case five only will be reckoned as belonging to the lumbar series. The odontoid process of the axis is wide, flat, and hollowed above, as in the ruminants. The bodies of the cervical vertebrae are elongated, strongly keeled, and markedly opisthocœloous, or concave behind and convex in front. The neural laminae are broad, the spines almost obsolete, except in the seventh, and the transverse processes not largely developed. In the trunk vertebrae the opisthocœloous character of the centrum gradually diminishes. The spinous processes of the anterior thoracic region are high and compressed. To these is attached the powerful elastic ligament (*ligamentum nuchæ*, or "paxwax") which, passing forwards in the middle line of the neck above the neural arches of the cervical vertebrae—to which it is also connected—is attached to the occiput and supports the weight of the head. The transverse processes of the lumbar vertebrae are long, flattened, and project horizontally outwards or slightly forward from the arch. The metapophyses are moderately developed, and there are no anapophyses. The caudal vertebrae, except those quite at the base, are slender and cylindrical, without processes and without chevron bones beneath. The ribs are eighteen or nineteen in number on each side, flattened, and united to the sternum by short, stout, tolerably well ossified sternal ribs. The sternum consists of six pieces; the anterior or presternum is compressed and projects forwards like the prow of a boat. The segments which follow gradually widen, and the hinder part of the sternum is broad and flat.

As in all other ungulates, there are no clavicles. The scapula is long and slender, the supra-scapular border being rounded, and slowly and imperfectly ossified. The spine is very slightly developed; rather above the middle its edge is thickened and somewhat turned backwards, but it gradually subsides at the lower extremity without forming any acromial process. The coracoid is a prominent rounded nodule. The humerus is stout and rather short. The ulna is rudimentary, being represented by little more than the olecranon. The shaft gradually tapers below and is firmly welded to the radius. The latter bone is of nearly equal width throughout. The three bones of the first row of the carpus (scaphoid, lunar and cuneiform) are subequal in size. The second row consists of a broad and flat magnum, supporting the great third metacarpal, having to its radial side the trapezoid, and to its ulnar side the unciform, which are both small, and articulate inferiorly with the rudimentary second and fourth metacarpals. The pisiform is large and prominent, flattened and curved; it articulates partly with the cuneiform and partly with the lower end of the radius. The large metacarpal is called in veterinary anatomy "cannon bone"; the small lateral metacarpals, which gradually taper towards their lower extremities, and lie in close contact with the large one, are called "splint bones." The single digit consists of a moderate-sized proximal (*os suffraginis*, or large pastern), a short middle (*os coronæ*, or small pastern), and a wide, semi-lunar, unequal phalanx (*os pedis*, or coffin bone). There is a pair of large nodular sesamoids behind the metacarpo-phalangeal articulation, and a single large transversely-extended sesamoid behind the joint between the second and third phalanx, called the "navicular bone."

The carpal joint, corresponding to the wrist of man, is commonly called the "knee" of the horse, the joint between the metacarpal and the first phalanx the "fetlock," that between the first and second phalanges the "pastern," and that between the second and third phalanges the "coffin joint."

In the hinder limb the femur is marked, as in other perissodactyles, by the presence of a "third trochanter," a flattened process, curving forwards and arising from the outer side of the bone, about one-third of the distance from the upper end. The fibula is reduced to a mere rod-like rudiment of the upper end. The lower part is absent or completely fused with the tibia. The calcaneum has a long and compressed calcaneal process. The astragalus has a large flat articular surface in front for the navicular, and a small one for the cuboid. The navicular and the external cuneiform bones are broad and flat. The cuboid is small, and the internal and middle cuneiform bones are small and united together. The metapodals and phalanges resemble very closely those of the fore limb, but the principal metatarsal is more laterally compressed at its upper end than is the corresponding metacarpal. The joint between the femur and tibia, corresponding to the knee of man, is called the "stifle-joint"; that between the tibia and tarsus, corresponding to the ankle of man, the "hock." The bones and joints of the foot have the same names as in the fore limb. The horse is eminently "digitigrade," standing on the extremity of the single digit of each foot, which is kept habitually in a position approaching to vertical.

The muscles of the limbs are modified from those of the ordinary mammalian type in accordance with the reduced condition of the bones and the simple requirements of flexion and extension of the joints, no such actions as pronation and supination, or opposition of digits, being possible or needed. The muscles therefore which perform these functions in other quadrupeds are absent or rudimentary. Below the carpal and tarsal joints, the fore and hind limbs correspond almost exactly in structure as well as function. On the anterior or extensor surface of the limb a powerful tendon (7 in fig. 2), that of the anterior extensor of the phalanges (corresponding to the *extensor communis digitorum* of the arm and *extensor longus digitorum*

of the foot of man) passes down over the metacarpal bone and phalanges, to be inserted mainly into the upper edge of the anterior surface of the last phalanx or pedal bone. There is also a much smaller second extensor on the outer side of this in each limb, the lateral extensor of the phalanges. In the fore-leg the tendon of this muscle (which corresponds with the *extensor minimi digiti* of man) receives a slip from that of the principal extensor, and is inserted into the first phalanx. In the hind-leg (where it is the homologue apparently of the *peroneus brevis* of man) the tendon becomes blended with that of the large extensor.

A strong ligamentous band behind the metapodium, arising from near the upper extremity of its posterior surface, divides into two at its lower end, and each division, being first connected with one of the paired upper sesamoid bones, passes by the side of the first phalanx to join the extensor tendon of the phalanges. This is called in veterinary anatomy the "suspensory ligament of the sesamoids," or of the "fetlock" (10 in fig. 2); but its attachments and relations, as well as the occasional presence of muscular fibres in its substance, show that it is the homologue of the interosseous muscles of other mammals, modified in structure and function, to



FIG. 2.—Section of Foot of Horse.

1. Metacarpal bone.
2. First phalanx (*os suffraginis*).
3. Second phalanx (*os coronæ*).
4. Third or ungual phalanx (*os pedis*, or coffin bone).
5. One of the upper sesamoid bones.
6. Lower sesamoid or navicular bone.
7. Tendon of anterior extensor of the phalanges.
8. Tendon of superficial flexor (*f. perforatus*).
9. Tendon of deep flexor (*f. perforans*).
10. Suspensory ligament of fetlock.
11. Inferior or short sesamoid ligament.
12. Derma or skin of the foot, covered with hair, and continued into
13. The coronary cushion,
14. The podophyllous or laminar membrane, and
15. The keratogenous membrane of the sole.
16. Plantar cushion.
17. Hoof.
18. Fatty cushion of fetlock.

suit the requirements of the horse's foot. Behind or superficial to these are placed the two strong tendons of the flexor muscles, the most superficial, or *flexor perforatus* (8) dividing to allow the other to pass through, and then inserted into the middle phalanx. The *flexor perforans* (9) is as usual inserted into the terminal phalanx. In the fore-leg these muscles correspond with those similarly named in man. In the hind-leg, the perforated tendon is a continuation of that of the plantaris, passing pulley-wise over the tuberosity of the calcaneum. The perforating tendon is derived from the muscle corresponding with the long flexor of man, and the smaller tendon of the oblique flexor (*tibialis posterior* of man) is united with it.

The hoof of the horse corresponds to the nail or claw of other mammals, but is so constructed as to form a complete and solid case to the expanded termination of the toe, giving a firm basis of support formed of a non-sensitive substance, which is continually renewed by the addition of material from within, as its surface wears away by friction. The terminal phalanx of the toe is greatly enlarged and modified in form to support this hoof, and the size of the internal framework of the foot is increased by a pair of lateral fibro-cartilaginous masses attached on each side to the hinder edges of the bone, and by a fibro-cellular and fatty plantar cushion in the median part. These structures are all enclosed in the middle subcutaneous integument, a continuation of the ordinary skin of the limb, but extremely vascular, and having its superficial extent greatly increased by being developed into papillæ or laminae. From this the horny material which constitutes the hoof is exuded. A thickened ring encircling the upper part, called coronary cushion (13) and the sole (15), are covered with numerous thickly-set

papillae or villi, and take the greatest share in the formation of the hoof; the intermediate part constituting the front and side of the foot (14), corresponding with the wall of the hoof, is covered with parallel, fine longitudinal laminae, which fit into corresponding depressions in the inner side of the horny hoof.

The horny hoof is divided into a wall or crust consisting of the front and sides, the flattened or concave sole, and the frog, a triangular median prominence, notched posteriorly, with the apex turned forwards, situated in the hinder part of the sole. It is formed of pavement epithelial cells, mainly grouped in a concentric manner around the vascular papillae of the subcorneous integument, so that a section near the base of the hoof, cut transversely to the long axis of these papillae, shows a number of small circular or oval orifices, with cells arranged concentrically round them. The nearer the surface of the hoof, or farther removed from the seat of growth, the more indistinct the structure becomes.

Small round or oval plates of horny epithelium called "chestnuts," callousities growing like the hoof from enlarged papillae of the skin, are found on the inner face of the fore-arm, above the carpal joint in all species of Equidae, and in the horse (*E. caballus*) similar structures occur near the upper extremity of the inner face of the metatarsus. They are evidently rudimentary structures which it is suggested may represent glands (Lydekker, *Proc. Zool. Soc. London*, 1903, vol. i.).

Dentition.—The dentition of the horse, when all the teeth are in place, is expressed by the formula $i. \frac{1}{1}, c. \frac{1}{1}, p. \frac{1}{1}, m. \frac{2}{2}$. The incisors of each jaw are placed in close contact, forming a semicircle. The crowns are broad, somewhat awl-shaped, and of nearly equal size. They have all the great peculiarity, not found in the teeth of any other mammal, and only in the Equidae of comparatively recent geological periods (see also PALAEOZOOLOGY), of an involution of the external surface of the tooth (see fig. 3), by which what should

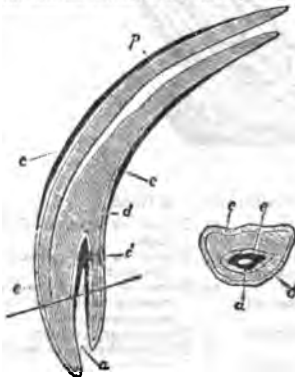

FIG. 3.—Longitudinal and Transverse Section of Upper Incisor of Horse.

p, Pulp cavity.

d, Dentine or ivory.

e, Enamel.

c, Outer layer of cementum or crusta petrosa.

c, Inner layer of cementum, lining a, the pit or cavity of the crown of the tooth.

properly be the apex is carried deeply into the interior of the crown, forming a pit, the bottom of which becomes partially filled with cement. As the tooth wears, the surface, besides the external enamel layer as in an ordinary simple tooth, shows in addition a second hard substance surrounding the pit, which adds greatly to the efficiency of the tooth as an organ for biting tough, fibrous substances. This pit, generally filled in the living animal with particles of food, is conspicuous from its dark colour, and constitutes the "mark" by which the age of the horse is judged, as in consequence of its only extending to a certain depth in the crown it becomes obliterated as the latter wears away, and then the tooth assumes the character of that of an ordinary incisor, consisting only of a core of dentine, surrounded by the external enamel layer. It is not quite so deep in the lower as in the upper teeth.

The canines are either rudimentary or absent in the female. In the male they are compressed, pointed, and smaller than the incisors, from which they are separated by a slight interval. The teeth of the cheek series are all in contact with each other, but separated from the canines by a considerable toothless space. The anterior premolars are quite rudimentary, sometimes not developed at all, and generally fall by the time the animal attains maturity, so that there are but six functional cheek teeth,—three that have predecessors in the milk-dentition, and hence are considered as premolars, and three molars, but otherwise, except the first and last of the series, not distinguishable in form or structure. These teeth in both upper and lower jaws are extremely long-crowned or hypsodont, successive portions being pushed out as the surface wears away, a process which continues until the animal becomes advanced in age. The enamelled surface is infolded in a complex manner (a modification of that found in other perissodactyles), the folds extending quite to the base of the crown, and the interstices being filled and the surface covered with a considerable mass of cement, which binds together and strengthens the whole tooth. As the teeth wear, the folded enamel, being harder than the other constituents, the dentine and cement, forms projecting ridges on the surface

arranged in a definite pattern, which give it great efficiency as a grinding instrument (see fig. 2, in article EQUIDAE). The free surfaces of the upper teeth are quadrate, except the first and last, which are nearly triangular. The lower teeth are much narrower than the upper.

The milk-dentition consists of $i. \frac{1}{1}, c. \frac{1}{1}, m. \frac{2}{2}$ —the canines and first or rudimentary premolars having apparently no predecessors. In form and structure the milk-teeth much resemble the permanent ones, having the same characteristic enamel-foldings. Their eruption commences a few days after birth, and is complete before the end of the first year, the upper teeth usually appearing somewhat earlier than the lower. The first teeth which appear are the first and second milk-molars (about five days), then the central incisor (from seven to ten days); this is followed by the second incisor (at one month), then the third molar, and finally the third incisor. Of the permanent teeth the first molar appears a little after the end of the first year, followed by the second molar before the end of the second year. At about two and a half years the first premolar replaces its predecessor. Between two and a half and three years the first incisor appears. At three years the second and third premolars, and the third molar have appeared, at from three and a half to four years the second incisor, at four to four and a half years the canine, and, finally, at five years, the third incisor, completing the permanent dentition. Up to this period the age of the horse is clearly shown by the condition of dentition, and for some time longer indications can be obtained from the wear of the incisors, though this depends to a certain extent upon the hardness of the food or other circumstances. As a general rule, the depression caused by the infolding of the surface of the incisor (the "mark") is obliterated in the first or central incisor at six years, in the second at seven years, and in the third at eight years. In the upper teeth, as the depressions are deeper, this obliteration does not take place until about two years later. After this period no certain indications can be obtained of the age of the horse from the teeth.

Digestive Organs.—The lips are flexible and prehensile; and the membrane that lines them and the cheeks smooth. The palate is long and narrow; its mucous surface has seventeen pairs of not very sharply defined oblique ridges, extending as far back as the last molar tooth, beyond which the *velum palati* extends for about 3 in., having a soft corrugated surface, and ending posteriorly in an arched border without a uvula. This embraces the base of the epiglottis, and, except while swallowing food, shuts off all communication between the cavity of the mouth and the pharynx, respiration being, under ordinary circumstances, exclusively through the nostrils. Between the mucous membrane and the bone of the hard palate is a dense vascular and nervous plexus. The membrane lining the jaws is soft and corrugated. An elongated raised glandular mass, 3 in. long and 1 in. from above downwards, extending backwards from the root of the tongue along the side of the jaws, with openings on the surface leading into crypts with glandular walls, represents the tonsil. The tongue, corresponding to the form of the mouth, is long and narrow. It consists of a compressed intermolar portion with a flat upper surface, broad behind and becoming narrower in front, and of a depressed anterior part rather shorter than the former, which is narrow behind and widens towards the evenly rounded apex. The dorsal surface generally is soft and smooth. There are two large circumvallate papillae near the base, rather irregular in form, about a quarter of an inch in diameter and half an inch apart. The conical papillae are small and close set, though longer and more filamentous on the intermolar portion. There are no lingiform papillae on the dorsum, but a few inconspicuous ones scattered along the sides of the organ.

Of the salivary glands the parotid is by far the largest, elongated in the vertical direction, and narrower in the middle than at either end. Its upper extremity embraces the lower surface of the cartilaginous ear-conch; its lower end reaches the level of the inferior margin of the mandible, along the posterior margin of which it is placed. Its duct leaves the inferior anterior angle, at first descends a little, and runs forward under cover of the rounded inferior border of the lower jaw, then curves up along the anterior margin of the masseter muscle, becoming superficial, pierces the buccinator, and enters the mouth by a simple aperture opposite the middle of the crown of the third premolar tooth. It is not quite so thick as a goose-quill when distended, and nearly a foot in length.

The submaxillary gland is of very similar texture to the last, but much smaller; it is placed deeper, and lies with its main axis horizontal. It is elongated and slender, and flattened from within outwards. Its posterior end rests against the anterior surface of the transverse process of the atlas, from which it extends forwards and downwards, slightly curved, to beneath the ramus of the jaw. The duct which runs along its upper and internal border passes forwards in the usual course, lying in the inner side of the sublingual gland, to open on the outer surface of a distinct papilla, situated on the floor of the mouth, half an inch from the middle line, and midway between the lower incisor teeth and the attachment of the fraenum linguae. The sublingual is represented by a mass of glands lying just beneath the mucous membrane of the floor of the mouth on the side of the tongue, causing a distinct ridge, extending from the fraenum backwards, the numerous ducts opening separately along the summit of the ridge. The buccal glands are arranged in two

rows parallel with the molar teeth. The upper ones are the largest, and are continuous anteriorly with the labial glands, the ducts of which open on the mucous membrane of the upper lip.

The stomach of the horse is simple in its external form, with a largely developed right *ad. de. sac.* and is a good deal curved on itself, so that the cardiac and pyloric orifices are brought near together. The *antrum pyloricum* is small and not very distinctly marked. The interior is divided by the character of the lining membrane into two distinct portions, right and left. Over the latter the dense white smooth epithelial lining of the esophagus is continued, terminating abruptly by a raised crenulated border. Over the right part the mucous membrane has a greyish-red colour and a velvety appearance, and contains numerous peptic glands, which are wanting in the cardiac portion. The oesophageal orifice is small, and guarded by a strong crescentic or horseshoe-like band of muscular fibres, supposed to be the cause of the difficulty of vomiting in the horse. The small intestine is of great length (80 to 90 ft.), its mucous membrane being covered with numerous fine villi. The caecum is of conical form, about 2 ft. long and nearly a foot in diameter; its walls are sacculated, especially near the base, having four longitudinal muscular bands; and its capacity is about twice that of the stomach. It lies with its base near the lower part of the abdomen, and its apex directed towards the thorax. The colon is about one-third the length of the small intestine, and very capacious in the greater part of its course. As usual it may be divided into an ascending, transverse, and descending portion; but the middle or transverse portion is folded into a great loop, which descends as low as the pubis; so that the colon forms altogether four folds, generally parallel to the long axis of the body. The descending colon is much narrower than the rest, and not sacculated, and, being considerably longer than the distance it has to traverse, is thrown into numerous folds.

The liver is tolerably symmetrical in general arrangement, being divided nearly equally into segments by a well-marked umbilical fissure. Each segment is again divided by lateral fissures, which do not extend quite to the posterior border of the organ; of the central lobes thus cut off, the right is rather the larger, and has two fissures in its free border dividing it into lobules. The extent of these varies, however, in different individuals. The two lateral lobes are subtriangular in form. The Spigelian lobe is represented by a flat surface between the postal fissure and the posterior border, not distinctly marked off from the left lateral by a fissure of the ductus venosus, as this vessel is buried deep in the hepatic substance, but the caudate lobe is distinct and tongue-shaped, its free apex reaching nearly to the border of the right lateral lobe. There is no gall-bladder, and the biliary duct enters the duodenum about 6 in. from the pylorus. The pancreas has two lobes or branches, a long one passing to the left and reaching the spleen, and a shorter right lobe. The principal duct enters the duodenum with the bile-duct, and there is often a second small duct opening separately.

Circulatory and Respiratory Organs.—The heart has the form of a rather elongated and pointed cone. There is one anterior vena cava, formed by the union of the two jugular and two axillary veins. The aorta gives off a large branch (the anterior aorta) very near its origin, from which arise—first, the left axillary, and afterwards the right axillary and the two carotid arteries.

Under ordinary circumstances the horse breathes entirely by the nasal passages, the communication between the larynx and the mouth being closed by the velum palati. The nostrils are placed laterally, near the termination of the muzzle, and are large and dilatible, being bordered by cartilages upon which several muscles act. Immediately within the opening of the nostril, the respiratory canal sends off on its upper and outer side a blind pouch ("false nostril") of conical form, and curved, 2 to 3 in. in depth, lying in the notch formed between the nasal and premaxillary bones. It is lined by mucous membrane continuous with that of the nasal passage; its use is not apparent. It is longer in the ass than in the horse. Here may be mentioned the guttural pouches, large air-sacs from the Eustachian tubes, and lying behind the upper part of the pharynx, the function of which is also not understood. The larynx has the lateral sacculi well developed, though entirely concealed within the alae of the thyroid cartilage. The trachea divides into two bronchi.

Nervous System.—The brain differs little, except in details of arrangement of convolutions, from that of other ungulates. The hemispheres are rather elongated and subcylindrical, the olfactory lobes are large and project freely in front of the hemispheres, and the greater part of the cerebellum is uncovered. The eye is provided with a nictitating membrane or third eyelid, at the base of which open the ducts of the Harderian gland.

Reproductive System.—The testes are situated in a distinct sessile or slightly pedunculated scrotum, into which they descend from the sixth to the tenth month after birth. The accessory generative glands are the two vesiculæ seminales, with the median third vesicle, or *uterus masculinus*, lying between them, the single bilobed prostate, and a pair of globular Cowper's glands. The penis is very large, cylindrical, with a truncated, expanded, flattened termination. When in a state of repose it is retracted, by a muscle arising from the scrotum, within the prepuce, a cutaneous fold attached below the symphysis pubis.

The uterus is bicornuate. The vagina is often partially divided by a membranous septum or hymen. The teats are two, inguinally placed. The surface of the chorion is covered evenly with minute villi, constituting a diffuse non-deciduate placenta. The period of gestation is eleven months.

AUTHORITIES.—R. I. Pocock, "The Species and Subspecies of Zebras," *Ann. Mag. Nat. Hist.* ser. 6, vol. xx., 1837; and "A New Arrangement of the Existing Species of Equidae," *Op. cit.* ser. 7, vol. x., 1902; R. Lydekker, "Notes on the specimens of Wild Asses in English Collections," *Novitates Zoologicae*, vol. xi., 1904; B. Salensky, "On Equus przewalskii," *Mém. Acad. St. Pétersbourg*, 1902; M. S. Arloing, "Organisation du pied chez le cheval," *Ann. Sci. Nat.*, 1867, viii., 55-81; H. Burmeister, *Los caballos fosiles de la Pampa Argentina* (Buenos Aires, 1875); Chauveau and Arloing, *Traité d'anatomie comparée des animaux domestiques* (Paris, 1871), and English edition by G. Fleming (1873); A. Ecker, "Das Europäische Wildpferd und dessen Beziehungen zum domesticirten Pferd," *Globus*, Bd. xxxiv. (Brunswick, 1878); Major Forsyth, "Beiträge zur Geschichte der fossilen Pferde besonders Italiens," *Abh. Schw. Pal. Ges.* iv., 1-16, pt. iv.; George, "Études zool. sur les Hémionides et quelques autres espèces chevalines," *Ann. Sci. Nat.*, 1869, xii., 5; E. F. Gurlt, *Anatomische Abbildungen der Hauszuchtthiere* (1824), and *Hand. der vergleich. Anat. der Hauszuchtthiere* (2 vols., 1822); Huet, "Croisement des diverses espèces du genre cheval," *Nouv. Archives du Muséum*, and ser., tom. ii., p. 46, 1879; Leisring, *Atlas der Anatomie des Pferdes* (Leipzig, 1861); O. C. Marsh, "Notice of New Equine Mammals from the Tertiary Formation," *Amer. Journ. of Science and Arts*, vol. vii., March 1874; *Id.*, "Fossil Horses in America," *Amer. Naturalist*, vol. viii., May 1875; *Id.*, "Polydactyle Horses," *Amer. Journ. Sci. and Arts*, vol. xvii., June 1879; Franz Müller, *Lehrbuch der Anatomie des Pferdes* (Vienna, 1853); R. Owen, "Equine Remains in Caverns of Bruniquel," *Phil. Trans.* vol. clix., 1870, p. 535; W. Percivall, *The Anatomy of the Horse* (1832); G. Stubbs, *Anatomy of the Horse* (1766); W. H. Flower, *The Horse* (London, 1891); Ridgeway, *Origin of the Thoroughbred Horse* (1905). (W. H. F.; R. L.)*

HISTORY

From the evidence of philology it appears that the horse was already known to the Aryans before the period of their dispersion.¹

The first mention of the British horse occurs in the well-known passages in Caesar (*B.G.* iv. 24, 33, v. 15, 16; cf. Pomp. Mela iii. 6), in which he mentions the native "essedarii" and the skill with which they handled their war chariots. We are left quite in the dark as to the character of the animal thus employed; but there would appear to be much probability in the surmise of W. Youatt, who conjectures the horse to have been, "then as ever, the creature of the country in which he lived. With short

¹ Compare Sans, *agha*, Zendish and Old Persian *agha*, Lithuanian *asma* (mare), Prussian *aminan* (mare's milk), O.H. Ger. *ehu*, A.S. *eh*, Icel. *jár*, Gothic *aihos*, *aihos* (?), Old Irish *ech*, Old Cambrian and Gaelic *ep* (as in *Epona*, the horse goddess), Lat. *equus*, Gr. *ἵππος* or *ἵκος*. The word seems, however, to have disappeared from the Slavonic languages. The root is probably *ak*, with the idea of sharpness or swiftness (*ἄκρος*, *ἀκρίς*, *αἶα*, *αἰός*). See Pott, *Etym. Forsch.* ii. 256, and Hehn, *Kulturpflanzen u. Hausthiere in ihrem Uebergang aus Asien nach Griechenland u. Italien sowie in das übrige Europa* (3rd ed., 1877), p. 38. The last-named author, who points out the absence of the horse from the Egyptian monuments prior to the beginning of the 18th century A.C., and the fact that the earliest references to this animal in Hebrew literature (Judges v. 22, 28; cf. Josh. xi. 4) do not carry us any farther back, is of opinion that the Semitic peoples as a whole were indebted for the horse to the lands of Iran. He also shows that literature affords no trace of the horse as indigenous to Arabia prior to about the beginning of the 5th century A.D., although references abound in the pre-Islamic poetry. Horses were not numerous even in Mahomet's time (Sprenger, *Leb. Moh.* iii. 139, 140). Compare Ignazio Guidi's paper "Della sede primitiva dei popoli Semitici" in the *Transactions of the Accademia dei Lincei* (1875-1879). Professor W. Ridgeway, in his *Origin and Influence of the Thoroughbred Horse* (1905), reinvestigated the historical mystery as to the Arab breed, and its connexion with the English thoroughbred stock, but his conclusions have been hotly controverted; archaeology and biology are in fact still in the dark on the subject, but see the section on "Species" above. According to Ridgeway, the original source of the finest equine blood is Africa, still the home of the largest variety of wild Equidae; he concludes that thence it passed into Europe at an early time, to be blended with that of the indigenous Celtic species, and thence into western Asia into the veins of an indigenous Mongolian species, still represented by "Przewalski's horse"; not till a comparatively late period did it reach Arabia, though the "Arab" now represents the purest form of the Libyan blood. The controversy depends upon the consideration of a wealth of detail, which should be studied in Ridgeway's book; but zoological authorities are sceptical as to the suggested species, *Equus caballus libycus*.

fare, and exposed to the rigour of the seasons, he was probably the little hardy thing we yet see him; but in the marshes of the Nen and the Witham, and on the borders of the Tees and the Clyde, there would be as much proportionate development of frame and strength as we find at the present day." After the occupation of the country by the Romans, it appears that the horses of their cavalry were crossed with the native mares, and thus there was infused into the breed new blood, consisting probably of strains from every quarter from which Roman remounts were procured. As to the effect of this cross we are not, however, in a position to judge. We are also quite uncertain as to the extent to which the Jutes and Saxons may in their turn have again introduced a new breed of horses into England; and even to the close of the Anglo-Saxon period of English history allusions to the horse are still very infrequent. The *horsthegn* we know, however, was from an early period a high court official; and from such a law as that of Athelstan prohibiting the exportation of horses except as presents, it may be inferred that the English breed was not only much valued at home but also in great request abroad.¹

The period of the Norman Conquest marks an important stage in the history of the British horse. William the Conqueror's own horse was of the Spanish breed, and others of the same kind were introduced by the barons on their estates. But the Norman horses included many varieties, and there is no doubt that to the Conquest the inhabitants of Britain were indebted for a decided improvement in the native horse, as well as for the introduction of several varieties previously unknown. According to Giraldus Cambrensis, Roger de Bellesme, a follower of William I., afterwards created earl of Shrewsbury, imported some stallions from Spain into England; their produce was celebrated by Drayton the poet. It is curious to notice that agriculture seems to be the last use to which the horse has been put. The earliest suggestion that horses were used in agriculture is derived from a piece of the Bayeux tapestry, where a horse is represented as drawing a harrow. This, however, must have been an exceptional case, for we know that oxen were used until a comparatively late time, and that in Wales a law existed forbidding horses to be used for ploughing.

In 1121 two Eastern horses are said to have been imported, one of them remaining in England, and the other being sent as a present by King Alexander I. to the church of St Andrews, in Scotland. It has been alleged that these horses were Barbs from Morocco, but a still more likely theory is that they existed only in name, and never reached either England or Scotland. The crusades were probably the means of introducing fresh strains of blood into England, and of giving opportunity for fresh crossings. The Spanish jennet was brought over about 1182. King John gave great encouragement to horse-breeding: one of his earliest efforts was to import a hundred Flemish stallions, and, having thus paved the way for improving the breed of agricultural horses, he set about acquiring a valuable stud for his own use.

Edward III. was likewise an admirer of the horse; he procured fifty Spanish horses, probably jennets. At this time there was evidently a tendency to breed a somewhat lighter and speedier horse; but, while the introduction of a more active animal would soon have led to the displacement of the ponderous but powerful cavalry horse then in use, the substituted variety would have been unable to carry the weight of armour with which horse and rider were alike protected; and so in the end the old breed was kept up for a time. With the object of preserving to England whatever advantages might accrue from her care and skill in breeding an improved stamp of horses, Edward III. forbade their exportation; they consequently improved so rapidly in value that Richard II. compelled dealers to limit their prices to a fixed maximum. In the ninth year of his reign, Edward received from the king of Navarre a present

of two running horses, supposed to have been valuable. The wars of 1346 checked the improvement of horses, and undid much of what had been previously accomplished, for we read that the cavalry taken into France by Edward III. were but indifferently mounted, and that in consequence he had to purchase large numbers of foreign horses from Hainault and elsewhere for remounts. The reign of Richard III. does not seem to have been remarkable for the furtherance of horse-breeding; but it was then that post-horses and stages were introduced.

Our information on the whole subject is but scanty down to the reign of Henry VII., who continued the enactment against the exportation of stallions, but relaxed it in the case of mares above two years old. His object was to retain the best horses in the country, and to keep the price of them down by limiting the demand and encouraging the supply. In his reign gelding is believed to have had its origin, on account of numerous herds of horses belonging to different proprietors grazing together, especially in time of harvest. Henry VIII. was particularly careful that horse-breeding should be conducted on right principles, and his enactments, if somewhat arbitrary, were singularly to the point. In the thirty-second year of this reign, the "bill for the breed of horses" was passed, the preamble of which runs thus:—"Forasmuch as the generation and breed of good and strong horses within this realm extendeth not only to a great help and defence of the same, but also is a great commodity and profit to the inhabitants thereof, which is now much decayed and diminished, by reason that, in forests, chases, moors and waste grounds within this realm, little stoned horses and nags of small stature and of little value be not only suffered to pasture thereupon, but also to cover mares feeding there, whereof cometh in manner no profit or commodity." Section 2 of the act provides that no entire horse being above the age of two years, and not being of the height of 15 "handfuls," shall be put to graze on any common or waste land in certain counties; any one was to be at liberty to seize a horse of unlawful height, and those whose duty it was to measure horses, but who refused to do so, were to be fined 40s. By section 6 all forests, chases, commons, &c. were to be "driven" within fifteen days of Michaelmas day, and all horses, mares and colts not giving promise of growing into serviceable animals, or of producing them, were to be killed. The aim of the act was to prevent breeding from animals not calculated to produce the class of horse suited to the needs of the country. By another act (27 Henry VIII. chapter 6), after stating that the "breed of good strong horses" was likely to diminish, it was ordered that the owners of all parks and enclosed grounds of the extent of one mile should keep two mares 13 hands high for breeding purposes, or, if the extent of the ground was 4 m., four mares. The statute was not to extend to the counties of Westmorland, Cumberland, Northumberland or the bishopric of Durham. Henry took great pains to improve the royal stud: according to Sir Thomas Chaloner—a writer in the reign of Elizabeth—he imported horses from Turkey, Naples and Spain.

Queen Elizabeth is reputed to have been an accomplished horsewoman, and to have indulged in riding late in life. In the first year of her reign she revived an act passed by Henry VIII. making it felony "to sell, exchange or deliver within Scotland, or to the use of any Scottishman, any horse"; this, however, was very naturally repealed by James I. Carriages were soon after introduced, and the use of them speedily became so fashionable that a bill was brought in "to restrain the excessive and superfluous use of coaches." Prior to the introduction of carriages horseback was the means of locomotion, and Queen Elizabeth rode in state to St Paul's on a pillion; but even after carriages were used, horseback was held to be more dignified, for James I. and his judges rode on horseback to Westminster Hall. One advantage of the introduction of carriages was that it created a demand for a lighter and quicker sort of horse, instead of the ponderous animal which, despite all attempts to banish him, was still the horse of England—the age of chivalry having been the first epoch of the British horse.

Gunpowder, too, was invented; and now that the weight

¹Some fragments of legislation relating to the horse about this period may be gleaned from *Ancient Laws and Institutes of England* (fol., London, 1840), and *Ancient Laws and Institutes of Wales* (fol., London, 1841).

of the cavalry soldier was diminished by the substitution of lighter armour, a quicker and better bred horse was thought desirable for military service. The introduction of carriages and the invention of gunpowder thus opened out a new industry in breeding; and a decided change was gradually creeping on by the time that James I. came to the throne (1603), which commences the second epoch. James was a thorough sportsman, and his taste for racing, in which he freely indulged, caused him to think but little of the speed of even the best English horses. With the laudable motive, therefore, of effecting improvement in horses, he gave the then large sum of 500 guineas for an Arab stallion which had been procured from Constantinople by a Mr Markham, since known as the "Markham Arabian." This is the first authentic account we have of the importation of Arab blood, and the *Stud-Book* says he was the first of that breed ever seen in England. The people having to do with horses at that time were as conservative in their notions as most of the grooms are now, and the "Markham Arabian" was not at all approved of. The duke of Newcastle, in his treatise on horsemanship, said that he had seen the above Arabian, and described him as a small bay horse and not of very excellent shape. In this instance, however, prejudice (and it is difficult to believe that it was anything else) was right, for King James's first venture does not appear to have been a success either as a race-horse or as a sire, and thus Arabian blood was brought into disrepute. The king, however, resolved to give Eastern blood another trial, and bought a horse known as Place's White Turk from a Mr Place, who subsequently held some office in connexion with the stable under Cromwell. Charles I. followed in the footsteps of James, and lent such patronage to the breeding of a better kind of horse that a memorial was presented to him, asking that some measures might be taken to prevent the old stamp of horse "fit for the defence of the country" from dying out.

We now come to a very important period in the history of the British horse, for Charles II. warmly espoused the introduction of Eastern blood into England. He sent his master of the horse abroad to purchase a number of foreign horses and mares for breeding, and the mares brought over by him (as also many of their produce) were called "royal mares"; they form a conspicuous feature in the annals of breeding. The *Stud-Book* shows of what breed the royal mares really were: one of them, the dam of Dodswoorth (who, though foaled in England, was a natural Barb), was a Barb mare; she was sold by the stud-master, after Charles II.'s death, for forty guineas, at twenty years old, when in foal by the Helmsley Turk.

James II. was a good horseman, and had circumstances been more propitious he might have left his mark in the sporting annals of the country. In his reign, according to the *Stud-Book*, the Stradling or Lister Turk was brought into England by the duke of Berwick from the siege of Buda.

The reign of William III. is noteworthy as the era in which, among other importations, there appeared the first of three Eastern horses to which the modern thoroughbred race-horse traces back as the founders of his lineage. This was the Byerly Turk, of whom nothing more is known than that—to use the words of the first volume of the *Stud-Book*—he was Captain Byerly's charger in Ireland in King William's wars. The second of the three horses above alluded to was the Darley Arabian, who was a genuine Arab, and was imported from Aleppo by a brother of Mr Darley of Aldby Park, Yorkshire, about the end of the reign of William III. or the beginning of that of Anne. The third horse of the famous trio, the Godolphin Arabian or Barb, brought to England about five-and-twenty years after the Darley Arabian, will be more particularly referred to further on. All the horses now on the turf or at the stud trace their ancestry in the direct male line to one or other of these three—the Byerly Turk, the Darley Arabian, and the Godolphin Arabian or Barb. In the female line their pedigrees can be traced to other sources, but for all practical purposes it suffices to regard one or other of these three animals as the *ultima Thule* of racing pedigree. Of course there is a large interfusion of the blood of

each of the trio through the dams of horses of the present day; indeed, it is impossible to find an English race-horse which does not combine the blood of all three.

The Race-horse.—The third and last epoch of the British horse, viz. that of the thoroughbred racer, may be taken to date from the beginning of the 18th century. By thoroughbred is meant a horse or mare whose pedigree is registered in the *Stud-Book* kept by Messrs Weatherby, the official agents of the Jockey Club—originally termed the keepers of the match-book—as well as publishers of the *Racing Calendar*. The first attempt to evolve order out of the chaos which had long reigned supreme was made in 1791, for we find in the preface of the first volume of the *Stud-Book*, published in 1808, that "with a view to correct the then increasing evil of false and inaccurate pedigrees, the author was in the year 1791 prevailed upon to publish an *Introduction to a General Stud-Book*, consisting of a small collection of pedigrees which he had extracted from racing calendars and sale papers and arranged on a new plan." It will be seen that the compiler of the volume on which so much depends had to go back fully a century, with little else to guide him but odds and ends in the way of publications and tradition. Mistakes under such circumstances are pardonable. The *Stud-Book* then (vol. i.), which is the oldest authority we have, contains the names and in most cases the pedigrees, obscure though they may be, of a very large number of horses and mares of note from the earliest accounts, but with two exceptions no dates prior to the 18th century are specified in it. These exceptions are the Byerly Turk, who was "Captain Byerly's charger in Ireland in King William's wars (1689, &c.)," and a horse called Counsellor, bred by Mr Egerton in 1694, by Lord D'Arcy's Counsellor by Lord Lonsdale's Counsellor by the Shaftesbury Turk out of sister to Spanker—all the dams in Counsellor's pedigree tracing back to Eastern mares. There is not the least doubt that many of the animals named in the *Stud-Book* were foaled much earlier than the above dates, but we have no particulars as to time; and after all it is not of much consequence.

The *Stud-Book* goes on to say of the Byerly Turk that he did not cover many bred mares, but was the sire of the duke of Devonshire's Basto, Holloway's Jigg, and others. Jigg, or Jig, is a very important factor, as will be seen hereafter. The *Stud-Book*, although silent as to the date of his birth, says he was a common country stallion in Lincolnshire until Partner was six years old—and we know from the same authority that Partner was foaled in 1718; we may therefore conclude that Jigg was a later foal than Basto, who, according to *Whyte's History of the Turf*, was a brown horse foaled in 1703.

The reign of Queen Anne, however (1702-1714), is that which will ever be inseparably connected with the thoroughbred race-horse on account of the fame during that period of the Darley Arabian, a bay stallion, from whom our very best horses are descended. According to the *Stud-Book*, "Darley's Arabian was brought over by a brother of Mr Darley of Yorkshire, who, being an agent in merchandise abroad, became member of a hunting club, by which means he acquired interest to procure this horse." The *Stud-Book* is silent, and other authorities differ, as to the date of the importation of this celebrated Arab, some saying he came over in the year 1700, others that he arrived somewhat later; but we know from the *Stud-Book* that Manica (foaled in 1707), Aleppo (1711), Almanzor (1713), and Flying Childers (1715) were got by him, as also was Bartlett's Childers, a younger brother of Flying Childers. It is generally believed that he was imported in Anne's reign, but the exact date is immaterial, for, assuming that he was brought over as early as 1700 from Aleppo, he could scarcely have had a foal living before 1701, the first year of the 18th century. The Darley Arabian did much to remove the prejudice against Eastern blood which had been instilled into the public mind by the duke of Newcastle's denunciation of the Markham Arabian. Prince George of Denmark, consort of Queen Anne, was himself a large horse-owner; and it was in a great measure owing to his intervention that so many valuable stallions were imported during her reign.

At this period we find, among a mass of horses and mares in the *Stud-Book* without any dates against their names, many animals of note with the earliest chronology extant, from Grey Ramsden (1704) and Bay Bolton (1705) down to a mare who exercised a most important influence on the English blood-horse. This was Roxana (1718) by the Bald Galloway, her dam sister to Chanter by the Akaster Turk, from a daughter of Leedes's Arabian and a mare by Spanker. Roxana threw in 1732 the bay colt Lath by the Godolphin Arabian, the sorrel colt Round-head by Childers in 1733, and the bay colt Cade by the Godolphin Arabian in 1734, in which year she died within a fortnight after foaling, the produce—Cade—being reared on cow's milk. The Godolphin Barb or Arabian, as he was commonly called, was a brown bay about 15 hands in stature, with an unnaturally high crest, and with some white on his off hind heel. He is said to have been imported into England from France by Mr Coke, where, as the editor of the *Stud-Book* was informed by a French gentleman, he was so little thought of that he had actually drawn a cart in the streets of Paris. Mr Coke gave him to a Mr. Williams, who in his turn presented him to the earl of Godolphin. Although called an Arabian, there is little doubt he was a Barb pure and simple. In 1731, being then the property of Mr. Coke, he was teaser to Hobboglin, and on the latter refusing his services to Roxana, the mare was put to the Godolphin, and the produce was Lath (1732), the first of his get, and the most celebrated race-horse of his day after Flying Childers. He was also the sire of Cade, own brother to Lath, and of Regulus the maternal grandsire of Eclipse. He died at Gogmagog in Cambridgeshire, in the possession of Lord Godolphin, in 1753, being then, as is supposed, in his twenty-ninth year. He is believed to have been foaled in Barbary about 1724, and to have been imported during the reign of George II.

In regard to the mares generally, we have a record of the royal mares already alluded to, and likewise of three Turk mares brought over from the siege of Vienna in 1684, as well as of other importations; but it is unquestionable that there was a very large number of native mares in England, improved probably from time to time by racing, however much they may have been crossed at various periods with foreign horses, and that from this original stock were to some extent derived the size and stride which characterized the English race-horse, while his powers of endurance and elegant shape were no doubt inherited from the Eastern horses, most of which were of a low stature, 14 hands or thereabouts. It is only necessary to trace carefully back the pedigree of most of the famous horses of early times to discover faults on the side of the dam—that is to say, the expression "dam's pedigree unknown," which evidently means of original or native blood. Whatever therefore may be owing to Eastern blood, of which from the middle of the 17th to the beginning of the 18th century a complete wave swept over the British Isles, some credit is unquestionably due to the native mares (which Blaine says were mostly Cleveland bays) upon which the Arabian, Barb, or Turk blood was grafted, and which laid the foundation of the modern thoroughbred. Other nations may have furnished the blood, but England has made the race-horse.

Without prosecuting this subject further, it may be enough here to follow out the lines of the Darley Arabian, the Byerly Turk, and the Godolphin Arabian or Barb, the main ancestors of the British thoroughbred of the 18th and 19th centuries, through several famous race-horses, each and all brilliant winners,—Flying Childers, Eclipse, Herod and Matchem,—to whom it is considered sufficient to look as the great progenitors of the race-horse of to-day.

1. The Darley Arabian's line is represented in a twofold degree—first, through his son Flying Childers, his grandsons Blaze and Snip, and his great-grandson Snap, and, secondly, through his other son Bartlett's Childers and his great-grandson Eclipse. Flying or Devonshire Childers, so called to distinguish him from other horses of the same name, was a bay horse of entirely Eastern blood, with a blaze in his face and four white feet, foaled in 1715. He was bred by Mr Leonard Childers of Carr House near Doncaster,

and was purchased when young by the duke of Devonshire. He was got by the Darley Arabian from Betty Leedes, by Careless from sister to Leedes, by Leedes's Arabian from a mare by Spanker out of a Barb mare, who was Spanker's own mother. Spanker himself was by D'Arcy's Yellow Turk from a daughter of the Morocco Barb and Old Bald Peg, by an Arab horse from a Barb mare. Careless was by Spanker from a Barb mare, so that Childers's dam was closely in-bred to Spanker. Flying Childers—the wonder of his time—was never beaten, and died in the duke of Devonshire's stud in 1741, aged twenty-six years. He was the sire of, among other horses, Blaze (1733) and Snip (1736). Snip too had a celebrated son called Snap (1750), and it is chiefly in the female line through the mares by these horses, of which there are fully thirty in the *Stud-Book*, that the blood of Flying Childers is handed down to us.

The other representative line of the Darley Arabian is through Bartlett's Childers, also bred by Mr Leonard Childers, and sold to Mr Bartlett of Masham, in Yorkshire. He was for several years called Young Childers,—it being generally supposed that he was a younger brother of his Flying namesake, but his date of birth is not on record,—and subsequently Bartlett's Childers. This horse, who was never trained, was the sire of Squire (1732), whose son Marske (1750) begat Eclipse and Young Marske (1762), sire of Shuttle (1793). This at least is the generally accepted theory, although Eclipse's dam is said to have been covered by Shakespeare as well as by Marske. Shakespeare was the son of Hobboglin by Aleppo, and consequently the male line of the Darley Arabian would come through these horses instead of through Bartlett's Childers, Squire, and Marske; the *Stud-Book* however, says that Marske was the sire of Eclipse. This last-named celebrated horse—perhaps the most celebrated in the annals of the turf—was foaled on the 1st of April 1764, the day on which a remarkable eclipse of the sun occurred, and he was named after it. He was bred by the duke of Cumberland, after whose decease he was purchased by a Mr Wildman, and subsequently sold to Mr D. O'Kelly, with whom he will ever be identified. His dam Spiletta was by Regulus, son of the Godolphin Barb, from Mother Westera, by a son of Snake from a mare by Old Montague out of a mare by Hautboy, from a daughter of Brimmer and a mare whose pedigree was unknown. In Eclipse's pedigree there are upwards of a dozen mares whose pedigrees are not known, but who are supposed to be of native blood. Eclipse was a chestnut horse with a white blaze down his face; his off hind leg was white from the hock downwards, and he had black spots upon his rump—this peculiarity coming down to the present day in direct male descent. His racing career commenced at five years of age, viz. on the 3rd May 1769, at Epsom, and terminated on the 4th October 1770, at Newmarket. He ran or walked over for eighteen races, and was never beaten. It was in his first race that Mr O'Kelly took the odds to a large amount before the start for the second heat, that he would place the horses. When called upon to declare, he uttered the exclamation, which the event justified, "Eclipse first, and the rest nowhere."

Eclipse commenced his stud career in 1771, and had an enormous number of foals, of which four only in the direct male line have come down to us, viz. Pot-o-cooco, or, as he is commonly called, Pot-8-os (1773), his most celebrated son, King Fergus (1775), Joe Andrews (1778), and Mercury (1778), though several others are represented in the female line. Pot-8-os was the sire of Waxy (1790) out of Maria (1777) by Herod out of Lisette (1772) by Snap. Waxy, who has been not inaptly termed the ace of trumps in the *Stud-Book*, begat Whalebone (1807), Web (1808), Woful (1809), Wire (1811), Whisker (1812), and Waxy Pope (1806), all but the last being out of Penelope (1798) by Trumpator (1782) from Prunella (1788) by Highflyer out of Promise by Snap, while Waxy Pope was out of Prunella, dam of Parasol (1800) by Pot-8-os. Trumpator was a son of Conductor, who was by Matchem out of a mare by Snap.

Whalebone's best sons were Camel (1822) and Sir Hercules (1826). Camel was the sire of Defence (1824) and Touchstone (1831), while Sir Hercules was the sire of Birdcatcher (1833) and Faugh-a-Ballagh (1841), own brothers, and of Gemma di Vergy (1854). Touchstone was the sire of Newminster (1848), who begat Lord Clifden, Adventurer, and the Hermit, as well as of Orlando (1841), sire of Tedington (1848). Whalebone's blood also descends through Waverley (1817) and his son the Saddler (1828), while Whisker is represented by the Colonel (1825) and by Economist (1825) and his son Harkaway (1834), sire of King Tom (1851). Birdcatcher begat, besides Saunterer (1854), the Baron (1842), sire of Stockwell (1849) and of Rataplan (1850). Stockwell, who was a chestnut with black spots, was the sire of Blair Athol (1861), a chestnut, and also of Doncaster (1870), another chestnut, but with the characteristic black spots of his grandsire; and Doncaster was the sire of the chestnut Bead Or (1877).

To turn to Eclipse's other sons. King Fergus (1775) was the sire of Benningbrough (1791), whose son was Orville (1799), whence comes some of the stoutest blood on the turf, including Emilius (1820) and his son Priam (1827), Plenipotentiary (1831), Muley (1810), Chesterfield (1834), and the Hero (1843). Joe Andrews (1778) was the sire of Dick Andrews (1797), and from him descend Tramp (1810), Lottery (1820), Liverpool (1828), Sheet Anchor (1832), Lanercost (1835), Weatherbit (1842), Beadman (1855), and

HORSE



Suffolk Stallion.



Shire Stallion.





Shetland Pony Stallion.



Polo Pony Stallion.



Thoroughbred Stallion.



Coaching Stallion.

Breeds of Horses. (From Photographs by F. Bobbage.)
The comparative sizes of the horses are shown.

Blue Gown (1865). Mercury was sire of Gohanna (1790), who was foaled in the same year as Waxy, and the two, who were both grandsons of Eclipse and both out of Herod mares, had several contests, Waxy generally getting the better of his cousin. Gohanna's descendants come down through Golumpus (1802), Catton (1809), Mulatto (1823), Royal Oak (1823), and Slane (1833).

2. The Byerly Turk's line is represented by Herod, the Turk being the sire of Jigg, who was the sire of Partner (1718); whose son Tartar (1743) begat King Herod, or Herod as he was commonly called, foaled in 1758. Herod's dam was Cyron (1750) by Blaise (1733), son of Flying Childers. Cyron's dam was Selma by Bethel's Arabian from a mare by Graham's Champion from a daughter of the Darley Arabian and a mare who claims Merlin for her sire, but whose mother's pedigree is unknown. In Herod's pedigree there are fully a dozen dams whose pedigree is unknown; Herod was a bay horse about 15 hands 3 inches high, possessed both of substance and length,—those grand requisites in a race-horse,—combined with uncommon power and stamina or lasting qualities. He was bred by William, duke of Cumberland, uncle of King George III. He commenced his racing career in October 1763, when he was five years old, and ended it on the 16th of May 1767. He ran ten times, winning six and losing four races. He died in 1780, and among other progeny left two famous sons, Woodpecker (1773), whose dam was Miss Ramsden (1760) by Cade, son of the Godolphin Barb, but descended also on the dam's side from the Darley Arabian and the Byerly Turk, and Highflyer (1774), whose dam was Rachel (1763) by Blank, son of the Godolphin Barb from a daughter of Regulus, also son of the Godolphin. These two horses have transmitted Herod's qualities down to the present day in the direct male line, although in the female line he is represented through some of his other sons and his daughters as well. Woodpecker was the sire of Buzzard (1787), who in his turn became the father of three celebrated sons, Castrel (1801), Selim (1802), and Rubens (1803), all three chestnuts, and all out of an Alexander mare (1790), who thereby became famous. This mare was by Eclipse's son Alexander (1782) out of a mare by Highflyer (son of Herod) out of a daughter of Alfred, by Matchem out of a daughter of Snap. Bustard (1813), whose dam was a daughter of Shuttle, and his son Heron (1833), Sultan (1816) and his sons Glencoe (1831) and Bay Middleton (1833) and Middleton's sons Cowl (1842) and the Flying Dutchman (1845), Pantaloon (1824) and his son Windhound (1847), Langar (1817) and his son Epirus (1834) and grandson Pyrrhus the First (1843), are representatives of Castrel and Selim.

Highflyer is represented through his greatly esteemed son Sir Peter Teazle, commonly called Sir Peter (1784), whose dam was Papillon by Snap. Sir Peter had five sons at the stud, Walton (1790), Stamford (1794), and Sir Paul (1802) being the chief. Paulowitz (1813), Cain (1822), Ion (1835), Wild Dayrell (1852), and his son Buccaneer (1857) bring down Sir Paul's blood; whilst Walton is represented through Phantom (1806), Partisan (1811) and his sons Glaucus (1829) and Venison (1833) and Gladiator (1833), Venison's sons Alarm (1842) and Kingston (1849), Gladiator's son Sweetmeat (1842), Sweetmeat's sons Macaroni (1860) and Parmesan (1857), and Parmesan's sons Favonius (1868) and Cremorne (1869). It may be added that in the first volume of the *Stud-Book* there are nearly a hundred Herod and Highflyer mares registered.

3. The Godolphin Barb is represented by Matchem, as the former was the sire of Cade (1734), and Cade begat Matchem, who was foaled in 1748. He was thus ten years the senior of Herod, representing the Byerly Turk, and sixteen years before Eclipse, though long subsequent to Flying Childers, who represent the Darley Arabian. Matchem was a brown bay horse with some white on his off hind heel, about 15 hands high, bred by Sir John Holme of Carlisle, and sold to Mr W. Fenwick of Bywell, Northumberland. His dam was sister to Miss Partner (1735) by Partner out of Brown Farewell by Makeless (son of the Oglethorpe Arabian) from a daughter of Brimmer out of Trumpet's dam, by Place's White Turk from a daughter of the Barb Dodsworth and a Layton Barb mare; while Brimmer was by D'Arcy's Yellow Turk from a royal mare. Matchem commenced his racing career on the 2nd of August 1753, and terminated it on 1st September 1758. Out of thirteen engagements he won eleven and lost two. He died in 1781, aged thirty-three years. His best son was Conductor (1767) out of a mare by Snap; Conductor was the sire of Trumpeter (1782), whose two sons, Sorcerer (1790) and Paynator (1791), transmit the blood of the Godolphin down to modern times. Sorcerer was the sire of Soothsayer (1808), Comus (1809), and Smolensko (1810). Comus was the sire of Humphrey Clinker (1822), whose son was Melbourne (1834), sire of West Australian (1850) and of many valuable mares, including Canezou (1845) and Blink Bonny (1854), dam of Blair Athol. Paynator was the sire of Dr Syntax (1811), who had a celebrated daughter called Beeswing (1833), dam of Newminster by Touchstone.

The gems of the three lines may be briefly enumerated thus: (1) of the Darley Arab's line—Snap, Shuttle, Waxy, and Orville—the stoutest blood on the turf; (2) of the Byerly Turk's line—Buzzard and Sir Peter—speedy blood, the latter the stouter of the two; (3) of the Godolphin Barb's line—Sorcerer—often producing large-sized animals, but showing a tendency to die out, and becoming rare.

On the principle that as a rule like begets like, it has been the practice to select as sires the best public performers on the turf, and of two horses of like blood it is sound sense to choose the better as against the inferior public performer. But there can be little doubt that the mating of mares with horses has been often pursued on a haphazard plan, or on no system at all; to this the *Stud-Book* testifies too plainly. In the article HORSE-RACING mention is made of some of the great horses of recent years; but the following list of the principal sires of earlier days indicates also how their progeny found a place among the winners of the three great races, the Derby (D), Oaks (O), and St Leger (L):—

Eclipse: Young Eclipse (D), Saltram (D), Sergeant (D), Annette (O).
Herod: Bridget (O), Faith (O), Maid of the Oaks (O), Phenomenon (L).
Matchem: Teetotum (O), Hollandaise (L).
Florizel (son of Herod): Diomed (D), Eager (D), Tartar (L), Ninety-three (L).
Highflyer: Noble (D), Sir Peter Teazle (D), Skyscraper (D), Violante (O), Omphale (L), Cowslip (L), Spadille (L), Young Flora (L).
Pol-8-os: Waxy (D), Champion (D), Tyrant (D), Nightshade (O).
Sir Peter (D): Sir Harry (D), Archduke (D), Ditto (D), Paris (D), Hermione (O), Parasite (O), Ambrosia (L), Fyldener (L), Paulina (L), Petronius (L).
Waxy (D): Pope (D), Whalebone (D), Blucher (D), Whisker (D), Music (O), Minuet (O), Corinne (O).
Whalebone (D): Moses (D), Landog (D), Spaniel (D), Caroline (O).
Woful: Augusta (O), Zinc (O), Theodore (L).
Whisker (D): Memnon (L), The Colonel (L).
Phantom: Cedric (D), Middleton (D), Cobweb (O).
Orville (L): Octavius (D), Emilius (D), Ebor (L).
Trump: St Giles (D), Dangerous (D), Barefoot (L).
Emilius (D): Priam (D), Plenipotentiary (D), Oxygen (O), Mango (L).
Priam (D): Miss Seltz (O), Industry (O), Crucifix (O).
Sir Hercules: Coronation (D), Faugh-a-Ballagh (L), Birdcatcher (L).
Touchstone (L): Cotherstone (D), Orlando (D), Surplice (D, L), Mendicant (O), Blue Bonnet (L), Newminster (L).
Birdcatcher (L): Daniel O'Rourke (D), Songstress (O), Knight of St George (L), Warlock (L), The Baron (L).
The Baron (L): Stockwell (L).
Melbourne: West Australian (D, L), Blink Bonny (D, O), Sir Tatton Sykes (L).
Newminster (L): Musjid (D), Hermit (D), Lord Clifden (L).
Sweetmeat: Macaroni (D), Mincepie (O), Mincepie (O).
Stockwell (L): Blair Athol (D, L), Lord Lyon (D, L), Doncaster (D), Regalia (O), St Albans (L), Caller Ou (L), The Marquis (L), Achievement (L).
King Tom: Kingcraft (D), Tormentor (O), Hippias (O), Hannah (O, L).
Rataplan (son of the Baron): Kettledrum (D).
Monarque: Gladiateur (D, L).
Parmesan (son of Sweetmeat): Favonius (D), Cremorne (D).
Buccaneer: Kieber (D), Formosa (O, L), Brigantine (O).
Lord Clifden (L): Jannette (O, L), Hawthornden (L), Wenlock (L), Petrarch (L).
Adventurer: Pretender (D), Apology (O, L), Wheel of Fortune (O).
Blair Athol (D, L): Silvio (D, L), Craig Millar (L).

In regard to mares it has very frequently turned out that animals which were brilliant public performers have been far less successful as dams than others which were comparatively valueless as runners. Beeswing, a brilliant public performer, gave birth to a good horse in Newminster; the same may be said of Alice Hawthorn, dam of Thormanby, of Canezou, dam of Fazzoletto, of Crucifix, dam of Surplice, and of Blink Bonny, dam of Blair Athol; but many of the greatest winners have dropped nothing worth training. On the other hand, there are mares of little or no value as racers who have become the mothers of some of the most celebrated horses on the turf; among them we may cite Queen Mary, Pocahontas and Paradigm. Queen Mary, who was by Gladiator out of a daughter of Plenipotentiary and Myrrha by Whalebone, when mated with Melbourne produced Blink Bonny (winner of the Derby and Oaks); when mated with Mango and Lanercost she produced Haricot, dam of Caller Ou (winner of the St Leger). Pocahontas, perhaps the most remarkable mare in the *Stud-Book*, never won a race on the turf, but threw Stockwell and Rataplan to the Baron, son of Birdcatcher, King Tom to Harkaway, Knight of St Patrick to Knight of St George, and Knight of Kars to Nutwith—all these horses being 16 hands high and upwards, while Pocahontas was

a long low mare of about 15 hands or a trifle more. She also gave birth to Ayacanora by Birdcatcher, and to Araucaria by Ambrose, both very valuable brood mares, Araucaria being the dam of Chamant by Mortemer, and of Rayon d'Or by Flageolet, son of Plutus by Touchstone. Paradigm again produced, among several winners of more or less celebrity, Lord Lyon (winner of the Two Thousand Guineas, Derby and St Leger) and Achievement (winner of the St Leger), both being by Stockwell. Another famous mare was Manganese (1853) by Birdcatcher from Moonbeam by Tomboy from Lunatic by the Prime Minister from Maniac by Shuttle. Manganese when mated with Rataplan threw Mandragora, dam of Apology, winner of the Oaks and St Leger, whose sire was Adventurer, son of Newminster. She also threw Mineral, who, when mated with Lord Clifden, produced Wenlock, winner of the St Leger, and after being sold to go to Hungary, was there mated with Buccaneer, the produce being Kisber, winner of the Derby.

We append the pedigree of Blair Athol, winner of the Derby and St Leger in 1864, who, when subsequently sold by auction, fetched the then unprecedented sum of 12,000 guineas, as it contains, not only Stockwell (the emperor of stallions, as he has been termed), but Blink Bonny and Eleanor—in which latter animal are combined the blood of Eclipse, Herod, Matchem and Snap,—the mares that won the Derby in 1801 and 1857 respectively, as well as those queens of the stud, Eleanor's great-granddaughter Pocahontas and Blink Bonny's dam Queen Mary. Both Eleanor and Blink Bonny won the Oaks as well as the Derby.

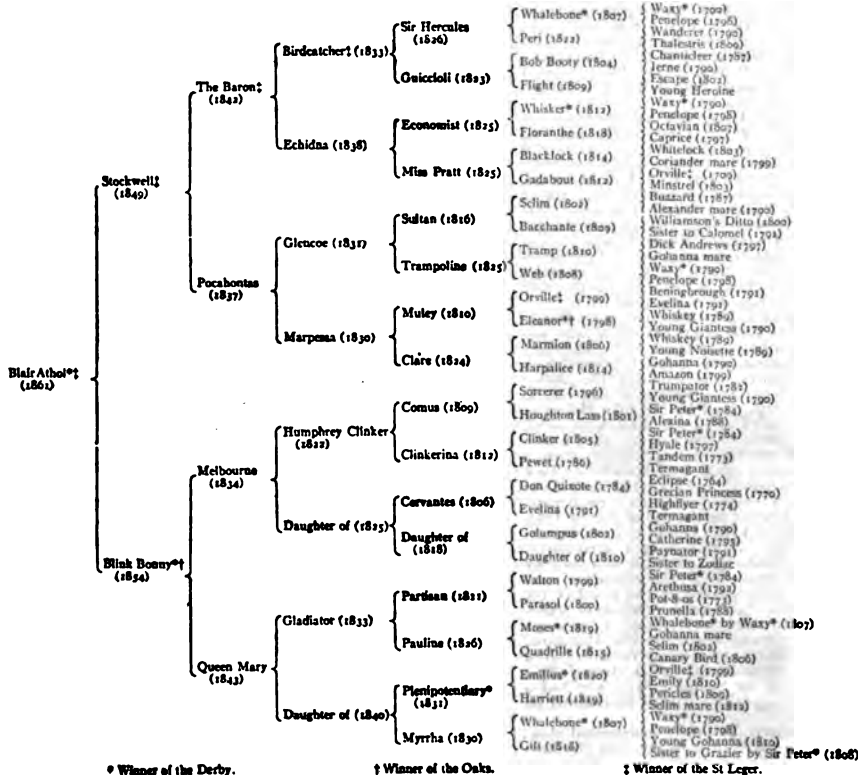

* Winner of the Derby.

† Winner of the Oaks.

‡ Winner of the St Leger.

The shape of a race-horse is of considerable importance, although it is said with some degree of truth that they win in

all shapes. There are the neat and elegant animals, like the descendants of Saunterer and Sweetmeat; the large-framed, plain-looking, and heavy-headed Melbournes, often with lop ears; the descendants of Birdcatcher, full of quality, and of more than average stature, though sometimes disfigured with curby hocks; and the medium-sized but withal speedy descendants of Touchstone, though in some cases characterized by somewhat loaded shoulders. In height it will be found that the most successful racers average from 15 to 16½ hands, the former being considered somewhat small, while the latter is unquestionably very large; the mean may be taken as between 15½ and 16 hands (the hand = 4 in.). The head should be light and lean, and well set on; the ears small and pricked, but not too short; the eyes full; the forehead broad and flat; the nostrils large and dilating; the muzzle fine; the neck moderate in length, wide, muscular, and yet light; the throat clean; the windpipe spacious and loosely attached to the neck; the crest thin, not coarse and arched. The withers may be moderately high and thin; the chest well developed, but not too wide or deep; the shoulder should lie well on the chest, and be oblique and well covered with muscle, so as to reduce concussion in galloping; the upper and lower arms should be long and muscular; the knees broad and strong; legs short, flat and broad; fetlock joints large; pasterns strong and of moderate length; the feet should be moderately large, with the heels open and frogs sound—with no signs of contraction. The body or barrel should be moderately deep, long and straight, the length being really in the shoulders and in the quarters; the back should be strong

and muscular, with the shoulders and loins running well in at each end; the loins themselves should have great breadth and substance, this being a vital necessity for weight-carrying and propelling power uphill. The hips should be long and wide, with the stifle and thigh strong, long and proportionately developed, and the hind quarters well let down. The hock should have plenty of bone, and be strongly affixed to the leg, and show no signs of curb; the bones below the hock should be flat, and free from adhesions; the ligaments and tendons well developed, and standing out from the bone; the joints well formed and wide, yet without undue enlargement; the pasterns and feet similar to those of the forehead. The tail

should be high set on, the croup being continued in a straight line to the tail, and not falling away and drooping

to a low-set tail. Fine action is the best criterion of everything fitting properly, and all a horse's points ought to harmonize or be in proportion to one another, no one point being more prominent than another, such as good shoulders, fine loins or excellent quarters. If the observer is struck with the remarkable prominence of any one feature, it is probable that the remaining parts are deficient. A well-made horse wants dissecting in detail, and then if a good judge can discover no fault with any part, but finds each of good proportions, and the whole to harmonize without defect, deformity or deficiency, he has before him a well-shaped horse; and of two equally well-made and equitably proportioned horses the best bred one will be the best. As regards hue, the favourite colour of the ancients, according to Xenophon, was bay, and for a long time it was the fashionable colour in England; but for some time chestnut thoroughbreds have been the most conspicuous figure on English race-courses, so far as the more important events are concerned. Eclipse was a chestnut; Castrel, Selim and Rubens were chestnuts; so also were Glencoe and Pantaloon, of whom the latter had black spots on his hind quarters like Eclipse; and also Stockwell and Doncaster. Birdcatcher was a chestnut, so also were Stockwell and his brother Rataplan, Manganese, Mandragora, Thormanby, Kettle drum, St Albans, Blair Athol, Regalia, Formosa, Hermit, Marie Stuart, Doncaster, George Frederick, Apology, Craig Millar, Prince Charlie, Rayon d'Or and Bend Or. The dark browns or black browns, such as the Sweetmeat tribe, are not so common as the bays, and black or grey horses are almost as unusual as roans. The skin and hair of the thoroughbred are finer, and the veins which underlie the skin are larger and more prominent than in other horses. The mane and tail should be silky and devoid of curl, which is a sign of impurity.

Whether the race-horse of to-day is as good as the stock to which he traces back has often been disputed, chiefly no doubt because he is brought to more early maturity, commencing to win races at two years instead of at five years of age, as in the days of Childers and Eclipse; but the highest authorities, and none more emphatically than the late Admiral Rous, have insisted that he can not only stay quite as long as his ancestors, but also go a good deal faster. In size and shape the modern race-horse is unquestionably superior, being on an average fully a hand higher than the Eastern horses from which he is descended; and in elegance of shape and beauty of outline he has certainly never been surpassed. That experiments, founded on the study of his nature and properties, which have from time to time been made to improve the breed, and bring the different varieties to the perfection in which we now find them, have succeeded, is best confirmed by the high estimation in which the horses of Great Britain are held in all parts of the civilized world; and it is not too much to assert that, although the cold, humid and variable nature of their climate is by no means favourable to the production of these animals in their very best form, Englishmen have by great care, and by sedulous attention to breeding, high feeding and good grooming, with consequent development of muscle, brought them to the highest state of perfection of which their nature is capable. (E. D. B.)

BREEDS OF HORSES

The British breeds of *light* horses include the Thoroughbred, the Yorkshire Coach-horse, the Cleveland Bay, the Hackney and the Pony; of *heavy* horses, the Shire, the Clydesdale and the Suffolk.

The *Thoroughbred* is probably the oldest of the breeds, and it is known as the "blood-horse" on account of the length of time through which its purity of descent can be traced. The frame is light, slender and graceful. The points of chief importance are a fine, clean, lean head, set on free from collar heaviness; a long and strongly muscular neck, shoulders oblique and covered with muscle; high, long withers, chest of good depth and narrow but not extremely so; body round in type, back rib well down; depth at withers a little under half the height; length equal to the height at withers and croup; loins level and muscular;

croup long, rather level; tail set on high and carried gracefully; the hind quarters long, strongly developed, and full of muscle and driving power; the limbs clean-cut and sinewy, possessing abundance of good bone, especially desired in the cannons, which are short, broad and flat; comparatively little space between the fore legs; pastern joints smooth and true; pasterns strong, clean and springy, sloping when at rest at an angle of 45°; feet medium size, wide and high at the heels, concave below and set on straight. The action in trotting is generally low, but the bending of the knee and the flexing of the hock is smooth, free and true. The thoroughbred is apt to be nervous and excitable, and impatient of common work, but its speed, resolution and endurance, as tested on the race-course, are beyond praise.

Many of the best hunters in the United Kingdom are thoroughbreds, but of the substantial weight-carrying type. The Hunters Improvement Society, established in 1885, did not restrict entries to the *Hunters' Stud-Book* to entirely clean-bred animals, but admitted those with breeding enough to pass strict inspection. This society acts in consort with two other powerful organizations (the Royal Commission on Horse-breeding, which began its work in 1888, and the Brood Mare Society, established in 1903), with the desirable object of improving the standard of light horse breeding. The initial efforts began by securing the services of thoroughbred stallions for specified districts, by offering a limited number of "Queen's Premiums," of £200 each, to selected animals of four years old and upwards. Since the formation of the Brood Mare Society mares have come within the sphere of influence of the three bodies, and well-conceived inducements are offered to breeders to retain their young mares at home. The efforts have met with gratifying success, and they were much needed, for while in 1904 the Dutch government took away 350 of the best young Irish mares, Great Britain was paying the foreigner over £2,000,000 a year for horses which the old system of management did not supply at home. The Royal Dublin Society also keeps a *Register of Thoroughbred Stallions* under the horse-breeding scheme of 1892, which, like the British effort, is now bearing fruit.

The *Yorkshire Coach-horse* is extensively bred in the North and East Ridings of Yorkshire, and the thoroughbred has taken a share in its development. The colour is usually bay, with black or brown points. A fine head, sloping shoulders, strong loins, lengthy quarters, high-stepping action, flat bone and sound feet are characteristic. The height varies from 16 hands to 16 hands 2 in.

The *Cleveland Bay* is an ancestor of the Yorkshire Coach-horse and is bred in parts of Yorkshire, Durham and Northumberland. He is adapted alike for the plough, for heavy draught, and for slow saddle work. Some specimens make imposing-looking carriage horses, but they have low action and are lacking in quality. The colour is light or dark bay, with black legs. Though rather coarse-headed, the Cleveland Bay has a well-set shoulder and neck, a deep chest and round barrel. The height is from 16 to 17 hands.

The *Hackney* has come prominently to the front in recent years. The term *Nag*, applied to the active riding or trotting horse, is derived from the A.S. *hneagan*, to neigh. The Normans brought with them their own word *haquente*, or *haquente*, a French derivative from the Latin *equus*, a horse, whence the name hackney. Both nag and hackney continue to be used as synonymous terms. Frequent mention is made of hackneys and trotters in old farm accounts of the 14th century. The first noteworthy trotting hackney stallion, of the modern type, was a horse foaled about 1755, and known as the Shales, Shields or Shales horse, and most of the recognized hackneys of to-day trace back to him. The breeding of hackneys is extensively pursued in the counties of Norfolk, Cambridge, Huntingdon, Lincoln and York, and in the showyard competitions a keen but friendly rivalry is usually to be noticed between the hackney-breeding farmers of Norfolk and Yorkshire. The high hackney action is uncomfortable in a riding horse. Excellent results have sometimes followed the use of hackney sires upon half-bred mares, *i.e.* by thoroughbred stallions and trotting

mares, but it is not always so. As regards the movement, or "action," of the hackney, he should go light in hand, and the knee should be well elevated and advanced during the trot, and, before the foot is put down, the leg should be well extended. The hackney should also possess good hock action, as distinguished from mere fetlock action, the propelling power depending upon the efficiency of the former. The hackney type of the day is "a powerfully built, short-legged, big horse, with an intelligent head, neat neck, strong, level back, powerful loins, and as perfect shoulders as can be obtained, good feet, flat-boned legs, and a height of from 15 hands 2 in. to 15 hands 3½ in. Carriage-horses hackney-bred have been produced over 17 hands high.

The *Pony* differs essentially from the hackney in height, the former not exceeding 14 hands. There is one exception, which is made clear in the following extract from Sir Walter Gilbey's *Ponies Past and Present* (1900):—

Before the establishment of the Hackney Horse Society in 1883 the dividing line between the horse and the pony in England was vague and undefined. It was then found necessary to distinguish clearly between horses and ponies, and, accordingly, all animals measuring 14 hands or under were designated "ponies," and registered in a separate part of the (Hackney) Stud-Book. This record of height, with other particulars as to breeding, &c., serves to direct breeders in their choice of sires and dams. The standard of height established by the Hackney Horse Society was accepted and officially recognized by the Royal Agricultural Society in 1889, when the prize-list for the Windsor show contained pony classes for animals not exceeding 14 hands. The altered polo-rule, which fixes the limit of height at 14 hands 2 in., may be productive of some little confusion; but for all other purposes 14 hands is the recognized maximum height of a pony. Prior to 1883 small horses were called indifferently Galloways, hobbies, cobs or ponies, irrespective of their height.

Native ponies include those variously known as Welsh, New Forest, Exmoor, Dartmoor, Cumberland and Westmorland, Fell, Highland, Highland Garron, Celtic, Shetland and Connemara. Ponies range in height from 14 hands down to 8 hands, Shetland ponies eligible for the Stud-Book not exceeding the latter. As in the case of the hackney, so with the pony, thoroughbred blood has been used, and with good results, except in the case of those animals which have to remain to breed in their native haunts on the hills and moorlands. There the only possible way of improvement is by selecting the best native specimens, especially the sires, to breed from. The thin-skinned progeny of thoroughbred or Arab stock is too delicate to live unless when hand-fed—and hand-feeding is not according to custom. Excellent polo ponies are bred as first or second crosses by thoroughbred stallions on the mares of nearly all the varieties of ponies named. The defective formation of the pony, the perpendicular shoulder and the drooping hind quarters, are modified; but neither the latter, nor bent hocks, which place the hind legs under the body as in the zebra, are objected to, as the conformation is favourable to rapid turning. One object of the pony breeder, while maintaining hardness of constitution, is to control size—to compress the most valuable qualities into small compass. He endeavours to breed an animal possessing a small head, good shoulders, true action and perfect manners. A combination of the best points of the hunter with the style and finish of the hackney produces a class of weight-carrying pony which is always saleable.

The *Shire* horse owes its happily-chosen name to Arthur Young's remarks, in the description of his agricultural tours during the closing years of the 18th century, concerning the large Old English Black Horse, "the produce principally of the *Shire* counties in the heart of England." Long previous to this, however, the word *Shire*, in connexion with horses, was used in the statutes of Henry VIII. Under the various names of the War Horse, the Great Horse, the Old English Black Horse and the *Shire* Horse, the breed has for centuries been cultivated in the rich fen-lands of Lincolnshire and Cambridgeshire, and in many counties to the west. The *Shire* is the largest of draught horses, the stallion commonly attaining a height of 17 to 17½ hands. Though the black colour is still frequently met with, bay and brown are more usually seen. With their immense size and

weight—1800 lb to 2200 lb—the *Shires* combine great strength, and they are withal docile and intelligent. They stand on short stout legs, with a plentiful covering—sometimes too abundant—of long hair extending chiefly down the back but also round the front of the limbs from knees and hocks, and when in full feather obscuring nearly the whole of the hoofs. The head is a good size, and broad between the eyes; the neck fairly long, with the crest well arched on to the shoulders, which are deep and strong, and moderately oblique. The chest is wide, full and deep, the back short and straight, the ribs are round and deep, the hind quarters long, level and well let down into the muscular thighs. The cannon-bones should be flat, heavy and clean, and the feet wide, tough, and prominent at the heels. A good type of *Shire* horse combines symmetrical outlines and bold, free action. There is a good and remunerative demand for *Shire* geldings for use as draught horses in towns.

The *Clydesdale*, the Scottish breed named from the valley of the Clyde, is not quite so large as the *Shire*, the average height of stallions being about 16 hands 2 in. The popular colour is bay, particularly if of a dark shade, or dappled. Black is not uncommon, but grey is not encouraged. White markings on one or more of the legs, with a white star or stripe on the face, are characteristic. The long hair on the legs is not so abundant as in the *Shires*, and it is finer in texture. It is regarded as an indication of good bone. The bones of the legs should be short, flat, clean and hard; the feet large, with hoofs deep and concave below. With its symmetry, activity, strength and endurance the *Clydesdale* is easily broken to harness, and makes an excellent draught horse. This breed is growing rapidly in favour in Canada, but in the United States the *Percheron*, with its round bone and short pasterns, holds the field. A blend of the *Shire* and *Clydesdale* strains of the British rough-legged draught horse (virtually sections of the same breed) is a better animal than either of the parents. It is an improvement upon the *Shire* due to the quality contributed by the *Clydesdale*, and it surpasses the *Clydesdale* in strength and substance, as a result of the *Shire* connexion. To secure success the two Stud-Books will require to be opened to animals eligible to be entered in either record. The blend is being established in U.S.A. as a National breed.

The *Suffolk* is a horse quite distinct from the *Shire* and the *Clydesdale*. Its body looks too heavy for its limbs, which are free from the "feather" so much admired in the two other heavy breeds; it possesses a characteristic chestnut colour. How long the *Suffolks* have been associated with the county after which they are named is unknown, but they are mentioned in 1586 in Camden's *Britannia*. With an average height of about 16 hands they often have a weight of as much as 2000 lb., and this may explain the appearance which has given rise to the name of the *Suffolk Punch*, by which the breed is known. The *Suffolk* is a resolute and unwavering worker, and is richly endowed with many of the best qualities of a horse. The *Suffolk Stud-Book and History of the Breed*, published in 1880, is the most exhaustive record of its kind in England. (W. FR.; R. W.)

MANAGEMENT

Breeding.—Animals to breed from should be of good blood, sound and compactly built, with good pluck and free from nervous excitability and vicious tendency. A mare used to be put to the horse at three years old, but latterly two has become the common age. Young sires begin to serve in moderation at two. May is considered the best month for a mare to foal, as there is abundance of natural food and the weather is mild enough for the mare to lie out. Show specimens generally profit by being born earlier. The period of gestation in the mare is about eleven months. No nursing mare should go to work, if this can possibly be avoided. A brood mare requires plenty of exercise at a slow pace and may work, except between shafts on a road, till the day of foaling.

To avoid colic an animal has to be gradually prepared by giving small quantities of green food for a few days before going to grass. Shelter against severe storms is needed. Succulent food encourages the flow of milk, and the success of the foal

greatly depends on its milk supply. Mares most readily conceive when served at the "foal heat" eleven days after foaling. A mature stallion can serve from eighty to one hundred mares per annum.

Foals are weaned when five or six months old, often in October, and require to be housed to save the foal-flesh, and liberally but not overfed; but from the time they are a month old they require to be "gentled" by handling and kindly treatment, and the elementary training of leading from time to time by a halter adjusted permanently to the head. When they are hand-reared on cow's milk foals require firm treatment and must have no fooling to teach them tricks. Young horses that are too highly fed are apt to become weak-limbed and top-heavy.

Breaking.—Systematic breaking begins at about the age of two years, and the method of subduing a colt by "galvayning" is as good as any. It is a more humane system than "rareying," which overcame by exhaustion under circumstances which were not fruitful of permanent results. Galvayning is accomplished by bending the horse's neck round at an angle of thirty-five to forty degrees and tying the halter to the tail, so that when he attempts to walk forward he holds himself and turns "round and round, almost upon his own ground." The more strenuous his resistance the sooner he yields to the inevitable force applied by himself. A wooden pole, the "third hand," is then gently applied to all parts of the body until kicking or any form of resistance ceases. "Biting" or "mouthing," or the familiarizing of an animal to the bit in his mouth, and to answer to the rein without bending his neck, is still a necessity with the galvayning method of breaking. Experience can only be gained by a horse continuing during a considerable time to practise what he has been taught.

Three main characteristics of a successful horse-breaker are firmness, good temper and incessant vigilance. Carelessness in trusting too much to a young colt that begins its training by being docile is a fruitful source of untrustworthy habits which need never have developed. Driving with long reins in the field should precede the fastening of ropes to the collar, as it accustoms the animal to the pressure on the shoulders of the draught, later to be experienced in the yoke. If a young horse be well handled and accustomed to the dummy jockey, mounting it is not attended with much risk of resistance, although this should invariably be anticipated. An animal ought to be in good condition when being broken in, else it is liable to break out in unpleasant ways when it becomes high-spirited as a result of improved condition. It should be well but not overfed, and while young not overworked, as an overtired animal is liable to refuse to pull, and thus contract a bad habit. Most bad habits and stable tricks are the result of defective management and avoidable accidents.

Feeding.—Horses have small stomachs relatively to ruminating animals, and require small quantities of food frequently. While grazing they feed almost continually, preferring short pasture. No stable food for quick work surpasses a superior sample of fine-hulled whole oats like "Garton's Abundance" (120 lb per week), and Timothy hay harvested in dry weather. The unbruised oats develop a spirit and courage in either a saddle or harness horse that no other food can. A double handful of clean chaff, or of bran mixed with the oats in the manger, prevents a greedy horse from swallowing a considerable proportion whole. Unchewed oats pass out in the faeces uninjured, so that they are capable of germination, and are of less than no value to a horse. Horses doing slow or other than "upper ten" work may have oats crushed, not ground, and a variety of additions made to the oats which are usually the basis of the feed—for example, a few old crushed beans, a little linseed meal, ground linseed cake or about a wine-glassful of unboiled linseed oil. Indian pulses are to be avoided on account of the danger of Lathyrus poisoning. A seasoning of ground fenugreek or spice is sometimes given to shy feeders to encourage them to eat. A little sugar or molascuit added to the food will sometimes serve the same purpose. Newly crushed barley or cracked maize, even in considerable proportion to the rest of the food, gives good

results with draught, coach, 'bus and light harness horses generally. Boiled food of any kind is unnatural to a horse, and is risky to give, being liable to produce colic, especially if the animal bolts its food when hungry, although it generally produces a glossy coat. Too much linseed, often used in preparing horses for market, gives a similar appearance, but is liable to induce fatty degeneration of the liver; given in moderation it regulates the bowels and stimulates the more perfect digestion of other foods. In England red-clover hay, or, better still, crimson-clover or lucerne hay, is liberally fed to farm horses with about 10 lb per day of oats, while they usually run in open yards with shelter sheds. Bean straw is sometimes given as part of the roughage in Scotland, but not in England. In England hunters and carriage horses are generally fed on natural hay, in Scotland on Timothy, largely imported from Canada, or ryegrass hay that has not been grown with nitrate of soda. Heavily nitrated hay is reputed to produce excessive urination and irritation of the bladder. Pease straw, if not sandy, and good bright oat straw are good fodder for horses; but with barley and wheat straw, in the case of a horse, more energy is consumed during its passage through the alimentary canal than the digested straw yields. Three or four Swedish turnips or an equivalent of carrots is an excellent cooling food for a horse at hard work. The greater number of horses in the country should have green forage given them during summer, when the work they do will permit of it, as it is their natural food, and they thrive better on it than on any dry food.

When a horse has been overstrained by work the best remedy is a long rest at pasture, and, if it be lame or weak in the limbs, the winter season is most conducive to recovery. The horse becomes low in condition and moves about quietly, and the frost tends to brace up the limbs. In autumn all horses that have been grazing should be dosed with some vermifuge to destroy the worms that are invariably present, and thus prevent colic or an unthrifty or anaemic state. On a long journey a horse should have occasional short drinks, and near the end a long drink with a slower rate of progression with the object of cooling off. In the stable a horse should always be provided with rock salt, and water to drink at will by means of some such stall fixture as the Mundt hygienic water-supply fittings. Overhead hay-racks are unnatural and are liable to drop seeds into a horse's eye.

LITERATURE.—For riding, &c. see RIDING, DRIVING, HORSEMANSHIP, and HORSE-RACING. For diseases of the horse see VETERINARY SCIENCE. The literature about the horse and its history and uses is voluminous, and is collected up to 1887 in Huth's *Works on Horses, &c.*, a bibliographical record of hippology. See also, besides the works already mentioned, various books by Capt. M. Horace Hayes, *Points of the Horse* (1893, 2nd ed., 1897); *Stables Management and Exercise* (1900); *Illustrated Horse-breaking* (1889, 2nd ed., 1896); and *The Horsewoman* (1893) (with Mrs Hayes); E. L. Anderson, *Modern Horsemanship* (1884); W. Day, *The Horse: How to Breed and Rear Him* (1888); W. Ridgeway, *Origin and Influence of the Thoroughbred Horse* (1905); Major-General Tweedie, *The Arab Horse* (1894); J. Wortley Axa, *The Horse; its Treatment in Health and Disease* (1906); R. Wallace, *Farm Live-Stock of Great Britain* (1885, 4th ed., 1907); Sydney Galvayne, *The Twentieth Century Book of the Horse* (1905); C. Bruce Low, *Breeding Racehorses by the Figure System* (1895); J. H. Wallace, *The Horse of America in his Derivation, &c.* (1897); Weatherly's *Celebrated Racehorses* (1887); Ruff's *Guide to the Turf*; T. A. Cook, *History of the English Turf* (1903); *The General Stud-Book* (issued quinquennially); and the *Stud-Books* of the various breed societies. (R. W.)

HORSE LATITUDES, the belts of calms and variable breezes at the polar edge of the N.E. and S.E. trades. According to the *New English Dictionary* two explanations have been given of the origin of the name: one that the calm kills horses on a sailing ship, the other that the name signifies the unruly and boisterous nature of these winds compared with the pleasant trades. The name is commonly applied to the permanent belt of high atmospheric pressure which encircles the globe in 30° to 35° from the equator.

HORSE-MACKEREL, the name applied to a genus of fishes (*Caranx*) found in abundance in almost all temperate and especially in tropical seas. The designation "cavalli," given to them by the early Portuguese navigators, and often met with

in the accounts of the adventures of the buccaners, is still in frequent use among the sailors of all nations. Some ninety different kinds are known—the majority being wholesome food, and some of the species attaining a length of 3 ft. and more. The fish to which the name horse-mackerel is applied in Great Britain is *Caranx trachurus*, distinguished by having the lateral line in its whole length armed with large but narrow bony plates. Horse-mackerel are found singly on the coast all the year round, but sometimes they congregate in shoals of many thousands. Although well-flavoured, they are much more frequently used for bait than for food. This species has a most extraordinary range, being found almost everywhere within the temperate and tropical zones of the northern and southern hemispheres.

HORSEMANSHIP, the art of managing the horse from his back and controlling his paces and the direction and speed of his movement. The ordinary procedure is dealt with in the articles on RIDING and cognate subjects (see also HORSE: section *Management*). A special kind of skill is, however, needed in breaking, training, biting and schooling horses for a game like polo, or for the evolutions of what is known as the *haute école*. It is with the latter, or "school" riding, that we deal here. The middle ages had seen chivalry developed into a social distinction, and horsemanship into a form of knightly prowess. The Renaissance introduced the cultivation of horsemanship as an art, with regular conditions and rules, instead of merely its skillful practice for utility and exercise. In Italy in the 16th century schools of horsemanship were established at Naples, Rome and other chief cities; thither flocked the nobility of France, Spain and Germany; and Henry VIII. of England and other monarchs of his time had Italians for their masters of the horse. The academy of Pignatelli at Naples was the most famous of the schools in the middle of the 16th century, but a score of other less renowned masters devoted themselves to teaching the riders and training the horses. Trappings of all sorts multiplied; the prescribed tricks, feats and postures involved considerable dexterity; they were fatiguing to both man and beast, and were really useless except for show. This elaborate art, enthusiastically followed among the Romance nations, was the parent of later developments of the *haute école*, and of the circus-performances of modern days. In England, however, the continental style did not find favour for long. The duke of Newcastle's *Méthode nouvelle de dresser les chevaux* (1648) was the leading text-book of the day, and in 1761 the earl of Pembroke published his *Manual of Cavalry Horsemanship*. In France a simplification was introduced in the early part of the 18th century by La Guérinière (*École de cavalerie*) and others. The French military school thus became the model for Europe, though the English style remained in opposition, forming a sort of compromise with the ordinary method of riding across country. In more modern times France again came to the front in regard to the *haute école*, through the innovations of the vicomte d'Aure (1798-1863) and François Baucher (1796-1873). Baucher was a circus-rider who became the greatest master of his art, and who had an elaborate theory of the principles involved in training a horse. His system was carried on, with modifications, by masters and theorists like Captain Raabe, M. Barroil and M. Fillis. In more recent times the style of the *haute école* has also been cultivated by various masters in the United States, such as H. L. de Bussigny at Boston.

See d'Aure, *Traité d'équitation* (1847); Hundersdorf, *Équitation allemande* (Bruxelles, 1843); Baucher, *Passé-temps équestres* (1840); *Méthode d'équitation* (1867); Raabe, *Méthode de haute école d'équitation* (1863); Barroil, *Art équestre*; Fillis, *Principes de dressage*; Hayes, *Riding on the flat*, &c. (1882).

HORSENS, a market town of Denmark, at the head of Horsens Fjord, on the east side of Jutland, 32 m. by rail S.W. of Aarhus, in the amt (county) of that name. Pop. (1901) 22,243. It is the junction of branch railways to Bryrup and to Thring Inland, and to Juelsminde on the coast. The exports are chiefly bacon and butter; the imports, iron, yarn, coal and timber. The town is ancient; there is a disused convent church with tombs of the 17th century, and the Vor-Frelsers-Kirke has a carved pulpit of the same period. Horsens is the birthplace of the

navigator Vitus Bering or Behring (1660), the Arctic explorer. To the north lies the picturesque lake district between Skanderborg and Silkeborg (see AARHUS).

HORSE-POWER. The device, frequently seen in farmyards, by which the power of a horse is utilized to drive threshing or other machinery, is sometimes described as a "horse-power," but this term usually denotes the unit in which the performance of steam and other engines is expressed, and which is defined as the rate at which work is done when 33,000 lb are raised one foot in one minute. This value was adopted by James Watt as the result of experiments with strong dray-horses, but, as he was aware, it is in excess of what can be done by an average horse over a full day's work. It is equal to 746 watts. On the metric system it is reckoned as 4500 kilogram-metres a minute, and the French *cheval-vapeur* is thus equal to 32,549 foot-pounds a minute, or 0.9863 of an English horse-power, or 736 watts. The "nominal horse-power" by which engines are sometimes rated is an arbitrary and obsolescent term of indefinite significance. An ordinary formula for obtaining it is $\frac{P \cdot D^2 \cdot S}{33,000}$ for high-pressure engines, and $\frac{P \cdot D^2 \cdot S}{33,000}$ for condensing engines, where D is the diameter of the piston in inches and S the length of the stroke in feet, though varying numbers are used for the divisor. The "indicated horse-power" of a reciprocating engine is given by $\frac{A \cdot P \cdot N}{33,000}$, where A is the area of the piston in square inches, S the length of the stroke in feet, P the mean pressure on the piston in lb per sq. in., and N the number of effective strokes per minute, namely, one for each revolution of the crank shaft if the engine is single-acting, but twice as many if it is double-acting. The mean pressure P is ascertained from the diagram or "card" given by an indicator (see STEAM-ENGINE). In turbine engines this method is inapplicable. A statement of indicated horse-power supplies a measure of the force acting in the cylinder of an engine, but the power available for doing external work off the crank-shaft is less than this by the amount absorbed in driving the engine itself. The useful residue, known as the "actual," "effective" or "brake" horse-power, can be directly measured by a dynamometer (q.v.); it amounts to about 80% of the indicated horse-power for good condensing engines and about 85% for non-condensing engines, or perhaps a little more when the engines are of the largest sizes. When turbines, as often happens in land practice, are directly coupled to electrical generators, their horse-power can be deduced from the electrical output. When they are used for the propulsion of ships recourse is had to "torsion meters" which measure the amount of twist undergone by the propeller shafts while transmitting power. Two points are selected on the surface of the shaft at different positions along it, and the relative displacement which occurs between them round the shaft when power is being transmitted is determined either by electrical means, as in the Denny-Johnson torsion-meter, or optically, as in the Hopkinson-Thring and Bevis-Gibson instruments. The twist or surface-shear being proportional to the torque, the horse-power can be calculated if the modulus of rigidity of the steel employed is known or if the amount of twist corresponding to a given power has previously been ascertained by direct experiment on the shaft before it has been put in place.

HORSE-RACING. Probably the earliest instance of the use of horses in racing recorded in literature occurs in *Il. xiii.* 212-650, where the various incidents of the chariot-race at the funeral games held in honour of Patroclus are detailed with much vividness. According to the ancient authorities the four-horse chariot-race was introduced into the Olympic games as early as the 23rd Olympiad; to this the race with mounted horses was added in the 33rd; while other variations (such as two-horse chariot-races, mule races, loose-horse races, special races for under-aged horses) were admitted at a still later period. Of the training and management of the Olympic race-horse we are left in ignorance; but it is known that the equestrian candidates were required to enter their names and send their horses to Elis at least thirty days before the celebration of the games commenced, and that the charioteers and riders, whether owners or proxies, went through a prescribed course of exercise

during the intervening month. At all the other national games of Greece (Pythian, Isthmian, Nemean), as well as at many of the local festivals (the Athenian Olympia and Panathenaea), similar contests had a prominent place. Some indication of the extent to which the passion for horse-racing was indulged in at Athens, for example, about the time of Aristophanes may be obtained from the scene with which *The Clouds* opens; while it is a significant fact that the Boeotians termed one of the months of their year, corresponding to the Athenian Hecatombæon, Hippodromius ("Horse-race month"; see Plutarch, *Cam.* 15). For the chariot-races and horse-races of the Greeks and Romans, see CIRCUS and GAMES.

GREAT BRITAIN

There is no direct historical evidence to show that the ancient Britons addicted themselves to any form of this amusement; but there are indications that among some at least of the Germanic tribes, from a very early period, horse-racing was an accompaniment of their religious cultus. There can be no doubt that the Romans encouraged the pursuit in Britain, if they did not introduce it; traces of race-courses belonging to the period of their occupation have been frequently discovered. The influence of the Christian Church was everywhere at first strongly against the practice. The opinion of Augustine and other fathers of the church with regard to attendance at the spectacles, whether of theatre or of circus, is well known; those who performed in them were rigidly excluded from church fellowship, and sometimes even those who merely frequented them. Thus the first council of Arles, in its fourth canon, declared that those members of the church who drove chariots at the public games should, so long as they continued in that employment, be denied communion. (Compare the rule in the *Ap. Const.* viii. 32; *ap. Bingham, Ant. Chr. Church*, xvi. 4, 10.) In many cases, however, the weight of ecclesiastical authority proved insufficient to cope with the force of old custom, or with the fascination of a sport the unchristian character of which was not very easily demonstrable; and ultimately in Germany and elsewhere the old local races appear to have been admitted to a recognized place among the ceremonies peculiar to certain Christian festivals.

The first distinct indication which contemporary history affords of horse-racing as a sport occurs in the *Description of the City of London* of William Fitzstephen (c. 1174). He says that in a certain "plane field without one of the gates (quidam planus campus re et nomine—Smithfield, quasi Smoothfield) every Friday, unless it be one of the more solemn festivals, is a noted show of well-bred (*nobilium*) horses exposed for sale. The earls, barons and knights who are resident in the city, as well as a multitude of citizens, flock thither either to look on or buy." After describing the different varieties of horses brought into the market, especially the more valuable chargers (*dextrarios preciosos*), he says: "When a race is to be run by such horses as these, and perhaps by others which, in like manner, according to their breed are strong for carriage and vigorous for the course, the people raise a shout and order the common horses to be withdrawn to another part of the field. The jockeys, who are boys expert in the management of horses, which they regulate by means of curb bridles, sometimes by threes and sometimes by twos, as the match is made, prepare themselves for the contest. Their chief aim is to prevent a competitor from getting before them. The horses too, after their manner, are eager for the race; their limbs tremble, and impatient of delay they cannot stand still; upon the signal being given they stretch out their limbs, hurry on the course, and are borne along with unremitting speed. The riders, inspired with the love of praise and the hope of victory, clap spurs to their flying horses, lashing them with whips, and inciting them by their shouts" (see Stow's Translation).

In the reign of Richard I. knights rode at Whitsuntide on steeds and palfreys over a three-mile course for "forty pounds of ready gold," according to the old romance of Sir Bevis of Hampton. The feats of the tilt-yard, however, seem to have surpassed horse-racing in popular estimation at the period of the

crusades. That the sport was to some extent indulged in by King John is quite possible, as running horses are frequently mentioned in the register of royal expenditure; and we know that Edward III. had a number of running horses, but it is probable they were chiefly used for field sports.

An evidence of the growing favour in which horse-racing was held as a popular amusement is furnished by the fact that public races were established at Chester in 1522. Randle Holme of that city tells us that towards the latter part of Henry VIII.'s reign, on Shrove Tuesday, the company of saddlers of Chester presented to "the drapers a wooden ball embellished with flowers, and placed upon the point of a lance. This ceremony was performed in the presence of the mayor at the cross of the Roodly or Roodee, an open place near the city; but this year (1540) the ball was changed into a silver bell, valued at three shillings and sixpence or more, to be given to him who shall run best and furthest on horseback before them on the same day, Shrove Tuesday; these bells were denominated St George's bells." In the reign of Elizabeth there is evidence from the poems of Bishop Hall (1597) that racing was in vogue, though apparently not patronized by the queen, or it would no doubt have formed part of the pastimes at Kenilworth; indeed, it seems then to have gone much out of fashion.

The accession of the Stuarts opened up an era of prosperity for the sport, for James I., who, according to Youatt, had encouraged if not established horse-racing in Scotland, greatly patronized it in England when he came to the throne. Not only did he run races at Croydon and Enfield, but he endeavoured to improve the breed of horses by the purchase for a high figure of the Arab stallion known as Markham's Arabian, which little horse, however, was beaten in every race he ran.

In 1607, according to Camden's *Britannia*, races were run near York, the prize being a little golden bell. Camden also mentions as the prize for running horses in Gatherley Forest a little golden ball, which was apparently anterior to the bell. In 1609 Mr Robert Ambrye, sometime sheriff of the city of Chester, caused three silver bells to be made of good value, which bells he appointed to be run for with horses on St George's day upon the Roodee, the first horse to have the best bell and the money put in by the horses that ran—in other words, a sweepstake—the bells to be returned that day twelvemonth as challenge cups are now; towards the expenses he had an allowance from the city. In 1613 subscription purses are first mentioned. Nicholls, in his *Progress of James I.*, makes mention of racing in the years 1617 and 1619. Challenge bells appear to have continued to be the prizes at Chester, according to Randle Holme the younger, and Ormerod's *History of Chester*, until 1623 or 1624, when Mr John Brereton, mayor of Chester, altered the course and caused the horses to run five times round the Roodee, the bell to be of good value, £8 or £10, and to be a free bell to be held for ever—in other words, a presentation and not a challenge prize.

During James's reign public race meetings were established at Gatherley or Garterley, near Richmond in Yorkshire, at Croydon in Surrey, and at Enfield Chase, the last two being patronized by the king, who not only had races at Epsom during his residence at Nonsuch, but also built a house at Newmarket for the purpose of enjoying hunting, and no doubt racing too, as we find a note of there having been horse-races at this place as early as 1605. Races are also recorded as having taken place at Linton near Cambridge, but they were probably merely casual meetings. The prizes were for the most part silver or gold bells, whence the phrase "bearing away the bell." The turf indeed appears to have attracted a great deal of notice, and the systematic preparation of running horses was studied, attention being paid to their feeding and training, to the instruction of jockeys—although private matches between gentlemen who rode their own horses were very common,—and to the adjustment of weights, which were usually about 10 stone. The sport also seems to have taken firm hold of the people, and to have become very popular.

The reign of Charles I., which commenced in 1625, saw still more marked strides made, for the king not only patronized the

racing at Newmarket, which we know was current in 1640, but thoroughly established it there, and built a stand house in 1667, since which year the races have been annual. Mention is likewise made in the comedy of the *Merry Beggars*, played in 1641, of races, both horse and foot, in Hyde Park, which were patronized by Charles I., who gave a silver cup, value 100 guineas, to be run for instead of bells. Butcher, in his survey of the town of Stamford (1646), also says that a race was annually run in that town for a silver and gilt cup and cover, of the value of £7 or £8, provided by the care of the aldermen for the time being out of the interest of a stock formerly made by the nobility and gentry of the neighbourhood.

In 1648 Clarendon tells us that a meeting of Royalists was held at Banstead Downs, as Epsom Downs were then called, "under the pretence of a horse-race," so that horse-racing at Epsom was not unknown early in the 17th century; Pepys, too, in his *Diary* of 1663, mentions his having intended to go to Banstead Downs to see a famous horse-race. Cromwell is said to have kept running horses in the year 1653, but in 1654 he appears to have gone so far as to forbid racing for six and eight months respectively. After the Reformation in 1660, a new impetus was given to horse-racing, which had languished during the civil wars, and the races at Newmarket, which had been suspended, were restored and attended by the king; and as an additional spur to emulation, according to Youatt, royal plates were given at each of the principal courses, and royal mares, as they were called, were imported from abroad. Charles II. rebuilt the house originally erected at Newmarket by James I., which had fallen into decay. The Round course was made in 1666, and racing at the headquarters of the turf was regulated in the most systematic way, as to the course, weights and other conditions. Charles II. was the first monarch who entered and ran horses in his own name; and, besides being a frequent visitor at the races on Newmarket Heath, and on Burford Downs, near Stockbridge, where the Bibury Club meeting was held, he established races at Datchet. In the reign of James II. nothing specially noteworthy occurred, but William III. continued former crown donations and even added to them.

Anne was much devoted to horse-racing, and not only gave royal plates to be competed for, but ran horses for them in her own name. In 1703 Doncaster races were established, when 4 guineas a year were voted by the corporation towards a plate, and in 1716 the Town Plate was established by the same authority to be run on Doncaster Moor. Nearly a century, however, elapsed before the St Leger was instituted. Matches at Newmarket had become common, for we find that Basto, one of the earliest race-horses of whom we have any authentic account, won several matches there in 1708 and 1709. In the latter year, according to Camden, York races were established, the course at first being on Clifton Ings, but it was subsequently removed to Knavesmire, on which the races are now run. In 1710 the first gold cup said to have been given by the queen, of 60 guineas value, was run for by six-year-old horses carrying 12 stone each, the best of three 4-mile heats, and was won by Bay Bolton. In 1711 it was increased to 100 guineas. In 1712 Queen Anne's gelding Pepper ran for the Royal Cup of £100 at York, and her Mustard, a nutmeg-grey horse, ran for the same prize in 1713. Again in 1714 her Majesty's bay horse Star won a sweepstake of 10 guineas added to a plate of £40 at the same place, in four heats, carrying 11 stone. In 1716 the Ladies' Plate at York for five-year-olds was won by Aleppo, son of the Darley Arabian. Racing and match-making continued to be a regular sport at Newmarket, and at York and Hambleton, and we also find a record of a race at Lincoln in August 1717 for a silver tea-board, won by Brocklesby Betty, as was the Queen's Plate at Black Hambleton in the year before.

Between 1714 and 1720 there were races at Pontefract in Yorkshire for plates or money. The best of two out of three heats was to be the winner, provided the said horse was not distanced in the third heat—the distance post being 1 furlong from the winning post; and this appears to have been a usual condition. In or about the year 1721 Flying Childers is said to

have run a trial against Almanzor and Brown Betty over the Round course at Newmarket (3 m. 4 f. 93 y.) in 6 m. 40 s., and another trial over the Beacon course (4 m. 1 f. 138 y.) in 7 m. 30 s.—which is fast even for a six-year old, but it is just possible that in those days the art of time-taking was anything but perfect. In 1721 George I. gave 100 guineas in specie in lieu of the gold cup at York presented by Anne, and the king's or queen's plates have been given in cash ever since. In 1725 a ladies' plate was run for on the 14th of September by female riders on Ripon Heath in Yorkshire. In 1727 Mr John Cheney established the *Racing Calendar*—an historical list of all the horse matches run, and of all plates and prizes run for in England and Wales of the value of £10 or upwards in 1727, &c. No systematic records had till then been preserved of the running of the race-horses of the day, and it is only through the performances of certain celebrated horses and mares that we have any information of what actually took place, and even that is more or less of a fragmentary kind. At this time racing was thoroughly established as a national and popular sport, for there were upwards of a hundred meetings in England and Wales, but the plates or sweepstakes run for were for the most part of small value, as £10, £20, £30, £40, and sometimes £50. In 1727, according to Whyte, there were only a dozen royal plates run for in England: one at Newmarket in April for six-year-old horses at 12 stone each, in heats over the Round course—first called the King's Plate course; one for five-year-old mares at 10 stone each, in one heat, and another in October for six-year-old horses at 12 stone, in heats over the same course; one at York (which commenced in 1711) for six-year-old horses, 12 stone each, 4-m. heats; one at Black Hambleton, Yorkshire (of which no regular account was kept until 1715), for five-year-old mares, 10 stone, 4 m.; one at each of the following places, Nottingham, Lincoln, Guildford, Winchester, Salisbury and Lewes, for six-year-old horses, 12 stone each, 4-m. heats; and one at Ipswich for five-year-old horses, 10 stone each. A royal plate was also run for at Edinburgh in 1728 or 1729, and one at the Curragh of Kildare in 1741.

In 1739 an act was passed to prevent racing by ponies and weak horses, 13 Geo. II cap. 10, which also prohibited prizes or plates of less value than £50. At this period the best horses seldom ran more than five or six times, and some not so often, there being scarcely any plates of note except royal ones, and very few sweepstakes or matches of value except at Newmarket until after 1750, moreover, as the races were run in heats, best three out of four, over a course of several miles in length, the task set the horses before winning a plate was very severe, and by no means commensurate with the value of the prize. In 1751 the great subscription races commenced at York, the city also giving £50 added money to each day's racing. At Newmarket there were only two meetings, one in April and the other in October, but in 1753 a second spring meeting was established, and in that year the Jockey Club, which was founded in 1750, established the present racing ground. In 1762 a second October meeting was added, in 1765 the July meeting, in 1770 the Houghton meeting, and in 1771 the Craven meeting. In 1766 Tattersall's was established at Hyde Park Corner by Richard Tattersall for the sale of horses, it remained the great emporium of horses, and the rendezvous for betting on horse races, until 1865, when, the lease of the premises at the Corner having run out, it was removed to Knightsbridge.

We now come to a very important period—that at which the great three-year-old races were instituted.

The St Leger was established in 1776 by Colonel St Leger, who resided at Parkhill, near Doncaster. On the 24th of September, during the Doncaster races, which took place annually in the autumn, at his suggestion a sweepstake of The St Leger. 25 guineas each for three-year-old colts and fillies was run over a 2-m. course; there were six competitors, the property of as many subscribers,—a very small beginning, it must be owned. The race was won by a filly by Sampson, belonging to Lord Rockingham, which was afterwards named Allabaculia. In the following year the same stake had twelve

subscribers and ten starters, and was won by Mr Sotherton's Bourbon. It was not, however, until the succeeding year, 1778, that it was named the St Leger, in compliment to the founder, at the suggestion of the marquis of Rockingham. The stakes were increased in 1832 to 50 sovs. each, and the weights have been raised from time to time to keep pace with modern requirements. The Doncaster Cup, a weight for age race for three-year-olds and upwards, was established in 1801. The course is nearly flat, of an oval or kite shape, about 1½ m. round the town-moor.

The Epsom Derby and Oaks were established in 1779 and 1780, the Oaks in the former and the Derby in the latter year.

It is true that in 1730 Epsom races became annual, but the prizes were nothing more than the usual plates run for in heats, the money required being raised by voluntary subscriptions, as well by the owners of booths on the downs as by the parties more immediately interested, whence arose the custom of charges being made by the lord of the manor for permission to erect booths, &c. during the race-meetings. On the 14th of May 1779 the twelfth earl of Derby originated the Oaks stakes (named after his seat or hunting-box "The Oaks" at Woodmansterne), a sweepstake for three-year-old fillies run on a course 1½ m. long. The race was won by Lord Derby's bay filly Bridget, bred by himself—her sire being Herod and her dam Jemima. In the following year the earl established a sweepstake of 50 sovs. each, half forfeit, for three-year-old colts. This, the first Derby, was won by Sir C. Bunbury's chestnut colt Diomed by Florizel, son of Herod, who beat eight opponents, including the duke of Bolton's Bay Bolton and Lord Grosvenor's Diadem. These two races have since been run for regularly every year, the Derby, which before 1839 was run on the Thursday, now taking place on the Wednesday, and the Oaks on the Friday, in the same week at the end of May.

Ascot races, which are held on Ascot Heath, were established by the duke of Cumberland, uncle of George III., and are patronized by royalty in state or semi-state. They are mentioned in the first *Racing Calendar*, published in 1727, but the races were for the most part plates and other prizes of small importance, though a royal plate for hunters appears to have been given in 1785. The Gold Cup was first given in 1807, and has been regularly competed for ever since, though from 1845 to 1853 inclusive it went by the designation of the Emperor's Plate, the prize being offered by the emperor of Russia. In 1854, during the Crimean War, the cup was again called the Ascot Gold Cup, and was given from the race fund. The Queen's Vase was first given in 1838, and the Royal Hunt Cup in 1843, while in 1865 a new long-distance race for four-year-olds and upwards was established, and named the Alexandra Plate, after the Princess of Wales.

Goodwood races were established by the duke of Richmond on the downs at the northern edge of Goodwood Park in 1802, upon the earl of Egremont discontinuing races in his park at Petworth. The races take place at the end of July, on the close of the London season. The Goodwood Cup, the chief prize of the meeting, was first given in 1812; but from 1815 to 1824 inclusive there was no race for it, with the single exception of 1816.

During the latter half of the 18th century horse-racing declined very much in England, and numbers of meetings were discontinued, the wars which took place necessarily causing the change. From the beginning of the 19th century, and especially after the conclusion of the

French war in 1815, racing rapidly revived, and many new meetings were either founded or renewed after a period of suspension, and new races were from time to time established. Among others the Two Thousand Guineas at Newmarket for three-year-old colts and fillies, and the One Thousand Guineas for fillies, were established in 1809 and 1814 respectively, the Goodwood Stakes in 1823, the Chester Cup and Brighton Stakes in 1824, the Liverpool Summer Cup in 1828, the Northumberland Plate in 1833, the Manchester Cup in 1834, the Ascot Stakes

and the Cesarewitch and Cambridgeshire Handicaps at Newmarket in 1830, the Stewards' and Chesterfield Cups at Goodwood in 1840, the Great Ebor Handicap at York in 1843, and, to omit others, the City and Suburban Handicap at Epsom in 1851, and the Lincoln Handicap in 1853.

Two-year-old racing was established very shortly after the great three-year-old races, and on a similar footing, that is to say, the competitors carried the same weights, with the exception of a slight allowance for sex,—the July Stakes at the Newmarket Midsummer Meeting having been founded as early as 1786. The Woodcote Stakes at Epsom succeeded in 1807, the Champagne Stakes at Doncaster in 1823, the Criterion Stakes at the Houghton Meeting in 1829, the Chesterfield Stakes at the Newmarket July meeting in 1834, the New Stakes at Ascot in 1843, the Middle Park Plate (or two-year-old Derby, as it is sometimes called) at the Newmarket Second October Meeting in 1866, the Dewhurst Plate at the Houghton Meeting in 1875, and the Richmond Stakes at Goodwood in 1877. (E. D. B.)

Present Conditions.—Horse-racing, usually described as "the national sport," has greatly advanced in general popularity in the British Isles. There is no doubt that the best specimens of the English thoroughbred horse are the finest animals of their kind in existence; the value of an infusion of the blood for chargers, hunters, backs, and other varieties is scarcely to be overestimated; and the only way of ascertaining what animals may be most judiciously employed for breeding purposes is to submit them to the tests of preparation for and performance on the turf. Racing is therefore a practical necessity. On some accepted authority, the origin of which is not to be traced, five races run each season by three-year-olds are distinguished as "classic." Of these the chief, by universal consent, is the Derby, which takes place at Epsom during the week which includes the 31st May. The Epsom course, on which the Derby has been run since its origin in 1780, is by no means a good one, in consequence of the abrupt turn at Tattenham Corner; and the severe descent after this turn is made is also held to be a disadvantage, though a really good horse should be able to act on ascents, descents and level ground with equal relative facility. In many respects the St Leger, run at Doncaster about the middle of September, is a better test, as here colts and fillies meet when both are presumably able to do themselves the fullest justice. September, indeed, has been called "the Mares' Month," for though fillies are eligible to run in the Derby, they are very frequently out of sorts and always more or less uncertain in their performances during the summer—only four have been successful in 129 contests for the stake—whereas in the autumn their numerous victories in the St Leger prove them to be at their best. It was the recognition of this fact which induced an alteration of the weights in the year 1882, previously to which fillies had carried 5 lb less than colts; the weights, formerly 8 st. 10 lb and 8 st. 5 lb, are now 9 st. and 8 st. 11 lb. The Doncaster course is superior for racing purposes to that at Epsom, where the Oaks, another of the "classic races," is run on the Friday following the Derby; the other two contests which come into this category being the Two Thousand Guineas for colts and fillies, and the One Thousand Guineas for fillies only. These races take place at Newmarket during the First Spring Meeting, the former always on a Wednesday, the latter on Friday. The expression "a Derby horse" is common, but has no precise significance, as the three-year-olds vary much in capacity from year to year. It is generally understood, for instance, that Ormonde, who won the Derby in 1886, must have been at least 21 lb superior to Sir Visto or Jeddah, who were successful in 1895 and 1898. By their ability to carry weight the value of horses is estimated on the turf. Thus one horse who beats another by a length over a distance of a mile would be described as a 5-lb better animal.

The term "handicap horse" once had an adverse significance which it does not now possess. In handicaps horses carry weight according to their presumed capacity, as calculated by handicappers who are licensed by the Jockey Club and

The Derby and Oaks.

Ascot Races.

Goodwood.

Two Thousand, &c.

Classic Races in England.

employed by the directors of different meetings. The idea of a handicap is to afford chances of success to animals who would have no prospect of winning if they met their rivals on equal terms; but of late years the value of handicaps has been so greatly increased that few owners resist the temptation of taking part in them. Horses nowadays who do not run in this kind of contest are very rare, though a few, such as Ormonde, Isinglass, and Persimmon, never condescended to this class of sport. The duke of Westminster did not hesitate to put his Derby winner Bend Or into some of the chief handicaps; and it is, of course, a great test of merit when horses carrying heavy weights show marked superiority in these contests to rivals of good reputation more lightly burdened. St Gatien, who dead-heated with Harvester in the Derby of 1884; Robert the Devil, who won the St Leger in 1880 and on several occasions beat the Derby winner Bend Or; and La Flèche, who won the Oaks and the St Leger in 1892, added to the esteem in which they were held by their successes under heavy weights, the colts in the Cesarewitch, the filly in the Cambridgeshire. Of the chief handicaps of the year, special mention may be made of the City and Suburban, run at the Epsom Spring Meeting over 1½ m.; the Kempton Park Jubilee, over 1 m.; the Ascot Stakes, 2 m., and the Royal Hunt Cup, 1 m.; the Stewards' Cup at Goodwood, six furlongs; the Cesarewitch Stakes and the Cambridgeshire Stakes at Newmarket, the former 2½ m., the latter now a mile and a furlong—till lately it was "a mile and a distance"—"a distance" on the Turf being a fixed limit of 240 yds. The cups at Manchester, Newbury, and Liverpool are also handicaps of some note, though it may be remarked that the expression "a cup horse" is understood to imply an animal capable of distinguishing himself over a long distance at even weights against the best opponents. There are many other valuable stakes of almost equal importance, diminishing to what are known as "selling handicaps," the winners of which are always put up for sale by auction immediately after the race, in the lowest class of them the condition being that the winner is to be offered for £50. No stake of less than £100 can be run for under Jockey Club rules, which govern all reputable flat racing in England, nor is any horse ever entered to be sold for less than £50. As horses mature they are naturally able to carry heavier weights.

of race meetings, but is not intended to be imperative, especially as regards the weights of two- and three-year olds relatively to the old horses in selling races early in the year. It is founded on the scale published by Admiral Rous, and revised by him in 1873, but has been modified in accordance with suggestions from the principal trainers and practical authorities.

In the year 1884 the managers of Sandown Park formulated the scheme of a race for a prize of £10,000, to be called the Eclipse Stakes, and to be run over a distance of 1½ m. In order to secure a large entry, horses were to be nominated soon after their birth; owners who perceived the hopelessness of their nominations could withdraw at stated intervals by the payment of increasing forfeits; if their animals finally went to the post a stake amounting in all to £115 would have to be paid for them; and thus it will be seen that owners were really running for their own money, though if there were an insufficient number of entries the funds of the club might be taxed to supply the deficiency. The scheme was found to be attractive, and the example was followed at Leicester and at Manchester, at both of which places, however, it lapsed. At Newmarket, under the immediate auspices of the Jockey Club, the £10,000 races succeeded, and there were two of them each year. The Princess of Wales's Stakes was run for the first time in 1894 at the First July Meeting, and the Jockey Club Stakes at the First October. The former has, however, now been reduced to £2000 added to a sweepstake of £30 each with a minor forfeit. In the year 1900 a fourth race of similar character, the Century Stakes, was originated at Sandown, but the experiment proved a failure, and the contest was discontinued.

The age of the thoroughbred horse is always dated from the 1st January. Foals are generally born in February, March or April, though not a few good horses have been born in May; they become yearlings, therefore, on the 1st January following, two-year-olds twelve months later, and many of them begin to race in the following March, for flat racing always starts during the week which contains the 25th, except when Easter falls unusually early. In France no two-year-olds run until the 1st August, and discussion is frequently raised as to the respective wisdom of the English and French systems. It happens, however, that some young horses "come to hand" soon, and deteriorate with equal rapidity. They are, in fact, able to win races at the beginning of the season, and fail to hold their own later in the year against bigger and more powerful animals of their own age who have taken longer to mature, so that there is some argument in favour of the earlier date. The first noteworthy two-year-old race is the Brocklesby Stakes, run at Lincoln during the first week of the season. Sometimes the winner of the Brocklesby is really a good animal, as was the case with The Bard in 1885 and Donovan in 1888, but as a general rule when the autumn comes he is found to be far inferior to the winners of subsequent two-year-old races of good class. It is seldom that a first-class two-year-old appears before the Ascot Meeting about the middle of June, though horses of character sometimes run for the Woodcote Stakes at Epsom and in other contests elsewhere. The names of many of the most famous horses on the turf are found in the list of winners of the New Stakes at Ascot, which was first run in 1843 and maintains its character. In 1890 the Coventry Stakes was originated, and is regarded as a race of practically equal importance. The July Stakes at Newmarket is the oldest of existing two-year-old races, having been first run in 1786. The list of winners is a brilliant one. The Chesterfield Stakes ranks with it. The best two-year-olds are usually seen out at Goodwood, and as a general rule those that have chiefly distinguished themselves during the year, and are to make names for themselves later in life, are found contesting the Middle Park Plate at the Newmarket Second October Meeting and the Dewhurst-Plate at the Newmarket Houghton. The Middle Park Plate is generally worth over £2000, the

Scale of Weight for Age.

The following scale of weight for age is published under the sanction of the Stewards of the Jockey Club as a guide to managers

Age.	Mar and April.	May.	June.	July.	Aug.	Sept.	Oct and Nov.
Five Furlongs—							
Two years	6 0	6 2	6 7	6 9	7 0	7 4	7 7
Three years	8 2	8 3	8 5	8 7	8 9	8 10	8 11
Four years	9 0	9 0	9 0	9 0	9 0	9 0	9 0
Five, six and aged	9 1	9 0	9 0	9 0	9 0	9 0	9 0
Six Furlongs—							
Two years	6 0	6 4	6 7	6 11	7 0	7 5	7 7
Three years	8 4	8 6	8 8	8 10	8 12	9 0	9 2
Four years	9 7	9 7	9 7	9 7	9 7	9 7	9 7
Five, six and aged	9 9	9 8	9 7	9 7	9 7	9 7	9 7
One Mile—							
Two years						6 5	6 7
Three years	7 9	7 11	7 13	8 2	8 4	8 5	8 6
Four years	9 0	9 0	9 0	9 0	9 0	9 0	9 0
Five, six and aged	9 4	9 3	9 2	9 0	9 0	9 0	9 0
One Mile and a Half—							
Two years						6 0	6 4
Three years	7 7	7 9	7 11	7 13	8 1	8 3	8 5
Four years	9 0	9 0	9 0	9 0	9 0	9 0	9 0
Five, six and aged	9 5	9 4	9 3	9 2	9 1	9 0	9 0
Two Miles—							
Two years						6 0	6 2
Three years	7 8	7 11	7 12	8 0	8 3	8 4	8 5
Four years	9 4	9 4	9 4	9 4	9 4	9 4	9 4
Five, six and aged	9 10	9 9	9 8	9 7	9 6	9 5	9 4
Three Miles—							
Three years	7 1	7 4	7 5	7 7	7 9	7 11	7 13
Four years	9 0	9 0	9 0	9 0	9 0	9 0	9 0
Five years	9 8	9 7	9 6	9 5	9 5	9 4	9 3
Six and aged	9 10	9 8	9 7	9 6	9 5	9 4	9 3

other races named are between £1000 and £2000 in value; but these are not the richest two-year-old prizes of the year, the value of the National Breeders' Produce Stakes at Sandown, run on the day following the Eclipse, being between £4000 and £5000, and the Imperial Stakes at Kempton Park falling not very far short of £3000. As a rule, a colt who has been specially successful as a two-year-old maintains his capacity later in life, unless it be found that he cannot "stay"—that is to say, is unable to maintain his best speed over more than five or six furlongs; but it is frequently the case that fillies who have won good races as two-year-olds entirely lose their form and meet with little or no success afterwards.

Newmarket is called with reason "the headquarters of the Turf." There are about forty training establishments in the town, each trainer being in charge of an average of thirty to forty horses, irrespective of mares, foals and yearlings. During the year eight race meetings are held on the Heath: the Craven; the First and Second Spring; the First and Second October—the First October usually occurring at the end of September; and the Houghton. These are contested on "the Flat," the course which includes the Rowley Mile. It is said that the Rowley Mile is so called from the fact of its having been a favourite race-ground with Charles II. The First and Second July Meetings take place on another course, known as "Behind the Ditch," the Ditch being the huge embankment which runs through several counties and has existed from time immemorial. The Craven Stakes for three-year-olds is an event of some importance at the first meeting of the year. It used to finish on an ascent at what is called the "Top of the Town," a course over which the handicap for the Cambridgeshire was run. This course has now been abandoned and the stand pulled down. At the First Spring Meeting the Two Thousand Guineas and the One Thousand Guineas occur, as already stated, but the names do not represent the values of the stakes, which are, in fact, usually worth close on £5000 each. The July Stakes and the Princess of Wales' Stakes are run at the First July Meeting. The Jockey Club Stakes is the leading event of the First October; the Cesarewitch and the Middle Park Plates follow in the Second October; the Criterion Stakes, another of the few races that once finished at the "Top of the Town," the Cambridgeshire and the Dewhurst Plate take place at the Houghton Meeting. The majority of races finish at the Rowley Mile post; but there are three other winning-posts along the Rowley Mile. "Behind the Ditch" races finish at two different posts, one of which enables horses to avoid the necessity of galloping up the severe ascent of the "Bunbury Mile." Although, as a rule, there is no better racing to be seen than the best events

Ascot and other meetings.

at Newmarket, the programmes are often spun out by selling plates and paltry handicaps, and a high level is nowhere so consistently maintained as at Ascot. The Ascot meeting is distinguished by the entire absence of selling plates, and much more "added money" is given than on any other course. Added money is the sum supplied by the directors of a race meeting, derived by them from the amounts paid for entrances to stands and enclosures; for in many races—the Ten Thousand prizes, for instance—owners run mainly or entirely for money which they have themselves provided. The Ascot Cup is generally spoken of as a race success in which sets the seal to the fame of a good horse. It is a prize of the highest distinction, and of late years has been of considerable value, the winner in 1909 having gained for his owner £3430. That the number of runners for this race should be invariably small—the average for many years past has been about six—is not a matter of surprise to those who are familiar with the Turf. There are very few horses possessing sufficient speed and staying power to make it worth the while of their owners to submit them to the exceedingly severe test of a preparation for this race, which is run over 2½ m. of ground at a time of year when the turf is almost always extremely hard everywhere, and harder at Ascot than almost anywhere else. There is no course on which more good horses have hopelessly broken down. All the prizes

are handsome, and success at Ascot confers much prestige, for the reason that the majority of horses that run are good ones; but annually there is a list of victims that never recover from the effects of galloping on this ground. Goodwood also attracts horses of high character, though some unimportant races fill out the programme. Formerly there were many meetings around London, which fell into disrepute in consequence of the manner in which they were conducted. These have been replaced by well-managed gatherings in enclosed parks, and here the value of the prizes is often so high that the best horses in training are attracted. These meetings include Sandown, Kempton, Gatwick, Lingfield, Newbury and Hurst Park. Liverpool, Manchester, Birmingham, Brighton, York and various other towns have race meetings twice or oftener in the course of each year. At the various fixtures over half a million of money is annually given in stakes. The largest sum ever won by a horse was the £57,185 gained by Isinglass in 1892-1895. Donovan follows with £54,935. In all probability these large totals would have been considerably exceeded had not Flying Fox—who had won in his first two seasons £40,000—been disqualified by the death of his owner, the duke of Westminster, as this colt was engaged in the four £10,000 races of 1900, in which to all appearance he could not have been beaten, so much was he superior to his contemporaries. The death of an owner of horses disqualifies the animals he has entered—a necessary regulation, as otherwise an heir might be burdened with a stable of horses the possession of which would entail heavy expense and serious responsibility on a person who perhaps had no knowledge of or taste for racing.

The value of an unquestionably good horse is enormous. It has been seen what handsome prizes are offered for competition, and when withdrawn from the Turf the horse may secure a large income to his owner at the stud. A *Value of horse.* stallion's fee of 600 guineas (as in the case of St Simon) should mean well over £20,000 a year; and fees of 100 guineas and more are common. Proved merit on the Turf is considered essential in a sire, though there have been instances of horses, unsuccessful during their racing career, who have distinguished themselves at the stud: Wisdom, sire of the Derby winner Sir Hugo, and several notable examples might be cited. Mares are much more uncertain in this respect. On the whole, the famous mares that have won the Oaks, the St Leger and other leading races, have been apt to fail in the paddocks; but there is always a hope of success with them, and the large sum of 12,600 guineas was paid for La Flèche when she had ceased from active service on the Turf. For None-the-Wiser 7200 guineas was given; and 4600 guineas for Wedlock when well advanced in years, on the strength of her having been the dam of a good horse called Best Man. Well-bred mares that have shown no capacity for racing are, however, frequently the dams of good winners. Breeding is a lottery. An Australian enthusiast some years since published a book the object of which was to enable breeders to produce good horses by a species of mathematical calculation; but the fallacy of the "Figure System" was at once proved by the simple circumstance that in very many cases the own brothers and sisters of good winners, whose breeding conformed entirely to the system, proved to be utterly worthless for racing purposes. It is a fact difficult of explanation that the majority of famous winners have been privately bred by their owners. Many persons breed for sale, in some cases sparing no expense or trouble in the endeavour to secure good results, and yearlings sold by auction have fetched prices of from 10,000 guineas (paid for Sceptre, a daughter of Persimmon and Ornament, in 1900) downwards; sums of over 1000 guineas being frequently given. That so large a proportion of high-priced yearlings should turn out failures is not at all a matter for surprise, considering the uncertainties of the Turf, but it by no means follows that a high-priced yearling is necessarily an expensive animal; 5500 guineas was, for instance, given for La Flèche, who won for her owner £34,585 in stakes, and, as already observed, was subsequently sold for 12,600 guineas. The principal yearling sales take place during the July meeting

at Newmarket and the Doncaster meeting in September. There are also sales at Ascot and elsewhere. The Royal Stud at Bushey Park, where Memoir, La Flèche, Best Man and other good animals were bred, has now been abandoned.

In many cases trainers have graduated from jockeys. The usual charge to an owner is 50s. a week per horse, but, as regards the cost of a horse in training, to this there are various additions irrespective of entrances to races, forfeits, travelling, jockey's fees, &c. The recognized sum paid to a jockey is 3 guineas for a losing mount, 5 guineas for winning. In many cases special terms are made; the principal owners usually have a claim on a rider's services, and for this call as much as £5,000 per annum, exclusive of the usual riding fees, has been given.

From time immemorial until within a very recent period jockeys rode in much the same style, though, of course, with varying degrees of skill. Many hundreds of boys exercise daily at Newmarket and other training grounds, all of them necessarily having a firm seat in the saddle, for the thoroughbred horse is, as a rule, high-couraged and apt to play violent tricks; but though most of these lads find chances to distinguish themselves in trials and races for apprentices, probably not 5% grow into professional jockeys, increasing weight keeping many from the business, as a jockey has few chances unless he can ride well under 9 stone. Knowledge of pace is a rare gift or acquisition which is essential to successful jockeyship. The rider must also be quick to perceive how his own horse is going—what he has "left in him"; he must understand at a glance which of his rivals are beaten and which are still likely to be dangerous; must know when the moment comes for the supreme effort to be made, and how to balance and prepare the horse for that critical struggle. At the beginning of the race the jockey used to stand in his stirrups, with the idea of removing weight from the horse's back and preserving perfect steadiness; towards the end of the race, if it were necessary to drive the animal home, he sat down "to finish."

This method used to be adopted in all countries, but recently a new system came into practice in America. Instead of putting the saddle in the middle of the horse's back, where it had always been placed previously, it was shifted forward on to the animal's withers. The jockey rode with very short stirrups, leaning forward over the neck and grasping the reins within a few inches of the horse's mouth. The appearance of this was ungainly in the extreme and an entire departure from ancient ways (though Fordham and a few other riders of great reputation had always sat much more forward than their contemporaries), but it was found to be remarkably effective. From the position thus adopted there was less resistance to the wind, and though the saving in this respect was largely exaggerated, in racing, where success or failure is frequently a matter of a very few inches, every little that helps is to be considered. The value of the discovery lay almost entirely in the fact that the horse carries weight better—and is therefore able to stride out more freely—when it is placed well forward on his shoulders. With characteristic conservatism the English were slow to accept the new plan. Several American jockeys, however, came to England. In all the main attributes of horsemanship there was no reason to believe that they were in the least superior to English jockeys, but their constant successes required explanation, and the only way to account for them appeared to be that horses derived a marked advantage from the new system of saddling. A number of English riders followed the American lead, and those who did so met with an unusual degree of success. Race-riding, indeed, was in a very great measure revolutionized in the closing years of the 19th century.

Of late years American horses—bred, it must always be remembered, from stock imported from England—have won many races in England. Australian horses have also been sent to the mother country, with results remunerative to their owners, and the intermixture of blood which will necessarily result should have beneficial consequences. French horses—i.e. horses bred in France from

Foreign horses.

immediate or from more or less remote English parentage—have also on various occasions distinguished themselves on English racecourses. That coveted trophy, the Ascot Cup, was won by a French horse, Elf II., in 1898, it having fallen also to the French-bred Verneuil in 1878, to Boiard in 1874, to Henry in 1872 and to Mortemer in 1871. In the Cesarewitch Plaisanterie (3 yrs., 7st. 8 lb) and Ténébreuse (4 yrs., 8 st. 12 lb) were successful in 1885 and 1888; and Plaisanterie also carried off the Cambridgeshire as a three-year-old with the heavy weight of 8 st. 12 lb in a field of 27 runners. In most respects racing in France is conducted with praiseworthy discrimination. There are scarcely any of the five- and six-furlong scrambles for horses over two years old which are such common features of English programmes.

That the horses who have covered various distances in the shortest times on record must have been exceptionally speedy animals is obvious. The times of races, however, frequently form a most deceptive basis in any attempt to gauge the relative capacity of horses. A good animal will often win a race in bad time, for the reason that his opponents are unable to make him exert himself to the utmost. Not seldom a race is described as having been "won in a canter," and this necessarily signifies that if the winner had been harder pressed he would have completed the course more quickly. The following figures show the shortest times that had been occupied in winning over various distances up to the spring of 1910:—

	M. S.
Five furlongs	{ Mirida (2 years), Epsom, 1905 } o 56½
	{ Le Buff (aged), Epsom, 1903 } o 56½
	{ Master Willie (aged), Epsom, 1903 } o 56½
Six furlongs	Master Willie (3 years), Epsom, 1901 1 7½
Seven furlongs	Vay (4 years), Epsom, 1907 1 20½
Mile	Cainan (4 years), Lingfield, 1900 1 33½
Mile and a quarter	Housewife (3 years), Brighton, 1904 2 1½
Mile and a half	Zinfandel (3 years), Manchester, 1903 2 28½
Mile and three quarters	Golden Measure (4 years), York, 1906 2 57½
Two miles	Pradella (aged), Ascot, 1906 3 19½
Two miles and a half	Bachelor's Button, Ascot, 1906 4 23½
Three miles	Corrie Roy, Ascot, 1884 5 9

It may be noted that, as compared with similar records in 1901, only three of these latter held good in 1910, i.e. the mile, the six furlongs and the three miles. The fastest times over a mile and a half (the Derby and Oaks distance) up to 1901 may be repeated here as of some interest: Avidity, 2 min. 30½ secs., in September 1901 at Doncaster; Santoi, 2 min. 31 secs., in May 1901 at Hurst Park; King's Courier, 2 min. 31 secs., in 1900 at Hurst Park; Landrail, 2 min. 34 secs., in September 1899 at Doncaster; Caribston, 2 min. 37½ secs., in August 1899 at York; Bend Or, 2 min. 40 secs., in 1888 at Epsom (gold cup); Volodyovski won the Derby in 1901, and Memoir the Oaks in 1890, in 2 min. 40½ secs.

As regards time in famous races, Ormonde, perhaps the best horse of the 19th century—one, at any rate, that can scarcely have had a superior—occupied 2 minutes 45½ seconds in winning the Derby; and Lonely, one of the worst masters that have won the Oaks, galloped the same mile and a half in 2 seconds less. Ormonde's St Leger time was 3 m. 21½ s., and Sir Visto, one of the poorest specimens of a winner of the great Doncaster race, took 3 m. 18½ s. The regulation of the weight to be carried serves to "bring the horses together," as the popular sporting phrase runs—that is to say, it equalizes their chances of winning; hence handicaps, the carrying of penalties by winners of previous races, and the granting of "maiden allowances." A horse that has never won a race, and is therefore known as a "maiden," often has an allowance of as much as 7 lb made in its favour.

Sport is carried on under the auspices of the Jockey Club, a self-elected body of the highest standing, whose powers are absolute and whose sway is judicious and beneficent. Three stewards, one of whom retires each year, when a successor is nominated, govern the active—and extremely arduous—work of the club. They grant licences to trainers and jockeys and all officials, and supervise the whole business of racing. The stewards of the Jockey Club are *ex officio* stewards of Ascot, Epsom, Goodwood and

The Jockey Club.

Doncaster. All other meetings are controlled by stewards, usually well-known patrons of the Turf invited to act by the projectors of the fixture, who settle disputed points, hear and adjudicate on objections, &c., and, if special difficulties arise, report to the stewards of the Jockey Club, whose decision is final.

Steeplechasing has altered entirely since the first introduction of this essentially British sport. In early days men were accustomed to match their hunters against each other and ride across country to a fixed point near to some steeple which guided them on their way; and this is no doubt, in several respects, a class of sport superior to that now practised under the name of steeplechasing; for it tested the capacity of the horse to jump fences of all descriptions, and provided the rider with opportunities of showing his readiness and skill in picking the best line of country. But racing of this kind afforded spectators a very small chance of watching the struggle; and made-up steeplechase courses the whole circuit of which could be viewed from the enclosures, came into existence. The steeplechase horse has also changed. The speed of the thoroughbred is so much greater than that of all other breeds that if one were in the field, if he only stood up and could jump a little, his success was certain; consequently, except in "point-to-point" races, organized by various hunts, where a qualification is that all starters must have been regularly ridden with hounds, few other than thoroughbred horses are nowadays ever found in races run under the rules of the National Hunt Committee, the body which governs the sport of steeplechasing. A considerable proportion of existing steeplechase horses have done duty on the flat. Members of certain equine families display a special aptitude for jumping; thus the descendants of Hermit, who won the Derby in 1867, are very frequently successful in steeplechases—Hermit's son Ascotic, the sire of Cloister, Hidden Mystery and other good winners, is a notable case in point. The sons and daughters of Timothy and of several other Hermit horses often jump well. When a flat-race horse appears to have comparatively poor prospects of winning under Jockey Club rules, he is frequently, if he "looks like jumping," schooled for steeplechasing, generally in the first place over hurdles, and subsequently over what is technically called "a country," beginning with small fences, over which he canters, led by some steady animal who is to be depended on to show the way. A great many steeplechase horses also come from Ireland. They are usually recognizable as thoroughbred, though it is possible that in some cases the name of an ancestor may be missing from the Stud Book. Irish horse-masters are for the most part particularly skilful in schooling jumpers, and the grass and climate of Ireland appear to have beneficial effects on young stock; but, as a rule, the imported Irish horse improves considerably in an English training-stable, where he is better fed and groomed than in most Irish establishments. All steeplechase courses must at the present time contain certain regulation jumps, the nature of which is specified in the National Hunt rules:—

44. In all steeplechase courses there shall be at least twelve fences (exclusive of hurdles) in the first 2 m., and at least six fences in each succeeding m. There shall be a water jump at least 12 ft. wide and 2 ft. deep, to be left open, or guarded only by a perpendicular fence not exceeding 2 ft. in height. There shall be in each m. at least one ditch 6 ft. wide and 3 ft. deep on the taking-off side of the fence, which ditch may be guarded by a single rail, or left open, and which fence must be 4 ft. 6 in. in height, and, if of dead brushwood or gorse, 2 ft. in width.

45. In all hurdle-race courses there shall be not less than eight flights of hurdles in the first 2 m., with an additional flight of hurdles for every quarter of a m. or part of one beyond that distance, the height of the hurdles being not less than 3 ft. 6 in. from the bottom bar to the top bar.

Natural fences would no doubt be desirable if they could be utilized; but it is obvious that fences must be made up, because when the same hedge is jumped frequently, and for the most part in the same place—as it is the object of riders to go the shortest way round—gaps would necessarily be made. The use of

these made courses naturally renders the sport somewhat artificial, but under existing conditions this is unavoidable; and as a matter of fact, by reason of the conformation of the ground, the arrangement and make of the fences, courses do vary in no small degree. The steeplechase horse differs from the hunter in his method of jumping. In riding to hounds a man usually steadies his horse at a fence, and in almost every case the animal "dwells" more or less after the leap. In a steeplechase, where speed is everything, horses must be taught to dash resolutely at their jumps without hesitation, and to get away with no pause on the other side; as a rule, therefore, an old steeplechase horse who is employed as a hunter is rarely a pleasant mount for any but a bold rider. It has been remarked that steeplechase horses are usually in the first place schooled over hurdles, and many animals remain hurdle racers till the end. More speed is required for hurdles than for a steeplechase course, and there is more money to be won over hurdles than over "a country." No hurdle race is worth so much as the Grand National or the Lancashire Handicap Steeplechase, the two richest prizes now offered; but, with the exception of these, hurdle-race stakes are as a rule of greater value. Except as a spectacle, there is little to be said in defence of this mongrel business, which is neither one thing nor the other; but hurdle races are popular and are therefore likely to continue. A few years ago an attempt was made to discriminate between what were called "hunters" and handicap steeplechase horses, and certain races were only open to the former class. It proved, however, to be a distinction without a difference; thoroughbred horses crept into the ranks of the so-called hunters, and when nominal hunters began to be entered for, and in some cases to win, the Grand National and other important steeplechases, for which they could be nominated by abandoning their qualification of hunter, the meaningless title was relinquished. Still more absurd were the hunters' flat races of a former day. In order to compete in these the rule was that an owner must produce a certificate from a master of hounds to the effect that his horse had been hunted. Thoroughbreds who lacked speed to win under Jockey Club rules used to be ridden to a meet, perhaps cantered across a field or two, and were then supposed to have become hunters. Animals who were genuinely and regularly utilized for the pursuit of foxes had of course no chance against these race-horses in shallow disguise. What are called National Hunt flat races still exist, the qualification being that a horse must have been placed first, second or third in a steeplechase in Great Britain or Ireland, after having jumped all the fences and completed the whole distance of the race to the satisfaction of at least two of the stewards, to whom previous notice must have been given in writing. There are no handicaps for such animals, and none is allowed to carry less than 11 stone. No race under National Hunt rules can be of a shorter distance than 2 m., except for three-year-olds, who sometimes run a mile and a half over hurdles; and the lowest weight carried can never be less than 10 stone except in a handicap steeplechase of 3½ m. or upwards, when it may be 9 st. 7 lb.

Horses are ridden in these races either by gentlemen, or qualified riders or jockeys. The first of these classes comprises officers on full pay in the army or navy, persons holding commissions under the Crown, bearing titles either in their own right or by courtesy, or members of certain social and racing clubs. Qualified riders may be farmers holding at least a hundred acres of land, their sons if following the same occupation, and persons elected by members of the National Hunt Committee, a proviso being that they must never have ridden for hire; but it is feared that this rule is in not a few cases evaded. Professional jockeys are paid £5 for each mount or £10 if they win. The sport is governed by the National Hunt Committee, a body which receives delegated powers from the Jockey Club, and six stewards are elected every year to supervise the business of the various meetings. Steeplechases and hurdle races are either handicaps or weight-for-age races according to the following scale:—

For Steeplechases of 3 miles and upwards.

From the 1st of January to the 30th of June, both inclusive:—
 4 yrs. 5 yrs. 6 and aged
 10 st. 3 lb 11 st. 8 lb 12 st. 3 lb
 From the 1st of July to the 31st of December, both inclusive:—
 4 yrs. 5 yrs. 6 and aged
 11 st. 11 st. 12 lb 12 st. 3 lb

For Steeplechases of less than 3 miles.

From the 1st of January to the 30th of June, both inclusive:—
 4 yrs. 5 yrs. 6 and aged
 10 st. 10 lb 11 st. 10 lb 12 st. 3 lb
 From the 1st of July to the 31st of December, both inclusive:—
 4 yrs. 5 yrs. 6 and aged
 11 st. 6 lb 12 st. 12 st. 3 lb

For Hurdle Races.

From the 1st of January to the 31st of August, inclusive:—
 4 yrs. 5 yrs. 6 and aged
 11 st. 6 lb 11 st. 10 lb 12 st. 0 lb
 From the 1st of September to the 31st of December, inclusive:—
 3 yrs. 4 yrs. 5, 6, and aged
 10 st. 7 lb 11 st. 12 lb 12 st. 3 lb

The great test of merit in a steeplechase horse is success in the Grand National, which is always run at Liverpool during the first week of the flat-racing season. The course is *The Grand National*, 4½ m., and includes thirty jumps, the fences being for the most part larger than are found elsewhere. The average time occupied is well under ten minutes. The stake has varied in value since the race was originated in 1839; it now amounts to close on £2500. Only a very small percentage of steeplechase horses possess the speed and staying power to give them a chance in this race, and the number of entries year by year falls considerably short of a hundred, the prospects of many of these usually appearing hopeless to all but unduly sanguine owners. The average number of starters during the period 1860-1901 was rather over twenty. As many as thirty-two competed in 1909, when the French-bred Lateur III. won; in 1883, when Zoedone, ridden by her owner, Count Kinsky, was successful, only ten went to the post. Mishaps are almost invariably numerous; in most years about one-third complete the course. So severe is the task that for a long time many good judges of steeplechasing believed that no horse with more than 12 stone on his back could possibly win. In 1893, however, Cloister won in a canter by forty lengths carrying 12 st. 7 lb, and with the same weight Manifesto also won in 1899. The race which most nearly approaches the Grand National in importance is the Lancashire Handicap Steeplechase, run at Manchester over 3½ m. early in April. The stake is worth about £1750. An interesting steeplechase called the Grand Sefton takes place at Liverpool about the middle of November; the distance is 3 m. During the winter, and extending into the spring, steeplechasing and hurdle racing are carried on at Sandown, Kempton, Gatwick, Lingfield, Newbury and Hurst Park; at Ludlow, Newmarket, Aldershot, Birmingham, Manchester, Windsor and other places. A race called the National Hunt Steeplechase, under the immediate patronage of the National Hunt Committee, is run annually over a 4-mile course, the stake being £1000. Managers of various courses bid for the privilege of having the race on their ground, and it is therefore found in different localities. A condition is that no horse who has ever won a race can compete; and, as few owners are willing to keep their animals with a view to success in this event, the field consists either of unknown horses or of those that have been beaten.

AUSTRALIA

Racing in Australia has its headquarters at Sydney, under the government of the Australian Jockey Club, the principal course being at Randwick; and at Melbourne, where the Victoria Jockey Club is supreme, the principal course being at Flemington. In New Zealand sport is carried on under the authority of delegates from the chief racing clubs, who meet in conference. There is a Sydney Derby and a Victoria Derby, and a notable event at Flemington is the Champion Race, weight-for-age, for three-year-olds and upwards, which usually attracts the best horses in training, as the fee at which a sire stands depends in a great measure on his success in this contest. This race is over a distance of 3 m., and to ensure a good pace there is a regulation that the time in which it is run must not exceed 5 minutes 40 seconds, though the stewards have power to

extend this in case the ground should be made exceptionally heavy by rainy weather. The Melbourne Cup is regarded as one of the most important races in the state. This is a handicap, and in comparison with English races may perhaps be ranked with the Cesarewitch. The birth of horses dates from the 1st of August, which corresponds as nearly as possible to the 1st of February in England, so that the Australian horses are practically seven months younger than the English—a matter of some importance in the case of those sent to run in England. There are few races which close long before the date of decision, and practically all the good animals run in handicaps. The five- and six-furlong races for other than two-year-olds, so common in Great Britain, are extremely rare; and it is asserted by colonial sportsmen that their horses stay better than those bred in England, a circumstance which is largely attributed to the fact that mares and foals have much more liberty and exercise than is the case in the mother country.

UNITED STATES

Horse-racing was indulged in to a limited extent in Maryland and Virginia as early as the middle of the 17th century, particularly in the latter colony. Most of the inhabitants of both were either from the British Isles or were descended from parents who had immigrated from them, and they inherited a taste for the sport. The animals used for this purpose, however, were not highly prized at the time, and the pedigree of not even one of them has been preserved. A horse called Bully Rock by the Darley Arabian out of a mare by the Byerly Turk, granddam by the Lister Turk, great-granddam a royal mare, foaled 1718, is the first recorded importation of a thoroughbred horse into America. He was imported into Virginia in 1730. In 1723 the duke of Bolton bred a mare named Bonny Lass by his celebrated horse Bay Bolton out of a daughter of the Darley Arabian. She became celebrated in England as a brood mare, and was the first thoroughbred mare, according to the records, that was carried to America. This is supposed to have been in or after 1740, as the *Stud-Book* shows she produced in England after 1739 a filly by Lord Lonsdale's Arabian, and subsequently became familiar to the public as the granddam of Zamora. The importations increased very rapidly from this period, and many valuable shipments were made before the war which resulted in a separation of the colonies from the mother country. This acquisition of thoroughbred stock increased the number and value of racing prizes, and extended the area of operations into the Carolinas in the South, and New Jersey and New York in the North. The first race run in South Carolina was in February 1734 for £20. It took place over "the Green," on Charleston Neck. This shows that the earlier races in America were actually on the turf, as they have always been in England. The next year a Jockey Club was organized at Charleston (1735), and a course was prepared, such as those which came later into general use throughout the states, the turf being removed and the ground made as level as possible.

After 1776, when the United States declared their independence of Great Britain, the importation of thoroughbred horses from England became quite common, and selections were made from the best stocks in the United Kingdom. This continued and even increased as the country became developed, down to 1840. The following Derby winners were among those carried into the states: Diomed, who won the first Derby in 1780; Saltram, winner in 1783; John Bull, winner in 1792; Spread Eagle, winner in 1795; Sir Harry, winner in 1798; Archduke, winner in 1799; and Priam, who won in 1830. The most important and valuable importations, however, proved to be Jolly Roger, Fearnought, Medley, Traveller, Diomed, Glencoe, Leviathan, Tranby, Lexington, Margrave, Yorkshire Buzzard, Albion and Leamington. The best results were obtained from Diomed and Glencoe. Diomed sired one horse, Sir Archy, who founded a family to which nearly all the blood horses of America trace back. He was foaled in 1805, in Virginia, and became celebrated as a sire. The superiority of his progeny was so generally conceded that they were greatly sought after. From this period, too, the number and value of races increased; still they were comparatively few in number, and could not compare in value with those of Great Britain. Up to 1860 the value of racing prizes was quite inadequate to develop large breeding establishments,

or to sustain extensive training stables. Then the civil war between the North and the South broke out, which raged for four years. Breeding establishments were broken up during that time; the horses were taken by the armies for cavalry purposes, for which service they were highly prized; and racing was completely paralysed. It took some time to regain its strength; but an era of prosperity set in about 1870, and since then the progress in interest has been continuous.

In the United States interest in trotting races more than rivals that felt in the contests of thoroughbred horses. This interest dates back to the importation to Philadelphia from England, in 1788, of the thoroughbred horse Messenger, a grey stallion, by Mambrino, 1st dam by Turf, 2nd dam by Regulus, 3rd dam by Starling, 4th dam by Fox, 5th dam Gipsy, by Bay Bolton, 6th dam by duke of Newcastle's Turk, 7th dam by Byerly Turk, 8th dam by Taffolet Barb, 9th dam by Place's White Turk. He was eight years old when imported to the United States. He was at the stud for twenty years, in the vicinity of Philadelphia and New York, serving a number of thoroughbred mares; but a far greater number of cold-blooded mares, and in the progeny of the latter the trotting instinct was almost invariably developed, while his thoroughbred sons, who became scattered over the country, were also noted for transmitting the trotting instinct. The first public trotting race of which there is any account in the United States was in 1818, when the grey gelding Boston Blue was matched to trot a mile in 3 minutes, a feat deemed impossible; but he won, though the time of his performance has not been preserved. From about that date interest in this gait began to increase; breeders of trotters sprang up, and horses were trained for trotting contests. The problem of breeding trotters has been necessarily found to be a much more complex one than that of breeding the thoroughbred, as in the latter case pure blood lines of long recognized value could be relied upon, while in the former the best results were constantly being obtained from most unexpected sources. Among the leading families came to be the Hambletonian, of which the modern head was Rysdyk's Hambletonian, a bay horse foaled in 1849, got by Abdallah (traced to imp. Messenger on the side of both sire and dam) out of the Charles Kent mare, by imp. (i.e. imported) Bellfounder, with two crosses to imp. Messenger on her dam's side; the Mambrinos, whose modern head was Mambrino Chief, foaled 1844, by Mambrino Paymaster, a grandson of imp. Messenger; the Bashaws, founded by Young Bashaw, foaled 1822, by Grand Bashaw, an Arabian horse, dam Pearl, by First Consul; the Clays, springing from Henry Clay, a grandson of Young Bashaw through Andrew Jackson; the Stars, springing from Stockholm's American Star, by Duroc, son of imp. Diomed; the Morgans, whose founder was Justin Morgan, foaled 1793, by a horse called True Briton, or Beautiful Bay, who was probably thoroughbred; the Black Hawks, a branch of the Morgan family; the Blue Bulls, descended from Doyle's Blue Bull, foaled 1855, a pacer, sired by a pacer of the same name, dam by Blacknose, son of Medoc; the Canadians, whose best representatives were St Lawrence and pacing Pilot, horses of unknown pedigree; the Gold Dusts, another branch of the Morgan family; and the Royal Georges, springing from Tippoo, a horse who was probably by Ogden's Messenger, son of imp. Messenger. But trotters of great speed have been produced which do not trace to any of the sources mentioned. Very large prices are paid. Steinway, a three-year-old colt, was sold in 1870, to go to California, for \$13,000; and in 1878 \$21,000 was paid for the four-year-old filly Maud S., after she had trotted a mile in public in 2 m. 17½ s. Much larger sums have been paid, however, for matured trotters, such as \$40,000 for the stallion Smuggler, \$38,000 for Pocahontas, \$35,000 for Dexter, \$36,000 for Rarus, and long prices for many others; St Julien, the trotter with the fastest record at the close of 1870, was held at \$50,000, while Rysdyk's Hambletonian, Messenger Duroc and Volunteer were valued, in their prime, at \$100,000 each.

Compared with the early days of American trotting, the advance has been rapid and the changes marked. After the performance of Boston Blue, mentioned above, more attention

was paid to the gait, but for a long time the races were generally under saddle, and at long distances, 3 m. being rather the favourite. The best of the old time trotters were Edwin Forrest, who trotted a mile in 2 m. 31½ s. in 1834; Dutchman, who did 3 m. under saddle in 7 m. 32½ s.; Ripton; Lady Suffolk, who trotted a mile in 2 m. 26½ s. in 1843, and headed the list of performers; Mac, Tacony, &c. After 1850, however, the taste of the people settled upon the style of race called "mile heats, best three out of five, in harness" as the favourite. By "in harness" is meant that the horse draws a sulky, a light two-wheeled vehicle in which the driver sits close to the horse, with his legs on each side of his flanks. These sulkies often weigh less than 40 lb. The driver is required to weigh, with the blanket on which he sits, 150 lb, while for saddle races the regulation weight is 145 lb, or 10 st. 5 lb. Each heat of a mile is a separate race; 20 minutes is allowed between heats; and the horse that first places three heats to his credit wins the race. There are various penalties imposed upon a horse that breaks into a run in a trotting race. The driver is required to pull him to a trot as quickly as possible; if the horse gains by running, the judges set him back at the finish twice the distance he has gained, in their estimation, by running; and for repeated "breaks" they can declare him distanced. The first-class tracks are of oval shape, with long stretches and easy curves, measuring 1 m. at 3 ft. distance from the "pole," as the inner railing of the track is called. The time in which the leading horse trots each heat is accurately kept, placed on a blackboard in front of the judges' stand for the information of the public, and also placed in the book of the course. The fastest time that any trotter has is thus entered as his "record." This is one of the distinctive features of trotting in America.

Prior to 1866 purses for trotters were small; match races were more in vogue, and the trotting turf was in bad odour. In that year an association was formed at Buffalo, N.Y., which inaugurated its efforts by offering the then unprecedented sum of \$10,500 for a trotting meeting of four days' duration. The experiment was successful; other cities followed the example of Buffalo; larger and larger purses were given; and at Buffalo in 1872 the prizes amounted to \$70,000. Since then the amount offered in the United States and Canada, during a single year, has reached \$1,500,000. Individual trotters, in the course of a long turf career, earn enormous amounts. A remarkable instance of this was the mare Goldsmith Maid, by Alexander's Abdallah (a son of Rysdyk's Hambletonian), out of an Abdallah mare. She began trotting in 1866, and left the turf in 1878, when twenty-one years old, and her winnings amounted to over \$500,000.

In 1869 the National Trotting Association was formed, under which an elaborate code of rules has been published.

In trotting races, it will be noted, the time test is supreme, differing from running races, in which time is of comparatively little consequence. The animal which has the fastest record for 1 mile in harness is, until deposed, the king or queen of the trotting turf. Lady Suffolk, with her record of 2 m. 26½ s., in 1843, held this honour until 1853, when Tacony trotted in 2 m. 25½ s. under saddle; Flora Temple wrested it from him in 1856 by trotting in 2 m. 24½ s. in harness. This latter mare, in 1859, trotted a mile in 2 m. 19½ s., a feat which the best horsemen thought would never be repeated, but since that time forty-two trotters have beaten 2 m. 20 s. Dexter's record was 2 m. 17½ s. in 1867, and Goldsmith Maid's in 1871 was 2 m. 17 s., which she reduced, by successive efforts, to 2 m. 16½ s., 2 m. 16 s., 2 m. 15 s., 2 m. 14½ s., and finally, in 1874, to 2 m. 14 s. In 1878 Rarus trotted a mile in 2 m. 13½ s., and in October 1879 the bay gelding St Julien, by Volunteer, son of Rysdyk's Hambletonian, dam by Henry Clay, trotted a mile in California in 2 m. 12½ s. Other notable performances reducing the record were Maud S. in 1881, 2 m. 10½ s.; Maud S. in 1885, 2 m. 8½ s.; Sunol in 1891, 2 m. 8½ s.; Nancy Hanks in 1892, 2 m. 4 s.; Alix in 1894, 2 m. 3½ s.; Cresceus in 1901, 2 m. 2½ s.; Lou Dillon in 1905, 1 m. 58½ s. Improved times have doubtless been the result of improved methods, as well as of care in the breeding of the trotter. Some very severe training rules used to be sedulously observed, about 1870, for

instance, a horse never had water the night before a race, and the system generally appears to have overtaxed the animal's strength. A prominent consideration in trotting races is the adjustment of toe-weights, which are fastened on to the horses' feet to equalize their action, and it is found that horses improve their time to the extent of several seconds when properly shod.

Pacing races are also frequent in the United States. In trotting the action may be described as diagonal; the pacer moves both legs on the same side at the same time, and both feet stride as one. A similar "gait," to employ the American term, was called in England some centuries ago an "amble." The pacer moves more easily and with apparently less exertion than the trotter, and the mile record (made by Prince Alert in 1903) stands at 1 m. 57 s.

Owing to the vast size of the country there are various centres of sport, which can be classified with reasonable accuracy as follows: the Eastern States, dominated by the Jockey Club, founded in New York in 1804, and recognized by a state law in 1805; the Middle Western States, under the control of the Western Jockey Club, whose headquarters are in Chicago; the Pacific Coast, with San Francisco for its centre; and the Southern and South-Western States, with Louisville as the most important centre. The passage of the racing law in New York State marked the opening of a new era. Supreme even over the Jockey Club is a State Racing Commission of three, appointed by the governor of the state. While the Jockey Club is only recognized by law in its native state, it has assumed and maintains control of all racing on the eastern seaboard, within certain lines of latitude and longitude, extending as far north as the Canadian border and south to Georgia. There is small question that other states, both east and west, will follow suit and enact similar laws. The Western Jockey Club, though not recognized by law, controls practically all the racing through the middle west, south-west and south; but the racing associations of the Pacific Coast have maintained a position of independence.

What New York is to the east, Chicago is to the middle west, and a very large proportion of American racing is conducted close to these centres. In New York State the Coney Island Jockey Club, at Sheepshead Bay; the Brooklyn Jockey Club, at Gravesend; the Westchester Racing Association, at Morris Park; the Brighton Beach Racing Association, at Brighton Beach; the Queen's County Jockey Club, at Aqueduct; and the Saratoga Racing Association, at Saratoga, are the leading organizations; and all these race-courses, with the exception of Saratoga, are within a radius of 20 miles of the city. The Empire City Jockey Club, near Yonkers, and another club with headquarters near Jamaica, Long Island, have also become prominent institutions. The Washington Park Club, at Chicago, is the leading Turf body of the west, and the only one on an equal footing with the prominent associations of New York State. With this single exception the most important and valuable stakes of the American Turf are given in the east; and so great has the prosperity of the Turf been since the Jockey Club came into existence that the list of rich prizes is growing at a surprising rate. In this respect the principal fault is the undue encouragement given to the racing of two-year-olds. At the winter meetings held at New Orleans and San Francisco, two-year-olds are raced from the very beginning of the year; and under the rules of the Jockey Club of New York they run as early as March. The Westchester Racing Association, with which are closely identified some of the principal members of the Jockey Club, gives valuable two-year-old stakes in May. The Futurity Stakes, the richest event of the year—on one occasion it reached a value of \$67,675—is for two-year-olds, and is run at Sheepshead Bay in the autumn. The institution of races, either absolutely or practically at weight-for-age, and over long courses, has engaged much attention. The Coney Island Jockey Club has the leading three-year-old stake in the Lawrence Realization, over 1 mile 5 furlongs, with an average value of about \$30,000. The Westchester Racing Association's two principal three-year-old stakes, the Withers,

over a mile, run in May, and the Belmont, 2 mile and 3 furlongs, run later in the same month, are of less value, but are much older-established and have a species of "classic" prestige, dating from the old Jerome Park race-course in the 'sixties. The Coney Island Jockey Club's Century and the Annual Champion Stakes, both for three-year-olds and upwards, over a mile and a half and two miles and a quarter respectively, are fair specimens of the races the associations have founded. At Saratoga a stake of \$50,000 for three-year-olds and upwards, distance a mile and a quarter, was opened, and run for first in 1904. The hope is to wean owners from the practice of overtaxing their two-year-olds, which has resulted practically in a positive dearth, almost a total absence, of good four-year-olds and upwards of late years. Handicaps play a more important part than in England. The principal events of this character, such as the Brooklyn Handicap at Gravesend and the Suburban at Sheepshead Bay, have for years drawn the largest attendances of the racing season.

Practically all flat racing in the United States is held on "dirt-tracks," i.e. courses with soil specially prepared for racing, instead of turf courses. At Sheepshead Bay there is a turf course, but it is only used for a minority of races. Dirt-tracks, which are, like many other things in American racing, a legacy from the once hugely popular harness-racing, are conducive to great speed, but are costly in the extreme strain on horses' legs. Steeplechases are run on turf. This branch of the sport in the east is now flourishing under the administration of the National Steeplechase and Hunt Association, a sister body of the Jockey Club. Comparatively few races are, however, run under these rules, as the weather conditions render it impossible to have a separate season for cross-country sport and steeplechases, and hurdle races are incorporated in programmes of flat racing held through the spring, summer and autumn, though the ground is frequently so hard as to be unsafe. Since the National Steeplechase and Hunt Association assumed control, regulation courses, practically similar in every respect to those used in England, have been insisted upon in the east, the "open ditch" figuring under the name of the "Liverpool." In the west and south there is not the same uniformity, and so far the sport has not flourished.

FRANCE

Racing in France as conducted on modern lines may be said to date from the year 1833, when the French *Stud-Book* was originated, and a body formed, somewhat after the model of the English Jockey Club, under the title of the Société d'Encouragement pour l'Amélioration des Races de Chevaux en France. Races took place in the Champs de Mars, and an unsuccessful attempt was made in 1834 to arrange for a course, or "hippodrome," as it is termed in France, at Maisons Laffitte. Chantilly was, however, fixed upon as the principal racing centre; on the 22nd April 1836 the first meeting was held there, with five races on the card, the principal being the Prix d'Orléans, a stake of 3500 francs, named after the duc d'Orléans, one of the chief promoters of the fixture. Next day the first race for the Prix du Jockey Club was run, and won by Frank, the property of Lord Henry Seymour, who was at the time taking a very active part in French sport. The Prix du Jockey Club was then worth 5000 francs; the value has since increased to 200,000 francs. This race occupies in France the place of the English Derby. The Prix de Diane, which corresponds to the English Oaks, was first run in 1843. Chantilly still continues an important centre of the French Turf, and a great many horses are trained in the district. Attempts had been made to popularize racing at Longchamps prior to the year 1836, when the Société d'Encouragement obtained a lease, erected stands, laid out the course, and held their first meeting on the 27th August 1857. Next season two meetings were held, one of four days in the spring and another of three in the autumn; at the present time the sport is vigorously carried on from March to the end of October, except during a summer recess. In 1857 meetings under the auspices of the Société d'Encouragement began to

take place at Amiens, Caen, Nantes, Versailles, Moulins and other towns; and there were stakes for two-year-olds in the spring, though of late years the appearance of the young horses has been postponed to the 1st of August. Progress was rapid, and in 1863 two important events were contested for the first time, the Prix du Prince Impérial, which was designed to balance the English St Leger, but for obvious reasons faded out of the programme, and the Grand Prix de Paris, an international race for three-year-olds, run at Longchamps over a distance of 1 mile 7 furlongs, and now the most valuable stake in Europe. In 1909 the prize was £14,071. The first Grand Prix fell to an English horse, Mr Savile's The Ranger; two years later it was won by Gladiateur, winner of the English Derby and the property of the comte de Lagrange, who raced equally in France and in England; the duke of Beaufort's Ceylon was successful in 1866, and the marquis of Hastings' Earl in 1868. Mr Savile's Cremorne followed up his Derby victory by a victory at Longchamps in 1872, as did Mr Baltazzi's Kiaber four years later. English horses were also victorious in 1874 (Mr W. R. Marshall's Trent), in 1878 (Prince Soltykoff's Thurio), in 1880 (Mr C. Brewer's Robert the Devil), in 1881 (Mr Keene's Foxhall, who, however, should rather rank as an American horse), in 1882 (Mr Rymill's Bruce), in 1885 (Mr Cloete's Paradox), in 1886 (Mr Vyner's Minting); and in 1906 Major Eustace Loder's Derby winner Spearmint. During the first 23 years of the Grand Prix (owing to the war the race did not take place in 1871) the stake fell to English horses—if Kisber and Foxhall be included—on twelve occasions, and generally to English jockeys. In recent years, however, French owners have held their own. In not a few respects racing is managed more judiciously than in England. The courses, for one thing, are better tended and maintained. The five- and six-furlong races for others than two-year-olds, which are so common at English meetings, are comparatively rare in France, and the value of the prizes in an average day's racing is considerably higher across the Channel than in England. A very large percentage of trainers and jockeys are English, and the former are, as a rule, quite as expert as at Newmarket and elsewhere. Transatlantic methods have been introduced by American jockeys since 1899. From the middle of February until the middle of December a race meeting within easy reach of Paris takes place almost every day, except during August, when the sport is carried on in the provinces, notably at Deauville. Near Paris, the chief centre after Longchamps is Maisons Laffitte. At Longchamps, early in October, a race called the Prix du Conseil Municipal, worth £4000, for three-year-olds and upwards, over a mile and a half, was organized in 1893, and has usually attracted English horses, Mr Wallace Johnstone's Best Man having been successful in 1894, and Mr Sullivan's Winkfield's Pride the following year. Except when the Whip is challenged for and the challenge decided over the Beacon Course at Newmarket, no race is run in England over a longer distance than two miles and 6 furlongs; but in France the Prix Gladiateur, of £1200 and a work of art value £100, 3 miles 7 furlongs, creates considerable interest at Longchamps in the autumn.

The first recognized steeplechase in France took place at Croix de Berny, and was won by the comte de Vaublanc's May-fly, all the horses at that time being ridden by gentlemen. Sport does not seem to have been carried on with much spirit, for it is said that the death of an animal called Barcha, in 1839, nearly led to the abandonment of the meeting; and it was not till 1863, when the Société des Steeplechases de France was founded, that the business was resolutely taken in hand. Gravelle and Vincennes were the principal centres until 1873, when the Société obtained possession of the ground at Auteuil, where the excellent course now in use was laid out. In 1874 twelve days' racing took place here, the card each day including three steeplechases and a hurdle race, the "hurdles," however, being small fences, as they are at present. The Grand Steeplechase d'Auteuil was then for a stake of 30,000 francs, at the time the most valuable offered in any country; but, as in racing

on the flat, the stakes have enormously increased in value, and in 1901 the Paris Grand Steeplechase, as the chief event is now called, credited the winner with £6020, the hurdle race being worth rather more than half as much. In England there is scarcely any steeplechasing between March and November, except at hunt meetings, but in Paris cross-country sport is pursued almost all through the year, the chief races at Auteuil taking place in June, about the time of the Grand Prix, which is usually run for between the English Epsom and Ascot meetings. The Auteuil course is laid out in the shape of the figure 8, with varied fences, several of which really test a horse's jumping capacity; and variety is further obtained by starting the fields in different places and traversing the course in different ways. St Ouen, a meeting within half an hour's drive of the Louvre, is entirely devoted to steeplechasing; and jumping is also carried on at Vincennes, Colombes, Enghien, and elsewhere near Paris, as also at Nice in the winter, at Dieppe and other places in August. As a rule, the stakes run for, especially at Auteuil, are very much larger than in England. There are none of the clubs and special enclosures such as at Sandown, Kempton, Hurst, Lingfield, Gatwick, &c., though portions of the stand are set apart for privileged persons. A fee of 20 francs is charged for admission to the chief French race-courses, with half as much for a lady's voucher, and the tickets give access everywhere but to the very few reserved portions. At Vincennes, St Cloud, and some other courses trotting races are also contested.

Other Countries.—Racing in Germany is mainly conducted under the authority of the Union Club of Berlin, the principal course being the Hoppegarten. Two-year-olds do not run until the 1st of June, except in Saxony, where they appear a month earlier. During the month of August there are several days' racing at Baden-Baden, steeplechases as well as flat races being run. Some of the more valuable stakes are usually contested by a proportion of horses from France and other countries, a few being occasionally sent from England. For years past blood-stock has been imported from England. In Austria the two centres of racing are Vienna and Budapest, each of which has its Jockey Club. Racing in Belgium derives no little support from the contiguity of the country to France. The headquarters of the Belgium Jockey Club are in the Bois de la Cambre at Boisfort, and meetings are held at Ostend, Antwerp, Spa, Bruges and elsewhere. Steeplechases take place at Groeneland and on other Belgian courses, but are not of high class. Racing has not reached a great degree of excellence in Italy, though attempts have been made to improve competitors by the purchase of Melton, who won the Derby of 1885, and of other notable animals. Meetings take place at Florence, Padua, Bologna and other places, but the stakes are usually small. (A. E. T. W.)

HORSERADISH (Ger. *Meerrettig*; Fr. *raisfort* = *racine forte*, *cran de Bretagne*; Swed. *Peppar-rot*; Russ. *chren*), known botanically as *Cochlearia Armoracia*, a perennial plant of the natural order Cruciferae, having a stout cylindrical rootstock from the crown of which spring large radical leaves on long stalks, 4 to 6 in. broad, and about a foot in length with a deeply crenate margin, and coarsely veined; the stem-leaves are short-stalked or sessile, elongated and tapering to their attachment, the lower ones often deeply toothed. The flowers, which appear in May and June, are $\frac{1}{2}$ in. in width, in flat-topped panicles, with purplish sepals and white petals; the fruit is a small silicula, which does not ripen in the climate of England. The horseradish is indigenous to eastern Europe. Into western Europe and Great Britain, where it is to be met with on waste ground, it was probably introduced. It was wild in various parts of England in Gerard's time.

The root, the *armoraciae radix* of pharmacy, is $\frac{1}{2}$ to 2 in. or more in diameter, and commonly 1 ft., sometimes 3 ft. in length; the upper part is enlarged into a crown, which is annulated with the scars of fallen leaves; and from the numerous irregular lateral branches are produced vertical stolons, and also adventitious buds, which latter render the plant very difficult of extirpation. From the root of Aconite (*q.v.*), which has occasionally been mistaken for it, horseradish root differs in being more or less cylindrical from a little below the crown, and in its pale yellowish (or brownish) white hue externally, acrid and penetrating odour when scraped or bruised, and

pungent and either sweetish or bitter taste. Under the influence of a ferment which it contains, the fresh root yields on distillation with water about .05% of a volatile oil, butyl sulphocyanide, C_4H_9CNS . After drying, the root has been found to afford 11.15% of ash. Horseradish root is an ingredient in the *spiritus armoraciacae compositus* (dose 1-2 drachms) of the British Pharmacopoeia. It is an agreeable flavouring agent. In common with other species of *Cochlearia*, the horseradish was formerly in high repute as an antiscorbutic. The root was, as well as the leaves, taken with food by the Germans in the middle ages, whence the old French name for it, *moutarde des Allemands*; and Coles, writing in 1657, mentions its use with meat in England, where it is still chiefly employed as a condiment with beef.

For the successful cultivation of the horseradish, a light and friable damp soil is the most suitable; this having been trenched 3 ft. deep in autumn, and the surface turned down with a liberal supply of farm-yard manure, a second dressing of decomposed manure should in the ensuing spring be dug in 2 ft. deep, and pieces of the root 6 in. in length may then be planted a foot apart in narrow trenches. During summer the ground requires to be kept free of weeds; and the application of liquid manure twice or thrice in sufficient quantity to reach the lowest roots is an advantage. When dug the root may be long preserved in good condition by placing it in sand.

See Gerard, *Herball*, p. 240, ed. Johnson (1636); Flücker and Hanbury, *Pharmacographia*, p. 71 (2nd ed., 1879); Bentley and Trimen, *Med. Pl.*, i. 21 (1880).

HORSE-SHOES. The horny casing of the foot of the horse and other Solidungulates, while quite sufficient to protect the extremity of the limb under natural conditions, is found to wear away and break, especially in moist climates, when the animal is subjected to hard work of any kind. This, however, can be obviated by the simple device of attaching to the hoof a rim of iron, adjusted to the shape of the hoof. The animal itself has been in a very marked manner modified by shoeing, for without this we could have had neither the fleet racers nor the heavy and powerful cart-horses of the present day. Though the ancients were sufficiently impressed by the damage done to horses' hoofs to devise certain forms of covering for them (in the shape of socks or sandals), the practice of nailing iron plates or rim-shoes to the hoof does not appear to have been introduced earlier than the 2nd century B.C., and was not commonly known till the close of the 5th century A.D., or in regular use till the middle ages. The evidence for the earlier date depends on the doubtful interpretations of designs on coins, &c. As time went on, however, the profession of the farrier and the art of the shoemaker gradually grew in importance. It was only in the 19th century that horse-shoeing was introduced in Japan, where the former practice was to attach to the horse's feet shippers of straw, which were renewed when necessary, a custom which may indicate the usage of early peoples. In modern times much attention has been devoted to horse-shoeing by veterinary science, with the result of showing that methods formerly adopted caused cruel injury to horses and serious loss to their owners. The evils resulted from (1) paring the sole and frog; (2) applying shoes too heavy and of faulty shape; (3) employing too many and too large nails; (4) applying shoes too small and removing the wall of the hoof to make the feet fit the shoes, and (5) rasping the front of the hoof. In rural districts, where the art of the farrier is combined with general blacksmith work, too little attention is apt to be given to considerations which have an important bearing on the comfort, usefulness and life of the horse. According to modern principles (1) shoes should be as light as compatible with the wear demanded of them; (2) the ground face of the shoe should be concave, and the face applied to the foot plain; (3) heavy draught horses alone should have toe and heel calks on their shoes to increase foothold; (4) the excess growth of the wall or outer portion of horny matter should only be removed in re-shoeing, care being taken to keep both sides of the hoof of equal height; (5) the shoe should fit accurately to the circumference of the hoof, and project slightly beyond the heel; (6) the shoes should be fixed with as few nails as possible, six or

seven in fore-shoes and eight in hind-shoes, and (7) the nails should take a short thick hold of the wall, so that old nail-holes may be removed with the natural growth and paring of the horny matter. Horse-shoes and nails are now made with great economy by machinery, and special forms of shoe or plate are made for race-horses and trotters, or to suit abnormalities of the hoof.

HORSETAIL (*Equisetum*), the sole genus of the botanical natural order Equisetaceae, consisting of a group of vascular cryptogamous plants (see *PTERIDOPHYTES*) remarkable for the vegetative structure which resembles in general appearance the genera of flowering plants *Casuarina* and *Ephedra*. They are herbaceous plants growing from an underground much-

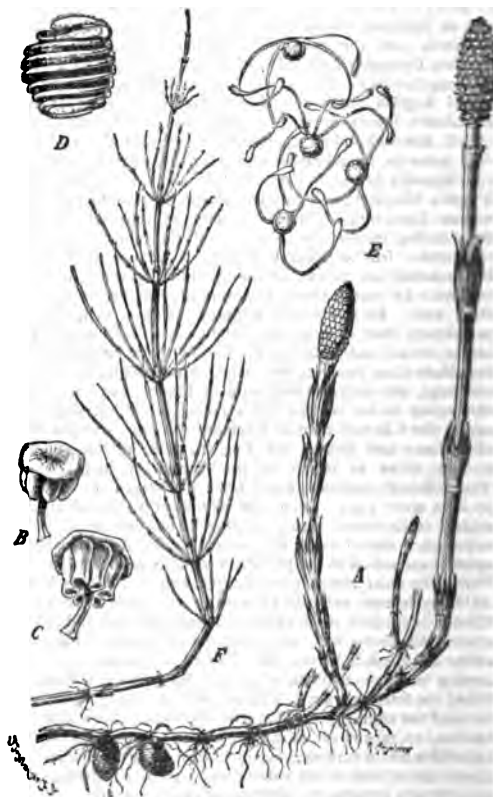

From Strasburger's *Lehrbuch der Botanik*, by permission of Gustav Fischer
Equisetum arvense.

- A. Fertile shoot, springing from the rhizome, which also bears tubers; the vegetative shoots have not yet unfolded.
B. Sporophylls bearing sporangia, which in C have opened.
C. Spore showing the two spiral bands of the peridium.
D. Spore showing the two spiral bands of the peridium.
E. Dry spores showing the expanded spiral bands.
F. Sterile vegetative shoot.
(A, F, reduced. B, C, D, E, enlarged.)

branched rootstock from which spring slender aerial shoots which are green, ribbed, and bear at each node a whorl of leaves reduced to a toothed sheath. From the nodes spring whorls of similar but more slender branches. Some shoots are sterile while others are fertile, bearing at the apex the so-called fructification—a dense oval, oblong conical or cylindrical spike, consisting of a number of shortly-stalked peltate scales, each of which has attached to its under surface a circle of spore-cases (*sporangia*).

which open by a longitudinal slit on their inner side. The spores differ from those of ferns in their outer coat (*exospore*) being split up into four club-shaped hygroscopic threads (*elaters*) which are curled when moist, but become straightened when dry. In most species the fertile and sterile shoots are alike, both being green and leaf-bearing, but in a few species the fertile are more or less different, e.g. in *E. arvense* the fertile shoots appear first, in the spring, and are unbranched and not green. Any portion of the underground rhizome when broken off is capable of producing a new plant; hence the difficulty of eradicating them when once established. There are 24 known species of the genus which is universally distributed.

The corn horsetail *E. arvense*, one of the commonest species, is a troublesome weed in clayey cornfields (see fig.). The fructification appears in March and April, terminating in short unbranched stems. It is said to produce diarrhoea in such cattle as eat it. The bog horsetail, *E. palustre*, is said to possess similar properties. It grows in marshes, ditches, pools and drains in meadows, and sometimes obstructs the flow of water with its dense matted roots. The fructification in this species is cylindrical, and in that of *E. limosum*, which grows in similar situations, it is ovate in outline. The largest British species, *E. maximum*, grows in wet sandy declivities by railway embankments or streams, &c., and is remarkable for its beauty, due to the abundance of its elegant branches and the alternately green and white appearance of the stem. In this species the fructification is conical or lanceolate, and is found in April on short, stout, unbranched stems which have large loose sheaths. Horses appear to be fond of this species, and in Sweden it is stored for use as winter fodder. *E. hyemale*, commonly known as the Dutch rush, is much more abundant in Holland than in Britain; it is used for polishing purposes. *E. variegatum* grows on wet sandy ground, and serves by means of its fibrous roots to bind the sand together. The horsetails are remarkable for the large quantity of silica they contain in the cuticle (hence their value in polishing), which often amounts to half the weight of the ash yielded by burning them; the roots contain a quantity of starch.

HORSHAM, a market town in the Horsham parliamentary division of Sussex, England, 38 m. S. by W. from London by the London, Brighton and South Coast railway. Pop. of urban district (1901) 9446. It is pleasantly situated in the midst of a fertile country near the source of the Arun. A picturesque avenue leads to the church of St Mary, principally Early English and Perpendicular, with remains of Norman work, having a lofty tower surmounted by a spire, and containing several fine monuments, tombs and brasses. Other buildings include the grammar school, founded in 1532 and rebuilt in 1893, a town hall and corn exchange, erected in 1866 in Italian style, with an assembly room. In the vicinity are several fine mansions. The buildings of Christ's Hospital (*q.v.*) at West Horsham were opened in 1902, the school being removed hither from London. The town has industries of tanning, founding, carriage-building and flour-milling.

Some neolithic remains have been found at Horsham. The town is not mentioned in Domesday Book, but the Rape of Bramber, in which it lies, belonged at that time to William de Braose. His descendants held the borough and the manor of Horsham, and through them they passed to the family of Mowbray, afterwards dukes of Norfolk. There are traces of burgage tenure at Horsham in 1210, and it was called a borough in 1236. It has no charter of incorporation. Horsham sent two representatives to parliament from 1295 until 1832, when the number was reduced to one. In 1885 it was disfranchised. In 1233 Henry III. granted William de Braose a yearly three-days' fair at his manor of Horsham. In the reign of Edward I. William de Braose claimed to have a free market on Wednesdays and Saturdays. Fairs are held on the 5th of April, 18th of July, 17th of November and 27th of November. Market days are Monday and Wednesday. "Glovers" of Horsham are mentioned in a patent roll of 1485, and a brewery existed here in the time of Queen Anne.

HORSLEY, JOHN (c. 1685-1733), British archaeologist. John Hodgson (1779-1845), the historian of Northumberland, in a short memoir published in 1831, held that he was born in 1685, at Pinkie House, in the parish of Inveresk, Midlothian, and that his father was a Northumberland Nonconformist, who had migrated to Scotland, but returned to England soon after the Revolution of 1688. J. H. Hinde, in the *Archaeologia Aeliana* (Feb. 1865), held that he was a native of Newcastle-on-Tyne, the son of Charles Horsley, a member of the Tailors' Company of that town. He was educated at Newcastle, and at Edinburgh University, where he graduated M.A. on the 20th of April 1701. There is evidence that he "was settled in Morpeth as a Presbyterian minister as early as 1709." Hodgson, however, thought that up to 1721, at which time he was residing at Widdrington, "he had not received ordination, but preached as a licentiate." Even if he was ordained then, his stay at the latter place was probably prolonged beyond that date; for he communicated to the *Philosophical Transactions* (xxxi. 328) notes on the rainfall there in the years 1722 and 1723. Hinde shows that during these years "he certainly followed a secular employment as agent to the York Buildings Company, who had contracted to purchase and were then in possession of the Widdrington estates." At Morpeth Horsley opened a private school. Respect for his character and abilities attracted pupils irrespective of religious connexion, among them Newton Ogle, afterwards dean of Westminster. He gave lectures on mechanics and hydrostatics in Morpeth, Alnwick and Newcastle, and was elected F.R.S. on the 23rd of April 1730. It is as an archaeologist that Horsley is now known. His great work, *Britannia Romana, or the Roman Antiquities of Britain* (London, 1732), one of the scarcest and most valuable of its class, contains the result of patient labour. There is in the British Museum a copy with notes by John Ward (c. 1679-1758), biographer of the Gresham professors. Horsley died of apoplexy on the 12th of January 1732, on the eve of the publication of the *Britannia Romana*. He also published two sermons and a handbook to his lectures on mechanics, &c., and projected a history of Northumberland and Durham, collections for which were found among his papers.

J. P. Wood (d. 1838) (*Parish of Cramond, 1704, and Anecdotes of Bowyer, 1782, p. 371*) says that his wife was a daughter of William Hamilton, D.D., minister of Cramond, afterwards professor of divinity in Edinburgh University, but probably the John Horsley in question was another, the father of Samuel Horsley (*q.v.*).

HORSLEY, JOHN CALLCOTT (1817-1903), English painter, son of William Horsley, the musician, and grand-nephew of Sir Augustus Callcott, was born in London, on the 29th of January 1817. He studied painting in the Academy schools, and in 1836 exhibited "The Pride of the Village" (Vernon Gallery) at the Royal Academy. This was followed by numerous *genre* pictures at subsequent exhibitions up to 1893, the best known of these being "Malvolio," "L'Allegro and il Penseroso" (painted for the Prince Consort), "Le Jour des Morts," "A Scene from Don Quixote," &c. In 1843 his cartoon of "St Augustine Preaching" won a prize in the Westminster Hall competition, and in 1844 he was selected as one of the six painters commissioned to execute frescoes for the Houses of Parliament, his "Religion" (1845) being put in the House of Lords; he also painted the "Henry V. assuming the Crown" and "Satan surprised at the Ear of Eve." In 1864 he became R.A., and in 1882 was elected treasurer, a post which he held till 1897, when he resigned and became a "retired Academician." Mr Horsley had much to do with organizing the winter exhibitions of "Old Masters" at Burlington House after 1870. When, during the 'eighties, the example of the French Salon began to affect the Academy exhibitors, and paintings of the nude became the fashion, he protested against the innovation, and his attitude caused *Punch* to give him the punning sobriquet of "Mr J. C (lothes) Horsley." He died on the 18th of October 1903. His son, Sir Victor Horsley (b. 1857), became famous as a surgeon and neuropathologist, and a prominent supporter of the cause of experimental research.

and a fragrance, and fruits a size and savour denied to them in their native haunts. It behooves the judicious gardener, then, not to be too slavish in his attempts to imitate natural conditions, and to bear in mind that such attempts sometimes end in failure. The most successful gardening is that which turns to the best account the plastic organization of the plant, and enables it to develop and multiply as perfectly as possible. Experience, coupled with observation and reflection, as well as the more indirect teachings of tradition, are therefore of primary importance to the practical gardener.

We propose here to notice briefly the several parts of a flowering plant, and to point out the rationale of the cultural procedures connected with them (see the references to separate articles at the end of article on BOTANY).

The Root.—The root, though not precluded from access of air, is not directly dependent for its growth on the agency of light. The efficiency of drainage, digging, hoeing and like operations is accounted for by the manner in which they promote aeration of the soil, raise its temperature and remove its stagnant water. Owing to their growth in length at, or rather in the immediate vicinity of, their tips, roots are enabled to traverse long distances by surmounting some obstacles, penetrating others, and insinuating themselves into narrow crevices. As they have no power of absorbing solid materials, their food must be of a liquid or gaseous character. It is taken up from the interstices between the particles of soil exclusively by the finest subdivisions of the fibrils, and in many cases by the extremely delicate thread-like cells which project from them and which are known as root-hairs. The importance of the root-fibres, or "feeding roots" justifies the care which is taken by every good gardener to secure their fullest development, and to prevent as far as possible any injury to them in digging, potting and transplanting, such operations being therefore least prejudicial at seasons when the plant is in a state of comparative rest.

Root-Pruning and Lifting.—In apparent disregard of the general rule just enunciated is the practice of root-pruning fruit trees, when, from the formation of wood being more active than that of fruit, they bear badly. The contrary is more apparent than real, as the operation consists in the removal of the coarser roots, a process which results in the development of a mass of fine feeding roots. Moreover, there is a generally recognised quasi-antagonism between the vegetative and reproductive processes, so that, other things being equal, anything that checks the one helps forward the other.

Watering.—So far as practical gardening is concerned, feeding by the roots after they have been placed in suitable soil is confined principally to the administration of water and, under certain circumstances, of liquid or chemical manure; and no operations demand more judicious management. The amount of water required, and the times when it should be applied, vary greatly according to the kind of plant and the object for which it is grown, the season, the supply of heat and light, and numerous other conditions, the influence of which is to be learnt by experience only. The same may be said with respect to the application of manures. The watering of pot-plants requires especial care. Water should as a rule be used at a temperature not lower than that of the surrounding atmosphere, and preferably after exposure for some time to the air.

Bottom-Heat.—The "optimum" temperature, or that best suited to promote the general activity of roots, and indeed of all vegetable organs, necessarily varies very much with the nature of the plant, and the circumstances in which it is placed, and is ascertained by practical experience. Artificial heat applied to the roots, called by gardeners "bottom-heat," is supplied by fermenting materials such as stable manure, leaves, &c., or by hot-water pipes. In winter the temperature of the soil, out of doors, beyond a certain depth is usually higher than that of the atmosphere, so that the roots are in a warmer and more uniform medium than are the upper parts of the plant. Often the escape of heat from the soil is prevented by "mulching," i.e. by depositing on it a layer of litter, straw, dead leaves and the like.

The Stem and its subdivisions or branches raise to the light and air the leaves and flowers, serve as channels for the passage to them of fluids from the roots, and act as reservoirs for nutritive substances. Their functions in annual, biennial and herbaceous perennial plants cease after the ripening of the seed, whilst in plants of longer duration layer after layer of strong woody tissue is formed, which enables them to bear the strains which the weight of foliage and the exposure to wind entail. The gardener aims usually at producing stout, robust, short-jointed stems, instead of long lanky growths defective in woody tissue. To secure these conditions free exposure to light and air is requisite; but in the case of coppices and woods, or where long straight spars are needed by the forester, plants are allowed to grow thickly so as to ensure development in an upward rather than in a lateral direction. This and like matters will, however, be more fitly considered in dealing hereafter with the buds and their treatment.

Leaves.—The work of the leaves may briefly be stated to consist of the processes of nutrition, respiration and transpiration. Nutrition (assimilation) by the leaves includes the inhalation of air, and the interaction under the influence of light and in the presence of chlorophyll of the carbon dioxide of the air with the water received from the root, to form carbonaceous food. Respiration in plants, as in other organisms, is a process that goes on by night as well as by day and consists in plants in the breaking up of the complex carbonaceous substances formed by assimilation into less complex and more transportable substances. This process, which is as yet imperfectly understood, is attended by the consumption of oxygen, the liberation of energy in the form of heat, and the exhalation of carbon dioxide and water vapour. Transpiration is loss of water by the plant by evaporation, chiefly from the minute pores or stomata on the leaves. In xerophytic plants (e.g. cacti, euphorbias, &c.) from hot, dry and almost waterless regions where evaporation would be excessive, the leaf surface, and consequently the number of stomata, are reduced to a minimum, as it would be fatal to such plants to exhale vapour as freely in those regions as the broad-leaved plants that grow in places where there is abundance of moisture. Although transpiration is a necessary accompaniment of nutrition, it may easily become excessive, especially where the plant cannot readily recoup itself. In these circumstances "syriaging" and "damping down" are of value in cooling the temperature of the air in hothouses and greenhouses and increasing its humidity, thereby checking excessive transpiration. Shading the glass with canvas or washes during the summer months has the same object in view. Syriaging is also beneficial in washing away dirt and insects.

Buds.—The recognition of the various forms of buds and their modes of disposition in different plants is a matter of the first consequence in the operations of pruning and training. Flower-buds are produced either on the old wood, i.e. the shoots of the past year's growth, or on a shoot of the present year. The peach, horse-chestnut, lilac, morello cherry, black currant, rhododendron and many other trees and shrubs develop flower-buds for the next season speedily after blossoming, and these may be stimulated into premature growth. The peculiar short, stunted branches or "spurs" which bear the flower-buds of the pear, apple, plum, sweet cherry, red currant, laburnum, &c., deserve special attention. In the rose, passion-flower, clematis, honeysuckle, &c., in which the flower-buds are developed at the ends of the young shoot of the year, we have examples of plants destitute of flower-buds during the winter.

Propagation by Buds.—The detached leaf-buds (*gemmas* or *bulbils*, of some plants are capable under favourable conditions of forming new plants. The edges of the leaves of *Bryophyllum calycinum* and of *Cardamine pratensis*, and the growths in the axils of the leaves of *Lilium bulbiferum*, as well as the fronds of certain ferns (e.g. *Asplenium bulbiferum*), produce buds of this character. It is a matter of familiar observation that the ends of the shoots of brambles take root when bent down to the ground. In some instances buds form on the roots, and may be used for purposes of propagation, as in the Japan quince, the globe thistle, the sea holly, some sea lavenders, *Bocconia*, *Acanthus*, &c. Of this tendency in buds to assume an independent existence gardeners avail themselves in the operations of striking "cuttings" and making "layers" and "pipings," as also in budding and grafting. In taking a slip or cutting the gardener removes from the parent plant a shoot having one or more buds or "eyes," in the case of the vine one only, and places it in a moist and sufficiently warm situation, where, as previously mentioned, undue evaporation from the surface is prevented. For some cuttings, pots filled with light soil, with the protection of the propagating-house and of bell-glasses, are requisite; but for many of our hardy deciduous trees and shrubs no such precautions are necessary, and the insertion of a short shoot about half its length into moist and gritty ground at the proper season suffices to ensure its growth. In the case of the more delicate plants, the formation of roots is preceded by the production from the cambium of the cuttings of a succulent mass of tissue, the *callus*. It is important in some cases, e.g. zonal pelargoniums, fuchsias, shrubby calceolarias, dahlias, carnations, &c., to retain on the cutting some of its leaves, so as to supply the requisite food for storage in the callus. In other cases, where the buds themselves contain a sufficiency of nutritive matter for the young growths, the retention of leaves is not necessary. The most successful mode of forming roots is to place the cuttings in a mild bottom-heat, which expedites their growth, even in the case of many hardy plants whose cuttings strike roots in the open soil. With some hard-wooded trees, as the common white-thorn, roots cannot be obtained without bottom-heat. It is a general rule throughout plant culture that the activity of the roots shall be in advance of that of the leaves. Cuttings of deciduous trees and shrubs succeed best if planted early in autumn while the soil still retains the solar heat absorbed during summer. For evergreens August or September, and for greenhouse and stove-plants the spring and summer months, are the times most suitable for propagation by cuttings.

Layering consists simply in bending down a branch and keeping it in contact with or buried to a small depth in the soil until roots are formed; the connexion with the parent plant may then be

covered. Many plants can be far more easily propagated thus than by cuttings.

Grafting or "**working**" consists in the transfer of a branch, the "**graft**" or "**scion**," from one plant to another, which latter is termed the "**stock**." The operation must be so performed that the growing tissues, or cambium-layer of the scion, may fit accurately to the corresponding layer of the stock. In **budding**, as with roses and peaches, a single bud only is implanted. **Inarching** is essentially the promotion of the union of a shoot of one plant to that of another of the same or allied species or variety. The outer bark of each being removed, the two shoots are kept in contact by ligature until union is established, when the scion is completely severed from its original attachments. This operation is varied in detail according to the kind of plant to be propagated, but it is essential in all cases that the affinity between the two plants be near, that the union be neatly effected, and that the ratio as well as the season of growth of stock and scion be similar.

The selection of suitable stocks is a matter still requiring much scientific experiment. The object of grafting is to expedite and increase the formation of flowers and fruit. Strong-growing pears, for instance, are grafted on the quince stock in order to restrict their tendency to form "gross" shoots and a superabundance of wood in place of flowers and fruit. Apples, for the same reason, are "worked" on the "paradise" or "doucin" stocks, which from their influence on the scion are known as dwarfing stocks. Scions from a tree which is weakly, or liable to injury by frosts, are strengthened by engrafting on robust stocks. Lindley has pointed out that, while in Persia, its native country, the peach is probably best grafted on the peach, or on its wild type the almond, in England, where the summer temperature of the soil is much lower than that of Persia, it might be expected, as experience has proved, to be most successful on stocks of the native plum.

The soil in which the stock grows is a point demanding attention. From a careful series of experiments made in the Horticultural Society's Garden at Chiswick, it was found that where the soil is loamy, or light and slightly enriched with decayed vegetable matter, the apple succeeds best on the doucin stock, and the pear on the quince; and where it is chalky it is preferable to graft the apple on the crab, and the pear on the wild pear. For the plum on loamy soils the plum, and on chalky and light soils the almond, are the most desirable stocks, and for the cherry on loamy or light rich soils the wild cherry, and on chalk the "mahaleb" stock.

The form and especially the quality of fruit is more or less affected by the stock upon which it is grown. The Stanwick nectarine, so apt to crack and not to ripen when worked in the ordinary way, is said to be cured of these propensities by being first budded close to the ground, on a very strong-growing *Magnum Bonum* plum, worked on a Brussels stock, and by then budding the nectarine on the *Magnum Bonum* about a foot from the ground. The fruit of the pear is of a higher colour and smaller on the quince stock than on the wild pear; still more so on the medlar. On the mountain ash the pear becomes earlier.

The effects produced by stock on scion, and more particularly by scion on stock, are as a rule with difficulty appreciable. Nevertheless, in exceptional cases modified growths, termed "graft-hybrids," have been obtained which have been attributed to the commingling of the characteristics of stock and scion (see **HYBRIDISM**). Of these the most remarkable example is *Cytisus Adamsi*, a tree which year after year produces some shoots, foliage and flowers like those of the common laburnum, others like those of the very different looking dwarf shrub *C. purpureus*, and others again intermediate between these. We may hence infer that *C. purpureus* was grafted or budded on the common laburnum, and that the intermediate forms are the result of graft-hybridization. Numerous similar facts have been recorded. Among gardeners the general opinion is against the possibility of graft-hybridization. The wonder, however, seems to be that it does not occur more frequently, seeing that fluids must pass from stock to scion, and matter elaborated in the leaves of the scion must certainly to some extent enter the stock. It is clear, nevertheless, from examination that as a rule the wood of the stock and the wood of the scion retain their external characters year by year without change. Still, as in the laburnum just mentioned, in the variegated jasmine and in *Abutilon Darwini*, in the copper beech and in the horse-chestnut, the influence of a variegated scion has occasionally shown itself in the production from the stock of variegated shoots. At a meeting of the Scottish Horticultural Association (see *Gard. Chron.*, Jan. 10, 1880, figs. 12-14) specimens of a small roundish pear, the "Aston Town," and of the elongated kind known as "Burré Claireau," were exhibited. Two more dissimilar pears hardly exist. The result of working the Burré Claireau upon the Aston Town was the production of fruits precisely intermediate in size, form, colour, speckling of rind and other characteristics. Similar, though less marked, intermediate characters were obvious in the foliage and flowers.

Double grafting (French, *greffe sur greffe*) is sufficiently explained by its name. By means of it a variety may often be propagated, or its fruit improved in a way not found practicable under ordinary circumstances. For its successful prosecution prolonged experiments in different localities and in gardens devoted to the purpose are requisite.

Planting.—By removal from one place to another the growth of every plant receives a check. How this check can be obviated or reduced, with regard to the season, the state of atmosphere, and the condition and circumstances of the plant generally, is a matter to be considered by the practical gardener.

As to season, it is now admitted with respect to deciduous trees and shrubs that the earlier in autumn planting is performed the better; although some extend it from the period when the leaves fall to the first part of spring, before the sap begins to move. If feasible, the operation should be completed by the end of November, whilst the soil is still warm with the heat absorbed during summer. Attention to this rule is especially important in the case of rare and delicate plants. Early autumn planting enables wounded parts of roots to be healed over, and to form fibrils, which will be ready in spring, when it is most required, to collect food for the plant. Planting late in spring should, as far as possible, be avoided, for the buds then begin to awaken into active life, and the draught upon the roots becomes great. It has been supposed that because the surface of the young leaves is small transpiration is correspondingly feeble; but it must be remembered, not only that their newly-formed tissue is unable without an abundant supply of sap from the roots to resist the excessive drying action of the atmosphere, but that, in spring, the lowness of the temperature at that season in Great Britain prevents the free circulation of the sap. The comparative dryness of the atmosphere in spring also causes a greater amount of transpiration than in autumn and winter. Another fact in favour of autumnal planting is the production of roots in winter.

The best way of performing transplantation depends greatly on the size of the trees, the soil in which they grow, and the mechanical appliances made use of in lifting and transporting them. The smaller the tree the more successfully can it be removed. The more argillaceous and the less siliceous the soil the more readily can balls of earth be retained about the roots. All planters lay great stress on the preservation of the fibrils; the point principally disputed is to what extent they can with safety be allowed to be cut off in transplantation. Trees and shrubs in thick plantations, or in sheltered warm places, are ill fitted for planting in bleak and cold situations. During their removal it is important that the roots be covered, if only to prevent desiccation by the air. Damp days are therefore the best for the operation; the driest months are the most unfavourable. Though success in transplanting depends much on the humidity of the atmosphere, the most important requisite is warmth in the soil; humidity can be supplied artificially, but heat cannot.

Pruning, or the removal of superfluous growths, is practised in order to equalize the development of the different parts of trees, or to promote it in particular directions so as to secure a certain form, and, by checking undue luxuriance, to promote enhanced fertility. In the rose-bush, for instance, in which, as we have seen, the flower-buds are formed on the new wood of the year, pruning causes the old wood to "break," i.e. to put forth a number of new buds, some of which will produce flowers at their extremities. The manner and the time in which pruning should be accomplished, and its extent, vary with the plant, the objects of the operation, i.e. whether for the production of timber or fruit, the season and various other circumstances. So much judgment and experience does the operation call for that it is a truism to say that bad pruning is worse than none. The removal of weakly, sickly, overcrowded and gross infertile shoots is usually, however, a matter about which there can be few mistakes when once the habit of growth and the form and arrangement of the buds are known. Winter pruning is effected when the tree is comparatively at rest, and is therefore less liable to "bleeding" or outpouring of sap. Summer pruning or pinching off the tips of such of the younger shoots as are not required for the extension of the tree, when not carried to too great an extent, is preferable to the coarser more reckless style of pruning. The injury inflicted is less and not so concentrated; the wounds are smaller, and have time to heal before winter sets in. The effects of badly-executed pruning, or rather hacking, are most noticeable in the case of forest trees, the mutilation of which often results in rotting, canker and other diseases. Judicious and timely thinning so as to allow the trees room to grow, and to give them sufficiency of light and air, will generally obviate the need of the pruning-saw, except to a relatively small extent.

Training is a procedure adopted when it is required to grow plants in a limited area, or in a particular shape, as in the case of many plants of trailing habit. Judicious training also may be of importance as encouraging the formation of flowers and fruit. Growth in length is mainly in a vertical direction, or at least at the ends of the shoots; and this should be encouraged, in the case of a timber tree, or of a climbing plant which it is desired should cover a wall quickly; but where flowers or fruit are specially desired, then, when the wood required is formed, the lateral shoots may often be trained more or less downward to induce fertility. The refinements of training, as of pruning, may, however, be carried too far; and not unfrequently the symmetrically trained trees of the French excite admiration in every respect save fertility.

Sports or Bud Variations.—Here we may conveniently mention certain variations from the normal condition in the size, form or

disposition of buds or shoots on a given plant. An inferior variety of pear, for instance, may suddenly produce a shoot bearing fruit of superior quality; a beech tree, without obvious cause, a shoot with finely divided foliage; or a camellia an unwontedly fine flower. When removed from the plant and treated as cuttings or grafts, such sports may be perpetuated. Many garden varieties of flowers and fruits have thus originated. The cause of their production is very obscure.

Formation of Flowers.—Flowers, whether for their own sake or as the necessary precursors of the fruit and seed, are objects of the greatest concern to the gardener. As a rule they are not formed until the plant has arrived at a certain degree of vigour, or until a sufficient supply of nourishment has been stored in the tissues of the plant. The reproductive process of which the formation of the flower is the first stage being an exhaustive one, it is necessary that the plant, as gardeners say, should get "established" before it flowers. Moreover, although the green portions of the flower do indeed perform the same office as the leaves, the more highly coloured and more specialized portions, which are further removed from the typical leaf-form, do not carry on those processes for which the presence of chlorophyll is essential; and the floral organs may, therefore, in a rough sense, be said to be parasitic upon the green parts. A check or arrest of growth in the vegetative organs seems to be a necessary preliminary to the development of the flower.

A diminished supply of water at the root is requisite, so as to check energy of growth, or rather to divert it from leaf-making. Partial starvation will sometimes effect this; hence the grafting of free-growing fruit trees upon dwarfing stocks, as before alluded to, and also the "ringing" or girdling of fruit trees, *i.e.* the removal from the branch of a ring of bark, or the application of a tight cincture, in consequence of which the growth of the fruits above the wound or the obstruction is enhanced. On the same principle the use of small pots to confine the roots, root-pruning and lifting the roots, and exposing them to the sun, as is done in the case of the vine in some countries, are resorted to. A higher temperature, especially with deficiency of moisture, will tend to throw a plant into a flowering condition. This is exemplified by the fact that the temperature of the climate of Great Britain is too low for the flowering, though sufficiently high for the growth of many plants. Thus the Jerusalem artichoke, though able to produce stems and tubers abundantly, only flowers in exceptionally hot seasons.

Forcing.—The operation of forcing is based upon the facts just mentioned. By subjecting a plant to a gradually increasing temperature, and supplying water in proportion, its growth may be accelerated; its season of development may be, as it were, anticipated; it is roused from a dormant to an active state. Forcing therefore demands the most careful adjustment of temperature and supplies of moisture and light.

Deficiency of light is less injurious than might at first be expected, because the plant to be forced has stored up in its tissues, and available for use, a reserve stock of material formed through the agency of light in former seasons. The intensity of the colour of flowers and the richness of flavour of fruit are, however, deficient where there is feebleness of light. Recent experiments show that the influence of electric light on chlorophyll is similar to that of sunlight, and that deficiencies of natural light may to some extent be made good by its use. The employment of that light for forcing purposes would seem to be in part a question of expense. The advantage hitherto obtained from its use has consisted in the rapidity with which flowers have been formed and fruits ripened under its influence, circumstances which go towards compensating for the extra cost of production.

Retardation.—The art of retarding the period of flowering in certain plants consists, in principle, in the artificial application of cold temperatures whereby the resting condition induced by low winter temperature is prolonged. For commercial purposes, crowns of lily of the valley, tulip and other bulbs, and such deciduous woody plants as lilac and deciduous species of rhododendron, while in a state of rest, are packed in wet moss and introduced into cold-storage chambers, where they may be kept in a state of quiescence, if desired, throughout the following summer. The temperature of the cold chamber is varied from the freezing-point of water, to a few degrees lower, according to the needs of the plants under treatment. When required for use they are removed to cool sheds to thaw, and are then gradually inured to higher temperatures. The chief advantages of retarded plants are:—(a) they may be flowered almost at will; (b) they are readily induced to flower at those times when unretarded plants refuse to respond to forcing. Cold-storage chambers form a part of the equipment of most of the leading establishments where flowers are grown for market.

Double Flowers.—The taste of the day, demands that "double flowers" should be largely grown. Though in many instances, as in hyacinths, they are less beautiful than single ones, they always present the advantage of being less evanescent. Under the vague term "double" many very different morphological changes are included. The flower of a double dahlia, *e.g.* offers a totally different condition of structure from that of a rose or a hyacinth. The double poinsettia, again, owes its so-called double condition merely to the increased number of its scarlet involucre leaves, which are not parts of the flower at all. It is reasonable, therefore, to infer that

the causes leading to the production of double flowers are varied. A good deal of difference of opinion exists as to whether they are the result of arrested growth or of exuberant development, and accordingly whether restricted food or abundant supplies of nourishment are the more necessary for their production. It must suffice here to say that double flowers are most commonly the result of the substitution of brightly-coloured petals for stamens or pistils or both, and that a perfectly double flower where all the stamens and pistils are thus metamorphosed is necessarily barren. Such a plant must needs be propagated by cuttings. It rarely happens, however, that the change is quite complete throughout the flower, and so a few seeds may be formed, some of which may be expected to reproduce the double-blossomed plants. By continuous selection of seed from the best varieties, and "roguing" or eliminating plants of the ordinary type, a "strain" or race of double flowers is gradually produced.

Formation of Seed—Fertilization.—In fertilization—the influence in flowering plants of the male-cell in the pollen tube upon the egg-cell in the ovule (see BOTANY)—there are many circumstances of importance horticulturally, to which, therefore, brief reference must be made. Flowers, generally speaking, are either self-fertilized, cross-fertilized or hybridized. Self-fertilization occurs when the pollen of a given flower affects the egg-cell of the same individual flower. Cross-fertilization varies both in manner and degree. In the simplest instances the pollen of one flower fertilizes the ovules of another on the same plant, owing to the stamens arriving at maturity in any one flower earlier or later than the pistils.

Cross-fertilization must of necessity occur when the flowers are structurally unisexual, as in the hazel, in which the male and female flowers are monoecious, or separate on the same plant, and in the willow, in which they are dioecious, or on different plants. A conspicuous example of a dioecious plant is the common aucuba, of which for years only the female plant was known in Britain. When, through the introduction of the male plant from Japan, its fertilization was rendered possible, ripe berries, before unknown, became common ornaments of the shrub.

The conveyance of pollen from one flower to another in cross-fertilization is effected naturally by the wind, or by the agency of insects and other creatures. Flowers that require the aid of insects usually offer some attraction to their visitors in the shape of bright colour, fragrance or sweet juices. The colour and markings of a flower often serve to guide the insects to the honey, in the obtaining of which they are compelled either to remove or to deposit pollen. The reciprocal adaptations of insects and flowers demand attentive observation on the part of the gardener concerned with the growing of grapes, cucumbers, melons and strawberries, or with the raising of new and improved varieties of plants. In wind-fertilized plants the flowers are comparatively inconspicuous and devoid of much attraction for insects; and their pollen is smoother and smaller, and better adapted for transport by the wind, than that of insect-fertilized plants, the roughness of which adapts it for attachment to the bodies of insects.

It is very probable that the same flower at certain times and seasons is self-fertilizing, and at others not so. The defects which cause gardeners to speak of certain vines as "shy setters," and of certain strawberries as "blind," may be due either to unsuitable conditions of external temperature, or to the non-accomplishment, from some cause or other, of cross-fertilization. In a viney, tomato-house or a peach-house it is often good practice at the time of flowering to tap the branches smartly with a stick so as to ensure the dispersal of the pollen. Sometimes more delicate and direct manipulation is required, and the gardener has himself to convey the pollen from one flower to another, for which purpose a small camel's-hair pencil is generally suitable. The degree of fertility varies greatly according to external conditions, the structural and functional arrangements just alluded to, and other causes which may roughly be called constitutional. Thus, it often happens that an apparently very slight change in climate alters the degree of fertility. In a particular country or at certain seasons one flower will be self-sterile or nearly so, and another just the opposite.

Hybridization.—Some of the most interesting results, and many of the gardener's greatest triumphs have been obtained by hybridization, *i.e.* the crossing of two individuals not of the same but of two distinct species of plants, as, for instance, two species of rhododendron or two species of orchid (see HYBRIDISM). It is obvious that hybridization differs more in degree than in kind from cross-fertilization. The occurrence of hybrids in nature explains the difficulty experienced by botanists in deciding on what is a species, and the widely different limitations of the term adopted by different observers in the case of willows, roses, brambles, &c. The artificial process is practically the same in hybridization as in cross-fertilization, but usually requires more care. To prevent self-fertilization, or the access of insects, it is advisable to remove the stamens and even the corolla from the flower to be impregnated, as its own pollen or that of a flower of the same species is often found to be "prepotent." There are, however, cases, *e.g.* some passion-flowers and rhododendrons, in which a flower is more or less sterile with its own, but fertile with foreign pollen, even when this is from a distinct species. It is a singular circumstance that reciprocal crosses are not always or even often possible; thus, one rhododendron may

afford pollen perfectly potent on the stigma of another kind, by the pollen of which latter its own stigma is unaffected.

The object of the hybridizer is to obtain varieties exhibiting improvements in hardiness, vigour, size, shape, colour, fruitfulness, resistance to disease or other attributes. His success depends not alone on skill and judgment, for some seasons, or days even, are found more propitious than others. Although promiscuous and haphazard procedures no doubt meet with a measure of success, the best results are those which are attained by systematic work with a definite aim.

Hybrids are sometimes less fertile than pure-bred species, and are occasionally quite sterile. Some hybrids, however, are as fertile as pure-bred plants. Hybrid plants may be again crossed, or even re-hybridized, so as to produce a progeny of very mixed parentage. This is the case with many of our roses, dahlias, begonias, pelargoniums, orchids and other long or widely cultivated garden plants.

Reversion.—In modified forms of plants there is frequently a tendency to "sport" or revert to parental or ancestral characteristics. So markedly is this the case with hybrids that in a few generations all traces of a hybrid origin may disappear. The dissociation of the hybrid element in a plant must be obviated by careful selection. The researches of Gregor Johann Mendel (1822-1884), abbot of the Augustinian monastery at Brunn, in connexion with peas and other plants, apparently indicate that there is a definite natural law at work in the production of hybrids. Having crossed yellow and green seeded peas both ways, he found that the progeny resulted in all yellow coloured seeds. These gave rise in due course to a second generation in which there were three yellows to one green. In the third generation the yellows from the second generation gave the proportion of one pure yellow, two impure yellows, and one green; while the green seed of the second generation threw only green seeds in the third, fourth and fifth generations. The pure yellow in the third generation also threw pure yellows in the fourth and fifth and succeeding generations. The impure yellows, however, in the next generation gave rise to one pure yellow, one pure green, to two impure yellows, and so on from generation to generation. Accordingly as the green or the yellow predominated in the progeny it was termed "dominant," while the colour that disappeared was called "recessive." It happened, however, that a recessive colour in one generation becomes the dominant in a succeeding one.

Germination.—The length of the period during which seeds remain dormant after their formation is very variable. The conditions for germination are much the same as for growth in general. Access to light is not required, because the seed contains a sufficiency of stored-up food. The temperature necessary varies according to the nature and source of the seed. Some seeds require prolonged immersion in water to soften their shells; others are of so delicate a texture that they would dry up and perish if not kept constantly in a moist atmosphere. Seeds buried too deeply receive a deficient supply of air. As a rule, seeds require to be sown more deeply in proportion to their size and the lightness of the soil.

The time required for germination in the most favourable circumstances varies very greatly, even in the same species, and in seeds taken from one pod. Thus the seeds of *Primula japonica*, though sown under precisely similar conditions, yet come up at very irregular intervals of time. Germination is often slower where there is a store of available food in the perisperm, or in the endosperm, or in the embryo itself, than where this is scanty or wanting. In the latter case the seedling has early to shift for itself, and to form roots and leaves for the supply of its needs.

Selection.—Supposing seedlings to have been developed, it is found that a large number of them present considerable variations, some being especially robust, others peculiar in size or form. Those most suitable for the purpose of the gardener are carefully selected for propagation, while others not so desirable are destroyed; and thus after a few generations a fixed variety, race or strain superior to the original form is obtained. Many garden plants have originated solely by selection; and much has been done to improve our breeds of vegetables, flowers and fruit by systematic selection.

Large and well-formed seeds are to be preferred for harvesting. The seeds should be kept in sacks or bags in a dry place, and if from plants which are rare, or liable to lose their vitality, they are advantageously packed for transmission to a distance in hermetically sealed bottles or jars filled with earth or moss, without the addition of moisture.

It will have been gathered from what has been said that seeds cannot always be depended on to reproduce exactly the characteristics of the plant which yielded them; for instance, seeds of the greengage plum or of the Ribston pippin will produce a plum or an apple, but not these particular varieties, to perpetuate which grafts or buds must be employed. (M. T. M.; W. R. W.)

PART II.—THE PRACTICE OF HORTICULTURE

The details of horticultural practice naturally range under the three heads of flowers, fruits and vegetables (see also FRUIT AND FLOWER FARMING). There are, however, certain general

aspects of the subject which will be more conveniently noticed apart, since they apply alike to each department. We shall therefore first treat of these under four headings: formation and preparation of the garden, garden structures and edifices, garden materials and appliances, and garden operations.

I. Formation and Preparation of the Garden.

Site.—The site chosen for the mansion will more or less determine that of the garden, the pleasure grounds and flower garden being placed so as to surround or lie contiguous to it, while the fruit and vegetable gardens, either together or separate, should be placed on one side or in the rear, according to fitness as regards the nature of the soil and subsoil, the slope of the surface or the general features of the park scenery. In the case of villa gardens there is usually little choice: the land to be occupied is cut up into plots, usually rectangular, and of greater or less breadth, and in laying out these plots there is generally a smaller space left in the front of the villa residence and a larger one behind, the front plot being usually devoted to approaches, shrubbery and plantations, flower beds being added if space permits, while the back or more private plot has a piece of lawn grass with flower beds next the house, and a space for vegetables and fruit trees at the far end, this latter being shut off from the lawn by an intervening screen of evergreens or other plants. Between these two classes of gardens there are many gradations, but our remarks will chiefly apply to those of larger extent.

The almost universal practice is to have the fruit and vegetable gardens combined; and the flower garden may sometimes be conveniently placed in juxtaposition with them. When the fruit and vegetable gardens are combined, the smaller and choicer fruit trees only should be admitted, such larger-growing hardy fruits as apples, pears, plums, cherries, &c., being relegated to the orchard.

Ground possessing a gentle inclination towards the south is desirable for a garden. On such a slope effectual draining is easily accomplished, and the greatest possible benefit is derived from the sun's rays. It is well also to have an open exposure towards the east and west, so that the garden may enjoy the full benefit of the morning and evening sun, especially the latter; but shelter is desirable on the north and north-east, or in any direction in which the particular locality may happen to be exposed. In some places the south-western gales are so severe that a belt of trees is useful as a break wind and shelter.

Soil and Subsoil.—A hazel-coloured loam, moderately light in texture, is well adapted for most garden crops, whether of fruits or vegetables, especially a good warm deep loam resting upon chalk; and if such a soil occurs naturally in the selected site, but little will be required in the way of preparation. If the soil is not moderately good and of fair depth, it is not so favourable for gardening purposes. Wherever the soil is not quite suitable, but is capable of being made so, it is best to remedy the defect at the outset by trenching it all over to a depth of 2 or 3 ft., incorporating plenty of manure with it. A heavy soil, although at first requiring more labour, generally gives far better results when worked than a light soil. The latter is not sufficiently retentive of moisture and gets too hot in summer and requires large quantities of organic manures to keep it in good condition. It is advantageous to possess a variety of soils; and if the garden be on a slope it will often be practicable to render the upper part light and dry, while the lower remains of a heavier and damper nature.

Natural soils consist of substances derived from the decomposition of various kinds of rocks, the bulk consisting of clay, silica and lime, in various proportions. As regards preparation, draining is of course of the utmost importance. The ground should also be trenched to the depth of 3 ft. at least, and the deeper the better so as to bring up the subsoil—whether it be clay, sand, gravel, marl, &c.—for exposure to the weather and thus convert it from a sterile mass into a living soil teeming with bacteria. In this operation all stones larger than a man's fist must be taken out, and all roots of trees and of

perennial weeds carefully cleared away. When the whole ground has been thus treated, a moderate liming will, in general, be useful, especially on heavy clay soils. After this, supposing the work to have occupied most of the summer, the whole may be laid up in ridges, to expose as great a surface as possible to the action of the winter's frost.

Argillaceous or clay soils are those which contain a large percentage (45-50) of clay, and a small percentage (5 or less) of lime. These are unfitted for garden purposes until improved by draining, liming, trenching and the addition of porous materials, such as ashes, burnt ballast or sand, but when thoroughly improved they are very fertile and less liable to become exhausted than most other soils. Loamy soils contain a considerable quantity (30-45%) of clay, and smaller quantities of lime, humus and sand. Such soils properly drained and prepared are very suitable for orchards, and when the proportion of clay is smaller (20-30%) they form excellent garden soils, in which the better sort of fruit trees luxuriate. Marly soils are those which contain a considerable percentage (10-20) of lime, and are called clay marls, loamy marls and sandy marls, according as these several ingredients preponderate. The clay marls are, like clay soils, too stiff for garden purposes until well worked and heavily manured; but loamy marls are fertile and well suited to fruit trees, and sandy marls are adapted for producing early crops. Calcareous soils, which may also be heavy, intermediate or light, are those which contain more than 20% of lime, their fertility depending on the proportions of clay and sand which enter into their composition; they are generally cold and wet. Vegetable soils or moulds, or humus soils, contain a considerable percentage (more than 5) of humus, and embrace both the rich productive garden moulds and those known as peaty soils.

The nature of the subsoil is of scarcely less importance than that of the surface soil. Many gardeners are still afraid to disturb an unsuitable subsoil, but experienced growers have proved that by bringing it up to the surface and placing plenty of manure in the bottoms of the various trenches, the very best results are attained in the course of a season or so. An uneven subsoil, especially if retentive, is most undesirable, as water is apt to collect in the hollows, and thus affect the upper soil. The remedy is to make the plane of its surface agree with that of the ground. When there is a hard pan this should be broken up with the spade or the fork, and have plenty of manure mixed with it. When there is an injurious preponderance of metallic oxides or other deleterious substances, the roots of trees would be affected by them, and they must therefore be removed. When the subsoil is too compact to be pervious to water, effectual drainage must be resorted to; when it is very loose, so that it drains away the fertile ingredients of the soil as well as those which are artificially supplied, the compactness of the stratum should be increased by the addition of clay, marl or loam. The best of all subsoils is a dry bed of clay overlying sandstone.

Plan.—In laying out the garden, the plan should be prepared in minute detail before commencing operations. The form of the kitchen and fruit garden should be square or oblong, rather than curvilinear, since the working and cropping of the ground can thus be more easily carried out. The whole should be compactly arranged, so as to facilitate working, and to afford convenient access for the carting of the heavy materials. This access is especially desirable as regards the store-yards and framing ground, where fermenting manures and tree leaves for making up hot beds, coals or wood for fuel and ingredients for composts, together with flower-pots and the many necessities of garden culture, have to be accommodated. In the case of villas or picturesque residences, gardens of irregular form may be permitted; when adapted to the conditions of the locality, they associate better with surrounding objects, but in such gardens wall space is usually limited.

The distribution of paths must be governed by circumstances. Generally speaking, the main paths for cartage should be 8 ft. wide, made up of 9 in. hard core covered by 4 in. of gravel or ash, with a gentle rise to centre to throw off surface water. The smaller paths, not intended for cartage, should be 4 ft. to 6 ft. wide, according to circumstances, made up of 6 in. hard core and 3 in. of gravel or ash, and should be slightly raised at centre.

A considerable portion of the north wall is usually covered

in front with the glazed structures called forcing-houses, and to these the houses for ornamental plants are sometimes attached; but a more appropriate site for the latter is the flower garden, when that forms a separate department. It is well, however, that everything connected with the forcing of fruits or flowers should be concentrated in one place. The frame ground, including melon and pine pits, should occupy some well-sheltered spot in the slips; or on one side of the garden, and adjoining to this may be found a suitable site for the compost ground, in which the various kinds of soils are kept in store, and in which also composts may be prepared.

As walls afford valuable space for the growth of the choicer kinds of hardy fruits, the direction in which they are built is of considerable importance. In the warmer parts of the country the wall on the north side of the garden should be so placed as to face the sun at about an hour before noon, or a little to the east of south; in less favoured localities it should be made to face direct south, and in still more unfavourable districts it should face the sun an hour after noon, or a little west of south. The east and west walls should run parallel to each other, and at right angles to that on the north side, in all the most favoured localities; but in colder or later ones, though parallel, they should be so far removed from a right angle as to get the sun by eleven o'clock. On the whole, the form of a parallelogram with its longest sides in the proportion of about five to three of the shorter, and running east and west, may be considered the best form, since it affords a greater extent of south wall than any other.

Fig. 1 represents a garden of one acre and admits of nearly double the number of trees on the south aspect as compared with the east and west; it allows a greater number of espalier or pyramid trees to face the south; and it admits of being divided into equal principal

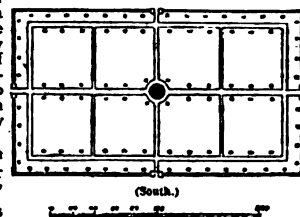

compartments, each of which forms nearly a square. The size of course can be increased to any requisite extent. That of the royal gardens at Frogmore, 760 ft. from east to west and 440 ft. from north to south, is nearly of the same proportions. The spaces between the walls and the outer fence are called "slips." A considerable extent is sometimes thus enclosed, and utilized for the growth of such vegetables as potatoes, winter greens and sea-kale, for the small bush fruits, and for strawberries. The slips are also convenient as affording a variety of aspects, and thus helping to prolong the season of particular vegetable crops.

Shelter.—A screen of some kind to temper the fury of the blast is absolutely necessary. If the situation is not naturally well sheltered, the defect may be remedied by masses of forest trees disposed at a considerable distance so as not to shade the walls or fruit trees. They should not be nearer than, say, 50 yds., and may vary from that to 100 or 150 yds. distance according to circumstances, regard being had especially to peculiarities occasioned by the configuration of the country, as for instance to aerial currents from adjacent eminences. Care should be taken, however, not to hem in the garden by crowded plantations, shelter from the prevailing strong winds being all that is required, while the more open it is in other directions the better. The trees employed for screens should include both those of deciduous and of evergreen habit, and should suit the peculiarities of local soil and climate. Of deciduous trees the sycamore, wych-elm, horse-chestnut, beech, lime, plane and poplar may be used,—the abele or white poplar, *Populus alba*, being one of the most rapid-growing of all trees, and, like other poplars, well suited for nursing other choicer subjects; while of evergreens, the holm oak, holly, laurel (both common and Portugal), and such conifers as the Scotch, Weymouth and Austrian pines, with spruce and

silver firs and yews, are suitable. The conifers make the most effective screens.

Extensive gardens in exposed situations are often divided into compartments by hedges, so disposed as to break the force of high winds. Where these are required to be narrow as well as lofty, holly, yew or beech is to be preferred; but, if there is sufficient space, the beautiful laurel and the bay may be employed where they will thrive. Smaller hedges may be formed of evergreen privet or of tree-box. These subordinate divisions furnish, not only shelter but also shade, which, at certain seasons, is peculiarly valuable.

Belts of shrubbery may be placed round the slips outside the walls; and these may in many cases, or in certain parts, be of sufficient breadth to furnish pleasant retired promenades, at the same time that they serve to mask the formality of the walled gardens, and are made to harmonize with the picturesque scenery of the pleasure ground.

Water Supply.—Although water is one of the most important elements in plant life, we do not find one garden in twenty where even ordinary precautions have been taken to secure a competent supply. Rain-water is the best, next to that river or pond water, and last of all that from springs; but a chemical analysis should be made of the last before introducing it, as some spring waters contain mineral ingredients injurious to vegetation. Iron pipes are the best conductors; they should lead to a capacious open reservoir placed outside the garden, and at the highest convenient level, in order to secure sufficient pressure for effective distribution, and so that the wall trees also may be effectually washed. Stand-pipes should be placed at intervals between the walks and in other convenient places, from which water may at all times be drawn; and to which a garden hose can be attached, so as to permit of the whole garden being readily watered. The mains should be placed under the walks for safety, and also that they may be easily reached when repairs are required. Pipes should also be laid having a connexion with all the various greenhouses and forcing-houses, each of which should be provided with a cistern for aerating the daily supplies. In fact, every part of the garden, including the working sheds and offices, should have water supplied without stint.

Fence.—Gardens of large extent should be encircled by an outer boundary, which is often formed by a sunk wall or ha-ha surrounded by an invisible wire fence to exclude ground game, or consists of a hedge with low wire fence on its inner side. Occasionally this sunk wall is placed on the exterior of the screen plantations, and walks lead through the trees, so that views are obtained of the adjacent country. Although the interior garden receives its form from the walls, the ring fence and plantations may be adapted to the shape and surface of the ground. In smaller country gardens the enclosure or outer fence is often a hedge, and there is possibly no space enclosed by walls, but some divisional wall having a suitable aspect is utilized for the growth of peaches, apricots, &c., and the hedge merely separates the garden from a paddock used for grazing. The still smaller gardens of villas are generally bounded by a wall or wood fence, the inner side of which is appropriated to fruit trees. For the latter walls are much more convenient and suitable than a boarded fence, but in general these are too low to be of much value as aids to cultivation, and they are best covered with bush fruits or with ornamental plants of limited growth.

Walks.—The best material for the construction of garden walks is good binding gravel. The ground should be excavated to the depth of a foot or more—the bottom being made firm and slightly concave, so that it may slope to the centre, where a drain should be introduced; or the bottom may be made convex and the water allowed to drain away at the sides. The bottom 9 in. should be filled in compactly with hard, coarse materials, such as stones, brickbats, clinkers, burned clay, &c., on which should be laid 2 or 3 in. of coarse gravel, and then 1 or 2 in. of firm binding gravel on the surface. The surface of the walks should be kept well rolled, for nothing contributes more to their elegance and durability.

All the principal lines of walk should be broad enough to allow

at least three persons to walk abreast; the others may be narrower, but a multitude of narrow walks has a puny effect. Much of the neatness of walks depends upon the material of which they are made. Gravel from an inland pit is to be preferred; though occasionally very excellent varieties are found upon the sea-coast. Gravel walks must be kept free from weeds, either by hand weeding, or by the use of one of the many weed killers now on the market. In some parts of the country the available material does not bind to form a close, even surface, and such walks are kept clean by hoeing.

Grass walks were common in English gardens during the prevalence of the Dutch taste, but, owing to the frequent humidity of the climate, they have in a great measure been discarded. Grass walks are made in the same way as grass lawns. When the space to be thus occupied is prepared, a thin layer of sand or poor earth is laid upon the surface and over this a similar layer of good soil. This arrangement is adopted in order to prevent excessive luxuriance in the grass. In many modern gardens pathways made of old paving stones lead from the house to different parts. They give an old-fashioned and restful appearance to a garden, and in the interstices charming little plants like thyme, *Ionopodium acule*, &c., are allowed to grow.

Edgings.—Walks are separated from the adjoining beds and borders in a variety of ways. If a living edging is adopted, by far the best is afforded by the dwarf box planted closely in line. It is of extremely neat growth, and when annually clipped will remain in good order for many years. Very good edgings, but of a less durable character, are formed by thrift (*Armeria vulgaris*), double daisy (*Bellis perennis*), gentianella (*Gentiana acaulis*) and London pride (*Saxifraga umbrosa*), *Cerastium tomentosum*, *Stachys laeata* and the beautiful evergreen *Veronica rupestris* with sheets of bright blue flowers close to the ground, or by some of the finer grasses very carefully selected, such as the sheep's fescue (*Festuca ovina*) or its glaucous-leaved variety. Indeed, any low-growing herbaceous plant, susceptible of minute division, is suitable for an edging. Amongst shrubby plants suitable for edgings are the evergreen candytuft (*Iberis sempervirens*), *Euonymus radicans variegata*, ivy, and *Euonymus microphyllus*—a charming little evergreen with small serrated leaves. Edgings may also be formed of narrow slips of sandstone flag, slate, tiles or bricks. One advantage of using edgings of this kind, especially in kitchen gardens, is that they do not harbour slugs and similar vermin, which all live edgings do, and often to a serious extent, if they are left to grow large. In shrubberies and large flower-plots, verges of grass-turf, from 1 to 3 ft. in breadth, according to the size of the border and width of the walk, make a very handsome edging, but they should not be allowed to rise more than an inch and a half above the gravel, the grass being kept short by repeated mowings, and the edges kept trim and well-defined by frequently clipping with shears and cutting once or twice a year with an edging iron.

II. Garden Structures.

Walls.—The position to be given to the garden walls has been already referred to. The shelter afforded by a wall, and the increased temperature secured by its presence, are indispensable in the climate of Great Britain, for the production of all the finer kinds of outdoor fruits; and hence the inner side of a north wall, having a southern aspect, is appropriated to the more tender kinds. It is, indeed, estimated that such positions enjoy an increased temperature equal to 7° of latitude—that is to say, the mean temperature within a few inches of the wall is equal to the mean temperature of the open plain 7° farther south. The eastern and western aspects are set apart for fruits of a somewhat harder character.

Where the inclination of the ground is considerable, and the presence of high walls would be objectionable, the latter may be replaced by sunk walls. These should not rise more than 3 ft. above the level of the ground behind them. As dryness is favourable to an increase of heat, such walls should be either built hollow or packed behind to the thickness of 3 or 4 ft.

with rubble stones, flints, brickbats or similar material, thoroughly drained at bottom. For mere purposes of shelter a height of 6 or 7 ft. will generally be sufficient for the walls of a garden, but for the training of fruit trees it is found that an average height of 12 ft. is more suitable. In gardens of large size the northern or principal wall may be 14 ft., and the side walls 12 ft. in height; while smaller areas of an acre or so should have the principal walls 12 and the side walls 10 ft. in height. As brick is more easily built hollow than stone, it is to be preferred for garden walls. A 14-in. hollow wall will take in its construction 12,800 bricks, while a solid 9-in. one, with piers, will take 11,000; but the hollow wall, while thus only a little more costly, will be greatly superior, being drier and warmer, as well as more substantial. Bricks cannot be too well burnt for garden walls; the harder they are the less moisture will they absorb. Many excellent walls are built of stone. The best is dark-coloured whinstone, because it absorbs very little moisture, or in Scotland Caithness pavement 4 in. thick. The stones can be cut (in the quarries) to any required length, and built in regular courses. Stone walls should always be built with thin courses for convenience of training over their surface. Concrete walls, properly coped and provided with a trellis, may in some places be cheapest, and they are very durable. Common rubble walls are the worst of all.

The coping of garden walls is important, both for the preservation of the walls and for throwing the rain-water off their surfaces. It should not project less than from 2 to 2½ in., but in wet districts may be extended to 6 in. Stone copings are best, but they are costly, and Portland cement is sometimes substituted. Temporary copings of wood, which may be fixed by means of permanent iron brackets just below the stone coping, are extremely useful in spring for the protection of the blossoms of fruit trees. They should be 9 in. or 1 ft. wide, and should be put on during spring before the blossom buds begin to expand; they should have attached to them scrim cloth (a sort of thin canvas), which admits light pretty freely, yet is sufficient to ward off ordinary frosts; this canvas is to be let down towards evening and drawn up again in the morning. These copings should be removed when they are of no further utility as protectors, so that the foliage may have the full benefit of rain and dew. Any contrivance that serves to interrupt radiation, though it may not keep the temperature much above freezing, will be found sufficient. Standard fruit trees must be left to take their chance; and, indeed from the lateness of their flowering, they are generally more injured by blight, and by drenching rains, which wash away the pollen of the flowers, than by the direct effects of cold.

Espalier Rails.—Subsidiary to walls as a means of training fruit trees, espalier rails were formerly much employed, and are still used in many gardens. In their simplest form, they are merely a row of slender stakes of larch or other wood driven into the ground, and connected by a slight rod or fillet at top. The use of iron rails has now been almost wholly discontinued on account of metallic substances acting as powerful conductors of both heat and cold in equal extremes. Standards from which galvanized wire is tightly strained from one end to the other are preferable and very convenient. Trees trained to them are easily got at for all cultural operations, space is saved, and the fruit, while freely exposed to sun and air, is tolerably secure against wind. They form, moreover, neat enclosures for the vegetable quarters, and, provided excess of growth from the centre is successfully grappled with, they are productive in soils and situations which are suitable.

Plant Houses.—These include all those structures which are more intimately associated with the growth of ornamental plants and flowers, and comprise conservatory, plant stove, greenhouse and the subsidiary pits and frames. They should be so erected as to present the smallest extent of opaque surface consistent with stability. With this object in view, the early improvers of hot-house architecture substituted metal for wood in the construction of the roofs, and for the most part dispensed with back walls; but the conducting power of the metal caused a great irregularity of temperature, which it was found difficult

to control; and, notwithstanding the elegance of metallic houses, this circumstance, together with their greater cost, has induced most recent authorities to give the preference to wood. The combination of the two, however, shows clearly that, without much variation of heat or loss of light, any extent of space may be covered, and houses of any altitude constructed.

The earliest notice we have of such structures is given in the Latin writers of the 1st century (Mart. *Epigr.* viii. 14 and 68); the *Ἀδωκτοὶ κήποι*, to which allusion is made by various Greek authors, have no claim to be mentioned in this connexion. Columella (xi. 3, 51, 52) and Pliny (*H.N.* xix. 23) both refer to their use in Italy for the cultivation of the rarer and more delicate sorts of plants and trees. Seneca has given us a description of the application of hot water for securing the necessary temperature. The botanist Jungermann had plant houses at Altdorf in Switzerland; those of Loader, a London merchant, and the conservatory in the Apothecaries' Botanic Garden at Chelsea, were among the first structures of the kind erected in British gardens. These were, however, ill adapted for the growth of plants, as they consisted of little else than a huge chamber of masonry, having large windows in front, with the roof invariably opaque. The next step was taken when it became fashionable to have conservatories attached to mansions, instead of having them in the pleasure grounds. This arrangement brought them within the province of architects, and for nearly a century utility and fitness for the cultivation of plants were sacrificed, as still is often the case, to the unity of architectural expression between the conservatory and the mansion.

Plant houses must be as far as possible impervious to wet and cold air from the exterior, provision at the same time being

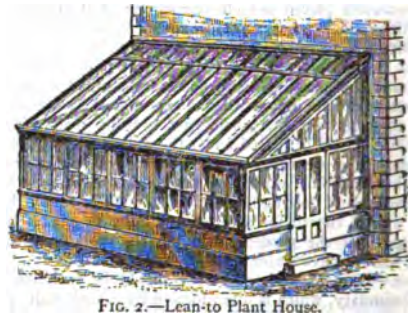

FIG. 2.—Lean-to Plant House.

made for ventilation, while the escape of warm air from the interior must also be under control. The most important part of the enclosing material is necessarily glass. But as the rays of light, even in passing through transparent glass, lose much of their energy, which is further weakened in proportion to the distance it has to travel, the nearer the plant can be placed to the glass the more perfectly will its functions be performed; hence the importance of constructing the roofs at such an angle as will admit the most light, especially sunlight, at the time it is most required. Plants in glass houses require for their fullest development more solar light probably than even our best hot-houses transmit—certainly much more than is transmitted through the roofs of houses as generally constructed.

Plant houses constructed of the best Baltic pine timber are very durable, but the whole of the parts should be kept as light as possible. In many houses, especially those where ornament is of no consequence, the rafters are now omitted, or only used at wide intervals, somewhat stouter sash-bars being adopted, and stout panes of glass (usually called 21-oz.) 12 to 18 in. wide, made use of. Such houses are very light; being also very close, they require careful ventilation. The glass roof is commonly designed so as to form a uniform plane or slope from back to front in lean-to houses (fig. 2), and from centre to sides in span-roofed houses. To secure the greatest possible influx of light, some horticulturists recommend curvilinear roofs; but the superiority of these is largely due to the absence of rafters, which may also be dispensed with in plain roofs. They are very expensive to build and maintain. Span and ridge-and-furrow roofs, the forms now mostly preferred, are exceedingly well adapted for the admission of light, especially when they are glazed to within a few inches

of the ground. They can be made, too, to cover in any extent of area without sustaining walls. Indeed, it has been proposed to support such roofs to a great extent upon suspension principles, the internal columns of support being utilized for conducting the rain-water off the roof to underground drains or reservoirs. The lean-to is the least desirable form, since it scarcely admits of elegance of design, but it is necessarily adopted in many cases.

In glazing, the greater the surface of glass, and the less space occupied by rafters and astragals as well as overlaps, the greater the admission of light. Some prefer that the sash-bars should be grooved instead of rebated, and this plan exposes less putty to the action of the weather. The simple bedding of the glass, without the use of over putty, seems to be widely approved; but the glass may be fixed in a variety of other ways, some of which are patented.

The *Conservatory* is often built in connexion with the mansion, so as to be entered from the drawing-room or boudoir. But when so situated it is apt to suffer from the shade of the building, and is objectionable on account of admitting damp to the drawing-room. Where circumstances will admit, it is better to place it at some distance from the house, and to form a connexion by means of a glass corridor. In order that the conservatory may be kept gay with flowers, there should be a subsidiary structure to receive the plants as they go out of bloom. The conservatory may also with great propriety be placed in the flower garden, where it may occupy an elevated terrace, and form the termination of one of the more important walks.

Great variety of design is admissible in the conservatory, but it ought always to be adapted to the style of the mansion of which it is a prominent appendage. Some very pleasing examples are to be met with which have the form of a parallelogram with a lightly rounded roof; others of appropriate character are square or nearly so, with a ridge-and-furrow roof. Whatever the form, there must be light in abundance; and the shade both of buildings and of trees must be avoided. A southern aspect, or one varying to south-east or south-west, is preferable; if these aspects cannot be secured, the plants selected must be adapted to the position. The central part of the house may be devoted to permanent plants; the side stages and open spaces in the permanent beds should be reserved for the temporary plants.

The *Greenhouse* is a structure designed for the growth of such exotic plants as require to be kept during winter in a temperature considerably above the freezing-point. The best form is the span-roofed, a single span being better even than a series of spans such as form the ridge-and-furrow roof. For plant culture, houses at a comparatively low pitch are better than higher ones where the plants have to stand at a greater distance from the glass, and therefore in greater gloom. Fig. 3 represents a convenient form of greenhouse.

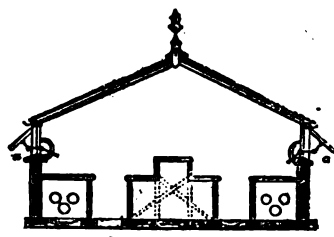

FIG. 3.—Section of Greenhouse.

It is 20 ft. wide and 12 ft. high, and may be of any convenient length. The side walls are surmounted by short upright sashes which open outwards by machinery *a*, and the roof is provided with sliding upper sashes for top ventilation. The upper sashes may also be made to lift, and are in many respects more convenient to operate. In the centre is a two-tier stage 6 ft. wide, for plants, with a pathway on each side 3 ft. wide, and a side stage 4 ft. wide, the side stages being flat, and the centre stage having the middle portion one-third of the width elevated 1 ft. above the rest so as to lift up the middle row of plants nearer the light. Span-roofed houses of this character should run north and south so as to secure an equalization of light, and should be warmed by two flow, and one or two return 4-in. hot-water pipes, carried under the side stages along each side and across each end. Where it is desired to cultivate a large number of plants, it is much better to increase the number of such houses than to provide larger structures. The smaller houses are far better for cultural purposes, while the plants can be classified, and the little details of management more conveniently attended to. Pelargoniums, cinerarias, calceolarias, cyclamens, camellias, heaths, roses and other specialities might thus have to themselves either a whole house or part of a house, the conditions of which could then be more accurately fitted to the wants of the inmates.

The lean-to house is in most respects inferior to the span-roofed;

one of the latter could be converted into two of the former of opposite aspects by a divisional wall along the centre. Except where space does not permit a span-roofed building to be introduced, a lean-to is not to be recommended; but a house of this class may often be greatly improved by adopting a half-span or hipped roof—that is, one with a short slope behind and a longer in front.

Where the cultivation of large specimens has to be carried on, a span-roofed house of greater height and larger dimensions may sometimes prove useful; but space for this class of plants may generally be secured in a house of the smaller elevation, simply by lowering or removing altogether the staging erected for smaller plants, and allowing the larger ones to stand on or nearer the floor. The *Plant Stove* differs in no respect from the greenhouse except in having a greater extent of hot-water pipes for the purpose of securing a greater degree of heat, although, as the plants in stove

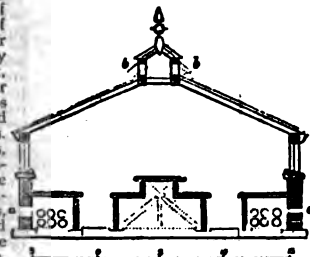

FIG. 4.—Section of Plant Stove.

houses often attain a larger size, and many of them require a bed of coco-nut fibre, tan or leaf mould to supply them with bottom heat, a somewhat greater elevation may perhaps be occasionally required in some of the houses. For the smaller plants, and for all choicer subjects, the smaller size of house already recommended for greenhouses, namely 20 ft. wide and 12 ft. high, with a side table of 4 ft. on each side, a pathway of 3 ft. and a central stage on two levels of 6 ft. wide, will be preferable, because more easily managed as to the supply of heat and moisture. It will be seen (fig. 4) that along the ridge of the roof a raised portion or lantern light *b, b* is introduced, which permits of the fixing of two continuous ventilators, one along each side, for the egress of heated and foul air, openings *a, a* being also provided in the side walls opposite the hot-water pipes for the admission of pure cold air. This type of house is also very suitable for greenhouse plants, but would not need so much heating apparatus. Three or four rows of flow and return pipes respectively will be required on each side, according to the heat proposed to be maintained.

In their interior fittings plant stoves require more care than greenhouses, which are much drier, and in which consequently the staging does not so soon decay. In stoves the stages should be of slate or stone where practicable, and the supports of iron. These should be covered with a layer of 2 or 3 in. of some coarse gritty material, such as pounded spar, or the shell sand obtained on the sea-coast, on which the pots are to stand; its use is to absorb moisture and gradually give it out for the benefit of the plants. The pathways should be paved with tiles, brick or stone, or made of concrete and cement, and the surface should be gently rounded so that the water required for evaporation may drain to the sides while the centre is sufficiently dry to walk upon; they should also have brick or stone edgings to prevent the water so applied soaking away at the sides and thus being wasted.

Fruit Houses.—The principal of these are the vinery, peach house, cucumber and melon house and orchard house. These,

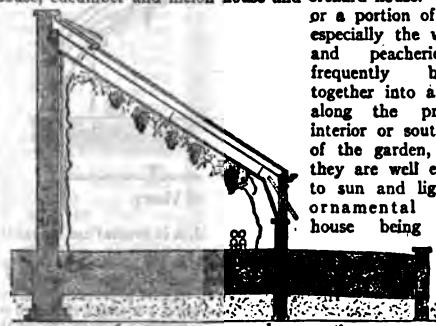

FIG. 5.—Lean-to Vinery.

or a portion of them, especially the vinerias and peacheries, are frequently brought together into a range along the principal interior or south wall of the garden, where they are well exposed to sun and light, an ornamental plant house being some-

times introduced into the centre of the range in order to give effect to the outline of the buildings. When thus associated, the houses are usually of the lean-to class, which have the

and with the means of giving sufficient ventilation to keep the air sweet. It should also be sufficiently commodious to permit of the fruit being arranged in single layers on the shelves or trays. A type of building which is becoming increasingly popular for this purpose, and which is in many respects superior to the older, and often more expensive structures, is built of wood, with or without brick foundations, and is thickly thatched with reeds or other non-conducting material externally—on walls and roof—while the interior is matchboarded. Ventilation is afforded at the ends, usually by tilting laths, operated by a cord. Two doors are provided at one end—an inner, and an outer—the inner being glazed at the top to admit light. They are generally span-roofed, about 6 ft. high at the eaves, and 8 or 10 ft. high at the ridge, according to width.

The length and breadth of these stores should be governed by the amount and character of the storage accommodation to be provided. If intended for storage only, a width of 9 ft. 6 in. would suffice, but if intended to combine display with storage, the internal diameter should be about 13 ft. In the former type, the walls are fitted with four rows of shelves, about 3 ft. wide, and about 1 ft. 6 in. apart. The shelves are of deal strips, 2 or 3 in. wide, laid about 1 in. apart for ventilation. These are being superseded, however, by sliding-out trays of convenient lengths and about 9 in. deep, working on fixed framework. By this means the storage accommodation is nearly doubled and the fruit is more easily manipulated. The central gangway is about 3 ft. 6 in. wide. In the latter a central exhibition bench about 3 ft. wide and of convenient height is provided. Gangways 2½ ft. wide flank this, while the shelves or drawers with which the walls are fitted are about 2½ ft. wide.

Care of the Fruit Rooms.—This consists mainly in the storing only of such fruits as are dry and in proper condition; in judicious ventilation, especially in the presence of large quantities of newly-gathered fruit; in the prompt removal of all decaying fruit; and in the exclusion of vermin. It is also advisable to wash all woodwork and gangways annually with a weak solution of formalin, or other inodorous germicide.

Heating Apparatus.—Plant houses were formerly heated in a variety of ways—by fermenting organic matter, such as dung, by smoke flues, by steam and by hot water circulating in iron pipes. The last-named method has proved so satisfactory in practice that it is now in general use for all ordinary purposes. The water is heated by a furnace, and is conveyed from the boiler into the houses by a main or "flow" pipe, connected by means of syphon branches with as many pipes as it is intended to serve. When cooled it is returned to the boiler by another main or "return" pipe. Heat is regulated in the structures by means of valves on the various branch pipes. The flow pipe is attached to the boiler at its highest point, to take the heated water as it ascends. The return pipe is connected with the boiler at or near its lowest point. The highest points of the pipes are fitted with small taps, for the removal of air, which would retard circulation if allowed to remain. Heating by hot water may be said to depend, in part, on the influence of gravity on water being to some extent overcome by heating in a boiler. It ascends the flow pipe by convection, where its onward journey would speedily end if it were not for the driving force of other molecules of water following, and the suction set up by the gravitation into the boiler of the cooled water by the return pipe. The power of water to conduct heat is very low. The conducting power of the iron in which it is conveyed is high. It is, however, probable that conduction is to some extent a factor in the process.

Pipes.—It is a mistake to stint the quantity of piping, since it is far more economical and better for the plants to have a larger surface heated moderately than a smaller surface heated excessively. In view of the fact that air expands, becomes lighter and rises, under the influence of heat, the pipes should be set near the floor. If intended to raise the temperature of the structure, they should be set on iron or brick supports just clear of walls, earth or other heat-absorbing bodies. Those intended to provide bottom heat, however, are set in (a) water tanks running under the beds, or (b) in enclosed dry chambers under the beds, or are (c) embedded in the soil or plunging material. The first-named method is distinctly superior to the others. Pipes of 2 in., 3 in., 4 in. and 6 in. diameters are mostly used, the 4 in. size being the most convenient for general purposes. The joints are packed or caulked with tow, smeared with a mixture of white and red lead. Flanged joints are made to bolt together on washers of vulcanized rubber.

Boilers.—There are numerous types of boilers in use, illustrative of efforts to secure as much exposure as possible to the action of the

flames. The water-tube type, with multiple waterways, consists of a number of separate tubes joined together in various ways. Some of these are built in the form of a blunt cone, and are known as conical tubular boilers. Others are built with the tubes arranged horizontally, and are known as horizontal tubular boilers. The majority of the latter are more or less saddle-shaped. Boilers with a single waterway are of three principal types, the Cornish, the saddle and the conical. The Cornish is cylindrical with the furnace occupying about half the length of the cylinder. The saddle is so named from its supposed resemblance to a saddle. It is set to span the furnace, additional exposure to heat being secured in a variety of ways by flues. Exposure in the conical boiler is direct on its inner surface, and is supplemented by flues. Tubular boilers, especially the horizontal types, are very powerful and economical. The Cornish type is a rather slow and steady boiler, and is much used for providing heat for large areas. The saddle boiler is very commonly employed to provide heat for moderately sized and small areas. Both are powerful and economical. Conical boilers are more expensive to set by reason of their shape, and are not so convenient to manipulate as the horizontal kinds. All the above types require a setting of masonry. Portable boilers are convenient for heating small areas, and are less expensive to install than those described above. They are less economical, however, owing to loss of heat from their exposed surfaces. What are called sectional boilers as used in America and on the Continent are being introduced to British gardens. Portions can be added or taken away according to the amount of heating surface required.

Water Supply.—Wastage of water in the boilers should be made good automatically from a cistern controlled by means of a ball-cock. It should be placed as high above the boiler as practicable. The feed should connect with the return pipe near the point at which it enters the boiler.

Stokeholds.—These have usually to be excavated to admit of the boilers being set below the level of the pipes they are intended to serve. In consequence of their depth, the draining of stokeholds often presents difficulties. Care should be taken to allow sufficient room to properly manipulate the fires and to store fuel. It is important that the ventilation should be as efficient as practicable, especially where coke fuel is to be used.

Stoking.—The management of the furnaces is relatively easy, and consists in adapting the volume and intensity of the fires to particular needs. It involves the keeping clean of flues, ashpits and especially the fires themselves. Where coke or ordinary hard coal are used, the removal of clinkers should be done systematically, and the fires stirred. Anthracite coal fires should not be stirred more than is absolutely necessary, and should not be fed in dribbles. They require more draught than coke fires, but care must be taken not to give too much, as excessive heat is likely to melt or soften the fire-bars. Draught is regulated in the ashpit by opening or closing the bottom door of the furnace and by the damper on the smoke shaft. The latter must be of a fairly good height, according to circumstances, to secure a good draught.

Solar Heat.—The importance of sun heat to the general well-being of plant life, its influence on the production of flowers and the ripening of edible fruits, has long been appreciated in horticulture. The practice of "closing up" early in the afternoon, i.e. the closing of ventilators (accompanied by syringing and damping of surfaces to produce a humid atmosphere) has for its object the conservation of as much solar heat as practicable.

Ventilation.—This consists in the admission of air for the purpose of preventing stagnation of the atmosphere and for the regulation of temperature. Means of affording ventilation in all plant houses should be provided in at least two places—as near the floor as practicable, and at the top. Mechanical contrivances whereby whole sets of ventilators may be operated simultaneously are now in common use, and are much more convenient and economical than the older method of working each ventilator separately. Efficient ventilating can only be effected by the exercise of common sense and vigilance, and care must be taken to avoid cold draughts through the houses.

III. Garden Materials and Appliances.

Soils and Composts.—The principal soils used in gardens, either alone, or mixed to form what are called composts, are—loam, sand, peat, leaf-mould and various mixtures and combinations of these made up to suit the different subjects under cultivation.

Loam is the staple soil for the gardener; it is not only used extensively in the pure and simple state, but enters into most of the composts prepared specially for his plants. For garden purposes loam should be rather unctuous or soapy to the touch when moderately dry, not too clinging nor adhesive, and should readily crumble when a compressed handful is thrown on the ground. If it clings together closely it is too heavy and requires amelioration by the admixture of gritty material; if it has little or no cohesion when squeezed tightly in the hand, it is

too light, and needs to be improved by the addition of heavier or clayey material. Sound friable loam cut one sod deep from the surface of a pasture, and stacked up for twelve months in a heap or ridge, is invaluable to the gardener. When employed for making vine borders, loam of a somewhat heavier nature can be used with advantage, on account of the porous materials which should accompany it. For stone fruits a calcareous loam is best; indeed, for these subjects a rich calcareous loam used in a pure and simple state cannot be surpassed. Somewhat heavy loams are best for potting pine apples, for melons and strawberries, fruit trees in pots, &c., and may be used with the addition of manures only; but for ornamental plants a loam of a somewhat freer texture is preferable and more pleasant to work. Loam which contains much red matter (iron) should be avoided.

Sand is by itself of little value except for striking cuttings, for which purpose fine clean sharp silver sand is the best; and a somewhat coarser kind, if it is gritty, is to be preferred to the comminuted sands which contain a large proportion of earthy matter. River sand and the sharp grit washed up sometimes by the road side are excellent materials for laying around choice bulbs at planting time to prevent contact with earth which is perhaps manure-tainted. Sea sand may be advantageously used both for propagating purposes and for mixing in composts. For the growth of pot plants sand is an essential part of most composts, in order to give them the needful porosity to carry off all excess of moisture from the roots. If the finer earthy sands only are obtainable, they must be rendered sharper by washing away the earthy particles. Washed sand is best for all plants like heaths, which need a pure and lasting peaty compost.

Peat soil is largely employed for the culture of such plants as rhododendrons, azaleas, heaths, &c. In districts where heather and gritty soil predominate, the peat soil is poor and unprofitable, but selections from both the heathy and the richer peat soils, collected with judgment, and stored in a dry part of the compost yard, are essential ingredients in the cultivation of many choice pot plants, such as the Cape heaths and many of the Australian plants. Many monocotyledons do well in peat, even if they do not absolutely require it.

Leaf-mould is eminently suited for the growth of many free-growing plants, especially when it has been mixed with stable manure and has been subjected to fermentation for the formation of hot beds. It any state most plants feed greedily upon it, and when pure or free from decaying wood or sticks it is a very safe ingredient in composts; but it is so liable to generate fungus, and the mycelium or spawn of certain fungi is so injurious to the roots of trees, attacking them if at all sickly or weakened by drought, that many cultivators prefer not to mix leaf-mould with the soil used for permanent plants, as peaches or choice ornamental trees. For quick growing plants, however, as for example most annuals cultivated in pots, such as balsams, cockscombs, globe-amaranths and the like, for cucumbers, and for young soft-wooded plants generally, it is exceedingly useful, both by preventing the consolidation of the soil and as a manure. The accumulations of light earth formed on the surface in woods where the leaves fall and decay annually are leaf-mould of the finest quality. Leaves collected in the autumn and stored in pits or heaps, and covered with a layer of soil, make beautiful leaf-mould at the end of about twelve months, if frequently drenched with water or rain during this period.

Composts are mixtures of the foregoing ingredients in varying proportions, and in combination with manures if necessary, so as to suit particular plants or classes of plants. The chief point to be borne in mind in making these mixtures is not to combine in the same compost any bodies that are antagonistic in their nature, as for example lime and ammonia. In making up composts for pot plants, the fibrous portion should not be removed by sifting, except for small-sized pots, but the turfy portions should be broken up by hand and distributed in smaller or larger lumps throughout the mass. When sifting is had recourse to, the fibrous matter should be rubbed through the

meshes of the sieve along with the earthy particles. Before being used the turfy ingredients of composts should lie together in a heap only long enough for the roots of the herbage to die, not to decompose.

Manures (see MANURE).—These are of two classes, organic and inorganic—the former being of animal and vegetable, the latter of mineral origin. The following are organic manures:

Farm-yard manure consists of the mixed dung of horses and cattle thrown together, and more or less soaked with liquid drainings of the stable or byre. It is no doubt the finest stimulant for the growth of plants, and that most adapted to restore the fertile elements which the plants have abstracted from exhausted soils. This manure is best fitted for garden use when in a moderately fermented state.

Horse dung is generally the principal ingredient in all hot bed manure; and, in its partially decomposed state, as afforded by exhausted hot beds, it is well adapted for garden use. It is most beneficial on cold stiff soils. It should not be allowed to lie too long unmoved when fresh, as it will then heat violently, and the ammonia is thus driven off. To avoid this, it should be turned over two or three times if practicable, and well moistened—preferably with farm-yard drainings.

Cow dung is less fertilizing than horse dung, but being slower in its action it is more durable; it is also cooler, and therefore better for hot dry sandy soils. Thoroughly decayed, it is one of the best of all manures for mixing in, composts for florists' flowers and other choice plants.

Pig dung is very powerful, containing more nitrogen than horse dung; it is therefore desirable that it should undergo moderate fermentation, which will be secured by mixing it with litter and a portion of earth. When weeds are thrown to the pigs, this fermentation becomes specially desirable to kill their seeds.

Night-soil is an excellent manure for all bulky crops, but requires to be mixed with earth or peat, or coal-ashes, so as both to deodorize it and to ensure its being equally distributed. Quicklime should not be used, as it dispels the greater part of the ammonia. When prepared by drying and mixing with various substances, night-soil is sold as desiccated night-soil or native guano, the value of which depends upon the materials used for admixture.

Malt-dust is an active manure frequently used as a top-dressing, especially for fruit trees in pots. It is rapid in its action, but its effects are not very permanent. **Rape dust** is somewhat similar in its character and action.

Bones are employed as a manure with decided advantage both to vegetable crops and to fruit trees, as well as to flowers. For turnips bone manure is invaluable. The effects of bones are no doubt mainly due to the phosphates they contain, and they are most effectual on dry soils. They are most quickly available when dissolved in sulphuric acid.

Guano is a valuable manure now much employed, and may be applied to almost every kind of crop with decided advantage. It should be mixed with six or eight times its weight of loam or ashes, charred peat, charcoal-dust or some earthy matter, before it is applied to the soil, as from its causticity it is otherwise not unlikely to kill or injure the plants to which it is administered. Peruvian guano is obtained from the excreta of South American sea-birds, and fish guano from the waste of fish. Both are remarkable for the quantity of nitrates and phosphates they contain.

Pigeon dung approaches guano in its power as manure. It should be laid up in ridges of good loamy soil in alternate layers to form a compost, which becomes a valuable stimulant for any very choice subjects if cautiously used. The dung of the domestic fowl is very similar in character.

Horn, hoof-parings, woollen rags, fish, blubber and blood, after treatment with sulphuric acid, are all good manures, and should be utilized if readily obtainable.

Liquid manure, consisting of the drainings of dung-heaps, stables, cowsheds, &c., or of urine collected from dwelling houses or other sources, is a most valuable and powerful stimulant, and can be readily applied to the roots of growing plants. The urine should be allowed to putrefy, as in its decomposition a large amount of ammonia is formed, which should then be fixed by sulphuric acid or gypsum; or it may be applied to the growing crops after being freely diluted with water or absorbed in a compost heap. Liquid manures can be readily made from most of the solid manures when required, simply by admixture with water. When thus artificially compounded, unless for immediate use, they should be made strong for convenience of storage, and applied as required much diluted.

The following are inorganic manures:

Ammonia is the most powerful and one of the most important of the constituents of manures generally, since it is the chief source whence plants derive their nitrogen. It is largely supplied in all the most fertilizing of organic manures, but when required in the inorganic state must be obtained from some of the salts of ammonia, as the sulphate, the muriate or the phosphate, all of which, being extremely energetic, require to be used with great caution. These salts of ammonia may be used at the rate of from 2 to 3 cwt. per acre as a top-dressing in moist weather. When dissolved in water they

form active liquid manures. The most commonly used nitrogenous manures are nitrate of soda, nitrate of potash and sulphate of ammonia, the prices of which are constantly fluctuating.

Potash and soda are also valuable inorganic manures in the form of carbonates, sulphates, silicates and phosphates, but the most valuable is the nitrate of potash. The price, however, is generally so high that its use is practically nil, except in small doses as a liquid manure for choice pot plants. Cheaper substitutes, however, are now found in sulphate of potash, and muriate of potash and kainit. The two last-named must not be applied direct to growing crops, but to the soil some weeks in advance of sowing or cropping. The manures of this class are of course of value only in cases where the soil is naturally deficient in them. On this account the salts of soda are of less importance than those of potash. The value of wood ashes as a manure very much depends upon the carbonate and other salts of potash which they contain.

Phosphoric acid, in the form of phosphates, is a most valuable plant food, and is absorbed by most plants in fairly large quantities from the soil. It induces the earlier production of flowers and fruits. In a natural state it is obtained from bones, guano and wood ashes; and in an artificial condition from basic slag or Thomas's phosphate, coprolites and superphosphate of lime.

Lime in the caustic state is beneficially applied to soils which contain an excess of inert vegetable matter, and hence may be used for the improvement of old garden soils saturated with humus, or of peaty soils not thoroughly reclaimed. It does not supply the place of organic manures, but only renders that which is present available for the nourishment of the plants. It also improves the texture of clay soils.

Gypsum, or sulphate of lime, applied as a top-dressing at the rate of 2 to 3 cwt. per acre, has been found to yield good results, especially on light soils. It is also employed in the case of liquid manures to fix the ammonia.

Gas lime, after it has been exposed to the air for a few months is an excellent manure on heavy soils. In a fresh state it is poisonous and fatal to vegetation, and is often used for this reason to dress land infested with wireworms, grubs, club-root fungus, &c.

Burnt clay has a very beneficial effect on clay land by improving its texture and rendering soluble the alkaline substances it contains. The clay should be only slightly burnt, so as to make it crumble down readily; in fact, the fire should not be allowed to break through, but should be constantly repressed by the addition of material. The burning should be effected when the soil is dry.

Vegetable refuse of all kinds, when another-burned in a similar way, becomes a valuable mechanical improver of the soil; but the preferable course is to decompose it in a heap with quicklime and layers of earth, converting it into leaf-mould. Potato haulms, and club-rooted cabbage crops should, however, never be mixed with ordinary clean vegetable refuse, as they would be most likely to perpetuate the terrible diseases to which they are subject. The refuse of such plants should be burned as early as possible. The ash may be used as manure.

Soot forms a good top-dressing; it consists principally of charcoal, but contains ammonia and a smaller proportion of phosphates and potash, whence its value as a manure is derived. It should be kept dry until required for use. It may also be used beneficially in preventing the attacks of insects, such as the onion gnat and turnip fly, by dusting the plants or dressing the ground with it.

Common salt acts as a manure when used in moderate quantities, but in strong doses is injurious to vegetation. It suits many of the esculent crops, as onions, beans, cabbages, carrots, beet-root, asparagus, &c.; the quantity applied varies from 5 to 10 bushels per acre. It is used as a top-dressing sown by the hand. Hyacinths and other bulbs derive benefit from slight doses, while to asparagus as much as 20 lb to the rod has been used with beneficial effect. At the rate of from 6 to 10 bushels to the acre it may be used on garden lawns to prevent worm casts. For the destruction of weeds on gravel walks or in paved yards a strong dose of salt, applied either dry or in a very strong solution, is found very effective, especially a hot solution, but after a time much of it becomes washed down, and the residue acts as a manure; its continued application is undesirable, as gravel so treated becomes pasty.

Garden Tools, &c.—Most of these are so well known that we shall not discuss them here. They are, moreover, illustrated and described in the catalogues of most nurserymen and dealers in horticultural sundries.

Tallies or Labels.—The importance of properly labelling plants can hardly be over-estimated. For ordinary purposes labels of wood of various sizes (sold in bundles) are the most convenient. These should be wiped with a little white paint or linseed oil, and written with a soft lead pencil before the surface becomes dry. Copying-ink pencils should not be used, as water will wash away the writing. For permanent plants, as trees, roses, &c., metallic labels with raised type are procurable from dealers, and are neat, durable and convenient. Permanent labels may also be made from sheet lead, the names being punched in by means

of steel type. For stove and greenhouse plants, orchids, ferns, &c., labels made of xylonite, zinc and other materials are also used.

IV. Garden Operations.

Propagation.—The increase of plants, so far as the production of new individuals of particular kinds is concerned, is one of the most important and constantly recurring of gardening operations. In effecting this, various processes are adopted, which will now be described.

1. **By Seeds.**—This may be called the natural means of increasing the number of any particular kind of plant, but it is to be remembered that we do not by that means secure an exact reproduction of the parent, especially in the case of plants raised or evolved in the course of generations by hybridization and selection. We may get a progeny very closely resembling it, yet each plant possessing a distinct individuality of its own; or we may get a progeny very unlike the parent, or a mixed progeny showing various degrees of divergence. Many seeds will grow freely if sown in a partially ripened state; but as a general rule seeds have to be kept for some weeks or months in store, and hence they should be thoroughly ripened before being gathered. They should be sown in fine rich soil, and such as will not readily get consolidated. In the case of outdoor crops, if the soil is inclined to be heavy, it is a good plan to cover all the smaller seeds with a light compost. Very small seeds should only have a sprinkling of light earth or of sand, and sometimes only a thin layer of soft moss to exclude light and preserve an equable degree of moisture. Somewhat larger seeds sown indoors may be covered to the depth of one-eighth or one-fourth of an inch, according to their size. Outdoor crops require to be sown, the smaller seeds from $\frac{1}{4}$ to 1 in., and the larger ones from 2 to 4 in. under the surface, the covering of the smaller ones especially being light and open. Many seeds grow well when raked in; that is, the surface on which they are scattered is raked backwards and forwards until most of them are covered. Whatever the seeds, the ground should be made tolerably firm both beneath and above them; this may be done by treading in the case of most kitchen garden crops, which are also better sown in drills, this admitting the more readily of the ground being kept clear from weeds by hoeing. All seeds require a certain degree of heat to induce germination. For tropical plants the heat of a propagating house—75° to 80°, with a bottom heat of 80° to 90°—is desirable, and in many cases absolutely necessary; for others, such as half-hardy annuals, a mild hot bed, or a temperate pit ranging from 60° to 70°, is convenient; while of course all outdoor crops have to submit to the natural temperature of the season. It is very important that seeds should be sown when the ground is in a good working condition, and not clammy with moisture.

2. **By Offsets.**—This mode of increase applies specially to bulbous plants, such as the lily and hyacinth, which produce little bulbs on the exterior round their base. Most bulbs do so naturally to a limited but variable extent; when more rapid increase is wanted the heart is destroyed, and this induces the formation of a larger number of offsets. The stem bulbs of lilies are similar in character to the offsets from the parent bulb. The same mode of increase occurs in the gladiolus and crocus, but their bulb-like permanent parts are called corms, not bulbs. After they have ripened in connexion with the parent bulb, the offsets are taken off, stored in appropriate places, and at the proper season planted out in nursery beds.

3. **By Tubers.**—The tuber is a fleshy underground stem, furnished with eyes which are either visible, as in the potato and in some familiar kinds of *Tropaeolum* (*T. tuberosum*) and of *Oxalis* (*O. crenata*), or latent, as in the Chinese yam (*Dioscorea Batatas*). When used for propagation, the tubers are cut up into what are called "sets," every portion having an eye attached being capable of forming an independent plant. The cut portions of bulky sets should be suffered to lie a short time before being planted, in order to dry the surface and prevent rotting; this should not, however, be done with such tropical subjects as caladiums, the tubers of which are often cut up into very small fragments for propagation, and of course require to be manipulated in a properly heated propagating pit. No eyes are visible in the Chinese yam, but slices of the long club-shaped tubers will push out young shoots and form independent plants, if planted with ordinary care.

4. **By Division.**—Division, or partition, is usually resorted to in the case of tufted growing plants, chiefly perennial herbs; they may be evergreen, as chamomile or thrift, or when dormant may consist only of underground crowns, as larkspur or lily-of-the-valley; but in either case the old tufted plant being dug up may be divided into separate pieces, each furnished with roots, and, when replanted, generally starting on its own account without much check. Suffruticose plants and even small shrubs may be propagated in this way, by first planting them deeper than they are ordinarily grown, and then after the lapse of a year, which time they require to get rooted, taking them up again and dividing them into parts or separate plants. Box-edging and southernwood are examples. The same ends may sometimes be effected by merely working fine

soil in amongst the base of the stems, and giving them time to throw out roots before parting them.

5. *By Suckers*.—Root suckers are young shoots from the roots of plants, chiefly woody plants, as may often be seen in the case of the elm and the plum. The shoots when used for propagation must be transplanted with all the roots attached to them, care being taken not to injure the parent plant. If they spring from a thick root it is not to be wantonly severed, but the soil should be removed and the sucker taken off by cutting away a clean slice of the root, which will then heal and sustain no harm. Stem suckers are such as proceed from the base of the stem, as is often seen in the case of the currant and lilac. They should be removed in any case; when required for propagation they should be taken with all the roots attached to them, and they should be as thoroughly disbudged below ground as possible, or they are liable to continue the habit of suckering. In this case, too, the soil should be carefully opened and the shoots removed with a suckering iron, a sharp concave implement with long iron handle (fig. 14). When the number of roots is limited, the tops



FIG. 14.—Suckering Iron.

should be shortened, and some care in watering and mulching should be bestowed on the plant if it is of value.

6. *By Runners*.—The young string-like shoots produced by the strawberry are a well-known example of runners. The process of rooting these runners should be facilitated by fixing them close down to the soil, which is done by small wooden hooked pegs or by stones; hair-pins, short lengths of bent wire, &c., may also be used. After the roots are formed, the strings are cut through, and the runners become independent plants.

7. *By Proliferous Buds*.—Not unlike the runner, though growing in a very different way, are the bud-plants formed on the fronds of several kinds of ferns belonging to the genera *Asplenium*, *Woodwardia*, *Polystichum*, *Lastrea*, *Adiantum*, *Cystopteris*, &c. In some of these (*Adiantum caudatum*, *Polystichum lepidocaulon*) the rachis of the frond is lengthened out much like the string of the strawberry runner, and bears a plant at its apex. In others (*Polystichum angulare proliferum*) the stipes below and the rachis amongst the pinnae develop buds, which are often numerous and crowded. In others again (*Woodwardia orientalis*, *Asplenium bulbiferum*), buds are numerously produced on the upper surface of the fronds. These will develop on the plant if allowed to remain. For propagation the bulbiferous portion is pegged down on the surface of a pot of suitable soil; if kept close in a moist atmosphere, the little buds will soon strike root and form independent plants. In *Cystopteris* the buds are deciduous, falling off as the fronds acquire maturity, but, if collected and pressed into the surface of a pot of soil and kept close, they will grow up into young plants the following season. In some genera of flowering plants, and notably in *Bryophyllum*, little plants form on various parts of the leaves. In some Monocotyledons, ordinarily in *Chlorophytum*, and exceptionally in *Phalaenopsis* and others, new plants arise on the flower stems.

8. *By Layers*.—Layering consists in preparing the branch of a plant while still attached to the parent, bending it so that the part operated on is brought under ground, and then fixing it there by means of a forked peg. Some plants root so freely that they need only pegging down; but in most cases the arrest of the returning sap to form a callus, and ultimately young roots, must be brought about artificially, either by twisting the branch, by splitting it, by girdling



FIG. 15.—Propagation by Layers—*a*, tonguing; *b*, ringing.

it closely with wire, by taking off a ring of bark, or by "tonguing." In tonguing the leaves are cut off the portion which has to be brought under ground, and a tongue or slit is then cut from below upwards close beyond a joint, of such length that, when the cut part of the layer is pegged an inch or two (or in larger woody subjects 3 or 4 in.) below the surface, the elevation of the point of the shoot to an upright position may open the incision, and thus set it free, so that it may

be surrounded by earth to induce it to form roots. The whole branch, except a few buds at the extremity, is covered with soil. The best seasons for these operations are early spring and mid-summer, that is, before the sap begins to flow, and after the first flush of growth has passed off. One whole summer, sometimes two, must elapse before the layers will be fully rooted in the case of woody plants; but such plants as carnations and picotees, which are usually propagated in this way, in favourable seasons take only a few weeks to root, as they are layered towards the end of the blooming season in July, and are taken off and planted separately early in the autumn. Fig. 15 shows a woody plant with one layer prepared by tonguing and another by ringing.

In general, each shoot makes one layer, but in plants like the *Wistaria* or *Clematis*, which make long shoots, what is called serpentine layering may be adopted; that is, the shoot is taken alternately below and above the surface, as frequently as its length permits. There must, however, be a joint at the underground part where it is to be tongued and pegged, and at least one sound bud in each exposed part, from which a shoot may be developed to form the top of the young plant.

9. *By Circumposition*.—When a plant is too high or its habit does not conveniently admit of its being layered, it may often be increased by what is called circumposition, the soil being carried up to the branch operated on. The branch is to be prepared by ringing or notching or wiring as in layering, and a temporary stand made to support the vessel which is to contain the soil. The vessel may be a flower-pot sawn in two, so that the halves may be bound together when used, or it may be a flower-pot or box with a side slit which will admit the shoot; this vessel is to be filled compactly with suitable porous earth, the opening at the slit being stopped by pieces of slate or tin. The earth must be kept moist, which is perhaps best done by a thick mulching of moss, the moss being also bound closely over the openings in the vessel, and all being kept damp by frequent syringings. Gardeners often dispense with the pot, using sphagnum and leaf-mould only when propagating indiarubber plants, perpetual carnations, dracaenas, &c.

10. *By Grafts*.—Grafting is so extensively resorted to that it is impossible here to notice all its phases. It is perhaps of most importance as the principal means of propagating our hardy kinds of fruit, especially the apple and the pear; but the process is the same with most other fruits and ornamental hardy trees and shrubs that are thus propagated. The stocks are commonly divided into two classes—(1) free stocks, which consist of seedling plants, chiefly of the same genus or species as the trees from which the scions are taken; and (2) dwarfing stocks, which are of more diminutive growth, either varieties of the same species or species of the same or some allied genus as the scion, which have a tendency to lessen the expansion of the engrafted tree. The French Paradise is the best dwarfing stock for apples, and the quince for pears. In determining the choice of stocks, the nature of the soil in which the grafted trees are to grow should have full weight. In a soil, for example, naturally moist, it is proper to graft pears on the quince, because this plant not only thrives in such a soil, but serves to check the luxuriance thereby produced. The scions should always be ripened portions of the wood of the preceding year, selected from healthy parents; in the case of shy-bearing kinds, it is better to obtain them from the fruitful branches. The scions should be taken off some weeks before they are wanted, and half-buried in the earth, since the stock at the time of grafting should in point of vegetation be somewhat in advance of the graft. During winter, grafts may be conveyed long distances, if carefully packed. If they have been six weeks or two months separated from the parent plant, they should be grafted low on the stock, and the earth should be ridged up round them, leaving only one bud of the scion exposed above ground. The best season for grafting apples and similar hardy subjects in the open air is in March and April; but it may be commenced as soon as the sap in the stock is fairly in motion.

Whip-grafting or *Tongue-grafting* (fig. 16) is the most usual mode of performing the operation when there is no great difference in thickness between the stock and scion. The stock is beaded off by an oblique transverse cut as shown at *a*, a slice is then pared off the side as at *b*, and on the face of this a tongue or notch is made, the cut being in a downward direction; the scion *c* is pared off in a similar way by a single clean sharp cut, and this is notched or tongued in the opposite direction as the figure indicates; the two are then fitted together as shown at *d*, so that the inner bark of each may come in contact at least on one side, and then tied round with damp soft bast as at *e*; next some grafting clay is taken on the forefinger and pushed down on each side so as to fill out the space between the top of the stock and the graft, and a portion is also rubbed over the ligatures on the side where the graft is placed, a handful of the clay is then taken, flattened out, and rolled closely round the whole point of junction, being finished off to a tapering form both above and below, as shown by the dotted line *f*. To do this deftly, the hands should be plunged from time to time in dry ashes, to prevent the clay from sticking to them. Various kinds of grafting wax are now obtainable, and are a great improvement upon the clay process. Some cold mastics become very pliable with the warmth of the hands. They are best applied with a piece of flat wood; or very liquid waxes may be applied with a brush.

Cleft-grafting (fig. 17) is another method in common use. The stock *a* is cleft down from the horizontal cut *d* (but not nearly so

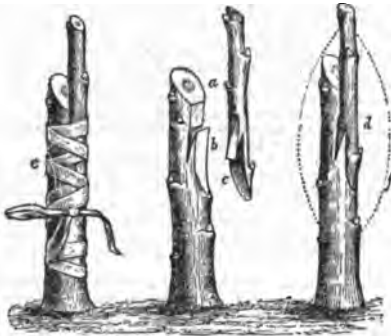

FIG. 16.—Whip-grafting or Tongue-grafting.

much as the sketch would indicate), and the scion, when cut to a thin wedge form, as shown at *c* and *e*, is inserted into the cleft; the whole is then bound up and clayed as in the former case. This is not so good a plan as whip-grafting; it is improved by sloping the stock on one side to the size of the graft.

Crown-grafting or Rind-grafting (fig. 18) is preferable to cleft-grafting, inasmuch as it leaves no open spaces in the wood. The stock *b* is cut off horizontally or nearly so in January or February. At grafting time a slit is cut in the bark *f, f*, a wedge-shaped piece of

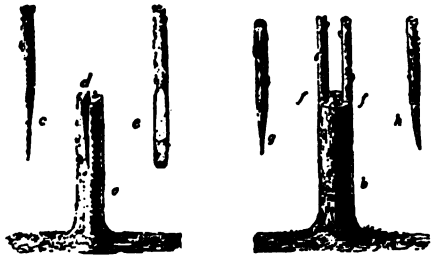

FIG. 17.—Cleft-Grafting.

FIG. 18.—Crown-Grafting.

iron or a small chisel being inserted to raise the bark; the scion is then cut to the same wedge-shaped form *g, h*, and inserted in the space opened for it between the alburnum and the bark, after which it is tied down and clayed or waxed over in the manner already described.

Side-grafting is performed like whip-grafting, the graft being inserted on the side of a branch and not at the cut end of the stock. It may be practised for the purpose of changing a part of the tree, and is sometimes very useful for filling out vacant spaces, in trained trees especially.

Inarching is another form of side-grafting. Here the graft is fixed to the side of the stock, which is planted or potted close to the plant to be worked. The branches are applied to the stock while yet attached to the parent tree, and remain so until united. In the case of trained trees, a young shoot is sometimes inarched to its parent stem to supply a branch where one has not been developed in the ordinary way.

For the propagation by grafts of stove and greenhouse plants the process adopted is whip-grafting or a modification of it. The parts are, however, sometimes so small that the tongue of the graft is dispensed with, and the two stems simply pared smooth and bound together. In this way hardy rhododendrons of choice sorts, greenhouse azaleas, the varieties of the orange family, camellias, roses, rare conifers, clematises and numerous other plants are increased. *Raffia*—which has taken the place of bast—is generally used for tying, and grafting wax is only used occasionally with such plants under glass. All grafting of this kind is done in the propagating house, at any season when grafts are obtainable in a fit state—the plants when operated on being placed in close frames warmed to a suitable temperature. Roses and clematis, however, are generally grafted from January to March and April.

Root-grafting is sometimes resorted to where extensive increase is an object, or where stem-grafting or other means of propagation are not available. In this case the scion is grafted directly on to a portion of the root of some appropriate stock, both graft and stock

being usually very small; the grafted root is then potted so as to cover the point of junction with the soil, and is plunged in the bed of the propagating house, where it gets the slight stimulus of a gentle bottom heat. Dahlias (fig. 19), paeonies, and Wisterias may be



FIG. 19.—Root-grafting of Dahlia.

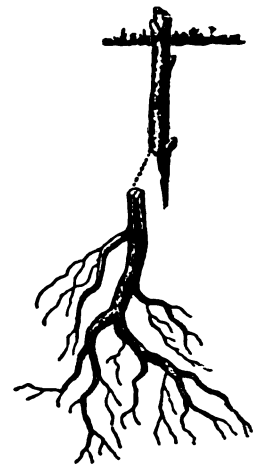

FIG. 20.—Root-grafting of Woody Plant.

grafted by inserting young shoots into the neck of one of the scaly roots of each kind respectively—the best method of doing so being to cut a triangular section near the upper end of the root, just large enough to admit the young shoot when slightly pared away on two sides to give it a similar form. In the case of large woody plants thus worked (fig. 20) the grafted roots, after the operation is completed, are planted in nursery beds, so that the upper buds only are exposed to the atmosphere, as shown in the figure.

11. *By Buds*.—Budding is the inserting of a bud of a choice variety cut with a portion of bark into the bark of the stock of an inferior nature where it is bound gently but firmly. Stone fruits, such as peaches, apricots, plums, cherries, &c., are usually propagated in this way, as well as roses and many other plants. In the propagating house budding may be done at any season when the sap is in motion; but for fruit trees, roses, &c., in the open air, it is usually done in July or August, when the buds destined for the following year are completely formed in the axils of the leaves, and when the bark separates freely from the wood it covers. Those buds are to be preferred, as being best ripened, which occur on the middle portion of a young shoot, and which are quite dormant at the time.

The simplest and most generally practised form of budding is that called *shield-budding* or *T-budding* (fig. 21). The operator should be

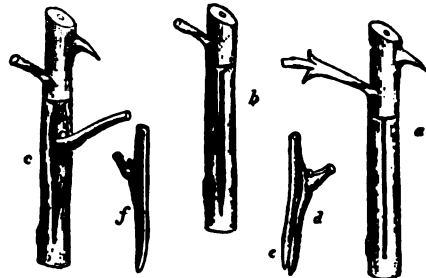

FIG. 21.—Shield-budding.

provided with a sharp budding knife having a thin ivory or bone handle, for raising the bark of the stock. A horizontal incision is made in the bark quite down to the wood, and from this a perpendicular slit is drawn upwards to the extent of perhaps an inch, so that the slit has a resemblance to the letter T, as at *a*. A bud is then cut by a clean incision from the tree intended to be propagated, having a portion of the wood attached to it, and so that the whole may be about 1 in. long, as at *d*. The bit of wood *e* must be gently withdrawn, care being taken that the bud adheres wholly to the bark or shield.

as it is called, of which *f* is a side view. The bark on each side of the perpendicular slit being then cautiously opened, as at *b*, with the handle of the knife, the bud and shield are inserted as shown at *c*. The upper tip of the shield is cut off horizontally, and brought to fit the bark of the stock at the transverse incision. Slight ties of soft cotton wool or worsted, or moist raffia, are then applied. In about a month or six weeks the ligatures may be removed or slit with the knife to allow for the swelling stem, when, if the operation has been successful, the bud will be fresh and full, and the shield firmly united to the wood. In the following spring a strong shoot will be thrown out, and to prevent its being blown out by the wind, must be fastened to a stake, or to the lower portion of the old stock which has been left for the purpose.

To be successful the operation should be performed with a quick and light hand, so that no part of the delicate tissues be injured, as would happen if they were left for a time exposed, or if the bud were forced in like a wedge. The union is effected as in grafting, by means of the organized sap or cambium, and the less this is disturbed until the inner bark of the shield is pressed and fixed against it the better. Trees to be grown in the form of a bush are usually budded low down on the stem of the stock as near the root as possible to obviate the development of wild suckers later on. Standard trees, however, are budded on a sturdy young shoot close to the top. In either case the stocks should have been carefully planted at least the previous November when the work is to be done in the open air the following July or August.

12. *By Branch Cuttings.*—Propagation by cuttings is the mode of increase most commonly adopted, next to that by seeds. It is effected by taking a portion from a branch or shoot of the plant, and placing it in the soil. There are great differences to be observed in the selection and treatment of cuttings. Sometimes soft green leafy shoots, as in *Verbena* (fig. 22, *a*), are used; sometimes the shoots



FIG. 22.—Propagation by Cuttings.

must be half-ripened, and sometimes fully matured. So of the mode of preparation; some will root if cut off or broken off at any point and thrust into wet earth or sand in a warm place (fig. 22, *a*); others require to be cut with the utmost care just below a joint or leaf-base, and by a keen blade so as to sever the tissues without tearing or bruising; and others again after being cut across may be split up for a short distance, but there seems to be no particular virtue in this. It is usual and in most cases necessary to cut away the lower portion of a cutting up to just below the node or joint (fig. 22, *b, d, e*). The internodal parts will not often divide so as to form separate individual plants; sometimes, however, this happens; it is said that the smallest piece of *Torenia asiatica*, for instance, will grow. Then as to position, certain cuttings grow readily enough if planted outdoors in the open soil, some preferring shade, others sunshine, while less hardy subjects must be covered with a bell-glass, or must be in a close atmosphere with bottom heat, or must have the aid of pure silver sand to facilitate their rooting (fig. 22, *c*). Cuttings should in all cases be taken from healthy plants, and from shoots of a moderate degree of vigour. It is also important to select leafy growths, and not such as will at once run up to flower. Young shoots which have become moderately firm generally make the best cuttings, but sometimes the very softest shoots strike more readily. For all indoor plants in a growing state spring is a good time for taking cuttings, but at any time during the summer months is also favourable if cuttings are obtainable.

Cuttings of deciduous plants should be taken off after the fall of the leaf. These cuttings should be about 6 in. to 1 ft. in length, and should be planted at once in the ground so as to leave only the top with the two or three preserved buds exposed. If a clean stem, however, is desired, a longer portion may be left uncovered. Gooseberries, currants, roses and many hardy deciduous trees and shrubs are easily propagated in this way if the cuttings are inserted in well-drained soil about the end of October or early in November.

Cuttings of growing plants are prepared by removing with a sharp knife, and moderately close, the few leaves which would otherwise be buried in the soil; they are then cut clean across just below a joint; the fewer the leaves thus removed, however, the better,

as if kept from being exhausted they help to supply the elaborated sap out of which the roots are formed. Free-rooting subjects strike in any lightish sandy mixture; but difficult subjects should have thoroughly well-drained pots, a portion of the soil proper for the particular plants made very sandy, and a surfacing of clean sharp silver sand about as deep as the length of the cutting.

Such difficult plants as heaths are reared in silver sand, a stratum of which is placed over the sandy peat soil in a specially prepared cutting pot, and thus the cuttings, though rooting in the sand under a bell-glass, find at once on the emission of roots congenial soil for them to grow in (fig. 22, *c*).

Hardy plants, such as pinks, pansies, &c., are propagated by cuttings planted during early summer in light rich soil. The cuttings of pinks are called pipings (fig. 22, *d*), and are planted about June, while pansies may be renewed in this way both in spring and in autumn.

13. *By Leaf Cuttings.*—Many plants may be propagated by plant-

ing their leaves or portions of the leaves as cuttings, as, for example, the *Gloxinia* (fig. 23, *a*) and *Gesnera*, the succulent *Sempervivum*, *Echeveria*, *Pachyphytum* and their allies, and such hard-leaved plants as *Theophrasta* (fig. 23, *b*). The leaves are best taken off with the base whole, and should be planted in well-drained sandy soil; in due time they form roots, and ultimately from some latent bud a little shoot which forms the young plant. The treatment is precisely like that of branch cuttings. *Gloxinia*, *begonia*, &c., grow readily from fragments of the leaves cut clean through the thick veins and ribs, and planted edgewise like cuttings. This class of subjects may also be fixed flat on the surface of the cutting pot, by means of little pegs or hooks, the main ribs being cut across at intervals, and from these points roots, and eventually young tubers, are produced (fig. 24).

14. *By Root Cuttings.*—Some plants which are not easily increased by other means propagate readily from root cuttings. Amongst the indoor plants which may be so treated, *Bonardia*, *Peperomia*, *Aralia*, and *Wigandia* may be mentioned. The *modus operandi* is to turn the plant out of its pot, shake away the soil so as to free the roots, and then select as many pieces of the stouter roots as may be required. These are cut up into half-inch lengths (more or less), and inserted in light sandy soil round the margin of a cutting pot, so that the upper end of the root cutting may be level with the soil or only just covered by it. The pots should be watered so as to settle the soil, and be placed in the close atmosphere of the propagating pit or frame, where they will need scarcely any water until the buds are seen pushing through the surface.

There are various herbaceous plants which may be similarly treated, such as sea-kale and horseradish, and, among ornamental plants, the beautiful autumn-blooming *Anemone japonica*, *Bocconia cordata*, *Dictamnus Fraxinella*—the burning bush; the sea hollies (*Eryngium*), the globe thistle (*Echinops ritro*), the Oriental poppy (*Papaver orientale*), the sea lavender (*Statice latifolia*), *Senecio pulcher*, &c. The sea-kale and horseradish require to be treated in the open garden, where the cut portions should be planted in lines in well-worked soil; but the roots of the others should be planted in pots and kept in a close frame with a little warmth till the young shoots have started.

Various hardy ornamental trees are also increased in this way, as the quince, elm, robinia and mulberry, and the rose amongst shrubs. The most important use to which this mode of propagation is put is, however, the increase of roses, and of the various plums used as stocks for working the choicer stone fruits. The method in the latter case is to select roots averaging the thickness of the little finger, to cut these into lengths of about 3 or 4 in., and to plant them

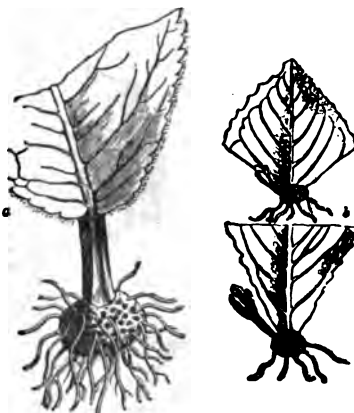

FIG. 23.—Leaf Cuttings.



FIG. 24.—Leaf-Propagation of *Begonia*.

In lines just beneath the surface in nursery beds. The root cuttings of rose-stocks are prepared and treated in a similar way.

15. *By Cuttings of Single Eyes.*—This mode of propagation is by cutting the ripened young branches into short lengths, each containing one well-matured bud or eye, with a short portion of the stem above and below.



FIG. 25.—Cutting of Single Eye.

It is a common mode of propagating vines, the eyes being in this case cut from the ripened leafless wood. The eyes (fig. 25, a) are planted just below the surface in pots of light soil, which are placed in a hot bed or propagating pit, and in due time each pushes up a young shoot which forms the future stem, while from about its base the young roots are produced (fig. 25, b) which convert it into an independent plant. In the case of plants with persistent leaves, the stem may be cut through just above and below the bud, retaining the leaf which is left on the cutting, the old wood and eye being placed beneath the soil and the leaf left exposed. In this way the india-rubber tree (*Ficus elastica*), for example, and many other tender plants may be increased with the aid of a brick bottom heat. Many of the free-growing soft-wooded plants may also be grown from cuttings of single joints of the young wood, where rapid increase is desired; and in the case of opposite-leaved plants two cuttings may often be made from one joint by splitting the stem longitudinally, each cutting consisting of a leaf and a perfect bud attached to half the thickness of the stem.

Planting and Transplanting.—In preparing a fruit tree for transplantation, the first thing to be done is to open a trench round it at a distance of from 3 to 4 ft., according to size. The trench should be opened to about two spades' depth, and any coarse roots which may extend thus far from the trunk may be cut clean off with a sharp knife. The soil between the trench and the stem is to be reduced as far as may seem necessary or practicable by means of a digging fork, the roots as soon as they are liberated being fixed on one side and carefully preserved. By working in this way all round the ball, the best roots will be got out and preserved, and the ball lightened of all superfluous soil. The tree will then be ready to lift if carefully prised up from beneath the ball, and if it does not lift readily, it will probably be found that a root has struck downwards, which will have to be sought out and cut through. Whenever practicable, it is best to secure a ball of earth round the roots. On the tree being lifted from its hole the roots should be examined, and all which have been severed roughly with the spade should have the ends cut smooth with the knife to facilitate the emission of fibres. The tree can then be transported to its new position. The hole for its reception should be of sufficient depth to allow the base of the ball of earth, or of the roots, to stand so that the point whence the uppermost roots spring from the stem may be 2 or 3 in. below the general surface level. Then the bottom being regulated so as to leave the soil rather highest in the centre, the plant is to be set in the hole in the position desired, and steadied there by hand. Next the roots from the lower portion of the ball are to be sought out and laid outwards in lines radiating from the stem, being distributed equally on all sides as nearly as this can be done; some fine and suitable good earth should be thrown amongst the roots as they are thus being placed, and worked in well up to the base of the ball. The soil covering the roots may be gently pressed down, but the tree should not be pulled up and down, as is sometimes done, to settle the soil. This done,

another set of roots higher up the ball must be laid out in the same way, and again another, until the whole of the roots, thus carefully laid, are embedded as firmly as may be in the soil, which may now receive another gentle treading. The stem should next be supported permanently, either by one stake or by three, according to its size. The excavation will now be filled up about two-thirds perhaps; and if so the tree may have a thorough good watering, sufficient to settle the soil closely about its roots. After twenty-four hours the hole may be levelled in, with moderate treading, if the water has soaked well in, the surface being left level and not sloping upwards towards the stem of the tree. In transplanting trees of the ornamental class, less need be attempted in respect to providing new soil, although the soil should be made as congenial as practicable. Generally speaking, fruit trees are best transplanted when three or four years of age, in which time they will have acquired the shape given by the nurseryman, who generally transplants his stock each autumn to produce large masses of root fibres. Nowadays, however, quite large trees, chiefly of an ornamental character, and perhaps weighing several tons, are lifted with a large ball of soil attached to the roots, by means of a special tree-lifting machine, and are readily transferred from one part of the garden to another, or even for a distance of several miles, without serious injury. The best season for transplanting deciduous trees is during the early autumn months. As regards evergreen opinions are divided, some preferring August and September, others April or May. They can be successfully planted at either period, but for subjects which are at all difficult to remove the spring months are to be preferred.

In transplanting smaller subjects, such as plants for the flower garden, much less effort is required. The plant must be lifted with as little injury to its rootlets as possible, and carefully set into the hole, the soil being filled in round it, and carefully pressed close by the hand. For moving small plants the garden trowel is a very convenient tool, but we are inclined to give the preference to the hand-fork. For larger masses, such as strong-growing herbaceous plants, a spade or digging-fork will be requisite and the soil may be trodden down with the feet.

When seedlings of vigorous plants have to be "pricked out," a dibble or dibber is the best implement to be used. The ground being prepared and, if necessary, enriched, and the surface made fine and smooth, a hole is made with the dibble deep enough and large enough to receive the roots of the seedling plants without doubling them up, and the hole is filled in by working the soil close to the plant with the point of the dibble. The pricking out of seedlings in pots in the propagating pit is effected in a similar way. The plants, indeed, often require to be removed and set from $\frac{1}{2}$ in. to 1 in. apart before they have become sufficiently developed to admit of being handled with any degree of facility, and for these a pointed stick of convenient size is used as a dibble. In delicate cases, such as seedling gloxinias and begonias, it is best to lift the little seedling on the end of a flattish pointed stick, often cleft at the apex, pressing this into the new soil where the plant is to be placed, and liberating it and closing the earth about it by the aid of a similar stick held in the other hand.

Potting and Repotting.—Garden pots are made with a comparatively large hole in the bottom, and those of the largest size have also holes at the side near the bottom; these openings are to prevent the soil becoming saturated or soured with superabundant water. To prepare the pot for the plant, a broadish piece of potsherd, called a "crock," is placed over the large hole, and if there be side holes they also are covered. The bottom crock is made from a piece of a broken garden pot, and is laid with the convex side upwards; then comes a layer of irregular pieces of crock of various sizes, about 1 in. deep in a 5-in. pot, 2 in. in an 11-in. or 12-in. pot, &c. The mode of crocking a pot is shown in fig. 26. A few of the coarser lumps from the outer

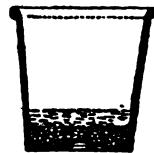

FIG. 26.—Section of Pot showing Crock.

edge of the heap of potting soil are spread over the crocks. The same end, that of keeping the finer particles of the soil from mixing with the drainage crocks, may be attained by shaking in a little clean moss. A handful or two of the soil is then put in, and on this the plant with its roots spread out is to be set, a trifle higher than the plant should stand in the pot when finished off; more soil is to be added, and the whole pressed firmly with the fingers, the base of the stem being just below the pot-rim, and the surface being smoothed off so as to slope a little outwards. When finished off, the pots should be watered well, to settle the soil; but they should stand till the water has well drained away, since, if they are moved about while the fresh soil is very wet, there will be a risk of its becoming puddled or too much consolidated: Larger plants do not need quite such delicate treatment, but care should be taken not to handle the roots roughly. The soil for these may be somewhat coarser, and the amount of drainage material more ample. Larger bodies of soil also require to be more thoroughly consolidated before watering; otherwise they would settle down so as to leave an unsightly void at the pot-rim.

Some plants, especially when potted temporarily, may be dealt with in a simpler way. A single crock may be used in some cases, and in others no-crock at all, but a handful of half-decayed leaves or half-decayed dung thrown into the bottom of the pot. This mode of potting does well for bulbs, such as hyacinths, which are either thrown away or planted out when the bloom is over. The bedding plants generally may be potted in this way, the advantage being that at planting-out time there is less risk of disturbing the roots than if there were potsherds to remove. Plants of this character should be potted a little less firmly than specimens which are likely to stand long in the pot, and indeed the soil should be made comparatively light by the intermixture of leaf-mould or some equivalent, in order that the roots may run freely and quickly into it.

For epiphytal plants like orchids the most thorough drainage must be secured by the abundant use of potsherds, small pots being sometimes inserted inside the larger ones, or by planting in shallow pots or pans, so that there shall be no large mass of soil to get consolidated. For most of these the lightest spongy but sweet turfy peat must be used, this being packed lightly about the roots, and built up above the pot-rim, or in some cases freely mixed before use with chopped sphagnum moss and small pieces of broken pots or nodules of charcoal. The plants under these conditions often require to be supported by wooden pegs or sticks. Some of the species grow better when altogether taken out of the soil and fixed to blocks of wood, but in this case they require a little coaking with moss about the roots until they get established. In other cases they are planted in open baskets of wood or wire, using the porous peat and sphagnum compost. Both blocks and baskets are usually suspended from the roof of the house, hanging free, so that no accumulation of water is possible. These conditions of orchid-growing have undergone great changes of late years, and the plants are grown much as other stove and greenhouse plants in ordinary pots with composts not only of peat but of leaf-mould, and fibres from osmunda and polypodium ferns.

When repotting is adopted as a temporary expedient, as in the case of bedding-out plants which it is required to push forward as much as possible, it will suffice if provision is made to prevent the drainage hole from getting blocked, and a rich light compost is provided for the encouragement of the roots. When, however, a hard-wooded plant has to be repotted, the case is different; it may stand without further potting for one year or two years or more, and therefore much more care is necessary. The old ball of earth must be freed from all or most of the old crocks without doing injury to the roots, and the sharp edge of the upper surface gently rubbed off. If there be any sour or sodden or effete soil into which the roots have not run, this should be carefully picked out with a pointed stick. The ball is to be set on the new soil just high enough that when finished the base of the stem may be somewhat below the pot-rim, and the space between the old ball and the sides of the pot is to

be filled in gradually with the prepared compost, which is from time to time to be pressed down with a blunt-ended flat piece of wood called a potting-stick, so as to render the new soil as solid as the old. The object of this is to prevent the plant from starving by the water applied all running off by way of the new soil, and not penetrating the original ball of earth. When this amount of pressure is necessary, especially in the case of loamy composts, the soil itself should be rather inclined to dryness, and should in no case be sufficiently moist to knead together into a pasty mass. In ordinary cases the potting soil should be just so far removed from dryness that when a handful is gently pressed it may hang together, but may lose its cohesion when dropped.

When plants are required to stand in ornamental china pots or vases, it is better, both for the plants and for avoiding risk of breakage, to grow them in ordinary garden pots of a size that will drop into the more valuable vessels. Slate pots or tubs, usually square, are sometimes adopted, and are durable and otherwise unobjectionable, only, their sides being less porous, the earth does not dry so rapidly, and some modification of treatment as to watering is necessary. For large conservatory specimens wooden tubs, round or square, are frequently used; these should be coated with pitch inside to render them more durable.

Various other contrivances take the place of garden pots for special purposes. Thus shallow square or oblong wooden boxes, made of light, inexpensive wood, are very useful for seed-sowing, for pricking out seedlings, or for planting cuttings. When the disturbance of the roots incidental to all transplanting is sought to be avoided, the seed or plant is started in some cases in squares of turf (used grassy-side downwards), which can when ready be transferred to the place the plant is to occupy. Cucumber and melon plants and vines reared from eyes are sometimes started in this way, both for the reason above mentioned and because it prevents the curling of the roots apt to take place in plants raised in pots. Strips of turf are sometimes used for the rearing of early peas, which are sown in a warmish house or frame, and gradually hardened so as to bear exposure before removal to the open air.

Watering.—The guiding principle in watering plants is to do it thoroughly when it is required, and to abstain from giving a second supply till the first has been taken up.

When watering becomes necessary for kitchen-garden crops, the hose should be laid on and the lines of euculents allowed to drink their fill, if fresh succulent vegetables are desired. So also, if well-swelled and luscious fruits, such as strawberries, are required, there must be no parching at the roots. This applies even more strongly to conservatory borders and to forcing-houses than to the outside fruit-tree borders, because from these the natural rain supply is in most cases more distinctly cut off. In the case of forcing-houses, the water should be heated before being applied to the borders containing the roots of the trees.

In the watering of pot plants the utmost care is requisite if the plant be a shy-growing or valuable one, and yet it is almost impossible to give any intelligible instruction for performing the operation. The roots should never be suffered either to get thoroughly dry or to get sodden with excess of water. An adept will know by the ring of the pot on striking it with his knuckles whether water is wanted or not, according as it rings loud and clear or dull and heavy. With very choice subjects watering may be necessary two or three times a day in drying summer weather. It is a wrong though common practice to press the surface of the soil in the pot in order to feel if it is moist enough, as this soon consolidates it, and prevents it from getting the full benefit of aeration.

In all heated houses the water used should be warmed at least up to the temperature of the atmosphere, so as to avoid chilling the roots. This is also necessary in the case of water used for syringing the plants, which should be done two or three times a day in all stoves and forcing-houses, especially during the period when the young growth is being developed. The damping of all absorbent surfaces, such as the floors or bare walls, &c., is frequently necessary several times a day in the growing season, so as to keep up a humid atmosphere; hence

the advantage of laying the floors a little rounded, as then the water draws off to the sides against the kerbstone, while the centre remains dry for promenaders.

In cooler structures it becomes necessary in the dull season of the year to prevent the slopping of water over the plants or on the floor, as this tends to cause "damping off,"—the stems assuming a state of mildewy decay, which not infrequently, if it once attacks a plant, will destroy it piece by piece. For the same reason cleanliness and free ventilation under favourable weather conditions are of great importance.

Pruning.—Pruning is a very important operation in the fruit garden, its object being twofold—(1) to give form to the tree, and (2) to induce the free production of flower buds as the precursors of a plentiful crop of fruit. To form a standard tree, either the stock is allowed to grow up with a straight stem, by cutting away all side branches up to the height required, say about 6 ft., the scion or bud being worked at that point, and the head developed therefrom; or the stock is worked close to the ground, and the young shoot obtained therefrom is allowed to grow up in the same way, being pruned in its progress to keep it single and straight, and the top being cut off when the desired height is reached, so as to cause the growth of lateral shoots. If these are three or four in number, and fairly balanced as to strength and position, little pruning will be required. The tips of unripened wood should be cut back about one-third their length at an outwardly placed bud, and the chief pruning thereafter required will be to cut away inwardly directed shoots which cross or crowd each other and tend to confuse the centre of the tree. Bushy heads should be thinned out, and those that are too large cut back so as to remodel them. If the shoots produced are not sufficient in number, or are badly placed, or very unequal in vigour, the head should be cut back moderately close, leaving a few inches only of the young shoots, which should be pruned back to buds so placed as to furnish shoots in the positions desired. When worked at the top of a stem formed of the stock, the growth from the graft or bud must be pruned in a similar way. Three or four leading shoots should be selected to pass ere long into boughs and form a well-balanced framework for the tree; these boughs, however, will soon grow beyond any artificial system the pruner may adopt.

To form a dwarf or bush fruit tree the stock must be worked near the ground, and the young shoot produced from the scion or bud must be cut back to whatever height it is desired the dwarf stem to be, say 1½ to 2 ft. The young shoots produced from the portion of the new wood retained are to form the framework of the bush tree, and must be dealt with as in the case of standard trees. The growth of inwardly directed shoots

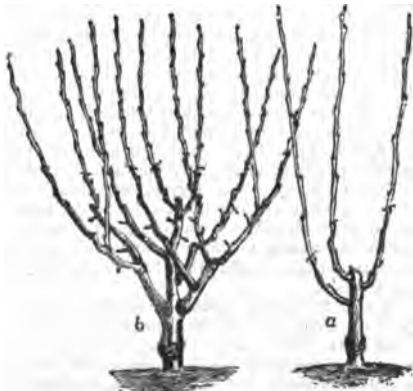

FIG. 27.—Dwarf-Tree Pruning.

is to be prevented, and the centre kept open, the tree assuming a cup-shaped outline. Fig. 27, reduced from M. Hardy's

excellent work, *Traité de la taille des arbres fruitiers*, will give a good idea how these dwarf trees are to be manipulated, a showing the first year's development from the maiden tree after being headed back, and b the form assumed a year or two later.

In forming a pyramidal tree, the lateral growths, instead of being removed, as in the standard tree, are encouraged to the utmost; and in order to strengthen them the upper part of the leading shoot is removed annually, the side branches being also shortened somewhat as the tree advances in size. In fig. 28, reduced from M. Hardy's work, a shows a young

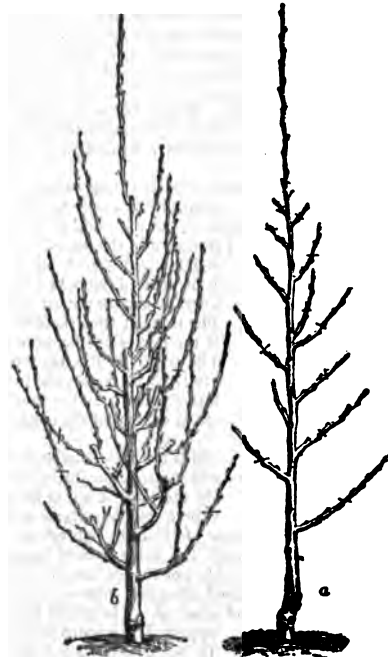

FIG. 28.—Pyramid Pruning.

tree with its second year's growth, the upright shoot of the maiden tree having been moderately headed back, being left longer if the buds near the base promise to break freely, or cut shorter if they are weak and wanting in vigour. The winter pruning, carried out with the view to shape the tree into a well-grown pyramid, would be effected at the places marked by a cross line. The lowest branch would have four buds retained, the end one being on the lower side of the branch. The two next would be cut to three buds, which here also are fortunately so situated that the one to be left is on the lower side of the branches. The fourth is not cut at all owing to its shortness and weakness, its terminal bud being allowed to grow to draw strength into it. The fifth is an example where the bud to which the shoot should be cut back is badly placed; a shoot resulting from a bud left on the upper side is apt instead of growing outwards to grow erect, and lead to confusion in the form of the tree; to avoid this it is tied down in its proper place during the summer by a small twig. The upper shoots are cut closer in. Near the base of the stem are two prominent buds, which would produce two vigorous shoots, but these would be too near the ground, and the buds should therefore be suppressed; but, to strengthen the lower part, the weaker buds just above and below the lowest branch should be forced into growth, by making a transverse incision close above each. Fig. 28, b, shows what a similar tree would be at the end of the third year's growth.

In order to bring a young tree into the cordon shape, all its side branches are shortened back, either to form permanent spurs, as in the case of pears, or to yield annual young shoots, as in peaches and nectarines. The single-stemmed cordon may be trained horizontally, obliquely at any required angle, or vertically if required, the first two arrangements being preferable. If a double cordon is required, the original young stem must be headed back, and the two best shoots produced must be selected, trained right and left, and treated as for the single cordon.

The forms chiefly adopted for trees trained to walls and espalier rails are the fan-shaped, the half-fan and the horizontal, with their various modifications.

The maiden tree is headed down, and two shoots led away right and left. Two laterals should be allowed to grow from the upper side of them, one from near the base, the other from near the middle, all others being pinched out beyond the second or third leaf during summer, but cut away to the last bud in winter. The tree will thus consist of six shoots, probably 3 ft. to 4 ft. long, which are not to be pruned unless they are unequal in strength, a defect which is rather to be remedied by summer pinching than by winter pruning. The second year three young shoots are to be left on each of the six, one close to the base, one about the middle, and one at the point, the rest being rubbed off. These three shoots will produce laterals, of which one or two may be selected and laid in; and thus a number of moderately strong fertile shoots will be obtained, and at the end of the season a comparatively large tree will be the result.

The method of pruning formerly adopted for the formation of a fan-shaped tree was to head down the maiden plant to about two eyes, so placed as to yield a young shoot on each side (fig. 29), the supernumerary shoots being rubbed off while quite young, and the reserved shoots trained against the wall



FIG. 29.—Pruning for Fan-shaped Tree.

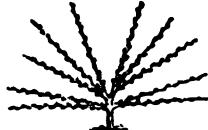

FIG. 30.—The same—third year.

during the summer so as to get them well matured. The next year they were cut back again, often nearly to the base, in order that the lower pair of these shoots might each produce two well-placed young shoots, and the upper pair three young shoots. The tree would thus consist of ten shoots, to be laid out at regular distances, and then if closely cut the framework of the tree would be as in fig. 30. These main shoots were not again to be shortened back, but from each of them three young shoots were to be selected and trained in two, on the upper side, one near the base, and the other halfway up, and one on the lower side placed about midway between these two; these with the leading shoot, which was also to be nailed in, made four branches of the current year from each of the ten main branches, and the form of the tree would therefore be that of fig. 31. The

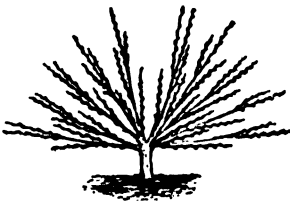

FIG. 31.—The same—fourth year.

were to be shortened, and from these year by year other shoots were to be selected to fill up the area occupied by the tree.

other young shoots produced were pinched off while quite young, to throw all the strength of the tree into those which were to form its basis, and to secure abundant light and air. In after years the leading shoot was not to be cut back, but all the lateral shoots

In pruning for a horizontal tree the young maiden tree has to be headed back nearly to its base, and from the young shoots three are to be selected, the two best-placed lower ones to form an opposite or nearly opposite pair of main branches, and the best-placed upper one to continue the erect stem (fig. 32). This upper shoot is at the next winter pruning to be cut down to within about a foot of the point whence it sprung, and its buds rubbed off except the upper one for a leader, and one on each side just below it to furnish another pair of side shoots; these being trained in position, the tree would appear as in fig. 33.



FIG. 32.—Pruning for Horizontally trained Tree.



FIG. 33.—The same—third year.

The same course is to be followed annually till the space is filled. Sometimes in very favourable soils and with vigorous trees two pairs of branches may be obtained in one season by summer-stopping the erect shoots and selecting others from the young growths thus induced, but more commonly the trees have to be built up by forming one pair of branches annually. The shoots are not at first lowered to the horizontal line, but are brought down gradually and tied to thin stakes; and while the tree is being formed weak shoots may be allowed to grow in a more erect position than it is ultimately intended they should occupy. Thus in four or five years the tree will have

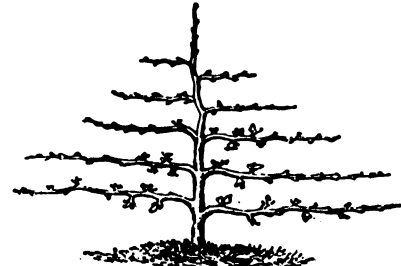

FIG. 34.—The same—fifth year.

acquired something of the character of fig. 34, and will go on thus increasing until the space is filled.

The half-fan is a combination of the two forms, but as regards pruning does not materially differ from the horizontal, as two opposite side branches are produced in succession upwards till the space is filled, only they are not taken out so abruptly, but are allowed to rise at an acute angle and then to curve into the horizontal line.

In all the various forms of cordons, in horizontal training, and in fan and half-fan training, the pruning of the main branches when the form of the tree is worked out will vary in accordance with the kind of fruit under treatment. Thus in the peach, nectarine, apricot, plum and cherry, which are commonly trained fan-fashion, the first three (and also the morello cherry if grown) will have to be pruned so as to keep a succession of young annual shoots, these being their fruit-bearing wood. The others are generally pruned so as to combine a moderate supply of young wood with a greater or less number of fruit spurs. In the pear and apple the fruit is borne principally on spurs, and hence what is known as spur-pruning has to be adopted, the young shoots being all cut back nearly to their base, so as to cause fruit buds to evolve from the remaining eyes or buds. Cordons of apples and pears have to be similarly treated, but cordons of peaches and nectarines are pruned so as to provide the necessary annual succession of young bearing wood.

Fruit trees trained as espaliers, fans or cordons against walls, trellises or fences, are not only pruned carefully in the winter but must be also pruned during the early summer months. Many of the smaller, useless shoots are rubbed out altogether; the best are allowed to grow perhaps a foot or more in length, and then either have the tips pinched out with the finger and thumb, or the ends may be cracked or broken, and allowed to hang down, but are not detached completely. This is called summer pruning, and is an important operation requiring knowledge on the part of the gardener to perform properly. Shoots of peaches, nectarines and morello cherries are "laid in," that is, placed in between fruiting shoots where there is the space to be ripened for next year's crop.

Summer Pruning should be performed while the shoots are yet young and succulent, so that they may in most cases be nipped off with the thumb-nail. It is very necessary in the case of trees trained to a flat surface, as a wall or espalier rail, to prevent undue crowding. In some cases, as, for example, with peaches, the superfluous shoots are wholly removed, and certain selected shoots reserved to supply bearing wood for next year. In others,

as pears, the tops of the young shoots are removed, leaving three or four leaves and their buds at the base, to be developed into fruit buds by the additional



FIG. 35.—Summer Pruning for Spurs.

if the lowermost only go to the formation of a fruit spur, the object will have been gained. They are cut to the last dormant bud in winter.

But summer pruning has been much extended since the introduction of restricted growth and the use of dwarfing stocks. Orchard-house trees, and also pyramidal and bush trees of apples, pears and plums, are mainly fashioned by summer pruning; in fact, the less the knife is used upon them, except in the necessary cutting of the roots in potted trees, the better. In the case of orchard-house plants no shoots are suffered to lengthen out, except as occasionally wanted to fill up a gap in the outline of the tree. On the contrary, the tops of all young shoots are pinched off when some three or four leaves are formed, and this is done again and again throughout the season. When this pruning is just brought to a balance with the vigour of the roots, the consequence is that fruit buds are formed all over the tree, instead of a thicket of sterile and useless wood. Pyramidal and bush trees out of doors are, of course, suffered to become somewhat larger, and sufficient wood must be allowed to grow to give them the form desired; but after the first year or two, when the framework is laid out, they are permitted to extend very slowly, and never to any great extent, while the young growths are continually nipped off, so as to clothe the branches with fruit buds as closely placed as will permit of their healthy development.

The nature of the cut itself in pruning is of more consequence, especially in the case of fruit trees, than at first sight may appear. The branches should be separated by a clean cut at an angle of about 45°, just at the back of a bud, the cut entering on a level with the base of the bud and passing out on a level with its top (fig. 36, *a*), for when cut in this way the wound becomes rapidly covered with new wood, as soon as growth recommences, whereas if the cut is too close the bud is starved, or if less close an ugly and awkward snag is left. Fig 36, *b* and *c*, are examples of the former, and *d*, *e*, *f* of the latter. In fact there is only one right way to cut a shoot and that is as shown at *a*.

The Pruning of flowering plants is generally a much lighter matter than the pruning of fruit trees. If a young seedling or cutting of any soft-wooded plant is to be bushy it must have

its top nipped out by the thumb-nail or pruning-scissors at a very early stage, and this stopping must be repeated frequently. If what is called a well-furnished plant is required, an average of from 2 to 3 in. is all the extension that must be permitted—



FIG. 36.—Cuts—Good and Bad.

sometimes scarcely so much—before the top is nipped out; and this must be continued until the desired size is attained, whether that be large or small. Then generally the plant is allowed to grow away till bloom or blooming shoots are developed. To form a pyramidal plant, which is a very elegant and useful shape to give to a decorative pot plant, the main stem should be encouraged to grow upright, for a length perhaps of 6 or 8 in. before it is topped; this induces the formation of laterals, and favours their development. The best-placed upper young shoot is selected and trained upright to a slender stake, and this also is topped when it has advanced 6 or 8 in. further, in order to induce the laterals on the second portion to push freely. This process is continued till the required size is gained. With all the difficult and slow-growing plants of the hard-wooded section, all the pruning must be done in this gradual way in the young wood as the plant progresses.

Some plants, like pelargoniums, can only be kept handsomely formed and well furnished by cutting them down severely every season, after the blooming is over. The plants should be prepared for this by keeping them rather dry at the root, and after cutting they must stand with little or no water till the stems heal over, and produce young shoots, or "break," as it is technically termed. The appearance of a specimen pelargonium properly pruned is shown in fig. 37, in which *a* shows a young plant, the head of which has been taken off to form a cutting, and whose buds are ready to break into young shoots. Three shoots will be produced, and these, after growing from 4 to 6 in. in length,



FIG. 37.

should be stopped by pinching out the point, this giving rise to lateral shoots. These will blossom in due course, and, after being ripened thoroughly by full exposure to the sun, should be cut back as shown at *b*. This is the proper foundation for a good specimen, and illustrates how all such subjects should be pruned to keep them stocky and presentable in form.

Root-pruning is most commonly practised in fruit-tree cultivation. It is often resorted to as a means of restoring fertility in plants which have become over rank from an excess of nourishment in the soil, or sterile from want of it. The effect of root-pruning in the first case is to reduce the supply of crude sap to the branches, and consequently to cause a check in their development. In the second case all roots that have struck downwards into a cold uncongenial subsoil must be pruned off if they cannot be turned in a lateral direction, and all the lateral ones that have become coarse and fibreless must also be shortened back by means of a clean cut with a sharp knife, while a compost of rich loamy soil with a little bone-meal, and leaf-mould or old manure, should be filled into the trenches from which the old sterile soil has been taken. The operation is best performed early in autumn, and may be safely resorted to in the case of fruit trees

of moderate age, and even of old trees if due care be exercised. In transplanting trees all the roots which may have become better or broken in the process of lifting should be cut clean away behind the broken part, as they then more readily strike out new roots from the cut parts. In all these cases the cut should be a clean sloping one, and made in an upward and outward direction.

The root-pruning of pot-plants is necessary in the case of many soft-wooded subjects which are grown on year after year—pelargoniums and fuchsias, for example. After the close pruning of the branches to which they are annually subjected, and when the young shoots have shot forth an inch or two in length, they are turned out of their pots and have the old soil shaken away from their roots, the longest of which, to the extent of about half the existing quantity, are then cut clean away, and the plants repotted into small pots. This permits the growing plant to be fed with rich fresh soil, without having been necessarily transferred to pots of unwieldy size by the time the flowering stage is reached.

Ringing.—One of the expedients for inducing a state of fruitfulness in trees is the ringing of the branches or stem, that is, removing a narrow annular portion of the bark, by which means, it is said, the trees are not only rendered productive, but the quality of the fruit is at the same time improved. The advantage depends on the obstruction given to the descent of the sap. The ring should be cut out in spring, and be of such a width that the bark may remain separated for the season. A tight ligature of twine or wire answers the same end. The advantages of the operation may generally be gained by judicious root pruning, and it is not at all adapted for the various stone fruits.

Training.—What is called training is the guiding of the branches of a tree or plant in certain positions which they would not naturally assume, the object being partly to secure their full exposure to light, and partly to regulate the flow and distribution of the sap. To secure the former object, the branches must be so fixed as to shade each other as little as possible; and

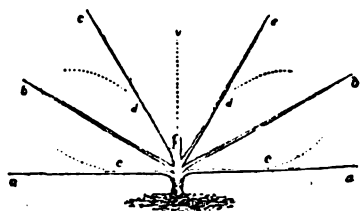

FIG. 38.—Diagram illustrating Branch Distribution.

to realize the second, the branches must have given to them an upward or downward direction, as they may require to be encouraged or repressed. Something of the same vegetative vigour which is given to a plant or tree by hard pruning is afforded by training in an upward direction so as to promote the flow of the sap; while the repression effected by summer pruning is supplemented by downward training, which acts as a check. One main object is the preservation of equilibrium in the growth of the several parts of the tree; and for this various minor details deserve attention. Thus a shoot will grow more vigorously whilst waving in the air than when nailed close to the wall; consequently a weak shoot should be left free, whilst its stronger antagonist should be restrained; and a luxuriant shoot may be retarded for some time by having its tender extremity pinched off to allow a weaker shoot to overtake it.

By the prudent use of the knife, fruit trees may be readily trained into the forms indicated below, which are amongst the best out of the many which have been devised.

The training of standard and bush trees in the open ground has been already referred to under the section *Pruning*. When the growth of pyramids is completed, the outline is something like that of fig. 39, and very pretty trees are thus formed. It is better, however, especially if the tendency to bear fruit is rather slack, to adopt what the French call *en quenouille* training

(fig. 40), which consists in tying or weighting the tips of the branches so as to give them all a downward curve. Pear trees

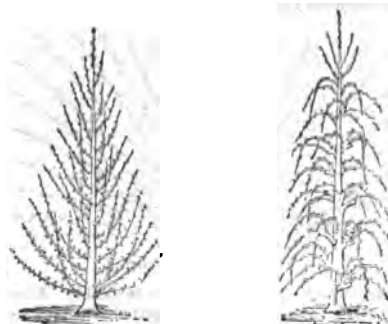

FIG. 39.—Pyramidal Training. FIG. 40.—Training *en quenouille*.

worked on the quince stock, and trained *en quenouille*, are generally very fertile.

Wall trees, it must be evident, are placed in a very unnatural and constrained position, and would in fact soon be reduced to a state of utter confusion if allowed to grow unrestricted; hence the following modes of training have been adopted.

Horizontal Training (fig. 41) has long been a favourite form in England. There is one principal ascending stem, from which

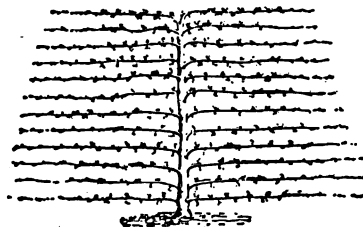

FIG. 41.—Horizontal Training.

the branches depart at right angles, at intervals of about a foot. Horizontal training is best adapted to the apple and the pear; and for the more twiggy growing slender varieties, the forms shown in fig. 42 have been recommended. In these the horizontal branches are placed wider, 18 to 20 in. apart, and the smaller shoots are trained between them, either on both sides, as at *a*, or deflexed from the lower side, as at *b*. The latter is an excellent method of reclaiming neglected trees. Every alternate

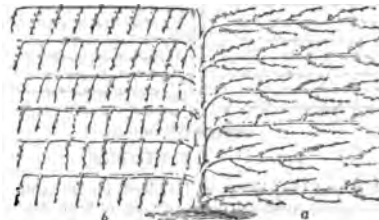

FIG. 42.—Forms of Horizontal Training.

branch should be taken away, and the spurs cut off, after which the young shoots are trained in, and soon produce good fruit.

In **Fan Training** (fig. 43) there is no leading stem, but the branches spring from the base and are arranged somewhat like the ribs of a fan. This mode of training is commonly adopted for the peach, nectarine, apricot and morello cherry, to which

it is best adapted. Though sometimes adopted, it is not so well suited as the horizontal form for apples and pears, because, when the branches reach the top of the wall, where they must



FIG. 43.—Fan Training.

be cut short, a hedge of young shoots is inevitable. A modification of the fan shape (fig. 44) is sometimes adopted for stone fruits, such as the plum and apricot. In this the object is to establish a number of mother branches, and on these to form a series of subordinate members, chiefly composed of bearing wood. The mother branches or limbs should not be numerous, but well marked, equal in strength and regularly disposed. The

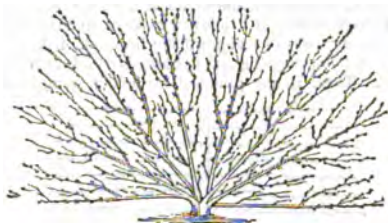

FIG. 44.—Modified Fan Training.

side branches should be pretty abundant, short and not so vigorous as to rival the leading members.

The *Half-fan* mode of training, which is intermediate between horizontal and fan training, is most nearly allied to the former, but the branches leave the stem at an acute angle, a disposition supposed to favour the more equal distribution of the sap. Sometimes, as in fig. 45, two vertical stems are adopted, but there is no particular advantage in this, and a single-stemmed tree is more manageable. The half-fan form is well adapted for such fruits

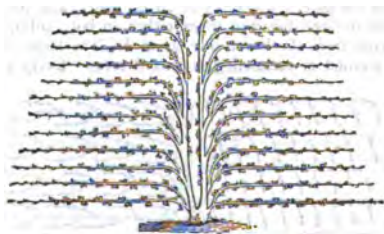

FIG. 45.—Half-Fan Training.

as the plum and the cherry; and, indeed, for fruits of vigorous habit, it seems to combine the advantages of both the foregoing.

Trees must be fixed to the walls and buildings against which they are trained by means of nails and shreds (neat medicated strips are now sold for this purpose), or in cases where it is desired to preserve the wall surface intact, by permanent nails or studs driven in in regular order. Sometimes the walls are furnished with galvanized wires, but this has been objected to as causing cankering of the shoots, for which, however, painting is recommended as a remedy. By crossing the tying material

between the wire and the wood, however, and so preventing them from coming in contact, there is no danger. If they are adopted, the wires should be a few inches away from the wall, to allow free circulation of air between it and the tree, and thus avoid the scorching or burning of leaves and fruits during the summer months in very hot places. Care should be taken that the ties or fastenings do not eventually cut into the bark as the branches swell with increased age. When shreds and nails are used, short thick wire nails and "medicated shreds" are the best; the ordinary cast iron wall nails being much too brittle and difficult to drive into the wall. It must be remembered that nails spoil a wall sooner or later, whereas a wire trellis is not only much neater, but enables the gardener to tie his trees up much more quickly.

For tying plants to trellises and stakes soft tarred string or raffia (the fibre from the *Raphia* palm of Madagascar) is used.

In training greenhouse plants the young branches should be drawn outwards by means of ties fastened to a string or wire



FIG. 46.—Clematis trained on Balloon-Shaped Trellis.

under the pot-rim; the centre then fills up, and slender stakes are used as required; but the fewer these are in number the better. Climbers are trained from the bottom around or across trellises, of which the cylindrical or the balloon-shaped, or sometimes the flat oval or circular, are the best forms. The size should be adapted to the habit of the plant, which should cover the whole by the time flowers are produced. Bast fibre and raffia fibre are to be preferred for light subjects of this character, as they can be split to any degree of fineness. Very durable trellises for greenhouse climbers are made of slender round iron rods for standards, having a series of hooks on the inner edge, into which rings of similar metal are dropped; the rings may be graduated so as to form a broad open top, or may be all of the same size, when the trellis will assume the cylindrical form. Fig. 46 shows a pot specimen of clematis trained over a balloon-shaped trellis.

The training of certain bedding plants over the surface of the soil is done by small pegs of birch wood or bracken, by loops of wire or cheap hair-pins, or sometimes by loops of raffia having the ends fixed in the soil by the aid of the dibble. The object is to fill up the blank space as quickly and as evenly as possible.

Forcing is the accelerating, by special treatment, of the growth of certain plants, which are required to be had in leaf, in flower or in fruit before their natural season,—as, for instance, the leaves of mint at Eastertide or the leafstalks of sea-kale and rhubarb

at Christmas, the flowers of summer in the depth of winter, or some of the choicest fruits perfected so much before their normal period as to complete, with the retarded crops of winter, the circle of the seasons.

In the management of artificial heat for this purpose, a considerable degree of caution is required. The first stages of forcing should, of course, be very gentle, so that the whole growth of the plants may advance in harmony. The immediate application of a very hot atmosphere would unduly force the tops, while the roots remained partially or wholly inactive; and a strong bottom heat, if it did not cause injury by its excess, would probably result in abortive growth.

Any sudden decrease of warmth would be very prejudicial to the progress of vegetation through the successive stages of foliage, inflorescence and fructification. But it is not necessary that one unvarying range of temperature should be kept up at whatever pains or risk. Indeed, in very severe weather it is found better to drop a little from the maximum temperature by fire heat, and the loss so occasioned may be made good by a little extra heat applied when the weather is more genial. Night temperatures also should always be allowed to drop somewhat, the heat being increased again in the morning. In other words, the artificial temperature should increase by day and decrease by night, should rise in summer and fall in winter, should, in short, imitate as nearly as possible the varying influence of the sun.

For the growth of flowers generally, and for that of all fruits, every ray of light to be obtained in the dull winter season is required, and therefore every possible care should be taken to keep the glass clean. A moist genial atmosphere too is essential, a point requiring unremitting attention on account of the necessity of keeping up strong fires. With moisture as with heat, the cultivator must hold his hand somewhat in very severe or very dull weather; but while heat must not drop so as to chill the progressing vegetation, so neither must the lack of moisture parch the plants so as to check their growth.

There are some few subjects which when forced do not require a light house. Thus amongst flowers the white blossoms of the lilac, so much prized during winter, are produced by forcing purple-flowered plants in darkness. Rhubarb and sea-kale among esculents both need to be forced in darkness to keep them crisp and tender, and mushrooms also are always grown in dark structures. In fact, a roomy mushroom house is one of the most convenient of all places for forcing the vegetables just referred to. The lilac would be better placed in a dark shed heated to about 70° or 80°, in which some dung and leaves could be allowed to lie and ferment, giving off both a genial heat and moisture.

One of the most important preliminaries to successful forcing is the securing to the plants a previous state of rest. The thorough ripening of the preceding season's wood in fruit trees and flowering plants, and of the crown in perennial herbs like strawberries, and the cessation of all active growth before the time they are to start into a new growth, are of paramount importance. The ripening process must be brought about by free exposure to light, and by the application of a little extra heat with dryness, if the season should be unfavourable; and both roots and tops must submit to a limitation of their water supply. When the ripening is perfected, the resting process must be aided by keeping the temperature in which they await the forcing process as low as each particular subject can bear. (See *Retardation* above.)

V. Flowers.

Flower Garden and Pleasure Grounds.—Wherever there is a flower garden of considerable magnitude, and in a separate situation, it should be constructed on principles of its own. The great object must be to exhibit to advantage the graceful forms and glorious hues of flowering plants and shrubs. Two varieties of flower gardens have chiefly prevailed in Britain. In one the ground is turf, out of which flower-beds, of varied patterns, are cut; in the other the flower-beds are separated

by gravel walks, without the introduction of grass. When the flower garden is to be seen from the windows, or any other elevated point of view, the former is to be preferred; but where the surface is irregular, and the situation more remote, and especially where the beauty of flowers is mainly looked to, the choice should probably fall on the latter.

The flower garden may include several different compartments. Thus, for example, there is the "Rock Garden," which should consist of variously grouped masses of large stones, those which are remarkable for being figured by water-wearing, or containing petrifications or impressions, or showing something of natural stratification, being generally preferred. In the cavities between the stones, filled with earth, alpine or trailing plants are inserted, and also some of the choicest flowers. In proper situations, a small pool of water may be introduced for the culture of aquatic plants. In these days the rock-garden is a most important feature, and it requires a good deal of care and skill to arrange the boulders, walks, pools or streams in natural and artistic fashion. The selection of suitable alpines, perennials and shrubs and trees also necessitates considerable knowledge on the part of the gardener. A separate compartment laid out on some regular plan is often set apart for roses, under the name of the "Rosery." A moist or rather a shady border, or a section of the pleasure ground supplied with bog earth, may be devoted to what is called the "American Garden," which, as it includes the gorgeous rhododendrons and azaleas, forms one of the grandest features of the establishment during the early summer, while if properly selected the plants are effective as a garden of evergreens at all seasons. The number of variegated and various-coloured hardy shrubs is now so great that a most pleasant plot for a "Winter Garden" may be arrayed with plants of this class, with which may be associated hardy subjects which flower during that season or very early spring, as the Christmas rose, and amongst bulbs the crocus and snowdrop. Later the spring garden department is a scene of great attraction; and some of the gardens of this character, as those of Cliveden and Belvoir, are among the most fascinating examples of horticultural art. The old-fashioned stereotyped flower garden that one met with almost everywhere is rapidly becoming a thing of the past, and grounds are now laid out more in accordance with their natural disposition, their climatic conditions and their suitability for certain kinds of plants. Besides the features already mentioned there are now bamboo gardens, Japanese gardens, water gardens and wall gardens, each placed in the most suitable position and displaying its own special features.

Lawns.—In the formation of lawns the ground must be regularly broken up so that it may settle down evenly, any deep excavations that may have to be filled in being very carefully rammed down to prevent subsequent settlement. The ground must also be thoroughly cleared of the roots of all coarse, perennial weeds, and be worked to a fine tilth ready for turving or sowing. The more expeditious method is of course to lay down turf, which should be free from weeds, and is cut usually in strips of 1 ft. wide, 3 ft. long, and about 1 in. in thickness. This must be laid very evenly and compactly, and should then be beaten down firmly with the implement called a turf-beater (fig. 47). When there is a large space to cover, it is much the cheaper plan to sow the lawn with grass-seeds, and equally effective, though the sward takes much longer to thicken. It is of the utmost importance that a good selection of grasses be made, and that pure seeds should be obtained (see GRASS AND GRASSLAND). The following sorts can be recommended, the quantities given being those for sowing an acre of ground:—



FIG. 47.—Turf-Beater.

the front line planted between suitable pieces of stone, or they may be relegated to a particular spot, and placed on an artificial rockery. Most of the hardy bulbs will do well enough in the border, care being taken not to disturb them while leafless and dormant.

Some deep-rooting perennials do not spread much at the surface, and only require refreshing from time to time by top-dressings. Others, as the asters, spread rapidly; those possessing this habit should be taken up every second or third year, and a nice patch being selected for replanting from the outer portions, the rest may be either thrown aside, or reserved for increase; the portion selected for replanting should be returned to its place, the ground having meanwhile been well broken up. Some plants are apt to decay at the base, frequently from exposure caused by the lifting process going on during their growth; these should be taken up annually in early autumn, the soil refreshed, and the plants returned to their places, care being taken to plant them sufficiently deep.

Only a section of some of the best of the decorative hardy perennials can be noted, before we pass on to those popular subjects of this class which have been directly influenced by the hybridizer and improver. Many more might be added to the subjoined list:—

Acæna.—Neat trailing plants adapted for rockwork, thriving in sandy soil. *A. microphylla* and *A. myriophylla* have pretty spiny heads of flowers.

Acantholimon.—Pretty dwarf tufted plants, with needle-shaped leaves, adapted for rockwork. *A. glumacum* and *A. venustum* bear bright pink flowers in July and August. Light sandy loam.

Acanthus.—Bold handsome plants, with stately spikes, 2 to 3 ft. high, of flowers with spiny bracts. *A. mollis*, *A. latifolius*, and *A. longifolius* are broad-leaved sorts; *A. spinosus* and *A. spinosissimus* have narrower spiny toothed leaves.

Achillea.—Handsome composite plants, the stronger ones of easy culture in common soil. *A. Eupatorium* and *flupendula*, 3 to 4 ft., have showy yellow corymbose flowers; *A. rosea*, 2 ft., rosy-cinnamon; and *A. Ptarmica flore-plena*, 2 ft., double white flowers. Others suitable for front lines or rockwork are *A. tomentosa*, 9 in., bright yellow; *A. ascyriaca*, 1 ft., silvery leaves and yellow flowers; *A. umbellata*, 8 in., silvery leaves and white flowers; and *A. Clowenæ*, 6 in., with silvery leaves and pure white flowers.

Aconitum.—Handsome border plants, the tall stems crowned by racemes of showy hooded flowers. *A. Camarum*, 3 to 4 ft., has deep purple flowers in August; *A. sinense*, 1 to 2 ft., has large dark purple flowers in September; *A. variegatum*, 3 ft., has the flowers white edged with blue; *A. autumnale*, 3 ft., has pale blue flowers; *A. Anthora*, 1 to 2 ft., yellow; and *A. japonicum*, 2 ft., deep blue flowers, produced in September and October. *A. Wilsoni*, a new species from China, 6 ft. high, with bluish-purple flowers.

Adenophora.—Bell-shaped flowers. *A. stylosa*, 2 ft., pale blue, elegant; *A. denticulata*, 1½ ft., dark blue; and in *A. lilifolia*, 1½ ft., pale blue, sweet-scented—all blooming during summer. Light soil.

Adonis.—*A. vernalis*, 1 ft., has large bright yellow stellate flowers in April. Deep light soil. *A. amurensis* is a fine Chinese species.

Ajuga.—Free growing, dwarf and showy. *A. reptans*, 8 in., has creeping runners, which *A. genevensis* has not; both bear handsome spikes of blue labiate flowers. Ordinary soil.

Allium.—Hardy bulbs of the garlic family, some species of which are ornamental; the inflorescence is umbellate. In *A. azureum*, 1 to 2 ft., the flowers are deep-blue; in *A. Moly*, 1 ft., golden yellow; in *A. neapolitanum*, 1½ ft., white, very handsome; in *A. triquetrum*, 8 in., white with green central stripes; in *A. padmomanium*, 9 in., reddish-violet, very beautiful, the umbels nodding.

Alistroseria.—Beautiful plants with fleshy tuberous roots, which are the better if not often disturbed. *A. aurantiaca*, 2 to 3 ft., orange streaked with red, in July and August; *A. chilensis*, 2 to 3 ft., blood-red, streaked with yellow, affording many varieties. Deep sandy loam or peat. Should be planted at least 6 or 8 in. deep.

Althæa rosea.—The hollyhock is a noble perennial, 6 to 15 ft. high, with flowers of every colour except blue. Requires rich loamy soil and plenty of space.

Alyssum.—Showy rockwork or front row border plants of easy culture in any light soil; the plants should be frequently renewed from cuttings. *A. saxatile*, with greyish leaves, and deep yellow flowers, produced in April and May, and the dwarfier *A. montanum* are useful.

Amaryllis.—Noble half-hardy bulbs, for planting near the front wall of a hothouse or greenhouse; the soil must be deep, rich and well drained. *A. Belladonna*, the Belladonna Lily, 3 ft., has large funnel-shaped flowers in September, of a delicate rose colour. The variety *A. blanda* has paler flowers, almost white.

Anchusa.—Pretty boraginaceous herbs, easily grown. *A. italica*, 3 to 4 ft., has blue star-like flowers. *A. sempervirens*, 1½ ft., rich blue, is well suited for rough borders.

Androsace.—Pretty dwarf rock plants, requiring rather careful management and a gritty soil. *A. Vivalhana*, yellow; *A. Wulfeniana*, purplish-pink; *A. villosa*, white or pale rose; *A. lactea*, white with yellow eye; *A. lanuginosa*, delicate rose; and *A. Chamæjasme*, delicate rose, are some of the best.

Anemone.—The Japanese kinds, *A. japonica*, flowers white and purple, are very easily grown and are particularly fine in autumn. The scarlet *A. Judgens*, and *A. coronaria*, the poppy anemone, are useful for the front, or in nooks in the rockery; while the common

hepatica (*A. hepatica*) with its bright blue flowers should also have a place.

Antennaria.—Composites plants, with everlasting flowers. *A. margaritacea*, 1½ to 2 ft., has white woolly stems and leaves, and white flower-heads.

Anthriscum.—Charming border flowers. *A. Lillastrum*, St Bruno's Lily, 1½ ft., bears pretty white sweet-scented flowers in May; *A. Hookeri* (*Chrysobactron*), 2 ft., with long racemes of bright golden yellow flowers, requires cool peaty soil.

Aquilegia.—The Columbine family, consisting of beautiful border flowers in great variety, ranging from 1 to 2 or 3 ft. in height. Besides the common purple *A. vulgaris* with its numerous varieties, double and single, there are of choice sorts *A. alpina* and *A. pyrenaica*, blue; *A. glandulosa*, *A. juncunda*, and *A. coerulea*, blue and white; *A. leptoceras*, blue and yellow; *A. canadensis*, *A. Skinneri*, and *A. truncata* (*californica*), scarlet and yellow; *A. chrysantha*, yellow; and *A. fragrans*, white or flesh-colour, very fragrant. Light rich garden soil.

Arabis.—Dwarf close-growing evergreen cruciferous plants, adapted for rockwork and the front part of the flower border, and of the easiest culture. *A. albidia* forms a conspicuous mass of greyish leaves and white blossoms. There is also a charming double variety. *A. lucida*, which is also white-flowered, bears its bright green leaves in rosettes, and has a variety with prettily gold-margined leaves.

Arenaria.—Evergreen rock plants of easy culture. *A. graminifolia* and *A. loricifolia* are tufted, with grassy foliage and white flowers, while *A. balearica*, a creeping rock plant, has tiny leaves and solitary white flowers.

Armeria.—The Thrift or Sea-Pink, of which the common form *A. maritima* is sometimes planted as an edging for garden walks; there are three varieties, the common pale pink; the deep rose, and the white, the last two being the most desirable. *A. cephalotes*, 1½ ft., is a large plant with tufts of linear lance-shaped leaves, and abundant globular heads of deep rose flowers, in June and July.

Asclepias.—*A. tuberosa* is a handsome fleshy-rooted plant, very impatient of being disturbed, and preferring good peat soil; it grows 1 to 1½ ft. high, and bears corymbs of deep yellow and orange flowers in September. *A. incarnata*, 2 to 4 ft., produces deep rose sweet-scented flowers towards the end of summer.

Asperula odorata.—The woodruff, a charming white-flowered plant with leaves in circles. Well adapted for carpeting the border or rockery.

Asphodelus.—Handsome liliaceous plants, with fleshy roots, erect stems, and showy flowers, thriving in any good garden soil. *A. albus*, 4 ft., *A. aestivus*, 4 ft., and *A. ramosus*, 4 ft., have all long tapering keeled leaves, and simple or branched spikes of white flowers; *A. luteus*, 2 ft., has awl-shaped leaves and dense spikes of fragrant yellow flowers; *A. capillaris* is similar to *A. luteus*, but more slender and elegant.

Aster.—A very large family of autumn-blooming composites, including some ornamental species, all of the easiest culture. Of these, *A. alpinus*, 1 ft., and *A. Amellus*, 1½ ft., with its var. *bessarebicus*, have broadish blunt leaves, and large starry bluish flowers; *A. longifolius formosus*, 2 ft., bright rosy lilac; *A. elegans*, 3 to 5 ft., small pale purple or whitish; *A. laxus*, 2 ft., purplish-blue; *A. pendulus*, 2½ ft., white, changing to rose; *A. pyrenaicus*, 2 to 3 ft., lilac-blue; *A. turbinellus*, 2 to 3 ft., mauve-coloured, are showy border plants; and *A. Nova Angliæ*, 5 to 6 ft., rosy-violet; *A. cynensis*, 5 ft., blue-lilac; and *A. grandiflorus*, 3 ft., violet, are especially useful from their late-flowering habit.

Astilbe.—*A. japonica*, 1 to 1½ ft., better known as *Hoteia japonica* or *Spiræa japonica*, thrives in peaty or sandy soil; its glossy tripartite leaves, and feathery panicles of white flowers early in summer, are very attractive. It proves to be a fine decorative pot-plant, and invaluable for forcing during the spring.

Astragalus.—Showy pea-flowered plants, the smaller species adapted for rockwork; sandy soil. *A. dasyglossis*, 6 in., has bluish-purple flowers in August and September; and *A. monspessulanus*, 8 in., crimson-purple in July; while *A. hypoglossis*, 6 in., produces in summer compact heads of pretty flowers, which are either purple or white. There are many very ornamental kinds.

Aubrietia.—Beautiful dwarf spring-blooming rock plants, forming carpet tufts of flowers of simple cruciferous form. *A. deltoidea* is of a deep lilac-blue; *A. Campbelliæ* is more compact and rather darker, approaching to purple; *A. grandiflora* and *græca* are rather larger, but of a lighter hue. Light sandy soil.

Bambusa.—The bamboo family are elegant arborescent grasses (see BAMBOO).

Baptisia.—Stoutish erect-growing, 2 to 3 ft., with smooth foliage and spikes of pea-like flowers. *B. australis* is purplish-blue, *B. alba*, white, *B. exaltata*, deep blue; all flowering in the summer months.

Bellis.—*B. perennis flore-plena*, the Double Daisy, consists of dwarf showy plants 3 to 4 in. high, flowering freely in spring if grown in rich light soil, and frequently divided and transplanted. The white and pink forms, with the white and red quilled, and the variegated-leaved *aucubaefolia*, are some of the best.

Bocconia.—Stately poppyworts, 6 to 8 ft. *B. cordata* has heart-shaped lobed leaves, and large panicles of small flesh-coloured flowers. Sometimes called *Macleaya*. Deep sandy loam.

Brodiaea.—Pretty bulbous plants. *B. grandiflora*, 1 ft., has large bluish-purple flowers; *B. coccinea*, 2 to 3 ft., has tubular campanulate nodding flowers of a rich crimson with green tips. Sandy loam.

Bulbocodium.—Pretty spring-flowering crocus-like bulbs. *B. versum*, 4 to 6 in. high, purplish-lilac, blooms in March. Good garden soil.

Buphthalmum.—Robust composite herbs with striking foliage, for the back of herbaceous or shrubby borders. *B. cordifolium*, 4 ft., has large cordate leaves, and heads of rich orange flowers in cymose panicles in July. Also called *Talehia speciosa*.

Calandrinia.—Showy dwarf plants for sunny rockwork, in light sandy soil. *C. umbellata*, 3 to 4 in., much branched, with narrow hairy leaves, and corymbs of magenta-crimson flowers in the summer months.

Calochortus.—Beautiful bulbous plants, called mariposa lilies, requiring warm sheltered spots in rich gritty and well-drained soil. There are several species known, the best being *abus*, *elegant*, *luteus*, *Plummerae*, *splendens*, *Purdyi*, *venustus* and *Woodi*.

Callitriche.—Showy marsh plants, adapted for the margins of lakes, streamlets or artificial bogs. *C. palustris flore-pleno*, 1 ft., has double brilliant yellow flowers in May.

Calyptegia.—Twining plants with running perennial roots. *C. pubescens flore-pleno*, 8 to 10 ft., has showy double-pink convolvuloid flowers in July; *C. dahurica* is a handsome single-flowered summer-blooming kind, with rosy-coloured flowers.

Camassia esculenta.—A beautiful bulbous plant 2 to 3 ft. high with large pale blue flowers. Also a white variety.

Campanula.—Beautiful, as well as varied in habit and character. They are called bell-flowers. *C. pulla*, 6 in., purplish, nodding, on slender erect stalks; *C. trachelium*, 9 in., purple, broad-bellied; *C. carpatica*, 1 ft., blue, broad-bellied; *C. nobilis*, 1½ ft., long-bellied, whitish or tinted with chocolate; *C. persicifolia*, 2 ft., a fine border plant, single or double, white or purple, blooming in July; and *C. pyramidalis*, 6 ft., blue or white, in tall branching spikes, are good and diverse. There are many other fine sorts.

Centauria.—Bold-habited composites of showy character; common soil. *C. babylonica*, 5 to 7 ft., has winged stems, silvery leaves, and yellow flower-heads from June to September; *C. montana*, 3 ft., deep bright blue or white.

Centranthus.—Showy free-flowering plants, for rockwork, banks, or stony soil. *C. ruber*, 2 ft., branches and blooms freely all summer, and varies with rosy, or crimson, or white flowers. It clothes the chalk cuttings on some English railways with a sheet of colour in the blooming season.

Cheiranthus.—Pretty rock plants, for light stony soils. *C. alpinus*, 6 in., grows in dense tufts, and bears sulphur-yellow flowers in May. *C. ochroleucus* is similar in character.

Chionodoxa.—Charming dwarf hardy bulbous plants of the liliaceous order, blooming in the early spring in company with *Scilla sibirica*, and of equally easy cultivation. *C. lucicola*, 6 in., has star-shaped flowers of a brilliant blue with a white centre. *C. gigantea* is the finest of the few known species. It blooms from February to April.

Chrysanthemum.—Apart from the florist's varieties of *C. indicum* there are a few fine natural species. One of the best for the flower border is *C. maximum* and its varieties—all with beautiful white flowers having yellow centres. *C. latifolium* is also a fine species.

Colchicum.—Showy autumn-blooming bulbs (corms), with crocus-like flowers, all rosy-purple or white. *C. speciosum*, *C. autumnale*, single and double, *C. byzantinum*, and *C. variegatum* are all worth growing.

Convallaria.—*C. majalis*, the lily of the valley, a well-known sweet-scented favourite spring flower, growing freely in rich garden soil; its spikes, 6 to 9 in. high, of pretty white fragrant bells, are produced in May and June. Requires shady places, and plenty of old manure each autumn.

Coreopsis.—Effective composite plants, thriving in good garden soil. *C. auriculata*, 2 to 3 ft., has yellow and brown flowers in July, and August; *C. lanceolata*, 2 to 3 ft., bright yellow, in August; next to the biennial *C. grandiflora* it is the best garden plant.

Corydalis.—Interesting and elegant plants, mostly tuberous, growing in good garden soil. *C. bracteata*, 9 in., has sulphur-coloured flowers in April, and *C. nobilis*, 1 ft., rich yellow, in May; *C. solida*, with purplish, and *C. tuberosa*, with white flowers, are pretty spring-flowering plants, 4 to 6 in. high. *C. thalictroides*, 1 ft., yellow, May to October.

Cyclamen.—Charming tuberous-rooted plants of dwarf habit, suitable for sheltered rockeries, and growing in light gritty soil. *C. europaeum*, reddish-purple, flowers in summer, and *C. hederifolium* in autumn.

Cypripedium.—Beautiful terrestrial orchids, requiring to be planted in peat soil, in a cool and rather shady situation. *C. spectabile*, 1½ to 2 ft., white and rose colour, in June, is a lovely species, as is *C. calceolus*, 1 ft., yellow and brown, in May; all are full of interest and beauty.

Delphinium.—The Larkspur family, tall showy plants, with spikes of blue flowers in July. Distinct sorts are *D. grandiflorum* and *D. grandiflorum flore-pleno*, 2 to 3 ft., of the richest dazzling blue, flowering on till September; *D. chinensis*, 2 ft., blue, and its double-flowered variety, are good, as is *D. Darwini*, 3 ft., a brilliant double

blue-purple. *D. nudicaule*, 2 ft., orange-scarlet, very showy, is best treated as a biennial, its brilliant flowers being produced freely in the second year from the seed.

Dianthus.—Chiefly rock plants with handsome and fragrant flowers, the smaller sorts growing in light sandy soil, and the larger border plants in rich garden earth. Of the dwarf sorts for rock gardens, *D. alpinus*, *D. cæsius*, *D. deltoides*, *D. dentatus*, *D. neglectus*, *D. petraeus*, and *D. glacialis* are good examples; while for borders or larger rockwork *D. plumarius*, *D. superbus*, *D. Fischeri*, *D. cruentus*, and the clove section of *D. Caryophyllus* are most desirable.

Dicentra.—Very elegant plants, of easy growth in good soil. *D. spectabilis*, 2 to 3 ft., has peony-like foliage, and gracefully drooping spikes of heart-shaped pink flowers, about May, but it should have a sheltered place, as it suffers from spring frosts and winds; *D. formosa* and *D. asiatica*, 1 ft., are also pretty rosy-flowered species.

Dictamnus.—*D. Fraxinella* is a very characteristic and attractive plant, 2 to 3 ft., with bold pinnate leaves, and tall racemes of irregular-shaped purple or white flowers. It is everywhere glandular, and strongly scented.

Digitalis.—Stately erect-growing plants, with long racemes of pouch-shaped drooping flowers. The native *D. purpurea*, or fox-glove, 3 to 5 ft., with its dense racemes of purple flowers, spotted inside, is very showy, but is surpassed by the garden varieties that have been raised. It is really a biennial, but grows itself so freely as to become perennial in the garden. An erect flowered form is called *glorinioides*. The yellow-flowered *D. lutea* and *D. grandiflora* are less showy. Good garden soil, and frequent renewal from seeds.

Dracunculus.—Showy composites of free growth in ordinary soil. *D. caucasicum* and *D. austriacum*, 1 to 1½ ft., both yellow-flowered, bloom in spring and early summer. *D. plantagineum caeruleum*, 3 to 5 ft. high, is the best garden plant.

Draba.—Good rockwork cruciferous plants. *D. alpina*, *D. sinoides*, *D. ciliaris*, *D. Aizoon*, and *D. cuspidata* bear yellow flowers in early spring; *D. cinerea* and *D. ciliata* have white flowers. Gritty well-drained soil.

Dracocephalum.—Handsome labiate plants, requiring a warm and well-drained soil. *D. argenteum*, 1½ ft., *D. austriacum*, 1 ft., *D. grandiflorum*, 1 ft., and *D. Ruyschianum*, 1½ ft., with its var. *Japanicum*, all produce showy blue flowers during the summer months.

Echinacea.—Stout growing showy composites for late summer and autumn flowering, requiring rich deep soil, and not to be often disturbed. *E. angustifolia*, 3 to 4 ft., light purplish-rose, and *E. intermedia*, 3 to 4 ft., reddish-purple, are desirable kinds. *E. purpurea* (often called *Rudbeckia*) is the showiest species. Height 3 to 4 ft., with rosy-purple flowers.

Eomecon chionanthus.—A lovely poppywort about 1 ft. high, with pure white flowers 2 to 3 in. across. Root-stocks thick, creeping.

Epimedium.—Pretty plants, growing about 1 ft. high, with elegant foliage, and curious flowers. *E. macranthum*, white flowers, and *E. rubrum*, red, are distinctly spurred; *E. pinnatum* and *E. Fendleri* are yellow, less so. They bloom in spring, and prefer a shady situation and a peaty soil.

Eranthis hymalis.—A charming tuberous rooted plant, called winter aconite. Flowers bright yellow, January to March, close to the ground.

Eremurus.—Noble plants with thick rootstocks, large sword-like leaves, and spikes of flowers from 3 to 10 ft. high. They require warm sunny spots and rich gritty soil. The best kinds are *robustus*, pink, 6 to 10 ft.; *himalicus*, 4 to 8 ft., white; *Aitchisoni*, 3 to 5 ft., red; *Bungei*, 2 to 3 ft., yellow; and *aurantiacus*, 2 to 3 ft., orange yellow. There are now several hybrid forms.

Erigeron.—Composite plants, variable in character. *E. purpureus*, 1½ ft., with pink flower-heads, having narrow twisted ray-florets; *E. Roylii*, 1 ft., dark blue; and *E. pulchellus*, 1 ft., rich orange, flowering during the summer, are among the best kinds. Good ordinary garden soil.

Erinus.—*E. alpinus* is a beautiful little alpine for rockwork, 3 to 6 in., of tufted habit, with small-toothed leaves, and heads of pinkish-purple or, in a variety, white flowers, early in summer. Sandy well-drained soil.

Erodium.—Handsome dwarf tufted plants. *E. Manescevi*, 1 to 1½ ft., has large purplish-red flowers in summer; *E. Reichardi*, a minute stemless plant, has small heart-shaped leaves in rosette-like tufts, and white flowers striped with pink, produced successively. Light soil.

Eryngium.—Very remarkable plants of the umbelliferous order, mostly of an attractive character. *E. amethystinum*, 2 ft., has the upper part of the stem, the bracts, and heads of flowers all of an amethystine blue. Some of more recent introduction have the aspect of the pine-apple, such as *E. bromelioides*, *E. pandanifolium*, and *E. eburneum*. Deep light soil.

Erythronium.—*E. dens-canis*, the Dog's Tooth Violet, is a pretty dwarf bulbous plant with spotted leaves, and rosy or white flowers produced in spring, and having reflexed petals. Mixed peaty and loamy soil, deep and cool. Several charming American species are now in cultivation.

Euphorbia.—Plants whose beauty resides in the bracts or floral leaves which surround the inconspicuous flowers. *E. alpestris*, 2 ft.,

and *E. Characiis*, 2 to 3 ft., with green bracts, are fine plants for rockwork or sheltered corners.

Ferula.—Gigantic umbelliferous plants, with magnificent foliage, adapted for shrubby borders or open spots on lawns. They have thick fleshy roots, deeply penetrating, and therefore requiring deep soil, which should be of a light or sandy character. *F. communis*, *F. glauca*, and *F. tingiana*, the last with glossy lozenge-shaped leaflets, grow 8 to 10 ft. high; *F. Ferulago*, with more finely cut leaves, grows 5 to 6 ft. high. They flower in early spring, and all have a fine appearance when in bloom, on account of their large showy umbels of yellow flowers.

Fritillaria.—A large genus of liliaceous bulbs, the best known of which is the crown imperial (*F. imperialis*) and the snake's head (*F. Meleagris*). There are many charming species grown, such as *aves*, *pubica*, *recurva*, *scucronis*, *ashabadensis*, &c.

Funkia.—Pretty liliaceous plants, with simple conspicuously longitudinal-ribbed leaves, the racemose flowers funnel-shaped and deflexed. *F. Sieboldiana*, 1 ft., has lilac flowers; *F. graciflora*, 18 in., is white and fragrant; *F. corulea*, 18 in., is violet-blue; *F. albo-marginata*, 15 in., has the leaves edged with white, and the flowers lilac. Rich garden soil.

Gaillardia.—Showy composite plants, thriving in good garden soil. *G. aristata*, 2 ft., has large yellow flower-heads, 2 or 3 in. across, in summer; *G. Baeselari* and *G. Loiselei* have the lower part of the ray-flowers red, the upper part yellow.

Galanthus.—The Snowdrop. Early spring-flowering amaryllidaceous bulbs, with pretty drooping flowers, snow-white, having the tips of the enclosed petals green. The common sort is *G. sinensis*, which blossoms on the first break of the winter frosts; *G. Imperati*, *G. Elzevii* and *G. plicatus* have larger flowers.

Galax aphylla.—A neat little rock plant, 6 to 8 in. high, with pretty round leaves and white flowers. Requires moist peaty soil.

Galga officinalis.—A strong-growing leguminous plant, 2 to 5 ft. high, with pinnate leaves, and masses of pinkish purple pea-like flowers. Also a white variety. Grows anywhere.

Galtonia canadensis.—A fine bulbous plant, 3 to 4 ft. high, with drooping white flowers.

Gaura.—*G. Lindheimeri*, 3 to 5 ft., is much branched, with elegant white and red flowers of the onagraceous type, in long slender racemose spikes during the late summer and autumn months. Light garden soil; not long-lived.

Gentiana.—Beautiful tufted erect-stemmed plants preferring a strong rich loamy soil. *G. acuminata*, known as the Gentianella, forms a close carpet of shining leaves, and in summer bears large erect tubular deep blue flowers. *G. Androsii*, 1 ft., has, during summer, large deep blue flowers in clusters, the corollas closed at the mouth; *G. asclepiadea*, 18 in., purplish-blue, flowers in July.

Geranium.—Showy border flowers, mostly growing to a height of 1½ or 2 ft., having deeply cut leaves, and abundant saucer-shaped blossoms of considerable size. *G. ibericum*, *platypetalum*, *armense* and *Endressii* are desirable purple- and rose-flowered sorts; *G. sanguineum*, a tufted grower, has the flowers a deep rose colour; and the double-flowered white and blue forms of *G. pratense* and *G. sylvaticum* make pretty summer flowers. Good garden soil.

Gerbers.—A South African genus of composites requiring very warm sunny spots and rich gritty soil. *G. Jamesoni*, with large scarlet marguerite-like flowers, and *G. viridiflora*, with white flowers tinged with lilac, are best known. Numerous hybrids have been raised, varying in colour from creamy white to salmon, pink, yellow, red and orange.

Geum.—Pretty roseaceous plants. The single and double flowered forms of *G. chiloense* and its varieties *grandiflorum* and *miniatum*, 2 ft., with brilliant scarlet flowers; *G. coccineum*, 6 to 12 in., scarlet, and *G. montanum*, 9 in., yellow, are among the best sorts. Good garden soil.

Gilisia trifoliata.—A pretty roseaceous plant about 2 ft. high. Flowers white in graceful panicles; flourish in a mixture of sandy peat and loam.

Gnomen.—Remarkable rhubarb-like plants with huge lobed leaves, often 6 ft. across. They should be grown near water as they like much moisture, and a good loamy soil. *G. monicata* and *G. scabra* are the two kinds grown.

Gynerium.—The Pampas-Grass, a noble species, introduced from Buenos Aires; it forms huge tussocks, 4 or 5 ft. high, above which towards autumn rise the bold dense silvery plumes of the inflorescence. It does best in sheltered nooks.

Gypsophila.—Interesting caryophyllaceous plants, thriving in dryish situations. *G. paniculata*, 2 ft., from Siberia, forms a dense semi-globular mass of small white flowers from July onwards till autumn, and is very useful for cutting.

Haberlea rhodopensis.—A pretty rock plant with dense tufts of leaves and bluish-lilac flowers. It likes fibrous peat in fissures of the rocks.

Helenium.—Showy composites of free growth in lightish soil. *H. autumnale*, 4 ft., bears a profusion of yellow-rayed flower-heads in August and September.

Helianthemum.—Dwarf subshrubby plants well suited for rockwork, and called Sun-Roses from their blossoms resembling small wild roses and their thriving best in sunny spots. Some of the handsomest are *H. roseum*, *montabile*, *cupreum* and *rhodanthemum*, with red

flowers; *H. vulgare flore-pleno*, *grandiflorum* and *stramineum*, with yellow flowers; and *H. macranthum* and *papyraceum*, with the flowers white.

Helianthus.—The Sunflower genus, of which there are several ornamental kinds. *H. multiflorus*, 4 ft., and its double-flowered varieties, bear showy golden yellow flower-heads in profusion, and are well adapted for shrubby borders; *H. argyris*, 8 ft., has drooping willow-like leaves. Many other showy species.

Helichrysum.—Composite plants, with the flower-heads of the scarious character known as Everlastings. *H. arenarium*, 6 to 8 in., is a pretty species, of dwarf spreading habit, with woolly leaves and corymbs of golden yellow flowers, about July.

Helleborus.—Charming very early blooming dwarf ranunculaceous herbs. *H. niger* or Christmas Rose, the finest variety of which is called *maximus*, has white showy saucer-shaped flowers; *H. orientalis*, 1 ft., rose-coloured; *H. atrorubens*, 1 ft., purplish-red; and *H. colchicus*, 1 ft., deep purple. Deep rich loam.

Hemerocallis.—The name of the day lilies of which *H. fulva*, *H. disticha*, *H. flava*, *H. Danortieri* and *H. aurantiaca major* are the most showy, all with yellow or orange flowers. They flourish in any garden soil.

Hepatica.—Charming little tufted plants requiring good loamy soil, and sometimes included with Anemone. *H. triloba*, 4 in., has three-lobed leaves, and a profusion of small white, blue, or pink single or double flowers, from February onwards; *H. angustata*, from Transylvania, 6 to 8 in., is a larger plant, with sky-blue flowers.

Hesperis.—*H. matronalis*, 1 to 2 ft., is the old garden Rocket, of which some double forms with white and purplish blossoms are amongst the choicest of border flowers. They require a rich loamy soil, not too dry, and should be divided and transplanted into fresh soil annually or every second year, in the early autumn season.

Heuchera.—*H. sanguinea* and its varieties are charming and brilliant border plants with scarlet flowers in long racemes. Rich and well-drained soil.

Hibiscus.—Showy malvaceous plants. *H. Moscheutos*, rose-coloured, and *H. palustris*, purple, both North American herbs, 3 to 5 ft. high, are suitable for moist borders or for boggy places near the margin of lakes.

Iberis.—The Candytuft, of which several dwarf spreading subshrubby species are amongst the best of rock plants, clothing the surface with tufts of green shoots, and flowering in masses during May and June. The best are *I. saxatilis*, 6 to 10 in.; *I. sempervirens*, 12 to 15 in.; and *I. Pruitii* (variously called *coriacea*, *carnea*, *correaefolia*), 12 in.

Incarvillea.—*I. Delavayi* is the best species for the open air. It grows 2 ft. high and has large tubular rose-pink carmine blossoms. It likes rich sandy loam and sunny spots.

Lathyrus.—Handsome climbing herbs, increased by seeds or division. *L. grandiflorus*, 3 ft., has large rose-coloured flowers with purplish-crimson wings, in June; *L. latifolius*, the everlasting pea, 6 ft., has bright rosy flowers in the late summer and autumn; the vars. *albus*, white, and *superbus*, deep rose, are distinct. Ordinary garden soil.

Lavatera.—*L. thuringiaca*, 4 ft., is a fine erect-growing malvaceous plant, producing rosy-pink blossoms freely, about August and September. Good garden soil.

Leucocajum.—Snowflake. Pretty early-blooming bulbs, quite hardy. *L. vernum*, 6 in., blooms shortly after the snowdrop, and should have a light rich soil and sheltered position; *L. carpaticum*, flowers about a month later; *L. pulchellum*, 1½ ft., blooms in April and May; and *L. aestivum*, 2 ft., in May. All have white pendant flowers, tipped with green.

Liatris.—Pretty composites with the flower-heads collected into spikes. *L. pumila*, 1 ft.; *L. squarrosa*, 2 to 3 ft.; *L. spicata*, 3 to 4 ft.; *L. pycnostachya*, 3 to 4 ft., all have rosy-purplish flowers. Deep, cool, and moist soil.

Linum.—See LUY.
Linaria.—Toadflax. Pretty scrophulariads, of which *L. alpina*, 3 to 6 in., with bluish-violet flowers having a brilliant orange spot, is suitable for rockwork; *L. dalmatica*, 4 ft., and *L. genistifolia*, 3 ft., both yellow-flowered, are good border plants; *L. vulgaris*, the common British toad-flax, and its regular peloriate form, are very handsome and free flowering during the summer months.

Linum.—Flax. *L. alpinum*, 6 in., large, dark blue; *L. narbonense*, 1½ ft., large, blue; *L. perenne*, 1½ ft., cobalt blue; and *L. arboreum (flavum)*, 1 ft., yellow, are all pretty. The last is liable to suffer from damp during winter, and some spare plants should be wintered in a frame. It is really shrubby in character.

Lithospermum.—*L. prostratum*, 3 in., is a trailing evergreen herb, with narrow hairy leaves, and paniculate brilliant blue flowers in May and June. Well adapted for rockwork or banks of sandy soil.

Lupinus.—Showy erect-growing plants with papilionaceous flowers, thriving in good deep garden soil. *L. polyphylus*, 3 ft., shows noble tufts of palmate leaves, and long spikes of bluish-purple or white flowers in June and July; *L. arboreus* is subshrubby, and has yellow flowers.

Lychnis.—Brilliant erect-growing caryophyllaceous plants, thriving best in beds of peat earth or of deep sandy loam. *L. chalcedonica*, 3 ft., has dense heads of bright scarlet flowers, both single and double, in June and July; *L. fulgens*, 1 ft., vermilion; *L. Haageana*,

1½ ft., scarlet; and *L. grandiflora*, 1 to 2 ft., with clusters of scarlet, crimson, pink and white flowers. All large-flowered and showy, but require a little protection in winter.

Lysimachia.—The best known is the Creeping Jenny, *L. Nummularia*, much used for trailing over rockeries and window boxes, with bright yellow flowers. The variety *averea* with golden leaves is also popular. Other species that grow from 2 to 3 ft. high, and are good border plants, are *L. clethroides*, with white spikes of flowers; *L. vulgaris*, *L. thyriflora*, *L. ciliata*, *L. verticillata* and *L. punctata*, all yellow.

Maba.—*M. moschata*, 2 ft., with a profusion of pale pink or white flowers, and musky deeply cut leaves, though a British plant, is worth introducing to the flower borders when the soil is light and free.

Macropis.—The Welsh poppy, *M. cambrica*, 1 to 2 ft. high, yellow, and *M. Wallichii*, from the Himalayas, 4 to 6 ft. high with pale blue flowers, are the best known perennials of the genus. The last-named, however, is best raised from seeds every year, and treated like the biennial kinds.

Mertensia.—*M. virginica*, 1 to 1½ ft., azure blue, shows flowers in drooping panicles in May and June. It does best in shady peat borders.

Mimulus.—Monkey-flower. Free-blooming, showy scrophulariaceous plants, thriving best in moist situations. *M. cardinalis*, 2 to 3 ft., has scarlet flowers, with the limb segments reflexed; *M. luteus* and its many garden forms, 1 to 1½ ft., are variously coloured and often richly spotted; and *M. cupress*, 8 to 10 in., is bright coppery-red. *M. moschatus* is the Musk-plant, of which the variety *Harrisonii* is a greatly improved form, with much larger yellow flowers.

Monarda.—Handsome labiate plants, flowering towards autumn, and preferring a cool soil and partially shaded situation. *M. didyma*, 2 ft., scarlet or white; *M. fistulosa*, 3 ft., purple; and *M. purpurea*, 2 ft., deep purple, are good border flowers.

Muscari.—Pretty dwarf spring-flowering bulbs. *M. botryoides* (Grape Hyacinth), 6 in., blue or white, is the handsomest; *M. moschatus* (Musk Hyacinth), 10 in., has peculiar livid greenish-yellow flowers and a strong musky odour; *M. monstrosum* (Feather Hyacinth) bears sterile flowers broken up into a feather-like mass. Good garden soil.

Myosotidium nobile.—A remarkable plant, 1½ to 2 ft. high, with large blue forget-me-not-like flowers. Requires gritty peat soil and cool situations, but must be protected from frost in winter.

Myosotis.—Forget-me-not. Lovely boraginaceous plants. *M. dissiiflora*, 6 to 8 in., with large, handsome and abundant sky-blue flowers, is the best and earliest, flowering from February onwards; it does well in light cool soils, preferring peaty ones, and should be renewed annually from seeds or cuttings. *M. ruficola*, 2 to 3 in., intense blue, is a fine rock plant, preferring shady situations and gritty soil; *M. sylvatica*, 1 ft., blue, pink or white, used for spring bedding, should be sown annually in August.

Narcissus.—See NARCISSEUS.

Nepeta.—*N. Mussinii*, 1 ft., is a compactly spreading greyish-leaved labiate, with lavender-blue flowers, and is sometimes used for bedding or for marginal lines in large compound beds.

Nitemburgia.—*N. rimularis*, 4 in., from La Plata, has slender, creeping, rooting stems, bearing stalked ovate leaves, and large funnel-shaped white flowers, with a remarkably long slender tube; especially adapted for rockwork, requiring moist sandy loam.

Nymphaea.—See WATER-LILY.

Oenothera.—The genus of the Evening Primrose, consisting of showy species, all of which grow and blossom freely in rich deep soils. *Oe. missouriensis* (*macrocarpa*), 6 to 12 in., has stout trailing branches, lance-shaped leaves and large yellow blossoms; *Oe. taraxacifolia*, 6 to 12 in., has a stout crown from which the trailing branches spring out, and these bear very large white flowers, changing to delicate rose; this perishes in cold soils, and should therefore be raised from seed annually. Of erect habit are *Oe. speciosa*, 1 to 2 ft., with large white flowers; *Oe. frutescens*, 2 to 3 ft., with abundant yellow flowers; and *Oe. serotina*, 2 ft., also bright yellow.

Omphalodes.—Elegant dwarf boraginaceous plants. *O. serna*, 4 to 6 in., a creeping, shade-loving plant, has bright blue flowers in the very early spring; *O. Lucida*, 6 in., has much larger lilac-blue flowers, and is an exquisite rock plant for warm, sheltered spots. Light sandy soil.

Onosma.—*O. laurica*, 6 to 8 in., is a charming boraginaceous plant from the Caucasus, producing hispid leaves and cymose heads of drooping, tubular, yellow flowers. It is of evergreen habit, and requires a warm position on the rockwork and well-drained sandy soil; or a duplicate should be sheltered during winter in a cold, dry frame.

Ornithogalum.—The Star of Bethlehem. *O. arabicum* can only be grown in the warmest parts of the kingdom, and then requires protection in winter. Other species, all bulbous, are *O. sativum*, *O. pyramidale*, *O. pyrenaicum*, and the common Star of Bethlehem. *O. umbellatum*; all are easily grown, and have white flowers.

Ostrouskya magnifica.—A magnificent bellflower from Bokhara, 4 to 5 ft. high, and white flowers tinted and veined with lilac, 3 to 5 in. across. Requires rich, gritty loam of good depth, as it produces tuberous roots 1 to 2 ft. long.

Oxiris.—Handsome scrophulariaceous plants, from Chile, thriving in moist, well-drained peaty soil, and in moderate shade. *O. coccinea*, 1 ft., has erect racemes of pendent crimson flowers.

Papaver.—The Poppy. Very showy plants, often of strong growth, and of easy culture in ordinary garden soil. *P. orientale*, 3 ft., has crimson-scarlet flowers, 6 in. across, and the variety *bracteatum* closely resembles it, but has leafy bracts just beneath the blossom. *P. alpinum*, 6 in., white with yellow centre; *P. nudicaule*, 1 ft., yellow, scented, and *P. piosum*, 1 to 2 ft., deep orange, are ornamental smaller kinds.

Pentstemon.—The popular garden varieties have sprung from *P. Hartwegii* and *P. Cobaea*. Other distinct kinds are *P. campanulatus*, 1½ ft., pale rose, of bushy habit; *P. humilis*, 9 in., bright blue; *P. speciosus*, *cyranikus* and *Jaffrayanus*, 2 to 3 ft., all bright blue; *P. barbatus*, 3 to 4 ft., scarlet, in long terminal panicles; *P. Murrayanus*, 6 ft., with scarlet flowers and connate leaves; and *P. Palmeri*, 3 to 4 ft., with large, wide-tubed, rose-coloured flowers.

Pelastem.—*P. fragrans*, the Winter Heliotrope, though of weedy habit, with ample cordate rosette-like leaves, yields in January and February its abundant spikes, about 1 ft. high, of greyish flowers scented like heliotrope; it should have a corner to itself.

Phloxis.—Bold and showy labiates, growing in ordinary soil. *P. Russeliana* (*lunariaefolia*), 4 ft., yellow, and *P. tuberosa*, 3 ft., purplish-rose, both with downy hoary leaves, come in well in broad flower borders.

Phytolium.—*P. capensis* from South Africa is hardy south of the Thames and in favoured localities. Flowers tubular scarlet, on branching stems, 2 to 3 ft. high. Requires light, rich soil.

Physalis.—*P. Alkekengi* from South Europe has long been known in gardens for its bright orange-red globular calyxes. It has been surpassed by the much larger and finer *P. Franckii* from Japan; the brilliant calyxes are often 3 in. in diameter in autumn. Grows in any garden soil.

Physostegia.—Tall, autumn-blooming labiates, of easy growth in ordinary garden soils. *P. imbricata*, 5 to 6 ft., has pale purple flowers in closely imbricated spikes.

Phytolacca.—Ornamental strong-growing perennials requiring much space. *P. acinosa*, from the Himalayas, 3 to 4 ft., with whitish flowers in erect spikes. *P. decandara*, the North American Poke Weed or Red Ink plant, grows 5 to 10 ft. high, has fleshy poisonous roots, erect purple stems and white flowers. *P. icosandra*, from Mexico, 2 to 3 ft., pinky white. The foliage in all cases is handsome. Ordinary garden soil.

Platycodon.—*P. grandiflorus*, 6 to 24 in. high, is a fine Chinese perennial with flattish, bell-shaped flowers, 2 to 3 in. across, and purple in colour. The variety *Mariesii* (or *pumilus*) is dwarf, with larger, deeper-coloured flowers. Requires rich sandy loam.

Podophyllum.—Ornamental herbs with large lobed leaves. *P. Emodi*, 6 to 12 in. high, from the Himalayas, has large white or pale-rose flowers, and in autumn bright red, hen's-egg-like fruits. *P. peltatum*, the North American mandrake, has large umbrella-like leaves and white flowers; *P. peltatum*, from China, purple. They all require moist, peaty soil in warm, sheltered nooks.

Polemonium.—Pretty border flowers. *P. coeruleum* (Jacob's Ladder), 2 ft., has elegant pinnate leaves, and long panicles of blue rotate flowers. The variety called *variegatum* has very elegantly marked leaves, and is sometimes used as a margin or otherwise in bedding arrangements. Good garden soil.

Polygonatum.—Elegant liliaceous plants, with rhizomatous stems. *P. multiflorum* (Solomon's Seal), 2 to 3 ft., with arching stems, and drooping white flowers from the leaf axils, is a handsome border plant, doing especially well in partial shade amongst shrubs, and also well adapted for pot culture for early forcing. Good garden soil.

Polygonum.—A large family, varying much in character, often weedy, but of easy culture in ordinary soil. *P. saccinifolium*, 6 to 10 in., is a pretty prostrate subshrubby species, with handsome rose-pink flowers, suitable for rockwork, and prefers boggy soil; *P. affine* (*Brunonis*), 1 ft., deep rose, is a showy border plant, flowering in the late summer; *P. cuspidatum*, 8 to 10 in., is a grand object for planting where a screen is desired, as it suckers abundantly, and its tall spotted stems and handsome cordate leaves have quite a noble appearance. Other fine species are *P. boldschuanum*, a climber, *P. sphaerostachyum*, *P. lanigerum*, *P. polystachyum* and *P. sachalinense*, all bold and handsome.

Potentilla.—The double varieties are fine garden plants obtained from *P. argyrophylla atrosanguinea* and *P. nepalensis*. The colours include golden-yellow, red, orange-yellow, crimson, maroon and intermediate shades. They all flourish in rich sandy soil.

Primula.—Beautiful and popular spring flowers, of which many forms are highly esteemed in most gardens. *P. vulgaris*, 6 in., affords numerous handsome single- and double-flowered varieties, with various-coloured flowers for the spring flower-beds and borders. Besides this, *P. Sieboldii* (*corioides amena*), 1 ft., originally deep rose with white eye, but now including many varieties of colour, such as white, pink, lilac and purple; *P. japonica*, 1 to 2 ft., crimson-rose; *P. denticulata*, 1 ft., bright bluish-lilac, with its allies *P. erosa* and *P. purpurea*, all best grown in a cold frame; *P. viscosa*, 6 in., purple, and its white variety *minalis*, with *P. pedemontana* and *P. spectabilis*, 6 in., both purple; and the charming

little Indian *P. rosea*, 3 to 6 in., bright cherry-rose colour, are but a few of the many beautiful kinds in cultivation.

Palmaria.—Handsome dwarf, boraginaceous plants, requiring good deep garden soil. *P. officinalis*, 1 ft., has prettily mottled leaves and blue flowers; *P. sibirica* is similar in character, but has broader leaves more distinctly mottled with white.

Pyrethrum.—Composite plants of various character, but of easy culture. *P. Parthenium eximium*, 2 ft., is a handsome double white form of ornamental character for the mixed border; *P. usiginosum*, 5 to 6 ft., has fine large, white, radiate flowers in October; *P. Tchihatchewii*, a close-growing, dense evergreen, creeping species, with long-stalked, white flower-heads, is adapted for covering slopes in lieu of turf, and for rockwork.

Ranuncula.—*R. pyrenaica*, 3 to 6 in., is a pretty dwarf plant, requiring a warm position on the rockwork and a moist, peaty soil more or less gritty; it has rosettes of ovate spreading root-leaves, and large purple, yellow-centred, rotate flowers, solitary, or two to three together, on naked stalks.

Ranunculus.—The florists' ranunculus is a cultivated form of *R. asiaticus* (see **RANUNCULUS**). *R. amplexicaulis*, 1 ft., white; *R. acuminifolius*, 1 to 2 ft., white, with its double variety *R. acuminifolius flore-pleno* (Fair Maids of France); and *R. acris flore-pleno* (Bachelor's Buttons), 2 ft., golden yellow, are pretty. Of dwarfier interesting plants there are *R. alpestris*, 4 in., white; *R. gramineus*, 6 to 10 in., yellow; *R. parnassifolius*, 6 in., white; and *R. rupefolius*, 4 to 6 in., white with orange centre.

Rodgersia.—Handsome herbs of the saxifrage family. *R. podophylla* with large bronzy-green leaves cut into 5 large lobes, and tall branching spikes 3 to 4 ft. high—the whole plant resembling one of the large meadow sweets. *R. acaulisfolia*, yellowish-white; *R. Henriki*, deep purple; *R. pennata*, fleshy pink; and *R. sambucifolia*, white, are recently introduced species from China. They require rich sandy peat and warm sheltered spots.

Romneya.—*R. Coulteri*, a fine Californian plant, with large white flowers on shoots often as high as 7 ft.; *R. trichocalyx* is similar. Both require very warm, sunny spots and rich, sandy soil, and should not be disturbed often.

Rudbeckia.—Bold-habited composite plants, well suited for shrubby borders, and thriving in light loamy soil. The flower-heads have a dark-coloured elevated disk. *R. Drummondii*, 2 to 3 ft., with the ray-florets reflexed, yellow at the tip and purplish-brown towards the base; *R. fulgida*, 2 ft. golden-yellow with dark chocolate disk, the flower-heads 2 to 3 in. across; and *R. speciosa*, 2 to 3 ft., orange-yellow with blackish-purple disk, the flower-heads 3 to 4 in. across, are showy plants.

Sagittaria.—Graceful water or marsh plants with hastate leaves, and tuberous, running and fibrous roots. *S. japonica plena*; *S. lancifolia*, *S. macrophylla* and *S. sagittifolia*, are among the best kinds, all with white flowers.

Salvia.—The Sage—a large genus of labiates, often very handsome, but sometimes too tender for English winters. *S. Sckarea*, 5 to 6 ft., is a very striking plant little more than a biennial, with branched panicles of bluish flowers issuing from rosy-coloured bracts; *S. patens*, 2 ft., which is intense azure, has tuberous roots, and may be taken up, stored away and replanted in spring like a dahlia. *S. pratensis*, 2 ft., blue, a showy native species, is quite hardy; the variety *lupulina* has the centre of the lower lip white.

Saxifraga.—A very large genus of rock and border plants of easy culture. The *Megasea* group, to which *S. ligulata*, *S. cordifolia* and *S. crassifolia* belong, are early-flowering kinds of great beauty, with fleshy leaves and large cymose clusters of flowers of various shades of rose, red and purple. Another very distinct group with silvery foliage—the crustaceous group—contains some of our choicest Alpines. Of these *S. caesia*, *S. calyciflora*, *S. Colyledon* are among the best known. Some of the species look more like lichens than flowering plants. The green moss-like saxifrages are also a very distinct group, with dense tufted leaves which appear greener in winter than in summer. The flowers are borne on erect branching stems and are chiefly white in colour. *Saxifraga umbrosa* (London Pride) and *S. Gemm* belong to still another group, and are valuable alike on border and rockery. *S. petalata* is unique owing to its large petalate leaves, often 1 ft. to 18 in. across, with stalks 1 to 2 ft. long. Flowers in April, white or pinkish. Likes plenty of water and a moist peaty soil or marshy place. *S. sarmentosa*, the well-known "mother of thousands," is often grown as a pot plant in cottagers' windows.

Scilla.—Beautiful dwarf bulbous plants, thriving in well-worked peaty loam, or sandy peat. *S. bifolia*, 3 in., and *S. sibirica*, 4 in., both intense blue, are among the most charming of early spring flowers; *S. patula*, 6 to 8 in., and *S. campanulata*, 1 ft., with tubular greyish-blue flowers, freely produced, are fine border plants, as is the later-blooming *S. peruviana*, 6 to 8 in., dark blue or white.

Sedum.—Pretty succulent plants of easy growth, and mostly suitable for rockwork. They are numerous, varied in the colour of both leaves and foliage, and mostly of compact tufted growth. *S. spectabile*, 1 to 1½ ft., pink, in great cymose heads, is a fine plant for the borders, and worthy also of pot-culture for greenhouse decoration. Mention may also be made of the common *S. acre* (Stonecrop), 3 in., yellow, and its variety with yellow-tipped leaves.

Sempervivum.—House-Link. Neat-growing, succulent plants,

forming rosettes of fleshy leaves close to the ground, and rapidly increasing by runner-like offsets; they are well adapted for rockwork, and do best in sandy soil. The flowers are stellate, cymose, on stems rising from the heart of the leafy rosettes. *S. arachnoides*, purplish, *S. arenarium*, yellow, *S. globiferum* and *S. Lagabri*, rose, grow when in flower 3 to 6 in. high; *S. calcareum*, rose colour, and *S. Boutignianum*, pale rose, both have glaucous leaves tipped with purple; *S. Heuffelii*, yellow, with deep chocolate leaves, and *S. Wulfeni*, sulphur-yellow, are from 8 to 12 in. high.

Senecio.—A large genus with comparatively few good garden plants. Large and coarse-growing kinds like *S. Doria*, *S. macrophyllus* and *S. sarracenicus* are good for rough places; all yellow-flowered. *S. pulcher* is a charming plant, 2 to 3 ft. high, with rosy-purple flower-heads, having a bright orange centre. It likes a warm corner and moist soil. *S. ciliatum*, from China, has large roundish leaves and orange-yellow flowers. It flourishes near water and in damp places.

Shortia.—*S. galacifolia*, a beautiful tufted plant 2 to 3 in. high, with roundish crenate leaves, on long stalks, and white funnel-shaped flowers in March and April. *S. uniflora* from Japan is closely related. The leaves of both assume rich purple-red tints in autumn. Warm sunny situations and rich sandy loam and peat are required.

Silene.—Pretty caryophyllaceous plants, preferring sandy loam, and well adapted for rockwork. *S. alpestris*, 6 in., white, and *S. quadridentata*, 4 in., white, are beautiful tufted plants for rockwork or the front parts of borders; *S. maritima flore-pleno*, 6 in., white, *S. Elizabethae*, 4 in., bright rose, and *S. Schafta*, 6 in., purplish-rose, are also good kinds.

Sisyrinchium.—Pretty dwarf iridaceous plants, thriving in peaty soil. *S. grandiflorum*, 10 in., deep purple or white, blossoms about April, and is a fine plant for pot-culture in cold frames.

Sparaxis.—Graceful bulbous plants from South Africa. *S. grandiflora*, with deep violet-purple, and *S. tricolor*, with rich orange-red, flowers are best known. *S. pulcherrima*, a lovely species, 3 to 6 ft. high, with drooping blood-red blossoms, is now referred to the genus *Dierama*. A warm, light, but rich soil in sheltered spots required.

Spirea.—Vigorous growing plants of great beauty, preferring good, deep, rather moist soil; the flowers small but very abundant, in large corymbose or spicate panicles. *S. Aruncus*, 4 ft., white; *S. astilboides*, 2 ft., white; *S. Filipendula*, 1½ ft., and *S. Uimaria*, 3 ft., both white; *S. palmata*, 2 ft., rosy-crimson; and *S. senata*, 3 ft., carmine rose, are some of the best.

Statice.—Pretty plants with broad, radical leaves, and a much-branched inflorescence of numerous small flowers. *S. latifolia*, 2 ft., greyish-blue; *S. tatarica*, 1 ft., lavender-pink; *S. speciosa*, 1½ ft., rose colour; and *S. eximia*, 1½ ft., rosy-lilac—are good border plants. *S. bellidifolia*, 9 in., lavender; *S. emarginata*, 6 in., purple; *S. globulariaefolia*, 9 in., white; and *S. nana*, 4 in.—are good sorts for the rockery.

Stenactis.—*S. speciosa*, 1 to 2 ft., is a showy composite, of easy culture in good garden soil; it produces large corymbs of flower-heads, with numerous narrow blue ray-florets surrounding the yellow disk. Now more generally known as *Erigeron*.

Stipa.—*S. pennata* (Feather Grass), 1½ ft., is a very graceful-habited grass, with stiff slender erect leaves, and long leathery awns to the seeds.

Stibectia.—*S. cyanea*, 2 ft., is a grand, autumn-flowering, composite plant, with blue flower-heads, 4 in. across. Sandy loam and warm situation.

Symphytum.—Rather coarse-growing but showy boraginaceous plants, succeeding in ordinary soil. *S. caucasicum*, 2 ft., with blue flowers changing to red, is one of the finer kinds for early summer blooming.

Thalictrum.—Free-growing but rather weedy ranunculaceous plants, in many cases having elegantly cut foliage. *T. aquilegifolium*, 2 ft., purplish from the conspicuous stamens, the leaves glaucous, is a good border plant; and *T. minus* has foliage somewhat resembling that of the Maidenhair fern. Ordinary garden soil.

Tiarella.—*T. cordifolia*, the foam flower, is very ornamental in border or rockery. Leaves heart-shaped lobed and toothed; flowers white starry; ordinary garden soil.

Tigridia.—Lovely bulbous plants called tiger flowers, useful in the warmest parts of the kingdom for the border in rich but gritty soil. *T. Patonia*, the peacock tiger flower, from Mexico, grows 1 to 2 ft. high, with plaited sword-like leaves, and large flowers about 6 in. across, having zones of violet and yellow blotched with purple and tipped with scarlet. There are many varieties, all charming.

Trillium.—*T. grandiflorum*, the wood-lily of North America, is the finest. It has large white flowers and grows freely in peaty soil in shady borders. There are several other species, some with purplish flowers.

Tritonia.—A genus of South African plants with fibrous-coated corms or solid bulbs, often known as montretas. *T. crocata*, 2 ft., orange-yellow, *T. crocosmaeflora*, 2 to 2½ ft., orange-scarlet, and *T. Polka*, 3 to 4 ft., bright yellow, are the best-known varieties, of which there are many subsidiary ones, some being very late and free in flowering. A rich, gritty soil, and warm, sunny situations are best for these plants.

Trietelia.—Charming spring-flowering bulbs, thriving in any good sandy soil. *T. Murrayana*, 8 in., lavender-blue, and *T. majolica*,

6 in., white, are both pretty plants of the easiest culture, either for borders or rockeries.

Tritoma.—Splendid stoutish-growing plants of noble aspect, familiarly known as the Poker plant, from their erect, rigid spikes of flame-coloured flowers; sometimes called Kniphofia. *T. Uvaria*, 3 to 4 ft., bright orange-red, passing to yellow in the lower flowers, is a fine autumnal decorative plant. They should be protected from frosts by a covering of ashes over the crown during winter.

Trollius.—Showy ranunculaceous plants, of free growth, flowering about May and June. *T. europæus*, 18 in., lemon globular; *T. asiaticus*, 2 ft., deep yellow; and *T. nepallifolius*, 2 to 2½ ft., golden yellow, are all fine showy kinds. Rich and rather moist soil.

Tulipa.—Splendid dwarfish bulbs, thriving in deep, sandy, well-enriched garden soil, and increased by offsets. They bloom during the spring and early summer months. *T. Gamsersiana*, the parent of the florists' tulip, 12 to 18 in., crimson and other colours; *T. Eichleri*, 1 ft., crimson with dark spot; *T. Greigi*, 1 ft., orange with dark spot edged with yellow, and having dark spotted leaves; *T. oculus solis*, 1 ft., scarlet with black centre; and *T. sylvestris*, 12 to 18 in., bright yellow, are showy kinds.

Veratrum.—Distinct liliaceous plants with bold ornamental leaves regularly folded and plaited. *V. album*, 3 to 5 ft., has whitish blossoms in dense panicles, 1 to 2 ft. long. *V. nigrum*, 2 to 3 ft., has blackish-purple flowers, also *V. Maachi*, 2 ft. Rich sandy loam and peat.

Verbascum.—Showy border flowers of erect spire-like habit, of the easiest culture. *V. Chaixii*, 4 to 5 ft., yellow, in large pyramidal panicles; *V. phoeniceum*, 3 ft., rich purple or white; and *V. formosum*, 6 ft., golden yellow in dense panicles, are desirable species.

Veronica.—The Speedwell family, containing many ornamental members; all the hardy species are of the easiest cultivation in ordinary garden soil. The rotate flowers are in close, erect spikes, sometimes branched. *V. crassifolia*, 2 ft., dark blue; *V. incarnata*, 1½ ft., flesh-colour; *V. corymbosa*, 1½ ft., pale blue in corymbose-arranged racemes; *V. gentianoides*, 2 ft., grey with blue streaks; *V. spicata*, blue, and its charming white variety *alba*; and *V. virginica*, 5 ft., white, are distinct.

Vinca.—Periwinkle. Pretty rock plants, growing freely in ordinary soil. *V. herbacea*, of creeping habit, with purplish-blue flowers; *V. minor*, of trailing habit, blue; and *V. major*, 1 to 2 ft. high, also trailing, are suitable for the rock garden. The last two are evergreen, and afford varieties which differ in the colour of their flowers, while some are single and others double.

Viola.—Violet. Charming dwarf plants, mostly evergreen and of tufted habit, requiring well-worked rich sandy soil. *V. calcarata*, 6 in., light blue; *V. cornuta*, 6 to 8 in., blue; *V. lutea*, 4 in., yellow; *V. alba*, 6 in., yellow or violet with yellow eye; *V. palmensis*, 6 to 8 in., lavender-blue; *V. pedata*, 6 in., pale blue; and *V. odorata*, the Sweet Violet, in its many single and double flowered varieties, are all desirable.

Yucca.—Noble subarborescent liliaceous plants, which should be grown in every garden. They do well in light, well-drained soils, and have a close family resemblance, the inflorescence being a panicle of white, drooping, tulip-shaped flowers, and the foliage rosette, sword-shaped and spear-pointed. Of the more shrubby-habited sorts, *Y. glauca*, *recurvifolia* and *Treculeana* are good and distinct; and of the dwarfier and more herbaceous sorts *Y. filamentosa*, *fasciata* and *angustifolia* are distinct and interesting kinds, the first two flowering annually.

The taste for cultivation of the class of plants, of which the foregoing list embraces some of the more prominent members, is on the increase, and gardens will benefit by its extension.

HARDY TREES AND SHRUBS.—Much of the beauty of the pleasure garden depends upon the proper selection and disposition of ornamental trees and shrubs. We can only afford space here for lists of some of the better and more useful and ornamental trees and shrubs, old and new.

The following list, which is not exhaustive, furnishes material from which a selection may be made to suit various soils and situations. The shrubs marked * are climbers.

Hardy Deciduous Trees.

- | | |
|-----------------------------|-----------------------------------|
| Acer—Maple. | Fraxinus—Ash. |
| Aesculus—Horse-Chestnut. | Ginkgo—Maidenhair Tree. |
| Ailantus—Tree of Heaven. | Gleditschia—Honey Locust. |
| Alnus—Alder. | Gymnocladus—Kentucky Coffee Tree. |
| Amygdalus—Almond. | Juglans—Walnut. |
| Betula—Birch. | Kolreuteria. |
| Carpinus—Hornbeam. | Laburnum. |
| Carya—Hickory. | Larix—Larch. |
| Castanea—Sweet Chestnut. | Liriodendron—Tulip-tree. |
| Catalpa. | Magnolia. |
| Celtis—Nettle Tree. | Morus—Mulberry. |
| Cercis—Judas Tree. | Negundo—Box-Elder. |
| Cotoneaster (some species). | Ostrya—Hop Hornbeam. |
| Crataegus—Thorn. | Paulownia. |
| Davidia. | Planera. |
| Diospyros. | |
| Fagus—Beech. | |

- Platanus—Plane.
- Populus—Poplar.
- Prunus (Plums, Cherries, &c.).
- Ptelea—Hop Tree.
- Pyrus—Pear, &c.
- Quercus—Oak.
- Rhus—Sumach.
- Robinia—Locust Tree.

- Salix—Willow.
- Sophora.
- Taxodium—Deciduous Cypress.
- Tilia—Lime.
- Ulmus—Elm.
- Virgilia.
- Xanthoceras.

Hardy Evergreen Trees.

- Abies—Silver Fir.
- Araucaria—Chili Pine.
- Arbutus—Strawberry Tree.
- Biota—Arbor Vitæ.
- Buxus—Box.
- Cedrus—Cedar.
- Cephalorhiza.
- Cryptomeria—Japan Cedar.
- Cupressus—Cypress.
- Ilex—Holly.
- Juniperus—Juniper.
- Laurus—Bay Laurel.

- Libocedrus.
- Magnolia grandiflora.
- Picea—Spruce Fir.
- Pinus—Pine.
- Quercus ilex—Holm-Oak.
- Retinospora.
- Sciadopitys—Umbrella Pine.
- Sesuoia (Wellingtonia).
- Taxus—Yew.
- Thuja.
- Thuja—Arbor Vitæ.
- Tsuga.

Hardy Deciduous Shrubs.

- Abelia.
- Acer—Maple.
- Amelanchier.
- Ampelopsis.*
- Amygdalopsis.
- Aralia.
- Aristolocia.*
- Berberis—Berberry.
- Bignonia*—Trumpet Flower.
- Buddleia.
- Calophaca.
- Calycanthus—Carolina Allspice.
- Caragana.
- Chimonanthus.
- Clematis.*
- Colutea—Bladder Senna.
- Cornus—Dogwood.
- Cotoneaster (some species).
- Crataegus—Thorn.
- Cydonia—Japan Quince.
- Cytisus—Broom, &c.
- Daphne.
- Deutzia.
- Edwardsia.
- Euonymus europæus—Spindle Tree.
- Forsythia.
- Fremontia.

- Genista.
- Halesia—Snowdrop Tree.
- Hamamelis—Wych Hazel.
- Hibiscus—Althæa frutex, &c.
- Hippophaë—Sea Buckthorn.
- Hypericum—St John's Wort.
- Jasminum*—Jasmine.
- Kerria.
- Lonicera*—Honeysuckle.
- Lycium.
- Magnolia.
- Menispermum*—Moonseed.
- Periploca.*
- Philadelphus—Mock Orange.
- Rhus—Wig Tree, &c.
- Ribes—Flowering Currant.
- Robinia—Rose Acacia, &c.
- Rosa—Rose.
- Rubus*—Bramble.
- Spartium—Spanish Broom.
- Spiræa.
- Staphylea—Bladder-Nut.
- Symphoricarpos—Snowberry.
- Syringa—Lilac.
- Tamarix—Tamarisk.
- Viburnum—Guelder Rose, &c.
- Vitis*—Vine.
- Weigela.

Hardy Evergreen Shrubs.

- Aleebia.*
- Arbutus.
- Aucuba—Japan Laurel.
- Azara.
- Bambusa—Bamboo.
- Berberidopsis.*
- Berberis—Berberry.
- Buddleia.
- Bupleurum.
- Buxus—Box.
- Ceanothus.
- Ceraus—Cherry-Laurel, &c.
- Cistus—Sun-Rose.
- Cotoneaster.
- Crataegus Pyracantha—Fire Thorn.
- Daphne.
- Desfontainia.
- Elaeagnus—Oleaster.
- Erica—Heath.
- Escallonia.
- Euonymus.
- Fabiana.
- Fatsia (Aralia).
- Garrya.

- Grætainia.
- Hedera*—Ivy.
- Hypericum—St John's Wort.
- Ilex—Holly.
- Jasminum*—Jasmine.
- Kadsura.*
- Lardizabala.*
- Laurus—Sweet Bay.
- Ligustrum—Privet.
- Lonicera*—Honeysuckle.
- Osmanthus.
- Pernettya.
- Phillyrea.
- Photinia.
- Rhamnus Alaternus.
- Rhododendron—Rose-Bay.
- Rosa*—Rose.
- Ruscus.
- Skimmia.
- Smilax.*
- Stauntonia.*
- Ulex—Forze.
- Viburnum—Laurustinus.
- Vinca—Periwinkle.
- Yucca—Adam's Needle.

BEDDING PLANTS.—This term is chiefly applied to those summer-flowering plants, such as ivy-leaved and zonal pelargoniums, petunias, dwarf lobelias, verbenas, &c., which are employed in masses for filling the beds of a geometrical parterre. Of late years, however, more attention has been bestowed on arrangements of brilliant flowering plants with those of fine foliage, and the massing also of hardy early-blooming plants in parterre fashion has been very greatly extended. Bedding plants thrive best in a light loam, liberally manured with thoroughly rotten dung from an old hotbed or thoroughly decomposed cow droppings and leaf-mould.

Spring Bedding.—For this description of bedding, hardy plants only must be used; but even then the choice is tolerably extensive. For example, there are the *Alyssums*, of which *A. saxatile* and *A. gemmense* are in cultivation; *Antennaria lomentosa*; the double white *Arabis albidis*; *Aubrietias*, of which the best sorts are *A. Campbellii* and *A. grandiflora*; the double *Bellis perennis* or Daisy; the Wallflowers, including *Cheiranthus Cheiri* (the Common Wallflower), *C. alpina* and *C. Marshallii*; Hepaticas, the principal of which are the varieties of *H. triloba*, and the blue *H. angulosa*; Iberis or Candytuft; *Lithospermum fruticosum*; *Myosotis* or Forget-me-not, including *M. alpestris*, *M. dissitiflora*, *M. asorica* and *M. sylvestris*; Phloxes, like *P. subulata*, with its varieties *setacea*, *Nelsoni*, *nivalis*; the single-flowered varieties of the Primrose, *Primula vulgaris*; the Polyanthuses; *Pyrethrum Parthenium aureum*, called Golden Feather; the pink-flowered *Silene pendula*; self-coloured varieties of the Pansy, *V. tricolor*, and of *V. lutea* and *V. cornuta*, as well as some recent hybrids. Besides these there are the various spring-flowering bulbs, such as the varieties of Hyacinthus, Tulipa, Narcissus, Fritillaria, Muscari or Grape Hyacinth, Crocus, Scilla, Chionodoxa and Galanthus or Snowdrop.

Summer Bedding.—There is great variety amongst the plants which are used for bedding-out in the garden during the summer months, but we can note only some of the most important of them. Amongst them are the *Ageratums*, the old tall-growing sorts of which have been superseded by dwarfier blue and white flowered varieties; *Alternanthera*, the principal of which are *A. amoena*, *amoena spectabilis*, *magnifica*, *paronychioides major aurea* and *amarilis*; *Alyssum maritimum variegatum*; some of the dwarf varieties of *Antirrhinum majus*; *Arundo Donax variegata*; *Begonias*; *Calceolarias*; *Cannas*; *Centaurea rugosina*; *Clematises*, of which the hybrids of the *Jachmanni* type are best; *Dahlia variabilis*, and the single-flowered forms of *D. coccinea*; *Echeverias*, of which *E. secunda* and *E. metallica* are much employed; *Gaxanias*; *Heliotropes*; *Iresines*; *Lantanas*; *Lobelias*; *Mesembryanthemum cordifolium variegatum*; *Pelargonium*, of which the various classes of zonal or bedding varieties are unapproachable for effect and general utility; *Petunias*; *Phloxes*; *Polemonium coeruleum variegatum*; *Pyrethrum Parthenium aureum*, the well-known Golden Feather, especially useful as an edging to define the outline of beds upon grass; *Tropaeolum*, especially some of the varieties of *T. Lobbianum*; and *Verbenas*, the offspring of *Tweedii*, *chamaedrifolia* and others. Few bulbs come into the summer flower gardens, but amongst those which should always be well represented are the *Gladiolus*, the *Lilium*, the *Tigridia* and the *Montbretia*.

Subtropical Bedding.—Foliage and the less common flowering plants may be used either in masses of one kind, or in groups arranged for contrast, or as the centres of groups of less imposing or of dwarfier-flowering subjects; or they may be planted as single specimens in appropriate open spaces, in recesses, or as distant striking objects terminating a vista.

Carpet Bedding consists in covering the surface of a bed, or a series of beds forming a design, with close, low-growing plants, in which certain figures are brought out by means of plants of a different habit or having different coloured leaves. Sometimes, in addition to the carpet or ground colour, individual plants of larger size and handsome appearance are dotted symmetrically over the beds, an arrangement which is very telling. Some of the best plants for carpeting the surface of the beds are: *Antennaria lomentosa* and *Leucophytum Browni*, white; *Sedum acre*, *dasyphyllum*, *corsicum* and *glaucum*, grey; and *Sedum lydium*, *Mentha Pulegium gibraltaria*, *Sagina subulata* and *Herniaria glabra*, green. The *Alternantheras*, *Amaranthuses*, *Iresines* and *Colous Verschaffellii* furnish high and warm colours; while *Pyrethrum Parthenium aureum* yields greenish-yellow; *Thymus citriodorus aureus*, yellowish; *Mesembryanthemum cordifolium variegatum*, creamy yellow; *Centaureas* and others, white; *Lobelia Erinus*, blue; and the succulent *Echeverias* and *Sempervivums*, glaucous rosettes, which last add much to the general effect. In connexion with the various designs such fine plants as *Agave americana*, *Dracena indivisa* are often used as centre-pieces.

GREENHOUSE PLANTS.—These are plants requiring the shelter of a glass house, provided with a moderate degree of heat, of which 45° Fahr. may be taken as the minimum in winter. The house should be opened for ventilation in all mild weather in winter, and daily throughout the rest of the year. The following is a select list of genera of miscellaneous decorative plants (orchids, palms and ferns excluded; climbers are denoted by *; bulbous and tuberous plants by †):

Abutilon	Aspidistra	Brugmansia
Acacia	Asystasia (Mackaya)	Calceolaria
Agapanthus	Azalea	Camellia
Agathaea	Bauera	Campanula
Agave	Begonia†	Canna
Alonsoa	Blandfordia	Celosia
Aloysia	Bomarea*	Cestrum*
Amarylisi†	Boronia	Chorizema*
Ardisia	Bougainvillea*	Chrysanthemum
Asparagus	Bouvardia	Cineraria

Ciantbus	Ficus	Nerinet
Clivia	Fuchsia	Nerium
Cobaea*	Grevillea	Pelargonium
Coleus	Haemanthus†	Petunia
Coprosma	Heliotropium	Pimelea
Cordylone	Hibiscus	Plumbago*
Correa	Hoya*	Polygonia†
Cuphea	Hydrangea	Primula
Cyclamen†	Impatiens	Rhododendron
Cyperus	Jasminum†	Richardia (Calla)†
Cytisus	Justicia	Salvia
Darwinia (Genetyllia)	Kalosanthes	Sarracenia
Diosma	Lachenalia†	Solanum
Dracaena	Lantana	Sparmannia
Eccremocarpus*	Lapageria*	Statice
Epacris	Lilium†	Strelitzia
Epiphyllum	Lophospermum*	Streptocarpus
Erica	Mandevilla*	Swainsonia
Eriostemon	Manettia*	Taconia*
Erythraea	Mutisia*	Tecoma
Eucalyptus	Myrsiphyllum*	Tradescantia
Eupatorium	Maurandya*	Valloia†
Eurya		

STOVE PLANTS.—For the successful culture of stove plants two houses at least, wherein different temperatures can be maintained, should be devoted to their growth. The minimum temperature during winter should range at night from about 55° in the cooler to 65° in the warmer house, and from 65° to 75° by day, allowing a few degrees further rise by sun heat. In summer the temperature may range 10° higher by artificial heat, night and day, and will often by sun heat run up to 90° or even 95°, beyond which it should be kept down by ventilation and frequent syringing and damping down of the pathways. During the growing period the atmosphere must be kept moist by damping the walls and pathways, and by syringing the plants according to their needs; when growth is completed less moisture will be necessary. Watering, which, except during the resting period, should generally be copious, is best done in the forenoon; while syringing should be done early in the morning before the sun becomes too powerful, and late in the afternoon to admit of the foliage drying moderately before night. The following is a select list of genera of stove plants (climbers are denoted by *, bulbous and tuberous plants by †):

Acalypha	Cyanophyllum	Musa
Achimenes†	(Miconia)	Nelumbium†
Aeschynanthus	Cycas	Nepenthes
Allamanda*	Deffenbachia	Nymphæa†
Alcaesia†	Dipladenia*	Ozara*
Amarylisi†	Dracena	Pancratium†
Anthurium	Ematium	Pandanus
Aphelandra	Eucharis†	Passiflora*
Aralia	Euphorbia	Pavetta
Ardisia	Ficus	Perezia*
Arisæma†	Fraxinea	Pieroma*
Aristolochia*	Gardesia	Poinsettia
Ataccia	Genera	Rondeletia
Begonia	Gloriosa*	Sanchezia
Bertolonia	Gloxinia†	Schubertia*
Bignonia*	Heliconia†	Scutellaria
Bromeliads	Hoffmannia	Stephanotis
Cactus	Ipomæa	Tabernaemontana
Caladium†	Ixora	Terminalia
Calathea	Jacobia	Thunbergia
Centropogon	Jasminum*	Torenia
Cissus*	Luculia	Thyracanthus
Clerodendron*	Maranta	Tydaea
Crinum†	Medinilla	Vinca
Codiaeum (Croton)	Meyenia	

ORCHIDS.—For the successful cultivation of a mixed collection of tropical orchids, it is necessary that two or three houses, in which different temperatures can be maintained, should be provided. The greater number of them are epiphytes or plants that grow on others without absorbing nourishment from them, and heat and moisture afford all or nearly all the nourishment they require. At one time it was thought the plants themselves were better for being associated with such objects as ferns and palms, but they are best grown by themselves.

The East Indian orchid house takes in those species which are found in the warm parts of the eastern hemisphere, as well as those from the hottest parts of the western, and its temperature should range from about 70° to 80° during the summer or growing season and from 65° to 70° during winter. The Mexican or Brazilian orchid house accommodates the plants from the warm parts of South America, and its temperature should range from about 65° to 75° during summer and from 60° to 65° in winter. A structure called the cool orchid house is set apart for the accommodation of the many lovely mountain species from South America and India, such as *odonoglossums*, *masdevallias*, &c., and in this the more uniform the temperature can be kept the better, that in summer varying between

60° and 65°, and in winter from 45° to 60°. A genial moist atmosphere must be kept up in the hottest houses during the growing season, with a free circulation of air admitted very cautiously by well-guarded ventilators. In winter, when the plants are at rest, little water will be necessary; but in the case of those plants which have no fleshy pseudobulbs to fall back upon for sustenance, they must not be suffered to become so dry as to cause the leaves to shrivel. In the Mexican house the plants will generally be able to withstand greater drought occasionally, being greatly assisted by their thick pseudobulbs. In the cool or odontoglossum house a considerable degree of moisture must be maintained at all times, for in these the plants keep growing more or less continuously.

For potting or basketing purposes, or for plants requiring block-culture, the materials used are light fibrous peat, special leaf-mould, osmunda or polypodium fibre and living sphagnum moss, which supply free drainage for the copious supply of water required. Good turfy loam is also used for some, such as *Cypripediums* and *Calanthes*. Indeed the composts now used are varied considerably according to the particular group of orchids. The water should, however, be so used as not to run down into the sheathing bases of the leaves. While in flower, orchids may with advantage be removed to a drier and cooler situation, and may be utilized in the drawing-room or boudoir. Of late years not only have many fine hybrids been raised artificially between various species, but some remarkable bigeneric hybrids (between what are considered two distinct genera) have also been produced (indicated in the list below by *). To keep a valuable collection of orchids in good condition requires the services of an expert orchid grower.

The following is a select list of genera in cultivation:—

<i>Acineta</i>	<i>Cymbidium</i>	<i>Peristeria</i>
<i>Ada</i>	<i>Cypripedium</i>	<i>Peacatorea</i>
<i>Aërides</i>	<i>Cyrtopodium</i>	<i>Phajus</i>
<i>Angraecum</i>	<i>Dendrobium</i>	<i>Phaio-calanthæ*</i>
<i>Anguloa</i>	<i>Diacrium</i>	<i>Phalaenopsis</i>
<i>Anoëtochilus</i>	<i>Disa</i>	<i>Plumina</i>
<i>Anellia</i>	<i>Epidendrum</i>	<i>Platyclinis</i>
<i>Arachnanthe</i>	<i>Eulophia</i>	<i>Pleione</i>
<i>Arpophyllum</i>	<i>Eulophiella</i>	<i>Pleurochallis</i>
<i>Barkera</i>	<i>Galeandra</i>	<i>Polystachya</i>
<i>Batemanina</i>	<i>Gongora</i>	<i>Prosenanthe</i>
<i>Bifrenaria</i>	<i>Grammatophyllum</i>	<i>Ranathera</i>
<i>Brassavola</i>	<i>Habenaria</i>	<i>Restrepia</i>
<i>Brassia</i>	<i>Houlletia</i>	<i>Rodriguezia</i>
<i>Brasso-Cattleya*</i>	<i>Isonopsis</i>	<i>Scolobium</i>
<i>Broughtonia</i>	<i>Ipsea</i>	<i>Schomburgkia</i>
<i>Bulbophyllum</i>	<i>Laelia</i>	<i>Scuticaria</i>
<i>Burlingtonia</i>	<i>Laëlio-Cattleya*</i>	<i>Sobralia</i>
<i>Calanthe</i>	<i>Leptotes</i>	<i>Sophracattleya*</i>
<i>Catasetum</i>	<i>Lissochilus</i>	<i>Sophronitis</i>
<i>Cattleya</i>	<i>Lycaste</i>	<i>Spathoglottis</i>
<i>Chysis</i>	<i>Madevallia</i>	<i>Stanhopea</i>
<i>Cirrhopetalum</i>	<i>Miltonia</i>	<i>Thunia</i>
<i>Cochlioda</i>	<i>Mormodes</i>	<i>Trichopilia</i>
<i>Coelia</i>	<i>Odontoglossum</i>	<i>Trichosma</i>
<i>Coelogyne</i>	<i>Odontioda*</i>	<i>Vanda</i>
<i>Compareschia</i>	<i>Oncidium</i>	<i>Zygo-colax*</i>
<i>Cyclopitia</i>	<i>Pachystoma</i>	<i>Zygopetalum</i>

PALMS.—These form charming table and drawing-room plants when quite young. When more fully developed, and long before their full growth is attained, they are among the most decorative plants known for the conservatory and for subtropical gardening. They are easily cultivated, but should not be allowed to become dry. The soil should consist of about 3 parts turfy loam, 1 part leaf mould, 1 part coarse silver sand, with enough chemical or other manure added to render the whole moderately rich. The older plants will occasionally require the roots pruned in order to keep them in as small pots as possible without being starved. This should be done early in the spring, and the plants heavily shaded until feeding roots are again produced. It is of advantage to afford stove culture while the plants are quite young. A little later most of the genera succeed well under moderately cool conditions.

The following genera are among those most commonly cultivated:

<i>Acanthophoenix</i>	<i>Chamaerops</i>	<i>Martinezia</i>
<i>Acanthorhiza</i>	<i>Cocos</i>	<i>Oreodoxa</i>
<i>Areca</i>	<i>Corypha</i>	<i>Phoenix</i>
<i>Bactris</i>	<i>Geonoma</i>	<i>Pritchardia</i>
<i>Brahea</i>	<i>Hypophorbe</i>	<i>Rhapis</i>
<i>Calamus</i>	<i>Kentia</i>	<i>Sabal</i>
<i>Caryota</i>	<i>Latania</i>	<i>Stevensonia</i>
<i>Ceroxylon</i>	<i>Livistonia</i>	<i>Thrinax</i>
<i>Chamaedorea</i>		

PALMS.—These popular plants are usually increased by means of their spores, the "dust" produced on the back of their fronds. The spores should be sown in well-drained pots or seed pans on the surface of a mixture of fibrous sifted peat and small broken crocks or sandstone; this soil should be firmly pressed and well-watered, and the spores scattered over it, and at once covered with propagating glasses or pieces of sheet glass, to prevent water or dry air getting

to the surface. The pots should be placed in pans full of water, which they will absorb as required. A shady place is desirable, with temperature of 50° to 55° by night and 65° to 70° by day, or they may be set on a shelf in an ordinary propagating pit. The spores may be sown as soon as ripe, and when the young plants can be handled, or rather can be lifted with the end of a pointed flat stick, they should be pricked out into well-drained pots or pans filled with similar soil and should be kept moist and shady. As they become large enough, pot them singly in 3-in. pots, and when the pots are fairly filled with roots shift on into larger ones.

The best time for a general repotting of ferns is in spring, just before growth commences. Those with creeping rhizomes can be propagated by dividing these into well-rooted portions, and, if a number of crowns is formed, they can be divided at that season. In most cases this can be performed with little risk, but the *Gleichenias*, for example, must only be cut into large portions, as small divisions of the rhizomes are almost certain to die; in such cases, however, the points of the rhizomes can be led over and layered into small pots, several in succession, and allowed to remain unsevered from the parent plant until they become well-rooted. In potting the well-established plants, and all those of considerable size, the soil should be used in a rough turfy state, not sifted but broken, and one-sixth of broken crocks or charcoal and as much sand as will insure free percolation should be mixed with it.

The stove ferns require a day temperature of 65° to 75°, but do not thrive in an excessively high or close dry atmosphere. They require only such shade as will shut out the direct rays of the sun, and, though abundant moisture must be supplied, the atmosphere should not be overloaded with it. Ferns should not be allowed to become quite dry at the root, and the water used should always be at or near the temperature of the house in which the plants are growing. Some ferns, as the different kinds of *Gymnogramme* and *Cheilanthes*, prefer a drier atmosphere than others, and the former do not well bear a lower winter temperature than about 60° by night. Most other stove ferns, if dormant, will bear a temperature as low as 55° by night and 60° by day from November to February. About the end of the latter month the whole collection should be turned out of the pots, and retrained or repotted into larger pots as required. This should take place before growth has commenced. Towards the end of March the night temperature may be raised to 60°, and the day temperature to 70° or 75°, the plants being shaded in bright weather. Such ferns as *Gymnogrammes*, which have their surface covered with golden or silver powder, and certain species of scaly-surfaced *Cheilanthes* and *Nothochlaena*, as they cannot bear to have their fronds wetted, should never be syringed; but most other ferns may have a moderate sprinkling occasionally (not necessarily daily), and as the season advances, sufficient air and light must be admitted to solidify the tissues.

Hardy British ferns belonging to such genera as *Asplenium*, *Nephrodium*, *Aspidium*, *Scolopendrium*, have become fairly popular of late years, and many charming varieties are now used in borders and rockeries. Spores may be sown as above described, but in a much lower temperature.

The following is a select list of genera:—

<i>Acrostichum</i>	<i>Davallia</i>	<i>Osmunda</i>
<i>Actinopteris</i>	<i>Dicksonia</i>	<i>Onoclea</i>
<i>Adiantum</i>	<i>Gleichenia</i>	<i>Phlebodium</i>
<i>Alsophila</i>	<i>Gymnogramme</i>	<i>Platycaerium</i>
<i>Aspidium</i>	<i>Hymenophyllum</i>	<i>Polypodium</i>
<i>Asplenium</i>	<i>Lastrea</i>	<i>Pteris</i>
<i>Blechnum</i>	<i>Lomaria</i>	<i>Scolopendrium</i>
<i>Cheilanthes</i>	<i>Lygodium</i>	<i>Todea</i>
<i>Cibotium</i>	<i>Nephrodium</i>	<i>Trichomanes</i>
<i>Cyathea</i>	<i>Nephrolepis</i>	<i>Woodwardia</i>

VI. Fruits.

Fruit-Trees Borders.—No pains should be spared, in the preparation of fruit-tree borders, to secure their thorough drainage. In case of adhesive clayey subsoil this can generally be secured by placing over the sloping bottom a good layer of coarse rubble material, communicating with a drain in front to carry off the water, while earthenware drain tubes may be laid beneath the rubble from 8 to 10 ft. apart, so as to form air drains, and provided with openings both at the side of the walk and also near the base of the wall. Over this rubble matter, rough turfy soil, grass-side downwards, should be laid, and on this the good prepared soil in which the trees are to be planted.

The borders should consist of 3 parts rich turfy loam, the top spit of a pasture, and 1 part light gritty earth, such as road-grit, with a small portion (one-sixth) of fine brick rubbish. They should not be less than 12 ft. in breadth, and may vary up to 15 or 18 ft., with a fall from the wall of about 1 in. in 3 ft. The border itself should be raised a foot or more above the general level. The bottom of the border as well as that

of the drain must be kept lower than the general level of the subsoil, else the soaking will gather in all the little depressions of its surface. Fruit-tree borders should not be at all cropped with culinary vegetables, or very slightly so, as the process of digging destroys the roots of the trees, and drives them from near the surface, where they ought to be.

Shallow planting, whether of wall trees or standards, is generally to be preferred, a covering of a few inches of soil being sufficient for the roots, but a surface of at least equal size to the surface of the hole should be covered with dung or litter so as to restrain evaporation and preserve moisture. In the case of wall trees, a space of 5 or 6 in. is usually left between the stem at the insertion of the roots and the wall, to allow for increase of girth. Young standard trees should be tied to stakes so as to prevent their roots being ruptured by the wind-waving of the stems and to keep them erect. The best time for planting fruit trees in the open air is from the end of September till the end of November in open weather.

In the selection and distribution of fruit trees regard must of course be had to local situation and climate. The best walls having a south or south-east aspect are devoted to the peach, nectarine, apricot, dessert pears, plums and early cherries. Cherries and the generality of plums succeed very well either on an east or west aspect. Morello cherries, apples and stewing pears succeed well on a north wall. In Scotland the mulberry requires the protection of a wall, and several of the finer apples and pears do not arrive at perfection without this help and a tolerably good aspect. The wall-trees intended to be permanent are called dwarfs, from their branches springing from near the ground. Between these, trees with tall stems, called riders, are planted as temporary occupants of the upper part of the wall. The riders should have been trained in the nursery into good-sized trees, in order that when planted out they may come into bearing as speedily as possible.

Standard Fruit Trees should not be planted, if it can be avoided, in the borders of the kitchen garden, but in the outer slips, where they either may be allowed to attain their full size or may be kept dwarfed. Each sort of fruit should be planted by itself, for the sake of orderly arrangement, and in order to facilitate protection when necessary by a covering of nets. Their produce is often superior in flavour to that of the same kind of fruit grown on walls.

Orchard-house Trees.—Peaches, nectarines, apricots, figs and dessert plums, cherries, apples and pears are commonly cultivated in the orchard-house. Peaches and nectarines are generally planted out, while the rest are more commonly cultivated in pots. This allows of the hardier pot plants being removed out of doors while those planted out are in need of the room. The pot plants are overhauled in the autumn, the roots pruned, a layer being cut off to allow new soil to be introduced. Surface dressing and feeding by liquid manure should also be afforded these plants while the fruit is swelling. Every effort should be made to complete the growth of peaches and nectarines while the sun is sufficiently strong to ripen them. Tomatoes are frequently employed to fill gaps in the orchard-house. Should it be provided with a central path, requiring shade, Hambro and Sweet-water grapes serve the purpose well, and in favourable seasons afford excellent crops of fruit.

VII. Vegetables.

Under this head are included those esculents which are largely eaten as "vegetables" or as "salads." The more important are treated under their individual headings (see АРТИСТОК, ASPARAGUS, BEAN, &c. &c.). The culinary herbs used for flavouring and garnishing are for the most part dwarf perennial plants requiring to be grown on a rich soil in an open sunny aspect, or annuals for which a warm sheltered border is the most suitable place; and they may therefore be conveniently grown together in the same compartment—a herb garden. The perennials should be transplanted either every year or every second year. For winter use the tops of the most useful kinds of herbs should be cut when in flower or full leaf and quite

dry, and spread out in an airy but shady place so as to part slowly with the moisture they contain and at the same time retain their aromatic properties. When quite dry they should be put into dry wide-mouthed bottles and kept closely corked. In this way such herbs as basil, marjoram, mint, sage, savory, thyme, balm, chamomile, horehound, hyssop and rue, as well as parsley, may be had throughout the season with almost the full flavour of the fresh herb.

Intensive Cultivation.—This name has been applied to the method of forcing early vegetables and salads during the winter and spring months in the market gardens in the neighbourhood of Paris. The system is now popularly known in England as "French gardening." Although a few assert that it is an old English one that has been discarded in favour of superior methods, there seems to be little or no evidence in support of this contention. The system itself has been practised for about 300 years in the "marais" gardens round Paris. At one time these gardens were in the centre of the city itself, but owing to modern improvements they have been gradually pushed out beyond the city boundaries farther and farther. Most of these gardens are small—not more than a couple of acres in extent, and the rent paid by the *maratcher*, or market gardener, is very high—as much as £30 to £40 per acre.

The French *maratcher* does not use hot-water apparatus for forcing his plants into early growth. He relies mainly upon the best stable manure, a few shallow frames about 4½ ft. wide covered with lights, and a number of large bell glasses or "cloches." The work is carried on from October till the end of March and April, after which, with the exception of melons, the cultures are carried on in the open air.

The chief crops grown for early supplies, or "primeurs" as they are called, are special varieties of cos and cabbage lettuces, short carrots, radishes, turnips, cauliflowers, endives, spinach, onions, corn salad and celery. To these is added a very important crop of melons, a special large-fruited variety known as the Prescott Canteloup being the most favoured.

It is astonishing how much produce is taken off one of these small intensive gardens during the year, and especially during the worst months when prices usually run fairly high. The fact that rents are so heavy around Paris is in itself an indication of the money that is realized by the growers not only in the Paris markets, but also in Covent Garden.

During the winter season narrow beds are made up of manure, either quite fresh or mixed with old manure, according to the amount of heat required. These beds are covered with a few inches of the fine old mould obtained from the decayed manure of previous years. In the early stages seeds of carrots and radishes are sown simultaneously on the same beds, and over them young lettuces that have been raised in advance are planted. In this way three crops are actually on the same beds at the same time. Owing, however, to the difference in their vegetative growth, they mature one after the other instead of simultaneously. Thus with the genial warmth and moisture of the hotbeds, all crops grow rapidly, but the radishes mature first, then the lettuces are taken off in due course, thus leaving the beds to finish up with the carrots by themselves. Later on in the season, perhaps small cauliflowers will be planted along the margins of the beds where the carrots are growing, and will be developing into larger plants requiring more space by the time all the carrots have been picked and marketed. So on throughout the year with other crops, this system of intercropping or overlapping of one crop with another is carried out in a most ingenious manner, not only under glass lights, but also in the open air. Spinach, corn salad, radishes and carrots are the favourite crops for sowing between others such as lettuces and cauliflowers.

Although enormous quantities of water are required during the summer season, great care must be exercised in applying water to the winter crops. When severe frost prevails the lights or cloches are rarely taken off except to gather mature specimens; and no water is given directly overhead to the plants for fear of chilling them and checking growth. They must secure their

supply of moisture from the rain that falls on the glass, and flows into the narrow pathways from 9 in. to 12 in. wide between each range of frames. As the beds are only about 4½ ft. wide, the water from the pathways is soaked up on each side by capillary attraction, and in this way the roots secure a sufficient supply.

Besides an abundance of water in summer there must also be an enormous quantity of good stable manure available during the winter months. This is necessary not only to make up the required hotbeds in the first place, but also to fill in the pathways between the frames, wherever it is considered advisable to maintain the heat within the frames at a certain point. As it is impossible to use an ordinary wheelbarrow in these narrow pathways, the workman carries a specially made wicker basket called a "hotte" on his shoulders by means of two straps. In this way large quantities of manure are easily transported to any required spot, and although the work looks hard to an English gardener, the Frenchman says he can carry more manure with less fatigue in half a day than an Englishman can transport in a day with a wheelbarrow.

This is merely an outline of the system, which is now being taken up in various parts of the United Kingdom, but not too rapidly. The initial expenses for frames, lights, cloches, mats and water-supply are in many cases prohibitive to men with the necessary gardening experience, while on the other hand those who have the capital lack the practical knowledge so essential to success.

For full details of this system see *French Market-Gardening, with details of Intensive Cultivation*, by John Weathers (London, 1909).

VIII.—Calendar of Garden Operations (A) for Great Britain.

JANUARY

Kitchen Garden.—Wheel out manure and composts during frosty weather; trench vacant ground not turned up roughly in autumn. Sow early peas in a cold frame for transplanting. Sow also first-crop peas, early in the month, and William I. towards the end; Early Seville and Early Longpod beans; and short-topped radish in two or three sowings, at a week's interval, all on a warm border; also Hardy Green and Brown cos lettuce in a frame or on south border. Plant shallots and Ashleaf potatoes on a warm border. Protect broccoli as it becomes fit for use, or remove to a dry shed or cellar; lettuces and endive, which are best planted in frames; and parsley in frames so as to be accessible.

Fruit Garden.—Plant fruit trees in open weather, if not done in autumn, which is the proper season, mulching over the roots to protect them from frost, and from drought which may occur in spring. Prune fruit trees in mild weather or in moderate frosts, nailing only in fine weather. Wash trees infested with insects with one of the many insecticides now obtainable. Take off grafts, and lay them aside in moist earth in a shady place.

Forcing.—Prepare manure for making up hotbeds for early cucumbers and melons, where pits heated with hot water are not in use; also for Ashleaf potatoes. Sow also in heat mustard and cress for salads, onions for salads; tomatoes, celery to be pricked out for an early crop; and Early Horn carrot and kidney-beans on slight hotbeds. Force asparagus, sea-kale and rhubarb, in hotbeds, in pits, in the mushroom-house or in the open garden by the use of covers surrounded with warm litter; for cucumbers a top heat of 70°; for vines in leaf and flower a temperature ranging from 65° to 70°. Keep forced strawberries with swelling fruit well watered. Plant vine eyes for propagation in a brisk heat.

Plant Houses.—Give abundance of air to the greenhouse, conservatory and alpine frame in mild weather, but use little water. A supply of roses, kalmias, rhododendrons, &c., and of hardy flowers and bulbs, as lily of the valley, hyacinths, tulips, daffodils, &c., should be kept up by forcing.

Flower Garden.—Plant out tubers and bulbs of border flowers, where neglected in autumn, deferring the finer florists' flowers till next month. Transplant herbaceous plants in light soils, if not done in autumn; also deciduous trees, shrubs and hedges. Lay edgings in fine weather. Sow mignonette, stocks, &c., in pots; sow sweet peas and a few hardy annuals on a warm border. Give auriculas and carnations abundance of air, but keep the roots rather dry to prevent damping off.

FEBRUARY

Kitchen Garden.—Sow successional crops of Early Seville beans, and William I., American Wonder or other peas in the beginning and end of the month; early cabbages to follow the last sowing in August; red cabbages and savoy towards the end. Sow also Early Horn carrot; Early Purple-top Munich turnip; onions for a full crop in light soils, with a few leeks and some parsley. Sow lettuce

for succession, with radishes and Round-leaved spinach, twice in the course of the month; and small salads every fortnight. Plant Jerusalem artichokes, shallots, garlic, horse-radish and early potatoes. Transplant to the bottom of a south wall a portion of the peas sown in pots in frames in November and January for the first crop. Sow Brussels sprouts in gentle heat for an early crop.

Fruit Garden.—Prune apricots, peaches, nectarines and plums, before the buds are much swelled; finish pruning apples, pears, cherries, gooseberries, currants and raspberries, before the end of the month; also the dressing of vines. Keep the fruit-room free from spoiled fruit, and shut it close. Cut down the double-bearing raspberries to secure strong autumn-fruiting shoots. Head back stocks preparatory to grafting.

Forcing.—Sow melons and cucumbers on hotbeds and in pits. Sow carrots, turnips, early celery, also aubergines or egg-plants, capsicums, tomatoes and successional crops of kidney-beans; cauliflower and Brussels sprouts, in gentle heat, to be afterwards planted out. Plant early potatoes on slight hotbeds. Continue the forcing of asparagus, rhubarb and sea-kale. Commence or continue the forcing of the various choice fruits, as vines, peaches, figs, cherries, strawberries, &c. Pot roots of mint and place in heat to produce sprigs for mint sauce. Be careful to protect the stems of vines that are outside the forcing-houses.

Plant Houses.—Let the greenhouse and conservatory have plenty of air in mild weather. Pot and start tuberous-rooted begonias and gloxinias. Pot young plants of Hippeastrum, and start the established ones. Propagate chrysanthemums in cool-house or vinery under hand lights or frames. Put plants of fuchsias, petunias, verbenas, heliotropes, salvias and other soft-wooded subjects, into a propagating house to obtain cuttings, &c., for the flower garden. Sow stocks, dahlias and a few tender and half-hardy annuals, on a slight hotbed, or in pots. Propagate old roots of dahlias by cuttings of the young shoots in a hotbed. Sow petunias in heat, and prick out and harden for bedding out; also gloxinias to be grown on in heat till the flowering season.

Flower Garden.—In dry open weather plant dried roots, including most of the finer florists' flowers; continue the transplanting of hardy biennial flowers and herbaceous plants. Sow in the last week mignonette, and hardy annuals, in a warm border, for subsequent transplanting.

MARCH

Kitchen Garden.—Sow main crops of wrinkled marrow peas; Longpod and Windsor beans; cabbage, onions, leeks, Early Horn carrots, parsnips, salsify, scorzonera, Brussels sprouts, borecole, lettuces and spinach. In the beginning and also at the end of the month sow Early Strap-leaf and Early Snowball turnips and savoy. In the last fortnight sow asparagus, cauliflower and the various sweet and savoury herbs; also sea-kale, radishes, celery, celeriac and parsley. Small salads should be sown every ten days. Make up beds for mushrooms with well-prepared dung towards the end of the month. Plant early potatoes in the first week, and a main crop during the last fortnight. Sea-kale, asparagus and peas raised in frames may now be planted; also garlic and shallots. Full crops of cabbages should be planted out; also cauliflowers under hand-glasses. Propagate by slips, or by earthing up the old stems, the various pot-herbs.

Fruit Garden.—Finish the pruning of fruit trees before the middle of the month. Protect those coming into blossom. Begin grafting in the third week; dig and dress between the rows of gooseberries, currants and other fruit trees, if not already done. Kill wasps assiduously as soon as they appear.

Forcing.—Continue the forcing of melons, cucumbers, tomatoes and the various fruits. In the vinery and peach-house, attend to the keeping down of insects by syringing; and promote the growth of the young shoots, by damping the walls and paths morning and evening. Sow capsicum and tomato; also in slight heat such tender herbs as basil and marjoram.

Plant Houses.—More water may be given than formerly. Sow seeds of greenhouse and hothouse plants; also the different sorts of tender annuals; pot off those sown last month; sow cineraria for the earliest bloom; also Chinese primulas. Shift heaths and other hard-wooded subjects and stove-plants; plant tuberoses in pots for forcing. Begin to propagate greenhouse plants by cuttings; also colicues by cuttings in heat, potting them off as soon as rooted.

Flower Garden and Shrubbery.—In the last week, sow hardy annuals in the borders, with biennials that flower the first season, as also perennials. Plant anemone and ranunculus roots and the corms of gladiolus. Transplant from the nursery to their final sites annuals sown in autumn, with biennials and herbaceous plants. Propagate perennials from root-slips and offsets. Continue to propagate the finer sorts of dahlias, both by cuttings and by division of the roots. Finish the pruning of all deciduous trees and hedges as soon as possible. Attend to the dressing of shrubberies; lay turf-edgings, and regulate the surface of gravel walks.

APRIL

Kitchen Garden.—Sow asparagus, sea-kale, Turnip-rooted beet, salsify, scorzonera, skirret, carrots and onions on heavy soils; also marrow peas, Longpod and Windsor beans, turnips, spinach, celery,

cabbage, savoy and Brussels sprouts for succession. Sow broccoli and kidney-beans both in the second and in the last week, and lettuces and small salads twice or thrice during the month; sow all herbs, if not done last month. Sow vegetable marrow. Plant cauliflower, cabbages, sea-kale, lettuce; and finish the planting of the main crops of potatoes; divide and replant globe-artichokes. Propagate all sorts of pot-herbs, and attend to the hoeing and thinning of spinach, onions, turnips, carrots, beet, &c. Earth up cabbages, cauliflower, peas, beans and early potatoes. Stake up peas; blanch sea-kale and rhubarb in the open air by covering with straw or leaves.

Fruit Garden.—If vines have been neglected to be pruned, rub off the buds that are not wanted; this is safer than pruning now. Protect the finer sorts of fruit trees on the walls. The hardier orchard-house fruits should now be moved outdoors under temporary awnings, to give the choicer fruits more space,—the roots being protected by plunging the pots. Mulch all newly-planted fruit trees, watering abundantly in dry weather.

Forcing.—Continue the preparation of succession beds and pits for cucumbers and melons. Sow; pot tomatoes and capsicums for succession. Pollinate tomatoes by hand to ensure early fruit on plants intended for outdoor culture. In the forcing-houses, from the variable state of the weather, considerable vigilance is required in giving air. Keep down red spider (*Acarus*) in the more advanced houses by frequent syringings and a well-moistened atmosphere. Continue the usual operations of disbudbing and thinning of fruit, and take care to keep up the proper temperatures.

Plant Houses.—Still sow tender annuals if required; also cinerarias and primulas. Proceed with all necessary shiftings. Propagate rare and fine plants by cuttings or grafting; increase bouvardias by cuttings, and grow on for winter flowering. Pot off tender annuals, and cuttings of half-hardy greenhouse plants put in during February to get them well established for use in the flower garden. Transfer chrysanthemums to sheltered positions out of doors, and provide means of protecting them from frost and cutting winds.

Flower Garden and Shrubbery.—Sow main or successional crops of annuals of all sorts—half-hardy annuals in warm borders, or on slight hotbeds. Biennials and perennials should be sown before the middle of the month. Plant out gladioli, if not done, tigridias and fine stocks. Finish the transplanting of herbaceous plants by the end of the first week. Cuttings of border chrysanthemums may now be dibbled in a warm spot out of doors. Protect stage auriculas and hyacinths from extremes of every description of weather; and tulips from hoar-frosts and heavy rains. Plant out tender deciduous trees and shrubs raised in pots; plant out tea-roses, mulching the roots. Remove part of the coverings of all tender shrubs and plants in the first week, and the remainder at the end of the month. Form and repair lawns and grass walks by laying turf and sowing perennial grass-seeds; mow the lawns frequently; plant evergreens.

MAY

Kitchen Garden.—Sow main crop of beet in the first week, small salads every week, radishes and lettuces thrice, spinach once a fortnight, carrots and onions for late drawing, kidney-beans in the first week and together with scarlet runners in the last fortnight; endive for an early crop; also peas and Longpod and Windsor beans, cauliflowers, Early York or Little Pixie cabbages, Brussels sprouts, borecole, broccoli, savoy and kale for late crops. Sow vegetable marrows and hardy cucumbers on a warm border in the last week; sow cardoons in trenches, or (in the north) in pots under glass shelter; sow chicory for salading. Continue hoeing and earthing up the several crops.

Fruit Garden.—Disbud peaches, nectarines and other early trees against the walls, also attend to the thinning of fruit. Give occasional washings with the engine to keep down insects. Pick caterpillars from gooseberries and wall trees on their first appearance. Remove from raspberries and strawberries all suckers and runners that are not wanted.

Forcing.—Plant melons and cucumbers on the hotbeds prepared for vegetables in February, and now free. Plant out vegetable marrows and pumpkins on dung-ridges, under hand-glasses. Sow late crops of cucumbers and melons.

Plant Houses.—Turn out hardy plants about the middle, and the more tender at the latter end of the month. Sow tender annuals for succession, potting and shifting those sown at an earlier period; sow cinerarias for succession; and a few hardy annuals and ten-week stock, &c., for late crops. Pot off all rooted cuttings. Put in cuttings of the different desirable species which are now fit for that purpose. Plant out in rich soil Richardias, to be potted up in autumn for flowering. Bedding plants should be placed to harden in sheltered positions out of doors towards end of month. Towards the end of the month many of the main stock of chrysanthemums will be ready for the final potting.

Flower Garden.—Sow annuals for succession in the last week, also biennials and perennials in the nursery compartment, for planting out next year. Propagate plants of which more stock is required either by cuttings or by dividing the roots. Plant out, during the last week, dahlias, hardy pelargoniums, stocks and calceolarias, protecting the dahlias from slight frosts. By the end of the month, masses of the following plants may be formed with

safety in warm localities:—pelargonium, heliotropium, fuchsia, petunia, nierenbergia, salvia, verberna, bouvardia and lobelia. Protect tulips, ranunculuses and anemones from the mid-day sun, and from rains and winds. Remove the coverings from all tender plants in the open air.

Shrubbery.—Transplant all kinds of evergreens, this month and September being the proper seasons. The rarer conifers should be planted now and in June, after they have commenced to grow. Proceed with the laying down of lawns and gravel-walks, and keep the former regularly mown.

JUNE

Kitchen Garden.—Sow kidney-beans for succession; also the wrinkled marrow peas and Seville Longpod and Windsor beans for late crops. Sow salading every ten days; also carrots, onions and radishes for drawing young; and chicory for salads; sow endive for a full crop. In the first week sow Early Munich and Golden Ball turnips for succession, and in the third week for a full autumn crop. Sow scarlet and white runner beans for a late crop, and cabbages for coleworts. Make up successional mushroom beds early in the month. Plant full crops of broccoli, Brussels sprouts, savoy, kales, leeks and early celery, with successional crops of cabbage and cauliflower. In the first fortnight of the month, plant hardy cucumbers for pickling, in a warm border, placing hand-glasses over them towards the end of the month. Plant out capsicums and tomatoes in sunny positions, and stake and tie securely. Pull and store winter onions, if ripe.

Fruit Garden.—Train and prune the summer shoots of wall and trellis and other trained trees. Mulch and water fruit trees and strawberries in dry weather, desisting when the fruit begins to ripen. Net over cherry-trees. Destroy aphides and other insects by syringing with tobacco water, or by fumigating, or by dusting with tobacco powder.

Forcing.—Proceed with planting melons, cucumbers and tomatoes. Keep up the necessary temperatures for the ripening of the various fruits. Ventilation will still require constant care. Tomatoes will now be fruiting freely; thin out judiciously, avoiding excessive pruning at one time. Attend to the gathering of fruit as it ripens.

Plant Houses.—These will now be occupied with tender greenhouse plants and annuals, and the more hardy plants from the stove. Shift, repot and propagate all plants that are desirable. Sow fragrant or showy annuals to flower in pots during winter; and grow on a set of decorative plants for the same object. Continue the final potting of chrysanthemums as the plants become ready.

Flower Garden.—Plant out dahlias and other tender subjects, if risk of frost is past. Take up bulbs and tuberous roots and dry them in the shade before removing them to the store-room. Fill up with annuals and greenhouse plants those beds from which the bulbs and roots have been raised. After this season, keep always a reserve of annuals in pots, or planted on beds of thin layers of fibrous matter, so as to be readily transplanted. Layer carnations and pipe pinks in the end of the month. Keep the lawns closely mown.

JULY

Kitchen Garden.—Watering will be necessary in each department, if the weather is hot and dry. In the first week, sow peas for the last crop of the season; also Longpod beans and French beans. In the last week, sow red globe or Chirk Castle turnip for a full winter crop, spinach for an early winter supply and Enfield Market cabbage for early summer use. Sow endive, for autumn and winter use, in the beginning and end of the month; also successional crops of lettuce and small salads. Make up successional mushroom beds. Plant full crops of celery, celeriac, endive about the middle and end of the month; late crops of broccoli, cauliflower and coleworts in the last week. Gather and dry herbs; also propagate these by slips and cuttings.

Fruit Garden.—Continue the pruning and training of wall and espalier trees, and the destruction of noxious insects. Pot strawberries for forcing next winter, and make new beds out of doors as soon as well-rooted runners can be obtained. Propagate the different sorts of stone fruit trees by budding on other trees or on prepared stocks. Gather fruits of all kinds as they ripen.

Forcing.—Prune melons and cucumbers, giving air and water and maintaining heat, &c. Continue the routine treatment in the tomato-houses. Feed the plants artificially as soon as good crops are set; do not wait for signs of distress. The forcing-houses ought to have abundance of fresh air and moisture where required, along with the necessary heat.

Plant Houses.—Ventilation will be necessary to keep down excessive heat; and attention must be paid to potting, shifting and putting in cuttings, and giving abundance of water to the potted plants, both indoors and out. Sow seed of herbaceous calceolarias; shift heaths, if they require it; cut down pelargoniums past flowering, and plant the cuttings.

Flower Garden and Shrubbery.—Take up the remaining tuberous roots, such as anemones, ranunculuses, &c., by the end of the first week; fill up their places, and any vacancies that may have occurred, with annuals or bedding plants from the reserve ground.

Propagate auriculars, and sow auricula seed in boxes under glass. Propagate herbaceous and other plants that have gone out of flower, by means of cuttings and slips, especially those required for spring bedding; propagate also the various summer bedding plants increased by cuttings. Increase roses and American shrubs, by layering, budding or cuttings, and go on with the layering of carnations and picotees. Stake and tie up dahlias and strong herbaceous plants.

AUGUST

Kitchen Garden.—Sow winter and spring spinach in the beginning and about the end of the month; parsley and winter onions, for a full crop, in the first week; cabbages about the middle of the month, for planting out in spring; cauliflower in the first half (Scotland) and in the second half (England) of the month; Hardy Hammersmith and Brown Cos lettuce in the first and last week; small salads occasionally; and Black Spanish radish, for winter crops. Plant out kales and broccoli for late crops; plant celery (earthing up the advancing crops as required), endive for succession, and a few coleworts. Take up shallots, garlic, &c.

Fruit Garden.—Proceed in training and regulating the summer shoots of all fruit trees as directed for the last three months. Net up, in dry weather, gooseberry and currant bushes, to preserve the fruit till late in the autumn. Make new strawberry beds if required. Preserve the ripening fruits on the wall and other trees from insects, and destroy wasp nests. Gather fruits as they ripen.

Forcing.—The routine of cultivation in hotbeds and pits may be continued. Sow tomatoes and cucumbers for a winter crop. Make up mushroom beds. In the forcing-houses, where the crops are past, part of the sashes may be removed, so as to permit thorough ventilation.

Plant Houses.—Attend to the propagation of all sorts of greenhouse plants by cuttings, and to the replacing in the greenhouse and stoves the more tender species, by the end of the month in ordinary seasons, but in wet weather in the second week. Sow half-hardy annuals, as *Nemophila*, *Collinsia*, *Schizanthus*, *Rhodanthe*, &c., to flower during winter.

Flower Garden and Shrubbery.—Sow in the second and the last week, on a warm border of a light sandy soil, with an east aspect, any free-flowering hardy annuals as *Silene pendula*, *Nemophila*, &c., for planting in spring; and auricula and primula seeds in pots and boxes. Propagate all sorts of herbaceous plants by rooted slips or suckers; take off layers of carnations, picotees and pansies. Plant cuttings of bedding plants, and of bedding pelargoniums in boxes for convenience of removal. Layer the tops of chrysanthemums, to obtain dwarf flowering plants. Transplant evergreens in moist weather, about the end of the month; and propagate them by layers and cuttings. Pot Neapolitan violets for forcing; or plant out on a mild hotbed. Clip box edgings.

SEPTEMBER

Kitchen Garden.—Sow small salad for late crops; and lettuce and spinach, if not done last month, for spring crops. Plant endive and lettuce at the foot of a south wall to stand the winter; plant out cabbages from the chief autumn sowing. Plant cauliflowers on a warm border in spaces such as can be protected by hand-lights. Thin the winter spinach, when large enough, that it may have space to grow. If broccoli be too rank or tall to withstand the winter, lift and lay nearly up to the neck in the earth, the heads sloping towards the north. Lift onions, and lay them out to ripen on a dry border or gravel-walk. Lift potatoes and store them.

Fruit Garden.—Finish the summer pruning and training. Where the walls are heated, assist the maturing of peaches and nectarines, and the ripening of the young wood for next year, by fires during the day. Gather and lay up in the fruit-room with care the autumnal sorts of apples and pears. Prepare borders and stations for fruit trees during dry weathers. Plant strawberries for a main crop. Repot orchard-house trees, disrooting if necessary.

Forcing.—Take care that late melons, cucumbers and tomatoes be not injured by getting too much water and too little air. Sow a few kidney beans for an early forced crop. Expel damp, and assist the ripening of late grapes and peaches with fires during the day. Prune early vines and peaches.

Plant Houses.—The various pot plants should now be put in their winter quarters. Keep up moderate temperatures in the stove, and merely repel frosts in the greenhouse, guarding against damp, by ventilation and by the cautious use of water. Pot hyacinths, tulips and other bulbs for forcing; and propagate half-hardy plants by cuttings. Begin the housing of the main stock of chrysanthemums.

Flower Garden, &c.—Sow in the beginning of this month all half-hardy annuals required for early flowering; also mignonette in pots, thinning the plants at an early stage; the different species of primula; and the seeds of such plants as, if sown in spring, seldom come up the same season, but if sown in September and October, vegetate readily the succeeding spring. Put in cuttings of bedding pelargoniums in boxes, which may stand outdoors exposed to the sun, but should be sheltered from excessive rains. Continue the propagation of herbaceous plants, taking off the layers of carnations, picotees,

pansies and chrysanthemums, by the end of the month; choice carnations and picotees may be potted and wintered in cold frames if the season is wet and ungenial. Plant evergreens; lay and put in cuttings of most of the hard-wooded sorts of shrubby plants.

OCTOBER

Kitchen Garden.—Sow small salad and radishes in the first week, and lettuces in frames on a shallow hotbed for planting out in spring. If the winter prove mild they will be somewhat earlier than those sown next month or in January. Plant parsley in pots or boxes to protect under glass in case very severe weather occurs. Plant cabbages in beds or close rows till wanted in spring; and cauliflowers in the last week, to receive the protection of frames, or a sheltered situation. Store potatoes, beet, salsify, scorzonera, skirret, carrots and parsnips, by the end of the month. Band and earth up cardoons.

Fruit Garden.—Such fruit trees as have dropped their leaves may be transplanted; this is the best season for transplanting (though with care it may be done earlier), whether the leaves have fallen or not. Protect fig-trees, if the weather proves frosty, as soon as they have cast their leaves. Plant out raspberries. The orchard-house trees should be got under glass before the end of the month. Gather and store all sorts of apples and pears, the longest-keeping sorts not before the end of the month, if the weather be mild.

Forcing.—Maintain the heat in hotbeds and pits by means of fresh dung linings. Give abundance of air in mild bright weather. Dress vines and peaches. Clean and repair the forcing-houses, and overhaul the heating apparatus to see it is in good working condition. Plant chicory in boxes or on hotbeds for blanching. Sow kidney beans. Make up successional winter mushroom beds.

Plant Houses.—Replace all sorts of greenhouse plants. Fill the pits with pots of stocks, mignonette and hardy annuals for planting out in spring, along with many of the hardy sorts of greenhouse plants; the whole ought to be thoroughly ventilated, except in frosty weather. From this time till spring keep succulent plants almost without water. Begin to force roses, hyacinths and a few other bulbs, for winter and early spring decoration. Plant hyacinths in glasses for windows. The last of the pot chrysanthemums should be housed by the end of the first week.

Flower Garden.—Sow a few pots of hardy annuals in a frame, or on a sheltered border, for successional spring use if required. Plant the greater part of the common border bulbs, as hyacinths, narcissi, crocuses and early tulips, about the end of the month, with a few anemones for early flowering. Transplant strong plants of biennials and perennials to their final situations; also the select plants used for spring bedding. Protect alpine plants, stage auriculars, and choice carnations and picotees with glass frames; and tea roses and other tender plants with bracken or other protective material. Take up, dry and store dahlias and all tender tubers at the end of the month; pot lobelias and similar half-hardy plants from the open borders. Transplant all sorts of hardy evergreens and shrubs, especially in dry soils, giving abundance of water. Put in cuttings of all sorts of evergreens, &c. Plant out the hardier sorts of roses.

NOVEMBER

Kitchen Garden.—Trench up all vacant ground as soon as cleared of its crops, leaving the surface as rough as possible. Sow early peas and Early Dwarf Prolific beans in the second week, for an early crop; also in frames for transplanting. Protect endive, celery, artichoke and sea-kale with stable-litter or fern, or by planting the former in frames; take up late cauliflower, early broccoli and lettuces, and place them in sheltered pits or lay them in an open shed; earth up celery; mature and dress up asparagus beds.

Fruit Garden.—Plant all sorts of fruit trees in fine weather—the earlier in the month the better. Protect fig-trees. Commence pruning and nailing. Gather and store the latest apples and pears. Examine the fruit-room and remove all decayed fruit.

Forcing.—Keep up the requisite degree of heat in hotbeds and pits. Cucumbers and tomatoes will require more than ordinary attention. Force asparagus, rhubarb and sea-kale, in the mushroom-house, in pits, or in the open border under boxes or cases surrounded and covered by well-fermented stable dung and leaves. Sow Early Horn carrot; also kidney beans and radishes, on hotbeds. In the forcing-houses prune and train the trees; fork over and dress the borders of such houses as have not been already done.

Plant Houses.—The directions for the greenhouse and conservatory in January apply also to this month generally. Continue the forcing of roses, hyacinths, &c. Houses containing large-flowered Japanese chrysanthemums will require to be kept dry, airy and moderately warm to prevent "damping-off" of petals.

Flower Garden, &c.—Plant dried tubers of border flowers, but the finer sorts had better be deferred till spring. Plant tulips in the early part of the month. Put in cuttings of bedding calceolarias, choosing the shoots that will not run up to flower. Protect such half-hardy plants as are not already sheltered. Plant deciduous trees and shrubs so long as the weather continues favourable, and before the soil has parted with the solar heat absorbed during summer. Dig and dress such flower borders and shrubberies as may now be cleared of annuals and the stems of herbaceous plants.

DECEMBER

Kitchen Garden.—Collect and smother-burn all vegetable refuse, and apply it as a dressing to the ground. Sow a few peas and beans, in case of accident to those sown in November, drawing up the soil towards the stems of those which are above ground as a protection; earth up celery; blanch endive with flower-pots; sow radishes in a very sheltered place. Attend to trenching and digging in dry weather.

Fruit Garden.—Plant all sorts of fruit trees in mild weather. Proceed with pruning and nailing wall-trees. Examine the fruit-room every week, removing promptly all decaying fruit.

Forcing.—The same degree of attention to hotbeds and pits will be necessary as in the last month. Continue the forcing of asparagus, rhubarb and sea-kale, in pits and in the mushroom-house. Proceed with the usual routine of culture commenced last month. Make the necessary preparations to begin forcing early or succession crops by the last week of this or the first of next month.

Plant Houses, Frames, &c.—Carnations and picotees in pots must be kept rather dry to prevent damping off. Heaths and Australian plants must be very sparingly watered, and kept with only fire heat enough to repel frost. Cut down plants of chrysanthemums, which should be placed in a cool pit, near the glass, in order to afford hard sturdy cuttings in February. Shy plants should be given gentle bottom heat to induce growth, which should be gently hardened by exposure under cooler conditions.

Flower Garden, &c.—Plant shrubs in open weather. Prune shrubs. Sweep and roll the lawns, and put in repair the gravel-walks, keeping the surface frequently rolled. (J. Ws.; W. R. W.)

(B) For the United States (chiefly for the latitude of New York).

JANUARY

Flower Garden and Greenhouse.—Little is to be done in either. In the greenhouse care must be used to protect against frost. Ventilate but little, and with care; raise the ventilating sash only high enough to let the heated air from the greenhouse drive back the outer air so as not to chill the plants. To destroy the red spider, syringe the plants copiously at night, and splash the paths with water. The aphid, or "green fly," must also be destroyed; tobacco may be used. Various new preparations are coming on the market for the destruction of greenhouse pests. Several new effective preparations of tobacco have been brought into use. The white-fly is now a common pest in greenhouses, the nymphs being greenish scale-like objects on the under sides of the leaves, and adults very small white flies. The remedy is to spray with kerosene emulsion or whale-oil soap; or if on cucumbers or tomatoes, it is best to fumigate with hydrocyanic acid gas, using one ounce of potassium cyanide to each 1000 cubic ft. of space. (This material is very poisonous.) Many greenhouse insects can be kept more or less in check by careful and effective hosing of the plants at proper times. At this season roses, grape vines and other plants are often affected by mildew; an effectual remedy is to paint the hot-water pipes with a mixture of sulphur and lime, put on as thick as ordinary white-wash, once each week until it is checked; but care must be taken not to apply it on any surface at a higher temperature than 212°. Hyacinths and other bulbs that have been kept in a cellar or other dark cool place may now be brought into the light of the greenhouse or sitting-room, provided they have filled the pots with roots. If they are not well rooted, leave them until they are, or select such of them as are best, leaving the others. In the outside flower garden little can be done except that shrubs may be pruned, or new work, such as making walks or grading, performed, if weather permits. See that the ornamental plants and trees are not injured by heavy weights of ice or snow.

Fruit Garden.—Pruning, staking up or mulching can be done if the weather is such that the workmen can stand out. In all warm or comfortable days the fruit trees may be pruned.

Grapery.—Graperies used for the forcing of foreign grapes may be started, beginning at a temperature of 50° at night, with 10° or 15° higher during the day. The borders must be covered sufficiently deep with leaves or manure to prevent the soil from freezing, as it would be destruction to the vines to start the shoots if the roots were frozen; hence, when forcing is begun in January, the covering should be put on in November, before severe frosts begin.

Vegetable Garden.—But little can be done in the northern states except to prepare manure, and get ashes, tools, &c., in working order; but in sections of the country where there is little or no frost the harder kinds of seeds and plants may be sown and planted, such as asparagus, cabbage, cauliflower, carrot, leek, lettuce, onion, parsnip, peas, spinach, turnip, &c. In any section where these seeds can be sown in open ground, it is an indication that hotbeds may be started for the sowing of such tender vegetables as tomatoes, egg and pepper plants, &c.; though, unless in the extreme southern states, hotbeds should not be started before the beginning or middle of February. Make orders for the spring seeds.

FEBRUARY

Flower Garden and Greenhouse.—The directions for January will in the main apply to this month, except that now some of the harder

annuals may be sown in hotbed or greenhouse, and also the propagation of plants by cuttings may be done rather better now than in January, as the greater amount of light gives more vitality to the cutting.

Fruit Garden.—But little can be done in most of the northern states as yet, and in sections where there is no frost in the ground it is likely to be too wet to work; but in many southern states this will be the best month for planting fruit trees and plants of all kinds, particularly strawberries, raspberries, blackberries, pear and apple trees, while grape vines will do, though they will also do well quite a month later. Continue the pruning. Fruit trees for spring planting should be ordered, if not already done.

Grapery.—The graperies started last month at 50° at night may now be increased to 60°, with a correspondingly higher day temperature. Great care must be taken to syringe the leaves thoroughly at least once a day, and to deluge the paths with water, so as to produce a moist atmosphere. Paint the hot-water pipes with sulphur mixture, as recommended in January.

Vegetable Garden.—Leaves from the woods, house manure or refuse hops from breweries may be got together towards the latter part of this month, and mixed and turned to get "sweetened" preparatory to forming hotbeds. Cabbage, lettuce and cauliflower seeds, if sown early this month in hotbed or greenhouse, will make fine plants if transplanted into hotbed in March. This is preferable to the use of fall-sown plants. Manure that is to be used for the crop should be broken up as fine as possible, for the more completely manure of any kind can be mixed with the soil the better the crop will be, and, of course, if it is dug or ploughed in in large unbroken lumps it cannot be properly commingled.

MARCH

Flower Garden and Greenhouse.—The long days and bright sunshine will now begin to tell on the plants under glass. Examine all plants that are vigorous and healthy; if the roots have matted the "ball" of earth they must be shifted into a larger-sized pot. Plants from cuttings struck last month may now be shifted, and the propagation of all plants that are likely to be wanted should be continued. Hardier kinds of annuals may be sown; it is best done in shallow boxes, say 2 in. deep.

Lawns can be raked off and mulched with short manure, or rich garden earth where manure cannot be obtained. Flower-beds on light soils may be dug up so as to forward the work of the coming busy spring season. Lawns may be benefited by a good dressing, in addition to the manure, of some reliable commercial fertilizer. If the lawn is thin in spots, these places may be raked over heavily and new grass seed sown.

Fruit Garden.—In many sections, planting may now be done with safety, provided the soil is light and dry, but not otherwise. Although a tree or plant will receive no injury when its roots are undisturbed in the soil should a frost come after planting, the same amount of freezing will, and very often does, greatly injure the plant if the roots are exposed.

Grapery.—The grapery started in January will have set its fruit, which should be thinned by one-third. The temperature may now be further advanced to 70° at night, with 15° higher in the daytime. The same precautions must be used against mildew and insects as given in January. Graperies wanted for succession may be started in February or this month.

Vegetable Garden.—This is a busy month. In localities where the frost is out of the ground, if it is not wet, seeds of the hardier vegetables can be sown. The list of seeds given for the southern states in January may now be used at the north, while for most of the southern states tender vegetables, such as egg plant, okra, sweet potatoes, melon, squash, potatoes, tomatoes, &c., may be sown and planted. Hotbeds must now be all started. In March flower seeds and vegetable seeds may be sown in boxes or flats in the greenhouse, or in residence windows, or near the kitchen stove. Unless one has space under glass, or in hotbeds, in which the plants may be transplanted before they are set in the open ground, it is well not to start the seeds too early, inasmuch as the plants are likely to become too large or to be pot-bound, or to become drawn.

APRIL

Flower Garden and Greenhouse.—Window and greenhouse plants require more water and ventilation. Due attention must be paid to shifting well-rooted plants into larger pots; and, if space is desired, many kinds of hardier plants can be safely put out in cold frames. Towards the end of the month it may be necessary slightly to shade the glass of the greenhouse. All herbaceous plants and hardy shrubs may be planted in the garden. The covering of leaves or litter should be taken off bulbs and tender plants that were covered up for winter, so that the beds can be lightly forked and raked. Sow tender annual flower seeds in boxes inside.

Fruit Garden.—Strawberries that have been covered up with straw or leaves should be relieved around the plants, leaving the covering between them. Special care must be exercised that the mulch be not left on too long; the plants should not become whitened or "drawn." Raspberries, grape vines, &c., that have been laid down may now be uncovered and tied up to stakes or trellises, and all new

plantations of these and other fruits may now be made. Fruit trees may be grafted.

Vegetable Garden.—Asparagus, rhubarb, spinach, &c., should be uncovered, and the beds hoed or dug lightly. Hardier sorts of vegetable seeds and plants, such as beets, cabbage, cauliflower, celery, lettuce, onions, parsley, parsnips, peas, potatoes, radishes, spinach, turnip, &c., should all be sown or planted by the middle of the month if the soil is dry and warm, and in all cases, where practicable, before the end of the month. It is essential, in sowing seeds now, that they be well firmed in the soil. Any who expect to get early cabbage, cauliflower, lettuce or radishes, while planting or sowing is delayed until the time of sowing tomato and egg plant in May, are sure to be disappointed of a full crop. Frequent rotation of crops should be practised in the vegetable garden, in order to head off insects and diseases; and also to make the best use of the land. Every three or four years the vegetable garden should be laid out in some new place; but if this cannot be done, the crops should be rotated on different parts of the old garden.

MAY

Flower Garden and Greenhouse.—Window and greenhouse plants should be in their finest bloom. Firing may be entirely dispensed with, though care must still be exercised in ventilating. If weather is cold and backward, however, and in very northern regions, care must be taken not to stop firing too soon, or the plants will mildew and become stunted. Every precaution must be used to keep the air moist. "Moss culture" may be tried, the common sphagnum or moss of the swamps, mixed with one-twentieth of its bulk of bone-dust, being laid as a mulch on the top of the earth of the flower-pots; its effect is to shield the pots from the sun, and at the same time stimulate the roots to come to the surface. By the end of the month all of the plants that are wanted for the summer decoration of the flower border may be planted out, first loosening a little the ball of earth at the roots. If the weather is dry, water freely after planting. When the greenhouse is not to be used during the summer months, camellias, azaleas and plants of that character should be set out of doors under partial shade; but most of the other plants usually grown in the conservatory or window garden in winter may be set in the open border. Flower-beds should be kept well hoed and raked, to prevent the growth of weeds next month.

Pelargoniums, pinks, monthly roses and all the half-hardy kinds of flowering plants should be planted early, but coleus, heliotrope and the more tender plants should be delayed until the end of the month. Annuals that have been sown in the greenhouse or hotbed may be planted out, and seeds of such sorts as mignonette, sweet alyssum, Phlox Drummondii, portulaca, &c., may be sown in the beds or borders. The china aster is now one of the most popular of summer and fall plants. The seed may be sown in the north as late as the middle of May, or even the first of June, with good results for fall blooming. If the plants are started early in the greenhouse, they are likely to spend themselves before fall, and therefore a later sowing should be provided.

Lawns should be mown, and the edgings trimmed.

Fruit Garden.—The hay or leaf mulching on the strawberry beds should be removed and the ground deeply hoed (if not removed in April in the more forward places), after which it may be placed on again to keep the fruit clean and the ground from drying. Where it has not been convenient before, most of the smaller fruits may yet be planted during the first part of the month. Tobacco dust will dislodge most of the numerous kinds of slugs, caterpillars or worms that make their appearance on the young shoots of vines or trees. Fruit trees may be planted this month, if they were not planted in March or April. If they have been kept fresh and dormant, they should still be in good condition. The broken roots should be cut back to fresh wood, and the tops should be headed back in proportion.

Vegetable Garden.—Attention should be given to new sowings and plantings for succession. Crops sown last month will have to be thinned out if large enough. Hoe deeply all transplanted crops, such as cabbage, cauliflower, lettuce, &c. Tender vegetables, such as tomatoes, egg and pepper plants, sweet potatoes, &c., can be planted out. Seeds of Lima beans, sweet corn, melon, okra, cucumbers, &c., should be sown; and sow for succession peas, spinach, lettuce, beans, radishes, &c., every ten days.

JUNE

Flower Garden and Greenhouse.—Tropical plants can now be used to fill up the greenhouse during the summer months. It should be well shaded, and fine specimens of fancy caladiums, dracaenas, colcas, crotons, palms, ferns and such plants as are grown for the beauty of their foliage, will make a very attractive show. If these cannot be had, common geraniums may be used. The "moss culture" will be found particularly valuable for these plants. Hyacinths, tulips and other spring bulbs may be dug up, dried and placed away for next fall's planting, and their places filled with bedding plants, such as coleus, achyranthes, pelargoniums, and the various white and coloured leaf plants. It will be necessary to mow the lawn once a week, and sometimes oftener.

Fruit Garden.—The small fruits should be mulched about the roots, if this has not yet been done. If the fruit garden is large enough to

admit of horse culture, it is best to keep the bush-fruits well cultivated during the season; this tillage conserves the moisture and helps to make a full and plump crop of berries. In small areas the mulching system is sometimes preferable.

Vegetable Garden.—Beets, beans, carrots, corn, cucumbers, lettuce, peas and radishes may be sown for succession. This is usually a busy month, as many crops have to be gathered, and, if hoing is not promptly seen to, weeds are certain to give great trouble. Tomatoes should be tied up to trellises or stakes if fine-flavoured and handsome fruit is desired, for if left to ripen on the ground they are apt to have a gross earthy flavour.

JULY

Flower Garden and Greenhouse.—Watering, ventilating and fumigating (or the use of tobacco in other forms for destruction of aphides) must be attended to. The atmosphere of the greenhouse must be kept moist. Watch the plants that have been plunged out of doors, and see if any require repotting. All plants that require staking, such as dahlias, roses, gladioli and many herbaceous plants, should now be looked to. Carnations and other plants that are throwing up flower stems, if wanted to flower in winter, should be cut back, that is, the flower stems should be cut off to say 3 in. from the ground. **Fruit Garden.**—If grape vines show any signs of mildew, dust them over with dry sulphur, selecting a still warm day. The fruit, having now been gathered from strawberry plants, if new beds are to be formed, the system of layering the plants in small pots is the best. In general, field strawberries are not grown from potted layers, but from good strong layers that strike naturally in the field. In the north, spring planting of strawberries is generally advised for market conditions; although planting in early fall or late summer is successful when the ground is well prepared and when it does not suffer from drought. Where apples, pears, peaches, grapes, &c., have set fruit thickly, thin out at least one-half to two-thirds of the young fruit.

Vegetable Garden.—The first ten days of this month will yet be time enough to sow sweet corn, beets, lettuce, beans, cucumbers and ruta-baga turnips. Such vegetables as cabbage, cauliflower, celery, &c., wanted for fall or winter use, are best planted this month, though in some sections they will do later. Keep sweet potatoes hoed to prevent the vines rooting at the joints.

AUGUST

Flower Garden and Greenhouse.—But little deviation is required in these departments from the instructions for July. See that sufficient water is applied; the walks may be wet in the houses.

Fruit Garden.—Strawberries that have fruited well now be making "runners," or young plants. These should be kept cut off close to the old plant, so that the full force of the root is expended in making the "crowns" or fruit buds for next season's crop. If plants are required for new beds, only the required number should be allowed to grow, and these may be layered in pots as recommended in July. The old stems of raspberries and blackberries that have borne fruit should be cut away, and the young shoots thinned to three or four canes to each hill or plant. If tied to stakes and topped when 4 or 5 ft. high, they will form three or four branches on a cane, and will make stronger fruiting plants for next year.

Vegetable Garden.—Hoe deeply such crops as cabbage, cauliflower and celery. The earthing up of celery this month is not to be recommended, unless a little very early supply is wanted. Onions in many sections can be harvested. The proper condition is when the tops are turning yellow and falling down. They are dried best by placing them in a dry shed in thin layers. Sow spinach for fall use, but not yet for the winter crop. Red top, white globe, and yellow Aberdeen turnips should now be sown; ruta-baga turnips sown last month will need thinning, and in extreme southern states they may yet be sown.

SEPTEMBER

Flower Garden and Greenhouse.—The flower-beds in the lawn should be at their best. If planted in "ribbon lines" or "massing," strict attention must be given to pinching off the tops, so that the lines or masses will present an even surface. Tender plants will require to be put in the greenhouse or housed in some way towards the end of this month; but be careful to keep them as cool as possible during the day. Cuttings of bedding plants may now be made freely if wanted for next season, as young cuttings rooted in the fall make better plants for next spring's use than old plants, in the case of such soft-wooded plants as pelargoniums, fuchsias, verbenas, heliotropes, &c.; with roses and plants of a woody nature, however, the old plants usually do best. Dutch bulbs, such as hyacinths, tulips, crocus, &c., and most of the varieties of lilies, may be planted. Violets that are wanted for winter flowering will now be growing freely, and the runners should be trimmed off. Sow seeds of sweet alyssum, candytuft, daisies, mignonette, pansies, &c. Visit the roadsides and woods for interesting plants to put in the hardy borders.

Fruit Garden.—Strawberry plants that have been layered in pots may yet be planted, or in southern districts the ordinary ground layers may be planted. The sooner in the month both are planted the better crop they will give next season; and, as these plants soon

make runners, it will be necessary to trim them off. Attend to raspberries and blackberries as advised for last month, if they have not already been attended to. All fruit trees should be gone over for borers before cold weather sets in; they also should have been gone over for the same purpose in May and June.

Vegetable Garden.—If cabbage, cauliflower and lettuce are wanted to plant in cold frames, the seed should be sown from about the 10th to the 20th of this month; but judgment should be exercised, for, if sown too early, cabbage and cauliflower are apt to run to seed. The best date for latitude of New York is September 15th. The main crop of spinach or sprouts that is wanted for winter or spring use should be sown about the same date. The earth should be drawn up to celery with a hoe preparatory to earthing up with a spade. Onions that were not harvested and dried last month must now be attended to. Turnips of the early or flat sorts may yet be sown the first week of this month in the northern states, and in the south from two to four weeks later.

OCTOBER

Flower Garden and Greenhouse.—In northern sections of the United States, tender plants that are still outside should be got under cover as early as possible. Delay using fire heat as long as possible, unless the nights become so cold as to chill the plants inside the house. Roses, carnations, camellias, azaleas, pelargoniums and the hardier sorts of plants will do better if placed in a cold frame or pit until the middle of November than they would in an ordinary greenhouse. Look out for insects. Fall bulbs of all kinds may be planted. Take up summer-flowering bulbs and tubers, such as dahlias, tuberose, gladioli, cannas, caladiums, tigridias, and dry them off thoroughly, stowing them away afterwards in some place free from frost and moisture during the winter. Before winter sets in see that the lawn is freely top-dressed. Be careful not to mow the grass too short in fall.

Fruit Garden.—Strawberries that have been grown from pot-grown layers may yet be planted in southern states; keep the runners trimmed off. Fruit trees and shrubs may be set out; but, if planting is deferred to the last of the month, the ground around the roots should be mulched to the thickness of 3 or 4 in. with straw, leaves or rough manure, as a protection against frost. The fruit garden must be protected from the ravages of mice in winter. Mice will nest about the plants if there is straw or other litter around them. Before winter, all tall grass and loose litter should be taken away; if this is not done, then the first snow should be tramped heavily around the plants, in order to destroy any nesting-places.

Vegetable Garden.—Celery will now be in full growth, and will require close attention to earthing up, and during the last part of the month the first lot may be stored away in trenches for winter. All vegetable roots not designed to be left in the ground during the winter should be dug up, such as beets, carrots, parsnips, sweet potatoes, &c. The cabbage, cauliflower and lettuce plants grown from seed sown last month should be pricked out in cold frames. If lettuce is wanted for winter use, it may now be planted in the greenhouse or cold frame, and will be ready for use about Christmas. If asparagus or rhubarb is wanted for winter use, it should be taken up and stowed away in pit, frame, shed or cellar for a month or two. It may then be taken into the greenhouse and packed closely together under the stage, and will be fit for use from January to March, according to the temperature of the house. Vegetable gardens often become infested with diseases that are carried over from year to year in the old plants and litter; this is especially true of water-melons and of some diseases of tomatoes. It is well, therefore, to burn the tops of the plants in the fall, rather than to plough them under or to throw them on the compost heap.

NOVEMBER

Flower Garden and Greenhouse.—Plants intended to be grown inside should now all be indoors. Keep a sharp look-out for cold snaps, as they come very unexpectedly in November, and many plants are lost thereby. In cases where it is not convenient to use fire heat, 5° to 10° of cold can be resisted by covering the plants over with paper, and by using this before frost has struck the plants valuable collections may be saved. When fire heat is freely used, be careful to keep up the proper amount of moisture by sprinkling the paths with water. Little can be done in the flower garden, except to clean off all dead stalks, and straw up tender roses, vines, &c., and, wherever there is time, to dig up and rake the borders, as it will greatly facilitate spring work. Cover up all beds in which there are hyacinths, tulips and other bulbs with a litter of leaves or straw to the depth of 2 or 3 in. If short, thoroughly-decayed manure can be spared, a good sprinkling spread over the lawn will help it to a finer growth next spring.

Fruit Garden.—Strawberry beds should be covered (in cold sections) with hay, straw or leaf mulching, to a depth not exceeding 2 in. Fruit trees and grape vines generally should be pruned; and, if the wood of the vine is wanted for cuttings, or scions of fruit trees for grafts, they should be tied in small bundles and buried in the ground until spring. They may be taken in December or January if preferred.

Vegetable Garden.—Celery that is to be stored for winter use should

be put away before the end of the month in all sections north of Virginia; south of that it may be left in most places, where grown throughout the winter if well covered up. The stalks of the asparagus bed should be cut off, and burned if there are berries on them, as the seeds scattered in the soil sometimes produce troublesome weeds. Mulch the beds with 2 or 3 in. of rough manure. All vegetable roots that are yet in the ground, and not designed to be left there over winter, must be dug up in this latitude before the middle of the month or they may be frozen in. Cover up onions, spinach, sprouts, cabbage or lettuce plants with a covering of 2 or 3 in. of leaves, hay, or straw, to protect them during the winter. Cabbages that have headed may usually be preserved against injury by frost until the middle of next month, by simply pulling them up and packing them closely in a dry spot in the open field with the heads down and roots up. On approach of cold weather in December they should be covered up with leaves as high as the tops of the roots, or, if the soil is light, it may be thrown over them, if leaves are not convenient. Cabbages will keep this way until March if the covering has not been put on too early. Plough all empty ground if practicable, and, whenever time will permit, do trenching and subsoiling. Cabbage, cauliflower and lettuce plants that are in frames should be regularly ventilated by lifting the sash on warm days, and on the approach of very cold weather they should be covered with straw mats or shutters. In the colder latitudes, and even in the middle states, it is absolutely necessary to protect cauliflower in this way, as it is much more tender than cabbage and lettuce plants.

DECEMBER

Flower Garden and Greenhouse.—Close attention must be paid to protecting all tender plants, for it is not uncommon to have the care of a whole year spoiled by one night's neglect. Vigilance and extra hot fires will have to be kept up when the thermometer falls to 34° or 35° in the parlour or conservatory. It is well to set the plants under the benches or on the walls of the greenhouses; if they are in the parlour move them away from the cold point, and protect them with paper; this will usually save them even if the thermometer falls to 24° or 26°. Another plan in the greenhouse is to dash water on the pipes or flues, which causes steam to rise to the glass and freeze there, stopping up all the crevices. With plants outside that require strawing up or to be mulched, this will have now to be finished.

Fruit Garden.—In sections where it is an advantage to protect grape vines, raspberries, &c., from severe frost, these should be laid down as close to the ground as possible, and covered with leaves, straw or hay, or with a few inches of soil. Grapes may be pruned. Fruit trees may be pruned from now till March in the north.

Vegetable Garden.—Celery in trenches should receive the final covering for the winter, which is best done by leaves or light stable litter; in the latitude of New York it should not be less than 12 in. thick. Potatoes, beets, turnips or other roots in pits, the spinach crop in the ground, or any other article in need of protection, should be attended to before the end of the month; manure and compost heaps should be forwarded as rapidly as possible, and turned and mixed so as to be in proper condition for spring. Remove the snow that accumulates on cold frames or other glass structures, particularly if the soil which the glass covers was not frozen before the snow fell; it may remain on the sashes longer if the plants are frozen in, since they are dormant, and would not be injured if deprived of light for eight or ten days. If roots have been placed in cellars, attention must be given to ventilation, which can be done by making a wooden box, say 6 by 8 in., to run from the ceiling of the cellar to the eaves of the building above. (L. H. B. F. H.)



BIBLIOGRAPHY OF MODERN WORKS ON HORTICULTURE.—W. Robinson, *Alpine Flowers*; Lord Redesdale (A. B. Freeman Mitford), *The Bamboo Garden*; J. Weathers, *Bulbous Plants* (33 col. plates); H. H. Cousins, *Chemistry of the Garden*; W. Watson, *Cactus Culture for Amateurs*; R. P. Brotherton and M. R. Smith, *Book of the Carnation*; J. Weathers, *Collage and Allotment Gardening*; J. Veitch and Sons, *Manual of Coniferæ*; W. Wells, *Culture of the Chrysanthemum*; Rev. S. E. Bourne, *Book of the Daffodil*; Geo. Nicholson, *Dictionary of Gardening* (5 vols.); W. Robinson, *The English Flower Garden*; Geo. Schneider, *Book of Choice Ferns* (3 vols.); W. Robinson, *Flora and Sylva* (3 vols.); col. plates by the late H. G. Moon; J. Weathers, *Flowering Trees and Shrubs* (33 col. plates); J. Weathers, *French Market-Gardening and Intensive Cultivation*; T. Smith, *French Gardening*; Geo. Bunyard and O. Thomas, *The Fruit Garden*; Josh. Brace, *Fruit Trees in Pots*; Dr R. Hogg, *The Fruit Manual*; M. C. Cooke, *Fungoid Pests of Cultivated Plants*; Thos. H. Mawson, *The Art and Craft of Garden-Making*; J. Weathers, *A Practical Guide to Garden Plants*; W. Watson, *The Gardeners' Assistant*; C. H. Wright and D. Dewar, *The Gardeners' Dictionary*; J. Weathers, *Garden Flowers for Town and Country* (33 col. plates); Chas. Baltet, *The Art of Grafting and Budding*; W. Thomson, *The Grape Vine*; Thos. Baines, *Greenhouse and Stove Plants*; R. Irwin Lynch, *The Book of the Iris*; G. Jekyll, *Lilies for English Gardens*; E. A. Ormerod, *Manual of Injurious Insects*; Dr A. B. Griffiths, *Manures for Fruit and other Trees*; F. W. Burbridge and J. G. Baler, *The Narcissus* (48 col. plates); H. A. Burberry, *The Orchid Cultivator's Handbook*; B. S. Williams, *The Orchid Grower's Manual*;

J. Veitch & Sons, *Manual of Orchidaceous Plants*; Dr Paul Sauerer and F. E. Weiss, *Physiology of Plants*; W. Watson, *Orchids, their Culture and Management*; G. Massoe, *Plant Diseases*; Rev. A. Foster-Melliar, *Book of the Rose*; Wm. Paul, *The Rose Garden* (20 col. plates); G. Jekyll and E. Mawley, *Roses for English Gardens*; J. Weathers, *Roses for Garden and Greenhouse* (33 col. plates); *Nat. Rose Society, Handbook on Pruning Roses*; Rev. J. H. Pemberton, *Roses, their History, Development and Culture*; Very Rev. Dean Hole, *A Book about Roses*; J. Hoffmann, *The Amateur Gardener's Rose Book* (20 col. plates; translated from the German); A. Gaut, *Seaside Planting of Trees and Shrubs*; E. Beckett, *Book of the Strawberry*; W. Iggulden, *The Tomato*; J. Weathers, *Trees and Shrubs for English and Irish Gardens* (33 col. plates); Vilmorin et Cie., *The Vegetable Garden* (Eng. ed. by W. Robinson); A. F. Barron, *Vines and Vine Culture*; G. Jekyll, *Wall and Water Gardens*; W. Robinson, *The Wild Garden*; L. H. Bailey, *Practical Garden Book* (New York, 1908). (J. Ws.; W. R. W.)

HORTON, CHRISTIANA (c. 1696-c. 1756), English actress, first appeared in London as Melinda in *The Recruiting Officer* in 1714 at Drury Lane. Here she remained twenty years, followed by fifteen at Covent Garden. At both houses during this long career she played all the leading tragedy and comedy parts, and Barton Booth (who "discovered" her) said she was the best successor of Mrs. Oldfield. She was the original Mariana in Fielding's *Miser* (1733).

HORTON, ROBERT FORMAN (1855-), British Nonconformist divine, was born in London on the 18th of September 1855. He was educated at Shrewsbury school and New College, Oxford, where he took first classes in classics. He was president of the Oxford Union in 1877. He became a fellow of his college in 1879, and lectured on history for four years. In 1880 he accepted an influential invitation to become pastor of the Lyndhurst Road Congregational church, Hampstead, and subsequently took a very prominent part in church and denominational work generally. He delivered the Lyman Beecher lectures at Yale in 1893; in 1898 he was chairman of the London Congregational Union; and in 1903 of the Congregational Union of England and Wales. In 1909 he took a prominent part in the 75th anniversary celebration of Hartford Theological Seminary. His numerous publications include books on theological, critical, historical, biographical and devotional subjects.

HORTON, SAMUEL DANA (1844-1895), American writer on bimetalism, was born in Pomeroy, Ohio, on the 16th of January 1844. He graduated at Harvard in 1864, and at the Harvard Law School in 1868, studied Roman law in Berlin in 1869, and in 1871 was admitted to the Ohio bar. He practised law in Cincinnati, and then in Pomeroy until 1885, when he gave up law for the advancement of bimetalism. His attention had been turned to monetary questions by the "greenback campaign" of 1875 in Ohio, in which, as in former campaigns, he had spoken, particularly effectively in German, for the Republican party. He was secretary of the American delegation to the Monetary Conference which met in Paris in 1878, and edited the report of the delegation. To the conference of 1881 he was a delegate, and thereafter he spent much of his time in Europe, whither he was sent by President Harrison in 1889 as special commissioner to promote the international restoration of silver. He died in Washington, D.C., on the 23rd of February 1895. Horton's principal works were *The Silver Pound* (1887) and *Silver in Europe* (1890), a volume of essays.

HORUS (Egyptian *Hôr*), the name of an Egyptian god, if not of several distinct gods. To all forms of Horus the falcon was sacred; the name *Hôr*, written with a standing figure of that bird,  is connected with a root signifying "upper," and probably means "the high-flyer." The tame sacred falcon on its perch  is the commonest symbol of divinity in early hieroglyphic writing; the commonest title of the king in the earliest dynasties, and his first title later, was that which named him Horus. Hawk gods were the presiding deities of Poi (Pe) and Nekhen, which had been the royal quarters in the capitals of the two primeval kingdoms of Upper and Lower Egypt, at Buto and opposite El Kab. A principal festival in very early times

was the "worship of Horus," and the kings of the prehistoric dynasties were afterwards called "the worshippers of Horus." The Northern Kingdom in particular was under the patronage of Horus. He was a solar divinity, but appears very early in the Osiris cycle of deities, a son of Isis and probably of Osiris, and opponent of Sêth. On monuments of the Middle Kingdom or somewhat later we find besides *Hôr* the following special forms: *Har-behet*, i.e. *Hôr* of Beht, the winged solar disk, god of Edfu (*Apollinopolis Magna*); *Har-khentkhai*, god of Athribis; *Har-mesen* (whose principal sacred animal was a lion), god of the Sethroite (?) nome; *Har-khentemma*, i.e. the blind (?) Horus (with a shrew-mouse) at Letopolis; *Har-mert* ("of two eyes") at Pharaethus; *Har-akht*, *Ra-har-akht*, or *Har-m-akhi* (Harmakhis, "Hor of the horizon"), the sun-god of Heliopolis.

As a sun-god Horus not only worsted the hostile darkness and avenged his father, but also daily renewed himself. He was thus identical with his own father from one point of view. In the mythology, especially that of the New Kingdom, or of quite late times, we find the following standing epithets applied to more or less distinct forms or phases: *Har-ent-yotf*, i.e. "Hôr, avenger of his father (Osiris)"; *Harpokhrates* (*Har-p-khrat*), i.e. "Hôr the child," with finger in mouth, sometimes seated on a lotus-flower; *Harsiesis* (*Har-si-Esi*), i.e. "Hôr, son of Isis," as a child; *Har-en-khêbi*, "Hôr in Chemmis," a child nursed by Isis in the papyrus marshes; *Harocris* (*Har-ufi*), i.e. "the elder Hôr," at Ombos, &c., human-headed or falcon-headed; *Harsemtesu* (*Har-sem-teu*), i.e. "Hôr, uniter of the two lands," and others.

In the judgment scene Horus introduces the deceased to Osiris. To the Greeks Horus was equivalent to Apollo, but in the name of Hermopolis Parva (see DAMABHUR), which must have been among the first of the Egyptian cities to be known to them, he was apparently identified with Hermes. Although the falcon was the bird most properly sacred to Horus, not only its varieties, but also the sparrow-hawk, kestrel and other small hawks were mummified in his honour in late times.

See EGYPT: section *Religion*; Meyer, art. "Horus" in *Röcher, Lexicon der Griech. und Röm. Mythologie*. (F. L. G.)

HORWICH, an urban district in the Westhoughton parliamentary division of Lancashire, England, 4 m. W.N.W. of Bolton, on the Lancashire and Yorkshire railway. Pop. (1901) 15,084. It lies beneath the considerable elevation of Rivington Pike, where formerly was a great forest. It has extensive locomotive works, and there are large stone quarries in the district. Bleaching and cotton-spinning and the manufacture of fire-bricks and tiles are carried on.

HOSANNA, the cry of praise or adoration shouted in recognition of the Messiahship of Jesus on his entry into Jerusalem (Matt. xxi. 9, 15; Mark xi. 9 sq.; John xii. 13), and since used in the Christian Church. It is also a Jewish liturgical term, and was applied specifically to the "hosanna" branches carried in procession in the Feast of Booths or Tabernacles, the seventh day of which was called the Hosanna-day (so also in Syrian usage; cf. "Palm" Sunday). This festival (for which see Lev. xxiii. 39 sqq.; 2 Macc. x. 7; Jos. Ant. xii. 10, xiii. 15; and the Talmudic tractate *Sukkah*) already suggested a Dionysiac celebration to Plutarch (*Symp.* iv. 6), and was associated with a ceremonial drawing of water which, it was believed, secured fertilizing rains in the following year; the penalty for abstinence was drought (cf. Zech. xiv. 16 sq.). The evidence (see further *Ency. Bib.* cols. 3354, 4880 sqq.; I. Levy, *Rev. des Ét. juives*, 1901, pp. 192 sqq.) points to rites of nature-worship, and it is possible that in these the term Hosanna had some other application.

The old interpretation "save, now!" which may be a popular etymology, is based on Pa. *crvii*. 25 (Heb. *hōshi'ah-sad*), but this does not explain the occurrence of the word in the Gospels, a complicated problem, on which see the articles of J. H. Thayer in *Hastings's Dict. Bib.*, and more especially T. K. Cheyne, *Ency. Bib.* s.v.

HOSE (a word common to many Teutonic languages; cf. Dutch, *hoos*, stocking, Ger. *Hose*, breeches, tights; the ultimate origin is unknown), the name of an article of dress,

used as a covering for the leg and foot. The word has been used for various forms of a long stocking covering both the foot and leg (see HOUSAV), and this is the usual modern sense. But it also formerly meant a kind of gaiter covering the leg from the knee to the ankle only, of the long tight covering for the whole of the lower limbs, and later of the short puffed or slashed breeches worn with the doublet—at this period, from the early part of the 16th century onwards, comes the distinction between the "hose" or "trunk hose" and the stocking (see COSTUME). The term is applied to certain objects resembling such a covering, as in its application to flexible rubber or canvas piping used for conveying water (see HOSEPIPE), and in botany, to the "sheath" covering, e.g. the ear of corn. The term "hose-in-hose" is thus used in botany for a flower in which the corolla has become doubled, as though a second were inserted in the throat of the first; it occurs sometimes in the primrose.

HOSEA, the son of Beeri, the first in order of the minor prophets of the Old Testament. The name Hosea (*וֹשֵׁעַ*, LXX. *Ἰωσὴφ*; Vulg. *Osee*, and so the English version in Rom. ix. 25) ought rather to be written Hoshah, and is identical with that borne by the last king of Ephraim, and by Joshua in Num. xiii. 16, Deut. xxxii. 44. Of the life of Hosea¹ we know nothing beyond what can be gathered from his prophecies. That he was a citizen of the northern kingdom appears from the whole tenor of the book, but most expressly from i. 2, where "the land," the prophet's land, is the realm of Israel, and vii. 5, where "our king" is the king of Samaria. The date at which Hosea flourished is given in the title, i. 1, by the reigning kings of Judah and Israel. He prophesied (1) in the days of Uzziah, Jotham, Ahaz and Hezekiah, kings of Judah; (2) in the days of Jeroboam the son of Joash, king of Israel. The dates indicated by the title, which may be regarded as editorial, are, for the four kings of the southern kingdom, 789-740, 739-734, 733-722 and 720-693 A.C. respectively; and, for Jeroboam II., 782-743 (cf. *Ency. Bib.* col. 797-798). The book itself, however, plainly belongs to the period prior to 734 B.C. since, in that year, (a) the Syro-Ephraimite war began, to which there is here no reference, nor is Assyria yet the open foe it then became; (b) Gilead became Tiglath-Pileser's (2 Kings xv. 29), whereas it is here described as still part of the territory of Israel (vi. 8; xii. 11; cf. the included place-names of v. 1). On the other hand, the prophet connects with the birth of his eldest child the approaching fall of the house of Jehu (i. 4), thus anticipating the death of Jeroboam II. in 743, and the period of anarchy which followed (2 Kings xv.). Thus the prophetic work of Hosea may be dated, with practical certainty, as beginning from some point previous to 743 and extending not later than 734.² This is corroborated by the general character of the book. Of its two parts, i.-iii. reflects the wealth and prosperity of the reign of Jeroboam II., whilst iv.-xiv. contains frequent references to the social disorder and anarchy of the subsequent years.

¹ *Traditions about Hosea.*—Beeri, the prophet's father, is identified by the Rabbins with Beerah (1 Chron. v. 6), a Reubenite prince carried captive by Tiglath-Pileser. This view is already expressed by Jerome, *Quaest. in Paralip.* and doubtless underlies the statement of the Targum to Chronicles that Beerah was a prophet. For it is a Jewish maxim that when a prophet's father is named, he, too, was a prophet, and accordingly a tradition of R. Simon makes Isa. viii. 19, 20 a prophecy of Beeri (Kimchi *in loc.*; *Leviticus Rabba*, par. 15). According to the usual Christian tradition, however, Hosea was of the tribe of Issachar, and from an unknown town, Belemoth or Belemon (pseudo-Epiphanius, pseudo-Dorotheus, Ephraem Syr. ii. 234; *Chron. Pasch.*, Bonn ed., l. 276). As the tradition adds that he died there, and was buried in peace, the source of the story lies probably in some holy place shown as his grave. There are other traditions as to the burial-place of Hosea. A Jewish legend in the *Shalshet ha-gabala* (Carpov, *Introd.*, pt. iii. ch. vii. § 3) tells that he died in captivity at Babylon, and was carried to Upper Galilee, and buried at *nea*, that is, Safed (Neubauer, *Géog. du Talmud*, p. 227); and the Arabs show the grave of Nebi 'Osha, east of the Jordan, near Es-Salt (Baedeker's *Palestine*, p. 337; Burckhardt's *Syria*, p. 353).

² The supposed reference of viii. 9-10 to the tribute paid by Menahem to Tiglath-Pileser (2 Kings xv. 19), and dated, on the monuments, 738 B.C., depends on a corrupt text; read v. 10 with Septuagint.

The first part of Hosea's prophetic work, corresponding to chs. i.-iii., lay in the years of external prosperity immediately preceding the catastrophe of the house of Jehu in or near the year 743. The second part of the book is a summary of prophetic teaching during the subsequent troublous reign of Menahem, and, perhaps, that of his successor, Pekahiah, and must have been completed before 734 B.C. Apart from the narrative in chs. i.-iii., to which we shall presently recur, the book throws little or no light on the details of Hosea's life. It appears from ix. 7, 8, that his prophetic work was greatly embarrassed by opposition: "As for the prophet, a fowler's snare is in all his ways, and enmity in the house of his God." The enmity which had its centre in the sanctuary probably proceeded from the priests (comp. Amos vii.), against whose profligacy and profanation of their office our prophet frequently declaims—perhaps also from the degenerate prophetic guilds which had their seats in the holy cities of the northern kingdom, and with whom Hosea's elder contemporary Amos so indignantly refuses to be identified (Amos vii. 14). In ch. iv. 5 Hosea seems to comprise priests and prophets in one condemnation, thus placing himself in direct antagonism to all the leaders of the religious life of his nation. He is not less antagonistic to the kings and princes of his day (vii. 3-7, viii. 4, viii. 10 Septuagint, x. 7-15, xiii. 11).³ In view of the familiarity shown with the intrigues of rulers and the doings of priests, it has been conjectured that Hosea held a prominent position, or even (by Duhm) that he was himself a priest (Marti, p. 2).

The most interesting problem of Hosea's history lies in the interpretation of the story of his married life (chs. i.-iii.). We read in these chapters that God's revelation to Hosea began when in accordance with a divine command he married a profligate wife, Gomer, the daughter of Diblaima. Three children were born in this marriage and received symbolical names, illustrative of the divine purpose towards Israel, which are expounded in ch. i. In ch. ii. the faithlessness of Israel to Jehovah (Yahweh), the long-suffering of God, the moral discipline of sorrow and tribulation by which He will yet bring back His erring people and betroth it to Himself for ever in righteousness, love and truth, are depicted under the figure of the relation of a husband to an erring spouse. The suggestion of this allegory lies in the prophet's marriage with Gomer, but the details are worked out quite independently, and under a rich multiplicity of figures derived from other sources. In the third chapter we return to the personal experience of the prophet. His faithless wife had at length left him and fallen, under circumstances which are not detailed, into a state of misery, from which Hosea, still following her with tender affection, and encouraged by a divine command, brought her back and restored her to his house, where he kept her in seclusion, and patiently watched over her for many days, yet not readmitting her to the privileges of a wife.

In these experiences the prophet again recognizes a parallel to Yahweh's long-suffering love to Israel, and the discipline by which the people shall be brought back to God through a period in which all their political and religious institutions are overthrown. Throughout these chapters personal narrative and prophetic allegory are interwoven with a rapidity of transition very puzzling to the modern reader; but an unbiased exegesis can hardly fail to acknowledge that chs. i. and iii. narrate an actual passage in the prophet's life. The names of the three children are symbolical, but Isaiah in like manner gave symbolical names to his sons, embodying prominent points

³ Some scholars hold that his attack is directed against the very principle of monarchy (Nowack, p. 8; Smend, p. 200: "Hosea rejects the kingship in itself"; Wellhausen, p. 125: "The making of kings in Israel is for him, together with the heathen cultus, the fundamental evil"). This view depends on a disputed interpretation of the reference to Gibeath (x. 9; cf. ix. 9); and on the words: "I give thee kings in mine anger, and I take them away in my wrath" (xiii. 11), which may refer to the rise and fall of contemporary kings (cf. Marti, *ad loc.*). In any case, as Wellhausen himself says (p. 132): "He does not start in from a dogmatic theory, but simply from historical experience."

in his prophetic teaching (Shear-jashub, Isa. vii. 3, comp. x. 21; Maher-shalah-hash-baz, viii. 3). And the name of Gomer bath Diblaim is certainly that of an actual person, upon which all the allegorists, from the Targum, Jerome and Ephraem Syrus downwards, have spent their arts in vain, whereas the true symbolical names in the book are perfectly easy of interpretation.¹ That the ancient interpreters take the whole narrative as a mere parable is no more than an application of their standing rule that everything in the Biblical history is allegorical which in its literal sense appears offensive to propriety (comp. Jerome's preface to the book). But the supposed offence to propriety seems to rest on mistaken excess and too narrow a conception of the way in which the Divine word was communicated to the prophets.² There is no reason to suppose that Hosea knowingly married a woman of profligate character. The point of the allegory in i. 2 is plainly infidelity after marriage as a parallel to Israel's departure from the covenant God, and a profligate wife (גִּיְוָנָה) is not the same thing with an open prostitute (זֶמֶר). The marriage was marred by Gomer's infidelity; and the struggle of Hosea's affection for his wife with this great unhappiness—a struggle inconceivable unless his first love had been pure and full of trust in the purity of its object—furnished him with a new insight into Yahweh's dealings with Israel. Then he recognized that the great calamity of his life was God's own ordinance and appointed means to communicate to him a deep prophetic lesson. The recognition of a divine command after the fact has its parallel, as Wellhausen observes, in Jer. xxxiii. 8.

It was in the experiences of his married life, and in the spiritual lessons opened to him through these, that Hosea first heard the revealing voice of Yahweh (i. 2).³ Like Amos (Amos iii. 8), he was called to speak for God by an inward constraining voice,

¹ Theodorus Mops. remarks very justly, καὶ τὸ ὄνομα καὶ τὸν πατέρα λέγει, ὅτι μὴ πλάσμα ψάλο τε δοταὶ τὸ ἀεχέμενον, ἱστορία δὲ ἀληθὴς τὸν πραγματικόν.

² This explanation of the narrative, which is essentially Ewald's, is now generally accepted. It has the great advantage of supplying a psychological key to the conception of Israel or the land of Israel (i. 2) as the spouse of Yahweh, which dominates these chapters, but in the later part of the book gives way to the personification of the nation as God's son. This conception has, indeed, formal points of contact with notions previously current, and even with the ideas of Semitic heathenism. On the one hand, it is a standing Hebrew usage to represent the land as mother of its people, while the representation of worshippers as children of their god is found in Num. xxi. 29, where the Moabites are called children of Chemosh, and is early and widespread throughout the Semitic field (cf. *Trans. Bib. Arch.* vi. 438; *Jour. of Phil.* ix. 82). The combination of these two notions gives at once the conception of the national deity as husband of the land. On the other hand, the designation of Yahweh as Baal, which, in accordance with the antique view of marriage, means husband as well as lord and owner, was current among the Israelites in early times, perhaps, indeed, down to Hosea's age (ii. 16). Now it is highly probable that among the idolatrous Israelites the idea of a marriage between the deity and individual worshippers was actually current and connected with the immorality which Hosea often condemns in the worship of the local Baalim whom the ignorant people identified with Yahweh. For we have a Punic woman's name, γαρμω, "the betrothed of Baal" (*Euting, Punische Steine*, pp. 9, 15), and a similar conception existed among the Babylonians (Herod. i. 181, 182). But Hosea takes the idea of Yahweh as husband, and gives it an altogether different turn, filling it with a new and profound meaning, based on the psychical experiences of a deep human affection in contest with outraged honour and the willful self-degradation of a spouse. It can hardly be supposed that all that lies in these chapters is an abstract study in the psychology of the emotions. It is actual human experience that gives Hosea the key to divine truth.

³ Davidson (*D.B.* ii. 422) remarks that "it was not his misfortunes that gave Hosea his prophetic word. Israel's apostasy was plain to him, and he foreshadowed her doom in Jezreel, the name of his first child, before any misfortunes overtook him. At most, his misfortunes may at a later time have given a complexion to his prophetic thoughts." Wellhausen (p. 108) objects to the emergence of the call from the experience, on the ground that the name given to the first child gives no indication that Hosea had yet reached his specific message, the infidelity of his wife and of Israel, though it shows him already as a prophet. Marti (p. 15) agrees with Davidson in making the order (a) call, (b) marriage and birth of three children, (c) comprehension of the significance of the marriage for himself and for Israel. The statement made above must be interpreted of Hosea's specific message from Yahweh, as recorded in his book.

and there is no reason to think that he had any connexion with the recognized prophetic societies, or ever received such outward adoption to office as was given to Elisha. His position in Israel was one of tragic isolation. Amos, when he had discharged his mission at Bethel, could return to his home and to his friends; Hosea was a stranger among his own people, and his home was full of sorrow and shame. Isaiah in the gloomiest days of Judah's declensions had faithful disciples about him, and knew that there was a believing remnant in the land. Hosea knows no such remnant, and there is not a line in his prophecy from which we can conclude that his words ever found an obedient ear.

As already stated, this prophecy falls into two clearly distinguished sections,⁴ the former (i.-iii.), already dealt with, accounting for the general standpoint of the latter (iv.-xiv.). It is not possible to make any convincing subdivisions of this latter section (cf. G. A. Smith, i. p. 223) which is best regarded as a series of separate discourses on certain recurrent topics, viz. (a) the cultus, (b) the social disorder and immorality, (c) political tendencies (alliance with either Assyria or Egypt sought).⁵ In regard to each of these topics, the attitude of the prophet involves the discernment of present guilt, and the assertion of future punishment. For him the present condition of the people contained no germ or pledge of future amendment, and he describes the impending judgment, not as a sifting process (Amos ix. 9, 10) in which the wicked perish and the righteous remain, but as the total wreck of the nation which has wholly turned aside from its God. In truth, while the idolatrous feasts of Ephraim still ran their joyous round, while the careless people crowded to the high places, and there in unbridled and licentious mirth flattered themselves that their many sacrifices ensured the help of their God against all calamity, the nation was already in the last stage of internal dissolution. To the prophet's eye there was "no truth, nor mercy, nor knowledge of God in the land—nought but swearing, and lying, and killing, and stealing and adultery; they break out, and blood toucheth blood" (iv. 1, 2). The root of this corruption lay in total ignorance of Yahweh, whose precepts were no longer taught by the priests, while in the national calf-worship, and in the local high places, this worship was confounded with the service of the Canaanite Baalim. Thus the whole religious constitution of Israel was undermined. And the political state of the realm was in Hosea's eyes not more hopeful. The dynasty of Jehu, still great and powerful when the prophet's labours began, is itself an incorporation of national sin. Founded on the bloodshed of Jezreel, it must fall by God's vengeance, and the state shall fall with it (i. 4, iii. 4). This sentence stands at the head of Hosea's predictions, and throughout the book the civil constitution of Ephraim is represented as equally lawless and godless with the corrupt religious establishment. The anarchy that followed on the murder of Zachariah appears to the prophet as the natural decadence of a realm not founded on divine ordinance. The nation had rejected Yahweh, the only helper. And now the avenging Assyrian is at hand. Samaria's king shall pass away as foam on the water. Fortress and city shall fall before the ruthless invader, who spares neither age nor sex, and thistles shall cover the desolate altars of Ephraim.

In our present book of Hosea, this condemnatory judgment on contemporary Israel culminates in a chapter of appeal for penitence, with promise of divine forgiveness. The question of the authenticity of this and of other "restoration" passages forms the chief problem

⁴ Marti disregards this generally accepted division, arguing that (a) i.-iii. was not written earlier than iv.-xiv., (b) iii. is not Hoseanic, (c) it is much more akin to iv.-xiv. than to i.-iii. (*Comm.* p. 1; cf. *Exc. Bib.* 2123 n.3). He holds that another wife, not Gomer, is intended in iii., which is an allegory referring to Israel, as Gomer referred to Judah. His arguments are not convincing.

⁵ So, practically, Davidson, *D.B.* ii. p. 423 seq., where the detailed references will be found.

⁶ This is too definite for the data; cf. Davidson, *loc. cit.* "Hosea has no clear idea of the instrument or means of Israel's destruction. It is 'the sword' (vii. 16, xi. 6), the 'enemy' (viii. 3, v. 8-9); or it is natural, internal decay (vii. 8-9, ix. 16), the moth and rottenness (v. 12)."

⁷ e.g. i. 10-ii. 1, ii. 14 f., iii. 5, v. 15-vi. 3, xi. 10-11.

for literary criticism presented by the book.¹ Amongst the more recent commentators, Davidson, G. A. Smith and Nowack regard Hosea xiv. as written by the prophet, though the second admits its chronological misplacement and the third its later expansion. On the other hand, it is altogether rejected by Cheyne, Wellhausen, Marti and Harper. These claim that the passage reflects the later standpoint of completed punishment, and is therefore inconsistent in the prophet who anticipates that punishment. But the case is different from that of the epilogue to Amos, since Hosea's personal experience covers forgiveness as well as discipline (Marti consistently, though without ground, rejects this experience also). There seems, therefore, to be no sufficient evidence for denying thoughts of restoration to Hosea, whilst it is highly probable that such passages would be amplified in a later age. Indeed, the importance of these passages for the interpretation of Hosea is apt to be overrated, for, as one of those rejecting them remarks, though Hosea "promised nothing," yet he "contributed a conception of Yahweh which made such a future not only possible but even probable" (Harper, p. cliii.). We may therefore read the closing chapter as, at least, the explicit statement of a hope implicit in Hosea's teaching.

Hosea could discern no faithful remnant in Ephraim, yet Ephraim in all his corruption is the son of Yahweh, a child nurtured with tender love, a chosen people, whose past history declares in every episode the watchful and patient affection of his father. And that father is God and not man, the Holy One who will not and cannot sacrifice His love even to the justest indignation (chap. xi.). To the prophet who knows this love of Yahweh, who has learned to understand it in the like experience of his own life, the very ruin of the state of Israel is a step in the loving guidance which makes the valley of trouble a door of hope (ii. 15), and the wilderness of tribulation as full of promise as the desert road from Egypt to Canaan was to Israel of old. Of the manner of Israel's repentance and conversion Hosea presents no clear image—nay, it is plain that on this point he had nothing to tell. The certainty that the people will at length return and seek Yahweh their God rests, not on any germ of better things in Israel, but on the invincible supremacy of Yahweh's love. And so the two sides of his prophetic declaration, the passionate denunciation of Israel's sin and folly, and the not less passionate tenderness with which he describes the final victory of divine love, are united by no logical bond. The unity is one of feeling only, and the sob of anguish in which many of his appeals to a heedless people seem to end turns once and again with sudden revulsion into the clear accents of evangelical promise, which in the closing chapter swell forth in pure and strong cadence out of a heart that has found its rest with God from all the troubles of a stormy life.

The strongly emotional temperament of Hosea suggests comparison with that of Jeremiah, who like himself is the prophet of the decline and fall of a kingdom. The subsequent influence of Hosea on the literature of the Old and New Testaments is very marked. Not only is it seen in the conception of the relation between God and His people as a marriage, which he makes current coin (cf. Marti, p. 15), but still more in the fact that his conception of the divine character becomes the inspiration of the book of Deuteronomy and so of the whole canon of Scripture. "In a special degree, the author of Deuteronomy is the spiritual heir of Hosea."²

RECENT LITERATURE (where references to older works will be found): Cheyne, "Hosea" in *Cambridge Bible* (1884); W. R. Smith, *The Prophets of Israel*, with Cheyne's introduction (1895); G. A. Smith, "The Book of the Twelve," I, in *The Expositor's Bible* (1896); Nowack, *Die Kleinen Propheten* (1897); Wellhausen, *Die Kleinen Propheten* (1898); Smend, *Allgemeine Religionsgeschichte*, pp. 204 f. (1899); Davidson art. "Hosea" in *Hastings' Dictionary of the Bible*, ii. pp. 419 f. (1900); Marti, art. "Hosea" in *Ency.*

¹ Apart from glosses and minor alterations, the only other critical problem of importance is that of the references to *Judah* scattered throughout the book (i. 7, iv. 15, v. 5, v. 10 f., vi. 4, II, viii. 14, x. 11, xi. 12). There is no inherent improbability in some mention of the sister kingdom; but some of the actual references do suggest interpenetration, especially i. 7, where the deliverance of Judah from Sennacherib in 701 B.C. seems intended. Each case, as Wellhausen implies, is to be considered on its merits. On these and other suspected passages, cf. Cheyne, Intro. to W. R. Smith's *Prophets of Israel*, pp. xvii-xxii.; Marti, p. 8; Harper, p. clix.

² Driver, *Deuteronomy*, p. xxvii.

Biblica, ii. c. 2119 (1901) (a revision of the original article by W. R. Smith, in the *Ency. Britannica*, partially reproduced above); Marti, *Dodekapropheten* (1903); W. R. Harper, "Amos and Hosea" in *Inter. Critical Commentary* (1905) (with copious bibliography).

(W. R. S.; H. W. R.)

HOSE-PIPE, or simply "hose," the name given to flexible piping by means of which water may be conveyed from one place to another. One end of the pipe is connected to the source of the water, while the other end is free, so that the direction of the stream of water which issues from the pipe may be changed at will. The method of manufacture and the strength of the materials used depend naturally upon the particular use to which the finished article is to be put. Simple garden hose is often made of india-rubber or composition, but the hose intended for fire brigade and similar important purposes must be of a much more substantial material. The most satisfactory material is the best long flax, although cotton is also extensively used for many types of this fabric.

The flax fibre, after having been carefully spun into yarn, is boiled twice and then beetled; these two processes remove all injurious matter, and make the yarn soft and lustrous. The yarn is then wound on to large bobbins, and made into a chain; the number of threads in the chain depends upon the size of the hose, which may be anything from half an inch to 15 in. or even more in diameter. When the chain is warped, it is beamed upon the weaver's beam, and the ends—either double or triple—are drawn through the leaves of the cambs of heddles, passed through the reed and finally tied to the cloth beam. The preparation of the warp for any kind of loom varies very little, but the weaving may vary greatly. In all cases the hose fabric is essentially circular, although it appears quite flat during the weaving operation.

There are very few hand-made fabrics which can compete with the machine-made article, but the very best type of hose-pipe is certainly one of the former class. The cloth can be made much more cheaply in the power-loom than in the hand-loom, but, up to the present, no power-loom has been made which can weave as substantial a cloth as the hand-loom product; the weak part in all hose-pipes is where the weft passes round the sides from top to bottom of the fabric or vice versa, that is, the side corresponding to the selvages in an ordinary cloth; the hand-loom weaver can draw the weft tighter than is possible in the power-loom, hence the threads at the sides can be brought close together, and by this means the fabric is made almost, but not quite, as perfect here as in other parts. It is essential that the warp threads be held tightly in the loom, and to secure this, they pass alternately over and under three or four back rests before reaching the heddles or cambs, which are almost invariably made of wire. Although the warp yarn is made very soft and pliable by boiling and beetling, the weaver always tallows it in order to make it work more easily.

The commonest type of hose-pipe is made on the double-plain principle of weaving, the cloth being perfectly plain but woven in such a manner that the pipe is without seams of any kind. Fig. 1 is a design showing two repeats or eight shots in the way of the weft, and six repeats or twenty-four threads in the way of the warp, consequently the weave is complete on four threads, or leaves, and four picks. Fig. 2 illustrates the method of interlacing the threads

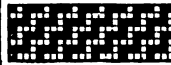

FIG. 1.



FIG. 2.

and the picks: this figure shows that twenty-three threads only are used, the first thread—shown shaded in fig. 1—having been left out. It is necessary to use a number of threads which is either *odd* or one more than some multiple of four—the number of threads in the unit weave. The sectional view (fig. 2), although indicating the crossings of the warp and the weft, is quite different from an actual section through the threads: the warp is almost invariably two or three ply, and in addition two or more of these twisted threads pass through the same heddle-eye in the camb; moreover, they are set very closely together—so closely, indeed, that the threads entirely conceal the weft; it is, therefore, impossible to give a correct

Sectional view with satisfactory cleanness, as the threads are so very rank, but fig. 3 gives some idea of the structure of the fabric. This view shows ninety-nine threads and one complete round of weft; this round is, of course, equal to two picks or shots—one pick for the top part of the cloth and one for the bottom part. A comparison of this figure with fig. 2 will, perhaps, make the description clearer. The weft in fig. 3 is thinner than the warp, but, in practice, it is always much thicker, and may consist of from two to seventy threads twisted together.

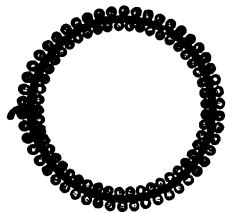

FIG. 3.—Section through the Warp.

Hose-pipes are also woven with the three-leaf twill on both sides, and occasionally with the four-leaf twill. These pipes, woven with the twill weaves, are usually lined with a pure rubber tube which is fixed to the inside of the cloth by another layer of rubber after the cloth leaves the loom. Such pipes have usually, but not invariably, a smoother inner surface than those which are unlined, hence, when they are used, less friction is presented to the flow of water, and there is less tendency for the pipe to leak. They are, therefore, suitable for hotels, public buildings and similar places where their temporary use will not result in undue damage to articles of furniture, carpets and general decoration.

The greatest care must be observed in the weaving of these fabrics, the slightest flaw in the structure rendering the article practically useless. After the cloth has been woven, it is carefully examined, and then steeped in a chemical solution which acts as an antiseptic. The cloth is thus effectively preserved from mildew, and is, in addition, made more pliable. Finally the hose-pipe is dried artificially, and then fitted with the necessary couplings and nozzles.

For a more detailed description of circular weaving see Woodhouse and Milne, *Textile Design: Pure and Applied.* (T. Wo.)

HOSHANGABAD, a town and district of British India, in the Nerbudda division of the Central Provinces. The town stands on the left bank of the Nerbudda, 1009 ft. above the sea, and has a railway station. Pop. (1901), 14,940. It is supposed to have been founded by Hoshang Shah, the second of the Ghori kings of Malwa, in the 15th century; but it remained an insignificant place till the Bhopal conquest about 1720, when a massive stone fort was constructed, with its base on the river, commanding the Bhopal road. It sustained several sieges during the 18th century, and passed alternately into the hands of the Bhopal and Nagpur rulers. Since 1818 it has been the residence of the chief British officials in charge of the district. It has a government high school, and agricultural school and a brass-working industry.

The **DISTRICT OF HOSHANGABAD** has an area of 3676 sq. m. Pop. (1901), 449,165, showing a decrease of 10% in the decade, due to famine. It may be described as a valley of varying breadth, extending for 150 m. between the Nerbudda river and the Satpura mountains. The soil consists chiefly of black basaltic alluvium, often more than 20 ft. deep; but along the banks of the Nerbudda the fertility of the land compensates for the tameness of the scenery. Towards the west, low stony hills and broken ridges cut up the level ground, while the Vindhya and the Satpuras throw out jutting spurs and ranges. In this wilder country considerable regions are covered with jungle. On the south the lofty range which shuts in the valley is remarkable in mountain scenery, surpassing in its picturesque irregularity the Vindhyan chain in the north. Many streams take their rise amid its precipices, then, winding through deep glens, flow across the plain between sandy banks covered with low jungle till they swell the waters of the Nerbudda. None is of any importance except the Tawa, which is interesting to the geologist on account of the many minerals to be found along its course. The boundary rivers, the Nerbudda and Tapi, are the only considerable waters in Hoshangabad. The principal crops are wheat, millets and oil-seeds. The district is traversed throughout its length by the Great Indian Peninsula railway.

HOSHEA (Heb. for "deliverance"), the last king of Israel, in the Bible. The attempt of his predecessor Pekah to take Jerusalem with the help of his ally Rasun (Rezin) of Damascus was frustrated by the intervention of Tiglath-Pileser IV. (see **ABAZ**), who attacked Gilead, Galilee and the north frontier,

and carried off some of its population (cp. 1 Chron. v. 26). Pekah's resistance to Assyria led to a conspiracy in which he lost his life, and Hoshea the son of Elah became king (2 Kings xv. 27-30). The Assyrian king held him as his vassal (and indeed claims to have set him on the throne), and exacted from him a yearly tribute. Meanwhile, Damascus was besieged (733-732 B.C.), Ragun was slain and the inhabitants deported (2 Kings xvi. 9; LXX. omits "to Kir," but see Amos i. 5). The impending fate of Damascus is illustrated by Isaiah (vii. 16; viii. 4, xviii. 1-11), who also gives a vivid description of the impression left by the Assyrian army (v. 26-30). After the death of Tiglath-Pileser, Israel regained confidence (Isa. ix. 8-x. 4) and took steps to recover its independence. Its policy vacillated—"like a silly dove" (Hos. vii. 11), and at length negotiations were opened with Mizraim. The annual payment of tribute ceased and Shalmaneser IV. (who began to reign in 727 B.C.) at once laid siege to Samaria, which fell at the end of three years (722-721 B.C.). The achievement is claimed by his successor Sargon. Hoshea was killed, the land was again partly depopulated and a governor appointed (2 Kings xviii. 9-12; cp. xvii. 1 sqq.). For other allusions to this period see **HOSEA**, **ISRAEL**.

2 Kings xvii. 3 and 5 imply two attacks by Shalmaneser: in the first of which Hoshea was imprisoned and perhaps blinded (Cheyne, emending, "shut him up" in v. 4), although in v. 6 he is still reigning; see on this Winckler, *Keitinschr. u. Alte Test.* p. 268; Burney, *Kings*, p. 328 seq.; Skinner, *Kings*, p. 372 seq. The chronological notes, moreover, are extremely confused; contrast xv. 30 with xvii. 1. The usual identification of So (or Seve), king of Mizraim, with Shabaka of Egypt is difficult, partly on chronological grounds (which Petrie, *History of Egypt*, pp. 277, 281 sqq. does not remove), and partly because the Ethiopian dominion in Egypt appears to be still weak and divided. The Assyrian records name a certain Sibi as officer, and also Piru (Pharaoh) as king of Museri, and it is doubtful whether Hoshea's ally was a petty prince of Egypt or of a N. Arabian district (see **MIZRAIM**). If the latter, Hoshea's policy becomes more intelligible; see Whitehouse, *Isaiah*, p. 17 seq.; *Jews: History*; **PHILISTINES**. On the depopulation of Samaria and the introduction of colonists, see Winckler's objections, *Alttest. Untersuch.* pp. 95-107, with Burney's criticisms, *Kings*, p. 334 seq. (S. A. C.)

HOSHIARPUR, a town of British India, in the Jullundur division of the Punjab. Pop. (1901), 17,549. It was founded, according to tradition, about the early part of the 14th century. In 1809 it was occupied by Ranjit Singh. The maharaja and his successors maintained a considerable cantonment 1 m. S.E. of the town, and the British government kept it up for several years after the annexation of the Punjab in 1849. There are manufactures of cotton goods, inlaid woodwork, lacquered ware, shoes and copper vessels.

The **DISTRICT OF HOSHIARPUR** comprises an area of 2244 sq. m.; pop. (1901) 989,782, showing a decrease of 2% in the decade, compared with an increase of 12% during the previous decade. It falls into two nearly equal portions of hill and plain country. Its eastern face consists of the westward slope of the Solar Singhi Hills; parallel with that ridge, a line of lower heights belonging to the Siwalik range traverses the district from south to north, while between the two chains stretches a valley of uneven width, known as the Jaswan Dun. Its upper portion is crossed by the Sohan torrent, while the Sutlej sweeps into its lower end through a break in the hills, and flows in a southerly direction till it turns the flank of the central range, and debouches westwards upon the plains. This western plain consists of alluvial formation, with a general westerly slope owing to the deposit of silt from the mountain torrents in the sub-montane tract. The Beas has a fringe of lowland, open to moderate but not excessive inundations, and considered very fertile. A considerable area is covered by government woodlands, under the care of the forest department. Rice is largely grown, in the marshy flats along the banks of the Beas. Several religious fairs are held, at Anandpur, Mukerian and Chintpurni, all of which attract an enormous concourse of people. The district, owing to its proximity to the hills, possesses a comparatively cool and humid climate. Cotton fabrics are manufactured, and sugar, rice and other grains, tobacco and indigo are among the exports.

The country around Hoshiarpur formed part of the old Hindu kingdom of Katoch in Jullundur. The state was eventually broken up, and the present district was divided between the rajahs of Ditarpur and Jaswan. They retained undisturbed possession of their territories until 1759, when the rising Sikh chieftains commenced a series of encroachments upon the hill tracts. In 1815 the aggressive maharaja, Ranjit Singh, forced the ruler of Jaswan to resign his territories in exchange for an estate on feudal tenure; three years later the raja of Ditarpur met with similar treatment. By the close of the year 1818 the whole country from the Sutlej to the Beas had come under the government of Lahore, and after the first Sikh war in 1846 passed to the British government. The deposed rajahs of Ditarpur and Jaswan received cash pensions from the new rulers, but expressed bitter disappointment at not being restored to their former sovereign position. Accordingly the outbreak of the second Sikh war, in 1848 found the disaffected chieftains ready for rebellion. They organized a revolt, but the two rajahs and the other ringleaders were captured, and their estates confiscated.

HOSIERY, a term used to designate all manufactured textile fabrics which in their process of manufacture have been built on the principle of looping or loop structure. The origin of the term is obvious, being derived from "hose" or stocking, this being one of the earliest garments made by the process of knitting (*q.v.*). While it still forms one of the staples of the trade, it is only one of a very numerous and diversified range of applications of the entire industry. The elastic structure of knitting makes it very adaptable for all kinds of body or underwear. There is scarcely a single textile article manufactured but can be reproduced on the knitting or loop structure principle. The art of knitting is of very modern origin as compared with that of weaving. No certain allusion to the art occurs before the beginning of the 15th century. In an act of parliament of Henry VII. (1488) knitted woollen caps are mentioned. It is supposed that the art was first practised in Scotland, and thence carried into England, and that caps were made by knitting for some period before the more difficult feat of stocking-making was attempted. In an act of Edward VI. (1553) "knitte hose, knitte peticoates, knitte gloves and knitte sleeves" are enumerated, and the trade of hosiers, among others, included in an act dated 1563. Spanish silk stockings were worn on rare occasions by Henry VIII., and the same much-prized articles are also mentioned in connexion with the wardrobe of Edward VI.

Knitting, or loop formation by mechanical means, is divided into two distinct principles—frame-work knitting and warp knitting. Both principles may be employed in the formation of a large variety of plain and fancy stitches or a combination of the two.

Frame-work Knitting in its simplest form consists of rows of loops supporting each other—built from one continuous thread of yarn and running from one side of the fabric to the other and back

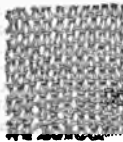

FIG. 1.—The Stitch or Loop Structure of Plain Knitting (back of fabric).



FIG. 2.—A Single Thread formed into a Chain of Crocket Work, showing the Loop Structure of the plain Warp-knitted Fabric. It is built up as shown in the diagram by a number of threads running up the fabric.

(fig. 1). It is on this principle of stitch that the greatest amount of hosiery is built (hose, shirts, pants).

Warp Knitting in its simplest form consists of rows of loops, but the number of threads employed are equal to the number of loops in the width of the fabric. Thus it will be seen that the threads run lengthwise of the fabric (fig. 2). This principle gives greater scope for reproducing designs in openwork and colour than that of

frame-work knitting. For this reason it is largely used in the shawl, glove and fancy hosiery industries.

Machinery.—In hand knitting the implements employed (a few needles or wires) are very simple and inexpensive. In the manu-

facturing industry the most complex and ingenious machinery is used.

In 1589 the Rev. William Lee, a graduate of St John's College, Cambridge, while acting as curate (or vicar) of Calverton, Nottinghamshire, introduced his stocking-frame.

This machine was the first mechanical means employed to produce a looped or knitted fabric. This frame or machine of Lee's was the origin of all the hosiery and lace machines at present in use.

One of the most remarkable points about his invention was its completeness and adaptability for the work for which its inventor intended it. The main principles of Lee's frame are embodied in most of the rotary or power frames of the present day.

Fig. 3 shows a hand frame of the present day.

In hand knitting an indefinite number of loops are skewered on a wire or pin, but, in Lee's frame, an individual hooked or bearded needle is employed for the support and formation of each loop in the breadth of the fabric. This needle consists of a shank with a terminal spring-pointed hook (or beard), the point of which can be pressed at will into a groove or eye in the shank. For method by which the loops are formed on the needles of the frame see fig. 4. This shows a few of Lee's hooked or bearded needles having the old loops or work hanging round the needle shanks. The thread of yarn which is to form the new row of loops is laid over the needle shanks and waved or looped between each pair of needles. This waving or looping ensures sufficient yarn being drawn and loops of a uniform size being made, so that a regular and level fabric will be produced. The looping or waving is obtained by having thin plates of shaped metal, called *sinkers*, which have a nose-shaped point

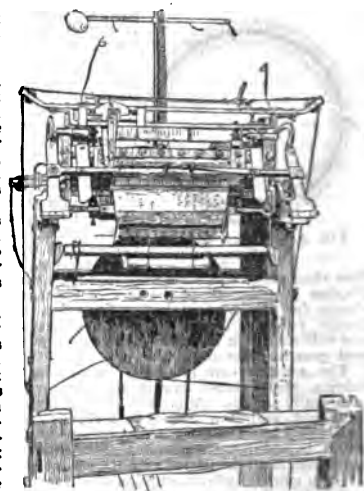

FIG. 3.—Hand Stocking Frame.

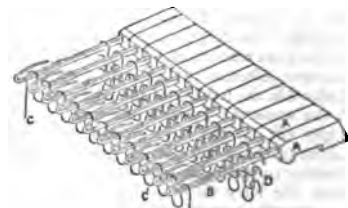

FIG. 4.

- A. The leads into which the needles (B) are cast.
D. The old loops or work.
C. The new loops formed and brought under the beards.

forward under the needle beards or hooks. A presser bar is now brought down to close or press all the points of the needle beards into the eye in the shank. Thus all the hook ends of the needles are temporarily closed, with the newly formed loops under them. While in this position, the old loops hanging round the shank are brought forward and landed on to the top of the needle beard and off the needle altogether, being thus left hanging round, or supported by the loops newly formed. The needle beards are now released, and the loops drawn back along the shanks to be in position for next new course of loops. The foregoing is only an outline of how the loops are formed on the needles. It is not necessary here to enter into a description of the complex mechanical movements of Lee's stocking-frame. The first fabric made by Lee was of a

flat, even-selvaged nature, so that garments had to be cut to shape from the fabric. He soon learned to fashion or shape the garment at will, during the process of making, by transferring loops

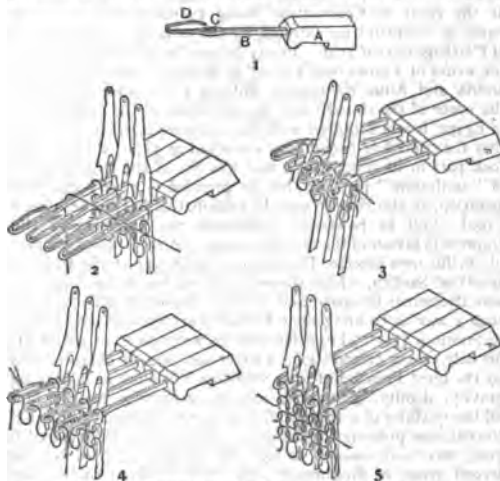

FIG. 5.—Formation of a Loop on a Hand Frame.

- 1, Bearded needle cast in the lead. A, Lead; B, Shank; C, Eye; D, Beard.
- 2, The thread is laid over the needles and formed into loops between the needles by means of the sinkers, those new-formed loops being brought under the needle beards (as at 3).
- 4, The beards pressed or closed to allow the old loops to be passed on to the top.
- 5, The old loops knocked off the needles and left hanging round the newly formed loops.

at the edges, inwards to narrow, or outwards to widen. This process at the present day is known as fashioning, and all garments of the best make are shaped or fashioned in this manner. After Lee had

practised his new art for a few years at Calverton he removed to London, but on his receiving no help or encouragement from Queen Elizabeth or her successor, King James, he was induced to cross over to France with his frames. There he built up a flourishing industry at Rouen, under the patronage of the French king, Henry IV. Through the murder of this monarch he lost his patronage and died of want about the year 1610. He was buried in an unknown grave in Paris.

A number of improvements had been made on Lee's frame during the 18th century. The one of greatest importance was the rib machine invented by Jedediah Strutt of Belper in 1758. It was not what could be actually termed an improvement on Lee's frame, but an addition to it. Lee's frame was not altered in any way, Strutt's machine being added to it, and the two being worked in conjunction produced a fabric of a more elastic nature and alike on both sides (fig. 6). Strutt's machine consisted of a set of needles placed at right angles to and between Lee's plain needles, with the result that, when knitting, the frame needles drew their loops to one side and the machine needles their loops to the opposite side of the fabric. The first offshoot from frame-work knitting was the invention of the hand warp loom in 1775. It was improved by the addition of the Dawson wheel by William Dawson in 1791. This machine is the origin of the various complex machines now working on this principle. Some of these have Jacquard mechanism attached, and nearly all of them are driven by motive power. About the middle of the 19th century close on 50,000 of Lee's hand frames were in use, finding employment for nearly 100,000 persons. Many attempts had been made previously to transform Lee's frame into a power or rotary frame. One of the first and most successful was that invented by Luke Barton in 1857. This frame was fitted with self-acting mechanism for fashioning, and was practically Lee's frame having rotary shafts with cams added to give the various movements, this type of frame being known as straight bar rotary frames. In 1864 William Cotton of Loughborough altered this frame by reversing the positions of the needles and sinkers. Although made by various builders it is still known as the "Cotton Patent Rotary Frame" (fig. 7). Since 1864 a great number of important improvements and additions have been made to this frame. Single frames are built which will turn off one dozen pairs of hose at once, with the attention of one person. One of the most important inventions in connexion with the hosiery trade was the latch, tumbler, or self-acting needle invented by Matthew Townsend and David Moulding of Leicester in 1858. Previous to this Lee's type of needle was the only one in use. This latch-needle (fig. 8) consists of a stem having a butt at lower end by which it receives its knitting action from cams,



FIG. 6.—A Rib Stitch.

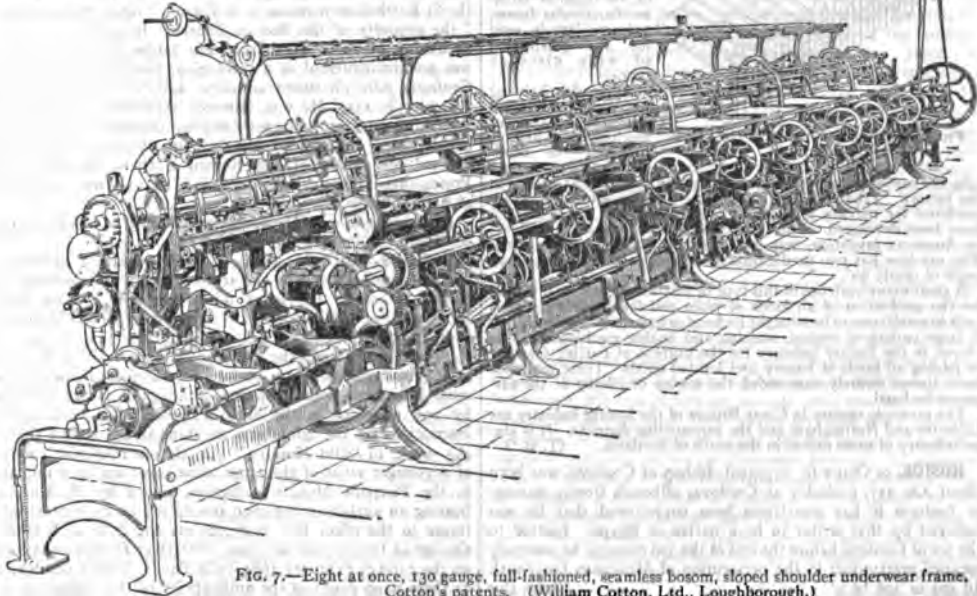

FIG. 7.—Eight at once, 130 gauge, full-fashioned, seamless bosom, sloped shoulder underwear frame, Cotton's patents. (William Cotton, Ltd., Loughborough.)

the upper end being turned into a hook. Near the hook end and attached to the stem by a pin is the spoon-shaped latch, which closes over the hook as required. Machines fitted with latch-needles have grooves in which the stem of the needle works.

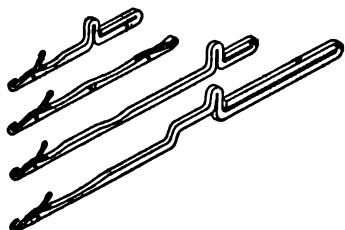

FIG. 8.—Various Shapes of the Latch Needle.

ing the latch open. When about to knit, they are raised individually and in rotation (by the cams acting on the needle butts) to receive the new loop of yarn.

Down till almost the middle of the 19th century only a flat web could be knitted in the machines in use, and for the finishing of stockings, &c., it was necessary to seam up the selvages of web shaped on the frame (fashioned work), or to cut and seam them from even web (cut work). The introduction of any device by which seamless garments could be fabricated was obviously a great desideratum, and it is a singular fact that a machine capable of doing this was patented in 1816 by Sir Marc I. Brunel. This frame was the origin of the French-German loop-wheel circular frame of the present day. Brunel's frame was greatly improved by Peter Claussen of Brussels and was shown at an exhibition in Nottingham in 1845. This frame had horizontal placed needles fixed on a rotating rim. A few years later Moses Mellor of Nottingham transformed this type of frame by altering the position of the needles to perpendicular. This is now known as the English loop-wheel circular frame. After the invention of the latch-needle there was a revolution in the hosiery machine-building industry, new types of machines being

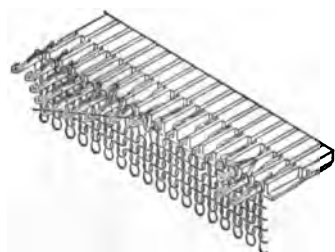

FIG. 9.—Individual Action of the Latch Needle.

Like the sewing machine it is largely used in the home as well as in the factory. From this machine all the circular automatic power machines for making plain and rib seamless hose and half hose have been developed. The "flat" or "lamb" type of machine, an American invention, was introduced by J. W. Lamb in 1863. This machine has two needle beds or rows of needles sloping at an angle of nearly 90°.

A great many varieties of this type of machine have been invented for the production of all kinds of plain and fancy hosiery. It is built in small sizes to be wrought by hand or in large power machines. A large variety of sewing, seaming and linking machines are employed in the hosiery industry for the purpose of putting together or joining all kinds of hosiery and knitted goods. These machines have almost entirely superseded the sewing or joining of the garments by hand.

The principle centres in Great Britain of the hosiery industry are Leicester and Nottingham and the surrounding districts. It is also an industry of some extent in the south of Scotland. (T. B.)

HOSIUS, or **OSRUS** (c. 257-359), bishop of Cordova, was born about A.D. 257, probably at Cordova, although from a passage in Zosimus it has sometimes been conjectured that he was believed by that writer to be a native of Egypt. Elected to the see of Cordova before the end of the 3rd century, he narrowly escaped martyrdom in the persecution of Maximian (303-305). In 305 or 306 he attended the council of Iliberis or Elvira (his

name appearing second in the list of those present), and upheld its severe canons concerning such points of discipline as the treatment of the lapsed and clerical marriages. In 313 he appears at the court of Constantine, being expressly mentioned by name in a constitution directed by the emperor to Caecilianus of Carthage in that year. In 323 he was the bearer and possibly the writer of Constantine's letter to Bishop Alexander of Alexandria and Arius his deacon, bidding them cease disturbing the peace of the church; and, on the failure of the negotiations in Egypt, it was doubtless with the active concurrence of Hosius that the council of Nicaea was convened in 325. He certainly took part in its proceedings, and was one of the large number of "confessors" present; that he presided is a very doubtful assertion, as also that he was the principal author of the Nicene Creed. Still he powerfully influenced the judgment of the emperor in favour of the orthodox party. After a period of quiet life in his own diocese, Hosius presided in 343 at the fruitless synod of Sardica, which showed itself so hostile to Arianism; and afterwards he spoke and wrote in favour of Athanasius in such a way as to bring upon himself a sentence of banishment to Sirmium (355). From his exile he wrote to Constantius II. his only extant composition, a letter not unjustly characterized by the great French historian Sebastian Tillemont as displaying gravity, dignity, gentleness, wisdom, generosity and in fact all the qualities of a great soul and a great bishop. Subjected to continual pressure the old man, who was near his hundredth year, was weak enough to sign the formula adopted by the second synod of Sirmium in 357, which involved communion with the Arians but not the condemnation of Athanasius. He was then permitted to return to his diocese, where he died in 359.

See S. Tillemont, *Mémoires*, vii. 300-321 (1700); Hefele, *Concilien-geschichte*, vol. i.; H. M. Gwatkin, *Studies of Arianism* (Cambridge, 1882, 2nd ed., 1900); A. W. W. Dale, *The Synod of Elvira* (London, 1882); and article *s.v.* in Herzog-Hauck, *Real-encyclopædie* (3rd ed., 1900), with bibliography.

HOSIUS, STANISLAUS (1504-1579), Polish cardinal, was born in Cracow on the 5th of May 1504. He studied law at Padua and Bologna, and entering the church became in 1549 bishop of Kulm, in 1551 bishop of Ermland, and in 1561 cardinal. Hosius had Jesuit sympathies and actively opposed the Protestant reformation, going so far as to desire a repetition of the St Bartholomew massacre in Poland. Apart from its being "the property of the Roman Church," he regarded the Bible as having no more worth than the fables of Aesop. Hosius was not distinguished as a theologian, though he drew up the *Confessio fidei christiana catholica* adopted by the synod of Piotrkow in 1557. He was, however, supreme as a diplomatist and administrator. Besides carrying through many difficult negotiations, he founded the lyceum of Braunsberg, which became the centre of the Roman Catholic mission among Protestants. He died at Capranica near Rome on the 5th of August 1579.

A collected edition of his works was published at Cologne in 1584. Life by A. Eichhorn (Mainz, 1854), 2 vols.

HOSKINS, JOHN (d. 1664), English miniature painter, the uncle of Samuel Cooper, who received his artistic education in Hoskins's house. His finest miniatures are at Ham House, Montagu House, Windsor Castle, Amsterdam and in the Pierpont Morgan collection. Vertue stated that Hoskins had a son, and Redgrave added that the son painted a portrait of James II. in 1686 and was paid £10, 5s. for it, a statement for which there must have been some evidence, although it is not supported by any reference in the State Papers. Some contemporary inscriptions on the miniatures at Ham House record them as the work of "Old Hoskins," but the fact of the existence of a younger artist of the same name is settled by a miniature in the Pierpont Morgan collection, signed by Hoskins, and bearing an authentic engraved inscription on its contemporary frame to the effect that it represents the duke of Berwick at the age of twenty-nine in 1700. The elder Hoskins was buried on the 22nd of February 1664, in St Paul's, Covent Garden, and as there is no doubt of the authenticity of this miniature or of

the signature upon it, it is evident that he had a son who survived him thirty-six years and whose monogram we find upon this portrait. The frame of it has also the royal coat of arms debruised, the batons of a marshal of France, the collar of the Golden Fleece and the ducal coronet. (G. C. W.)

HOSMER, HARRIET GOODHUE (1830-1908), American sculptor, was born at Watertown, Massachusetts, on the 9th of October 1830. She early showed marked aptitude for modelling, and studied anatomy with her father, a physician, and afterwards at the St Louis Medical College. She then studied in Boston until 1852, when, with her friend Charlotte Cushman, she went to Rome, where from 1853 to 1860 she was the pupil of the English sculptor John Gibson. She lived in Rome until a few years before her death. There she was associated with Nathaniel Hawthorne, Thorwaldsen, Flaxman, Thackeray, George Eliot and George Sand; and she was frequently the guest of the Brownings at Casa Guidi, in Florence. Among her works are "Daphne" and "Medusa," ideal heads (1853); "Puck" (1855), a spirited and graceful conception which she copied for the prince of Wales, the duke of Hamilton and others; "Oenone" (1855), her first life-sized figure, now in the St Louis Museum of Fine Arts; "Beatrice Cenci" (1857), for the Mercantile Library of St Louis; "Zenobia, Queen of Palmyra, in Chains" (1859), now in the Metropolitan Museum of Art, New York City; "A Sleeping Faun" (1867); "A Waking Faun"; a bronze statue of Thomas H. Benton (1868) for Lafayette Park, St Louis; bronze gates for the earl of Brownlow's art gallery at Ashridge Hall; a Siren fountain for Lady Marian Alford; a fountain for Central Park, New York City; a monument to Abraham Lincoln; and, for the Columbian Exposition, Chicago, 1893, statues of the queen of Naples as the "heroine of Gaëta," and of Queen Isabella of Spain. Miss Hosmer died at Watertown, Mass., on the 21st of February 1908.

HOSPICE (Lat. *hospitium*, entertainment, hospitality, inn, *hospes*, host), the name usually given to the homes of rest and refuge kept by religious houses for pilgrims and guests. The most famous hospices are those of the Great and Little St Bernard Passes in the Alps.

HOSPITAL (Lat. *hospitālis*, the adjective of *hospes*, host or guest), a term now in general use for institutions in which medical treatment is given to the sick or injured. The place where a guest was received was in Lat. *hospitium* (Fr. *hospice*), but the terms *hospitālis* (sc. *domus*), *hospitale* (sc. *cubiculum*) and *hospitālia* (sc. *cubicula*) came into use in the same sense. Hence were derived on the one hand the Fr. *hospital*, *hôpital*, applied to establishments for temporary occupation by the sick for the purpose of medical treatment, and *hospice* to places for permanent occupation by the poor, infirm, incurable or insane; on the other, the form *hôtel*, which became restricted (except in the case of *hôtel-Dieu*) to private or public dwelling-houses for ordinary occupation. In English, while "hostel" retained the earlier sense and "hotel" has become confined to that of a superior inn (*q.v.*), "hospital" was used both in the sense of a permanent retreat for the poor infirm or for the insane, and also for a regular institution for the temporary reception of sick cases; but modern usage has gradually restricted it mainly to the latter, other words, such as almshouse and asylum, being preferred in the former cases.

The Origin of Hospitals.—In spite of contrary opinions the germ of the hospital system may be seen in pre-Christian times (see CHARITY AND CHARITIES). Finel goes so far as to declare that there were asylums distinctly set apart for the insane in the temples of Saturn in ancient Egypt. But this is probably an exaggeration, the real historical facts pointing to the existence of medical schools in connexion with the temples generally, to the knowledge that the priests possessed what medical science existed, and finally to the rite of "Incubation," which involved the visit of sick persons to the temple, in the shade of which they slept, that the god might inform them by dreams of the treatment they ought to follow. The temples of Saturn are known to have existed some 4000 years before Christ; and that those temples were medical schools in their earliest form is beyond

question. The reason why no records of these temples have survived is due to the fact that they were destroyed in a religious revolution which swept away the very name of Saturn from the monuments in the country. Professor Georg Ebers of Leipzig, whose possession of that important handbook of Egyptian medicine called the *Papyrus Ebers* constitutes him an authority, says the Heliopolis certainly had a clinic united to the temple. The temples of Dendera, Thebes and Memphis, are other examples. Those early medical works, the Books of Hermes, were preserved in the shrines. Patients coming to them paid contributions to the priests. The most famous temples in Greece for the cure of disease were those of Aesculapius at Cos and Trikka, while others at Rhodes, Cnidus, Pergamum and Epidaurus were less known but frequented. Thus it is clear that both in Egypt and in Greece the custom of laying the sick in the precincts of the temples was a national practice.

Alexandria again was a famous medical centre. Before describing the European growth of the hospital system in modern times, to which its development in the Roman Empire is the natural introduction, it will be well to dispose very briefly of the facts relating to the hospital system in the East. Harun al-Rashid (A.D. 763-809) attached a college to every mosque, and to that again a hospital. He placed at Bagdad an asylum for the insane open to all believers; and there was a large number of public infirmaries for the sick without payment in that city. Benjamin, the Jewish traveller, notes an efficient scheme for the reception of the sick in A.D. 1173, which had long been in existence. The Buddhists no less than the Mahomedans had their hospitals, and as early as 260 B.C. the emperor Asoka founded the many hospitals of which Hindustan could then boast. The one at Surat, made famous by travellers, and considered to have been built under the emperor's second edict, is still in existence. These hospitals contained provision so extensive as to be quite comparable to modern institutions. In China the only records that remain are those of books of very early date dealing with the theory of medicine. To return to India, the hospitals of Asoka were swept away by a revival of Brahmanism, and a practical hiatus exists between the hospitals he introduced and those that were refounded by the British ascendancy. Hadrian's reign contains the first notice of a military hospital in Rome. At the beginning of the Christian era we hear of the existence of open surgeries (of various price and reputation), the specialization of the medical profession, and the presence of women practitioners, often as obstetricians. Iatria, or *tabernae-medicae*, are described by Galen and Placetus: many towns built them at their own cost. These iatria attended almost entirely to out-patients, and the system of medicine fostered by them continued without much development down to the middle of the 18th century. It is to be noted that these out-patients paid reasonable fees. In Christian days no establishments were founded for the relief of the sick till the time of Constantine. A law of Justinian referring to various institutions connected with the church mentions among them the *Nosocomia*, which correspond to our idea of hospitals. In A.D. 370 Basil had one built for lepers at Caesarea. St Chrysostom founded a hospital at Constantinople. At Alexandria an order of 600 Parabolani attended to the sick, being chosen for the purpose for their experience by the prelate of the city (A.D. 416). Fabiola, a rich Roman lady, founded the first hospital at Rome possessed of a convalescent home in the country. She even became a nurse herself. St Augustine founded one at his see of Hippo. These *Nosocomia* fell indeed almost entirely into the hands of the church, which supported them by its revenues when necessary and controlled their administration. Salerno became famous as a school of medicine; its rosier days were between A.D. 1000 and 1050. Frederick II. prescribed the course for students there, and founded a rival school at Naples. At this period the connexion between monasteries and hospitals becomes a marked one. The crusaders also created another bond between the church and hospital development, as the route they traversed was marked by such foundations. Lepers were some of the earliest patients for whom a specialised treatment was recognized,

and in 1119 a leprosarium was built in London for isolation purposes. Russia seems the one country where the interconnection of hospital and monastery was not to be observed. After the period already reached, the 13th century, hospitals became common enough to demand individual or at any rate national treatment.

History of the Hospital Movement.—We have now to consider the principles upon which the provision of the best form of medical care in hospitals can be secured for all classes of people. Though hospitals cannot be claimed as a direct result of Christianity, no doubt it softened the relations between men, and gradually tended to instil humanitarian views and to make them popular with the civilized peoples of the world. These principles, as civilization grew, education improved, and the tastes and requirements of the common people were developed, made men and women of many races realize that the treatment of disease in buildings set apart exclusively for the care of the sick was, in fact, a necessity in urban districts. The establishment of a hospital freed the streets of the abuses attendant upon beggars and other poor creatures, who made their ailments the chief ground of appeal for alms. As the knowledge of hygiene and of the doctrine of cleanliness and purity in regard not only to dwellings and towns, but also in relation to food of all descriptions, including water, became known and appreciated, hospitals were found to be of even greater importance, if that is possible, to the healthy in crowded communities, than to the sick. It took many centuries before sound hygiene really began to occupy the position of importance which it is now known to possess, not only in regard to the treatment and cure of disease, but to its prevention and eradication. So the history of the world shows, that, whereas a few of the larger towns in most countries contained hospitals of sorts, up to and including the middle ages, it was not until the commencement of the 18th century that inhabitants of important but relatively small towns of from 50,000 to 100,000 inhabitants began to provide themselves with a hospital for the care of the sick. Thus, twenty-three of the principal English counties appear to have had no general hospital prior to 1710, while London itself at that date, so far as the relief of the sick was concerned, was mainly, if not entirely, dependent upon St. Bartholomew's and St. Thomas's Hospitals. These facts are interesting to note, because we are enabled from them to deduce from recent events that hospital buildings in the past, though the planning of most of them was faulty to begin with and became more and more faulty as extensions were added to the original buildings, did in fact suffice to satisfy the requirements of the medical profession for nearly two centuries. In other words, under the old condition of affairs the life of a building devoted to the care of the sick might be considered as at least 150 years. To-day, under the conditions which modern science impose upon the management, probably few hospital buildings are likely to be regarded as efficient for the purpose of treating the sick for more than from 30 to 50 years.

The foregoing statement is based upon the history of British hospitals of importance throughout the country, but the same remark will apply in practice to hospital buildings almost everywhere throughout the world. In truth, hospitals have been more developed and improved in Great Britain than in other countries, though, since the last quarter of the 19th century, German scientists especially have added much to the efficiency of the accommodation for the sick, not only at hospitals but in private clinics, and many German ideas have been accepted and copied by other countries. In Great Britain hospitals for the treatment of general and special diseases are mainly maintained upon what is known as the voluntary system. On the European continent, hospitals as a rule are maintained by the state or municipalities, and this system is so fully developed in Sweden and elsewhere that a sound economical principle has been embrodered upon the hospital system, to the great physical and moral advantage of all classes of the community. The system referred to confers great benefits upon inhabitants in large towns by bringing the poor-law and voluntary institutions into more

intimate association, although they may be managed by separate governing bodies. The plan pursued is to demand payment from all patients who are admitted to the hospital under a scale of charges divided into three or four grades. The first grade pays a substantial sum and obtains anything or everything the patient may care to have or to pay for, subject to the control of the medical attendant. The second pays much less, but a remunerative rate, for all they receive at the hospital; and the third and fourth classes are very poor people or paupers, who are paid for on a graduated scale by the poor-law authorities, or the communal government, or the municipality. Under this system well-to-do thrifty artisans and improvident paupers are all treated by one staff, controlled by one administration, and are located in immediate proximity to each other though in separate pavilions. We have no doubt, as the result of many years' investigation and an accurate knowledge of the working of the system, that this is the true principle to enforce in providing adequate medical relief for large urban populations everywhere throughout the world. It should be accompanied by a system of government insurance, whereby all classes who desire to be thrifty may pay a small annual premium in the days of health, and secure adequate hospital treatment and care when ill. Provided that pay wings were added to the existing voluntary and municipal hospitals, it should be found that the relatively small annual premium of £3 per annum should enable the policyholders to defray the cost of medical treatment in a pay ward or at a consultation department of a great hospital as a matter of business. In the United States of America most large towns have great hospitals, usually known as city hospitals, administered and mainly supported by the municipality. Many such institutions have pay wards, but nowhere, so far as we have been able to discover, has the system of medical relief in its entirety been organized as yet upon the business system we have just referred to.

As to the relative merits and demerits of the systems of government of municipal hospitals and voluntary hospitals a few words may be useful. There can be no doubt that the voluntary hospital in Great Britain has had a remarkable effect for good upon all classes in the making of modern England. The management of these institutions is frequently representative of all classes of the people, while the voluntary system, as the Hospital Sunday collections all over the country, and all over the English-speaking world, prove, has united all creeds in the good work of caring and providing for the sick and injured members of each community. Again the voluntary system makes for efficiency in the administration of all hospitals. Each voluntary hospital is dependent upon its popularity and efficiency, in large measure, for the financial support it receives. In this way an ill-managed voluntary hospital, or one which has ceased to fulfil any useful public purpose, is sure to disappear in due course under the voluntary system. Voluntary hospitals are always open to, as well as supported by, the public, and, owing largely to the example so prominently set by King Edward VII. and members of the royal family, more people every year devote some time in some way to the cause of the hospitals. Attached to the voluntary hospitals are the principal medical and nursing schools upon which the public depend for the supply of doctors and nurses. The education of students and nurses in a clinical hospital makes that hospital the most desirable place for everybody when they are really ill. In such a hospital no patient can be overlooked, no wrong or imperfect diagnosis can long remain undiscovered and unrectified, and nowhere else have the patients so continuous a guarantee that the treatment they receive will be of the best, while the provision made for their comfort and welfare, owing to the unceasing and ever varying quality of the criticism to which the work of everybody, from the senior physician to the humblest official, is subjected in a clinical hospital, is unequalled anywhere else. At a great voluntary hospital, not only do hundreds of medical students and nurses work in the wards, but thousands of people, in the persons of the patients' friends, and those members of the public who take an interest in hospitals, pass through the wards in the

course of every year. Again, each voluntary hospital has to live by competition, a fact which guarantees that everything in the way of new treatment and scientific development shall in due course find its proper place within the walls of such an establishment. Open as they are to the full inspection of everybody whose knowledge and presence can promote efficiency, the voluntary hospitals have shown, especially since the last quarter of the 19th century, a continuous development and improvement. Here the patients are treated with invariable kindness and consideration, as human beings rather than cases, to the great benefit of the whole human family as represented by the officials, the patients and the students, with their relations and friends, the honorary medical officers, hundreds of medical practitioners and nurses, who receive their medical training in the hospitals, and the ever-increasing number of governors and supporters by whose contributions voluntary hospitals live. The great missionary and social value of the voluntary hospitals to the whole community cannot be questioned, and they have been of inestimable value to the churches by inculcating the higher principles of humanity, while removing the many acerbities which might otherwise prevail between rich and poor in large cities.

The voluntary hospitals are attended, however, by certain disadvantages which do not attach to municipal institutions. A municipality which undertakes the provision of hospitals for the entire community is largely able to plan out the urban area, and to provide that each hospital site selected shall not only be suitable for the purpose, but that it shall be so chosen as to contribute to make the whole system of hospital provision easily accessible to all classes who may require its aid. The voluntary hospitals, on the contrary, have grown up without any comprehensive plan of the districts or any real regard to the convenience or necessities of their poorer inhabitants. Voluntary hospital sites were almost invariably selected to suit the convenience of the honorary medical staff and the general convenience of the hospital economy rather than to save the patients and their friends long journeys in search of medical aid. The best of the municipal systems too enables economy to be enforced in the administration by a plan which provides a central office in every town where the number of vacant beds in each hospital is known, so that the average of occupied beds in all the hospitals can be well maintained from an economical point of view. This speedy and ready inter-communication between all hospitals in a great city, which might perfectly well be secured under the voluntary system if the managers could only be brought into active co-operation, prevents delay in the admission of urgent cases, promotes the absence of waste by keeping the average of beds occupied in each establishment high and uniform, and has often proved a real gain to the poor by the diminution in cost to the patients and their friends, who under the best municipal systems can find a hospital within reasonable distance of their home in a large city wherever it may be placed. Another advantage of the municipal system should be that central control makes for economical administration. Unfortunately a close study of this question tends to prove that municipal hospitals for the most part have resulted in a dead monotony of relative inefficiency, often entailing great extravagance in buildings, and accompanied by much waste in many directions. Existing municipal hospital systems are attended by several grave disadvantages. The administration shows a tendency to lag and grow sleepy and inert. The absence of competition, and the freedom from continuous publicity and criticism such as the voluntary hospitals enjoy, make for inefficiency and indifferent work. Rate-supported hospitals, as a rule, are administered by permanent officials who reside in houses usually situated on the hospital sites, and who are paid salaries which attract the younger men, who, once appointed, tend to continue in office for a long period of years. This fixture of tenure is apt to cause a decline in the general interest in the work of the municipal hospital, due mainly to the absence of a continuous criticism from outside, and so the average of efficiency, both in regard to treatment and other important matters, may become lower

and lower. Those who have habitually inspected great rate-supported hospitals must have met instances over and over again where a gentleman who has held office for twenty or thirty years has frankly stated that his income is fixed, that his habits have become crystallized, that he finds the work terribly monotonous, and yet, as he hopes ultimately to retire upon a pension, he has felt there was no course open to him but to continue in office, even though he may feel conscientiously that a change would be good for the patients, for the hospital and for himself. Under the voluntary system evils of this kind are seldom or never met with, nor have these latter establishments, within living memory, ever been so conducted as to exhibit the grave scandals which have marred the administration of rate-supported hospitals not only in Great Britain but in other parts of the world. We believe that the more thoroughly the advantages and disadvantages of rate-supported and voluntary hospitals for the care of the sick are weighed and considered, and the more accurate and full the knowledge which is added to the judgment upon which a decision can be based, the more certain will it be that every capable administrator will come to the conclusion that on the whole it is good for the sick and for the whole community that these establishments should, at any rate in Great Britain, be maintained upon the voluntary system. Of course it is essential to have rate-supported hospitals where cases of infectious disease and the poorest of the people who are dependent largely upon the poor-law for their maintenance can be cared for. It is satisfactory to be able to state that of late years the administration of both these types of rate-supported hospitals has greatly improved. The added importance now given all over the country to medical officers of health, and the disposition exhibited, both by parliament and government departments, to make the position of these officers more important and valuable than ever before, have tended largely to improve the administrative efficiency of hospitals for infectious diseases. No doubt the whole community would benefit if residents in every part of the country could be moved to take a personal interest in the infectious hospital in their immediate neighbourhood. Amongst the smaller of these establishments there has been so marked an inefficiency at times as to cause much avoidable suffering. The existence of such inefficiency casts a grave reflection upon the local authorities and others who are responsible for the evils which undoubtedly exist in various places at the present time. Unfortunately knowledge has not yet sufficiently spread to enable the public to overcome its fear and dread of infectious maladies. It is therefore very difficult to induce people to take an active interest in one of these hospitals, but we look forward to the time when, owing to the activity of the medical officers of health who have immediate charge of buildings of this kind, this difficulty may be overcome, when the avoidable dangers and risks and the appalling discomfort which a poor sufferer from a severe infectious disease in a rural district may suddenly have to encounter under existing circumstances, would be rendered impossible.

The poor-law infirmary in large cities, so far as the buildings and equipment are concerned, very often leaves little to desire. Poor-law infirmaries lack, however, the stimulus and the checks and advantages which impartial criticism continuously applied brings to a great voluntary hospital. Such disadvantages might be entirely removed if parliament would decide to throw open every poor-law infirmary for clinical purposes, and to have connected with each such establishment a responsible visiting medical staff, consisting of the best qualified men to be found in the community which each hospital serves. The old prejudice against hospital treatment has disappeared, for the least intelligent members of the population now understand that, when a citizen is sick, there is no place so good as the wards of a well-administered hospital. Looking at the question of hospital provision in Great Britain, and indeed in all countries at the present time, it may be said, that there is everywhere evidence of improvement and development upon the right lines, so that never before in the history of the world has the lot of the sick man or woman been so relatively fortunate and safe as it is in

the present day. Probably it is not too much to say that to-day hospitals occupy the most important position in the social economy of nations.

Classification of Hospitals.—Having dealt with hospitals as a whole it may be well very briefly to classify them in groups, and explain as tersely as possible what they represent and how far it may be desirable to eliminate by consolidation or to increase by disintegration the number of special hospitals.

General Hospitals.—These establishments consist of two kinds, (a) clinical and (b) non-clinical, each of which, under the modern system, should include every department of medicine and surgery, and every appliance and means for the alleviation of suffering, the healing of wounds, the reduction of fractures, the removal of mal-formations and foreign growths, the surgical restoration of damaged and diseased organs and bones, and everything of every kind which experience and knowledge prove to be necessary to the rapid cure of disease. The clinical hospital means an institution to which a medical school is attached, where technical instruction is given by able and qualified teachers to medical students and others. A non-clinical hospital is one which is not attached to a medical school, and where no medical instruction is organized.

Special Hospitals.—Up to about 1840 the general hospital was, speaking generally, the only hospital in existence. Twenty years later, as the population increased and medical science became more and more active, some of the more ardent members of the medical profession, especially amongst the younger men, pressed continuously for opportunities to develop the methods of treatment in regard to special diseases for which neither accommodation nor appliances were at that time forthcoming in general hospitals. In a few cases, where the managers of the great general hospitals were men of action and initiative special departments were introduced, and an attempt was made to make them efficient. The conservative spirit which, on the whole, represents the British character for the most part, resulted, however, in a steady resistance being offered by the older members of the medical staffs and existing committees to the advocates of special departments. In the result, especially as such special departments as there were in connexion with general hospitals were too often starved for want of means and men for their development and improvement, the younger spirits called their friends together and began to start special hospitals. To-day every really efficient clinical general hospital has within its walls special departments of almost every description, which have been made as efficient and up-to-date as money and knowledge can make them. Unfortunately the causes already referred to led to the establishment of hundreds of the smaller special hospitals, many of which were started in unsuitable buildings, and some of which have ever since maintained a struggling existence. Others, on the contrary, through the energy of their original promoters and the excellence of the work they have done, have obtained a position of authority and reputation which has had a very important bearing for good upon the development of medical science in the treatment of disease. If the world had to-day to organize the very best system of hospital accommodation which could be evolved, there is no doubt that few or none of the special hospitals would find any place in that system. As matters stand, however, the special hospital has had to be accepted, and nothing which King Edward's Hospital Fund has done in London has met with greater popularity and professional approval than the labours which its council have undertaken in promoting the amalgamation of the smaller special hospitals of certain kinds, so as to secure the provision of one really efficient special hospital for each speciality. No doubt this policy of amalgamation will be steadily pursued, and in the course of years every great city will gradually reorganize its hospital methods so as to secure that, whether the patients are treated in a general hospital or in a special hospital, the average efficiency in every institution shall be as high and as good as possible.

We will take now the special hospitals in detail.

Cancer Hospitals.—The justification for efficient cancer hospitals must be found in the circumstance that most scientific men of

experience believe that, if adequate resources were placed at the disposal of the medical profession, the origin of cancer might be discovered, and so the human race would be freed from one of the most awful diseases which affect humanity. Pending such a discovery the experience of the cancer department connected with the Middlesex Hospital in London proves to demonstration that the provision of adequate and special accommodation for the exclusive treatment of cases of cancer is not only desirable but necessary on humanitarian grounds alone.

Hospitals for Consumption.—For many years it was held that this group of hospitals was not a necessity, and the patients were treated in the ordinary medical wards of the general hospital. Since the contagious character of tuberculosis became known, and improved methods of treatment have been developed, every one agrees that this type of special hospital is desirable, though it is believed by the more advanced school of scientists that before long it may be happily rendered obsolete owing to the discovery of methods of treatment which will stay the disease at its commencement and restore the patient to health.

Children's Hospitals.—These hospitals were very much opposed at the outset. There can be no doubt that the children's ward or wards in a big voluntary hospital is a most valuable asset to the managers, so long as the children are treated in separate wards. There is no reason of course why a hospital should confine its work to the treatment of children, exclusively. Still this special hospital is popular with the public; it has led to many discoveries and developments in the treatment of children's diseases; on the whole the administration of these establishments has been good; and we believe they will continue to flourish, however many children's wards may be provided in general hospitals. Children's hospitals with country branches for the treatment of chronic ailments, such as hip disease, are a valuable addition to the relief of suffering in cities.

Cottage Hospitals.—These hospitals, established originally in 1859 by Mr Albert Napper at Cranleigh, Surrey, have fulfilled a most useful function. Many of them are very efficient both in regard to equipment and treatment. They have become essential to the well-being and adequate medical care of rural populations, as they attract to the country some of the best members of the profession, who are able, with the aid of the cottage hospital, to keep themselves efficient and up-to-date, so that all classes of the community are benefited in this way by this type of hospital.

Ear, Throat and Nose Hospitals.—The history of this type of hospital bears out in every particular the reason we have given above for the establishment of special hospitals in the first instance. There can be no doubt that the best conducted throat hospitals have been beneficial to the poorer inhabitants of great cities.

Fever Hospitals.—Incidentally we have dealt with these institutions, which are usually supported out of the rates and administered by the medical officers of health, who are paid by the county or municipal authorities.

Maternity and Lying-in Hospitals.—This is one of the oldest types of special hospitals, and has done a great deal of good in its time. Owing to modern methods of treatment and hygienic developments the maternity hospital never occupied a stronger position than it does to-day.

Mental Hospitals.—In Great Britain the insane are provided for in asylums (see *INSANITY, ad fin.*), though such establishments, if properly conducted, are essentially hospitals. Scientific and public opinion tend towards the establishment of mental hospitals to which all acute cases of mental disease should be first relegated for treatment and diagnosis before they are consigned to a permanent lunatic hospital. Too little attention on an organized plan has been given to the continuous study of mental disease in its clinical and pathological aspects. It is probable, therefore, that the advent of the mental hospital may lead to important developments in treatment in many ways.

Ophthalmic Hospitals.—Of all special hospitals this is one which would probably be the least necessary, providing general hospitals everywhere were properly equipped and organized. No special hospital has probably been so abused in the material sense by the free relief of patients who could well afford to pay for their treatment at the ophthalmic hospital. Several of the existing ophthalmic hospitals have entailed an enormous expenditure, and their modern equipment is wonderfully efficient.

Orthopaedic Hospitals.—It is very doubtful whether this type of hospital is really desirable or necessary. Its necessity may be advocated on the ground that orthopaedic cases may require prolonged treatment, and that the pressure upon the beds of general hospitals by acute cases is nowadays so great as to render the orthopaedic hospital more necessary than ever before.

Paralysis and Epileptic Hospitals.—Seeing that the percentage of those who are at present attacked by paralysis and nervous disease shows a continued tendency to increase under modern conditions of life in large cities, hospitals of this type are necessary, and London at any rate, like most foreign towns of importance, possesses, at present, far too little accommodation for this class of case.

Skin and Photo-Therapy.—Up to the end of the 19th century hospitals for diseases of the skin were a constant cause of scandal and criticism. The introduction of modern methods of treatment by

light and electricity, including photo-therapy, has given an importance to this department and treatment which it did not previously possess. We are of opinion that, on the whole, it is better and more economical to treat these cases in properly equipped departments of general hospitals than in separate institutions.

Women's Hospitals.—These hospitals are not absolutely necessary, but considering their popularity with the women themselves, and that several of them have done excellent work, remembering too that women constitute the majority of the population, there seems to be some reason for their continuance.

The Evolution of the Modern Hospital.—The evolution of the modern hospital affords one of the most marvellous evidences of the advance of scientific and humanitarian principles which the world has ever seen. At the outset hospitals were probably founded by the healthy more for their own comfort than out of any regard for the sick. Nowadays the healthy, whilst they realize that the more efficient they can make the hospital, the more certain, in the human sense, is their own chance of prolonged life and health, are, as the progress of the League of Mercy has shown in recent years, genuinely anxious for the most part to do something as individuals in the days of health in the cause of the sick. Formerly the hospital was merely a building or buildings, very often unsuitable for the purposes to which it was put, where sick and injured people were retained and more frequently than not died. In other words the hygienic condition, the methods of treatment and the hospital atmosphere were all so relatively unsatisfactory as to yield a mortality in serious cases of 40%. Nowadays, despite, or possibly because of, the fact that operative interference is the rule rather than the exception in the treatment of hospital patients, and in consequence of the introduction of antiseptic and aseptic methods, the mortality in hospitals is, in all the circumstances, relatively less, and probably materially less, than it is even amongst patients who are attended in their own homes. Originally hospitals were unsystematic, crowded, ill-organized necessities, which wise people refused to enter, if they had any voice in the matter. At the present time in all large cities, and in crowded communities in civilized countries, great hospitals have been erected upon extensive sites which are so planned as to constitute in fact a village with many hundreds of inhabitants. This type of modern hospital has common characteristics. A multitude of separate buildings are dotted over the site, which may cover 20 acres or upwards. In one such institution, within an area of 20 acres, there are 6 m. of drains, 29 m. of water and steam pipes, 3 m. of roof gutters, 42 m. of electric wires, and 42 separate buildings, which to all intents and purposes constitute a series of distinct, isolated hospitals, in no case containing more than forty-six patients. On the continent of Europe buildings of this class are usually of one storey; in the United States, owing to the difficulty of obtaining suitable sites and for reasons of economy, some competent authorities strenuously advocate high buildings with many storeys for town hospitals. In England the majority have two to three storeys each, the ward unit containing a ward for twenty beds and two isolation wards for one and two beds respectively. The two storeys in modern fever hospitals, however, are absolutely distinct—that is, there is no internal staircase going from one ward to the others, for each is entered separately from the outside. This system carries to its extreme limits the principle of separating the patients as much as possible into small groups; the acute cases are usually treated in the upper ward, and as they become convalescent are removed downstairs. In this way the necessity for an entirely separate convalescent block is done away with and the patients are kept under the same charge nurse, an arrangement which promotes necessary discipline. The unit of these hospitals is the pavilion, not the ward, and consists of an acute ward, a convalescent ward, separation wards, nurses' duty rooms, store-rooms for linen, an open-air balcony upstairs into which beds can be wheeled in suitable weather, and a large airing-ground for convalescent patients directly accessible from the downstairs ward. Each of the pavilions is raised above the ground level, so that air

can circulate freely underneath. The wall, floor and air spaces in the scarlet fever wards of one of these hospitals are respectively 12 ft., 156 ft. and 2028 ft. per bed; and in the enteric and diphtheria wards they have been increased to 15 ft., 195 ft. and 2535 ft. respectively. The provision of so large a floor and linear space, especially in the diphtheria wards, is an experiment the effect of which will be watched with considerable interest. A building of this type is a splendid example of the separate pavilion hospital, and is doing great service in the treatment of fevers wherever it has been introduced. Some idea of a hospital village, some of the wards of which we have been describing, may be gathered from the circumstances that it costs from £300,000 to £400,000, that it usually contains from 500 to 700 beds, and that the staff numbers from 350 to 500 persons. The medical superintendent lives in a separate house of his own. The nurses are provided with a home, consisting of several blocks of buildings under the control of the matron; the charge nurses usually occupy the main block, where the dining and general sitting-rooms are placed, the day assistant-nurses another block; and lastly, by a most excellent arrangement, the night nurses, 80 to 120 in number, have one whole block entirely given up to their use. The female servants have a second home under the control of the house-keeper, and the male servants occupy a third home under the supervision of the steward. The two main ideas aimed at are to disconnect the houses occupied by the staff from the infected area, and to place the members of each division of the staff together, but in separate buildings, under their respective heads. These objects are highly to be commended, as they have important bearings upon the well-being and discipline of the whole establishment and constitute a lesson for all who have to do with buildings where a great number of people are constantly employed.

The Hospital City.—We have shown that the modern hospital where an adequate site is available under the most favourable conditions has developed into a hospital village. No one who is familiar with the existing disadvantages of many of the sites and their surroundings of town hospitals in many a large city can have any doubt that, if the well-being of the patients and the good of the whole community, combined with economical and administrative reasons, together with the provision of an adequate system for the instruction and training of medical students and nurses, are to be the first considerations with those responsible for the hospitals of the future, the time will come, and is probably not far distant, when each great urban community will provide for the whole of its sick by removing them to a hospital city, which will be situated upon a specially selected and most salubrious site some distance from the town itself. The atmosphere of a great city grows less and less suitable to the rapid and complete recovery of patients who may undergo the major operations or be suffering from the severe and acute forms of disease. Asepsis, it is true, has reduced the average residence in hospital from about 35 to less than 20 days. It has thereby added quite one million working days each year to the earning power of the artisan classes in London alone. Medical opinion is more and more favouring the provision of convalescent and suburban hospitals, to which patients suffering from open wounds may be removed from the city hospitals. This course, which entails much additional expenditure, is advocated to overcome the difficulty arising from the fact that, in operation and other cases, the patients cease to continue to make rapid progress towards recovery after the seventh or ninth day's residence in a city hospital. A change of such cases to the country restores the balance and completes the recovery with a rapidity often remarkable.

Thinking out the problem here presented in all its bearings, realizing the great and ever-increasing cost of sites for hospitals in great cities, the heavy consequential taxes and charges which they have to meet there, and all the attendant disadvantages and drawbacks, the present writer has ventured upon an anticipation which he hopes may prove intelligent and well-founded. Nearly every difficulty in regard to the cost of hospitals and in respect to all the many problems presented by securing

the material required, under present systems, for the efficient training of students and nurses, would be removed by the erection of the Hospital City, which, he foresees, must ultimately be recognized by intelligent communities throughout the civilized world. Why should we not have, on a carefully selected site well away from the contaminations of the town, and adequately provided with every requisite demanded from the site of the most perfect modern hospital which the mind of man can conceive, a "Hospital City"? Here would be concentrated all the means for relieving and treating every form of disease to the abiding comfort of all responsible for their adequacy and success. At the present time all the traffic and all the citizens give way to fire engines and the ambulance in the public streets. Necessarily the means of transit to and from the "Hospital City," and its rapidity, would be the most perfect in the world. So the members of the medical staff, the friends of the patients, and all who had business in the "Hospital City," would find it easier and less exacting in time and energy to be attached to one of the hospitals located therein than to one situated in the centre of a big population in a crowded town. To meet the urgent and accident cases a few receiving houses, or outpost relief stations, with a couple of wards, would be situated in various quarters of the working city, where patients could be temporarily treated, and whence they could be removed to the "Hospital City" by an efficient motor ambulance service. The writer can see such a "Hospital City" established, can realize the comfort it will prove in practice to the medical profession, to the patients' friends, to those who have to manage the hospitals and train the medical and nursing students, and indeed to all who may go there as well as to the whole community. The initial cost of hospital buildings should be reduced at once to a quarter or less of the present outlay. They could then be built of the cheapest but most suitable material, which would have many advantages, whilst the actual money forthcoming from the realization and sale of the existing hospital sites in many cities would, in all probability, produce a sum which in the whole might prove adequate, or nearly adequate, or even in some cases more than adequate, to defray the entire cost of building the "Hospital City" and of equipping it too. The cost of administration and working must be everywhere reduced to a minimum. The hygienic completeness of the whole city, its buildings and appliances, must expedite recovery to the maximum extent. In all probability the removal of the sick from contact with the healthy would tend in practice so to increase the healthiness of the town population, *i.e.* of the workers of the city proper, as to free them from some of the most burdensome trials which now cripple their resources and diminish materially the happiness of their lives. Probably the United States (where a city has sometimes sprung up in twelve months) may be the home where this idea may first find its realization in accomplished fact. The writer may never live to see such a city in actual working or in its entirety, but he makes bold to believe its adoption will one day solve the more difficult of the problems involved in providing adequately for the sick in crowded communities. He has formulated the idea because it seems desirable to encourage discussion as to the best method of checking the growing tendency to make hospital buildings everywhere too costly. If the idea of the "Hospital City" commends itself to the profession and the public, the practice of treating all the hospital accommodation in each city as a whole will gradually increase and spread, until most of the present pressing difficulties may disappear altogether. That is a consummation devoutly to be wished.

The Problem of Hospital Administration.—A study of the hospital problem in various countries, and especially in different portions of the English-speaking world, convinces the writer that, apart from local differences, the features presented are everywhere practically identical. A number of hospitals under independent administration, dependent in whole or in part on voluntary contributions, administered under different regulations originally representing the idiosyncracies of individual managers for the time being, without any standard of efficiency

or any system of co-operation, which would bring the whole of the medical establishments of each or all of the great cities of the world under one administration which the combined wisdom and experience of hospital managers as a whole might agree to be the best, must mean in practice a material gain in every way to each and all of the hospitals and their supporters on economical, scientific and other grounds. Such an absence of system throughout the world has everywhere led to overlapping, to the perpetuation of many abuses, to the admission of an increasing number of patients whose social position does not entitle them to claim free medical relief at all, and, often too, to the admission of patients belonging to a humbler grade of society who are already provided for by the rates in institutions which they do not care to enter and who find their way to the wards of hospitals which were established to provide for patients of an entirely different social grade. These evils have continued to grow and increase almost everywhere, despite many and varied attempts to grapple with and remove them. Amongst these attempts we may mention the assembling of hospital conferences, the establishment of special funds and committees, and the holding of inquiries of various kinds in London and other British cities and also in the United States. The most remarkable proof of the impossibility of inducing those responsible to act together and enforce the necessary reforms is afforded by the historical fact that the famous Commission on Hospital Abuse, known as Sir William Fergusson's Commission, in 1871, after an exhaustive inquiry, made the following recommendations: (1) to improve the administration of poor-law medical relief; (2) to place all free dispensaries under the control of the poor-law authorities; (3) to establish an adequate system of provident dispensaries; (4) to curtail the unrestricted system of gratuitous relief, partly by the selection of cases possessing special clinical interest and partly by the exclusion of those who on social grounds are not entitled to gratuitous medical advice; (5) the payment of the medical staff engaged in both in- and out-patient work, and the payment of fees by patients in the pay wards and in the consultation departments of the voluntary hospitals. Other commissions have since been appointed, have reported, and have disappeared, with the result that nothing practical had been done up to 1910 in the way of reform. Yet it is an undoubted fact that, if the foregoing recommendations of Sir William Fergusson's Commission had been carried out in their entirety at the time they were made, practically all the abuses from which British hospitals afterwards suffered would have been removed, and the charitable public might have been saved several millions of pounds sterling. It may be well, therefore, briefly to indicate exactly what these changes amount to, and how they can be made effective at any time by those responsible for the working of a hospital.

There is no doubt that all the facts available tend to prove that the voluntary hospitals are used to an increasing extent by persons able to make payment or partial payment for the treatment which they receive. The evidence and statistics demonstrating these facts may be readily gathered from a study of the Report (1909) and Evidence of the Royal Commission on the Poor Laws and Relief of Distress (Lord George Hamilton's Commission) and in the authorities mentioned at the end of this article. The underlying cause of the abuse was that no means existed whereby persons of moderate income could obtain efficient treatment and hospital care when ill at a rate which they could afford to pay. The system, or want of system, whereby medical relief is granted to practically all applicants by the voluntary hospitals grew up without any combined attempt to organize it efficiently or to check abuses. Such a system rests upon a wrong basis, and the best interests of every class of the population demand its abolition in favour of one which shall afford the maximum of justice (1) to the poor, (2) to those who can afford to pay in part or in whole the cost of their medical treatment and care at a hospital, (3) to the medical profession, (4) to the subscribers and supporters of voluntary hospitals, whose gifts should be strictly applied to the purposes they were intended to serve, and (5) to the ratepayers, who are entitled to a guarantee that the

maximum efficiency is secured by the poor-law system of medical relief. The remedy is very simple and easy of application. Every voluntary hospital, while admitting all accidents and urgent cases needing immediate attention, should institute a system whereby each applicant would be asked to prove that he or she was a fit object of charity. The only real attempt at reform, up to 1909, was the appointment by many of the larger hospitals of almoners to ascertain whether certain selected patients were in a position to pay or not. By putting the burden of proof of eligibility to receive free medical relief upon the patients and their friends, all abuse of every kind must speedily cease. There would be no hardship entailed upon the patients by such a system, as experience has proved, but, to make it effective, the system of providing for in- and out-patients in Great Britain requires radical change, for, in existing circumstance, if a voluntary hospital attempted to enforce this simple method, it would be met with the difficulty that, where it was found that a patient or his friends could pay at any rate something, no department connected with British hospitals existed—as is the case in regard to hospitals in the United States—enabling such in-patients to be transferred to accommodation provided in paying wards. In the same way, directly the out-patients were dealt with under such a system, it would be made apparent, where a case could be properly treated under the poor law, that no plan of co-operation to secure this was organized under existing conditions. If the patient, being of a better class, were suffering from a minor ailment, and could be properly dealt with at a provident dispensary, the fees of which he could easily pay, the same absence of co-operation must make it practically impossible readily to enforce the system. When, again, an out-patient of the better class was entitled, from the severity of his ailment, to receive the advantages of a consultation by the medical staff, no method existed whereby this aid could be rendered to him, and his transfer afterwards to the care of a medical practitioner attached to some provident dispensary, or resident near the patient's home, could be properly carried out. It follows that adequate reforms required that methods should be adopted with a view to some part or all the cost of treatment being provided by the patient or his friends through an entire reorganization of the system of medical relief not only at the voluntary hospitals, but under the poor-law system. The reforms required in regard to voluntary hospitals are that every large hospital shall have connected with the in-patient department, in separate buildings, but under the administration of the managers, pay wards for the reception of those patients who are able to pay some part or all of the cost of treatment; that, as regards out-patients, the existing out-patient department should be abolished; that in substitution for it each hospital should have a casualty department and a department for consultation. In the casualty department every applicant should be seen once, and be there disposed of by being handed on to the consultation department; if his case was sufficiently important, he should then be transferred to some provident or poor-law dispensary, or be referred to a private medical attendant. It would no doubt take time to overcome the incidental difficulties which would necessarily arise in effecting so radical a reform as is here contemplated, but if all voluntary hospitals adopted the same system, and were to be brought into active co-operation with provident dispensaries and poor-law dispensaries and private medical practitioners, the new system might be successfully introduced and made effective within twelve months, and probably within six months, from the date of its commencement. This opinion is based upon the assumption that the provident dispensaries would be standardized, and that every one of them would be brought up to a state of the highest efficiency. In the town of Northampton the Royal Victoria Dispensary has been worked with the maximum of success, so far as the patients and the medical practitioners are concerned. In London and in other large towns like Manchester and elsewhere the provident dispensary has not succeeded as it has done in Northampton, because so many members of the medical profession are not alive to the importance of making

it their first business to provide that every patient connected with the provident dispensary who attends at the surgery of a private medical practitioner shall receive at least equal attention and accommodation to that afforded to every other private patient, whatever the fee he may pay. In the same way, poor-law dispensaries must be radically reformed. Everything which tends to excite a feeling of shame on the part of the patient attending the poor-law dispensary, such as the printing of the word "pauper" at the beginning of the space on which the patient's name is entered, must be abolished, and the class of medical service and all the arrangements for the treatment of the patients, however poor, at the poor-law dispensary, must be made at least as efficient as those provided by voluntary hospitals. There undoubtedly is considerable overlapping between the voluntary hospitals and the poor law in Great Britain. The Royal Commission on the Poor Laws and Relief of Distress (1909) deals with this point with a view to set up a standard of medical relief to be granted by each class and type of hospitals, provides for adequate co-operation between all classes of institutions; and these reforms may be commended. It is too often forgotten that the function of the poor law is the relief of destitution, while it should be the object and duty of each voluntary hospital and indeed of all hospitals other than poor-law institutions to apply their resources entirely to the prevention of destitution, by stepping in to grant free medical relief to the provident and thrifty when, through no fault of their own, they meet with an accident or are overtaken by disease. An adequate system of co-operation would preserve the privilege of the voluntary hospitals, which save such patients from the necessity of requiring the relief which it is the object of the poor law to supply.

We have dealt with the relative advantages and disadvantages of rate-supported hospitals and voluntary hospitals. We should regard the establishment of a complete state-provided or rate-provided system of gratuitous medical relief either for in-door patients or for out-door patients, or for both, as a grave evil. Such a system must eventually lead to the extinction of voluntary hospitals. If this disaster ever happens, it must result in the gravest evils, for it could not fail to injure the morale of all classes and tend to harden unnecessarily the relations between the rich and poor, who, under the voluntary system, have come to share each other's sufferings and to be animated by respect and confidence towards each other.

Hospital Construction. Locality and Site.—Hospitals are required for the use of the community in a certain locality, and to be of use they must be within reach of the centre of population. Formerly the greater difficulty of locomotion made it necessary that they should be actually in the midst of towns and cities, and to some extent this continues to prevail. It is now proved to demonstration that this is not the best plan. Fresh and pure air being a prime necessity, as well as a considerable amount of space of actual area in proportion to population, it would certainly be better to place hospitals as much in the outskirts as is consistent with considerations of usefulness and convenience. In short, the best site would be open fields; but if that be impracticable, a large space, "a sanitary zone" as it is called by Tallet, should be kept permanently free between them and surrounding buildings, certainly never less than double the height of the highest building. In the selection of a site various factors must be taken into consideration. If the hospital is to be used as the clinical school of a university or medical college, then the most suitable ground available within easy reach of the university or college must be secured. If, on the other hand, the hospital is not to be used as a teaching school, a site more in the country should be favoured. In any case ample ground must be purchased to permit of the wards receiving the maximum of sunlight, an abundant supply of fresh air, and leave room for possible future extensions. The site should be self-contained; it should be in such a position as to prevent the hospital being shadowed by other buildings in the neighbourhood, and, unless the site is alongside a public park, it should be entirely surrounded by streets of from 40 to 60 ft. in width. It is also necessary to secure that adequate water mains serve the site, and that the system of sewers be ample for all sewage purposes.

The difference between the expense of purchase of land in a town and in the environs is generally considerable, and this is therefore an additional reason for choosing a suburban locality. Even with existing hospitals it would be in most cases pecuniarily advantageous to dispose of the present building and site and retain only a receiving house in the town. St Thomas's in London, the Hôtel-Dieu in Paris

and the Royal Infirmary in Manchester, are all good examples where this might have been carried out. In none, however, has this been done; these hospitals have been rebuilt, at enormous outlay, in the cities as before, although not exactly in the same locality.

As regards the actual site itself, where circumstances admit of choice, a dry gravelly or sandy soil should be selected, in a position where the ground water is low and but little subject to fluctuations of level, and where the means of drainage are capable of being effectually carried out. There should also be a cheerful sunny aspect and some protection from the coldest winds.

Form of Building.—A form of building must be selected which answers the following conditions: (a) the freest possible circulation of air round each ward, with no cul-de-sac or enclosed spaces where air can stagnate; (b) free play of sunlight upon each ward during some portion at least of the day; (c) the possibility of isolating any ward, or group of wards, effectually, in case of infectious disease breaking out; (d) the possibility of ventilating every ward independently of any other part of the establishment. Those conditions can only be fulfilled by one system, viz. a congeries of houses or pavilions, more or less connected with each other by covered ways, so as to facilitate convenient and economical administration. The older plans of huge blocks of buildings, arranged in squares or rectangles, enclosing spaces without free circulation of air, are obviously objectionable. Even when arranged in single lines or crosses they are not desirable, as the wards either communicate with each other or with common passages or corridors, rendering separation impossible. On this point it may be remarked that some of the buildings of the 18th century were more wisely constructed than many of those in the first half of the 19th century, and that the older buildings have been from time to time spoilt by ignorant additions made in later times.

The question next arises, is it better to have pavilions of two or more storeys high, or to have single-storeyed huts or cottages scattered more widely? For the treatment of tuberculosis there can be no doubt that, for hygienic reasons, the *châlet* or single-patient hut is the best for the patients in the acute stages; for economical reasons the *châlet* has not been heretofore as popular as it deserves to be, but if the welfare of the patient is to be the first consideration there is no doubt that the *châlet* will ultimately prevail. It has the merit of being easily adapted to villages and houses where there is a garden, and in this way poor families may readily isolate and treat a member affected by tuberculosis at a cost within their means. For hospital purposes, so long as the system of placing hospital buildings in densely crowded areas prevails, many-storeyed buildings for hospital purposes are likely to continue. Should the proposal to institute a Hospital City ultimately prevail, then it is probable that the majority of the pavilions will be single-storeyed. Still some hospital authorities prefer the multiple-storeyed system for administrative reasons, contending that single-storeyed pavilions have no special advantages over two or three-storeyed buildings, whereas the difficulties in administration and service of a hospital building on the single-storey principle outweigh any argument against the two- or three-storey building, if it is properly designed and constructed. We hope that the time is approaching when architects and those members of the public who have to provide the money for hospital buildings will insist upon the erection of simple structures, costing little, so that the whole cost of hospital buildings may be, as it ought to be, reduced by at least half when compared with the expenditure of the past.

The pavilions may be arranged in various ways; they may be joined at one end by a corridor, or may be divided by a central corridor at right angles to them. In fact, the plan is very elastic, and adapts itself to almost any circumstances. A certain distance, not less than twice the height of the pavilions, ought to be preserved between them. By this means free circulation of air and plenty of light are secured, whilst separation or isolation may be at once accomplished if required.

Foundations, Building Materials, &c.—It is of the first consequence that a hospital should be dry; therefore the foundation and walls ought to be constructed so as to prevent the inroads of damp. An impervious foundation has the further advantage of preventing emanations from the soil rising up in consequence of the suction force produced by the higher temperature of the internal atmosphere of the building itself. There should be free ventilation in the basement, and the raising of the whole on arches is a good plan, now generally carried out in hot climates. If the pavilions are two or more storeys high, it is advisable to use fire-proof material as much as possible, but single-storeyed huts may be of wood. In any case effectual means of excluding damp must be employed. The interiors of wards ought to be rendered as non-absorbent as possible, by being covered with impervious coatings, such as glazed tiles (Parisian, though much used, is apt to crack), silicate paint, which is preferable to tiles, or the like. The ceilings ought to be treated in the same way as the walls. There must be a concrete floor between each flat, experience showing that if a teak floor is laid hard on the concrete a very noisy floor is the result, but if the teak is laid on strips of wood, leaving a small space between the concrete and the floor, a more silent floor is obtained. For the floors themselves various materials have been suggested; in France there is a preference for flags (*dalles*), but in England wood is more liked; and

indeed hard well-fitting wood, such as teak, oak or American willow, leaves nothing to be desired. The surface should be waxed and polished or varnished. Even deal floors can be rendered non-absorbent by waxing, by impregnating them with solid paraffin as recommended by Dr Langstaff.

Shape and Arrangement of Wards.—It is now generally agreed that wards should have windows on at least two opposite sides. Three main shapes have been proposed: (a) long wards with windows down each side, and (generally) one at the farther end with balcony; 26 ft. is a good width for a ward of twelve or fourteen beds, but for larger wards of more than fourteen beds the width should be not less than 28 ft.; (b) wards nearly square, with windows on three sides; and (c) circular wards with windows all round. The first (a) is the form usually adopted in pavilions; (b) is recommended by Dr C. F. Folsom (*Plans for the Johns Hopkins Hospital*); and (c) has been suggested by Mr John Marshall, F.R.S. (*Nat. Assoc. for Promotion of Social Science*, 1878). Of these (b) seems the least to be commended, and (c), now comparatively common, has distinct advantages in an administrative sense, when the wards are constructed as to floor space so as to allow the same proportion of superficial space per bed in a circular ward to that which is contained in a rectangular ward, as is the case at the Great Northern Central Hospital, London. Some authorities object to a chimney-stack up the centre of the circular ward, urging that it prevents the nurses from having complete supervision over all the beds. In practice this objection seems to us to have little force, and it can be avoided by placing the fireplaces at the side of the circular ward, if desirable, though this adds somewhat to the cost of building.

Each bed should be a little distance, say from 8 in. to 1 ft. from the wall, and each bed may be reckoned as 6½ ft. long; this gives 7½ ft. on each side. Between the ends of the beds about 10 ft. space is necessary, so that 25 or 26 ft. of total breadth may be taken as a favourable width. The wards of the Herbert Hospital are 26 ft.; but some exceed this, as, for instance, St Thomas's, London, and the New Royal Infirmary, Edinburgh, 28; new Hôtel Dieu, 29; and Lariboisière, 30. There seems no necessity for exceeding 26 for a ward of twelve or fourteen beds, but if the breadth be greater there ought to be more window space—the great difficulty being to get a wide space thoroughly ventilated. There ought to be only two rows of beds, one down each wall, with a window on each side of each bed.

For ventilation two things are required—sufficient space and sufficiently frequent change or renewal of air. As regards space, this must be considered with reference both to total space and to lateral or floor space. Unless a minimum of floor space be laid down, we shall always be in danger of overcrowding, for cubic space may be supplied vertically with little or no advantage to the occupier. If we allow a minimum distance of 4 ft. between the beds and 10 ft. between the ends of the beds, this gives 100 sq. ft. of space per bed; less than this is undesirable. In severe surgical cases, fever cases and the like, a much larger space is required; and in the Edinburgh Infirmary 130 sq. ft. is allowed. Cubic space must be regulated by the means of ventilation; we can rarely change the air oftener than three times in an hour, and therefore the space ought to be at least one-third of the hourly supply. This ought not to be less than 4000 cubic ft. per bed, even in ordinary cases of sickness—and the third of that is 1333 cubic ft. of space. With 100 sq. ft. of floor space a ward of 13½ beds will supply this amount, and there is but little to be gained by raising the ceiling higher,—indeed 12 ft. is practically enough. The experiments of Drs Cowles and Wood of Boston (see *Report of State Board of Health of Massachusetts for 1879*) show that above 12 ft. there is little or no movement in the air except towards the outlet ventilator; the space above is therefore of little value as ventilation space. Authorities nowadays, however, fix 10 ft. 6 in. as the maximum, and any height above this may be disregarded for purposes of ventilation. Additional height adds also to the cost of construction, increases the expense of warming, makes cleaning more difficult, and to some extent hampers ventilation. Whatever be the height of wards, the windows must reach to the ceiling, or there must be ventilators in the ceiling or at the top of the side walls. If this be not arranged for, a mass of foul air is apt to stagnate near the ceiling, and sooner or later to be driven down upon the inmates. The reasons for a large and constant renewal of air are, of course, the immediate removal and dilution of the organic matter given off by the inmates; as this is greater in quantity and more offensive and dangerous in sickness than in health, the change of air in the former case must be greater than in the latter. Hence in serious cases an amount of air practically unlimited is desirable—the aim of true ventilation being to approach as near as possible to the condition of pure external air. Without going too much into details, a few general rules may be laid down. (1) Fresh air ought, if possible, to be brought in at the lowest part of the ward, warmed if necessary; (2) foul air ought to be taken out at the highest part of the ward; (3) fresh air should reach each patient without passing over the bed of any other; (4) the vitiated air should be removed from each patient without passing over the bed of any other; (5) 4000 cubic ft. of fresh air per bed per hour should be the minimum in ordinary cases of sickness, to be increased without limit in severer cases; (6) the air should move in no part of a ward at a greater rate than 1½ ft. per second, except at the point of entry, where it should not exceed 5 ft. per second, and at the

outlet, where the rate may be somewhat higher; about 64 sq. in. of inlet and outlet sectional area ought to be supplied per head as a minimum; (7) every opportunity ought to be taken of freely flushing the wards with air, by means of open windows, when this can be done with safety.

Warming is a question of great importance in most climates, especially in such a climate as that of Great Britain, where every system of ventilation must involve either the warming of some portion of the incoming air, or the contriving its delivery without too great lowering of temperature; at the same time it cannot be too strongly insisted upon that the tendency is too much in the direction of allowing warmth to supersede freshness of air. There are very few cases of disease (if any) that are not more injured by foul air than by low temperature; and in the zymotic diseases, such as typhus, enteric fever, smallpox, &c., satisfactory results have been obtained even in winter weather by almost open-air treatment. At the same time a reasonable warmth is desirable on all grounds if it can be obtained without sacrificing purity of atmosphere. For all practical purposes 60° to 63° F. is quite sufficient, and surgical and lying-in cases do well in lower temperatures. Various plans of warming have been recommended, but probably a combination is the best. It is inadvisable to do away altogether with radiant heat, although it is not always possible to supply sufficient warmth with open-air fire-places alone. A portion of the air may be warmed by being passed over a heating apparatus before it enters the ward, by having an air-chamber round the fire-place or stove, or by the use of radiators in the ward itself. In each case, however, the air must be supplied independently to each ward, so that no general system of air supply is applicable.

The lighting of the ward at night will be most conveniently done by means of electricity in the form of a lamp for each bed, where gas is used each jet should have a special ventilator to carry off combustion products, as in the Edinburgh Infirmary.

The furniture of wards should be simple, clean and non-absorbent; the bedsteads of iron, mattresses hair, laid on spring bottoms without sacking. No curtains should be permitted.

The water-supply ought to be on the constant system, and plentiful—50 gallons per head per diem may be taken as a fair minimum estimate.

The closets ought to be of the simplest construction, the pans of earthenware all in one piece, the flushing arrangements simple but perfect, and the supply of water ample. Each ward should have its own closets, lavatories, &c., built in small annexes, with a cross-ventilated vestibule separating them from the ward. All the pipes should be disconnected from the drains, the closets by intercepting traps, the sink and waste pipes by being made to pour their contents over trapped gratings. The soil pipes should be ventilated, and placed outside the walls, protected as may be necessary from frost. Each ward should have a movable bath, which can be wheeled to the patient's bedside.

Each ward should have attached to it a small kitchen for any special cooking that may be required, a room for the physician or surgeon, and generally a room with one or two separate beds. No cooking should be done in the wards, nor ought washing, airing or drying of linen to be allowed there.

Hospital Economics.—There is no doubt that the voluntary system of hospital government is far more economical than any system of state or rate-supported hospitals. That the present condition of the voluntary hospitals in regard to economy is all that can be wished is not, of course, true. Still, resting as this system does upon the goodwill of the public for its continuance and maintenance, it is satisfactory to note that there is a continuous improvement in system and method, which makes for economy. It has taken many years to perfect and enforce the uniform system of hospital accounts, but this system with the co-operation of the great funds has produced economical results of the first importance. This system originated at the Queen's Hospital, Birmingham, in 1860, and was devised by an eminent Birmingham accountant, William Laundy, and Sir Henry Burdett. It proved so fruitful in practice that six years later it was introduced at the "Dreadnought" Seamen's Hospital, the first London hospital to use it, and was then adopted spontaneously by a few of the best-administered hospitals where the managers were keen in enforcing economy. In 1891, in order to secure for comparative purposes an identical classification of the items and charges included in the system, a glossary or index of classification was prepared and published in the *Hospital Annual* of that year. This index enabled the same classification of the many items included in the expenditure of a great institution to be adopted generally. In the same year a committee of hospital secretaries, at the instigation of the Metropolitan Hospital Sunday Fund, revised and elaborated the index of classification, and the new index was adopted by a general meeting of hospital secretaries in January 1892. The Council of the Metropolitan Hospital Sunday Fund approved it, and the Uniform System of Accounts was formulated by that body for the use of the metropolitan hospitals. In 1906 the whole of this system was inquired into on behalf of the King's Fund by Mr John G. Griffiths, F.C.A., when a committee of hospital secretaries and representatives of the King's Fund prepared a further revision of the system. This was completed in the course of the year and adopted by the King's, the Hospital Sunday and the

Hospital Saturday Funds. The publication of a book by Sir Henry Burdett led to the adoption of the system in several of the British Colonies, and as a result of the action taken in the British Empire the Uniform System of Accounts has recently been set up and adopted by the principal hospitals of the United States of America. The prince of Wales (George V.) testified to the value of this system in enforcing control over expenditure, and Sir Henry Burdett adapted it for the use of the authorities of all charities of every class. It is probable that no single reform has had a greater influence for good upon the administration of charitable institutions than the evolution and enforcement of the uniform system of accounts.

Nursing.—The arrangements for nursing the sick have greatly improved in recent times, although controversy still goes on as to the best method of carrying it out. In arranging for the nursing in a hospital both efficiency and economy have to be considered. No ward in a general hospital for acute cases should contain more than 24 beds. In hospitals with clinical schools the proportion of nurses to patients should be about one nurse to every three patients, and if possible every ward should have a probationer on duty at night in addition to the night nurse. In all well-conducted hospitals it is now arranged that the nurses on night duty have a hot meal served in the general dining-room during the night, and this is only possible where a nurse and a probationer are allowed for each ward. The nurses' quarters should be separate from the hospital proper, and connected by a conservatory or covered way. Each nurse should have a separate bedroom, measuring not less than 12 ft. long, 9 ft. broad and 10 ft. high. A bath should be allowed for every eight rooms, and the water-closets and sinks should, if possible, be in sanitary towers cut off from the main block of buildings.

Circumstances must to a large extent determine the arrangement, but it seems desirable on the whole that the work of a nurse should be confined to a single ward at a time if possible. The duties of nurses ought also to be distinctly confined to attendance on the sick, and no menial work, such as scrubbing floors and the like, should be demanded of them; a proper staff of servants ought to be employed for such purposes. It is also desirable that a separate pavilion for lodging the nurses should be set apart, and that fair and reasonable time for rest and recreation should be allowed. Some discussion has taken place as to the advisability of placing the nursing of a hospital in the hands of a sisterhood or a separate corporation. It will, however, be admitted that the best plan is for the nursing staff of each hospital to be special and under one head within the establishment itself, even though it may be connected with some main institution outside. The nursing must, of course, be carried on in accordance with the directions and treatment of the physicians and surgeons.

General.—The kitchen, laundry, dispensary and other offices must be in a separate pavilion or pavilions, away from the wards, but within convenient access. A separate pavilion for isolation of infectious cases is desirable. This may be a wooden hut, or in some cases even a tent; either is probably preferable to a permanent block of buildings. A disinfecting chamber ought to be provided where heat can be applied to clothes and bedding, for the destruction both of vermin and of the germs of disease. It is advisable to expose all bedding and clothing to its influence after each occasion of wear. Although this may entail additional expense from the deterioration of fabric, it is worth the outlay to secure immunity from disease. This plan is rigidly followed at the Royal South Hants Infirmary at Southampton. It is of great importance that the wards should be periodically emptied and kept unoccupied for not less than one month in each year, and longer if possible. During such period thorough cleansing and flushing with air could be carried out, so as to prevent any continuous deposit of organic matter.

Gate House or Admission Block.—If the efficiency of a hospital and the regular and smooth working of its departments are to be secured, the proper management and control of the admission department is of the greatest importance. When one considers for a moment the number of applicants of all ages in various stages of disease, and the number of accident cases of every degree of severity who present themselves every day seeking admission, it will be evident that the most careful supervision must be exercised on the very threshold. It is essential that every precaution be taken against the admission of an unsuitable case, or the refusal, without careful examination, of any patient seeking admission. It is only necessary to instance the case of a patient with delirium tremens being admitted to a general ward at a late hour, or a case of infectious disease admitted through an overlook, or a case refused admission and expiring on the way home, in order to illustrate the danger and trouble which might arise should the supervision exercised over this department not be systematic, stringent and thorough.

To secure this proper control it is necessary that the admission department should be designed on a definite plan suitable for the purposes in view. It is not sufficient to utilize any available rooms, say, in the basement of the building, where patients may be casually interviewed by a house surgeon or physician. This department should be as carefully designed and equipped as any other department of the hospital.

Within recent years much more attention has been devoted to the details of construction than was formerly considered necessary,

but even in the best type of hospital there is still much to be desired in this respect. It is essential for an architect in designing any building to have before him an accurate idea of all the requirements, and the use to which each foot of space is to be put; for unless he is furnished with this information it is not possible for him to design his building so as to give effect to all the details which are so necessary. The following is an endeavour in a general way to enumerate the various points which an architect should have before him in designing the admission department of a general hospital:—

The admission department should be conveniently placed on the ground floor of the hospital—or it may be a detached building—with a large court where ambulance wagons or other vehicles may easily pass each other on approaching or retiring from the institution. The entrance to the admission department for patients should, if possible, be entirely separate and distinct from that for the staff and students. An additional entrance should be provided for patients' friends on visiting days, in order that they may be able to enter the hospital without passing through the patients' entrance, or coming into contact with an accident case or other patient seeking admission. The main entrance door should be protected by a covered porch so that patients may be removed from the ambulance or cab to the examination room without being exposed to the weather or the gaze of inquisitive onlookers. This door should be sufficiently wide to allow two hand ambulances or barrows to pass should they require to be brought out to the ambulance or cab, and to facilitate this the floor of the entrance hall should be as nearly as possible on a level with that of the outside porch. Adjoining the entrance vestibule, lavatory accommodation should be provided for males and females who may accompany the patient. Lavatory accommodation should also be provided for porters on duty, and all lavatories should have a cut-off ventilating passage.

A recess to store ambulance barrows should adjoin the entrance, and this recess must be in proportion to the size of the hospital, in order that a hand ambulance may always be available when an accident or urgent case arrives. The vestibule should lead into a large waiting-hall with an inquiry office at its entrance, provided with a telephone exchange, private exchange box, also letter and parcel racks. If possible a window of the inquiry office should command a view of the main entrance. A room should be provided for the medical officer on duty, so that a medical officer may be always at hand and that no delay will occur in attending to a patient on arrival.

Leading off from this waiting-hall, well-lit examination rooms should be available for the thorough examination of patients, both male and female, the number of rooms, of course, varying with the size of the hospital and the amount of work to be done. Each of these rooms should be fitted with a wash-hand basin and sink, and a plentiful supply of hot and cold water.

Two rooms, with recovery rooms adjoining, should be fitted up as small operating-rooms for the treatment of minor casualties. A special room should also be furnished with an X-ray outfit, and arrangements should be made whereby this room can be readily darkened so that suspected fractures, &c., may be examined with the fluorescent screen.

Adjoining the admission department two small wards should be provided for the accommodation of drunk or noisy cases unfit to be placed in the general wards. To these "emergency wards" must be attached the usual bathroom and lavatory accommodation, nurses' room, ward kitchen and urine-test room or small lavatory. These wards should have double windows in order to prevent noise being heard outside if the wards are near other buildings.

The interior walls of the admission department should, as far as possible, have a smooth and impervious surface, in order that they may be easily cleaned. All angles should be avoided and all corners rounded. Although glazed tiles are open to the criticism that they have numerous joints, they probably make the most suitable wall yet devised, as they can be easily washed down at very small cost. The corridors and waiting-hall should be tiled to a height of 6 ft. 6 in., and the upper walls covered with Parian or Kean's cement, and be treated with three coats of flat paint and two coats of enamel, or, what is equally suitable and less costly, enamelled. The floors of the passages and corridors throughout the department should be covered with terrazzo, which is a mixture of Portland cement and marble chips. A margin of 1 ft. round the rooms should be treated in this way, and the terrazzo carried up this same distance on the wall to join the tiles. The remainder of the floors should be covered with hard wood, such as American maple or teak. As these floors require to be frequently washed, oak is not so suitable. Oak very soon becomes destroyed with water; the same trouble is experienced with pitch pine. The doors should also be made of a hard wood,

preferably teak, and have no mouldings or grooves where dust can lodge. They should be wide enough to admit an ambulance barrow or bed with ease. In no case should the doors of an examination room be less than 3 ft. 6 in. in width.

As an aid to a complete understanding of the varied work which has to be provided for, and the most effective method of carrying it out, the accompanying plans are given of an admission block designed to embody the main principles which govern the construction of such a department.

All accidents and patients seeking admission to this hospital enter through the central gateway, and on the left is shown the porters' room, where a porter is always in readiness to attend to any applicant. This room has suitable accommodation for parcels, letters, telephones, &c., and adjoining it is a small lavatory for the use of porters. At the side of the porters' room

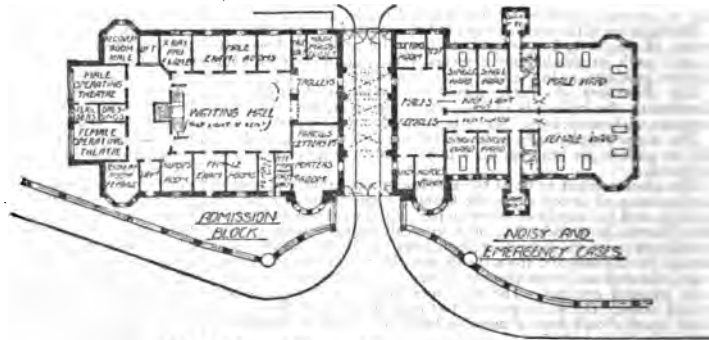
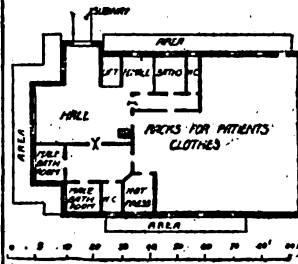

Plans of Ground Floor and Basement of a Hospital.

is the entrance to the central waiting-hall, which is lit from the roof. On one side of this hall are examination and dressing-rooms for males, with lavatory accommodation; and on the other side similar provision for females, with the addition of a nurses' duty room. At the end of the central hall are two operating theatres, with recovery room adjoining each; one theatre for males, and the other for females. Between these theatres are rooms for sterilisers and dressings. An X-ray examination room is provided beyond the male examination room on the right of the hall. In the basement, under the entrance-hall and operating theatres are two bathrooms for males and two for females, with W.C.'s for each. The remainder of the basement is used as a store for patients' clothes, and a hot-air chamber is provided for purposes of disinfection. The basement can be reached by a lift or by a wide staircase which is situated at the end of the waiting-hall.

In the above plan provision is made for a sitting-room for the medical officer on duty. This is a new and essential feature in the admission block unit of all hospitals in large cities, for it should secure that no patient is kept waiting for many minutes before being seen. One of the blots on the management of many hospitals is that regrettable delays often take place, and much dissatisfaction and avoidable suffering may arise from this difficulty in the administration of a general hospital. We have given this plan of a model gatehouse or admission block for a modern general hospital, because the block as it stands contains all the elements necessary for a receiving-house block in cities in connexion with a great Hospital city situated outside its area. In fulfilment of the suggestion for a Hospital city made above. Apart from its interest as a new feature which all new hospitals should adopt, the gatehouse or admission block has an importance in the wider sense, that it may come to form the key to the solution of the problem of how best to provide hospital accommodation for the poor in great cities under the best hygienic conditions, while protecting them from the misery and danger of prolonged delay in first treatment, especially in connexion with accidents and other cases of urgency.

BIBLIOGRAPHY.—Sir H. Burdett, *College Hospitals, General, Fever and Contagious*, their Construction, Management and Work (London, 1877-1880 and 1896); Tallet, *Les Edifices hospitaliers depuis leur*

origines jusqu'à nos jours (Paris, 1892); Sir H. Burdett, *Hospitals and Asylums of the World*, with large portfolio of plans to a uniform scale (London, 1893) (a supplement is published every year bringing the information up to date, entitled *Burdett's Hospitals and Charities*); J. S. Billings, *The Principles of Ventilation, Heating and their Practical Applications* (New York, 1893); Galton, *Healthy Hospitals* (London, 1893); Tollet, *Les Hôpitaux au XIX^e siècle* (Paris, 1894); Billings and Hurd, *Suggestions to Hospital and Asylum Visitors* (Philadelphia 1895); Oswald Kuhn, "Hospitals," *Handbuch der Architektur*, 4th part, 5th half-volume, part i. (Stuttgart, 1897); *Plans for the Johns Hopkins Hospital* (Baltimore, 1875); *Report of State Board of Health for Massachusetts for 1879*. (H. Br.)

HOSPITIUM (Gr. *ξενία, πρῶξενία*), "hospitality," among the Greeks and Romans, was of a twofold character: (1) private; (2) public.

(1) In Homeric times all strangers without exception were regarded as being under the protection of Zeus Xenios, the god of strangers and suppliants. It is doubtful whether, as is commonly assumed, they were considered as *ipso facto* enemies; they were rather guests. Immediately on his arrival, the stranger was clothed and entertained, and no inquiry was made as to his name or antecedents until the duties of hospitality had been fulfilled. When the guest parted from his host he was often presented with gifts (*ξένηα*), and sometimes a die (*ἀσπράγχαλος*) was broken between them. Each then took a part, a family connexion was established, and the broken die served as a symbol of recognition; thus the members of each family found in the other hosts and protectors in case of need. Violation of the duties of hospitality was likely to provoke the wrath of the gods; but it does not appear that anything beyond this religious sanction existed to guard the rights of a traveller. Similar customs seem to have existed among the Italian races. Amongst the Romans, private hospitality, which had existed from the earliest times, was more accurately and legally defined than amongst the Greeks, the tie between host and guest being almost as strong as that between patron and client. It was of the nature of a contract, entered into by mutual promise, the clasp of hands, and exchange of an agreement in writing (*tabula hospitalis*) or of a token (*lessera* or *symbolum*), and was rendered hereditary by the division of the tessera. The advantages thus obtained by the guest were, the right of hospitality when travelling and, above all, the protection of his host (representing him as his patron) in a court of law. The contract was sacred and inviolable, undertaken in the name of Jupiter Hospitalis, and could only be dissolved by a formal act.

(2) This private connexion developed into a custom according to which a state appointed one of the citizens of a foreign state as its representative (*πρόξενος*) to protect any of its citizens travelling or resident in his country. Sometimes an individual came forward voluntarily to perform these duties on behalf of another state (*ἑλενοπρόξενος*). The proxenus is generally compared to the modern consul or minister resident. His duties were to afford hospitality to strangers from the state whose proxenus he was, to introduce its ambassadors, to procure them admission to the assembly and seats in the theatre, and in general to look after the commercial and political interests of the state by which he had been appointed to his office. Many cases occur where such an office was hereditary; thus the family of Callias at Athens were proxeni of the Spartans. We find the office mentioned in a Corcyraean inscription dating probably from the 7th century B.C., and it continued to grow more important and frequent throughout Greek history. There is no proof that any direct emolument was ever attached to the office, while the expense and trouble entailed by it must often have been very great. Probably the honours which it brought with it were sufficient recompense. These consisted partly in the general respect and esteem paid to a proxenus, and partly in many more substantial honours conferred by special decree of the state whose representative he was, such as freedom from taxation and public burdens, the right of acquiring property in Attica, admission to the senate and popular assemblies, and perhaps even full citizenship. Public hospitium seems also to have existed among the Italian races; but the

circumstances of their history prevented it from becoming so important as in Greece. Cases, however, occur of the establishment of public hospitality between two cities (Rome and Caere, Livy v. 50), and of towns entering into a position of clientship to some distinguished Roman, who then became patronus of such a town. Foreigners were frequently granted the right of public hospitality by the senate down to the end of the republic. The public hospes had a right to entertainment at the public expense, admission to sacrifices and games, the right of buying and selling on his own account, and of bringing an action at law without the intervention of a Roman patron.

A full bibliography of the subject will be found in the article in Daremberg and Saglio, *Dictionnaire des antiquités*, to which may be added R. von Jhering, *Die Gastfreundschaft im Altertum* (1887); see also Smith's *Dictionary of Greek and Roman Antiquities* (3rd ed., 1890).

HOSPODAR, a term of Slavonic origin, meaning "lord" (Russ. *gospodar*). It is a derivative of *gospod*, "lord," and is akin to *gosudar*, which primarily means "sovereign," and is now also used in Russia as a polite form of address, equivalent to "sir." The pronunciation as *hospodar* of a word written *gospodar* in all but one of the Slavonic languages which retain the Cyrillic alphabet is not, as is sometimes alleged, due to the influence of Little Russian, but to that of Church Slavonic. In both of these *g* is frequently pronounced *h*. In Little Russian the title *hospodar* is specially applied to the master of a house or the head of a family. The rulers of Walachia and Moldavia were styled *hospodars* from the 15th century to 1866. At the end of this period, as the title had been held by many vassals of Turkey, its retention was considered inconsistent with the growth of Rumanian independence. It was therefore discarded in favour of *domn* (*dominus*, "lord"), which continued to be the official princely title up to the proclamation of a Rumanian kingdom in 1881.

HOST. (1) (Through the O. Fr. *ostis* or *hostis*, modern *hôte*, from Lat. *hospes*, a guest or host; *hospes* being probably from an original *hostipes*, one who feeds a stranger or enemy, from *hostis* and the root of *pascerre*), one who receives another into his house and provides him with lodging and entertainment, especially one who does this in return for payment. The word is thus transferred, in biology, to an animal or plant upon which a parasite lives. (2) (From Lat. *hostis*, a stranger or enemy; in Med. Latin a military expedition), a very large gathering of men, armed for war, an army, and so used generally of any multitude. In biblical use the word is applied to the company of angels in heaven; or to the sun, moon and stars, the "hosts of heaven," and also to translate "Jehovah Sabaoth," the Lord God of hosts, the lord of the armies of Israel or of the hosts of heaven. (3) (From Lat. *hostia*, a victim or sacrifice), the sacrifice of Christ's body and blood in the Eucharist, more particularly the consecrated wafer used in the service of the mass in the Roman Church (see EUCHARIST).

HOSTAGE (through Fr. *ostage*, modern *otage*, from Late Lat. *obsidaticum*, the state of being an *obses* or hostage; Med. Lat. *ostaticum*, *ostagium*), a person handed over by one of two belligerent parties to the other or seized as security for the carrying out of an agreement, or as a preventive measure against certain acts of war. The practice of taking hostages is very ancient, and has been used constantly in negotiations with conquered nations, and in cases such as surrenders, armistices and the like, where the two belligerents depended for its proper carrying out on each other's good faith. The Romans were accustomed to take the sons of tributary princes and educate them at Rome, thus holding a security for the continued loyalty of the conquered nation and also instilling a possible future ruler with ideas of Roman civilization. This practice was also adopted in the early period of the British occupation of India, and by France in her relations with the Arab tribes in North Africa.¹ The position of a hostage was that of a prisoner of war.

¹ The sultan of Bagiem, in Central Africa, in 1906 sent his nephew to undergo military training with a squadron of Spahis, and at the same time to serve as a guarantee of his fidelity to the French (*Bulletin du Comité de l'Afrique française*, Oct. 1906).

to be retained till the negotiations or treaty obligations were carried out, and liable to punishment (in ancient times), and even to death, in case of treachery or refusal to fulfil the promises made. The practice of taking hostages as security for the carrying out of a treaty between civilized states is now obsolete. The last occasion was at the treaty of Aix-la-Chapelle in 1748, when two British peers, Henry Bowes Howard, 11th earl of Suffolk, and Charles, 9th Baron Cathcart, were sent to France as hostages for the restitution of Cape Breton to France.

In modern times the practice may be said to be confined to two occasions: (1) to secure the payment of enforced contributions or requisitions in an occupied territory and the obedience to regulations the occupying army may think fit to issue; (2) as a precautionary measure, to prevent illegitimate acts of war or violence by persons not members of the recognized military forces of the enemy. During the Franco-Prussian War of 1870, the Germans took as hostages the prominent people or officials from towns or districts when making requisitions and also when foraging, and it was a general practice for the mayor and *adjoint* of a town which failed to pay a fine imposed upon it to be seized as "hostages" and retained till the money was paid. The last case where "hostages" have been taken in modern warfare has been the subject of much discussion. In 1870 the Germans found it necessary to take special measures to put a stop to train-wrecking by parties in occupied territory not belonging to the recognized armed forces of the enemy, an illegitimate act of war. Prominent citizens were placed on the engine of the train "so that it might be understood that in every accident caused by the hostility of the inhabitants their compatriots will be the first to suffer." The measure seems to have been effective. In 1900 during the Boer War, by a proclamation issued at Pretoria (June 19th), Lord Roberts adopted the plan for a similar reason, but shortly afterwards (July 29) it was abandoned (see *The Times' History of the War in S. Africa*, iv. 492). The Germans also, between the surrender of a town and its final occupation, took "hostages" as security against outbreaks of violence by the inhabitants. Most writers on international law have regarded this method of preventing such acts of hostility as unjustifiable, on the ground that the persons taken as hostages are not the persons responsible for the act;¹ that, as by the usage of war hostages are to be treated strictly as prisoners of war, such an exposure to danger is transgressing the rights of a belligerent; and as useless, for the mere temporary removal of important citizens till the end of a war cannot be a deterrent unless their mere removal deprives the combatants of persons necessary to the continuance of the acts aimed at (see W. E. Hall, *International Law*, 1904, pp. 418, 475). On the other hand it has been urged (L. Oppenheim, *International Law*, 1905, vol. ii., "War and Neutrality," pp. 271-273) that the acts, the prevention of which is aimed at, are not legitimate acts on the part of the armed forces of the enemy, but illegitimate acts by private persons, who, if caught, could be quite lawfully punished, and that a precautionary and preventive measure is more reasonable than "reprisals." It may be noticed, however, that the hostages would suffer should the acts aimed at be performed by the authorized belligerent forces of the enemy.

In France, after the revolution of Prairial (June 18, 1799), the so-called "law of hostages" was passed, to meet the insurrection in La Vendée. Relatives of *émigrés* were taken from disturbed districts and imprisoned, and were liable to execution at any attempt to escape. Sequestration of their property and deportation from France followed on the murder of a republican, four to every such murder, with heavy fines on the whole body of hostages. The law only resulted in an increase in the insurrection. Napoleon in 1796 had used similar measures to deal with the insurrection in Lombardy (*Correspondance de Napoleon I.* i. 323, 327, quoted in Hall, *International Law*).

¹ Article 50 of the Hague War Regulations lays it down that "no general penalty, pecuniary or otherwise, can be inflicted on the population on account of the acts of individuals for which it cannot be regarded as collectively responsible." The regulations, however, do not allude to the practice of taking hostage.

In May 1871, at the close of the Paris Commune, took place the massacre of the so-called hostages. Strictly they were not "hostages," for they had not been handed over or seized as security for the performance of any undertaking or as a preventive measure, but merely in retaliation for the death of their leaders E. V. Duval and Gustave Flourens. It was an act of maniacal despair, on the defeat at Mont Valérien on the 4th of April and the entry of the army into Paris on the 21st of May. Among the many victims who were shot in batches the most noticeable were Monsignor Darboy, archbishop of Paris, the Abbé Deguery, curé of the Madeleine, and the president of the Court of Cassation, Louis Bernard Bonjean.

HOSTE, SIR WILLIAM (1780-1828), British naval captain, was the son of Dixon Hoste, rector of Godwick and Tittlesbill in Norfolk. He was born on the 26th of August 1780 at Ingoldsthorpe, and entered the navy in April 1793, under the special care of Nelson, who had a lively affection for him. He became lieutenant in 1798, and was appointed commander of the "Mutine" brig after the battle of the Nile, at which he was present as lieutenant of the "Theseus." In 1802 he was promoted post captain by Lord St Vincent. During all his active career, he was employed in the Mediterranean and the Adriatic. From 1808 to 1814 he held the command of a detached force of frigates, and was engaged in operations against the French who held Dalmatia at the time, and in watching, or, when they came out, fighting, the ships of the squadron formed at Venice by Napoleon's orders. The work was admirably done, and was also lucrative; and Hoste, although he occasionally complained that his exertions did not put much money in his pocket, made a fortune of at least £60,000 by the capture of Italian and Dalmatian merchant ships. He also made many successful attacks on the French military posts on shore. His most brilliant feat was performed on the 13th of March 1811. A Franco-Venetian squadron of six frigates and five small vessels, under the command of a French officer named Dubourdieu, assailed Hoste's small force of four frigates near the island of Lissa. The French officer imitated Nelson's attack at Trafalgar by sailing down on the English line from windward with his ships in two lines. But the rapid manœuvring and gunnery of Hoste's squadron proved how little virtue there is in any formation in itself. Dubourdieu was killed, one of the French frigates was driven on shore, and two of the Venetians were taken. After the action, which attracted a great deal of attention, Hoste returned to England, but in 1812 he was back on his station, where he remained till the end of the war. During the peace he did not again go to sea, and he died on the 6th of December 1828. He married Lady Harriet Walpole in April 1817, and left three sons and three daughters.

In 1833 his widow published his *Memoirs and Letters*. See also Marshall, *Roy. Nav. Biog.* vol. iii., and James, *Naval History*.

HOSTEL, the old name for an inn (see *HOSPITAL*, *ad inu.*); also employed at Oxford and Cambridge to designate the lodgings which were in ancient times occupied by students of the university and to a certain extent regulated by the authorities. In some English public schools what is known as the "hostel" system provides for an organization of the lodging accommodation under separate masterships.

HOSTIUS, Roman epic poet, probably flourished in the 2nd century B.C. He was the author of a *Bellum Histricum* in at least seven books, of which only a few fragments remain. The poem is probably intended to celebrate the victory gained in 120 by Gaius Sempornius Tuditanus (consul and himself an annalist) over the Illyrian Iapydes (Appian, *Illyrica*, 10; Livy, *epi.* 59). Hostius is supposed by some to be the "doctus avus" alluded to in Propertius (iv. 20. 8), the real name of Propertius's Cynthia, according to Apuleius (*Apologia* x.) and the scholiast on Juvenal (vi. 7), being Hostia (perhaps Roscia).

Fragments in E. Bährens, *Fragmenta poetarum Romanorum* (1884); A. Weichert, *Poetarum Latinorum reliquias* (1830).

HOSUR, a town of British India, in the Salem district of Madras, 24 m. E. of Bangalore. Pop. (1901) 6695. It contains an old fort, frequently mentioned in the history of the Mysore wars, and a fine castellated mansion built by a former collector.

Close by is the remount dépôt, established in 1828, where Australian horses are acclimatized and trained for artillery and cavalry use in southern India.

HOTCH-POT, or **HOTCH-POUCH** (from Fr. *hocker*, to shake; used as early as 1292 as a law term, and from the 15th century in cookery for a sort of broth with many ingredients, and so used figuratively for any heterogeneous mixture), in English law, the name given to a rule of equity whereby a person, interested along with others in a common fund, and having already received something in the same interest, is required to surrender what has been so acquired into the common fund, on pain of being excluded from the distribution. "It seemeth," says Littleton, "that this word *hotch-pot* is in English a pudding; for in a pudding is not commonly put one thing alone, but one thing with other things together." The following is an old example given in Coke on Littleton: "If a man seized of 30 acres of land in fee hath issue only two daughters, and he gives with one of them 10 acres in marriage to the man that marries her, and dies seized of the other 20; now she that is thus married, to gain her share of the rest of the land, must put her part given in marriage into hotch-pot; *i.e.* she must refuse to take the profits thereof, and cause her land to be so mingled with the other that an equal division of the whole may be made between her and her sister, as if none had been given to her; and thus for her 10 acres she shall have 15, or otherwise the sister will have the 20." In the common law this seems to have been the only instance in which the rule was applied, and the reason assigned for it is that, inasmuch as daughters succeeding to lands take together as coparceners and not by primogeniture, the policy of the law is that the land in such cases should be equally divided. The law of hotch-pot applies only to lands descending in fee-simple. The same principle is noticed by Blackstone as applying in the customs of York and London to personal property. It is also expressly enacted in the Statute of Distributions (§ 5) that no child of the intestate, except his heir-at-law, who shall have any estate in land by the settlement of the intestate, or who shall be advanced by the intestate in his lifetime by pecuniary portion equal to the distributive shares of the other children, shall participate with them in the surplus; but if the estate so given to such child by way of advancement be not equivalent to their shares, then such part of the surplus as will make it equal shall be allotted to him. It has been decided that this provision applies only to advancements by *fathers*, on the ground that the rule was founded on the custom of London, which never affected a widow's personal estate. The heir-at-law is not required to bring any land which he has by descent or otherwise from the deceased into hotch-pot, but advancements made to him out of the personal property must be brought in. The same principle is to be found in the *collatio bonorum* of the Roman law: emancipated children, in order to share the inheritance of their father with the children unemancipated, were required to bring their property into the common fund. It is also found in the law of Scotland.

HOTEL-DE-VILLE, the town hall of every French municipality. The most ancient example still in perfect preservation is that at St-Antonin (Tarn-et-Garonne) dating from the middle of the 12th century. Other fine town halls are those of Compiègne, Orléans, Saumur, Beaugency and St Quentin. The Hôtel de Ville in Paris built in the 16th century was burnt by the Commune in 1871 and has since been rebuilt on an extended site, the central portion of the main front being a reproduction of the old design. There is only one town hall in a French town, those erected for the mayors of the different arrondissements in Paris being called *mairies*.

HÔTEL-DIEU, the name given to the principal hospital in any French town. The Hôtel-Dieu in Paris was founded in the year A.D. 660, has been extended at various times, and was entirely rebuilt between 1868-1878. One of the most ancient in France is at Angers, dating from 1153. The Hôtel-Dieu of Beaune (Côte-d'Or), founded 1443, is one of the most interesting, as it retains the picturesque disposition of its courtyard, with covered galleries on two storeys and large dormer windows;

and the great hall of the Hôtel-Dieu at Tommerre, Yonne (1338), nearly 60 ft. wide and over 300 ft. long, is still preserved as part of the chief hospital of the town.

HOTHAM, SIR JOHN (d. 1645), English parliamentarian, belonged to a Yorkshire family, and fought on the continent of Europe during the early part of the Thirty Years' War. In 1622 he was made a baronet, and he was member of parliament for Beverley in the five parliaments between 1625 and 1640, being sheriff of Yorkshire in 1635. In 1639 he was deprived by the king of his office of governor of Hull, and joining the parliamentary party refused to pay ship-money. In January 1642 Hotham was ordered by the parliament to seize Hull, where there was a large store of munitions of war; this was at once carried out by his son John. Hotham took command of Hull and in April 1642 refused to admit Charles I. to the town. Later he promised his prisoner, Lord Digby, that he would surrender it to the king, but when Charles appeared again he refused a second time and drove away the besiegers. Meanwhile the younger Hotham was taking an active part in the Civil War in Yorkshire and Lincolnshire, but was soon at variance with other parliamentary leaders, especially with the Fairfaxes, and complaints about his conduct and that of his troops were made by Cromwell and by Colonel Hutchinson. Soon both the Hothams were corresponding with the earl of Newcastle, and the younger one was probably ready to betray Hull; these proceedings became known to the parliament, and in June 1643 father and son were captured and taken to London. After a long delay they were tried by court-martial, were found guilty and were sentenced to death. The younger Hotham was beheaded on the 2nd of January 1645, and in spite of efforts made by the House of Lords and the Presbyterians to save him, the elder suffered the same fate on the following day. Sir John Hotham had two other sons who were persons of some note: Charles Hotham (1615-c. 1672), rector of Wigan, a Cambridge scholar and author of *Ad philosophiam Testonicam Manuductio* (1648); and Durant Hotham (1617-1691), who wrote a *Life of Jacob Boehme* (1654).

HOTHAM, WILLIAM HOTHAM, 1ST BARON (1736-1813), British Admiral, son of Sir Beaumont Hotham (d. 1771), a lineal descendant of the above Sir John Hotham, was educated at Westminster School and at the Royal Naval Academy, Portsmouth. He entered the navy in 1751, and spent most of his midshipman's time in American waters. In 1755 he became lieutenant in Sir Edward Hawke's flagship the "St George," and he soon received a small command, which led gradually to higher posts. In the "Syren" (20) he fought a sharp action with the French "Télémaque" of superior force, and in the "Fortune" sloop he carried, by boarding, a 26-gun privateer. For this service he was rewarded with a more powerful ship, and from 1757 onwards commanded various frigates. In 1759 his ship the "Melampe," with H.M.S. "Southampton," fought a spirited action with two hostile frigates of similar force, one of which became their prize. The "Melampe" was attached to Keppel's squadron in 1761, but was in the main employed in detached duty and made many captures. In 1776, as a commodore, Hotham served in North American waters, and he had a great share in the brilliant action in the Cul de Sac of St Lucia (Dec. 15th, 1778). Here he continued till the spring of 1781, when he was sent home in charge of a large convoy of merchantmen. Off Scilly Hotham fell in with a powerful French squadron, against which he could effect nothing, and many of the merchantmen went to France as prizes. In 1782 Commodore Hotham was with Howe at the relief of Gibraltar, and at the time of the Spanish armament of 1790 he flew his flag as rear-admiral of the red. Some time later he was made vice-admiral. As Hood's second-in-command in the Mediterranean he was engaged against the French Revolutionary navy, and when his chief retired to England the command devolved upon him. On March 12th, 1794 he fought an indecisive fleet action, in which the brunt of the fighting was borne by Captain Horatio Nelson, and some months later, now a full admiral, he again engaged, this time under conditions which might have permitted a decisive victory;

of this affair Nelson wrote home that it was a "miserable action." A little later he returned to England, and in 1797 he was made a peer of Ireland under the title of Baron Hotham of South Dalton, near Hull. He died in 1813. Hotham lacked the fiery energy and genius of a Nelson or a Jervis, but in subordinate positions he was a brave and capable officer.

As Hotham died unmarried his barony passed to his brother, Sir Beaumont Hotham (1737-1814), who became 2nd Baron Hotham in May 1813. Beaumont, who was a baron of the exchequer for thirty years, died on the 4th of March 1814, and was succeeded as 3rd baron by his grandson Beaumont Hotham (1794-1870), who was present at the battle of Waterloo, being afterwards a member of parliament for forty-eight years. He died unmarried in December 1870 and was succeeded by his nephew, Charles (1836-1872), and then by another nephew, John (1838-1907). In 1907 his cousin Frederick William (b. 1863) became the 6th baron.

Other distinguished members of this family were the 2nd baron's son, Sir Henry Hotham (1777-1833), a vice-admiral, who saw a great deal of service during the Napoleonic wars; and Sir William Hotham (1772-1848), a nephew of the 1st baron, who served with Duncan in 1797 off Camperdown and elsewhere.

See Charnock, *Biographia navalis*, vi. 236.

HOTHOTHOT, HEINRICH GUSTAV (1802-1873), German historian of art, was born at Berlin in 1802, and died in his native city on Christmas day 1873. During boyhood he was affected for two years with blindness consequent on an attack of measles. But recovering his sight he studied so hard as to take his degree at Berlin in 1826. A year of travel spent in visiting Paris, London and the Low Countries determined his vocation. He came home delighted with the treasures which he had seen, worked laboriously for a higher examination and passed as "dozent" in aesthetics and art history. In 1829 he was made professor at the university of Berlin. In 1833 G.F. Waagen accepted him as assistant in the museum of the Prussian capital; and in 1858 he was promoted to the directorship of the print-room. During a long and busy life, in which his time was divided between literature and official duties, Hothothot's ambition had always been to master the history of the schools of Germany and the Netherlands. Accordingly what he published was generally confined to those countries. In 1842-1843 he gave to the world his account of German and Flemish painting. From 1853 to 1858 he revised and published anew a part of this work, which he called "The school of Hubert van Eyck, with his German precursors and contemporaries." His attempt later on to write a history of Christian painting overtaxed his strength, and remained unfinished. Hothothot is important in the history of aesthetics as having developed Hegel's theories; but he was deficient in knowledge of Italian painting.

HOTHOTHOT-MARDAN, or **MARDAN**, a frontier cantonment of British India in the Peshawar district of the North-West Frontier Province, situated 15 m. N. of Nowshera. Pop. (1901) 3572. It is notable as the permanent headquarters of the famous corps of Guides, and also contains a cavalry brigade belonging to the 1st division of the northern army.

HOTHOTHOT, FRANÇOIS (1524-1590), French publicist, eldest son of Pierre Hothothot, was born on the 23rd of August 1524, at Paris, his family being of Silesian origin. His name is latinized by himself Hothothotanus, by others Hothothotannus and Hothothotannus. His father, a zealous Catholic, and a counsellor of the parlement of Paris, destined him for the law, and sent him at the age of fifteen to the university of Orleans. He obtained his doctorate in three years, and became a pleader at Paris. The arts of the barrister were not to his taste; he turned to the study of jurisprudence and literature, and in 1546 was appointed lecturer in Roman Law at the university of Paris. The fortitude of Anne Dubourg under torture gained his adhesion to the cause of Reform. Giving up a career on which he had entered with high repute, he went in 1547 to Lyons, and thence to Geneva and to Lausanne, where, on the recommendation of Calvin, he was appointed professor of belles-lettres and history, and married Claudine Aubelin, a refugee from Orleans. On the

invitation of the magistracy, he lectured at Strassburg on law in 1555, and became professor in 1556, superseding François Baudouin, who had been his colleague in Paris. His fame was such that overtures were made to him by the courts of Prussia and Hesse, and by Elizabeth of England. Twice he visited Germany, in 1556 accompanying Calvin to the Diet at Frankfurt. He was entrusted with confidential missions from the Huguenot leaders to German potentates, carrying at one time credentials from Catherine de Medici. In 1560 he was one of the principal instigators of the conspiracy of Amboise; in September of that year he was with Antoine of Navarre at Nérac. In 1562 he attached himself to Condé. In 1564 he became professor of civil law at Valence, retrieving by his success the reputation of its university. In 1567 he succeeded Cujas in the chair of jurisprudence at Bourges. Five months later his house and library were wrecked by a Catholic mob; he fled by Orleans to Paris, where L'Hôpital made him historiographer to the king. As agent for the Huguenots, he was sent to Blois to negotiate the peace of 1568. He returned to Bourges, only to be again driven away by the outbreak of hostilities. At Sancerre, during its siege, he composed his *Consolatio* (published in 1593). The peace of 1570 restored him to Bourges, whence a third time he fled, in consequence of the St Bartholomew massacre (1572). In 1573, after publishing his *Franco-Gallia*, he left France for ever with his family, and became professor of Roman law at Geneva. On the approach of the duke of Savoy he removed to Basel in 1579. In 1580 he was appointed councillor of state to Henry of Navarre. The plague sent him in 1582 to Montbéliard; here he lost his wife. Returning to Geneva in 1584 he developed a kind of scientific turn, dabbling in alchemy and the research for the philosopher's stone. In 1589 he made his final retirement to Basel, where he died on the 12th of February 1590, leaving two sons and four daughters; he was buried in the cathedral.

Hothothot was a man of pure life, real piety (as his *Consolatio* shows) and warm domestic virtues. His constant removals were inspired less by fear for himself than by care for his family, and by a temperament averse to the conditions of warfare, and a constitutional desire for peace. He did much for 16th-century jurisprudence, having a critical knowledge of Roman sources, and a fine Latin style. He broached the idea of a national code of French law. His works were very numerous, beginning with his *De gradibus cognationis* (1546), and including a treatise on the Eucharist (1566); a treatise (*Anti-Tribonian*, 1567) to show that French law could not be based on Justinian; a life of Coligny (1575); a polemic (*Brutum fulmen*, 1585) directed against a bull of Sixtus V., with many other works on law, history, politics and classical learning. His most important work, the *Franco-Gallia* (1573), was in advance of his age, and found favour neither with Catholics nor with Huguenots in its day; yet its vogue has been compared to that obtained later by Rousseau's *Contrat Social*. It presented an ideal of Protestant statesmanship, pleading for a representative government and an elective monarchy. It served the purpose of the Jesuits in their pamphlet war against Henry IV.

See Bayle, *Dictionnaire*; R. Darest, *Essai sur F. Hothothot* (1850); E. Grégoire, in *Nouvelle Biog. générale* (1858). (A. G. S.)

HOTHOTHOT SPRINGS, a city of Arkansas, U.S.A., the county-seat of Garland county, at the easterly base of the Ozark mountains, 55 m. by rail W.S.W. of Little Rock. Pop. (1880) 3554; (1890) 8086; (1900) 9973, of whom 3102 were of negro descent and 561 were foreign-born; (1910 census) 14,434. The transient population numbers more than 100,000 annually. Hot Springs is served by the Chicago, Rock Island & Pacific, the Little Rock & Hot Springs Western, and the St. Louis, Iron Mountain & Southern railways. The city lies partly in several mountain ravines and partly on a plateau. A creek, flowing through the valley but walled over, empties into the Ouachita river several miles from Hot Springs. The elevation of the surrounding hills is about 1200 ft. above the sea and 600 above the surrounding country. The scenery is beautiful, and there is a remarkable view from a steel tower observatory 150 ft. high, on the top of Hot Springs mountain. The climate is delightful. The

average rainfall for the year is about 55 in. The springs are about forty-four in number, rising within an area of 3 acres on the slope of Hot Springs mountain. They are all included within a reservation held by the United States government, which (since 1903) exercises complete jurisdiction. The daily flow from the springs used is more than 800,000 gallons. Their temperature varies from 95° to 147° F. The waters are tasteless and inodorous, and contain calcium and magnesium bicarbonates, combinations of hydrogen and silicon, and of iodides, bromides and lithium. The national government maintains at Hot Springs an army and navy hospital, and a bath-house open gratuitously to indigent bathers. The business of Hot Springs consists mainly in caring for its visitors. Fruit-raising and small gardening characterize its environs. There are sulphur, lithia and other springs near the city, and an ostrich farm and an alligator farm in the suburbs. The finest of the novaculite rocks of central Arkansas are quarried near the city. The total value of its factory product in 1905 was \$597,029, an increase of 213.1% since 1900.

The Springs were first used by the itinerant trappers. They were visited about 1800 by French hunters; and by members of the Lewis and Clark party in 1804 under instructions from President Thomas Jefferson. The permanent occupation of the town site dates only from 1828, though as early as 1807 a temporary settlement was made. In 1876 Hot Springs was incorporated as a town, and in 1879 it was chartered as a city. In 1832 Congress created a reservation, but the right of the government as against private claimants was definitely settled only in 1876, by a decision of the United States Supreme Court. The city was almost destroyed by fire in 1878, and was greatly improved in the rebuilding.

HOT SPRINGS, a hamlet and health-resort in Cedar Creek District, Bath county, Virginia, U.S.A., 25 m. by rail (a branch of the Chesapeake & Ohio railway) N. by E. of Covington and near the N.W. border of the state. It lies in a narrow valley, about 2200-2500 ft. above the sea, with rugged mountains on either side. Pop. of the district (1900) 1761; (1910) 2472. The mean summer temperature is only 69° F., and the summer nights are always cool. There is a good golf-course. Mineral waters (with magnesia, soda-lithia and alum) issue from several springs, some at a temperature as high as 106° F., and are used both for drinking and for bathing. The Warm Sulphur Springs (about 98° F.) are 5 m. N.; Healing Springs (85° F.) are 2½ m. S. of Hot Springs; and a few miles to the S.E., in Rockbridge county, are Rockbridge and Jordan Alum Springs.

HOTTENTOTS, an African people of western Cape Colony and the adjoining German territory, formerly widely spread throughout South Africa. The name is that given them by the early Dutch settlers at the Cape, being a Dutch word of an onomatopoeic kind to express stammering, in reference to the staccato pronunciation and clicks of the native language. Some early writers termed them Hodmadods or Hodmandods, and others Hot-nots and Otentots—all corruptions of the same word. Their name for themselves was Khoi-Khoi (men of men), or Quae Quae, Kwekhena, t'Kuhkeub, the forms varying according to the several dialects. Early authorities believed them to be totally distinct from all other African races. The researches of Gustav Fritsch, Dr E. T. Hamy, F. Shrubbsall and others have demonstrated, however, that they are not so much a distinct or independent variety of mankind as the result of a very old cross between two other varieties—the Bantu Negro (containing a distinct Hamitic element) and the Bushman. Hamy calls them simply "Bushman-Bantu half-breeds," the Bushman element being seen in the leathery colour, compared to that of the "sere and yellow leaf"; in the remarkably prominent cheek-bones and pointed chin, giving the face a peculiarly triangular shape; and lastly, in such highly specialized characters as the *tablier* and the *scatopygia* of the women. The cranial capacity is also nearly the same (1331 c.c. in the Bushman, 1365 c.c. in the Hottentot), and on these anatomical grounds Shrubbsall concludes that the two are essentially one race, allowing for the undeniable strain of Bantu blood in the Hottentot. This view is further

strengthened by the vast range in prehistoric times of the Hottentot variety, which, since the time of Martin H.K. Lichtenstein (1800-1804), was known to have comprised the whole of Africa south of the Zambezi, and has since been extended as far north as the equatorial lake region.

Fritsch divides the Hottentots into three bodies; the Cape Hottentots, from the Cape peninsula eastward to Kaffraria, the Koranna, chiefly on the right bank of the Orange river, but also found on the Harts and the Vaal, and the Namaqua in the western portion of South Africa. Of these all save the last mentioned have ceased to exist in any racial purity. The name which the Namaqua give to themselves is *Khoi-Khoi*, and this name must be distinguished from that of the Berg-Damara or *Hau-Khoi*, since the latter are physically of Bantu origin though they have borrowed their speech from the Hottentots. While the Namaqua preserve the racial type and speech, the other so-called Hottentots are more or less Hottentot-Dutch or Hottentot-Bantu half-breeds, mainly of debased Dutch speech, although the Koranna still here and there speak a moribund Hottentot jargon flooded with Dutch and English words and expressions. When the Cape Colony became a part of the British empire the protection given to the natives arrested the process of extermination with which the Hottentots were then threatened, but it did not promote racial purity. Sir John Barrow, describing the condition of the Hottentots in 1798, estimated their number at about 15,000 souls. In 1806 the official return gave a Hottentot population of 9784 males and 20,642 females. In 1824 they had increased to 31,000. At the census of 1865 they numbered 81,589, but by this time the official classification "Hottentot" signified little more than a half-breed. The returns for 1904 showed a "Hottentot" population of 85,892. Very few of these were pure-bred Hottentots, while the official estimate of those in which Hottentot blood was strongly marked was 56,000.

Customs and Culture.—The primitive character of the race having greatly changed, the best information as to their original manners and customs is therefore to be found in the older writers. All these agree in describing the Hottentots as a gentle and friendly people. They held in contempt the man who could eat, drink or smoke alone. They were hospitable to strangers, even to the point of impoverishing themselves. Although mentally and physically indolent, they were active in the care of their cattle and, within certain limits, clever hunters. They were of a medium height, the females rather smaller than the men, slender but well proportioned, with small hands and feet. Their skin was of a leathery brown colour; their face oval, with prominent cheekbones; eyes dark brown or black and wide apart; nose broad and thick and flat at the root; chin pointed and mouth large, with thick turned-out lips. Their woolly hair grew in short thick curly tufts and the beard was very scanty. Amongst the women abnormal developments of fat were somewhat common; and cases occurred of extraordinary elongation of the *labia minora* and of the *præputium clitoridis*.

Their dress was a skin cloak (*kaross*) worn across the shoulders and a smaller one across the loins. They wore these cloaks all the year round, turning the hairy side inward in winter and outward in summer; they slept in them at night, and when they died they were buried in them. They had suspended around their necks little bags or pouches, containing their knives, their pipes and tobacco or *dakka* (*Cannabis*, or hemp), and an amulet of burnt wood. On their arms were rings of ivory. Sometimes they wore sandals and carried a jackal's tail fastened on a stick, which served as handkerchief and fan. The women wore, besides the *kaross*, a little apron to which were hung their ornaments; and underneath this one or two fringed girdles; and a skin cap. Both sexes smeared themselves and even their dress with an ointment made of soot, butter or fat, and the powdered leaves of a shrub called by them *buchchu* (*Diasma crenata*).

Their villages were usually on meadow grounds. They never entirely exhausted the grass but kept moving from one pasture to another. The huts were in circles, the area of which varied with the pastoral wealth of the community. In the centre of the huts a hole served for a fire-place, and at each side of this small excavations an inch or two deep were made in the ground in which both sexes, rolled up in their *karosses*, slept. A few earthen vessels, well-made bowls of wood, tortoise shells for spoons and dishes, calabashes, bamboos and skins for holding milk and butter, and mats of rushes interwoven with bast, were all their furniture. Their weapons were primarily bows and arrows, but they also possessed assegais.

¹ See paper by Messrs Flower and Murne in *Journ. Comp. Anat. and Physiology* (1867); and Fritsch, *Die Eingebornen Süd-Afrikas* (Breslau, 1873).

and knob-herries. To women much respect was shown; the most sacred oath a Hottentot could take was to swear by his sister or mother; yet the females ate apart from the men and did all the work of the kraal with the exception of the tending of cattle and of the curing of the hides; the men, however, assisted in the erection of the framework of the huts. The usual food of the Hottentots was milk, the flesh of the buffalo, hippopotamus, antelope or other game, and edible roots and bulbs or wild fruits. On the coast fish captured by hooks and lines or spears were also eaten. Cows' milk was commonly drunk by both sexes, but ewes' milk only by the women, and when cows' milk was scarce the women were obliged to keep to ewes' milk or water. Milk was drunk fresh, and not allowed to turn sour as among the Bantu. Meats were eaten either roasted or boiled, but for the most part half raw, without salt, spices or bread. From some meats they carefully abstained, such as swine's flesh. Hares and rabbits were forbidden to the men, but not to the women; the pure blood of beasts and the flesh of the mole were forbidden to the women, but not to the men.

In occupation they were essentially cattle-breeders, and showed great skill in this pursuit, especially the Namaqua, who were capable of training the horns of their cattle so that they grew in spirals. Their social pleasures consisted in feasting, smoking, dancing and singing. Dances were held every first quarter of the moon and lasted all night, often for eight days in succession. Every signal event of life, and every change of abode and condition was celebrated with a feast. On the formation of a new kraal an arbour was constructed in the centre, and the women and children adorned and perfumed it with flowers and branches of trees and odoriferous herbs. The fattened ox was killed and cooked, and the men ate of it in the arbour, while the women sitting apart regaled themselves with broth. Upon such occasions the only intoxicant was tobacco or daktka.

Circumcision, which is common to the Kaffir tribes, was unknown to the Hottentots, but when a youth entered upon manhood a ceremony was performed. One of the elders, using a knife of quartz, made incisions in the young man's body, afterwards besprinkling them with urine. When a man killed his first elephant, hippopotamus or rhinoceros, similar marks were made on his body, and were regarded as insignia of honour. Finger mutilation was common, especially among women; this consisted in the removal of one or two joints of the little finger, and, sometimes, the first joint of the next. The reason for this is doubtful; it may have been a sign of mourning, or, especially in the case of children, it may have been regarded as magically protective. Marriages were by arrangement between the man and the girl's parents, the consent of the girl herself being a matter of little consideration. If accepted, the suitor, accompanied by all his kindred, drove two or three fat oxen to the house of his bride. There her relations welcomed the visitors; the oxen were slain, and the bridal feast took place. The nuptial ceremony was concluded by an elder besprinkling the happy pair. Among the southern Hottentots these ancient usages have ceased; but they are continued among some tribes north of the Orange river. Polygamy was allowed; divorce was common. Family names were perpetuated in a peculiar manner—the sons took the family name of the mother, the daughters that of the father. The children were very respectful to their parents, by whom they were kindly and affectionately treated. Yet the aged father or mother was sometimes put in the bush and left to die. Namaqua says this was done by very poor people if they had no food for their parents. But even when there was food enough, aged persons, especially women, who were believed to be possessed of the evil spirit, were so treated.

The Hottentots had few musical instruments. One named the "gorah" was formed by stretching a piece of the twisted entrails of a sheep from end to end of a thin hollow stick about 3 ft. in length in the manner of a bow and string. At one end there was a piece of quill fixed into the stick, to which the mouth of the player was applied. The "rommel-pot" was a kind of drum shaped like a bowl and containing water to keep the membrane moist. Reeds several feet long were used as flutes.

Government and Laws.—The system of government was patriarchal. Each tribe had its hereditary "khu-khoi" or "gao-ao" or chief, and each kraal its captain. These met in council whenever any great matters had to be decided. The post was honorary, and the councillors were held in great reverence, and were installed in office with solemnities and feasting. In certain tribes the hind part of every bullock slaughtered was sent to the chief, and this he distributed among the males of the village. He also collected sufficient milk at the door of his hut to deal out amongst the poor. A part of every animal taken in hunting was exacted by the chief, even though it was in a state of putrefaction when brought in. The captains, assisted by the men of each kraal, settled disputes regarding property and tried criminals. A murderer was beaten or stoned to death; but if one escaped and was at large for a whole year, he was allowed to go unpunished. Adultery seldom occurred; if any one found parties in the act and killed them he was no murderer, but on the contrary received praise for his deed. Women found offending were burnt. Theft, especially cattle-stealing, was severely punished. The thief was bound hand and foot, and left on the ground without food for a long time; then, if his offence was slight, he received some blows with a stick, but if his case was

an aggravated one, he was severely beaten, and then unloosed and banished from the kraal. The family of even the worst criminal suffered nothing on his account in reputation, privilege or property. The duel was an institution. If any one was insulted he challenged his enemy by offering him a handful of earth. If the latter seized the hand and the dust fell to the ground, the challenge was accepted. If it was not accepted, the challenger threw the dust in his foe's face. The duel took place by kicking, with clubs, or with the spear and shield.

Religious Ideas.—The religious ideas of the Hottentots were very obscure. François le Vaillant says they had "neither priests nor temples, nor idols, nor ceremonies, nor any traces of the notion of a deity." Other authorities state that they believed in a benevolent deity or "Great Captain," whom they named Tik-guoa (*Tsu-goab*). There were other "captains" of less power, and a black captain named Gauna, the spirit of evil. The moon was a secondary divinity, supposed to govern the weather; and its appearance each month was hailed with dancing and singing. George Schmidt, the first missionary to the Hottentots, says they also celebrated the annual appearance of the Pleiades above the eastern horizon. As soon as the constellation appeared, all the mothers ascended the nearest hill, carrying their babies, whom they taught to stretch their arms towards the friendly stars. Some of the tribes are said to worship a being whom they name Tsuib, the rain god. An old Namaqua was once heard to say "The stars are the souls of the deceased," and a Hottentot form of imprecation is "Thou happy one, may misfortune fall on thee from the star of my grandfather."

Such as it was, the Hottentot religion was largely ancestor-worship. Their deified hero was named Heitsi-Eibib; and of him endless stories are told. The one most generally accepted is that he was a notable warrior of great physical strength, who once ruled the Khoi-Khoi, and that in a desperate struggle with one of his enemies, whom he finally overcame, he received a wound in the knee, from which event he got the name of "Wounded knee." He had extraordinary powers during life, and after death he continued to be invoked as one who could still relieve and protect. According to the tradition preserved among the Namaqua, Heitsi-Eibib came from the east. Therefore they make the doors of their huts towards the east, and those who possess waggon and carts put their vehicles alongside the mat-house with the front turned towards the east. All the graves are in true west-easterly direction, so that the face of the deceased looks towards the east. The spirit of Heitsi-Eibib is supposed to exist in the old burial places, and whenever a heathen Hottentot passes them, he throws stones on the spot as an offering, at the same time invoking the spirit's blessing and protection. Johann Georg von Hahn asserts that there are many proofs which justify the conclusion that Heitsi-Eibib and Tsu-goab (the supreme being) were identical. Both were benevolent. Both were believed to have died and risen again. They killed the bad beings and restored peace on earth; they promised men immortality, understood the secrets of nature, and could foretell the future.¹

Various ceremonies were practised to ward off the evil influence of ghosts and spirits, and charms were freely employed. If a Khoi-Khoi went out hunting his wife kindled a fire, and assiduously watched by it to keep it alive; if the fire should be extinguished her husband would not be lucky. If she did not make a fire, she went to the water and kept on throwing it about on the ground, believing that thereby her husband would be successful in getting game. Charms, consisting of bones, burnt wood, and roots of particular shrubs cut into small pieces, were generally worn round the neck. There was also a belief that in every fountain there was a snake, and that as long as the snake remained there water would continue to flow, but that if the snake was killed or left the fountain it would cease. Offerings were sometimes made to the spirit of the fountain. In common with the Bushmen, the Hottentots venerated the *mantis fausta*, a local variety of the insect known as "the praying mantis" (*mantis religiosa*). P. Kolbe saw sacrifices made in its honour when it appeared inside a kraal; to kill it was strictly forbidden. The Hottentots had great faith in witch-doctors, or sorcerers. When called to a sick-bed these ordered the patient to lie on his back, and then pinched, cuffed, and beat him all over until they expelled the illness. After that they produced a bone, small snake, frog or other object which they pretended to have extracted from the patient's body. If the treatment did not succeed, the person was declared incurably bewitched. If death occurred, the corpse was interred on the day of decease. It was wrapt in skins, and placed in the ground in the same position it once occupied in the mother's womb. Death was generally regarded in a very *social* manner.

Language.—The existence of a fundamental connexion between the language of the Hottentot and that of the Bushman was

¹ An interesting notice of this form of worship occurs in the journal of an expedition which the Dutch governor, Ryk van Tulbagh, sent to the Great Namaqua in 1752, which reached as far as the Kamob or Lion river (about 27° S. lat.).

² On the religion and antiquities see Theophilus Hahn's papers, "Graves of the Heitsi-Eibib," in *Cape Monthly Magazine* (1879), and "Der hottentottische Zai-goab und der griechische Zeus," in *Zeitschr. für Geogr.* (Berlin, 1870).

suggested by Dr Bleek and is supported by further evidence advanced by Bertin.

The Hottentot language was regarded by the early travellers and colonists as an uncouth and barbarous tongue. The Portuguese called the native manner of speaking stammering; and the Dutch compared it to the "gobbling of a turkey-cock." These phonetic characteristics arose from the common use of "clicks,"—sounds produced by applying the tongue to the teeth or to various parts of the gums or roof of the mouth, and suddenly jerking it back. Three-fourths of the syllabic elements of the language begin with these clicks, and combined with them are several hard and deep gutturals and nasal accompaniments. The difficulty a European has in acquiring an accurate pronunciation is not so much in producing the clicking sound singly as in following it immediately with another letter or syllable. The four recognized clicks, with the symbols generally adopted to denote them, are as follows: dental = |; palatal = #; lateral = !; cerebral = l. According to Tindall, one of the best grammarians of the language, the dental click (similar to a sound of surprise or indignation) is produced by pressing the top of the tongue against the upper front teeth, and then suddenly and forcibly withdrawing it. The palatal click (like the crack of a whip) is produced by pressing the tongue with as flat a surface as possible against the termination of the palate at the gums, so that the top of the tongue touches the upper front teeth and the back of the tongue lies towards the palate, and then forcibly withdrawing the tongue. The cerebral click (compared to the popping of the cork of a bottle of champagne) is produced by curling up the tip of the tongue against the roof of the palate, and withdrawing it suddenly and forcibly. The lateral click (similar to the sound used in stimulating a horse to action) is articulated by covering with the tongue the whole of the palate and producing the sound as far back as possible; Europeans imitate it by placing the tongue against the side teeth and then withdrawing it. The easiest Hottentot clicks, the dental and cerebral, have been adopted by the Kaffirs; and it is a striking circumstance, in evidence of the past Hottentot influence upon the Kafir languages, that the clicking decreases amongst these tribes almost in proportion to their distance from the former Hottentot domain.

The language in its grammatical structure is beautiful and regular. Dr Bleek describes it as having the distinctive features of the suffix-pronominal order or higher form of languages, in which the pronouns are identical with and borrowed from the derivative suffixes of the nouns. The words are mostly monosyllables, always ending, with two exceptions, in a vowel or nasal sound. Among the consonants neither *l*, nor *f* nor *v* is found. There are two *g*'s, *g* hard and *g* guttural, and a deeper guttural *kh*. Diphthongs abound. There is no article, but the definite or indefinite sense of a noun is determined by the gender. In the fullest known dialect (that spoken by the Namaqua) nouns are formed with eight different suffixes, which in nouns designating persons distinguish masc. sing. (-b), masc. plur. (-ku), max. dual (-ha), fem. sing. (-s), fem. plur. (-h), com. sing. (-h), com. plur. or referred to by a suffixed pronoun. This grammatical division of the nouns, according to gender led to the classification of the language as "sex-denoting" thus suggesting its relationship, in original structure, with the Galla and others.

There are four dialectal varieties of the language, each with well-marked characteristics: the Nama dialect, spoken by the Namaqua as well as by the Hau-Khoïn or Hill Damara; the Kora dialect, spoken by the Koranna, or Koragua, dwelling about the middle and upper part of the Orange, Vaal and Modder rivers; the Eastern dialect, spoken by the Gona or Gonaqua on the borders of Kaffrland; and the Cape dialect, now no longer spoken but preserved in the records of early voyagers and settlers. Of the Nama dialect there are three grammars: Wallmann's (1857) and Hahn's in German, and Tindall's (1871) in English, the last being the best; and the four Gospels, with a large amount of missionary literature, have been published in it.

The vocabulary is not limited merely to the expression of the rude conceptions that are characteristic of primitive races. It possesses such words as *hoi*, human being; *hohi-si*, kindly or friendly; *hohi-si-b*, philanthropist; *hohi-si-s*, humanity; # *ei*, to think; # *ei-s*, thought; *amo*, eternal; *amo-si-b*, eternity; *isa*, to feel; *isa-b*, feeling, sentiment; *isa-ha*, to condole; *ama*, true; *ama-b*, the truth; *anu*, sacred; *anu-si-b*, holiness; *esa*, pretty; *anu-so*, full of beauty.

Literature and History.—Much traditional literature—fables, myths and legends—existed amongst the Hottentots,—a fact first made known by Sir James Alexander, who in his journeys through Great Namaqualand in 1835 jotted down the stories told him around the camp fire by his Hottentot followers. These Hottentot tales generally have much of the character of fables; some are in many points identical with northern nursery tales, and suggestive of European origin or of contact with the white man; but the majority bear evidence of being true native products. Bleek's *Reynard the Fox in South Africa* (1864) contains a translation of a legend written down from the lips of the Namaqua by the Rev. G. Krönlén, which is regarded as an excellent specimen of the national style. Another legend relating to the moon and the hare conveys the idea of an early conception of the hope of immortality.

It is found in various versions, and, like many other stories, occurs in Bushman as well as in Hottentot mythology.

The earliest accounts of the Hottentots occur in the narratives of Vasco da Gama's first voyage to India round the Cape in 1497-1498. In 1510 the Portuguese viceroy, Francisco d'Almeida, count of Abrantes, met his death in a dispute with the natives. Till the 17th century they were believed to be cannibals, but with the occupation of the Cape by the Dutch, in 1652, more accurate knowledge was obtained. A century of Dutch rule resulted in the Hottentots becoming a nation of slaves and in serious danger of extermination, and thus the arrival of the English in 1795 was welcomed by them. In 1828 an ordinance was passed declaring "all Hottentots and other free persons of colour" entitled to all and every right to which any other British subjects were entitled. (See CAPE COLONY: History; and SOUTH AFRICA.)

BIBLIOGRAPHY.—A. de Quatrefages, *Les Pygmées* (1887); G. W. Stow, *The Native Races of South Africa* (1905); E. T. Hamy, "Les Races nègres," in *L'Anthropologie* (1897), pp. 257 et seq.; F. Shrubhall, "Crania of African Bush Races," in *Jour. Anthropol. Inst.* (November 1897); W. H. J. Bleek, *A Comparative Grammar of South African Languages* (1862); and "Die Hottentotten Stämme," in *Petermanns Mit.* (1858), pp. 49 et seq.; G. Fritsch, *Die Eingeborenen Süd-Afrikas* (1872); and "Schilderungen der Hottentotten," in *Globus* (1875), pp. 374 et seq.; G. Bertin, "The Bushmen and their Language," in *Jour. R. Asiatic Soc.* xviii., part i., and reprint; P. Kolbe or Kolben, *Present State of the Cape of Good Hope*; Sir John Barrow, *Travels in South Africa* (1801-1804).

HOTTINGER, JOHANN HEINRICH (1620-1667), Swiss philologist and theologian, was born at Zürich on the 10th of March 1620. He studied at Geneva, Groningen and Leiden, and after visiting France and England was in 1642 appointed professor of church history in his native town. The chair of Hebrew at the Carolinum was added in 1643, and in 1653 he was appointed professor ordinarius of logic, rhetoric and theology. He gained such a reputation as an Oriental scholar that the elector palatine in 1655 appointed him professor of Oriental languages and biblical criticism at Heidelberg. In 1661, however, he returned to Zürich, where in 1662 he was chosen principal of the university. In 1667 he accepted an invitation to succeed Johann Hoornbeck (1617-1666) as professor in the university of Leiden, but he was drowned with three of his children by the upsetting of a boat while crossing the river Limmat. His chief works are *Historia ecclesiastica Nov. Test.* (1651-1667); *Thesaurus philologicus seu clavis scripturæ* (1649; 3rd ed. 1698); *Etymologicon orientale, sive lexicon harmonicum heptaglotton* (1661). He also wrote a Hebrew and an Aramaic grammar.

His son, **JOHANN JAKOB HOTTINGER** (1652-1735), who became professor of theology at Zürich in 1698, was the author of a work against Roman Catholicism, *Hebeteische Kirchengeschichte* (4 vols., 1698-1729); and his grandson, **JOHANN HEINRICH HOTTINGER** (1681-1750), who in 1721 was appointed professor of theology at Heidelberg, wrote a work on dogmatics, *Typus doctrinae christianæ* (1714).

HOUBRAKEN, JACOBUS (1698-1780), Dutch engraver, was born at Dort, on the 25th of December 1698. All that his father, Arnold Houbraken (1666-1719), bequeathed to him was a fine constitution and a pure love for work. In 1707 he came to reside at Amsterdam, where for years he had to struggle incessantly against difficulties. He commenced the art of engraving by studying the works of Cornelis Cort, Suyderhoef, Edelinck and the Visschers. He devoted himself almost entirely to portraiture. Among his best works are scenes from the comedy of *De Ontdekte Schijndeugd*, executed in his eightieth year, after Cornelis Troost, who was called by his countrymen the Dutch Hogarth. He died on the 14th of November 1780.

See A. Ver Hull, *Jacobus Houbraken et son œuvre* (Amsterdam, 1875), where 120 engraved works are fully described.

HOUDENC (or **HOUDAIN**), **RAOUL DE**, 12th-century French trouvère, takes his name from his native place, generally identified with Houdain (Artois), though there are twelve places bearing the name in one or other of its numerous variants. It has been suggested that he was a monk, but from the scattered hints in his writings it seems more probable that he followed the trade of jongleur and recited his chansons, with small success apparently, in the houses of the great. He was well acquainted with Paris, and probably spent a great part of his life there. His undoubted works are: *Le Songe d'enfer*, *La Voie de paradis*, *Le Roman des des* (pr. by A. Scheler in *Trouvères belges*, New

Series, 1897) and the romance of *Mérougis de Portlesgues*, edited by M. Michelant (1869) and by Dr M. Friedwagner (Halle, 1897). Houdenc was an imitator of Chrétien de Troyes; and Huon de Méry, in his *Tournoi de l'antéchrist* (1226) praises him with Chrétien in words that seem to imply that both were dead. *Mérougis de Portlesgues*, the hero of which perhaps derives his name from Lesgues, the port of Saint Briec in Brittany, is a roman d'aventures loosely attached to the Arthurian cycle.

See Gaston Paris in *Hist. lit. de la France*, xxx. 220-237; W. Zingerle, *Über Raoul de Houdenc und seine Werke* (Erlangen, 1880); and O. Boerner, *Raoul de Houdenc. Eine stilistische Untersuchung* (1885).

HOUDETOT, a French noble family, taking its name from the lordship of Houdetot, between Arques and St Valéry. Louis de Houdetot went with Robert, duke of Normandy, to Palestine in 1034, and the various branches of the family trace descent from Richard I. de Houdetot (fl. 1229), who married Marie de Montfort. Charles Louis de Houdetot received a marquise in 1722, and on his son Claude Constance César, lieutenant-general in the French army, was conferred the hereditary title of count in 1753. His wife (see below) was the Madame de Houdetot of Rousseau's *Confessions*. Their son César Louis Marie François Ange, comte de Houdetot (1749-1825), was governor of Martinique (1803-1809) and lieutenant-general (1814) under the Empire. His son Frédéric Christophe, comte de Houdetot (1778-1859), was director-general of indirect imposts in Prussia after Jena, and prefect of Brussels in 1813. He acquiesced in the Restoration, but had to resign from the service after the Hundred Days. He became a peer of France in 1819, and under the Second Empire he was returned by the department of Calvados to the Corps Législatif. His half-brother, Charles Île-de-France, comte de Houdetot (1789-1866), was wounded at Trafalgar and transferred to the army, in which he served through the Napoleonic wars. He retired at the Restoration, but returned to the service in 1823, and in 1826 became aide-de-camp to the duke of Orleans, becoming lieutenant-general in 1842. He sat in the Chamber of Deputies from 1837 to 1848, when he followed Louis Philippe into exile. A third brother, César François Adolphe, comte de Houdetot (1799-1869), was a well-known writer on military and other subjects.

HOUDETOT, ELISABETH FRANÇOISE SOPHIE DE LA LIVE DE BELLEGARDE, COMTESSE DE (1730-1813), was born in 1730. She married the comte de Houdetot (see above) in 1748. In 1753 she formed with the marquis de Saint Lambert (q.v.) a connexion which lasted till his death. Mme de Houdetot has been made famous by the chapter in Rousseau's *Confessions* in which he describes his unreciprocated passion for her. When questioned on the subject she replied that he had much exaggerated. A view differing considerably from Rousseau's is to be found in the *Mémoires* of Mme d'Épinay, Mme de Houdetot's sister-in-law.

For a discussion of her relations with Rousseau see Saint-Marc-Girardin in the *Revue des deux mondes* (September 1853).

HOUDON, JEAN ANTOINE (1740-1828), French sculptor, was born at Versailles on the 18th of March 1740. At the age of twelve he entered the École royale de Sculpture, and at twenty, having learnt all that he could from Michel Ange Slodtz and Pigalle, he carried off the prix de Rome and left France for Italy, where he spent the next ten years of his life. His brilliant talent, which seems to have been formed by the influence of that world of statues with which Louis XIV. peopled the gardens of Versailles rather than by the lessons of his masters, delighted Pope Clement XIV., who, on seeing the St Bruno executed by Houdon for the church of St Maria degli Angeli, said "he would speak, were it not that the rules of his order impose silence." In Italy Houdon had lived in the presence of that second Renaissance with which the name of Winckelmann is associated, and the direct and simple treatment of the Morpheus which he sent to the Salon of 1771 bore witness to its influence. This work procured him his "agrégation" to the Academy of Painting and Sculpture, of which he was made a full member in 1775. Between these dates Houdon had not been idle; busts of

Catharine II., Diderot and Prince Galitsin were remarked at the Salon of 1773, and at that of 1775 he produced, not only his Morpheus in marble, but busts of Turgot, Gluck (in which the marks of small-pox in the face were reproduced with striking effect) and Sophie Arnould as Iphigenia (now in the Wallace Collection, London), together with his well-known marble relief, "Grive suspendue par les pattes." He took also an active part in the teaching of the academy, and executed for the instruction of his pupils the celebrated Écorché still in use. To every Salon Houdon was a chief contributor; most of the leading men of the day were his sitters; his busts of d'Alembert, Prince Henry of Prussia, Gerbier, Buffon (for Catharine of Russia) and Mirabeau are remarkable portraits; and in 1778, when the news of Rousseau's death reached him, Houdon started at once for Ermenonville, and there took a cast of the dead man's face, from which he produced the grand and life-like head now in the Louvre. In 1779 his bust of Molière, at the Théâtre Français, won universal praise, and the celebrated draped statue of Voltaire, in the vestibule of the same theatre, was exhibited at the Salon of 1781, to which Houdon also sent a statue of Marshal de Tourville, commissioned by the king, and the Diana executed for Catharine II. This work was refused; the jury alleged that a statue of Diana demanded drapery; without drapery, they said, the goddess became a "suivante de Vénus," and not even the proud and frank chastity of the attitude and expression could save the Diana of Houdon (a bronze reproduction of which is in the Louvre) from insult. Three years later he went to America, there to carry out a statue of Washington. With Franklin, whose bust he had recently executed, Houdon left France in 1785, and, staying some time with Washington at Mount Vernon, he modelled the bust, with which he decided to go back to Paris, there to complete the statue destined for the capitol of the State of Virginia. After his return to his native country Houdon executed for the king of Prussia, as a companion to a statue of Summer, La Frileuse, a naïf embodiment of shivering cold, which is one of his best as well as one of his best-known works. The Revolution interrupted the busy flow of commissions, and Houdon took up a half-forgotten project for a statue of St Scholastica. He was immediately denounced to the convention, and his life was only saved by his instant and ingenious adaptation of St Scholastica into an embodiment of Philosophy. Under Napoleon, of whom in 1806 he made a nude statue now at Dijon, Houdon received little employment; he was, however, commissioned to execute the colossal reliefs intended for the decoration of the column of the "Grand Army" at Boulogne (which ultimately found a different destination); he also produced a statue of Cicero for the senate, and various busts, amongst which may be cited those of Marshal Ney, of Josephine and of Napoleon himself, by whom Houdon was rewarded with the legion of honour. He died at Paris on the 16th of July 1828.

See memoir by Émile Délerot and Arsène Legrelle in *Mémoires de la société des sciences morales . . . de Seine-et-Oise*, iv. 49 et seq. (1857); Anatole de Montaigon and Georges Duplessis in *Revue universelle des arts*, i. and ii. (1855-1856); Hermann Dierks, *Houdons Leben und Werke* (Gotha, 1887); Albert Terrade, *Autour de la statue de Jean Houdon* (Versailles, 1892); P. E. Mangant, *Sur une statuette de Voltaire par J. Houdon* (Paris, 1896).

HOUFFALIZE, a small town occupying an elevated position (nearly 1100 ft.) in the extreme south-east of the province of Luxemburg, Belgium, much visited during the summer on account of its fine bracing air. There are the ruins of an old castle, and some remains of the still older abbey of Val Ste Catherine. The parish church dates from the 13th or 14th century. It contains two old black marble tombs to Thierry of Houffalize and Henri his son, the latter killed at Woeringen in 1288. Houffalize is on the eastern Ourthe, and is connected by a steam tramway with Bourcy on the line from Libramont to Bastogne, Spa and Liège. Pop. (1904) 1486.

HOUGHTON, RICHARD MONCKTON MILNES, 1ST BARON (1809-1885), English poet and man of letters, son of Robert Pemberton Milnes, of Fryston Hall, Yorkshire, and the Hon. Henrietta Monckton, daughter of the fourth Lord Galway, was born in London on the 19th of June 1809. He was educated

privately, and entered Trinity College, Cambridge, in 1827. There he was at once drawn into a literary set, and became a member of the famous "Apostles" Club, which then included Tennyson, Hallam, Trench, J. W. Blakesley, afterwards dean of Lincoln, and others. After taking his degree, Milnes travelled abroad, spending some time at Bonn University. Thence he went to Italy and Greece, and published in 1834 a volume of *Memorials of a Tour in some Parts of Greece*, describing his experiences. He returned to London in 1837, and was in that year elected to Parliament as member for Pontefract. His parliamentary career was marked by much strenuous activity. He interested himself particularly in the question of copyright and the conditions of reformatory schools. He left Peel's party over the Corn Law controversy, and was afterwards identified in politics with Palmerston, at whose instance he was made a peer in 1863. His literary career was industrious and cultured, without being exceptionally distinguished. Church matters had always a claim upon him: he wrote a striking tract in 1841, which was praised by Newman; and took part in the discussion about "Essays and Reviews," defending the tractarian position in *One Tract More* (1841). He published two volumes of verse in 1838, *Memorials of Residence upon the Continent* and *Poems of Many Years, Poetry for the People* in 1840 and *Palm Leaves* in 1844. He also wrote a *Life and Letters of Keats* in 1848, the material for which was largely provided by the poet's friend, Charles Armitage Brown. Milnes also contributed largely to the reviews. His poetry is meditative and delicate; some of his ballads were among the most popular of their day, and all his work was marked by refinement. But his chief distinctions were his keen sense of literary merit in others, and the judgment and magnanimity with which he fostered it. He was surrounded by the most brilliant men of his time, many of whom he had been the first to acclaim. His chief title to remembrance rests on the part he played, as a man of influence in society and in moulding public opinion on literary matters, in connexion with his large circle of talented friends. He secured a pension for Tennyson, helped to make Emerson known in Great Britain, and was one of the earliest champions of Swinburne. He helped David Gray and wrote a preface for *The Luggie*. He was, in the old sense of the word, a patron of letters, and one who never abused the privileges of his position. Milnes married in 1851 the Hon. Annabel Crewe (d. 1874). He died at Vichy on the 11th of August 1885, and was buried at Fryston. His son, the second Baron Houghton, was created Earl of Crewe (q.v.) in 1895.

See *The Life, Letters and Friendships of Richard Monckton Milnes, 1st Lord Houghton* (1890), by Sir T. Wemyss Reid.

HOUGHTON-LE-SPRING, an urban district in the Houghton-le-Spring parliamentary division of Durham, England, 6 m. N.E. of the city of Durham. Pop. (1901) 7858. It is well situated at the head of a small valley branching from that of the Wear. St Michael's church is a cruciform Early English and Decorated building, with a picturesque embattled rectory adjoining. Bernard Gilpin, "the Apostle of the North," was rector of this parish from 1556 to 1583, and the founder of the grammar school. The principal public buildings are a town hall, market house and church institute. Houghton Hall is a fine mansion of the late 16th century. In the orchard stands a tomb, that of the puritan Sir Robert Hutton (d. 1680), of whom a curious tradition states that he desired burial beside his war-horse, the body of which was denied interment in consecrated ground. The main road from Durham to Sunderland here passes through a remarkable cutting in the limestone 80 ft. deep. The district affords frequent evidence of ice activity in the glacial period. The town is the centre of a large system of electric tramways. The population is mainly dependent on the neighbouring collieries, but limestone quarrying is carried on to some extent.

HOUND, a dog, now used, except in poetry, only of dogs of the chase, and particularly of the breed used in hunting the fox, the "hound" *par excellence*. Other breeds have a defining word prefixed, e.g. boar-hound, stag-hound, &c. (see DOG). The O. Eng. *hund* is the common Teutonic name for the animal,

cf. Du. *hond*, Ger. *Hund*, &c., and is cognate with Sansk. *वृण*, Gr. *κῶν*, Lat. *canis*, Ir. and Gael. *cu*.

HOUNSLOW, a town in the Brentford parliamentary division of Middlesex, England, 12½ m. W. by S. of St Paul's Cathedral, London, on the District and London & South Western railways. Pop. (1901) 11,377. It has grown into an extensive residential suburb of London. Its situation at the junction of two great roads from the west of England made it an important coaching station, and some 500 coaches formerly passed through it daily. A priory of friars of the Holy Trinity was founded at Hounslow in 1296, and existed till the dissolution of the monasteries. The priory chapel was used as a church till 1830, after which its place was taken by the existing church of the Holy Trinity (1835). Hounslow Heath, west of the town, had, according to the survey of 1546, an area of 4293 acres. It was the site of Roman and British camps, and in the wars of the 17th century was the scene of several important military rendezvous. It was a favourite resort of highwaymen, whose bodies were exposed on gibbets along the road. In 1784 the base-line of the first trigonometrical survey in England was laid down on the heath. In 1793 large cavalry barracks were erected upon it, and it is also the site of extensive powder mills. It began to be enclosed towards the end of the reign of George III. In Osterley Park, N.E. of Hounslow, Sir Thomas Gresham built a mansion in 1577, and this was rebuilt with great magnificence by Francis and Robert Child c. 1770. Hounslow is divided between the parishes of Heston and Isleworth. Pop. of urban district of Heston and Isleworth (1901) 30,863.

HOUR, the twenty-fourth part of a civil day, the twelfth part of a natural day or night, a space of time of sixty minutes' duration. The word is derived through the O. Fr. *ure*, *ore*, *houre*, mod. *heure*, from Lat. *hora*, Gr. *ῥορα*, season, time of day, hour (see CALENDAR).

HOUR ANGLE, the angular distance of a heavenly body from the meridian, as measured around the celestial pole. It is equal to the angle at the pole between the hour circle through the body and the meridian, but is usually expressed in time.

HOUR-GLASS, a device for measuring intervals of time, also known as sand-glass, and as log-glass when used in conjunction with the common log for ascertaining the speed of a ship. It consists of two pear-shaped bulbs of glass, united at their apices and having a minute passage formed between them. A quantity of sand (or occasionally of mercury) is enclosed in the bulbs, and the size of the passage is so proportioned that this sand will completely run through from one bulb to another in the time it is desired to measure—e.g. an hour or a minute. Instruments of this kind, which have no great pretensions to accuracy, were formerly common in churches. In the English House of Commons, as a preliminary to a division, a two-minute sand-glass is still turned, and while the sand is running the "division bells" are set in motion in every part of the building, to give members notice that a division is at hand.

HOURI, the term for a beautiful virgin who awaits the devout Mahomedan in Paradise. The word is the French representative of the Pers. *hūrī*, Arab. *hawrā'*, a black-eyed virgin, from *hawra*, to be black-eyed, like a gazelle.

HOURS, CANONICAL, certain portions of the day set apart by rule (canon) of the church for prayer and devotion. The Jewish custom of praying three times a day, *i.e.* at the third, sixth and ninth hours, was perpetuated in the early Christian Church (Acts ii. 15, iii. 1, x. 9), and to these were added midnight (when Paul and Silas sang in prison), and the beginning of day and of night. Ambrose, Augustine and Hilary commended the example of the psalmist who gave praise "seven times a day" (Ps. cxix. 164). The seventh (Compline, *Completorium*) was added by Benedict. These hours were adopted especially in the monasteries as a part of the canonical life, and spread thence to the cathedral and collegiate chapters.

Since the 6th century the number and order of the hours have been fixed thus: matins, lauds, prime, terce, sext, none, vespers, compline.

Matins theoretically belongs to midnight, but in Italy it is

said about 7 or 8 A.M. and in France often on the preceding evening in accordance with the statement "evening and morning were one day." At matins is said the *Venite* (Pa. xcvi.) and a hymn, followed by a *Nocturna* or night-watch (on Sundays three) which consists of twelve psalms. After the *nocturna* comes a lesson divided into three parts, one biblical and two patristic, and finally the *Te Deum*.

Lauds is proper to sunrise, but is mostly grouped with matins. It consists of four psalms, a canticle, psalms 148-150, a hymn, the Benedictus (Luke i. 68-79) and prayers.

Prime (6 A.M.), *Terce* (9 A.M.), *Sext* (noon) and *None* (3 P.M.) are called the Little Day Hours, are often said together, and are alike in character, consisting of a hymn and some sections of Ps. cxix., followed by a prayer. On Sundays the Athanasian Creed is said at prime.

Vespers or *Evensong* consists of five varying psalms, a hymn, the *Magnificat* (Luke i. 46-55) and prayers. It belongs theoretically to sunset.

Compline, technically 9 P.M., but usually combined with vespers, is a prayer for protection during the darkness. It consists of the general confession, four fixed psalms, a hymn, the *Nunc dimittis* (Luke ii. 29-32), prayers and a Commemoration of the Virgin.

The term "canonical hours" is also used of the time during which English marriages may be solemnized without special licence, *i.e.* between 8 A.M. and 3 P.M.

HOUSE (O. Eng. *hás*, a word common to Teutonic languages, cf. Dut. *huis*, Ger. *Haus*; in Gothic it is only found in *gudhás*, a temple; it may be ultimately connected with the root of "hide," conceal), the dwelling-place of a human being (treated, from the architectural point of view, below), or, in a transferred sense, of an animal, particularly of one whose abode, like that of the beaver, is built by the animal itself, or, like that of the snail, resembles in some fancied way a human dwelling. Apart from the numerous compound uses of the word, denoting the purpose for which a building is employed, such as custom-house, lighthouse, bakehouse, greenhouse and the like, there may be mentioned the particular applications to a chamber of a legislative body, the Houses of Parliament, House of Representatives, &c.; to the upper and lower assemblies of convocation; and to the colleges at a university; the heads of these foundations, known particularly as master, principal, president, provost, rector, &c., are collectively called heads of houses. At English public schools a "house" is the usual unit of the organization. In the "houses" the boys sleep, have their "studies" and their meals, if the school is arranged on the "boarding-house" system. The houses have their representative teams in the school games, but have no place in the educational class-system of the school. It may be noticed that in Scotland the words "house" and "tenement" are used in a way distinct from the English use, "tenement" being applied to the large block containing "houses," portions, *i.e.*, occupied by separate families. "The House" is the name colloquially given to such different institutions as the London Stock Exchange, the House of Commons or Lords and to a workhouse.

In the transferred sense, "house" is used of a family, genealogically considered, and of the audience at a public meeting or entertainment, especially of a theatre. A "house-physician" and "house-surgeon" is a member of the resident medical staff of a hospital. In astrology the twelve divisions into which the heavens are divided, and through which the planets pass, are known as houses, the first being called the "house of life." The word "house," "housing," used of the trappings of a horse, especially of a covering for the back and flanks, attached to the saddle, is of quite distinct origin. In mediæval Latin it appears as *hucia*, *houssia* and *housia* (see Ducange, *Glossarium*. s.v. *houisia*), and comes into English from the O. Fr. *huche*, modern *houisse*. It has been supposed to have been adopted, at the time of the crusades, from the Arabic *yushiah*, a covering.

Architecturally considered, the term "house" is given to a building erected for habitation, in contradistinction to one built for secular or ecclesiastical purposes. The term extends, there-

fore, to a dwelling of any size, from a single-room building to one containing as many rooms as a palace; thus in London some of the largest dwellings are those inhabited by royalty, such as Marlborough House, or others by men of rank, such as Devonshire House, Bridgewater House, Spencer House, &c.; and even those which, formerly built as habitations, have subsequently been devoted to other purposes, such as Somerset House and Burlington House, retain the term. In Paris the larger houses thus named would be called *hôtels*.

So far as the history of domestic architecture is concerned, the earliest houses of which remains have been found are those of the village of Kahun in Egypt, which were built for the workmen employed in the building of the pyramid at Illahun, and deserted on its completion. They varied in size from the habitations of the chief inspectors to the single room of the ordinary labourer, and were built in unburnt brick with open courts in the larger examples, to give light and air to the rooms round. The models found in 1907 at Deir-Rifa opposite Assiut in Upper Egypt, by Flinders Petrie, and assumed by him to be those of "soul-houses," suggest that the early type of building consisted of a hut, to which later a porch or lean-to, with two poles in front, has been added; subsequently, columns replaced the poles, and a flat roof with parapet, suggesting the primitive forms of the Egyptian temple.

The only remains of early houses found in Mesopotamia are those within the precincts of the Temple of Bel, at Nippur, occupied by the king; but beyond the fact that the walls were built in unburnt brick and were sometimes of great thickness, nothing is known.

The houses in Crete would seem to have been small in area, but this was compensated for in height, as the small plaques found in the palace at Cnosus show houses in two or three storeys, with gable roofs and windows subdivided by mullions and transoms, corresponding with those of the 15th to 17th centuries in England. The stone staircase in the palace rising through two storeys shows that even at this early period the houses in towns had floors superposed one above the other; to a certain extent the same extension existed in the later Greek houses found in Delos, in two of which there was clear evidence of wooden staircases leading within to the roof or to an upper storey. The largest series hitherto discovered is that at Priene in Asia Minor, where the remains of some thirty examples were found, varying in dimensions, but all based on the same plan; this consisted of an entrance passage leading to an open court, on the north side of which, and therefore facing south, was an open portico, corresponding to the *prostas* in Vitruvius (vi. 7), and in the rear two large rooms, one of which might be the oecus or sitting-room, and the other the thalamos or chief bedroom. Other rooms round the court were the triclinium, or dining room, and cubicula or bedchambers. The largest of these houses occupied an area measuring 75×30 ft. Those found in Delos, though fewer in number, are of much greater importance, the house in the street of the theatre having twelve rooms exclusive of the entrance passage and the great central court, surrounded on all four sides by a peristyle; in this house the oecus measured 26×18 ft. In a second example the *prostas* consisted of a long gallery, the whole width of the site, which was lighted by windows at each end, the sills of which were raised 8 ft. or 9 ft. from the floor.

The remains of the houses found in the Peiræus are of the same simple plan as those at Priene, and suggest that the Greek house was considered to be the private residence only for the members of the family, and without any provision for entertaining guests as in Rome and Pompeii. From the descriptions given by Vitruvius (ii. 8) it may be gathered that in his time many of the houses in Rome were built in unburnt brick, the walls of which, if properly protected at the top with a course of burnt brick projecting over the face of the brickwork, and coated inside and outside with stucco, were considered to be more lasting than those built in soft stone. Vitruvius refers also to Greek houses thus built, and states that in the house of Mausolus, at Halicarnassus, the walls were of unburnt brick, and the

plastering with which they were covered was so polished that they sparkled like glass. In Rome, however, he points out, such walls ought to be forbidden, as they are not fit to carry an upper storey, unless they are of great thickness, and as upper storeys become necessary in a crowded city such walls would occupy too much space. The houses in Pompeii (*q.v.*) were built in rubble masonry with clay mortar, and their walls were protected at the top by burnt brick courses and their faces with stucco; they were, however, of a second- or third-rate class compared with those in Rome, the magnificence of which is attested in the descriptions given by various writers and substantiated by the remains occasionally found in excavations. Vitruvius refers to upper storeys, which were necessary in consequence of the limited area in Rome, and representations in mosaic floors and in bas-relief sculpture have been found on which two or three storeys are indicated. The plans of many Roman houses are shown on the *Marble Plan*, and they resemble those of Pompeii, but it is probable that the principal reception rooms were on an upper storey, long since destroyed. The house of Livia on the Palatine Hill was in two storeys, and the decoration was of a much finer character than those of Pompeii; this house and the House of the Vestals might be taken as representative of the Roman house in Rome itself. In those built in colder climates, as in England and Germany, account has to be taken of the special provision required for warming the rooms by hypocausts, of which numerous examples have been found, with rich mosaic floors over them.

Of the houses in succeeding centuries, those found in the cities of central Syria, described in the article ARCHITECTURE, are wonderfully perfect, in consequence of their desertion at the time of the Mahomedan invasion in the 7th century. Very little is known of the houses in Europe during the dark ages, owing to the fact that they were generally built in wood, with thatched roofs. The only examples in stone which have been preserved are those in the island of Skellig Michael, Kerry, which were constructed like the beehive tombs at Mycenae with stone courses overlapping inside until they closed in at the top. These houses or cells were rectangular inside and round or oval outside, with a small low door at one end, and an opening above to let the smoke out.

The houses, even in large towns like London, were built mainly in wood, in some cases down to the 17th century; in the country, the smaller houses were constructed with trunks of trees in pairs, one end of the trunk being sunk in the ground, the other bent over and secured by a ridge piece, thus forming a pointed arch, the opening of which was about 11 ft. The pairs were fixed 16 ft. apart, and the space included constituted a bay, any requisite increase in the size of the house being made by doubling or trebling the bays. The roofs were thatched with straw on battens, and sometimes with a collar beam carrying a floor, which constituted an upper storey. The end walls were closed with wooden studs and wattle-and-dab filling. The pairs of trees were known as forks or crucks. Vitruvius (ii. 1) suggests a similar kind of building in ancient times, except that the interlaced twigs were covered with clay, so as to carry off the rain. In Yorkshire there was another type of house, known as a coit, which was a dwelling-house and barn (shippon) united; the latter contained the cow-stalls with loft above, and the former was in two storeys, with a ladder inside the room leading to the upper floor.¹

Passing now to structures of a less ephemeral character, the earliest houses of which there still remain substantial relics are those built in stone (see MANOR HOUSE). The Jew's House at Lincoln, 12th century, is one of the best-known examples, and still preserves its street front in stone, with rich entrance doorway and first-floor windows lighting the principal room, which seems invariably in those early houses to have been on the first floor, the ground floor being used for service and stores (see Plate I. fig. 5). To the 13th century belongs the old Rectory House at West Dean, Sussex, and to the 14th century the

¹ A complete description of these houses will be found in *The Evolution of the English House*, by S. O. Addy.

Parsonage House at Market Deeping, Lincolnshire. The principal examples of the domestic architecture of this early period in the country are castles, manor houses and farm buildings, as town houses occupied sites too valuable to be left untouched; this, however, is not the case in France, and particularly in the south, where streets of early houses are still to be found in good preservation, such as those at Cluny (fig. 1) and Cordes (Tarn), and others at Montferand, Cahors, Figeac, Angers, Provins, Sarlat (fig. 2), St Emilion, Périgueux, Soissons and Beauvais, dating from the 12th to the 14th centuries. One of the most remarkable examples is the Musician's House at Reims (see Plate I., fig. 4), with large windows on the first floor, between which are niches with life-size figures of musicians seated in them. Generally speaking, the ground storeys of these houses, which in many cases were occupied by shops, have been transformed, but occasionally the old shop fronts remain, as in Dinan, Morlaix and other old towns in Brittany. Houses of the first Renaissance of great beauty exist in Orleans, such as the house of Agnes Sorel; and the example in the Market Place illustrated in fig. 3; in Tours, Tristan's house in brick with stone

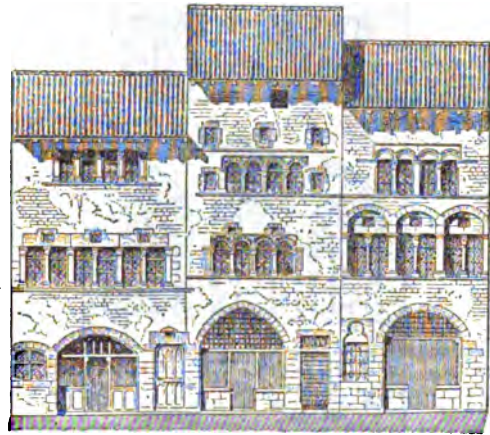

FIG. 1.—Houses at Cluny.

quoins and dressings to windows; in Rouen, Caen, Bayeux, Toulouse, Dijon and, in fact, in almost every town throughout France. Of houses of large dimensions, which in France are termed *hôtels*, there are also many other fine examples, the best known of which are the hôtel de Jacques Cœur (see Plate II., fig. 7), at Bourges, and the hôtel de Cluny at Paris (see Plate I., fig. 6). In the 15th and 16th centuries in France, owing to the value of the sites in towns, the houses rose to many storeys, the upper of which were built in half-timber, sometimes projecting on corbels and richly carved; of these numerous examples exist at Rouen, Beauvais, Bayeux and other towns in Normandy and Brittany. Of such structures in English towns (see Plate II. fig. 9) there are still preserved some examples in York, Southampton, Chester, Shrewsbury, Stratford-on-Avon, and many smaller towns; the greatest development in half-timber houses in England is that which is found more particularly throughout Kent, Sussex and Surrey, in houses of modest dimensions, generally consisting of ground and first floor only, with sometimes additional rooms in the roof; in these the upper storey invariably projects in front of the lower, giving increased dimensions to the rooms in the former, but adopted in order to protect the walls of the ground storey from rain, which in the upper storey was effected by the projecting eaves of the roof. In the north and west of England, where stone could be obtained at less cost than brick, and in the east of England, where brick, often imported from the Low Countries, was largely employed, the ordinary houses were built in those materials,

and in consequence of their excellent construction many houses of the 16th and 17th centuries have remained in good preservation down to the present day; they are found in the Cotswolds generally, and (among small towns) at Broadway in Worcestershire and (of brick) throughout Essex and Suffolk. Among the larger half-timber houses built in the 15th and 16th centuries, mention may be made of Bramhall Hall, near Manchester; Speke Hall, near Liverpool (see Plate III., fig. 10); The Oaks, West Bromwich; and Moreton Old Hall, Cheshire, one of the most elaborate of the series (see Plate III., fig. 11).

On the borders of the Rhine, as at Bacharach and Rhense, and throughout Germany, half-timber houses of the most

Houses with external staircases, but without any architectural pretensions, are found throughout the Balkan provinces.

The introduction of the purer Italian style into England in the 17th century created a great change in domestic architecture. Instead of the projecting wings and otherwise picturesque contour of the earlier work the houses were made square or rectangular on plan, in two or three storeys, crowned with a modillion cornice carrying a roof of red tiles; the only embellishments of the main front were the projecting courses of stone on the quoins and architraves round the windows, and flat pilasters carrying a hood or pediment flanking the entrance doorway. In the larger mansions more thought was bestowed

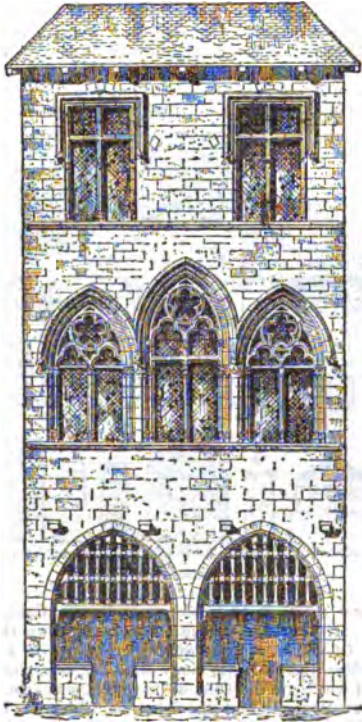

FIG. 2.—House at Sarlat.

picturesque character are found in every town, large and small, those of Hildesheim (see Plate II., fig. 8) dating from the 15th and 16th centuries, and in some cases rising to a great height with four or five storeys, not including those in the lofty roofs. Houses in stone from the 12th to the 16th century are found in Cologne, Metz, Trier, Hanover and Münster in Westphalia, where again there are whole streets remaining; and in brick at Rostock, Stralsund, Lübeck, Greifswald and Dantzic, forming a very remarkable series of 15th and 16th-century work.

Of half-timber work in Italy there are no examples, but sometimes (as at Bologna) the rooms of the upper floors are carried on arcades, and sometimes on corbels, as the casa dei Carracci in the same town. The principal feature of the Italian house is the courtyard in the rear, with arcades on one or more sides, the front in stone or brick, or both combined, being of the greatest simplicity (examples in San Gimignano and Pisa). At Viterbo are small houses in stone, two of which have external stone staircases of fine design, and the few windows on the ground floor suggest that the rooms there were used only for stores.

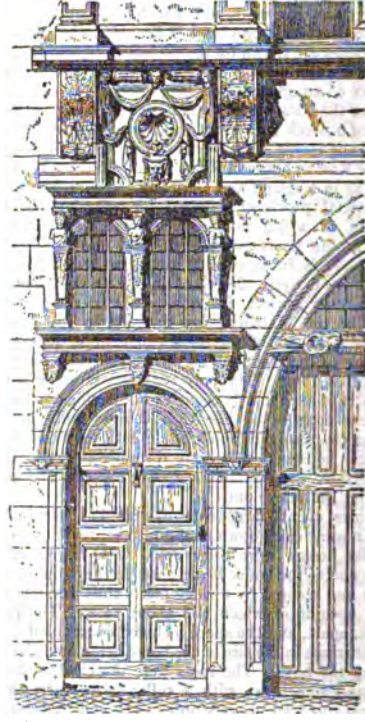

FIG. 3.—Detail of house at Orleans.

on the introduction of porticoes (scarcely necessary in the English climate), with sometimes great flights of steps up to the principal floor, which was raised above a basement with cold and dark passages; a great saloon in the centre of the block, lighted from above, took the place of the great entrance hall of the Tudor period, and the rooms frequently led one out of the other, without an independent entrance door. On the other hand, in the ordinary houses, the deficiency in external ornament was amply made up for by the comfort in the interior and the decoration of the staircase and other rooms. Towards the close of the century the square mullioned and transomed windows, with opening casements, gave way to sash windows, introduced from Holland, and these with moulded and stout sash-bars gave a certain character to the outside of the houses, which are valued now for their quiet unpretentious character and excellent construction. In the closes of many English cathedrals, on the outskirts of London, and in some of the older squares, as Lincoln's Inn Fields and Queen Square, are examples of this style of house. The substitution of thin sash-bars in the 19th century,

and their omission occasionally, in favour of plate-glass, deprived the house-front of one of its chief attractions; but the old English casements and oriels or bow-windows have been again introduced, and a return has been made to the style which prevailed in the beginning of the 18th century, commonly known as that of Queen Anne.

Perhaps in one respect the greatest change which has been made in the English house is the adoption of "flats"; commenced some time in the 'fifties in Ashley Gardens, Westminster, they have spread throughout London. In consequence of the great value of the sites on which they are sometimes built, to which must be added the cost of the houses pulled down to make way for them, the question of expense in material and rich decoration has not always been worth considering, so that frontages in stone, with the classic orders brought in with many varieties of design, have given the character of a palace to a structure in which none of the rooms exceeds the modest height of 10 ft. The increasing demand for these, however, shows that they meet, so far as their accommodation and comfort are concerned, the wants and tastes of the upper and middle classes. In some of the London streets, where shops occupy the ground floor, a far finer type of house has been erected than that which could have been afforded for the shopkeeper's residence above, as in old times, so that London promises in time to become a city of palaces. The same change in the aspects of its streets has long been evident in Paris, but there is one feature in the latter city which has never yet found its way into London, much to the surprise of French visitors, viz. the *porte-cochère*, through which the occupants of the house can in wet weather drive and be landed in a covered hall or vestibule. This requires, of course, a small court at the back, so small that one wonders sometimes how it is possible for the carriage to turn round in it. The *porte-cochère* also, from its dimensions, is a feature of more importance than the ordinary street doorway, even when a portico of some kind is added; on the other hand, the strict regulations in Paris as regards the projection of cornices and other decorative accessories gives to the stranger the appearance of monotony in their design, which certainly cannot be said of the houses in flats lately built in London. Within recent years an old English feature, known as the bow-window, has been introduced into Paris, the primary object of which does not seem yet to have been thoroughly understood by the French architect. An English bow-window, by its slight projection in front of the main wall, increases greatly the amount of light entering the room, and it is generally placed between solid piers of stone or brick. The French architects, however, project their piers on immense corbels, and then sink their windows with deep external reveals, so that no benefit accrues to the room, so far as the increased light is concerned. In Paris, since 1800, there has been a tendency to introduce a style of design in French houses which is known as "*l'art nouveau*," a style which commenced in furniture as a reaction against the revival of the Empire and Louis XIV. and XVI. periods, and was then extended to house fronts; this style has unfortunately spread through the various towns in France and apparently to Germany, again as a reaction against the formal classic style of the latter half of the 19th century. It is probable that in Italy and Spain "*l'art nouveau*" may meet with the same success, and for the same reasons, so that in the latter country it will be a revival, with modifications, of the well-known Churrigueresque style, the most debased Rococo style which has ever existed. In England it has never met with any response. (R. P. S.)

HOUSEHOLD, ROYAL. In all the mediæval monarchies of western Europe the general system of government sprang from, and centred in, the royal household. The sovereign's domestics were his officers of state, and the leading dignitaries of the palace were the principal administrators of the kingdom. The royal household itself had, in its turn, grown out of an earlier and more primitive institution. It took its rise in the *comitatus* described by Tacitus, the chosen band of *comites* or companions who, when the Roman historian wrote, constituted the personal following, in peace as well as in war, of the Teutonic chieftain. In

England before the Conquest the *comitatus* had developed or degenerated into the thegnood, and among the most eminent and powerful of the king's thegns were his diaththegn, his bowerthegn, and his horsethegn or staller. In Normandy at the time of the Conquest a similar arrangement, imitated from the French court, had long been established, and the Norman dukes, like their overlords the kings of France, had their seneschal or steward, their chamberlain and their constable. After the Conquest the ducal household of Normandy was reproduced in the royal household of England; and since, in obedience to the spirit of feudalism, the great offices of the first had been made hereditary, the great offices of the second were made hereditary also, and were thenceforth held by the grantees and their descendants as grand-serjeants of the crown. The consequence was that they passed out of immediate relation to the practical conduct of affairs either in both state and court or in the one or the other of them. The steward and chamberlain of England were superseded in their political functions by the justiciar and treasurer of England, and in their domestic functions by the steward and chamberlain of the household. The marshal of England took the place of the constable of England in the royal palace, and was associated with him in the command of the royal armies. In due course, however, the marshalship as well as the constableness became hereditary, and, although the constable and marshal of England retained their military authority until a comparatively late period, the duties they had successively performed about the palace had been long before transferred to the master of the horse. In these circumstances the holders of the original great offices of state and the household ceased to attend the court except on occasions of extraordinary ceremony, and their representatives either by inheritance or by special appointment have ever since continued to appear at coronations and some other public solemnities, such as the opening of the parliament or trials by the House of Lords.¹

The materials available for a history of the English royal household are somewhat scanty and obscure. The earliest record relating to it is of the reign of Henry II. and is contained in the *Black Book of the Exchequer*. It enumerates the various inmates of the king's palace and the daily allowances made to them at the period at which it was compiled. Hence it affords valuable evidence of the antiquity and relative importance of the court offices to which it refers, notwithstanding that it is silent as to the functions and formal subordination of the persons who filled them.² In addition to this record we have a series of far later, but for the most part equally meagre, documents bearing more or less directly on the constitution of the royal household, and extending, with long intervals, from the reign of Edward III. to the reign of William and Mary.³ Among them, however, are what are known as the *Black Book of the Household* and the *Statutes of Eltham*, the first compiled in the reign of Edward IV. and the second in the reign of Henry VIII., from which a good deal of detailed information may be gathered concerning the arrangements of the court in the 15th and 16th centuries. The *Statutes of Eltham* were meant for the practical guidance merely of those who were responsible for the good order and the sufficient supply of the sovereign's household at the time they were issued.

¹ The great officers of state and the household whom we have particularly mentioned do not of course exhaust the catalogue of them. We have named those only whose representatives are still dignitaries of the court and functionaries of the palace. If the reader consults Hallam (*Middle Ages*, i. 181 seq.), Freeman (*Norman Conquest*, i. 91 seq., and v. 426 seq.) and Stubbs (*Const. Hist.* i. 343, seq.), he will be able himself to fill in the details of the outline we have given above.

² The record in question is entitled *Constitutio Domus Regis de Procuracionibus*, and is printed by Hearne (*Liber Niger Scaccarii*, i. 341 seq.). It is analysed by Stubbs (*Const. Hist.* vol. i. note 2, p. 345).

³ *A Collection of Ordinances and Regulations for the Government of the Royal Household, made in Divers Reigns from King Edward III. to King William and Queen Mary*, printed for the Society of Antiquaries, (London, 1790). See also Pegge's *Curiosa*, published partly before and partly after this volume; and Carlisle's *Gentlemen of the Privy Chamber*, published in 1829. Pegge and Carlisle, however, deal with small and insignificant portions of the royal establishment.

But the *Black Book of the Household*, besides being a sort of treatise on princely magnificence generally, professes to be based on the regulations established for the governance of the court by Edward III., who, it affirms, was "the first setter of certeynties among his domestical meyne, upon a grounded rule" and whose palace it describes as "the house of very policie and floure of England"; and it may therefore possibly, and even probably, take us back to a period much more remote than that at which it was actually put together.¹ Various orders, returns and accounts of the reigns of Elizabeth, James I., Charles I., Charles II., and William and Mary throw considerable light on the organization of particular sections of the royal household in times nearer to our own.² Moreover, there were several parliamentary inquiries into the expenses of the royal household in connexion with the settlement or reform of the civil list during the reigns of George III., George IV. and William IV.³ But they add little or nothing to our knowledge of the subject in what was then its historical as distinguished from its contemporary aspects. So much, indeed, is this the case that, on the accession of Queen Victoria, Chamberlayne's *Present State of England*, which contains a catalogue of the officials at the court of Queen Anne, was described by Lord Melbourne the prime minister as the "only authority" which the advisers of the crown could find for their assistance in determining the appropriate constitution and dimensions of the domestic establishment of a queen regnant.⁴

In its main outlines the existing organization of the royal household is essentially the same as it was under the Tudors or the Plantagenets. It is now, as it was then, divided into three principal departments, at the head of which are severally the lord steward, the lord chamberlain and the master of the horse, and the respective provinces of which may be generally described as "below stairs," "above stairs" and "out of doors." The duties of these officials, and the various officers under their charge are dealt with in the articles under those headings. When the reigning sovereign is a queen, the royal household is in some other respects rather differently arranged from that of a king and a queen consort. When there is a king and a queen consort there is a separate establishment "above stairs" and "out of doors" for the queen consort. She has a lord chamberlain's department of her own, and all the ladies of the court from the mistress of the robes to the maids of honour are in her service. At the commencement of the reign of Queen Victoria the two establishments were combined, and on the whole considerably reduced. On the accession of Edward VII. the civil list was again reconstituted; and while the household of the king and his consort became larger than during the previous reign, there was a tendency towards increased efficiency by abolishing certain offices which were either redundant or unnecessary.

The royal households of such of the continental monarchies of Europe as have had a continuous history from medieval times resemble in general outlines that described above. There are,

¹ *Liber niger domus Regis Edward IV. and Ordinances for the Household made at Eltham in the seventeenth year of King Henry VIII., A.D. 1526*, are the titles of these two documents. The earlier documents printed in the same collection are *Household of King Edward III. in Peace and War from the eighteenth to the twenty-first year of his reign; Ordinances of the Household of King Henry IV. in the thirty-third year of his reign, A.D. 1455, and Articles ordained by King Henry VII. for the Regulation of his Household, A.D. 1494.*

² *The Book of the Household of Queen Elizabeth as it was ordained in the forty-third year of her Reign delivered to our Sovereign Lord King James, &c.*, is simply a list of officers' names and allowances. It seems to have been drawn up under the curious circumstances referred to in *Archæologia* (xii. 80-85). For the rest of these documents see *Ordinances and Regulations, &c.*, pp. 299, 340, 347, 352, 368 and 380.

³ Burke's celebrated Act "for enabling His Majesty to discharge the debt contracted upon the civil list, and for preventing the same from being in arrear for the future, &c.," 22 Geo. III. c. 82, was passed in 1782. But it was foreshadowed in his great speech on "Economic Reform" delivered two years before. Since the beginning of the 19th century select committees of the House of Commons have reported on the civil list and royal household in 1803, 1804, 1815, 1831 and 1901.

⁴ *Torrans's Memoirs of William, second Viscount Melbourne*, ii. 308.

common to many, certain great offices, which have become, in course of time, merely titular and sometimes hereditary. In most cases, as the name of the office would suggest, they were held by those who discharged personal functions about the sovereign. Gradually, in ways or for reasons which might vary in each individual case, the office alone survived, the duties either ceasing to be necessary, or being transferred to officers of less exalted station and permanently attached to the sovereign's household. For example, in Prussia, there are certain great titular officers, such as the Oberstmarshall (great chamberlain); the Oberstjägermeister (grand master of the hunt); the Oberstschenk (grand cup-bearer) and the Oberstruchsess (grand carver), while, at the same time, there are also departments which correspond, to a great extent—both as to offices and their duties—to those of the household of the English sovereigns. This is a feature which must necessarily be reproduced in any monarchical country, whatever the date of its foundation, to a more or less limited extent, and varying in its constitution with the needs or customs of the particular countries.

See also LORD STEWARD; LORD CHAMBERLAIN; MASTER OF THE HORSE; PRIVY PURSE; and CIVIL LIST.

HOUSEL, the English name, until the time of the Reformation, for the Eucharist. The word in O. Eng. was *hæsel*. Its proper meaning is "sacrifice," and thus the word *hæsel* appears in Ulúilas' Gothic version of Matt. ix. 13, "I will have mercy and not sacrifice." The ultimate origin is doubtful. The *New English Dictionary* connects it with a Teutonic stem meaning "holy"; from which is derived the Lithuanian *suostas*, and Lettish *svēts*. Skeat refers it to a root meaning "to kill," which may connect it with Gr. *καίω*.

HOUSELEEK, *Sempervivum*, a genus of ornamental evergreen plants belonging to the natural order *Crasulaceae*. About 30 species are known in gardens, some of which are hardy perennial herbs, and grow well in dry or rocky situations; the others are evergreen shrubs or undershrubs, fit only for cultivation in the greenhouse or conservatory. The genus *Sempervivum* is distinguished from the nearly allied *Sedum* by having more than five (about 12) petals, and by the glands at the base of the ovary being lacinated if present. The common houseleek, *S. tectorum* (Gr. *ἡασυμνῶν*, Fr. *joubarbe*), is often met with in Britain on roofs of outhouses and wall-tops, but is not a native. Originally it was indigenous in the Alps, but it is now widely dispersed in Europe, and has been introduced into America. The leaves are thick, fleshy and succulent, and are arranged in the form of a rosette lying close to the soil. The plant propagates itself by offsets on all sides, so that it forms after a time a dense cushion or aggregation of rosettes. The flowering stem, which is of rather rare occurrence, is about 1 ft. high, reddish, cylindrical and succulent, and ends in a level-topped cyme, reflexed at the circumference, of reddish flowers, which bloom from June to September. The houseleek has been known variously as the houselick, homewort or great houseleek. *Sedum acre* (stone-crop) is styled the little houseleek. In Germany it is sometimes called *Donnerkraut*, from being supposed to protect the house on which it grows from thunder. The leaves are said to contain malic acid in considerable quantity, and have been eaten as salad, like *Portulaca*. *S. glutinosum* and *S. balsemiferum*, natives respectively of Madeira and the Canary Islands, contain a very viscous substance in large quantity, and are used for the preparation of bird-lime; fishermen in Madeira, after dipping their nets in an alkaline solution, rub them with this substance, rendering them as tough as leather. *S. montanum*, indigenous in Central Europe, according to Gmelin, causes violent purging; *S. arborum*, *τὸ πύρα ἀέλωον* of Dioscorides, is employed in Cyprus, the East, and northern Africa as an external remedy for malignant ulcers, inflammations and burns, and internally for mucous discharges.

HOUSING. The housing of the poorer classes has become a pressing problem in all populous Western countries, and has engaged, in a varying but constantly increasing measure, the attention of legislative and administrative bodies and of philanthropic individuals and societies. The general interest was

signalled by an International Congress held in London in 1907. The recognition of the problem is due in the first instance to the science of public health, the rise of which dates from the second quarter of the 19th century; and in the second instance to the growth of urban populations consequent on the development of manufacturing industries and of trading and transporting agencies, both of which tend to mass increasing numbers of people in convenient centres. To have a clear view of the subject it is necessary to distinguish these factors and their respective influence upon the problem. Urban congestion is quite secondary, and only important because and so far as it has a prejudicial effect upon health and strength. Further, the requirements on the scientific side, made on behalf of public health, are of very much wider application and more expansive than those which arise from the mere growth of urban population. That is obvious at once from the fact that they extend to rural housing, which has indeed become a prominent feature of the question in recent years. To ascribe the housing problem to the "factory system," as some writers have done, is to put forward an inadequate and misleading view of it. It is, in fact, particularly acute in some places totally devoid of factories and least acute in some purely factory towns. If the factory system were abolished with all its effects the housing question would remain. But there is a more important distinction than extent of application. The requirements of public health are indeterminate and interminable; knowledge increases, or rather changes, and the standard constantly rises. It is the changing standard which gives most trouble; housing at one period thought good enough is presently condemned. Fifty years ago no house existed which would satisfy modern sanitary standards, and the mansions of the great were in some respects inferior to the worst quarters to-day. And to this process there is no end. It is quite conceivable that urban congestion might cease to be a difficulty at all. That actually happens in particular towns where the population is stationary or diminishing. One whole nation (France) has already reached that point, and others are moving towards it at varying rates. But even where the supply of houses exceeds the demand and many stand empty, the housing problem remains; condemnation of existing accommodation continues and the effort to provide superior houses goes on. In other words, there are two main aspects of the housing question, quality and quantity; they touch at various points and interact, but they are essentially distinct. The problem of quantity may be "solved," that of quality has no finality.

The importance attached to housing is much enhanced by the general tendency to lay stress on the material conditions of life, which characterizes the present age. Among material conditions environment takes a leading place, largely under the influence of the theory of evolution in a popular and probably erroneous form; and among the factors of environment the home assumes a more and more prominent position. There is reason in this, for whatever other provision be made for work or recreation the home is after all the place where people spend most of their time. Life begins there and generally ends there. At the beginning of life the whole time is spent there and home conditions are of paramount importance to the young, whose physical welfare has become the object of increasing care. But the usual tendency to run to extremes has asserted itself. It may be admitted that it is extremely difficult to raise the character and condition of those who live in thoroughly bad home surroundings, and that an indispensable or preliminary step is to improve the dwelling. But if in pursuit of this object other considerations are lost sight of, the result is failure. Bad housing is intimately connected with poverty; it is, indeed, largely a question of poverty now that the difference between good and bad housing is understood and the effects of the latter are recognized. The poorest people live under the worst housing conditions because they are the cheapest; the economic factor governs the situation. Poverty again is associated with bad habits, with dirt, waste, idleness and vice, both as cause and as effect. These factors cannot be separated in real life; they act and react upon each other in such a way that it is impossible

to disentangle their respective shares in producing physical and moral evils. To lay all responsibility upon the structural environment is an error constantly exposed by experience.

Defective quality embraces some or all of the following conditions—darkness, bad air, damp, dirt and dilapidation. Particular insanitary conditions independent of the structure are often associated, namely defects of water-supply, drainage, excrement and house refuse removal, back-yards and surrounding ground; they contribute to dirt, damp and bad air. Defective quantity produces high rents and overcrowding, both of which have a prejudicial effect upon health; the one by diminishing expenditure on other necessities, the other by fouling the atmosphere and promoting the spread of infectious illness. The physical effects of these conditions have been demonstrated by comparative statistics of mortality general and special; among the latter particular stress is laid on the mortality of infants, that from consumption and from "zymotic" diseases. The statistical evidence has been especially directed to the effects of overcrowding, which can be stated with greater precision than other insanitary conditions. It generally takes the form of comparing the death-rates of different areas having widely contrasted densities of population or proportions of persons to a given space. It is not necessary to quote any of these figures, which have been produced in great abundance. They broadly establish a connexion between density and mortality; but the inference that the connexion can be reduced to a precise numerical statement and that the difference of mortality shown is all due to overcrowding or other housing conditions is highly fallacious. Many other factors ought to be taken into account, such as the age-distribution of the population, the birth-rate, the occupations, means, character and habits of the people, the geographical situation, the number of public institutions, hospitals, workhouses, asylums and so forth. The fallacious use of vital statistics for the purpose of proving some particular point has become so common that it is necessary to enter a warning against them; the subject of housing is a popular field for the exercise of that art, though there is no need of it.

The actual state of housing in different countries and localities, the efforts made to deal with it by various agencies, the subsidiary points which arise in connexion with it and the results attained—all these heads embrace such a vast mass of facts that any attempt to treat them fully in detail would run to inordinate length. It must suffice to review the more salient points; and the most convenient way of doing so is to deal first with Great Britain, which has led the way historically in extent of need, in its recognition and in efforts to meet it, adding some notes upon other countries, in which the question is of more recent date and for which less information is available.

THE UNITED KINGDOM

The importance of housing and the need of improvement had by 1909 received public recognition in England for nearly 70 years, a period coinciding almost exactly with the systematic study of sanitation or public health. The active movement definitely began about 1841 with voluntary effort in which Lord Shaftesbury was the most prominent and active figure. The motive was philanthropic and the object was to improve the condition of the working classes. It took the form of societies; one was the "Metropolitan Association for Improving the Dwellings of the Industrial Classes," incorporated in 1845 but founded in 1841; another was the "Society for Improving the Condition of the Labouring Classes," originally the "Labourers' Friend Society," of which the Prince Consort became president. That fact and the statement of the Society concerning improved housing that "the moral were almost equal to the physical benefits," sufficiently prove that public interest in the subject and a grasp of its significance already existed at that date. Legislation followed not long after and has continued at intervals ever since.

Legislation.—Twenty-eight Housing and Health Acts, passed between 1851 and 1903, are enumerated by Mr Dewenup, whose monograph on *The Housing Problem in England* is the fullest account

of the subject published. The first was the Shaftesbury Act of 1851 for the establishment of lodging-houses for the working classes; the last was the Housing of the Working Classes Act of 1903. The Shaftesbury Act had in view the provision by local authorities of good lodging-houses for the better class of artisans, and particularly of single persons, male and female, though families were also contemplated. It was accompanied in the same year by another act, not included in the list of twenty-eight, for the regulation and control of common lodging-houses, from which Mr Dewson reasonably infers that the object of Lord Shaftesbury, who inspired both acts, was the separation of the casual and disorderly class frequenting common lodging-houses from the more regularly employed and respectable workers who were sometimes driven to use them for lack of other accommodation. At any rate this early legislation embodied the principle of differential treatment and showed a grasp of the problem not always visible in later procedure. The most important of the subsequent acts were those of 1855 and 1866, both intended to encourage private enterprise in the provision of working-class dwellings; the Torrens Act of 1868 (Artisans' and Labourers' Dwellings Act) for the improvement or demolition of existing buildings; the Cross Act of 1875 (Artisans' and Labourers' Dwellings Improvement Act), for extending that process to larger areas; the Public Health Act of 1875; the Housing of the Working Classes Act of 1885 following the report of the Royal Commission on the Housing of the Working Classes, of which King Edward, then prince of Wales, was a member; the Housing of the Working Classes Act of 1890; the Public Health (London) Act of 1891. The acts of 1875 (Public Health), of 1890 and of 1891 are still in force. The story of this half-century of legislation (which also includes a number of Scotch and Irish acts, local private acts and others bearing on the question) is one of tentative efforts first in one direction then in another, of laws passed, amended, extended, consolidated, superseded. Many of the enactments, originally of limited application, were subsequently extended, and the principal laws now in force apply to the whole of the United Kingdom. Two main objects can be distinguished—(1) the treatment of existing dwellings by demolition or improvement; (2) the construction of new ones. The second head is further subdivided into (a) municipal action, (b) private action. These objects have been alternately promoted by legislative measures conceived and carried out on no systematic plan, but gradually and continuously developed into an effective body of law, particularly with regard to the means of dealing with existing insanitary dwellings. The advancing requirements of public health are clearly traceable in the series of enactments directed to that end. The Nuisances Removal Act of 1855 took cognizance of premises in such a state as to be "a nuisance or injurious to health," and made provision for obtaining an order to prohibit the use of such premises for human habitation. In the same act overcrowding obtained statutory recognition as a condition dangerous or prejudicial to health, and provision was made for compelling its abatement. The campaign against bad housing conditions thus inaugurated by the legislature was extended by subsequent acts in 1860, 1866 and 1868, culminating in the Cross Act of 1875 for the demolition (and reconstruction) of large insanitary areas and the extremely important Public Health Act of the same year. The constructive policy, begun still earlier in 1851 by Lord Shaftesbury's Act, was concurrently pursued, and for some years more actively than the destructive; but after 1866 the latter became more prominent, and though the other was not lost sight of it fell into the background until revived by the Royal Commission of 1885 and the housing legislation which followed, particularly the Housing of the Working Classes Act of 1890, amending and consolidating previous acts.

The laws in operation at the beginning of 1900 were the Public Health Acts of 1875 and 1891 (London), as amended by subsequent minor measures, and the Housing of the Working Classes Act of 1890, amended in 1894, 1900 and 1903. The Public Health Acts place upon the local sanitary authority the obligation of securing, under by-laws, the proper construction, draining and cleaning of streets, removal of house refuse and building of houses, including structural details for the prevention of damp and decay, the provision of sanitary conveniences and an adequate water-supply; also of inquiring into and removing nuisances, which include any premises in such a condition as to be a nuisance or injurious to health and any house so overcrowded as to be dangerous or injurious to health. For the purpose of carrying out these duties the local authority has the power of inspection, of declaring a building unfit for human habitation and of closing it by order. The Housing Acts give more extended power to the local authority to demolish insanitary dwellings and clear whole areas or "slums," and also to construct dwellings for the working classes with or without such clearance; they also retain the older provisions for encouraging private enterprise in the erection of superior dwellings for

the working classes. The procedure for dealing with insanitary property under these Acts is too intricate to be stated in detail; but, briefly, there are two ways of proceeding. In the first the local authority, on receiving formal complaint of an unhealthy area, cause an inspection to be made by their medical officer, and if the report in their opinion justifies action, they may prepare an "improvement scheme," which is submitted to the Local Government Board. The Board holds an inquiry, and, if satisfied, issues a provisional order, which has to be confirmed by a special act of parliament, under which the local authority can proceed to demolish the houses concerned after paying compensation to the owners. This procedure, which is authorized by part i. of the act of 1890, is obviously both cumbersome and costly. The second way, provided for by part ii. of the act, is much simpler and less ambitious; it only applies to single houses or groups of houses. The medical officer in the course of his duty reports to the local authority any houses which are in his opinion unfit for human habitation; the local authority can then make an order to serve notices on the owners to repair the houses at their own expense. Failing compliance on the part of the owners, an order for closing the houses can be obtained; and if nothing is done at the end of three months an order for demolition can be made. Buildings injurious by reason of their obstructive character (e.g. houses built back to back so as to be without through ventilation and commonly called "back-to-back" houses) can be dealt with in a similar manner. Small areas containing groups of objectionable houses of either kind may be made the subject of an improvement scheme, as above. Where areas are dealt with under improvement schemes there is a certain obligation to re-house the persons displaced. Building schemes are provided for under part iii. of the act. Land may be compulsorily purchased for the purpose and the money required may be raised by loans under certain conditions. The provisions thus summarized were considerably modified by the "Housing, Town Planning, &c., Act," passed at the end of 1909. It rendered obligatory the adoption (previously permissive) of the housing provisions (part iii.) of the act of 1890 by local authorities, simplified the procedure for the compulsory purchase of land required for the purpose and extended the facilities for obtaining loans. It further gave power to the Local Government Board to compel local authorities to put in force the act of 1890 in regard both to existing insanitary housing and the provision of new housing. Power was also given to county councils to act in default of rural district councils in regard to new housing. The procedure for dealing with insanitary houses by closing and demolition under part ii. (see above) was rendered more stringent. The general intention of the new act was partly to facilitate the administration of the previous one by local authorities and partly to provide means of compelling supine authorities to take action. Its town-planning provisions are noted below.

Effects of Legislation.—The efficacy of laws depends very largely on their administration; and when they are permissive and dependent on the energy and discretion of local bodies their administration varies greatly in different localities. That has been the case with the British housing and health laws, and is one cause of dissatisfaction with them. But in the aggregate they have effected very great improvement. Public action has chiefly taken effect in sanitary reform, which includes the removal of the worst housing, through demolition or alteration, and general sanitary improvements of various kinds. In some large towns the worst parts have been transformed, masses of old, narrow, crowded, dilapidated and filthy streets and courts have been swept away at one blow or by degrees; other parts have been reconstructed or improved. The extent to which this has been accomplished is not generally recognized. It is not easily demonstrated, and to realize it local knowledge, observation and memory are needed. The details of the story are hidden away in local annals and official reports, and writers on the subject are usually more concerned with what has not than with what has been done. Both the Public Health and the Housing Acts have had a share in the improvement effected.

HOUSE

PLATE I



Photo, Neurdein.

Fig. 4.—Musician's House, Reims.



Photo, F. Frith & Co.

Fig. 5.—Jew's House, Lincoln.



Photo, Neurdein.

Fig. 6.—Hôtel de Cluny, Paris.



Photo, Neurdein.

Fig. 7.—Hôtel de Jacques Cœur, Bourges. Façade.



Fig. 8.—Half-Timbered House at Hildesheim.



Photo, F. Frith & Co.

Fig. 9.—House of John Harvard's Mother, Stratford-on-Avon.



Photo, F. Frith & Co.

Fig. 10.—Speke Hall, Near Liverpool.



Photo, F. Frith & Co.

Fig. 11.—Moreton Old Hall, Near Congleton, Cheshire.



From Garner and Stratton, *Domestic Architecture of England during the Tudor Period*, 1910. By permission of B. T. Batsford.

Fig. 12.—South Court of Sutton Place, Surrey, 1525.



From Gotch, *Architecture of the Renaissance in England*, 1894. By permission of B. T. Batsford.

Fig. 13.—Moyns Park, Essex, 1580.



From Belcher and Macartney, *Later Renaissance Architecture in England*, 1901. By permission of B. T. Batsford.

Fig. 14.—Ham House, Petersham, 1610.



From Gotch, *Architecture of the Renaissance in England*, 1894. By permission of B. T. Batford.

Fig. 15.—Bramshill, Hampshire, 1612.

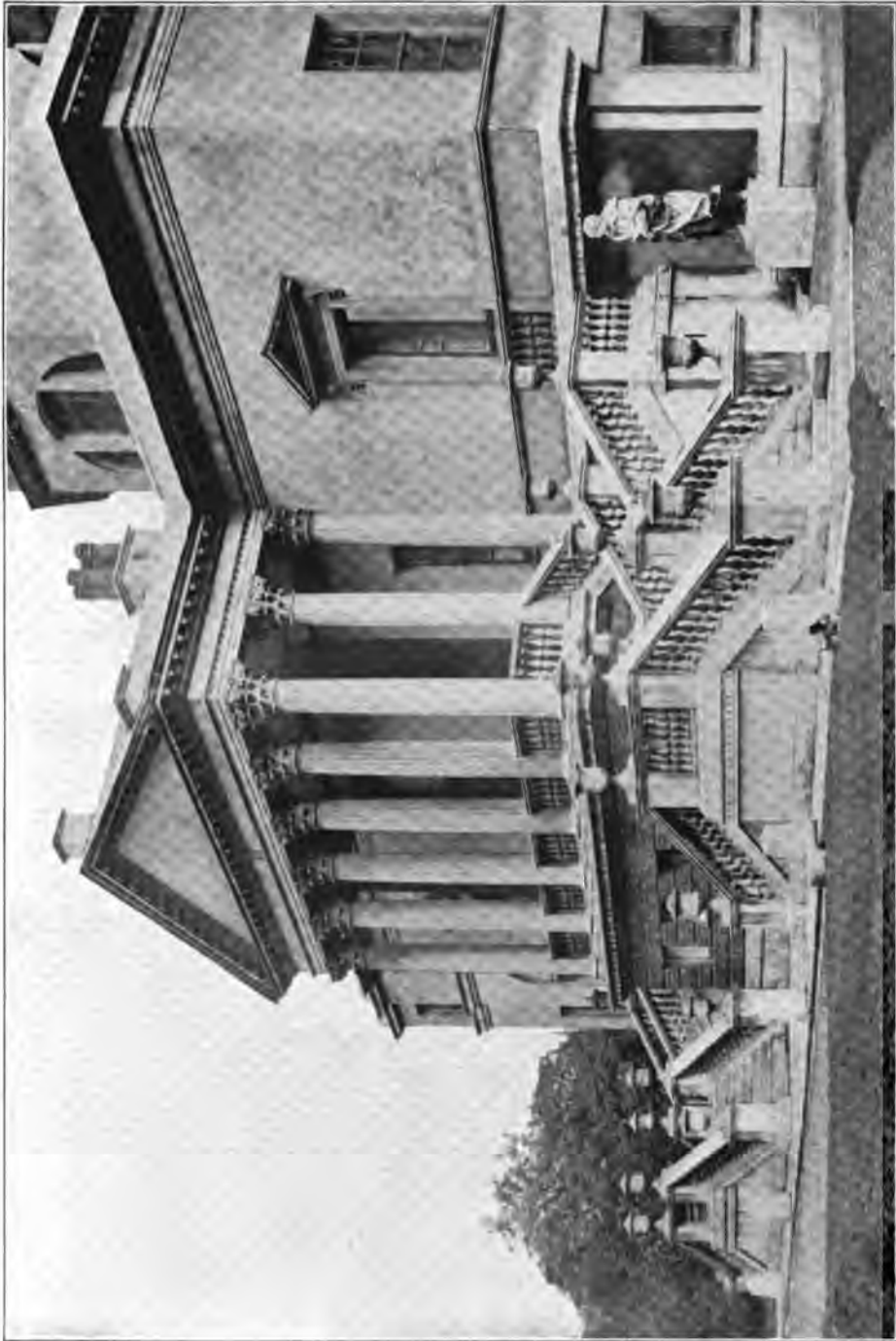

From Belcher and Macartney, *Later Renaissance Architecture in England*, 1901. By permission of B. T. Batsford.
Fig. 16.—The Earl of Burlington's Villa, Chiswick. Eighteenth Century.



From Becher and Macartyney, *Later Renaissance Architecture in England*, 1901. By permission of B. T. Batford.
Fig. 17.—Houses in Cavendish Square, London. Eighteenth Century.

The operation of the former is slow and gradual, but it is continuous and far more general than that of the latter. It embraces many details which are not usually taken into account in discussing housing, but which have as much bearing on the healthiness of the home as the structure itself. The Public Health Acts have further had a certain preventive influence in laying down a standard for the erection of new houses by the ordinary commercial agencies. Such houses are not ideal, because the commercial builder studies economy and the question of rent, but the standard has risen, and building plans involving insufficient light and air, such as once were general, have now for several years been forbidden almost everywhere. Supervision of commercial building is, in fact, vastly more important than the erection of dwellings by public or philanthropic agencies, because it affects a vastly larger proportion of the population. The influence of the Public Health Acts in improving the conditions of home life cannot be estimated or summarized, but it is reflected in the general death-rate, which fell steadily in the United Kingdom from 21.1 per 1000 in 1878 to 15.4 per 1000 in 1907.

Insanitary Areas.—The operation of the Housing Acts is more susceptible of being stated in figures, though no fully comprehensive information is available. The original Shaftesbury Act of 1851 for erecting municipal lodging-houses appears to have been practically inoperative and little or nothing was done for a good many years. In 1864, however, Liverpool obtained a private act and entered on the policy of improvement by the demolition of insanitary dwellings on a considerable scale, following it up in 1869 by re-housing. In 1866 Glasgow, also under a private act, created an Improvement Trust, administered by the city council, and embarked on a large scheme of improvement. These seem to have been the earliest examples. The Torrens Act of 1868, which embodied the improvement policy, did not produce much effect. According to a parliamentary return, during the years 1863-1868, proceedings were only taken under this act in respect of about 2000 houses in London and four provincial towns. More advantage was taken of the Cross Act of 1875, which was intended to promote large improvement schemes. Between 1875 and 1885 23 schemes involving a total area of 31 acres and a population of about 30,000 were undertaken, in London; and 11 schemes in provincial towns. By far the most important of these, and the largest single scheme ever undertaken, was one carried out in Birmingham. It affected an area of 93 acres and involved a net cost of £550,000. Altogether between £4,000,000 and £5,000,000 were raised for improvement schemes under those acts. After the Housing Act of 1890 the clearance policy was continued in London and extended in the provinces. During the period 1891-1905 loans to the amount of about £2,300,000 were raised for improvement schemes by 28 provincial towns in England and Wales. The largest of these were Leeds (£923,000), Manchester (£285,000), Liverpool (£178,000), Sheffield (£131,000), Brighton (£112,000). The Leeds scheme affected an area of 75 acres, which was cleared at a cost of £500,000. In London the area cleared was raised to a total of 104 acres; the gross cost, down to March 31, 1908, was £3,417,337, the net cost £2,434,096, and the number of persons displaced 48,525. Glasgow has under its Improvement Trust cleared an area of 88 acres with a population of 51,000. At the same time the policy of dealing with houses unfit for habitation singly or in small groups by compelling owners to improve them has been pursued by a certain number of local authorities. In the six years 1899-1904 action was taken each year on the average in respect of about 5000 houses by some 400 local authorities large and small outside London. Representations were made against 33,746 houses, 17,210 were rendered fit for habitation, closing orders were obtained against 4220 and demolition orders against 748. These figures do not include cases in which action was taken under local acts and Public Health Acts. In Manchester, between 1885 and 1905, nearly 10,000 "back-to-back" houses were closed and about half of them reopened after reconstruction. Hull, an old seaport town with a great deal of extremely bad housing, has made very effective use of the method of gradual improvement and has transformed its worst areas without appearing in any list of improvement schemes. In recent years this procedure has been systematically taken up in Birmingham and other places, and has been strongly advocated by Mr. J. S. Nettlefold (*Practical Housing*) in preference to large improvement schemes on account of the excessive expense involved by the latter in buying up insanitary areas. In the six years 1902-1907 Birmingham dealt with 4111 houses represented as unfit for habitation; 1780 were thoroughly repaired, 1005 were demolished; the rest were under notice or in course of repair at the end of the period. Among other towns which have adopted this policy are Liverpool, Cardiff, York, Warrington and two London boroughs.

Building.—On the constructive side the operation of the Housing Acts has been less extensive and much less general. In London

alone has the erection of working-class dwellings by municipal action and organized private enterprise assumed large proportions. Philanthropic societies were first in the field and date from a period anterior to legislation, which however, stimulated their activity for many years by affording facilities. Fourteen organizations were in operation in London prior to 1890 and some of them on a large scale; others have since been formed. The earliest was the Metropolitan Association for Improving the Dwellings of the Industrial Classes, whose operations date from 1847; it has built 1441 tenements containing 5105 rooms. The largest of these enterprises are the Improved Industrial Dwellings Company (1864), which has built 5421 tenements containing 19,945 rooms; the Peabody Fund (1864) with 5460 tenements containing 12,328 rooms; the Artisans', Labourers' and General Dwellings Company (1867), with 1467 tenements containing 3495 rooms, and 6195 cottage dwellings; the East-End Dwellings Company (1885) with 2096 tenements containing 4276 rooms; the Guinness Trust (1889) with 2574 tenements containing 5338 rooms. The Artisans' Dwellings Company alone has housed upwards of 50,000 persons. In addition to these there are the Rowton Houses (1892), which are hotels for working men, six in number, accommodating 5162 persons. So far as can be estimated, private enterprise has housed some 150,000 persons in improved dwellings in London on a commercial basis. The early activity of the building companies was largely due to the policy of the Metropolitan Board of Works, which adopted extensive improvement schemes and sold the cleared sites to the companies, who carried out the re-housing obligations imposed by the law. Since the London County Council, which replaced the Board of Works in 1889, adopted the policy of undertaking its own re-housing, their activity has greatly diminished. The buildings erected by them are nearly all in the form of blocks of tenements; the Artisans' Dwellings Company, which has built small houses and shops in outlying parts of London, is an exception. The tenement blocks are scattered about London in many quarters. For instance the Peabody Fund has 18 sets of dwellings in different situations, the Metropolitan Association has 14; the Artisans' Dwellings Company has 10; the Guinness Trust has 8. In 1909 an important addition to the list of philanthropic enterprises in London was put in hand under the will of Mr. W. R. Sutton, who left nearly £2,000,000 for the purpose of providing improved working-class dwellings. The erection of tenement blocks containing accommodation for 300 families was begun on a site in the City Road. In only a few provincial towns has private enterprise contributed to improved housing in a similar manner and that not upon a large scale; among them are Newcastle, Leeds, Hull, Salford and Dublin.

Municipal Building has been more generally adopted. The following details are taken from Mr. W. Thompson's *Housing up to Date*, which gives comprehensive information down to the end of 1906. The number of local authorities which had then availed themselves of part iii. of the Housing Act of 1890, which provides for the erection of working-class dwellings, was 142. They were the London County Council, 12 Metropolitan Boroughs, 69 County Boroughs and Town Councils, 49 Urban District Councils and 12 Rural District Councils. The dwellings erected are classified as lodging-houses, block dwellings, tenement houses, cottage flats and cottages. Lodging-houses have been built by 12 towns, of which 8 are in England, 3 in Scotland (Glasgow, Aberdeen and Leith) and 1 in Ireland (Belfast). The total number of beds provided was 6218, of which Glasgow accounts for 2414, London for 1846, Manchester and Salford together for 648. Four other towns have built or are building municipal lodging-houses for which no details are available. The other municipal dwellings erected are summarized as follows:—

Kind of Dwelling.	No. of Dwellings.	No. of Rooms.
Blocks	12,165	27,523
Tenement Houses	2,507	6,068
Cottage flats	2,004	5,747
Cottages	3,830	17,611
Total	20,506	56,949

It appears from these figures that municipal building has provided for a smaller number of persons in the whole of the United Kingdom than private enterprise in London alone. The principal towns which have erected dwellings in blocks are London (7786), Glasgow (2300), Edinburgh (596), Liverpool (501), Dublin (460) and Manchester (420). The great majority of such dwellings contain either two or three rooms. Tenement houses have been built in Liverpool (1424), Manchester (308), Sheffield (192), Aberdeen (128), and in seven other towns on a small scale. Such tenements are generally somewhat larger than those built in blocks; the proportion of three- and four-roomed dwellings is higher and only a small number consist of a single room. Cottage flats have been built in Dublin (528) West Ham (401), Battersea (320), Plymouth (238), East Ham (212) and on a small scale in Liverpool, Birmingham, Newcastle and seven other places. The majority of the cottage flats contain three or more rooms, a considerable proportion have four rooms. Cottages

have been built in 67 places, chiefly small towns and suburban districts. Of the large towns which have adopted this class of dwellings Salford stands first with 633 cottages; three London boroughs, all on the south side of the Thames, have built 234; Manchester has 228, Sheffield 173, Huddersfield 157, Birmingham 103. The number of rooms in municipal cottages ranges from three to eight, but the great majority of these dwellings have four or five rooms.

Some further details of municipal housing in particular towns are of interest. In London, the work of the London County Council down to March 31, 1908, not including three lodging-homes containing 1845 cubicles, is given in the official volume of London Statistics, published by the Council, as follows:—

Buildings Erected and in Course of Erection.

No. of Dwellings.	No. of Rooms.	Cost of Land and Building.	No. of Persons in Occupation.
8,373	22,939	£2,438,263	26,687

With regard to the cost, it is to be noted that the actual cost of the land purchased for improvement schemes was very much greater than that stated, having been written down to an arbitrary figure called "housing valuation." The financial accounts of L.C.C. dwellings for the year ending March 31, 1908, are thus summarized:—

London County Council Dwellings, Accounts 1907-1908.

Gross Rental.	Deductions for Empties, &c.	Net Receipts.	Expenditure including Interest.	Net Returns.
£180,169	£19,455	£160,714	£157,141	£3,573

It appears from this that if the actual commercial cost of the land were taken the housing of the Council would be run at a considerable annual loss. The occupations of the tenants are stated in the following proportions: labourers 789, clerks 312, policemen 251, shop assistants 202, warehousemen 183, printers 182, charwomen 182, tailors 155, cabinetmakers 146, canvassers 122, cigarette makers 118, widows 116, tram drivers 110, postmen 107, packers 97, engineers 87, dressmakers 41, coachmen 31, motormen 26, milliners 19. These proportional figures show that though a considerable number of labourers have been housed, the great majority of the occupants of London municipal dwellings are of a superior class. The mean weekly rent in London County Council dwellings is 2s. 10½d. per room against 2s. 4d. in dwellings erected by other agencies. The most important feature of the County Council's policy in recent years has been the acquisition of suburban sites for the erection of cottages. There are four such sites, two on the south, one on the north and one on the west side of London; the total area is 349 acres, and the total accommodation contemplated is for 66,000 persons at an estimated cost of £3,105,840; the present accommodation is for about 8000. In addition to the housing provided by the County Council, fourteen London Borough Councils and the City Corporation had at the beginning of 1909 erected or adapted 3136 dwellings containing 7999 rooms.

In Liverpool, down to 1907, about £920,000 had been spent in clearing insanitary areas and building new dwellings; the demolition of about 8000 houses and purchase of land cost about £500,000; and the erection of 2046 dwellings, containing 4961 rooms, cost about £350,000. The size of the dwellings and the number of each class are: 1 room, 193; 2 rooms, 965; 3 rooms, 719; 4 rooms, 167. The great majority are in tenement houses of three storeys. The mean weekly rent is 1s. 6½d. per room, but a large number are let at less. The net return on the total outlay is just over 1% on the building outlay it is 2½%. The principal classes of persons occupying the dwellings are labourers 675, carters 120, charwomen 105, firemen 93, porters 80, hawkers 64, sailors 45, scavengers 40. These all belong to the poorest classes, living by casual or irregular work. Liverpool has, in fact, succeeded more than any other town in providing municipal dwellings in which the really poor can afford to live.

In Manchester 956 dwellings have been built at a total cost for building and improvement of £451,932; of the whole number 420 are in blocks, 308 in tenement houses and 228 in cottages. The rents are much higher than in Liverpool; in the tenement houses the mean weekly rent is about 6d. per room more than in Liverpool. The gross profit on the block dwellings is 1½% on the capital outlay, on the tenement houses 3% on the cottages 2½%. The total loss during the last seven to ten years, including loan charges, has amounted to about £54,240 (Thompson).

In Glasgow the corporation has built under improvement schemes 2280 new dwellings containing 4013 rooms and 241 shops. The dwellings, which are all in blocks and centrally situated, are occupied chiefly by artisans; only 28% have been reserved for the poorest class of tenants. The total amount taken from the rates on this account in 30 years is £600,000. Dwellings valued at £400,000 for

building and £300,000 for land give a net return of 3.06% on outlay; dwellings valued at £280,000 for land and building return 3.03% on outlay; leaving the sinking fund charges to be defrayed out of rates.

In Edinburgh insanitary areas have been bought for £107,023 and new dwellings containing 1032 rooms have been built for £87,970. Nearly all the dwellings are of one or two rooms only. The rents charged average about 2s. a week per room; actual rents received average 1s. 4d. per room and they have to be subsidized out of the rates to the extent of 2s. 3d. per room to meet the cost of site.

In Dublin provision has been or was in 1909 shortly to be made for housing 5304 families or 19,000 persons; of which 1041 families, or about one-fifth, are housed by the Corporation, the rest by companies and private persons. Altogether it was estimated that £500,000 would be spent under the act of 1890. Fifteen streets, containing 1665 houses, have been declared unhealthy areas by the medical officer, and between 1879 and 1909 more than 3000 houses were closed as unfit for habitation.

Co-operative Building.—Municipal and philanthropic housing by no means exhaust the efforts that have been made to provide working-class dwellings outside the ordinary building market. Their special function has been to substitute better dwellings for pre-existing bad ones, which is the most costly and difficult, as well as the most urgent, part of the problem in old towns. But in the provision of new dwellings alone they have been far surpassed by organized self-help in different forms. Down to 1906 there had been built 46,707 houses by 413 co-operative societies at a cost of nearly £10,000,000. They are most numerous in the manufacturing towns and particularly in the north-western district of England. Of the whole number 8530 were owned by the societies which built them; 5777 had been sold to members, and 3260 had been built by members on money lent by the societies. These figures do not include the particular form of co-operative building known as co-partnership housing, which will be mentioned later on, or the operations of the so-called building societies, which are really companies lending money to persons on mortgage for the purpose of building. The difference between them and the co-operative societies which do the same thing is that the latter retain the element of co-operation by lending only to their own members, whereas the building societies deal in the open market. Their operations are on an immense scale; at the end of 1908 the invested funds of the registered building societies exceeded £72,000,000. An agency working on this scale, which far exceeds the operations of all the others put together, is obviously an important factor in housing. The number of houses built must help to relieve congestion, and since they are built to suit the owners or tenants they cannot be of the worst class. They also represent a form of thrift, and deserve notice on that account.

The Small Dwellings Acquisition Act of 1899, which has not previously been mentioned, was intended to facilitate the building or purchase of small houses by their tenants by means of loans advanced by local authorities. Down to 1906 about £82,000 had been so advanced by 5 county boroughs, 17 urban councils and 1 rural district council.

Housing by Employers.—No comprehensive information is available on this head, but it has not been an important factor in towns, being chiefly confined to agricultural, mining and suburban manufacturing districts. The former two belong to the subject of Rural Housing, which is separately discussed below; the third has an interest of its own on account of its connexion with "model settlements." The building of houses for their workpeople by industrial employers has never been widely adopted in this country, but it has attracted considerable attention at two different periods. Sir Titus Salt was a pioneer in this direction, when he built his woolen mills at Saltaire, on the outskirts of Bradford, and housed his workpeople on the spot. That plan was maintained by his successors, who still own some 900 excellent and cheap cottages, and was adopted by a few other manufacturers in the same neighbourhood. Saltaire was a model settlement with many institutions for the benefit of the mill-hands, and as such it attracted much attention; but the example was not generally followed, and the interest lapsed. Recently it has been revived by the model settlements at Port Sunlight, near Liverpool, started about 1888, Bournville near Birmingham (1895), and Earswick, near York (1904), which are of a much more elaborate character. Elsewhere, employers setting down works in some new locality where no provision existed, have had to build houses for their workmen; but they have done so in a plain way, and this sort of housing has not assumed large proportions.

Conditions in 1909.—It has been said above that great improvements have been effected, and of that there is no doubt at all. Both quantity and quality are more satisfactory than they were, though both are still defective. The conditions vary greatly in different places, and no general indictment can be sustained. The common practice of citing some exceptionally bad cases, and by tacit inference generalizing from them to the whole country, is in nothing more misleading than in the matter of housing. Local differences are due to several causes—age,

population, occupations and means of the people, public opinion and municipal energy. The first three chiefly determine the difficulty and extent of the problem, the last two influence its treatment. The difficulty is greatest in towns which are old, have large populations and a high percentage of poor. Such pre-eminently are the large seaports, where much casual labour is employed. London, Liverpool, Glasgow, the Tyne, Hull, Sunderland are examples. Old inland towns having a large trading as well as an industrial element present the same features. Such are Manchester, Birmingham, Leeds, Sheffield and Bradford. In all these, and some others like them, the past has left a heavy legacy of bad housing by malconstruction and dilapidation, which has been increased by growth of population and overcrowding. They have attacked it with varying degrees of energy according to the prevalent local spirit and with varying results.

Overcrowding.—The one condition which permits of precise and comprehensive statement is overcrowding. A standard has been officially adopted in England based on the number of persons to a room in each dwelling; and the facts in relation to this standard are embodied in the census returns. It is a much better criterion than that of "density" or number of persons per acre, which is very deceptive; for an apparently low density may conceal much overcrowding within walls and an apparently high one may be comparatively guiltless. The room-density is the important thing in actual life. Some light is also thrown on this question by the number of rooms contained in each dwelling, and that is also given in the census. The standard of overcrowding is more than two persons to a room. In 1901 there were in England and Wales 2,667,506 persons or 8.2% of the population living in a state of overcrowding according to this definition. Their distribution is extremely irregular and capricious. In rural districts the proportion was only 5.8%, in urban districts 8.9%; but these summary figures give no idea of the actual state of things in different localities. In both rural districts and in towns the proportion of overcrowding varies in different localities from less than 1% to over 30% of the population. The towns are the most important and we shall confine attention chiefly to them. A list of 84 having a population of 50,000 and upwards, exclusive of London, is given by Mr Dewsnup. The overcrowding ranges from 34.54% in Gateshead and 32.42% in South Shields to 0.97% in Northampton and 0.62% in Bournemouth. Of the whole number exactly one-half have less than 5%; 15 have less than 2% and 22 have 10% or more. Neither size nor character has much to do with the variation. Bournemouth, at the bottom of the list with 0.62%, is a residential place and health resort with a population of about 50,000; so is Tynemouth, which is nearly at the top, with 30.71%. The two largest towns, Liverpool and Manchester, are 26th and 32nd on the list, with only 7.94% and 6.28% respectively, or considerably less than the average; and on the other hand none of the first 17 towns with the highest proportion of overcrowding are of the largest size. Again, with regard to character, Leicester and Northampton, which are almost at the bottom of the list, with 1.04% and 0.97% respectively, are both purely industrial towns. The most striking facts are that the six towns, which alone have more than 20% of overcrowding, namely Gateshead (34.5), South Shields (32.4), Tynemouth (30.7), Newcastle (30.4), Sunderland (30.10), Plymouth (20.1) are all old seaports, that four of them at the head of the list are on the Tyne and the fifth on the Wear. This points strongly to special local conditions and it is borne out by the facts with regard to rural districts. Northumberland and Durham show a great excess of overcrowding over other counties; and some of their rural districts even surpass any of the towns. The highest of all is the district of Tynemouth, with 38.18% of overcrowding. The explanation lies in a special combination of large families and small houses prevalent in this area. All the rural districts are seats of coal-mining, and miners are the most prolific section of the population. They also live in small houses of a traditional and antiquated character, often of one storey only or built back to back. Many are built by colliery

proprietors. Large families and small houses also prevail in the towns. Some of them contain coal-pits and the rest of their industrial population is engaged chiefly in engineering and shipbuilding works, occupations also usually associated with a high birth-rate. The men live as near their work as possible and the practice of living in flats or occupying part of a house prevails extensively.

In London the number of persons living in overcrowded conditions in 1901 was 726,096 or 16.0% of the population. The proportion varied from 2.6% in Lewisham to 35.2% in Finsbury, but in 23 out of the 29 boroughs into which the county is divided it exceeded the urban mean for the whole country, and in 9 boroughs having an aggregate population of 1,430,000 it was more than double the mean. Conditions in London are evidently untypical of English towns.

In the light of the census figures it is clear that no large proportion of the English industrial population is living under conditions of serious overcrowding, outside the special districts mentioned and that the expression "house famine" cannot be properly applied to England or English towns in general. In the House of Commons, on the 16th of August 1909, the president of the Local Government Board, Mr John Burns, gave a list of the number of unoccupied houses and tenements in each of the London boroughs and in the eight largest provincial towns, including Glasgow; the total was 104,107. By a further analysis of the census returns Mr Dewsnup shows that a great deal of the overcrowding is of a comparatively mild character and that it is due to a relatively small excess of population. Bradford, for instance, is credited with 40,896 overcrowded persons, representing the high percentage of 14.61 of the population; but in the case of nearly 20,000 the excess over the standard is very slight, and the proportion of gross overcrowding comes down to 7.55%. Moreover, this serious overcrowding is produced by no more than 2.79 of the population, so that its cure presents no insuperable difficulty. The argument is confirmed by the very substantial diminution which actually took place between 1891 and 1901. The facts are so striking that they deserve to be presented in tabular form:—

Percentage of Population Overcrowded.

	1891	1901
England and Wales	11.23	8.20
Gateshead	40.78	34.54
Newcastle	35.08	30.47
Sunderland	32.85	30.10
Plymouth	26.27	20.19
Halifax	21.31	14.49
Bradford	20.61	14.61
Huddersfield	19.89	12.88
London	19.70	16.01
Leeds	16.46	10.08
St Helens	15.72	10.86
Birmingham	14.27	10.32
Burnley	12.74	7.14
Sheffield	11.58	9.50
Bolton	11.22	6.50
Liverpool	10.96	7.94
Oldham	10.13	7.42
Salford	9.39	7.54
West Ham	9.34	9.27
Wolverhampton	9.31	4.67
Swansea	9.25	5.57
Stockport	8.50	4.98
Manchester	8.25	6.28
Bristol	8.03	3.55
Hull	7.86	6.12
Blackburn	7.05	3.92
Birkenhead	6.80	5.02
Norwich	4.91	3.34
Brighton	4.56	3.07
Cardiff	4.31	2.92
Preston	4.13	2.64
Nottingham	3.62	3.65
Croydon	2.76	2.74
Derby	2.59	1.18
Leicester	2.22	1.04
Portsmouth	1.74	1.19

To what is this remarkable movement due? It is far too general to be attributed to the operation of the Housing Acts; for, though they have helped in some cases, a great diminution has occurred in many places in which no use has been made of them. Towns of all kinds and in all parts of the country exhibit the same movement in some degree; those which had little and those which had much overcrowding, the worst and the best. In London the percentage fell by 3.7, and the number of persons overcrowded was reduced by 103,669 in spite of an increase of population of 324,798. In Gateshead a fall of 6.2%, in Newcastle one of 4.6% took place; while at the other end of the scale Leicester and Derby reduced their already very low proportions by more than one-half. Nottingham is the only exception in the whole list. And in 28 out of the 35 towns the decrease of overcrowding was absolute as well as relative in spite of a large increase of population. London has been cited. The other large towns may be tabulated with it, thus:—

Town.	Increase of Population.	Decrease of Overcrowded Persons.
London	324,898	103,669
Liverpool	166,978	2,381
Manchester	38,504	7,545
Birmingham	44,091	14,290
Leeds	61,463	17,252
Sheffield	56,550	1,388
Bristol	107,367	6,105
Bradford	63,406	3,696

The very divergencies make the uniform diminution of overcrowding the more remarkable. The large increase of population in Liverpool and Bristol no doubt means extension of boundaries, which might have the effect of reducing the proportions of overcrowding, but it cannot account for the actual decrease of overcrowded persons. The change seems to be due to three factors all of which have been in general operation though in varying degrees. They are (1) the centrifugal movement promoted by improved locomotive facilities, (2) the declining birth-rate, (3) public health administration: (1) The first is the most important and the chief element has been tramways, of which a great extension accompanied by electrification took place in the decade. Thus the process of urbanization has been modified by one of suburbanization. Bristol is a prominent case; its overcrowding has been reduced by more than one-half without any large and costly municipal interference, mainly through the operation of ordinary economic forces. Tramways have made the outskirts accessible and builders have utilized the opportunity. They have built good houses, too, under supervision, and Bristol, though an old seaport and industrial town with much poverty, has the lowest general death-rate and the lowest infantile death-rate of all the great towns. (2) The birth-rate and the size of families are conditions which affect overcrowding in a very marked degree, though no attention is paid to them in that connexion. The case of the mining districts and the towns on the Tyne has been mentioned above; the same thing is seen in London, where all the most overcrowded districts (Finsbury, Stepney, Shoreditch and Bethnal Green) have high birth-rates, ranging from 31.3 to 36.4 per 1000 in 1902-1906. The necessity imposed on poor parents of putting several children into a cheap and therefore small dwelling accounts for a large proportion of overcrowding, which automatically diminishes with a falling birth-rate. The ultimate advantage of this method of reducing overcrowding is a question on which opinions may differ, but there is no doubt about the fact. (3) Public health administration is the third general cause; it attracts no notice and works very gradually, but it does work. The last annual report (for 1907) of the medical officer to the London County Council says of overcrowding: "There is reason for thinking that in recent years greater

attention has been paid by sanitary authorities to the abatement of the nuisance, and Dr Newman states that in Finsbury there has been an enormous reduction in overcrowding, the reduction having been effected mainly in the years 1901-1905." The medical officers of the metropolitan boroughs reported in 1907 2613 dwellings overcrowded in 23 boroughs and 3216 such dwellings remedied in 27 boroughs. It should not be forgotten that a good deal of overcrowding is voluntary. Families which have not enough room for their own members nevertheless take in lodgers; and in some places, of which London is the most conspicuous but not the only example, foreigners herd together thickly in a very small space.

The improvement shown by the statistics of overcrowding is confirmed by those relating to the size of dwellings. Between 1891 and 1901 the percentage of the population living in very small dwellings appreciably diminished thus—in 1-roomed dwellings, from 2.2 to 1.6%; in 2-roomed dwellings, from 8.3 to 6.6%; in 3-roomed dwellings, from 11.1 to 9.8%; while the proportion living in dwellings of 5 rooms and upwards increased from 54.9 to 60.1%. This again is referable to the suburban movement and a higher standard of requirements. Six-roomed houses with a bathroom tend to replace the old four-roomed type. The general report accompanying the census says: "However the tenement figures for England and Wales are compared it is impossible to avoid the conclusion that the comparison affords satisfactory evidence of distinct improvement in the housing of the people during the ten years 1891-1901." In short, the problem of quantity is only acute in a few places and steadily becoming less so.

The foregoing facts apply only to England and Wales. In Scotland the state of things is much less satisfactory. No statistics of overcrowding are available, but the following comparative table shows how different the housing conditions are in the two countries:—

Size of Dwellings, England and Scotland, 1901.

Dwelling.	Percentage of Population.	
	England.	Scotland.
1 room	1.6	11.1
2 rooms	6.6	39.5
3 rooms	9.8	19.9
4 rooms	21.9	9.1
5 rooms and over	60.1	20.4

Over 50% of the population of Scotland live in tenements of one or two rooms; only 8.2% in England. A comparison of the largest towns in the two countries gives the following result:—

Percentage of Population.

Scotland.			England.		
Town.	1 Room.	2 Rooms.	Town.	1 Room.	2 Rooms.
Glasgow	16.2	38.9	London	6.7	15.5
Edinburgh	8.9	32.4	Liverpool	2.7	5.9
Dundee	11.3	51.7	Manchester	0.8	4.01
Aberdeen	6.1	33.2	Birmingham	0.3	2.4
Paisley	13.5	49.9	Leeds	0.4	9.5
Greenock	11.3	47.6	Sheffield	0.4	4.0
Kilmarnock	18.9	43.3	Bristol	1.6	5.7
Mean	12.7	42.4	Mean	1.8	6.7

The conditions in Scottish towns where very tall tenement houses are common, resemble those in other countries, in which overcrowding is far greater than in England. All these matters are comparative, and the superiority of conditions in England ought to be recognized. Yet, in Scotland, too, great improvements have been effected. In 1861 there were 25,939 houses without windows; in 1901 only 130. These facts throw light on the long standing of the housing question, the change of standard and the improvement effected.

In Ireland there is more overcrowding than in England, though probably less than in Scotland, with the possible exception of Dublin, which has a larger proportion of one-roomed dwellings than any Scottish town, namely, 24.7%. The percentage of population living in overcrowded conditions in the principal towns is—Dublin 40.6, Limerick 31.7, Cork 23.4, Waterford 20.6, Londonderry 16.7, Belfast 8.2.

Sanitary Conditions.—With regard to the quality of existing housing reference has already been made to the effect of the Public Health Acts and the general improvement in sanitation. The only numerical measure is afforded by the death-rates, which have fallen in England from 20.9 per 1000 in 1871-1875 to 15.4 per 1000 in 1903-1907 and in the United Kingdom from 21.3 to 15.7 per 1000 in the same period. The condition of the dwelling must be credited with a considerable share in this fall. There have, in fact, been great changes and all in the direction of improvement. The rise and development of sanitation, of house and main drainage and sewage disposal, the purification of water and provision of a constant service in the house, the removal of refuse, the segregation of infectious illness, sanitary inspection—all these, apart from the demolition of the worst housing and the provision of better, have raised the general healthiness of the dwellings of the people. In face of these facts and of the vital statistics, to say that the people are physically deteriorating through the influence of bad housing is to talk obvious nonsense, for all conditions have been improving for more than a generation. If physical deterioration is going on, of which there is no proof, either it is not caused by bad housing or there is less than there was. Deterioration may be caused by the continued process of urbanization and the congregating of an ever larger proportion of the population in towns; but that is a different question. If the town has any injurious influence it is not due to the sanitary condition of the houses, which is in general superior to that of houses in the country, but to the habits and occupations of the people or to the atmosphere and the mere aggregation. But much misapprehension prevails with regard to towns. The most distinctive and the most valuable feature of English housing is the general predominance of the small house or cottage occupied by a single family. Only in London and a few other towns do blocks of large tenement houses of the continental type exist, and even there they are comparatively few. In England and Wales 84% of the population live in dwellings of 4 rooms and upwards, which means broadly separate houses. Now the prevalence of small houses involves spreading out and the covering of much ground with many little streets, which produce a monotonous effect; a smoky atmosphere makes them grimy and dull skies contribute to the general dinginess. The whole presents to the eye a vast area of dreary meanness and monotony. Thus the best feature of English national housing turns to its apparent disadvantage and the impression is gained by superficial observers that the bulk of our working-class populations lives in "slums." The word "slum" has no precise meaning, but if it implies serious sanitary defects it is not applicable to most of our town housing. There are real slums still, but the bulk of the working class population do not live in them; they live in small houses, often of a mean and dingy exterior but in essential respects more sanitary than the large and often handsome blocks to be seen in foreign towns, which are not put down as slums because they do not look dirty. A smoky atmosphere is injurious to health, but it must be distinguished from defects of housing. Ideal houses in a smoky place soon look bad; inferior ones in a clean air look brighter and deceive the eye. The worst of the old housing has disappeared; the filthy, dilapidated, airless and sunless rookeries—the real slums—and the underground dwellings have been swept away in most cases, and what remains of them is not so bad as what has gone. But reform has been very regularly applied. Some towns have done much, others little. The large towns, in which the evil was most intense and most conspicuous in bulk, have as a class done far more than smaller ones in which the need perhaps was less great, but in which also a less healthy public spirit prevailed. The worst housing conditions to-day are probably to be found in old towns of small and medium size, in which the ratepayers have a great disinclination to spend money on anything, and the control of local affairs is apt to be in the hands of the owners of the most insanitary property. Nor is this state of things altogether confined to old places. Some of recent growth have been allowed, for the same reason, to spring up and develop without any regard to sanitary principles or the requirements of public health.

There is therefore abundant scope for further reform and in not a few cases urgent need of it. On the other hand, we have a number of towns, particularly manufacturing towns, both large and small in the midlands and the north of England, which have already reached a good general standard of housing in all essential requirements, and only need the regular and steady exercise of vigilance by the public health service to remove such defects as still remain or may reveal themselves with the lapse of time.

Rents.—Rent is a matter of great importance from every point of view, and that is now being realized. A quantity of official information on the subject has been collected and made available by an elaborate inquiry ordered by the Board of Trade in 1905 and published in 1908 (Cd. 3864). It relates to working class dwellings in the principal industrial towns in the United Kingdom, 94 in all: namely, 77 in England and Wales, 11 in Scotland and 6 in Ireland. The following tables give in a condensed form the chief statistical results obtained in October 1905:—

Predominant Range of Weekly Rents.

	England and Wales.		Scotland.	Ireland.
	London.	Provincial towns.		
One room	2/- to 2/6	1/6 to 2/6
Two rooms	4/6 to 7/6	3/- to 3/6	3/10 to 4/3	2/6 to 3/6
Three "	6/- to 9/-	3/9 to 4/6	5/2 to 6/5	4/- to 5/-
Four "	7/6 to 10/6	4/6 to 5/6	..	5/6 to 6/9
Five "	9/- to 13/-	5/6 to 6/6
Six "	10/6 to 15/6	6/6 to 7/9

Rents are lowest in Ireland and next lowest in English provincial towns, considerably higher in Scotland and highest of all in London, for which further special details are given. It is divided into three zones (1) central, (2) middle, (3) outer, which have the following mean weekly rents:—

London Mean Weekly Rents.

	Zone.		
	Central.	Middle.	Outer.
One room	4/6	3/9	..
Two rooms	7/-	6/-	..
Three "	8/9	7/6	6/6
Four "	9/-	7/9
Five "	11/-	9/6
Six "	13/-	11/-

In central London—which extends to Stepney in the East, Lambeth in the South, Islington in the North, and includes Westminster, Holborn, Finsbury, Marylebone, Shoreditch, most of Bethnal Green, Southwark and Bermondsey—the rent of a single room may be as high as 6s. or even 6s. 6d. (Holborn) a week. It is here that overcrowding is greatest, and block-tenements, philanthropic and municipal, most numerous. The rentals of the block dwellings have not been taken into account in the foregoing official statistics; they range as follows: 1 room, 2s. 6d. to 5s.; 2 rooms, 5s. to 8s.; three rooms, 6s. 6d. to 11s. The lowest rent for which a single room can be obtained in this area is 2s. 6d. a week. In no English town are rents nearly so high as in London. If 100 is taken as the index number for rent in London the nearest towns to it (Croydon and Plymouth) only reach 81, and one town on the list (Macclesfield) is as low as 32. The index number of twenty-one towns out of the whole is 50 or under, and these include a number of important industrial centres—Hull, Leicester, Blackburn, Northampton, Warrington, Coventry, Crewe and others. The index numbers of the great towns are: Liverpool 65, Manchester and Salford 62, Birmingham 59, Leeds 56, Sheffield 55, Bristol 53, Bradford 59, Hull 48; that is to say the level of rents in these towns is little more than half that in London. This is one more proof of the untypical character of London, and of the fallacy of generalizing from it to the rest of the country. Even in the overcrowded towns on Tyneside rents do not run to three-fourths of the London level. When the towns are divided into geographical groups the index numbers run thus: London 100, Northern Counties 62, Yorkshire 56, Lancashire and Cheshire 54, Midlands 51, Eastern Counties 50, Southern Counties 61, Wales and Monmouth 60. Rents are always highest in capitals, and Edinburgh complies with the rule; but it is very slightly in advance of Glasgow, and in Scotland generally the range is much smaller than in England. Dublin, on the other hand, is differentiated from the other Irish towns as widely as London from English ones.

A general and progressive rise in rents has been taking place for many years. The following index numbers for the great towns are

given in the second series of memoranda published by the Board of Trade in 1904 (Cd. 1761):—

Relative Working-Class Rents.			
1880	86.6	1895 96.3
1885	90.1	1900 100.0
1890	89.9	

The tendency to rise is attributable to increased cost of labour, due to higher wages and less work, increased cost of materials and higher rates. Weekly working-class rents generally include rates which are paid by the landlord. Housing reform has contributed to the rise, both directly and through the rates, on which it has thrown a heavy burden in various ways. When slums are cleared away and replaced by superior dwellings the new rents are generally higher than the old and this fact has proved a great difficulty. Most of the improved housing is beyond the means of those who need it most, and they seek other quarters resembling the old ones as nearly as possible. The example of Liverpool, which has the largest proportion of casual and ill-paid labour of all the great towns, and has been the most successful in providing new dwellings of a fair quality, centrally situated and not in blocks, at really low rates, shows that the problem is not insoluble; but as a rule too little attention is paid to the question of rent in housing reform, especially in building undertaken by municipalities. It is not ignored, but the importance attached to it by the poor is not realized. To them it is the first consideration after four walls, a roof and a fire-place; and 6d. a week makes a vast difference in their calculations. Reform which aims at raising the lowest classes of tenants by improving their dwellings defeats itself when it drives them away.

Rural Housing.—Little has hitherto been said about rural housing. It is of less importance than urban housing because it concerns a much smaller proportion of the population, and because in rural life the influence of inferior housing on health is offset by other conditions; but it has recently attracted much attention and was made the subject of inquiry by a Select Committee of the House of Commons in 1906. The report laid stress chiefly on the inaction of local rural authorities under the Public Health and Housing Acts, and on various obstacles in the way of improving existing houses and of providing more and better ones at rents which agricultural labourers can afford to pay. The available facts with regard to rural housing are scrappy and unsatisfactory. The word "rural" has no precise meaning and it includes several very different sections of the population; for instance, the inhabitants of suburbs, mining villages and mill villages as well as the real agricultural population. Complaint is made of both the quantity and the quality of rural housing. With regard to quantity it is said that in spite of migration to the towns there is a dearth of cottages through dilapidation and demolition without rebuilding. That may happen in particular localities, but there is no evidence to support a general allegation. Inquiries issued by the Board of Trade to agricultural correspondents brought the following replies: insufficient 56, sufficient 111, more than sufficient 32. Similar inquiries of land agents and owners resulted thus: insufficient 9, sufficient 11, more than sufficient 4, variable 6. From which it appears that insufficiency exists but is not general. The official evidence with regard to overcrowding is that it is much less acute than in the towns. The proportion of the rural population in England living in overcrowded conditions in 1901 was 5.8%; if the rural mining districts, the exceptional overcrowding of which has been noted above, be eliminated, the rest cannot be very bad. Moreover, the percentage has appreciably diminished; in 1891 it was 8.46. The complaint of bad quality is better founded. Some landowners take great pride in the state of their property, and excellent cottages may be found in model villages and elsewhere in many parts of the country; but much rural housing is of an extremely insanitary character. A good deal of evidence on this head has of late years been published in the reports of medical inspectors to the Local Government Board. And local authorities are very reluctant to set the law in motion against insanitary dwellings. On the other hand, they have in some cases hindered and prevented building by too rigid insistence on by-laws, framed with a view to urban housing and quite unsuited to rural conditions. A few rural authorities have taken action with regard to building schemes under Part III. of the Housing Act. A list of 31 in 17 counties is given in "Housing up to Date"; 13 applications were refused and 13 granted by the respective county

councils and others were dropped. Details are given by the same authority of 54 houses built by 17 rural district councils. Public action may thus be said to amount to nothing at all. Landowners, however, have borrowed under the Improvements of Lands Acts upwards of £1,250,000 for building labourers' cottages; and this is probably only a fraction of the amount spent privately.

In Ireland a special condition of affairs exists. A series of about a dozen acts, dating from 1881 and culminating in the Labourers (Ireland) Act of 1906, have been passed for promoting the provision of labourers' cottages; and under them 20,634 cottages had been built and some thousands more authorized previous to the act of 1906, which extended the pre-existing facilities. The principle is that of the English Housing Acts applied to rural districts, but the procedure is simpler and quicker. The law provides that a representation may be made to the local authority by three ratepayers or resident labourers that "the existing house accommodation for agricultural labourers and their families is deficient having regard to the ordinary requirements of the district, or is unfit for human habitation owing to dilapidation, want of air, light, ventilation or other convenience or to any other sanitary defects," whereupon the local authority shall make an improvement scheme. It may also initiate a scheme without representation, or the Local Government Board may do so in default of the local authority. The scheme is published, an inquiry held, notice given and an order made with very much less delay and expense than under the English law. Land is purchased by agreement, or compulsorily and the money for land and building raised by loan. Loans amounting to about 3½ millions sterling had been raised down to 1906. The great majority of the cottages built are in Munster and Leinster. They must have at least 2 bedrooms and a kitchen, and the habitable rooms must be 8 ft. high. One of the most remarkable features is the low cost—about £150—at which these cottages have been built, including land and the expenses of procedure.

Recent Developments.—It is clear from a general review of the subject that the problem of housing the working classes in a satisfactory manner has proved more complex than was at one time realized. Experience has falsified hopes and led to a change of attitude. It is seen that there are limits to drastic interference with the normal play of economic forces and to municipal action on a large and ambitious scale. A reaction has set in against it. At the same time the problem is being attacked on other sides and from new points of departure. The tendency now is towards the more effectual application of gradual methods of improvement, the utilization of other means and the exercise of prevention in preference to cure. Under each of these heads certain movements may be noted.

The most troublesome problem is the treatment of existing bad housing. In regard to this the policy of large improvement schemes under which extensive areas are bought up and demolished has had its day, and is not likely to be revived to any considerable extent. That is not only because it is extremely costly but also because it has in the main done its work. It has done what could not have been done otherwise, and has swept away the worst of the old housing *en masse*. To call it a failure because it is costly and of limited application would be as great a mistake as to regard it as a panacea. The procedure which seems to be coming into favour in place of it is that adopted in Birmingham and advocated by Mr J. S. Nettleton (*Practical Housing*) coupled with a more general and effective use of the Public Health Acts. The principle is improvement in detail effected by pressure brought to bear on owners by public authority. The embodiment of this principle forms an important part of the Housing and Town Planning Bill introduced by the Local Government Board in 1908, which contained clauses empowering the central authority to compel apathetic local authorities to do their duty in regard to the closing of unfit houses, and authorizing local authorities both to issue closing orders and to serve notices on landlords requiring them "to execute such works as the local authority may specify as being necessary to

make the house in all respects reasonably fit for human habitation."

Among the other and less direct means to which attention is being turned is the policy of getting people away from the towns. The effect of improved travelling facilities in reducing urban overcrowding has been noted above. That object was not specifically contemplated in the building and electrification of tramways, and in the development of other means of cheap local travel, but the beneficial effect has caused them to be recognized as an important factor in relation to housing and to be more systematically applied in that connexion. A newer departure, however, is to encourage migration not to the outskirts of towns but altogether into the country by facilitating the acquisition of small holdings of land. This has been done by private landowners in an experimental way for some years, and in 1907 the policy was embodied in the Small Holdings Act, which gives county and borough councils power to purchase or hire land compulsorily and let it in holdings of not more than 50 acres or £50 annual value. Failing action on their part the Board of Agriculture may frame schemes. Power is also conferred on the Board and on County Councils to establish co-operative agricultural societies and credit banks. These measures have been adopted from foreign countries, and particularly from Denmark and Germany. A very large number of applications for holdings have been made under this act, but it is too early to state the effects. They will depend on the success of tenants in earning a livelihood by agricultural produce.

Another new and quite different departure is the attempt to establish a novel kind of town, called a "Garden City," which shall combine the advantages of the town and the country. The principal points are the choice of a site, which must be sufficiently convenient to enable industries to be carried on, yet with rural surroundings, the laying out of the ground in such a way as to ensure plenty of open space and variety, the insistence on building of a certain standard and the limitation of size. One has been established at Letchworth in Hertfordshire, 34 m. from London, and so far seems to be prospering. It consists of an area of 3800 acres, bought from the previous owners by a company registered in 1903 and entitled First Garden City Ltd., with a capital of £300,000 in £5 shares. The interest is limited to a dividend of 5%, all further profits to be devoted to the benefit of the town. The estate is divided into a central urban area of 1200 and a surrounding agricultural belt of 2600 acres. The town is planned for an eventual population of 30,000 and at present (1909) has about 5000. Some London printing works and other small industrial establishments have been planted there, and a number of model cottages have been built. In this connexion another recent novelty has appeared in the shape of an exhibition of cottages. The idea, originated by Mr St Loe Strachey, was to encourage the art of designing and building cheap but good and convenient cottages, especially for the country. Two exhibitions have been held at Letchworth in 1905 and 1907, and others at Sheffield (1907) and Newcastle (1908). The two latter were held on municipal land, and it is proposed by the National Housing Reform Council to hold one every year.

The "Garden City" has led to the "Garden Suburb," an adaptation of the same idea to suburban areas. One was opened near Hampstead Heath in 1907: it consists of 240 acres, of which 72 have been reserved for working-class cottages with gardens. These developments, with which may be associated the model industrial villages, mentioned above, at Bourneville, Port Sunlight and Earswick, represent an aspiration towards a higher standard of housing for families belonging to the upper ranks of the working classes; and the same movement is demonstrated in a still more interesting fashion by a particular form of co-operative activity known as Co-partnership Housing. The first complete example of this method of organization was the Ealing Tenants Limited, a society registered under the Industrial and Provident Societies Act in 1901, though the Tenant Co-operators Limited, formed in 1888, was a precursor on very nearly the same lines. The essential principle is self-help

applied by combination to the provision of superior homes, and the chief material feature is the building of houses which are not only of good design and workmanship, but disposed on a systematic plan so as to utilize the ground to the best advantage. Land is bought and houses are built with combined capital to which each tenant contributes a substantial share; the houses are let at rents which will return 5% on share capital and 4% on loan capital after defraying all expenses, and the surplus profits are divided among the tenant members in proportion to the rents paid by them. Each tenant's share of profits is credited to him in shares until his share capital equals the value of the house he occupies, after which it is paid in cash. There is thus common ownership of the whole group, which forms a little community. This system has caught on in a remarkable way and has spread with great rapidity. In 1905 a central organizing body was formed called the Co-partnership Housing Council, for the purpose of promoting the formation of societies and assisting them with advice; it is supported by voluntary contributions. In 1909 twelve societies, including the original Tenant Co-operators, had been formed with a total investment of £536,300. They are situated at Ealing, Letchworth, Sevenoaks, Leicester, Manchester, Hampstead (two), Harborne near Birmingham, Fallings Park, Stoke-on-Trent, Wayford and Derwentwater. The rapidity with which the movement has developed and spread since the establishment of the Co-partnership Housing Council indicates great vitality, and since it is based on thoroughly sound lines it has probably a large future. It is the most interesting and in many respects the best of all recent developments. The Report of the Select Committee on Rural Housing mentioned above suggested that a Co-partnership Housing Society should be formed in every county in England.

All the enterprises just described have one feature in common, namely, the laying out of sites on a plan which takes cognizance of the future, secures a due proportion of open space, variety in the arrangement of streets and the most advantageous disposition of the houses and other buildings. They go beyond sanitary requirements and take account of higher needs. They have lent force to the advocacy of municipal "town-planning," as practised by several towns in Germany; and provision was made for this procedure in the Housing and Town Planning Act of 1909. The act contains clauses giving local authorities power to prepare plans with reference to any land which appears likely to be used for building purposes within or near their own boundaries; and also to purchase land comprised in a town-planning scheme and either build on it themselves or let plots for building in accordance with the plan. The chief object is to safeguard the future, prevent the repetition of past defects and encourage a higher standard of housing.

These new developments represent an upward movement at the higher end of the scale. They cater for the superior ranks of working classes, those who attach some importance to the aesthetic and moral influence of pleasant and wholesome surroundings, and are willing to sacrifice immediate gratifications to a higher end. They embody an aspiration, set an example and exercise an educative influence. But they have nothing to do with the housing of the really poor, which is the great difficulty; and their very attractiveness seems in some danger of drawing attention from it. Garden cities and suburbs will never house the poor or even the bulk of our working class population, and it would be a pity if the somewhat sentimental popularity of romantic schemes led to a distaste for the plodding effort which alone can effect a real cure of deep-seated social evils of long standing. All the new schemes and legislative proposals leave untouched the greatest difficulty of all, which lies not in the dwelling but in the tenant. It is comparatively easy to afford better opportunities to those who are willing to take advantage of them, but how to raise those who are not? The lesson taught by Miss Octavia Hill's classical experiment is, if not forgotten, certainly neglected in the presence of more showy efforts. Or perhaps it would be more true to say that half of it is neglected. Miss Hill was one of the pioneers in the comparatively modest

method of improving and reconstructing bad houses, which, as we have noted, is now being more generally recognized and pursued; but that was only half her work. She improved bad dwellings and made them decent, but she also managed them on business lines; by a system of inspection and rent collection which combined a judicious discipline with the stimulus of reward. This was done by means of personal service, which is the secret of all really effective work among the poor. Her words written years ago remain true to-day: "The people's homes are bad partly because they are badly built and arranged, they are tenfold worse because the tenants' habits and lives are what they are. Transplant them to-morrow to healthy and commodious homes and they will pollute and destroy them."

The following is a list of the principal associations formed for the promotion of housing reform: Mansion House Council on the Dwellings of the Poor, Rural Housing and Sanitation Association, Workmen's National Housing Council, National Housing Reform Council, Co-partnership Tenants' Housing Council. They are all of recent date, except the first. There are also local associations at Liverpool, Oldham, Rochdale, York, Plymouth, and elsewhere.

OTHER COUNTRIES

At the International Housing Congress organized by the National Housing Reform Council and held in London in 1907 representatives were present from a number of foreign countries and a good deal of information was collected and published in the report of the Congress. Further detailed data have been supplied by foreign correspondents to Mr. W. Thompson and published in *Housing up to Date*. The more important facts relating to the principal industrial countries are here condensed from this and other sources of information.

Austria.—An act for encouraging the building of cheap working-class dwellings was passed in 1902; it provides for exemption from taxes for 24 years of working-class dwellings which fulfil certain conditions, including sanitary requirements, a minimum area per room, minimum height, minimum door and window spaces, thickness of walls, a maximum number of inhabitants (one to 4 sq. metres in sleeping rooms), prohibition of lodgers, fixed rent and maximum profit. The municipalities are the authority for administering sanitary and housing laws; they have no power of compulsory purchase of land without a special law. There is excessive overcrowding in the large towns; in Vienna (1900) 43 % of the population live in dwellings of 1 room or 1 room and a kitchen; in 60 provincial towns the proportion is 63 %. Overcrowding is reckoned at more than 5 persons to a room and more than 2 to two rooms; the proportion of overcrowded on this basis is nearly one-fifth in Vienna and one-fourth in the provincial towns (Thompson).

Belgium.—An act was passed in 1889 instituting *Comités de Patronage*; since then other Acts relating to loan societies, and to inheritance and succession in the case of small properties. *Comités de Patronage* are semi-official bodies, but without legal power, whose function it is to study the subject of housing, to report to local authorities on existing conditions, to advise, to collect funds and promote the provision of good houses by any means in their power. They influence public opinion and stimulate the activity of local authorities which have the power to compel improvements and close dwellings unfit for habitation; they have led to the formation of numerous societies for erecting working-class dwellings. The latter are encouraged by the law in various ways; they are exempt from the payment of some government duties and partly exempt from others. Working men buying or building houses liable to registration fees up to from 75 to 171 francs are exempted from personal, provincial and communal taxes. The National Savings Bank of Belgium is empowered to lend money to working men for buying or building houses and to insure the lives of those doing so, to preserve the home for the family. In 1904 the number of workmen's homes exempted from taxation was 164,387, and the amount of taxation remitted considerably exceeded 3 million francs; workmen had acquired lands and houses valued at nearly £4,000,000; there were 161 societies for building working-class dwellings; 30,000 workmen representing a population of 150,000 had become owners of property; and 70,000 representing a population of 350,000 had availed themselves of the law in obtaining exemptions and loans (O. Velghe). The foregoing results effected in 15 years are remarkable and indicate a great capacity for self-help on the part of Belgian workmen with suitable and well-considered assistance. But this movement, in common with those of a similar character in other countries, does not touch the problem of housing the very poor. No statistics of overcrowding are available, but the average number of persons to a dwelling is over 5 for the whole country and nearly 9 in Brussels. The communal administrations are the authorities for health and housing; they have power to abate nuisances but not to compel landowners to sell land for building, though they have the right to dispose of it for "public purposes." No town has constructed

quarters devoted entirely to working-class dwellings and only one commune (St Giles) has built any. In towns the height of buildings is regulated by the width of streets; generally it is the width plus 6 metres. The height of rooms and thickness of walls are prescribed by local regulations but not the area of rooms. The housing difficulty has been lessened in a notable degree by cheap transport facilities, including railroads, light railroads and tramways; a large proportion of the workpeople travel long distances to and from work. One-quarter travel on the State railways alone; fares are 1s. 6d. a week for a daily double journey of 20 m., 2s. for 44 m. and 2s. 6d. for 66 m. The area of the labour market of Liège extends nearly to Ostend and out of 5830 workmen travelling over 1000 live more than 50 kilometres from Liège. Some journeys last 3 hours.

France.—The question of housing was publicly raised in France quite as early as in England on grounds of public health in connexion with the first visitation of cholera, and building societies were formed as early as 1851, but little was done until after 1889, when the *Société Française des Habitations à Bon Marché* was founded under the inspiration of M. Siegfried. This led to the formation of several societies, which increased rapidly after the passage of *la loi Siegfried* in 1894, for promoting the provision of working-class dwellings. In 1902 a Public Health Act and in 1906 a Housing of the Working Classes Act were passed, and these three enactments with regulations made in 1907 govern the procedure. The act of 1906 embodies the Belgian system of *Comités de Patronage*, of which at least one was to be established in each department with grants in aid, and exemptions from certain taxes of working-class dwellings fulfilling specified conditions as to sanitation and rent. The law promotes the formation of Housing Societies by granting various facilities for the investment of money in building by public bodies and benevolent institutions by taking shares or by loans. Down to the end of 1906 there had been lent for this purpose £233,000 by savings banks, £258,000 by the Caisse des Dépôts, and £14,000 by charitable institutions. The law does not authorize municipalities to build houses and none of the communes have acquired land for this purpose. Under the Public Health Act of 1902 towns can purchase land compulsorily in connexion with unhealthy areas. The Public Health and Housing Acts are administered by the local authority, which makes regulations for building and for laying out building land. A minimum height of 2-6 metres and a minimum cubical content of 25 cubic metres are prescribed for rooms; there are no regulations for thickness of walls. Housing societies are under the Ministry of Works and a Superior Housing Council, which is a central advisory body. These societies are now numerous; there are 46 in Paris alone, but their operations are not on a large scale. One of them deserves special notice on account of its special object. It is called the *Société de logements pour familles nombreuses* and it builds special flats called *maisons des enfants* which are let at low rents only to persons with large families. In 1907 it had housed 168 families, averaging 6-8 persons, in two blocks at Belleville and Montmartre. The great defect in France is the large quantity of old, bad, insanitary housing. Real slums exist in all the old towns and in some of them, such as Marseilles and Lyons, on an extensive scale. Very little has hitherto been done to grapple with this difficulty. The standard of sanitation is altogether lower in France than in England, as is shown by the death-rates, and this holds good of the housing. But conditions vary widely in different parts of the country. They are better, generally speaking, in the industrial towns of the north, which are largely Flemish and distinguished by the prevalence of small houses after the English fashion, than in the central or southern districts where tall old tenement houses of six and seven stories abound. There are no statistics and no standard of overcrowding; but the careful inquiry carried out by the Board of Trade and published in 1909 shows the extraordinary prevalence of tenements consisting of 1, 2 or 3 rooms. In 16 towns for which information was obtained the average proportion of dwellings containing less than 4 rooms was 75 % of the whole; in some it was as high as 89 % and in some lower than 61 %. In 8 towns, including Paris, the number of one-roomed dwellings was more than a quarter of the whole, and in two towns (Brest and Fourmies) it was more than half. Some corresponding statistics for English and German towns are given below in the section on Germany. According to the same report, the general accuracy of which has been confirmed by personal inquiries, made in 1909 by the writer in a number of towns, rents are decidedly lower in France. If the London level be taken as 100 that of Paris is only 78 and the other French towns are considerably lower, 28 out of 29 being less than half the London standard. A general comparison between a number of English and French towns shows the average level of French rents to be less than three-fourths of English ones. A noticeable feature of housing in France is the large number of dwellings built by employers in recent years. The mining companies, particularly in the Pas de Calais, have built whole groups of villages; the railway companies and various manufacturers have also done a great deal, chiefly in rural areas. Among the manufacturers MM. Schneider at Le Creusot and the textile mill-owners in the Vosges are noticeable. The houses provided are of a charming type, white with red roofs; the rooms are of good size, the rents low, and a large garden is usually attached to every house.

Germany.—In no country is the problem of housing more acute

than in Germany, where the increase of population, the growth of manufacturing industry and the urbanization of the people have proceeded at an exceptionally rapid pace in recent years and have combined with increasing wealth and a rising standard of living to force the question into prominence. Up to 1909 no uniform legislation for the empire had been framed and no central authority existed for dealing with housing; but the several states have their own public health and housing laws, and great activity has been developed in various directions. The most general difficulty is deficiency of quantity consequent on the rapid change in the distribution of the population. The proportion of the whole population living in the great towns increased from 7.2% to 16.2%, or more than doubled between 1890 and 1900; in England it only increased by about one-tenth. Slums are a much less conspicuous feature than in England because of the comparatively recent development of German towns, but where old quarters exist on a large scale, as in Hamburg, the conditions are quite as bad as anything in English towns, and call for similar measures. Public sanitation in Germany is still as a whole less advanced than in England; but in some cases it is superior and in general it is coming up rapidly; the administration of sanitary laws, as of others, is more effective and uniform, and less subject to evasion. This also contributes to the comparative absence of slums. And there is a third factor which has perhaps the greatest influence of all, and that is the superior manner in which German homes are kept. But the pressure of inadequate quantity is urgent; it has caused high rents, overcrowding, and the development of large barrack or block dwellings which are becoming the prevailing type. At the same time it has led to many and varied efforts to meet the difficulty. Isolated attempts go back to an early date. For instance a building society was formed in Berlin in 1849, Alfred Krupp began to build his "colonies" at Essen in 1863, Barmen started a society in 1871 and there were other cases; but general attention seems first to have been drawn to the subject by the reforming efforts of Pastor Bodelschwingh at Bielefeld about 1884 in connexion with his *Arbeiterheim*. In short housing reform in Germany is really a matter of the last 20 years. The first efficient by-laws for regulating building in Berlin were not adopted till 1887; the previous regulations dating from 1853 permitted many abuses and under them a great deal of bad housing was constructed, especially after the establishment of the empire and the beginning of the great development of the capital.

The worst feature is the general prevalence of dwellings containing a very small number of rooms—from 1 to 3—and consequent overcrowding. The following figures are extracted from the Report to the Board of Trade on Rents, Housing, &c., in Germany (1908, Cd. 4032). They indicate the proportion of dwellings containing 1, 2 or 3 rooms, or (in a few cases) the proportion of the population living in such dwellings. The towns are those for which the information is given. They are not selected as particularly bad specimens but as representative, and they include most of the capitals and chief industrial centres. The figures relate to the year 1906, except in a few cases, in which they are taken from a municipal house census in 1905.

Percentage of Dwellings or Population living in Dwellings containing

Town.	1 Room.	2 Rooms.	3 Rooms.	Total under 4 Rooms.
Berlin	8.0	37.2	30.6	75.8
Aachen	13.7	32.0	21.9	67.6
Barmen (pop.)	1.5	24.3	28.8	54.6
Bremen	3.8(?)	26.8	26.1	56.7 (?)
Breslau (pop.)	3.9	46.0	24.4	74.3
Chemnitz (pop.)	1.7	34.8	29.9	66.4
Dantzig	3.3	45.0	29.9	78.2
Dortmund	4.7	45.5	30.0	80.2
Dresden	0.8	3.5	27.8	32.1
Düsseldorf	5.0	26.4	22.7	54.1
Elberfeld	8.4(?)	36.9	21.7	67.0 (?)
Essen	2.9	35.4	30.0	68.3
Hamburg	1.0	3.9	24.7	29.6
Königshütte (pop.)	10.0	60.4	16.8	87.2
Leipzig (pop.)	0.4	1.7	14.5	16.6
Mannheim	3.1	22.1	49.4	65.6
Munich (pop.)	4.6	24.1	28.4	57.1
Plauen (pop.)	1.3	14.2	21.8	36.3

The figures must be read with a certain amount of caution, as they are not in every case compiled on a precisely uniform method with regard to inclusion of kitchens and attics. For this reason the position of Bremen and Elberfeld is probably more unfavourable than it ought to be. But broadly the table shows that in most of the large towns in Germany more than half, and in some cases more than three-quarters of the dwellings have less than 4 rooms. Leipzig is the most striking exception. If working-class quarters alone are taken it is found that dwellings of more than 3 rooms are so few as to be negligible. In Stuttgart, where housing is very dear, the

percentages for working-class quarters are—1 room 21.0, 2 rooms 51.8, 3 rooms 26.9; total under 4 rooms 98.7. Königshütte, the chief coal and iron centre in Silesia and a purely working-class town, shows the same state of things; 60% of the whole population live in dwellings of 2 rooms and 87% in less than four. It is interesting to compare English towns. The proportion of dwellings containing less than 4 rooms in London was (1901) 52.2% in Berlin 75.8%; the proportion of the population living in such dwellings was—London 38.7%, Berlin 71.5%. Not only is the proportion of small dwellings very much higher in Berlin but the proportion of the population living in them shows a far greater discrepancy. This indicates a much higher degree of overcrowding. The only point in which Berlin has the advantage is the smaller number of single-room dwellings. The proportions are London 14.7%, Berlin 8.0%. But it is to be observed that overcrowding is not so common in 1-room dwellings, which are often occupied by a single person, as in those with 2 or 3 rooms, which are occupied by families, though probably the most extreme cases of overcrowding occur in particular 1-room dwellings. In the English county boroughs the proportion of dwellings with less than 4 rooms was 24.0% in other urban districts 17.4, and in all urban areas including London 26.4%. When all allowance is made for minor errors and discrepancies it may be broadly concluded that the proportion of small dwellings containing less than 4 rooms is at least twice as great in German as in English towns, and that the conditions as to accommodation which in England prevail only in London are general in urban Germany. As a set-off German rooms are generally larger than English ones and in block dwellings there is often a little ante-room or landing which does not count but really increases the space.

The German census does not take cognisance of overcrowding and there is no general official standard; but some towns have adopted a standard of their own, namely, six or more persons to 1 room and ten or more to 2 rooms. In Breslau, which is one of the worst towns, 17.5% of the population (53,000) of the "city" or inner ring were overcrowded on this basis in 1900. In Barmen, which is not one of the worst, 20% of the 2-roomed and 17% of the 3-roomed dwellings (together housing more than half the population) were overcrowded according to the English standard. Overcrowding and other bad conditions are worst in the basement or cellar dwellings, of which some towns have a very large number. In Breslau 15,000 persons were living in 3853 such dwellings in 1900; in Berlin 91,426 persons were living in 24,088 basements. Some of these are free from objection, but 11,147, housing 38,663 persons, were situated in back buildings and unfit for habitation on account of darkness, damp, dilapidation and the like. "Back" houses are a feature of old towns; they are houses which do not give on the street but lie behind and are approached by a passage; they are what we call courts and quite as insanitary as anything of the kind in English towns.

With regard to rents the Board of Trade (London) Report gives the following figures for Berlin and a number of other towns:—

No. of Rooms per Dwelling.	Predominant Range of Weekly Rents.	
	Berlin.	Other Towns.
2 rooms	5/- to 6/-	2/8 to 3/6
3 rooms	7/- to 9/3	3/6 to 4/9
4 rooms		4/3 to 6/-

Rents are higher in Berlin than in any other town, though Stuttgart comes very near it. The following table of index numbers shows the relations of 32 towns to Berlin:—

Town.	Index Number.	Town.	Index Number.
Berlin	100	Nuremberg	53
Stuttgart	97	Aachen	53
Düsseldorf	79	Crefeld	52
Dortmund	68	Bremen	52
Anschaffenburg	67	Plauen	52
Hamburg	66	Leipzig	51
Mannheim	64	Dantzig	49
Königsberg	63	Mülhausen	48
Munich	63	Königshütte	47
Essen	62	Stettin	46
Solingen	61	Magdeburg	43
Bochum	57	Chemnitz	40
Elberfeld	57	Zwickau	38
Barmen	57	Brunswick	37
Remscheid	56	Stassfurt	33
Breslau	56	Oschersleben	28
Dresden	54		

Comparing rents in Germany and England, the Board of Trade Report gives the following table, to which the corresponding ratio of French towns has been added.

No. of Rooms.	Predominant Weekly Rents.		Ratio of German to English (100)	Ratio of French to English (100)
	England.	Germany.		
2 rooms . . .	3/- to 3/6	2/8 to 3/6	95	79
3 rooms . . .	3/9 to 4/6	3/6 to 4/9	100	86
4 rooms . . .	4/6 to 5/6	4/3 to 6/-	102	78

If the mean of the English and German figures be taken it shows a very slight difference in favour of Germany; the mean weekly rent per room being 1s. 5d. in England and 1s. 4½d. in Germany. But in England rent usually includes local taxation (rates) whereas in Germany it does not; if this be added German rents are to English as 123 to 100, or nearly one-fourth more.

The statistics given above indicate a wide range of variation in the conditions prevailing in different towns in Germany; and that holds good with regard to improvements. The administration of the laws relating to public health and housing is in the hands of the local authorities. The public health service is generally efficient and sometimes very good. Increasing attention has been paid in recent years to the sanitary inspection of houses and in some towns it is now thorough and systematic, but active efforts to deal with old and insanitary quarters *en masse* are isolated and exceptional. Hamburg is an instance; scared by the visitation of cholera in 1892 the authorities put in hand an extensive improvement scheme on the English plan at a cost of half a million sterling. But demolition is exceptional; slums are usually subjected to supervision and are not allowed to be in a state of dilapidation, and sometimes, as at Mannheim, notices are served to abate overcrowding. In Munich a policy of gradually buying up insanitary houses has been adopted. But improvement has principally been promoted by new building and the reduction of the population in old insanitary quarters, to which cheap locomotive facilities have greatly contributed. The great bulk of urban Germany is new, and the most valuable contribution made by it to the housing question is the more effective control of new building and particularly the principle of town-planning, coupled with the purchase of neighbouring ground with a view to future extension. This policy is comparatively recent and still very partially applied, but it is now rapidly extending. A general act providing for the planning of streets was passed in Prussia in 1875 and still forms the basis of building legislation; but as noted above no effective by-laws were adopted even in Berlin until after 1887, and consequently a very faulty style of building was adopted, especially in large blocks which conceal grave defects behind an imposing exterior. The Saxon towns have been conspicuously successful in regard to housing. Leipzig stands alone among German towns in having 83·4% of its population living in dwellings of 4 rooms and upwards. Yet it is a great commercial city, the fifth in the empire, with a population of upwards of half a million. It also comes low on the rent table, having an index number little more than half that of Berlin. All the Saxon towns are low, Chemnitz and Zwickau particularly so, and the position of Dresden, being a capital, is remarkable. More than two-thirds of the population live in dwellings of 4 rooms or more, and the rent index number is only 54. In Saxony a general Building Act, especially providing for town planning, was passed in 1900; and the Grand Duchy of Hesse, which alone among the German states has a government Housing Department, adopted a Housing of the Working Classes Act in 1902. Other states have followed or are following and the air is full of movement. The distinctive features of urban housing reform in Germany are (1) the systematic planning of extensions, (2) purchase of ground by municipalities, (3) letting or sale of municipal land for building under prescribed conditions. Many of the great towns, including Berlin, Munich, Dresden, Leipzig, Cologne, Frankfurt and Düsseldorf, are owners of land to a variable but sometimes large extent. This policy seems to have been originally adopted on economic grounds and those municipalities which bought or otherwise came into possession of town land at an early date derive a substantial revenue from it now, besides being in a position to promote housing improvement. There is comparatively little municipal building, and that as a rule only or principally for municipal servants, as at Düsseldorf, Mannheim and Nuremberg; but there seems to be a tendency to venture further in this direction and some towns have built houses for letting. The municipalities generally sell or let their land, and the building agencies which enjoy most official favour are the societies "of public utility"; they are encouraged in every way and have greatly developed, particularly in the Rhine province. Some are co-operative, others semi-philanthropic in that they aim at building good houses and limit their profits. In 1901 the Prussian Government issued an order urging municipalities to support these societies by remitting the cost of constructing streets and sewers, placing the assistance of building officials at their disposal, taking their shares, lending them money and becoming security for them. A great deal of public money has been advanced to building societies, and one very important source of supply has been developed, since the Old Age and Infirmary Insurance Act of 1889, in the National Insurance Funds which invest their surplus capital in this way. Down to 1906 the Boards of Insurance had lent £8,650,000 to societies for building;

the Imperial Government had lent £1,250,000, the Prussian Government £1,825,000, and the other states and municipalities further large sums in addition to the municipalities. Money lent by the state is usually limited to building houses for state employees and insurance Boards lend on condition that the houses are let to persons who come under the insurance law. The development of building societies has been promoted by the formation of general building associations of which

the earliest was established in Düsseldorf in 1897 for the Rhine provinces; under its influence one-fifth of the new housing provided in 1901 was erected by the societies. The example was followed at Frankfurt, Münster and Wiesbaden. Housing by employers has also been carried out on a large scale in Germany. States and municipalities have to some extent built houses as employers, the former chiefly for railwaymen, besides lending money to societies for the purpose; but most housing of this kind has been done by private employers. Krupp, who had built 4274 dwellings housing nearly 27,000 persons down to 1901, are the most famous example; but they are only one among many. In Rhineland and Westphalia employers had in 1902 provided 22,269 houses containing 62,539 dwellings at a cost of £10,500,000; more than half the families so housed belonged to the mining industry, the rest to various manufactures. These two provinces, in which industrial development has been extremely rapid, are exceptional; but housing by employers is not confined to them. At Mannheim for instance over 1000 working-class households have been so provided. At Nuremberg the Siemens Schuckert Company have encouraged an interesting system of collective building among their employees, by which 722 dwellings have been provided.

Holland.—In 1901 a Public Health and a Housing Act were passed, and these two embody most of the features of housing reform adopted in other countries. The first provides for a general sanitary service under the Ministry of the Interior. The second ordains that local authorities shall frame by-laws for building and for the maintenance and proper use of dwellings; that they shall inspect existing dwellings, order improvements or repairs or demolition; empower them to take land compulsorily for the purposes of the act, to prohibit building or rebuilding on sites reserved for public purposes and to make grants or loans to societies or companies operating exclusively for the improvement of working-class dwellings. If they fail to make by-laws the provincial authorities may take action. Land buying with a view to extensions has been adopted by a number of municipalities including Amsterdam, Rotterdam, Utrecht and other important towns, and the practice is increasing. Amsterdam has also begun the systematic planning of extensions. There has been a little municipal building in some small places, but it is on an insignificant scale; the tendency is rather to favour societies of public utility as in France, Germany and Belgium. The new laws are too recent to have had much effect and housing reform is as yet in an early stage. Rents are high in the large towns, namely, 1 room 1s. 8d. to 3s.; 2 rooms 2s. 6d. to 5s.; 3 rooms 3s. 6d. to 6s.; 4 rooms 4s. 2d. to 7s.

Italy.—A Housing of the Working Classes Act was passed in 1903, to promote the improvement and provision of workmen's dwellings. Municipalities have the power to purchase land compulsorily for housing purposes and also to build workmen's dwellings. A few towns, of which Milan is one, have done so. There are building regulations relating to the area and height of rooms and the thickness of walls. The antiquity of the Italian towns and the great quantity of old and insanitary building make housing improvement a very difficult matter. *Le Società Umiltaria*, a benevolent trust founded by Prosper Loria of Milan in 1902, has taken up this subject among others and has built two model tenements, housing 2000 persons.

United States.—Interest in the housing question in the United States is confined to a few of the largest cities and can only be said to be acute in New York, though there have been investigations by commissions elsewhere and Miss Octavia Hill's work in London has found admirers and imitators in Philadelphia and Boston as well as in New York. The evils of housing in New York have been the subject of much sensational writing which has elevated them to the position of a world-wide scandal. It is not necessary to accept all the allegations made in order to see that several circumstances have combined to produce an exceptional state of things in this great city. The limited space—the island or peninsula of Manhattan—in which central New York is built has compelled the erection of large tenement blocks, otherwise rare in American towns; the incessant inrush of immigrants from the poorest parts of Europe has filled these tenements with immense numbers of persons of many nationalities accustomed to a low standard of living; the generally backward state of public sanitation in America, and the absence of evasion of regulations and supervision, have permitted the erection of bad dwellings, their deterioration into worse, and their misuse by excessive overcrowding. Other large cities in which bad housing conditions are known to exist are Chicago, Philadelphia, Boston, Baltimore, Cincinnati, Pittsburg, Jersey City. There are doubtless many others, but bad housing conditions are not so general in the United States as in Europe. Outside the very large cities there is more space, more light and air, less crowding together, less darkness, dirt and dilapidation. Large houses, occupied by two or perhaps three

families, are common, but they have more room space than is usual in Europe. The 18th annual report (1903) of the Commissioner of Labour gives the result of a special inquiry embracing 23,447 families distributed in 33 states. The average number of rooms was 4.95 per family and 1.04 per individual. It is a fair inference that overcrowding is confined to a comparatively small number of exceptional places. A large number of the schedules were furnished by the eminently urbanized and manufacturing states of New York, Pennsylvania, Massachusetts, Ohio and Illinois; and in all these the average number of rooms to a family exceeded 4, ranging from 4.2 in Ohio to 5.5 in Massachusetts. The condition of homes as to sanitation and cleanliness was statistically stated thus: Sanitary condition—good 61.46 % fair 32.50 % bad 5.05 %; Cleanliness—good 79.63 % fair 14.66 % bad 5.71 %. Other special inquiries have been carried out in particular towns. In 1891-1892 the tenements in Boston were investigated for the Massachusetts Labour Bureau, which found 3657 sleeping rooms without outside windows and about 8 % of the population living in conditions objectionable from one cause or another. In 1892 Congress authorized a special inquiry into the slum population of New York, Chicago, Philadelphia and Baltimore, the results of which were published in the seventh special report (1894) of the United States Commissioner of Labour. It was estimated that the total "slum population" (presumably those living in unhealthy conditions) was—New York 360,000, Chicago 162,000, Philadelphia 35,000, Baltimore 25,000. In Baltimore 530 families, consisting of 1648 persons, were living in single rooms with an average of 3.15 persons to a room; in Philadelphia 401 families were so living with an average of 3.11 persons to a room. The proportion of 1-room dwellings was less in New York and Chicago. In New York 44.55 % or nearly half the families investigated were found living in 2-roomed dwellings, in Baltimore 27.88 %, in Philadelphia 19.41 % and in Chicago 19.14 %. These figures conclusively prove that European conditions reproduce themselves in American cities. Poverty was not the cause, as the average earnings per family ranged from \$3.48 a week in Baltimore to \$4.68 a week in Chicago. Another official investigation in New York was carried out in 1895 by the Tenement House Commission appointed by the State of New York. It reported "many houses in the city in an insanitary condition which absolutely unfit them for habitation." Further details have been compiled from the census by the New York Federation of Churches, chiefly relating to density of population in the city. In 1900, out of a total of nearly 250,000 dwellings, 95,433 (38.2 %) contained from 2 to 6 persons, 60,672 (24.2 %) from 7 to 10 persons and 89,654 (35.9 %) 11 persons or more. The density of population for the whole city as now constituted was 19 persons to the acre, in Manhattan 149; in the south-eastern district of Manhattan 382 and in one ward 735. Between 1900 and 1905 the density increased in every district, and in the latter year there were 12 blocks with from 1000 to 1400 persons to the acre. The number of persons to the acre in London (1901) is 60.6; in the most densely populated borough 182, and in the most densely populated district (a very small one) 396. This will give a measure of comparison. The large tenement blocks in New York have been constructed with far less regard to health than those in Berlin, and reproduce in an aggravated form the same evil of insufficient light and air. In place of the inadequate courts round which many are built in Berlin, the New York tenements have merely narrow air shafts. In 1904 there were reported to be 362,000 dark interior rooms, that is with no outside windows.

If American cities have nothing to learn from other countries in regard to bad housing, they have nothing to teach in the way of reform. They are following Europe slowly and a long distance behind. There is no serious attempt to deal with insanitary areas as they have been dealt with in England, or to prevent the creation of new ones by regulation and planning of extensions as in Germany, or to promote the provision of superior houses by organized public effort as in several countries. A little has been done in New York to improve the worst housing. A Tenement House Act was passed after the report of the Commission of 1895 and a Department formed to give effect to it. Some cleansing and repairing and insertion of windows is carried out every year, but more attention seems to be paid to fire escapes. Societies for providing improved dwellings exist in New York, Boston, Chicago and Philadelphia. The oldest is one formed in Boston in 1871, called the Co-operative Building Company; it was followed in 1876 by an Improved Dwellings Company in Brooklyn, and in 1879 by a similar society in Manhattan, and in 1885 by another in Boston. The largest concern of the kind is the City and Suburban Houses Company in New York, formed in 1896 under the guidance of Dr E. R. L. Gould; it has built four groups of tenements housing 1238 families in the city and 112 houses on a suburban estate at Brooklyn; in all it has housed some 6000 persons. More recently Mr Henry Phipps has given £200,000 for the provision of model dwellings in New York, and a building has been erected on the plan of the Maison des Enfants in Paris. In Chicago the City Houses Association works at housing reforms in various ways. There are some other institutions of a like kind, but the aggregate results are inconsiderable. Two other building agencies have done far more in the United States than philanthropic societies; these are the building and loan associations and private

employers. The former are co-operative provident societies; they are widely diffused throughout the United States and their operations are on a very large scale. They date from 1831, when the Oxford Provident Building Association was formed at Frankfort, near Philadelphia. Pennsylvania has still the largest number of associations, but from 1843 onwards the movement spread rapidly and continuously in other states. The high-water mark appears to have been reached in 1897, when the total assets of the associations amounted to about £133,000,000. In 1905 there were 3326 associations with an aggregate membership of 1,686,611 and assets of about £130,000,000. The states of Pennsylvania and Ohio head the list, but the movement is very strong in many others. It accounts for the comparatively large number of houses owned by working-class families in the United States. With regard to housing by employers, no comprehensive information is available, but the total amount is certainly considerable though probably not so large as in Germany or in France. Some of the better-known instances are the Pelzer Manufacturing Company at Pelzer in South Carolina, which has built about 1000 dwellings; the Maryland Steel Company at Sparrows Point, Maryland, 800 dwellings; Ludlow Manufacturing Associates at Ludlow, Mass., 500 dwellings; Whitin Machine Works at Whitinsville, Mass., 600 dwellings; Westinghouse Air Brake Co. at Wilmerding, Penn., 360 dwellings; Draper Co., Hopedale, Mass., 250 dwellings. These are all more or less "model" settlements, not in cities, but in outlying or country places, where works have been established, and that is generally true of housing by employers in the United States, whereas in Germany much has been provided by them in the large towns. Rents are very much higher in American cities than in European towns of comparable size and character.

AUTHORITIES.—Board of Trade Reports—"Cost of Living of the Working Classes (England)" (1908); "Cost of Living in German Towns" (1908); "Cost of Living in French Towns" (1909). *Proceedings of International Housing Congress* (London, 1907); *The New Encyclopaedia of Social Reform*; E. R. Dewnup, *The Housing Problem in England*; T. C. Horsfall, *The Example of Germany*; J. S. Nettelfold, *Practical Housing Reform*; A. Shadwell, *Industrial Efficiency*, ch. xi on "Housing"; W. Thompson, *The Housing Handbook, Housing up to Date*. (A. S.)

HOUSMAN, LAURENCE (1867–), English writer and artist, was born on the 18th of June 1867. Having studied at South Kensington, he first made a reputation as a book-illustrator. Some of his best pictorial work may be seen in the editions of Meredith's *Jump to Glory Jane* (1892), the *Weird Tales* of Jonas Lie (1892), Jane Barlow's *Land of Elfintown* (1894), Christina Rossetti's *Goblin Market* (1893), *Werewolf* (1896), by his sister, Miss Clemence Housman, Shelley's *Sensitive Plant* (1898), and his own *Farm in Fairyland* (1894). His designs were engraved on wood by Miss Housman. His volumes of verse include *Green Arras* (1896), *Rue* (1899), *Spikenard* (1898) and *Mendicant Rhymes* (1906); and the mysticism which characterizes the devotional poems in *Spikenard* recurs in his half-allegorical tales, *All Fellows* (1896), *The Blue Moon* (1904) and *The Cloak of Friendship* (1906). His nativity play, *Bethlehem*, was presented in the Great Hall of London University at South Kensington for a week in December 1902. In 1900 he published anonymously *An Englishwoman's Love Letters*, which created a temporary sensation; and he followed this essay in popular fiction by the novels *A Modern Antaeus* (1901) and *Sabrina Warham* (1904). On the 23rd of December 1904 his fantastic play *Prunella*, written in collaboration with Mr Granville Barker, was produced at the Court Theatre.

His brother, Alfred Edward Housman (b. 1859), an accomplished scholar, professor of Latin at University College, London, is known as a poet by his striking lyrical series, *A Shropshire Lad* (1896).

HOUSSAYE, ARSÈNE (1815–1896), French novelist, poet and man of letters, was born at Bruyères (Aisne), near Laon, on the 28th of March 1815. His real surname was Housset. In 1832 he found his way to Paris, and in 1836 he published two novels, *La Couronne de bleus* and *La Pêcheresse*. He had many friends in Paris, among them Jules Janin and Théophile Gautier, and he wrote in collaboration with Jules Sandeau. He produced art criticism in *L'Histoire de la peinture flamande et hollandaise* (1846), semi-historical sketches in *Mlle de la Vallière et Mme de Montespan* (1860) and *Galerie de portraits du XVII^e siècle* (1844); literary criticism in *Le Roi Voltaire* (1858) and his famous satirical *Histoire du quarante et unième fauleuil de l'Académie française* (1855); drama in his *Comédiennes* (1857), poetry in his *Symphonie des vingt ans* (1867), *Cent et un sonnets*

(1873), &c.; and novels, *Les Filles d'Ève* (1852) and many others. In 1849, through the influence of Rachel, he was entrusted with the administration of the Théâtre Français, a position he filled with unflinching tact and success until 1850, when he was made inspector-general of works of art. He died on the 26th of February 1896.

His *Confessions, souvenirs d'un demi-siècle* appeared in 1885-1891. See also J. Lemaitre, *Arsène Houssaye* (1897), with a bibliography.

His son, HENRY HOUSSAYE (1848-), the historian, was born in Paris. His early writings were devoted to classical antiquity, studied not only in books but on the actual Greek sites which he visited in 1868. He published successively *Histoire d'Aphelles* (1867), a study on Greek art, *L'Armée dans la Grèce antique* (1867); *Histoire d'Alcibiade et de la république athénienne depuis la mort de Périclès jusqu'à l'avènement des trente tyrans* (1873); *Papiers on Le Nombre des citoyens d'Athènes au V^{me} siècle avant l'ère chrétienne* (1882); *La Loi agraire à Sparte* (1884); *Le Premier Siège de Paris en 52 av. J.-C.* (1876), and two volumes of miscellanies, *Athènes, Rome, Paris, l'histoire et les mœurs* (1879), and *Aspasie, Cléopâtre, Théodora* (6th ed. 1889). The military history of Napoleon I. then attracted him. His first volume on this subject, called *1814* (1888), went through no fewer than forty-six editions. It was followed by *1815*, the first part of which comprises the first Restoration, the return from Elba and the Hundred Days (1803), the second part, Waterloo (1809), and the third part, the second abdication and the White Terror (1905). He was elected a member of the French Academy in 1895.

HOUSTON, SAM, or SAMUEL (1793-1863), American general and statesman, of Scotch-Irish descent, was born near Lexington, Virginia, on the 2nd of March 1793. His father, who had fought in the War of Independence, died in 1806, and soon afterward Samuel removed with his mother to the frontier in Blount county, Tennessee. When he was about fifteen his elder brothers obtained for him a place as clerk in a trader's store, but he ran away and lived with the Cherokee Indians of East Tennessee for nearly three years. On his return he opened a country school, and later attended a session or two of the Academy at Maryville. During the War of 1812 he served under Andrew Jackson against the Creek Indians, and his bravery at the battle of Tohopeka, in which he was disabled by several wounds, won promotion to a lieutenantcy. In 1817 he was appointed sub-agent in managing the business relating to the removal of the Cherokees from East Tennessee to a reservation in what is now Arkansas, but he was offended at a rebuke from John C. Calhoun, then secretary of war, for appearing before him in Indian garments, as well as at an inquiry into charges affecting his official integrity, and he resigned in 1818. He entered a law office in Nashville, and was admitted to the bar, and was soon elected a district attorney. From 1823 to 1827 Houston represented the ninth district of Tennessee in Congress, and in 1827 was elected governor of the state by the Jackson Democrats. He married Eliza Allen in January 1829; his wife left him three months later, and he resigned his office of governor, again took up his residence among the Cherokees, who were at this time about to remove to Indian Territory, and was formally adopted a member of their nation.

In 1830 and again in 1832 he visited Washington to expose the frauds practised upon the Cherokees by government agents, and attracted national attention by an encounter on the 13th of April 1832 with William Stanberry, a Congressman from Ohio, who intimated that Houston himself was seeking to defraud them. Commissioned by President Jackson, Houston went to Texas in December 1832 to negotiate treaties with the Indian tribes there for the protection of American traders on the border. He decided to remain in Texas, and was elected a delegate to the constitutional convention which met at San Felipe on the 1st of April 1833 to draw up a memorial to the Mexican Congress asking for the separation of Texas from Coahuila, in which the anti-American party was in control, as well as to frame a constitution for the commonwealth as a new member of the Mexican

Republic, and he served as chairman of the drafting committee, and took a prominent part in the preparations for war when next year the petition was refused. In October 1835, soon after the outbreak of the War for Texan Independence, the committees of the township of Nacogdoches chose Houston as commander-in-chief of the forces in eastern Texas, and after the San Felipe convention in November he was chosen commander-in-chief of the Texan army. On the 21st of April 1836, while in command of 743 raw troops, he met on the bank of the San Jacinto about 1600 Mexican veterans led by Santa Anna and completely routed them; on the next day Santa Anna was taken prisoner.

Texan independence was won by this victory (although the Mexican government repudiated the treaty negotiated by Santa Anna), and Houston was elected president of Texas (1st of September) and was inaugurated on the 22nd of October. His term expired in December 1838; he was elected again in 1841 and served until 1844. During his first term a newly founded city was named in his honour and this was the seat of government in 1837-39 and in 1842-45. Texas having been admitted as a state of the American Union in 1845, Houston was elected one of its first two United States senators. He served as a stalwart Union Democrat from March 1846 until 1859; he opposed the Kansas-Nebraska bill in an able speech (3rd March 1854), and spoke frequently in defence of the rights of the Indians. In 1859 he was elected governor of Texas and tried to prevent the secession of his state; upon his refusal, in March 1861, to swear allegiance to the Confederacy he was declared deposed. He died at Huntsville, Texas, on the 26th of July 1863. Houston was an able soldier, wary, intrepid and resolute; and was a legislator of rare foresight, cool discrimination and fearless candour.

See A. M. Williams, *Sam Houston and the War of Independence in Texas* (Boston, 1893); Henry Bruce, *Life of General Houston* (New York, 1891); and W. C. Crane, *Life and Selected Literary Remains of Sam Houston* (Philadelphia, 1884).

HOUSTON, a city and the county-seat of Harris county, Texas, U.S.A., at the head of deep-sea navigation on Buffalo Bayou, a tributary of Galveston Bay, 50 m. N.W. of Galveston, and about 325 m. W. of New Orleans. Pop. (1880) 16,513; (1890) 27,557; (1900) 44,633, of whom 4415 were foreign-born and 14,608 were negroes; (1910 census) 78,800. The land area in 1906 was 16.02 sq. m.; in 1908, about 20 sq. m. It is served by the Galveston, Harrisburg & San Antonio (Southern Pacific), the Galveston, Houston & Henderson, the Gulf, Colorado & Santa Fé, the Houston & Texas Central (Southern Pacific), the Houston, East & West Texas, the International & Great Northern, the Missouri, Kansas & Texas, the San Antonio & Aransas Pass, the Trinity & Brazos Valley, the St Louis, Brownsville & Mexico, the Texas & New Orleans, and the Houston Belt & Terminal railways, several of which have their headquarters at Houston. The Federal government has greatly improved the natural channel from the city to the Gulf of Mexico, straightening, widening and deepening it to a depth of 25 ft. for the entire distance from the Galveston jetties to the Houston turning basin—where the municipality has constructed free municipal wharves. The city occupies an unusually fine site on both sides of the Buffalo Bayou. Among the principal buildings are a Carnegie library, the Houston Lyceum, the Federal building, the Masonic temple, the city high school, the city hall and market house, the Harris County Court House, the Cotton Exchange, and the First and Commercial National banks. Houston is the seat of the Texas Dental College, of St Thomas College (1903), and of the Houston, Annunciation and St Agnes academies; and the will (1901) of William Marsh Rice provided an endowment (valued in 1908 at about \$7,000,000) for the William M. Rice Institute for the Advancement of Literature, Science and Art, of which Dr Edgar Odell Lovett, formerly professor of mathematics (1900-1905) and of astronomy (1905-1908) in Princeton University, was made president in 1908. The city is the most important railway and shipping centre of South Texas, and has a large trade in cotton (the receipts for the year ending Aug. 31, 1907 being 2,967,535 bales), cotton-seed

oil, sugar, rice,¹ lumber and citrus fruits. Houston is important also as a manufacturing centre, its factory product being valued at \$13,564,019 in 1905, an increase of 81% over the factory product in 1900. There are extensive railway car-shops, cottonseed oil, petroleum and sugar refineries, cotton gins and compresses, steel rolling mills, car-wheel factories, boiler, pump and engine works, flour mills, rice mills and a rice elevator, breweries, planing and saw-mills, pencil factories, and brick and tile factories. Its proximity to the Texas oil fields gives the city a cheap factory fuel. The assessed valuation of taxable property in the city increased from \$27,480,898 in 1900 to \$51,513,615 in 1908. The No-Tsu Oh Carnival week each November is a distinctive feature of the city. Houston, like Galveston, adopted in 1905 a very successful system of municipal government by commission, a commission of five (one of whom acts as mayor) being elected biennially and having both executive and legislative powers. The waterworks are owned and operated by the municipality, which greatly improved them from the city's surplus under the first two years of government by commission. In 1908 extensive improvements in paving, drainage and sewerage were undertaken by the city. The payment of an annual poll-tax of \$2.50 is a prerequisite to voting. Houston was settled and laid out in 1836, and was named in honour of General Sam Houston, whose home in Caroline Street was standing in 1908. In 1837-1839 and in 1842-1845 Houston was the capital of the Republic of Texas. About 15 m. E.S.E. of the city is the battleground of San Jacinto, which was bought by the state in 1906 for a public memorial park.

HOUWALD, CHRISTOPH ERNST, FRIEDRICH VON (1778-1845), German dramatist and author, was born at Straupitz in Lower Lusatia, a son of the president of the district court of justice, on the 28th of November 1778. He studied law at the university of Halle, and on completion of his academic studies returned home, married, and managed the family estates. In 1816 he afforded a home to his friend K. W. S. Contessa (1777-1825), himself a poet, who had met with serious reverses of fortune; Contessa lived with Houwald, assisting and stimulating him in his literary work, for eight years. In 1821 Houwald was unanimously elected syndic for Lower Lusatia, an office which placed him at the head of the administration of the province. He died at Neuhaus, near Lübben, on the 28th of January 1845.

Houwald is remembered as the author of several so-called "Fate tragedies" (see GERMAN LITERATURE), of which the best known are *Das Bild, Der Leuchtturm, Die Heimkehr, Fluch und Segen* (all published in 1821). They have, however, small literary value, and Houwald is seen to better advantage in his narratives and books for juvenile readers, such as *Romanische Akkorde* (publ. by W. Contessa, Berlin, 1817); *Buch für Kinder gebildeter Stände* (1819-1824); and *Jakob Thau, der Hofnarr* (1821). Houwald's collected works, *Sämtliche Werke*, were published in five volumes (Leipzig, 1851; 2nd ed., 1858-1859). See J. Minor, *Die Schicksalstragödie in ihrem Hauptvertreter* (Frankfurt, 1883), and *Das Schicksalsdrama in Kürschner's Deutsche Nationalliteratur*, vol. cii. (Stuttgart, 1884); O. Schmidtborn, *C. E. von Houwald als Dramatiker* (1909).

HÔVA, the name originally applied to the middle-class Malayo-Indonesian natives of Madagascar (*q.v.*), as distinct from the noble class *Andriana* and the slave class *Androvo*. Hôva has now come to mean the most numerous and powerful of the tribes which form the native population of Madagascar. The Hôva, who occupy the province of Imérina, the central plateau of the island, are of Malayo-Indonesian origin. The period at which the Hôva arrived in Madagascar is still a subject of dispute. Some think that the immigration took place in very early times, before Hinduism reached the Malay Archipelago, since no trace of Sanskrit is found in Malagasy. Others believe that the Hôva did not reach the island until the 12th or 13th century. At the French conquest of Madagascar (1895), the Hôva were the most powerful and, politically, the dominant people; but were far from having subjected the whole of the island to their rule. The Hôva are short and slim, with a complexion of a yellowish olive, many being fairer than the average of southern Europeans. Their hair is long, black and smooth but coarse. Their heads

¹ Much rice is cultivated in the vicinity of Houston by Japanese farmers.

are round, with flat straight foreheads, flat faces, prominent cheekbones, small straight noses, fairly wide nostrils, and small black and slightly oblique eyes. The physical contrast to the negro is usually very obvious, but, especially among the lower classes, there is a tendency to thick lips, kinky hair and dark skin. In many of their customs, such as taboo, infanticide, marriage and funeral rites, they show their Indonesian origin. Most of them now profess Christianity.

HOVE, a municipal borough of Sussex, England, adjoining the watering-place of Brighton on the west, on the London, Brighton, & South Coast railway. Pop. (1901) 36,535. The great seawall of Brighton continues along the front at Hove, forming a pleasant promenade. Here is the Sussex county cricket ground. The municipal borough, incorporated in 1898, includes the parishes of Hove and Aldrington, of which the first is within the parliamentary borough of Brighton, but the second is in the Lewes division of the county. The corporation consists of a mayor, 10 aldermen and 30 councillors. Area, 1,521 acres.

HOVENDEN, THOMAS (1840-1895), American artist, was born in Dunmanway, Co. Cork, Ireland, on the 28th of December 1840. He was a pupil of the South Kensington Art Schools and those of the National Academy of Design, New York, whither he had removed in 1863. Subsequently he went to Paris and studied in the Ecole des Beaux Arts under Cabanel, but passed most of his time with the American colony in Brittany, at Pont-Aven, where he painted many pictures of the peasantry. Returning to America in 1880, he became an academician in 1882, and attracted attention by an important canvas of "The Last Moments of John Brown" (now in the Metropolitan Museum of Art). His "Breaking Home Ties," a picture of American farm life, was engraved with considerable popular success. Hovenden was mortally injured in a heroic effort to save a child from a railroad train in the station at Germantown, near Philadelphia, and died at Norristown, Pennsylvania, on the 14th of August 1895. Among his principal works are:—"News from the Conscript" (1877), "Loyalist Peasant Soldier of La Vendée" (1879), "A Breton Interior," "Image Seller" and "Jerusalem the Golden" (in the Metropolitan Museum of Art).

HOW, WILLIAM WALSHAM (1823-1897), English divine, son of a Shrewsbury solicitor, was born on the 13th of December 1823, and was educated at Shrewsbury school and Wadham College, Oxford. He was ordained in 1846, and for upwards of thirty years was actively engaged in parish work at Whittington in Shropshire and Oswestry (rural dean, 1860). He refused preferment on several occasions, but his energy and success made him well known, and in 1879 he became a suffragan bishop in London, under the title of bishop of Bedford, his province being the East End. There he became the inspiring influence of a revival of church work. He founded the East London Church Fund, and enlisted a large band of enthusiastic helpers, his popularity among all classes being immense. He was particularly fond of children, and was commonly called "the children's bishop." In 1888 he was made bishop of Wakefield, and in the north of England he continued to do valuable work. His sermons were straightforward, earnest and attractive; and besides publishing several volumes of these, he wrote a good deal of verse, including such well-known hymns as "Who is this so weak and helpless," "Lord, Thy children guide and keep." In 1863-1868 he brought out a *Commentary on the Four Gospels*; and he also wrote a *Manual for the Holy Communion*. In the movement for infusing new spiritual life into the church services, especially among the poor, How was a great force. He died on the 10th of August 1897. He was much helped in his earlier work by his wife, Frances A. Douglas (d. 1887).

See his *Life* by his son, F. D. How (1898).

HOWARD (FAMILY). Among English families, the house of Howard has long held the first place. Its head, the duke of Norfolk, is the first of the dukes and the hereditary earl marshal of England, while the earls of Suffolk, Carlisle and Effingham and the Lord Howard of Glossop represent in the peerage its younger lines.

Its founder was a Norfolk lawyer, William Howard or Haward,

who was summoned to parliament as a justice in 1295, being appointed a justice of the common pleas in 1297. Over the parentage of this man genealogists have disputed for centuries. The pedigree-makers have hailed him in turn as the descendant of a Norman "Auber, earl of Passy" and as the heir of Hereward, "the last of the English." But out of the copies of Norfolk deeds and records collected for Thomas, earl of Arundel, in the early part of the 17th century, it seems clear enough that he sprang from a Norfolk family, several of whose members held lands at Wiggenhall near Lynn. These notes from deeds, evidently collected by an honest inquirer, make no extravagant claims of ancient ancestry or illustrious origin for the Howards, although the facts contained in them were recklessly manipulated by subservient genealogists. Doubtless the judge was the son of John Howard of Wiggenhall, living about 1260, whose widow Lucy, called by the genealogists the daughter of John Germund, was probably the wife of John Germund by her second marriage. William Howard was employed as counsel by the corporation of Lynn, and it is worthy of note that the "crosslets fitchy" in his shield of arms suggest the cross with which the dragon was discomfited by St Margaret, the patroness of Lynn. Prospering by the law, William Howard of Wiggenhall rose to knight's rank and acquired by purchase Grancourt's manor in East Winch, near Lynn, where he had his seat in a moated house whose ruins remain. He was probably dead and buried in his chapel at East Winch before November 27, 1308, the date of the patent by which Henry Scrope succeeded him as a commissioner of trailbaston. His two wives, Alice Ufford and Alice Fitton—heir of Fitton's manor in Wiggenhall—were both daughters of knightly houses. Before his death his eldest son, John Howard, was a knight and already advanced by his marriage with Joan of Cornwall, one of the bastard line founded by Richard of Cornwall, king of the Romans.

Sir John Howard served in Edward II.'s wars in Scotland and Gascony, was sheriff of Norfolk and Suffolk and governor of Norwich Castle. When he died in 1331 he was seised of many Norfolk manors. His son and heir, another Sir John, admiral of the king's navy in the north, was a banneret who displayed his banner in the army that laid siege to Calais. By the admiral's wife Alice, sister and heir of Sir Robert de Boys, the Howards had the Boys manor of Fersfield, near Diss, which is still among the possessions of the dukes of Norfolk. His son Sir Robert Howard, who had married a daughter of Sir Robert Scales (Lord Scales), died in 1388. From Sir John Howard, the only son of Sir Robert, two branches of the house of Howard spring. The elder line was soon extinct. By his first wife, Margaret, daughter and heir of Sir John Plays, Sir John Howard had a son who died before him, leaving a daughter through whom descended to her issue, the Veres, earls of Oxford, the ancient Norfolk estates of the Howards at East Winch and elsewhere, with the lands of the houses of Scales, Plays and Walton, brought in by the brides of her forefathers. After the death of Margaret Plays, her widower found, with the peculiar instinct of his race, a second well-endowed wife. By her, the heir of the Tendrings of Tendring, he had a second son, Sir Robert Howard, a knight who fought under Henry V. in France, and died, like his half-brother, before the old knight's career ended in 1436.

It is to the marriage of this young knight that the house of Howard owes the tragedy of its greatness. He was a younger son, although he had some of his mother's inheritance. Had he married the landless daughter of a neighbour he might have been the ancestor of a line of Essex squires, whose careers would have had the parish topographer for chronicler. But his bride was Margaret Mowbray, daughter of the banished duke of Norfolk. Although this was a noble alliance, it is probable that the lady had no great portion. The head of her elder brother, the boy earl marshal, had been stricken off in the cornfield under the walls of York, but her younger brother's right to his father's dukedom was allowed by parliament in 1425.

Sir John Howard, only son of the match between Howard and Mowbray, took service with his cousin the third duke of Norfolk, who had him returned as knight of the shire for Norfolk,

where, according to the *Paston Letters*, this Howard of the Essex branch was regarded by the gentry as a strange man. He followed the White Rose and was knighted at the crowning of King Edward IV., who pricked him for sheriff of Norfolk and Suffolk. In the duke's quarrel he brawled with the Pastons, his wife boasting that, should her husband's men meet with John Paston "there should go no penny for his life." "And Howard," writes Clement Paston, "hath with the king a great fellowship." Offices and lands came to John Howard by reason of that fellowship. Henry VI., when restored, summoned him to parliament in 1470 as Lord Howard, a summons which may have been meant to lure him to London into Warwick's power, but he proclaimed the Yorkist sovereign on his return and fought at Barnet and Tewkesbury. When peace was made, Edward summoned him again as a baron and gave him the Garter and the treasurership of his household. After Edward's burial, at which he bore the king's banner, Howard, an enemy of the Wydviles, linked his fortunes with those of the duke of Gloucester. At this time came his sudden lifting to the highest rank in the peerage. The last of the dukes of Norfolk had left a child heir, Anne Mowbray, married to the infant duke of York, the younger of the princes doomed by Richard in the Tower. By the death of this little girl, John Howard became one of the coheirs of her illustrious house, which was now represented by the issue of Margaret Mowbray, his mother, and of her sister Isabel, who had married James, Lord Berkeley. A lion's share of the Mowbray estates, swollen by the great alliances of the house, heir of Brocouse and Segrave, and, through Segrave, of Thomas of Brotherton, son of Edward I., fell to Howard, who, by a patent of June 28, 1483, was created duke of Norfolk and earl marshal of England with a remainder to the heirs male of his body. On the same day the lord Berkeley, the other coheir, was made earl of Nottingham. High steward at Richard's crowning, the duke bore the crown and rode as marshal into Westminster Hall. For the rest of his life he was Richard's man, and though warned by the famous couplet that "Dykon his master" was bought and sold, "Jack of Norfolk" led the archer vanguard at Bosworth and died in the fight, from which his son the earl of Surrey was carried away a wounded prisoner. An attainder by the first parliament of Henry VII. extinguished the honours of the father with those of the son, who had been created an earl when the lord Howard was raised to the dukedom. Their estates were forfeit.

Thomas Howard, a politic mind, loyal to the powers that be, was released from the Tower of London in 1489, his earldom of Surrey and his Garter restored. Accepting the position in which the Tudor king would have his great nobles, he became the faithful soldier, diplomatist and official of the new power. In his seventieth year, as lieutenant-general of the North, he led the English host on the great day of Flodden, earning a patent of the dukedom of Norfolk, dated 1 February 1513-4, and that strange patent which granted to him and his heirs that they should bear in the midst of the silver bend of their Howard shield a demi-lion stricken in the mouth with an arrow, in the right colours of the arms of the king of Scotland. This augmentation has been interpreted as a golden scoccheon with the demi-lion within the Scottish tressure. Thus charged on the silver bend, it makes bad armory and it is worthy of note that, although the grant of it is clearly to the duke and his heirs in fee simple, Howards of all branches descending from the duke bear it in their shields, even though all right to it has long passed from the house to the duke's heirs general, the Stourtons and Petres.

The victor of Flodden is the common ancestor of all living Howards that can show a descent from the main stock. The second duke, twice married, was father of at least eleven sons and six daughters, the sons including Edward the lord high admiral, killed in boarding Prégent's galleys at Brest, Edmund the knight marshal of the army at Flodden, and William the first Lord Howard of Effingham. The eldest son, Thomas, succeeded as the third duke of his name, although the second under the patent of 1514. He had fought as captain of the

vanguard at Flodden and after the victory was created earl of Surrey. When Richard III. was allying himself with the Howards, Thomas Howard, a boy of eleven, had been betrothed to Anne, daughter of the late King Edward IV., and Henry VII. allowed the marriage with his queen's sister to take place in 1495. This royal bride died of consumption, leaving no living child, and her husband took in 1513, as his second wife, Elizabeth Stafford, daughter of that duke of Buckingham upon whom the old duke of Norfolk, the tears upon his cheeks, was forced to pass sentence of death. Succeeding his father in 1524, Norfolk was created earl marshal in 1533. An unsuccessful diplomatist, his chief services in arms were the butchery in the north after the Pilgrimage of Grace and the raid into Scotland which ended with the rout of Solway Moss. He left his wife for a mistress, Elizabeth Holland, was in discord with his family, and lived to see his two nieces, Anne Boleyn and Catherine Howard, and his son Surrey, the fiery-tempered poet, go in turn to the block. He himself was attainted and was lying a prisoner in the Tower, doomed to die in the morning, on the night of the death of Henry VIII. He was not released until the accession of Mary, parliament restoring his dukedom on his petition for reversal of the attainder. His grandson Thomas succeeded him in 1554, and in 1556 made the second of those marriages which have given the Howards their high place among the English nobility. The bride was Mary, sole heir in her issue of her father Henry, the last of the Fitzalan earls of Arundel. Her father's line and the royal Stewards of Scotland sprang from one forefather, Alan, son of Flaald the Breton. The Mowbray match had already brought to the Howards the representation of an elder line of the Fitzalan earls, who sat in the seats of their ancestors, the Aubignys and Warrennes, great earls near akin to their sovereigns. And now the younger line, earls of Arundel and Lords Mautravers, were also to have a Howard to represent them. From this time the spreading genealogy of the Howards drew its origins from most of the illustrious names of the houses founded after the Norman Conquest.

The young duchess died in her seventeenth year after giving birth to a son, and the duke took a second wife from a humble stock, newly enriched and honoured, the daughter of Henry VIII.'s subservient chancellor, the Lord Audley of Walden. Within ten years he married a third time, the lady being Elizabeth Leybourne, the widow of Lord Dacre of Gilsland. She survived her marriage but a few months and her husband then obtained the wardship of her Dacre offspring, a son who died young, and three daughters whom the duke, with the true Howard eye for a rich inheritance, gave as brides to three of his sons. After three such good fortunes by marriage Norfolk in his folly looked for a crown with a fourth match, listening to the laird of Lethington when he set forth the scheme by which the duke was to marry a restored queen of Scots and rule Scotland with her who should be recognized as Elizabeth's successor. Ten months in the Tower under strong suspicion would have warned another man, but Norfolk was unstable and false. After promising fidelity and the abandonment of the Scots marriage scheme, Cecil took him corresponding with Mary and tampering with the Ridolfi plot. He died on Tower Hill in 1572 for an example to the disloyal counties, protesting innocence and repentance, warning his children in a last letter to discredit all "false bruits" that he was a papist.

By his attainder the Norfolk titles were once more forfeited. But Philip Howard, the son and heir, succeeded to the ancient earldom of Arundel in 1580, on the death of his maternal grandfather, while the Lord Lumley, his uncle by marriage, surrendered to him his life interest in the castle and honour of Arundel. The next year an act of parliament restored the earl in blood. After a profligate youth at court, he followed his wife in professing the Roman faith, and in 1585 made an attempt to leave England to seek safety from the penal laws. But his ship was boarded in the Channel and the earl, condemned by the Star-Chamber to a heavy fine and to imprisonment during the queen's pleasure, suffered a harsh captivity in the Tower. After the defeat of the Armada he had been condemned to death on a

charge of high treason, founded on the tale drawn by torture from a priest, that Arundel had urged him to say a mass for the success of the Spaniards. But he was allowed to linger in his prison until 1595 when he died, the sight of his wife and children being cruelly refused to the dying man. Thus it befell that, of the chiefs of the Howards born since the great Mowbray alliance, two had died by the axe and one in the prison from which a fourth had hardly escaped. A fifth had fallen in a lost battle, and only one had died in peace in his own house.

The ill fate of the Howards seemed to be appeased by the death of Philip, earl of Arundel. Tudor policy did its work well, and noblemen, however illustrious their pedigrees, could no longer be counted as menaces by the Crown, which was, indeed, finding another rival to its power. In the first year of James I., Thomas, the young son of Earl Philip, was restored in blood and given the titles of Arundel and Surrey. But the lands belonging to these titles remained with the Crown and he had to repair his fortunes by one of those marriages which never failed his house, his wife being Alathea Talbot, who was at last the heir of Gilbert, earl of Shrewsbury. To the grief of his mother he left the Roman church. A knight of the Garter, he was in 1621 created earl marshal for life, and revived the jurisdiction belonging to the office. An act of 1627, one of several such aimed at aggrandizing families by diverting the descent of dignities in fee from heirs general, entailed the earldom and castle of Arundel upon Thomas, earl of Arundel and Surrey and the heirs male of his body "and for default of such issue, to the heirs of his body." His pride and austerity made him unpopular at court and he left the country in 1642, settling at last in Padua, where he died in 1646, impoverished by the sequestrations of the parliament, whose forces had taken and retaken his castle of Arundel. In answer to his petition for the dukedom, the king had, on the 6th of June 1644, given him a patent of the earldom of Norfolk, in order, as it would seem, to flatter him by suggesting that the title of Norfolk would at least be refused to any other family. He is celebrated as a collector of paintings, books, gems and sculptures, his "Arundel marbles" being given by his grandson in 1667 to the University of Oxford. The dukedom for which Arundel had petitioned Charles I. in vain was restored by act of the first parliament of Charles II. to his grandson Thomas, a lunatic living at Padua, on whose death in 1677 it passed to this Thomas's brother, Henry Frederick, who had been created earl of Norwich and hereditary earl marshal of England in 1672. In 1777 Edward, the ninth of the Howard dukes, died childless in his ninety-second year. With him ended the earldom of Norwich, while the representation of the Mowbrays and Segraves passed to his nieces, the Ladies Stourton and Petre, the abeyance of the two baronies being determined in 1878 in favour of Lord Stourton. Under the act of 1627 the earldom of Arundel and the castle passed with the dukedom to a second cousin, Charles Howard of Greystock (d. 1786), an eccentric recluse. At his death in 1786 he was succeeded by his son Charles, the notorious "Jockey of Norfolk," the big, coarse, generous, slovenly, hard-drinking Whig of whom all the memoir-writers of his age have their anecdotes. He conformed to the Church of England and spent a vast sum in restoring Arundel Castle. A third cousin succeeded him in 1815, Bernard Edward Howard, who, although a Roman Catholic, was enabled, by the act of 1824, to act as earl marshal. This was the grandfather of the fifteenth duke, earl of Arundel, Surrey and Norfolk, and hereditary earl marshal of England.

The eldest of the cadet branches of the ducal house has its origin in William (c. 1510-1573), eldest son of the victor of Flodden by his second marriage. He survived the reign of Henry VIII., that perilous age for the Howards, with no worse misadventure than the conviction of himself and his wife of misprision of treason in concealing the offences of his niece, Queen Catherine. But both were pardoned. In 1553 he had the office of lord admiral of England, and in the next year the Garter. For his services against Sir Thomas Wyatt he was created (March 11, 1553/4) Lord Howard of Effingham, the title being taken from a Surrey manor granted him by Edward VI. Queen Elizabeth continued his employment in diplomacy, and had he been richer he might have had an earldom. His eldest son Charles (1536-1624), lord admiral of England in 1585, sailed as

commander in chief against the Spanish Armada, and, although giving due weight to the counsel of Drake and his other officers, showed himself a leader as prudent as courageous. He was created earl of Nottingham in 1596 and died in 1624. The legend that the admiral was a Roman Catholic has no authority. Two of his sons succeeded in turn to the earldom of Nottingham, extinct on the death of Charles, the third earl in 1681. Sir William Howard of Lingfield, younger brother of the great admiral, carried on the Effingham line, his great-grandson succeeding to the barony on the extinction of the earldom. Francis, seventh Lord Howard of Effingham, was created earl of Effingham in 1731, a title extinct in 1816 with the fourth earl, but revived again in 1837 for the eleventh baron, who had served as a general officer in the Peninsular campaign, the great-grandfather of the present peer.

A patent of 1604 created Henry Howard (1540-1614), younger son of Surrey the poet, earl of Northampton, a peerage which ended with the death of this, the most unprincipled of his house.

Thomas, son of the fourth duke of Norfolk's marriage with the daughter and heir of Thomas, Lord Audley of Walden, founded the line of the present earls of Suffolk and Berkshire and of the extinct Lords Howard of Escrick. His barony of Walden was descended to his heirs general. Lord William Howard (1563-1640), the "belted Will" of Scott's *Lay* and the "bald Willie" of more authentic legend, was another of the sons of the fourth duke and Margaret Audley. Married in 1577 to one of the three co-heirs of the Lord Dacre of Gilsland he suffered under Elizabeth more than one imprisonment with his brother the unfortunate earl of Arundel. But in 1603 he was able, on the partition of the Dacre lands, to make his home at Naworth Castle, where he lived, a border patriarch, cultivating his estates and serving as a commissioner of the borders. His great-grandson Charles Howard, although fledged in a nest of cavaliers, changed sides and fought at Worcester for the parliament. The Protector summoned him in 1657 to his House of Lords, but he was imprisoned in 1659 on suspicion of a share in Booth's insurrection and, after the Restoration, was created, in 1661, earl of Carlisle, Viscount Morpeth and Lord Dacre of Gilsland, titles which are still held by his descendants. From Sir Francis Howard, a cavalier colonel and a younger son of "bald Willie," come the Howards of Corby Castle in Cumberland, a branch without a hereditary title.

William Howard, Viscount Stafford, was the fifth son of Thomas, earl of Arundel, and grandson of Philip the prisoner. Marrying the sister and heir of the fifth Lord Stafford, who died in 1637, he and his wife were created Baron and Baroness Stafford by a patent of 1640, with remainder, in default of heirs male, to heirs female. A grant of the precedence enjoyed by the bride's father being held illegal, her husband was in the same year created Viscount Stafford. Roger Stafford, the impoverished heir male of the ancient Staffords, had been forced to surrender his barony to the king by a deed dated in the preceding year, a piece of injustice which is in the teeth of all modern conceptions of peerage law. The Viscount Stafford was one of the "five Popish lords" committed to the Tower in 1678 as a result of the slanders of Titus Oates and he died by the axe in 1680 upon testimony which, as the diarist Evelyn protested, "should not be taken against the life of a dog." But three earls of his own house—Carlisle, Suffolk and Berkshire—and the Lord Howard of Escrick, an ex-trooper of Cromwell's guard and an anabaptist sectary, gave their votes against him, his nephew Mowbray being the only peer of his name in the minority for acquittal. In 1688 his widow was created countess of Stafford for life, and his eldest son, Henry, had the earldom of Stafford, with special remainder to his brothers. This earldom ended in 1762, but the attainder was reversed by an act of 1824 and in the following year Sir George Jerningham, the heir general, established his claim to the Stafford barony of 1640.

AUTHORITIES.—State papers; patent, close and plea rolls. Tierney, *History of Arundel*; C. E. C., *Complete Peerage*; J. H. Round, *Peerage Studies*; Howard of Corby, *Memorials of the Family of Howard*; Brenan and Statham, *House of Howard*; Howard, *Historical Anecdotes of the Howard Family*; Morant, *Essex*; Blomefield, *Norfolk*.

HOWARD, CATHERINE (d. 1542), the fifth queen of Henry VIII., was a daughter of Lord Edmund Howard and a granddaughter of Thomas Howard, 2nd duke of Norfolk (d. 1524). Her father was very poor, and Catherine lived mainly with Agnes, widow of the 2nd duke of Norfolk, meeting the king at the house of Stephen Gardiner, bishop of Winchester. Henry was evidently charmed by her; the Roman Catholic party, who disliked the marriage with Anne of Cleves, encouraged his attentions; and after Anne's divorce he was privately married to Catherine at Otlands in July 1540. Soon afterwards she was publicly acknowledged as queen. Before her marriage Catherine had had several lovers, among them being a musician, Henry Mannock, or Manox; her cousin, Thomas Culpepper; and Francis Dereham, to whom she had certainly been betrothed.

After becoming queen she occasionally met Dereham and Culpepper, and in November 1541 Archbishop Cramer informed Henry that his queen's past life had not been stainless. Cramer had obtained his knowledge indirectly from an old servant of the duchess of Norfolk. Dereham confessed to his relations with Catherine, and after some denials the queen herself admitted that this was true, but denied that she had ever been betrothed to Dereham, or that she had misconducted herself since her marriage. Dereham and Culpepper were executed in December 1541 and their accomplices were punished, but Catherine was released from prison. Some fresh information, however, very soon came to light showing that she had been unchaste since her marriage; a bill of attainder was passed through parliament, and on the 13th of February 1542 the queen was beheaded.

See A. Strickland, *Lives of the Queens of England* (vol. iii. 1877).

HOWARD, JOHN (1726-1790), English philanthropist and prison reformer, was born at Hackney, probably on the 2nd of September 1726. His childhood was passed at Cardington, near Bedford, where his father, a retired merchant of independent means, had a small estate. He was apprenticed to a firm of grocers in the city of London, but on the death of his father in 1742, by which he inherited considerable property, he bought up his indenture, and devoted more than a year to foreign travel. Never constitutionally strong, he became, on his return to England, a confirmed invalid. Having been nursed through an acute illness by an attentive landlady, a widow of some fifty-three years of age, Howard, in return for her kindness, offered her marriage and they were united in 1752. Becoming a widower in less than three years, he determined to go abroad again, Portugal being his destination. The ship, however, in which he sailed was taken by a French privateer, the crew and passengers being carried to Brest, where they were treated with great severity. Howard was permitted to return to England on parole to negotiate an exchange, which he accomplished, as well as successfully representing the case of his fellow-captives. He now settled down on his Cardington property, interesting himself in meteorological observations. He was admitted a member of the Royal Society in 1756. In 1758 he married Henrietta, daughter of Edward Leeds, of Croxton, Cambridgeshire. He continued to lead a secluded life at Cardington and at Watcombe, Hampshire, busying himself in the construction of model cottages and the erection of schools. In 1765 his second wife died after giving birth to a son. In the following year Howard went for a prolonged foreign tour, from which he returned in 1770.

In 1773 the characteristic work of his life may be said to have begun by his acceptance of the office of high sheriff of Bedford. When the assizes were held he did not content himself with sitting out the trials in open court, his inquisitiveness and his benevolence alike impelled him to visit the gaol. Howard found it, like all the prisons of the time, wretchedly defective in its arrangements; but what chiefly shocked him was the circumstance that neither the gaoler nor his subordinates were salaried officers, but were dependent for their livelihood on fees from the prisoners. He found that some whom the juries had declared not guilty, others in whom the grand jury had not found even such appearance of guilt as would warrant a trial, others whose prosecutors had failed to appear, were frequently detained in prison for months after they had ceased to be in the position of accused parties, until they should have paid the fees of gaol delivery (see Introduction to *The State of the Prisons of England and Wales*). His prompt application to the justices of the county for a salary to the gaoler in lieu of his fees was met by a demand for a precedent in charging the county with an expense. This he undertook to find if such a thing existed. He went accordingly from county to county, and though he could find no precedent for charging the county with the wages of its servants he did find so many abuses in prison management that he determined to devote himself to their reform.

In 1774 he gave evidence before a committee of the House of Commons, and received the thanks of the house for "the humanity and zeal which have led him to visit the several gaols

of this kingdom, and to communicate to the House the interesting observations which he has made on that subject." Almost immediately an act was passed which provided for the liberation, free of all charges, of every prisoner against whom the grand jury failed to find a true bill, giving the gaoler a sum from the county rate in lieu of the abolished fees. This was followed in June by another requiring justices of the peace to see that the walls and ceilings of all prisons within their jurisdiction were scraped and whitewashed once a year at least; that the rooms were regularly cleaned and ventilated; that infirmaries were provided for the sick, and proper care taken to get them medical advice; that the naked should be clothed; that underground dungeons should be used as little as could be; and generally that such courses should be taken as would tend to restore and preserve the health of the prisoners. It was highly characteristic of the man that, having caused the provisions of the new legislation to be printed at his own private cost in large type, he sent a copy to every gaoler and warden in the kingdom, that no one should be able to plead ignorance of the law if detected in the violation of its provisions. He then set out upon a new tour of inspection, from which, however, he was brought home by the approach of a general election in September 1774. Standing as one of the anti-ministerial candidates for Bedford, he was returned by a narrow majority but was unseated after a scrutiny.

After a tour in Scotland and Ireland, he set out in April 1775 upon an extended tour through France, the Low Countries and Germany. At Paris he was at first denied access to the prisons; but, by recourse to an old and almost obsolete law of 1717, according to which any person wishing to distribute alms to the prisoners was to be admitted, he succeeded in inspecting the Bicêtre, the Force l'Évêque and most of the other places of confinement, the only important exception being the Bastille. Even in that case he succeeded in obtaining possession of a suppressed pamphlet, which he afterwards translated and published in English, to the unconcealed chagrin of the French authorities. At Ghent he examined with special interest the great Maison de Force, then recently erected, with its distinctive features—useful labour, in the profits of which the prisoners had a share, and complete separation of the inmates by night. At Amsterdam, as in Holland generally, he was much struck with the comparative absence of crime, a phenomenon which he attributed to the industrial and reformatory treatment there adopted. In Germany he found little that was useful and much that was repulsive; in Hanover and Osnabrück, under the rule of a British sovereign, he even found traces of torture. After a short tour in England (Nov. 1775 to May 1776), he again went abroad, extending his tour to several of the Swiss cantons. In 1777 appeared *The State of the Prisons in England and Wales, with Preliminary Observations, and an Account of some Foreign Prisons*. One of the immediate results was the drafting a bill for the establishment of penitentiary houses, where by means of solitary imprisonment, accompanied by well-regulated labour and religious instruction, the object of reforming the criminal and inuring him to habits of industry might be pursued. New buildings were manifestly necessary; and Howard volunteered to go abroad again and collect plans. He first went to Amsterdam (April 1778), and carefully examined the "spinhouses" and "rasp-houses" for which that city was famous; next he traversed Prussia, Saxony, Bohemia, Austria and Italy, everywhere inspecting prisons, hospitals and workhouses, and carefully recording the merits and defects of each. The information he thus obtained having been placed at the service of parliament, a bill was passed for building two penitentiary houses, and Howard was appointed first supervisor, but he resigned the post before anything practical had been achieved. In 1780 he had published a quarto volume as an appendix (the first) to his *State of Prisons*; about the same time also he caused to be printed his translation of the suppressed French

¹The spinhouses were for women prisoners, who were set to spinning or other useful work; in the rasp-houses, the prisoners were employed in rasping wood.

pamphlet on the Bastille; but on obtaining release from his employments at home his passion for accumulating statistics urged him to new and more extended continental tours, as far as to Denmark, Sweden and Russia in 1781, and to Spain and Portugal in 1783. The results of these journeys were embodied in 1784 in a second appendix, with the publication of which his direct labours in connexion with the subject of prison reform may be said to have ceased.

The five remaining years of his life were chiefly devoted to researches on the means for prevention of the plague, and for guarding against the propagation of contagious distempers in general. After an extended tour on the continent his researches seemed to be complete; and with a great accumulation of papers and memoranda, he was preparing to return homewards from Constantinople by Vienna, when it occurred to his scrupulous mind that he still lacked any personal experience of quarantine discipline. He returned to Smyrna, and, deliberately choosing a foul ship, took a passage to Venice. A protracted voyage of sixty days, during which an attack by pirates gave Howard an opportunity of manifesting his personal bravery, was followed by a weary term of confinement which enabled him to gain the experience he had desired. While imprisoned in the Venetian lazaretto he received the information that his only son, a youth of twenty-two years of age, had lost his reason and had been put under restraint. Returning hastily by Trieste and Vienna (where he had a long and singular interview with the emperor Joseph II.), he reached England in February 1787. His first care related to his domestic concerns; he then set out upon another journey of inspection of the prisons of the United Kingdom, at the same time busying himself in preparing for the press the results of his recent tour. The somewhat rambling work containing them was published in 1798 at Warrington, under the title *An Account of the Principal Lazarettos in Europe; with various Papers relative to the Plague, together with further Observations on some Foreign Prisons and Hospitals, and additional Remarks on the present State of those in Great Britain and Ireland*.

In July 1789 he embarked on what proved to be his last journey. Travelling overland to St Petersburg and Moscow, and so southwards, and visiting the principal military hospitals that lay on his route, he reached Kherson in November. In the hospitals of this place and of the immediate neighbourhood he found more than enough to occupy his attention while he awaited the means of transit to Constantinople. Towards the end of the year his medical advice was asked in the case of a young lady who was suffering under the camp fever then prevalent, and in attending her he himself took the disease, which terminated fatally on the 30th of January 1790. He was buried near the village of Dauphigny on the road to St Nicholas. There is a statue by Bacon to his memory in St Paul's, London, and one at Bedford by A. Gilbert. In personal appearance Howard is described as having been short, thin and sallow—unprepossessing apart from the attraction of a penetrating eye and a benevolent smile.

AUTHORITIES.—*Anecdotes of the Life and Character of John Howard, written by a Gentleman* (1790); Aikin, *View of the Character and Public Services of the late John Howard* (1792); *Memoirs* by J. Baldwin Brown (1818); T. Taylor (1836), Hepworth Dixon (1849), J. Field (1850), and J. Stoughton, *Howard the Philanthropist* (1864).

HOWARD, OLIVER OTIS (1830-1900), American soldier, was born in Leeds, Maine, on the 8th of November 1830. He graduated at Bowdoin College in 1850, and at the U.S. Military Academy in 1854. In 1857 he served in Florida against the Seminole Indians, and from 1857 to 1861 he was assistant professor of mathematics at West Point. At the beginning of the Civil War he resigned to become colonel of the 3rd Maine volunteer regiment, and at the first battle of Bull Run was in command of a brigade. In September he was promoted brigadier-general of volunteers. He served in the Peninsular Campaign, and at the battle of Seven Pines (Fair Oaks) he was twice wounded, losing his right arm. On his return to active service in August 1862 he took part in the Virginian campaigns of 1862-63; at

Antietam he succeeded Sedgwick in command of a division, and he became major-general of volunteers in March 1863. In the campaign of Chancellorsville (see *WILDERNESS*) he commanded the XI. corps, which was routed by "Stonewall" Jackson, and in the first day's battle at Gettysburg he was for some hours (succeeding Doubleday after Reynolds's death) in command of the Union troops. The XI. corps was transferred to Tennessee after Rosecrans's defeat at Chickamauga, and formed part of Hooker's command in the great victory of Chattanooga. When Sherman prepared to invade Georgia in the spring of 1864 the XI. corps was merged with the XII. into the new XX., commanded by Hooker, and Howard was then placed in command of the new IV. corps, which he led in all the actions of the Atlanta campaign, receiving another wound at Pickett's Mills. On the death in action of General M'Pherson, Howard, in July 1864, was selected to command the Army of the Tennessee. In this position he took part in the "March to the Sea" and the Carolinas campaign. In March 1865 he was breveted major-general U.S.A. "for gallant and meritorious service in the battle of Ezra Church and during the campaign against Atlanta," and in 1893 received a Congressional medal of honour for bravery at Fair Oaks. After the peace he served as commissioner of the Bureau of Refugees, Freedmen and Abandoned Lands from 1865 until 1874; in 1872 he was special commissioner to the hostile Apaches of New Mexico and Arizona; in 1874-1881 was in command of the Department of the Columbia and conducted the campaign against Chief Joseph in 1877 and that against the Bannocks and Piutes in 1878. In 1881-1882 he was superintendent of West Point; and in 1882-1886 he commanded the Department of the Platte, in 1886-1888 the Department of the Pacific, and in 1888-1894 the Department of the East. In 1886 he was promoted major-general and in 1894 he retired. He died at Burlington, Vermont, on the 26th of October 1909.

Howard was deeply interested in the welfare of the negroes; and the establishment by the U.S. Government in 1867 of Howard University, at Washington, especially for their education, was largely due to him; it was named in his honour, and from 1869 to 1873 he presided over it. In 1895 he founded for the education of the "mountain whites" the Lincoln Memorial University at Cumberland Gap, Tenn. (see *CUMBERLAND MOUNTAINS*), and became president of its board. He held honorary degrees of various universities, and was a chevalier of the Legion of Honour. He wrote, amongst other works, *Donald's Schooldays* (1877); *Chief Joseph* (1881); a life of General Zachary Taylor (1892) in the "Great Commanders" series; *Isabella of Castile* (1894); *Fighting for Humanity* (1898); *Henry in the War* (1898); papers in the "Battles and Leaders" collection on the Atlanta campaign; *My Life and Experience among our Hostile Indians* (1907); and *Autobiography of O. O. Howard* (2 vols., New York, 1907).

HOWARD, SIR ROBERT (1626-1698), English dramatist, sixth son of Thomas Howard, 1st earl of Berkshire, was born in 1626. He was knighted at the second battle of Newbury (1644) for his signal courage on the Royalist side. Imprisoned in Windsor Castle under the Commonwealth, his loyalty was rewarded at the Restoration, and he eventually became auditor of the exchequer. His best play is a comedy, *The Committee, or the Faithful Irishman* (1663; printed 1665), which kept the stage, long after its interest as a political satire was exhausted, for the character of Teague, said to have been drawn from one of his own servants. He was an early patron of Dryden, who married his sister, Lady Elizabeth Howard, and in the *Indian Queen*, a tragedy in heroic verse (1664; pr. 1665) Howard had assistance from Dryden, although the fact was not made public until the production of Dryden's *Indian Emperor*. The magnificence of the spectacle, and the novelty of the costume of feathers, presented by Mrs. Aphra Behn, that was worn by Zempoalla, the Indian queen, made a great sensation. The scenery and accessories were unusually brilliant, the richest ever seen in England, according to Evelyn. In 1665 Howard published *Four New Plays*, in the preface to which he opposed the view maintained by Dryden in the dedicatory epistle to *The Rival Ladies*, that

rhyme was better suited to the heroic tragedy than blank verse. Howard made an exception in favour of the rhyme of Lord Orrery, but by his silence concerning Dryden implicated him in the general censure. Dryden answered by placing Howard's sentiments in the mouth of Crites in his own *Essay on Dramatic Poesy* (1668). The controversy did not end here, but Dryden completely worsted his adversary in the 1668 edition of *The Indian Emperor*. Howard died on the 3rd of September 1698.

His brother, James Howard, wrote two comedies, *All Mistaken, or the Mad Couple*, a comedy (1667; pr. 1672), and *The English Mousieur* (1666; pr. 1674), the success of which seems to have been partly due to the acting of Nell Gwynn.

HOWARD, LORD WILLIAM (1563-1640), known as "Beited or Bauld (bold) Will," 3rd son of Thomas Howard, 4th duke of Norfolk (executed in 1572), and of his second wife Margaret, daughter of Lord Audley, was born at Audley End in Essex on the 19th of December 1563. He married on the 28th of October 1577 Elizabeth, daughter of Thomas, Lord Dacre, and proceeded subsequently to the University of Cambridge. Being suspected of treasonable intentions together with his elder brother, Philip, earl of Arundel, he was imprisoned in 1583, 1585 and 1589. He joined the church of Rome in 1584, both brothers being dispossessed by the queen of a portion of their Dacre estates, which were, however, restored in 1601 for a payment of £10,000. Howard then took up his residence with his children and grandchildren at Naworth Castle in Cumberland, restored the castle, improved the estate and established order in that part of the country. In 1603, on the accession of James, he had been restored in blood. In 1618 he was made one of the commissioners for the border, and performed great services in upholding the law and suppressing marauders. Lord William was a learned and accomplished scholar, praised by Camden, to whom he sent inscriptions and drawings from relics collected by him from the Roman wall, as "a singular lover of valuable antiquity and learned withal." He collected a valuable library, of which most of the printed works remain still at Naworth, though the MSS. have been dispersed, a portion being now in the Arundel MSS. in the Royal College of Arms; he corresponded with Usher and was intimate with Camden, Spelman, and Cotton, whose eldest son married his daughter. He published in 1592 an edition of Florence of Worcester's *Chronicon ex Chronicis*, dedicated to Lord Burghley, and drew up a genealogy of his family, now among the duke of Norfolk's MSS. at Norfolk House. He died in October 1640 at Greystock, to which place he had been removed when failing in health to escape the Scots who were threatening an advance on Naworth. He had a large family of children, of whom Philip, his heir, was the grandfather of Charles, 1st earl of Carlisle, and Francis was the ancestor of the Howards of Corby.

HOWARD OF EFFINGHAM, WILLIAM HOWARD, 1st BARON (c. 1510-1573), English lord high admiral, was the son of the 2nd duke of Norfolk. He was popular with Henry VIII., and at Anne Boleyn's coronation was deputy earl marshal; and he was sent on missions to Scotland and France; but in 1541 he was charged with abetting his relative Queen Catherine Howard, and was convicted of misprision of treason, but pardoned. In 1552 he was made governor of Calais, and in 1553 lord high admiral, being created Baron Howard of Effingham in 1554 for his defence of London in Sir Thomas Wyatt's rebellion against Queen Mary. He befriended the princess Elizabeth, but his popularity with the navy saved him from Mary's resentment; and when Elizabeth became queen he had great influence with her and filled several important posts. His son, the second baron, who is famous in English naval history, was created earl of Nottingham (q.v.); and from a younger son the later earls of Effingham were descended. William's descendant, Francis (d. 1695), inherited the barony of Howard of Effingham on the death of his cousin, Charles, in 1681; and Francis's son, Francis (1683-1743), was created earl of Effingham in 1731. This earldom became extinct on the death of Richard, the fourth holder, in 1816; but it was created again in 1837 in favour of Kenneth Alexander (1767-1845), another of William Howard's descendants.

who had succeeded to the barony of Howard of Effingham in 1816.

HOWE, ELIAS (1819—1867), American sewing-machine inventor, was born in Spencer, Massachusetts, on the 9th of July 1819. His early years were spent on his father's farm. In 1835 he entered the factory of a manufacturer of cotton-machinery at Lowell, Massachusetts, where he learned the machinist's trade. Subsequently, while employed in a machine shop at Cambridge, Mass., he conceived the idea of a sewing machine, and for five years spent all his spare time in its development. In September 1846 a patent for a practical sewing machine was granted to him; and Howe spent the following two years (1847—1849) in London, employed by William Thomas, a corset manufacturer, to whom he had sold the English rights for £250. Years of disappointment and discouragement followed before he was successful in introducing his invention, and several imitations which infringed his patent, particularly that of Isaac Merritt Singer (1811—1875), had already been successfully introduced and were widely used. His rights were established after much litigation in 1854, and by the date of expiration of his patent (1867) he had realized something over \$2,000,000 out of his invention. He died in Brooklyn, New York, on the 3rd of October 1867.

See *History of the Sewing Machine and of Elias Howe, Jr., the Inventor* (Detroit, 1867), P. G. Hubert, Jr., *Inventors*, in "Men of Achievement" series (New York, 1893).

HOWE, JOHN (1630—1706), English Puritan divine, was born on the 17th of May 1630 at Loughborough, Leicestershire, where his father was vicar. On the 19th of May 1647 he entered Christ's College, Cambridge, as a sizar, and in the following year took his degree of B.A. During his residence at the university he made the acquaintance of Ralph Cudworth, Henry More and John Smith, from intercourse with whom, as well as from direct acquaintance with the *Dialogues* themselves, his mind received that "Platonic tinge" so perceptible in his writings. Immediately after graduation at Cambridge, he migrated to Oxford, where he became fellow and chaplain of Magdalen College, proceeding M.A. in 1652. He was then ordained by Charles Herle (1508—1650), the Puritan rector of Winwick, and in 1654 went as perpetual curate to Great Torrington in Devon, where he preached the discourses which later took shape in his treatises on *The Blessedness of the Righteous* and on *Delighting in God*. In the beginning of 1657 a journey to London accidentally brought Howe under the notice of Cromwell, who made him his domestic chaplain. In this position his conduct was such as to win the praise of even the bitterest enemies of his party. Without overlooking his fellow-Puritans, he was always ready to help pious and learned men of other schools. Seth Ward (afterwards bishop of Exeter) and Thomas Fuller were among those who profited by Howe's kindness, and were not ashamed subsequently to express their gratitude for it. On the resignation of Richard Cromwell, Howe returned to Great Torrington, to leave it again in 1662 on the passing of the Act of Uniformity. For several years he led a wandering and uncertain life, preaching in secret as occasion offered to handfuls of trusted hearers. Being in straits he published in 1668 *The Blessedness of the Righteous*; the reputation which he thus acquired procured him an invitation from Lord Massereene, of Antrim Castle, Ireland, with whom he lived for five or six years as domestic chaplain, frequently preaching in public, with the approval of the bishop of the diocese. Here too he produced the most eloquent of his shorter treatises, *The Vanity of Man as Mortal*, and *On Delighting in God*, and planned his best work, *The Living Temple*. In the beginning of 1676 he accepted an invitation to become joint-pastor of a non-conformist congregation at Haberdashers' Hall, London; and in the same year he published the first part of *The Living Temple* entitled *Concerning God's Existence and his Conversableness with Man: Against Atheism or the Epicurean Deism*. In 1677 appeared his tractate *On the Reconcilableness of God's Presence of the Sins of Men with the Wisdom and Sincerity of His Counsels, Exhortations and whatsoever means He uses to prevent them,*

which was attacked from various quarters, and had Andrew Marvell for one of its defenders. *On Thoughtfulness for the Morrow* followed in 1681; *Self-Dedication and Union among Protestants* in 1682, and *The Redeemer's Tears wept over Lost Souls* in 1684.

For five years after his settlement in London Howe enjoyed comparative freedom, and was on not unfriendly terms with many eminent Anglicans, such as Stillingfleet, Tillotson, John Sharp and Richard Kidder; but the greater severity which began to be exercised towards nonconformists in 1681 so interfered with his liberty that in 1685 he gladly accepted the invitation of Philip, Lord Wharton, to travel abroad with him. In 1686 he determined to settle for a time at Utrecht, where he officiated in the English chapel. Among his friends there was Gilbert Burnet, by whose influence he obtained several confidential interviews with William of Orange. In 1687 Howe availed himself of the declaration for liberty of conscience to return to England, and in the following year he headed the deputation of nonconformist ministers who went to congratulate William on his accession to the English throne. The remainder of his life was uneventful. His influence was always on the side of mutual forbearance, between conformists and dissenters in 1689, and between Congregationalists and Presbyterians in 1690. In 1693 he published three discourses *On the Carnality of Religious Contention*, suggested by the disputes that became rife among nonconformists as soon as liberty of doctrine and worship had been granted. In 1694 and 1695 he published various treatises on the subject of the Trinity, the principal being *A Calm and Solemn Inquiry concerning the Possibility of a Trinity in the Godhead*. The second part of *The Living Temple*, entitled *Animadversions on Spinoza and a French Writer pretending to confute him, with a recapitulation of the former part and an account of the destitution and restitution of God's Temple among Men*, appeared in 1702. In 1701 he had some controversy with Daniel Defoe on the question of occasional conformity. In 1705 he published a discourse *On Patience in the Expectation of Future Blessedness*, but his health had begun to fail, and he died in London on the 2nd of April 1706. Richard Cromwell visited him in his last illness.

Though excelled by Baxter as a pulpit orator, and by Owen in exegetical ingenuity and in almost every department of theological learning, Howe compares favourably with either as a sagacious and profound thinker, while he was much more successful in combining religious earnestness and fervour of conviction with large-hearted tolerance and cultured breadth of view. He was a man of high principle and fine presence, and it was said of him "that he never made an enemy and never lost a friend."

The works published in his lifetime, including a number of sermons, were collected into 2 vols. fol. in 1724, and again reprinted in 3 vols. 8vo. in 1838. A complete edition of the *Whole Works*, including much posthumous and additional matter, appeared with a memoir in 8 vols. in 1822; this was reprinted in 1 vol. in 1838 and in 6 vols. in 1862—1863. E. Calamy's *Life* (1724) forms the basis of *The Life and Character of Howe, with an Analysis of his Writings*, by Henry Rogers (1836, new ed. 1863). See also a sketch by R. F. Horton (1896).

HOWE, JOSEPH (1804—1873), Canadian statesman, was born at Halifax, Nova Scotia, on the 13th of December 1804, the son of John Howe (1752—1835), a United Empire Loyalist who was for many years king's printer and postmaster-general for the Maritime Provinces and the Bermudas. He received little regular education, and at the age of 13 entered his father's office. In 1827 he started the *Acadian*, a weekly non-political journal, but soon sold it, and in 1828 purchased the *Nova Scotian*, which later became amalgamated with the *Morning Chronicle*. From this date he devoted increasing attention to political affairs, and in 1835 was prosecuted for libelling the magistrates of Halifax. Being unable to find a lawyer willing to undertake his case, he pleaded it himself, and won his acquittal by a speech of over six hours, which secured for Nova Scotia the freedom of the press and for himself the reputation of an orator. In 1836 he was elected member for Halifax in the provincial assembly, and during the next twelve years devoted himself to attaining

responsible government for Nova Scotia. This brought him into fierce conflict with the reigning oligarchy and with the lieutenant-governor, Lord Falkland (1803-1884), whom he forced to resign. Largely owing to Howe's statesmanship responsible government was finally conceded in 1848 by the imperial authorities, and was thus gained without the bloodshed and confusion which marked its acquisition in Ontario and Quebec. In 1850 he was appointed a delegate to England on behalf of the Intercolonial railway, for which he obtained a large imperial guarantee. In 1854 he resigned from the cabinet, and was appointed chief commissioner of railways. In 1855 he was sent by the imperial government to the United States in connexion with the Foreign Enlistment Act, to raise soldiers for the war in the Crimea. Through the rashness of others he got into difficulties, and was attacked in the British House of Commons by Mr Gladstone, whom he compelled to apologize.

In 1855 he was defeated by Mr (afterwards Sir Charles) Tupper, but was elected by acclamation in the next year in Hants county, and was from 1860 to 1863 premier of Nova Scotia. In the latter years he was appointed by the imperial government fishery commissioner to the United States, and thus took no part in the negotiations for confederation. Though his eloquence had done more than anything else to make practicable a union of the British North American provinces, he opposed confederation, largely owing to wounded vanity; but on finding it impossible to obtain from the imperial authorities the repeal of the British North America Act, he refused to join his associates in the extreme measures which were advocated, and on the promise from the Canadian government of better financial terms to his native province, entered (on the 30th of January 1869) the cabinet of Sir John Macdonald as president of the council. This brought upon him a storm of obloquy, under which his health gradually gave way. In May 1873 he was appointed lieutenant-governor of Nova Scotia, but died suddenly on the 1st of June of the same year.

Howe's eloquence, and still more his unflinching wit and high spirits, made him for many years the idol of his province. He is the finest orator whom Canada has produced, and also wrote poetry, which shows in places high merit. Many of his sayings are still current in Nova Scotia. In 1904 a statue in his honour was erected in Halifax.

His *Letters and Speeches* were published in 1858 in Boston, Mass., in 2 vols., edited nominally by William Annand, really by himself. See also *Public Letters and Speeches of Joseph Howe* (Halifax, 1909). The *Life and Times* by G. E. Fenety (1896) is poor. The *Life* by the Hon. James W. Longley (Toronto, 1904) is dispassionate, but otherwise mediocre. *Joseph Howe*, by George Monro Grant (reprinted Halifax, 1904), is a brilliant sketch. (W. L. G.)

HOWE, JULIA WARD (1819-1910), American author and reformer, was born in New York City on the 27th of May 1819. Her father, Samuel Ward, was a banker; her mother, Julia Rush [Cutler] (1796-1824), a poet of some ability. When only sixteen years old she had begun to contribute poems to New York periodicals. In 1843 she married Dr Samuel Gridley Howe (q.v.), with whom she spent the next year in England, France, Germany and Italy. She assisted Dr Howe in editing the *Commonwealth* in 1851-1853. The results of her study of German philosophy were seen in philosophical essays; in lectures on "Doubt and Belief," "The Duality of Character," &c., delivered in 1860-1861 in her home in Boston, and later in Washington; and in addresses before the Boston Radical Club and the Concord school of philosophy. Samuel Longfellow, his brother Henry, Wendell Phillips, W. L. Garrison, Charles Sumner, Theodore Parker and James Freeman Clarke were among her friends; she advocated abolition, and preached occasionally from Unitarian pulpits. She was one of the organizers of the American Woman-Suffrage Association and of the Association for the Advancement of Women (1869); and in 1870 became one of the editors of the *Woman's Journal*, and in 1872 president of the New England Women's Club. In the same year she was a delegate to the Prison Reform Congress in London, and founded there the Woman's Peace Association, one of the many ways in which she expressed her opposition

to war. She wrote *The World's Own* (unsuccessfully played at Wallack's, New York, in 1855, published 1857), and in 1858, for Edwin Booth, *Hippolytus*, never acted or published. Her lyric poetry, thanks to her temperament, and possibly to her musical training, was her highest literary form: she published *Passion Flowers* (anonymously, 1854), *Words for the Hour* (1856), *Later Lyrics* (1866), and *From Sunset Ridge: Poems Old and New* (1868); her most popular poem is *The Battle Hymn of the Republic*, written to the old folk-tune associated with the song of "John Brown's Body," when Mrs Howe was at the front in 1861, and published (Feb. 1862) in the *Atlantic Monthly*, to which she frequently contributed. She edited *Sex and Education* (1874), an answer to *Sex in Education* (1873) by Edward Hammond Clarke (1820-1877); and wrote several books of travel, *Modern Society* (1880) and *Is Politic Society Politic?* (1895), collections of addresses, each taking its title from a lecture criticizing the shallowness and falseness of society, the power of money, &c., *A Memoir of Dr Samuel G. Howe* (1876), *Life of Margaret Fuller* (1883), in the "Famous Women" series, *Sketches of Representative Women of New England* (1905) and her own *Reminiscences* (Boston, 1890). Her children were: Julia Romana Anagnos (1844-1886), who, like her mother, wrote verse and studied philosophy, and who taught in the Perkins Institution, in the charge of which her husband, Michael Anagnos (1837-1906), whose family name had been Anagnostopoulos, succeeded her father; Henry Marion Howe (b. 1848), the eminent metallurgist, and professor in Columbia University; Laura Elizabeth Richards (b. 1850), and Maud Howe Elliott (b. 1855), wife of John Elliott, the painter of a fine ceiling in the Boston library,—both these daughters being contributors to literature. Mrs Howe died on the 17th of October 1910.

HOWE, RICHARD HOWE, EARL (1726-1799), British admiral, was born in London on the 8th of March 1726. He was the second son of Emmanuel Scrope Howe, 2nd Viscount Howe, who died governor of Barbadoes in March 1735, and of Mary Sophia Charlotte, a daughter of the baroness Kilmansegge, afterwards countess of Darlington, the mistress of George I.—a relationship which does much to explain his early rise in the navy. Richard Howe entered the navy in the "Severn," one of the squadron sent into the south seas with Anson in 1740. The "Severn" failed to round the Horn and returned home. Howe next served in the West Indies in the "Burford," and was present in her when she was very severely damaged in the unsuccessful attack on La Guayra on the 18th of February 1742. He was made acting-lieutenant in the West Indies in the same year, and the rank was confirmed in 1744. During the Jacobite rising of 1745 he commanded the "Baltimore" sloop in the North Sea, and was dangerously wounded in the head while co-operating with a frigate in an engagement with two strong French privateers. In 1746 he became post-captain, and commanded the "Triton" (24) in the West Indies. As captain of the "Cornwall" (80), the flagship of Sir Charles Knowles, he was in the battle with the Spaniards off Havana on the 2nd of October 1748. While the peace between the War of the Austrian Succession and the Seven Years' War lasted, Howe held commands at home and on the west coast of Africa. In 1755 he went with Boscawen to North America as captain of the "Dun Kirk" (60), and his seizure of the French "Alcide" (64) was the first shot fired in the war. From this date till the peace of 1763 he served in the Channel in various more or less futile expeditions against the coast of France, with a steady increase of reputation as a firm and skilful officer. On the 20th of November 1759 he led Hawke's fleet as captain of the "Magnanime" (64) in the magnificent victory of Quiberon.

By the death of his elder brother, killed near Ticonderoga on the 6th of July 1758, he became Viscount Howe—an Irish peerage. In 1762 he was elected M.P. for Dartmouth, and held the seat till he received a title of Great Britain. During 1763 and 1765 he was a member of the Admiralty board, and from 1765 to 1770 was treasurer of the navy. In that year he was promoted rear-admiral, and in 1775 vice-admiral. In 1776 he was appointed to the command of the North American station. The rebellion

of the colonies was making rapid progress, and Howe was known to be in sympathy with the colonists. He had sought the acquaintance of Benjamin Franklin, who was a friend of his sister Miss Howe, a clever eccentric woman well known in London society, and had already tried to act as a peacemaker. It was doubtless because of his known sentiments that he was selected to command in America, and was joined in commission with his brother Sir William Howe, the general at the head of the land forces, to make a conciliatory arrangement. A committee appointed by the Continental Congress conferred with the Howes in September 1776 but nothing was accomplished. The appointment of a new peace commission in 1778 offended the admiral deeply, and he sent in a resignation of his command. It was reluctantly accepted by Lord Sandwich, then First Lord, but before it could take effect France declared war, and a powerful French squadron was sent to America under the count d'Estaing. Being greatly outnumbered, Howe had to stand on the defensive, but he baffled the French admiral at Sandy Hook, and defeated his attempt to take Newport in Rhode Island by a fine combination of caution and calculated daring. On the arrival of Admiral John Byron from England with reinforcements, Howe left the station in September. Until the fall of Lord North's ministry in 1782 he refused to serve, assigning as his reason that he could not trust Lord Sandwich. He considered that he had not been properly supported in America, and was embittered both by the supersession of himself and his brother as peace commissioners, and by attacks made on him by the ministerial writers in the press.

On the change of ministry in March 1782 he was selected to command in the Channel, and in the autumn of that year, September, October and November, he carried out the final relief of Gibraltar. It was a difficult operation, for the French and Spaniards had in all 46 line-of-battle ships to his 33, and in the exhausted state of the country it was impossible to fit his ships properly or to supply them with good crews. He was, moreover, hampered by a great convoy carrying stores. But Howe was eminent in the handling of a great multitude of ships, the enemy was awkward and unenterprising, and the operation was brilliantly carried out. From the 28th of January to the 16th of April 1783 he was First Lord of the Admiralty, and he held that post from December 1783 till August 1788, in Pitt's first ministry. The task was no pleasant one, for he had to agree to economies where he considered that more outlay was needed, and he had to disappoint the hopes of the many officers who were left unemployed by the peace. On the outbreak of the Revolutionary war in 1793 he was again named to the command of the Channel fleet. His services in 1794 form the most glorious period of his life, for in it he won the epoch-making victory of the 1st of June (see FIRST OF JUNE, BATTLE OF). Though Howe was now nearly seventy, and had been trained in the old school, he displayed an originality not usual with veterans, and not excelled by any of his successors in the war, not even by Nelson, since they had his example to follow and were served by more highly trained squadrons than his. He continued to hold the nominal command by the wish of the king, but his active service was now over. In 1797 he was called on to pacify the mutineers at Spithead, and his great influence with the seamen who trusted him was conspicuously shown. He died on the 5th of August 1799, and was buried in his family vault at Langar. His monument by Flaxman is in St Paul's Cathedral. In 1782 he was created Viscount Howe of Langar, and in 1788 Baron and Earl Howe. In June 1797 he was made a knight of the Garter. With the sailors he was always popular, though he was no popularity hunter, for they knew him to be just. His nickname of Black Dick was given on account of his swarthy complexion, and the well-known portrait by Gainsborough shows that it was apt.

Lord Howe married, on the 10th of March 1758, Mary Hartop, the daughter of Colonel Chiverton Hartop of Welby in Leicestershire, and had issue two daughters. His Irish title descended to his brother William, the general, who died childless in 1814. The earldom, and the viscounty of the United Kingdom, being

limited to heirs male, became extinct, but the barony, being to heirs general, passed to his daughter, Sophia Charlotte (1762-1835), who married the Hon. Penn Assheton Curzon. Their son, Richard William Curzon (1796-1870), who succeeded his paternal grandfather as Viscount Curzon in 1820, was created Earl Howe in 1821; he was succeeded by his son, George Augustus (1821-1876), and then by another son, Richard William (1822-1900), whose son Richard George Penn Curzon-Howe (b. 1861) became 4th Earl Howe in 1900.

The standard *Life* is by Sir John Barrow (1838). Interesting reminiscences will be found in the *Life of Codrington*, by Lady Bourchier. Accounts of his professional services are in Charnock's *Biographia Navalis*, v. 457, and in Ralf's *Naval Biographies*, i. 83. See also Beatson's *Naval and Military Annals*, James's *Naval History*, and Chevalier's *Histoire de la Marine française*, vols. i. and ii. (D. H.)

HOWE, SAMUEL GRIDLEY (1801-1876), American philanthropist, was born at Boston, Massachusetts, on the 10th of November 1801. His father, Joseph N. Howe, was a ship-owner and cordage manufacturer; and his mother, Patty Gridley, was one of the most beautiful women of her day. Young Howe was educated at Boston and at Brown University, Providence, and in 1821 began to study medicine in Boston. But fired by enthusiasm for the Greek revolution and by Byron's example, he was no sooner qualified and admitted to practice than he abandoned these prospects and took ship for Greece, where he joined the army and spent six years of hardship amid scenes of warfare. Then, to raise funds for the cause, he returned to America; his fervid appeals enabled him to collect about \$60,000, which he spent on provisions and clothing, and he established a relief depot near Aegina, where he started works for the refugees, the existing quay, or American Mole, being built in this way. He formed another colony of exiles on the Isthmus of Corinth. He wrote a *History of the Greek Revolution*, which was published in 1828, and in 1831 he returned to America. Here a new object of interest engaged him. Through his friend Dr John D. Fisher (d. 1850), a Boston physician who had started a movement there as early as 1826 for establishing a school for the blind, he had learnt of the similar school founded in Paris by Valentin Haüy, and it was proposed to Howe by a committee organized by Fisher that he should direct the establishment of a "New England Asylum for the Blind" at Boston. He took up the project with characteristic ardour, and set out at once for Europe to investigate the problem. There he was temporarily diverted from his task by becoming mixed up with the Polish revolt, and, in pursuit of a mission to carry American contributions across the Prussian frontier, he was arrested and imprisoned at Berlin, but was at last released through the intervention of the American minister at Paris. Returning to Boston in July 1832, he began receiving a few blind children at his father's house in Pleasant Street, and thus sowed the seed which grew into the famous Perkins Institution. In January 1833 the funds available were all spent, but so much progress had been shown that the legislature voted \$6000, later increased to \$30,000 a year, to the institution on condition that it should educate gratuitously twenty poor blind from the state; money was also contributed from Salem, and from Boston, and Colonel Thomas H. Perkins, a prominent Bostonian, presented his mansion and grounds in Pearl Street for the school to be held there in perpetuity. This building being later found unsuitable, Colonel Perkins consented to its sale, and in 1839 the institution was moved to South Boston, to a large building which had previously been an hotel. It was henceforth known as the "Perkins Institution and Massachusetts Asylum (or, since 1877, School) for the Blind." Howe was director, and the life and soul of the school; he opened a printing-office and organized a fund for printing for the blind—the first done in America; and he was unwearied in calling public attention to the work. The Institution, through him, became one of the intellectual centres of American philanthropy, and by degrees obtained more and more financial support. In 1837 Dr Howe went still further and brought the famous blind deaf-mute, Laura Bridgman (*q.v.*) to the school.

It must suffice here to chronicle the remaining more important facts in Dr Howe's life, outside his regular work. In 1843 he married Julia Ward (see above), daughter of a New York banker, and they made a prolonged European trip, on which Dr Howe spent much time in visiting those public institutions which carried out the objects specially interesting to him. In Rome, in 1844, his eldest daughter, Julia Romana (afterwards the wife of Michael Anagnos, Dr Howe's assistant and successor), was born, and in September the travellers returned to America, and Dr Howe resumed his activities. In 1846 he became interested in the condition and treatment of idiots, and particularly in the experiments of Dr Guggenbühl on the cretins of Switzerland. He became chairman of a state commission of inquiry into the number and condition of idiots in Massachusetts, and the report of this commission, presented in 1848, caused a profound sensation. An appropriation of \$2500 per annum was made for training ten idiot children under Dr Howe's supervision, and by degrees the value of his School for Idiotic and Feeble-minded Youths, which, starting in South Boston, was in 1890 removed to Waltham, was generally appreciated. It was the first of its kind in the United States. An enthusiastic humanitarian on all subjects, Dr Howe was an ardent abolitionist and a member of the Free Soil party, and had played a leading part at Boston in the movements which culminated in the Civil War. When it broke out he was an active member of the sanitary commission. In 1871 he was sent to Santo Domingo as a member of the commission appointed by President Grant to examine the condition of the island, the government of which desired annexation; and when that scheme was defeated through Sumner's opposition he returned (1872) as the representative of the Samana Bay Company, which proposed to take a lease of the Samana peninsula; but though in 1874 he revisited the island, it was only to see the flag of the company hauled down. His health was then breaking and began soon after to fail rapidly, and on the 9th of January 1876 he died at Boston. The governor of the state sent a special message of grief to the legislature on his death, eulogies were delivered in the two houses, and a public memorial service was held, at which Dr O. W. Holmes read a poem. Whittier had in his lifetime commemorated him in his poem "The Hero," in which he called him "the Cadmus of the blind"; and in 1901 a centennial celebration of his birth was held at Boston, at which, among other notable tributes, Senator Hoar spoke of Howe as "one of the great figures of American history."

A *Memoir* of Dr Howe by his wife appeared in 1876. See also the *Letters and Journals of S. G. Howe*, edited by Laura E. Richards (1910). (H. CH.)

HOWE, WILLIAM HOWE, 5TH VISCOUNT (1729-1814), British general, was the younger brother of George Augustus, 3rd viscount, killed in the Ticonderoga expedition of 1758, and of Richard, 4th viscount and afterwards Earl Howe, the admiral. He entered the cavalry in 1746, becoming lieutenant a year later. On the disbanding of his regiment in 1749 he was made captain-lieutenant and shortly afterwards captain in Lord Bury's (20th) regiment, in which Wolfe was then a field officer. Howe became major in 1756 and lieutenant-colonel in 1757 of the 58th (now Northampton) regiment, which he commanded at the capture of Louisburg. In Wolfe's expedition to Quebec he distinguished himself greatly at the head of a composite light battalion. He led the advanced party in the landing at Wolfe's Cove and took part in the battle of the Plains of Abraham which followed. He commanded his own regiment in the defence of Quebec in 1759-1760, led a brigade in the advance on Montreal and took part on his return to Europe in the siege of Belleisle (1761). He was adjutant-general of the force which besieged and took Havana in 1762, and at the close of the war had acquired the reputation of being one of the most brilliant of the junior officers of the army. He was made colonel of the 46th foot in 1764 and lieutenant-governor of the Isle of Wight four years later. From 1758 to 1780 he was M.P. for Nottingham. In 1772 he became major-general, and in 1774 he was entrusted with the training of light infantry companies on a new system, the training-ground being Salisbury Plain.

Shortly after this he was sent out to North America. He did not agree with the policy of the government towards the colonists, and regretted in particular that he was sent to Boston, where the memory of his eldest brother was still cherished by the inhabitants, and General Gage, in whom he had no confidence, commanded in chief. He was the senior officer after Gage, and led the troops actively engaged in the storming of Bunker Hill, he himself being in the thickest of the fighting. In the same year Howe was made a K.B. and a lieutenant-general, and appointed, with the local rank of general, to the chief command in the seat of war. For the events of his command see AMERICAN WAR OF INDEPENDENCE. He retained it until May 1778—on the whole with success. The cause of his resignation was his feeling that the home government had not afforded the proper support, and after his return to England, he and his brother engaged in a heated but fruitless controversy with the ministers. Howe's own defence is embodied in *Narrative of Sir William Howe before a Committee of the House of Commons* (London, 1780). In 1781 Howe was made lieutenant-general of the ordnance; in 1790 he was placed in command of the forces organized for action against Spain, and in 1793 he was made a full general. He held various home commands in the early part of the French revolutionary war, in particular that of the eastern district at the critical moment when the French established their forces on the Dutch coast. When Earl Howe died in 1799, Sir William succeeded to the Irish viscounty. He had been made governor of Berwick-on-Tweed in 1795, and in 1805 he became governor of Plymouth, where he died on the 12th of July 1814. With his death the Irish peerage became extinct.

HOWEL DDA ("the Good") (d. 950), prince of Deheubarth (South Central Wales) from before 915, and king of Wales from 943 to 950, was the grandson of Rhodri Mawr (the Great), who had united practically the whole of Wales under his supremacy. As Idwal Voel succeeded his father Anarawd, the elder son of Rhodri, as lord of Gwynedd in 915, so Howel at some time before that date succeeded Rhodri's younger son Cadell as prince of Deheubarth. Howel married Elen, daughter of the last king of Dyfed, and also added Kidweli and Gwyr to his dominions, while on the death of Idwal, who was slain by the English in 943, he took possession of Gwynedd. Both these princes had done homage to the English kings, Edward the Elder and Aethelstan, in 922 and 926, and we find that Howel attended the witan of the English kingdom and witnessed about ten charters between the years 931 and 949. He was secure, therefore, from attack on the eastern side of his kingdom, and it is not certain whether he was engaged in any of the battles recorded during these years in Wales, either in Môn 914, at Dinas Newydd 919 or at Brun 935. To the peaceful character of his reign is probably due the high place which he holds among the Welsh princes. From 943 to 950 Howel Dda was probably ruler of all Wales except Powys (apparently dependent on Mercia), Brecheiniog, Buallt, Gwent and Morgannwg. With Morgan Hen, king of Morgannwg, Howel had a dispute which was eventually settled in favour of the former at the court of the English king. Howel died in 950, and such unity as he had preserved at once disappeared in a war between his sons and those of Idwal Voel. The code of laws attributed to this prince is perhaps his chief claim to fame. He is said to have summoned four men from each cantref in his dominions to the Ty Gwyn (perhaps Whitland in Caermarthenshire) to codify existing custom. Three codes, accordingly called Venedotian, Demetian and Gwentian, are said to have been written down by Bleggwryd, archdeacon of Llandaff (see WELSH LAWS).

See Sir John Rhys and Brynmor-Jones, *The Welsh People* (London, 1900); and Aneurin Owen, *Ancient Laws and Institutions of Wales* (London, 1841).

HOWELL, JAMES (c. 1594-1666), British author, who came of an old Welsh family, was born probably at Abernant, in Carmarthenshire, where his father was rector. From the free grammar school at Hereford he went to Jesus College, Oxford, and took his degree of B.A. in 1613. About 1616 he was steward in Sir Robert Mansell's glass-works in Broad Street, and was commissioned to go abroad to procure the services of expert

workmen. It was not till 1622 that he returned, having visited Holland, France, Spain and Italy. With the intention of utilizing to better purpose his knowledge of continental languages and methods, he left the glass business and applied for a diplomatic post. Failing to obtain this, he was for a short time tutor in a nobleman's family. At the close of 1622 he was sent on a special mission to Madrid to obtain redress for the seizure of an English vessel, but, owing to the presence at the Spanish court of Prince Charles and the duke of Buckingham to arrange a marriage between the prince and the infanta of Spain, the negotiations had to be broken off. He made many friends among the prince's retinue, and, after his return in 1624, applied for employment to the duke of Buckingham, but without success. In 1626 he became secretary to Lord Scrope, Lord President of the North at York, and retained the office under Scrope's successor, Thomas Wentworth. In 1627 he was elected M.P. for Richmond; in 1632 he was sent as secretary to the embassy of the earl of Leicester to Denmark; and in 1642 the king appointed him one of the clerks of the privy council. In 1643 he was committed to the Fleet prison by the parliament, according to his own account, on suspicion of royalist leanings, or, as Anthony à Wood says, for debt. Whatever the reason, he remained in prison until 1651. He had acquired considerable fame by his allegorical *Δωδωκαλογία: Dodona's Grove, or the Vocal Forest*, published in 1640, and his *Instructions for Forreine Travell* (1642), which has been described as the first continental handbook; and now he was driven to maintain himself by his pen. He edited and supplemented (1650) Cotgrave's French and English dictionary, compiled *Lexicon Tetraglotton, or an English, French, Italian and Spanish Dictionary* (London, 1660), translated various works from Italian and Spanish, wrote a life of Louis XIII. and issued a number of political pamphlets, varying the point of view somewhat to suit the changes of the time. Among these tracts may be mentioned a rather malicious *Perfect Description of the People and Country of Scotland*, which was revived by John Wilkes and printed in the *North Briton* during the agitation directed against Lord Bute. In 1660 he asked for the place of clerk of the privy council; and, though this was not granted him, the post of historiographer royal was created for him. In 1661 he applied for the office of tutor in foreign languages to the infanta Catherine of Braganza, and in 1662 published an *English Grammar translated into Spanish*. He was buried in the Temple Church on the 3rd of November 1666, having realized to the last his favourite motto, "Senescio non senescere."

All Howell's writings are imbued with a certain simplicity and quaintness. His elaborate allegories are forgotten; his linguistic labours, of value in their time, are now superseded; but his *Letters*, the *Epistolae Ho-elianae* (four volumes issued in 1645, 1647, 1650 and 1655), are still models of their kind. Their dates are often fictitious, and they are, in nearly every case, evidently written for publication. Thackeray said that the *Letters* was one of his bedside books. He classes it with Montaigne and says he scarcely ever tired of "the artless prattle" of the "priggish little clerk of King Charles's council."

The *Epistolae* have been frequently edited, notably by J. Jacobs in 1890, with a commentary (1891), and Agnes Repplier (1907).

HOWELLS, WILLIAM DEAN (1837—), American novelist, was born at Martin's Ferry, Ohio, on the 1st of March 1837. His father, William Cooper Howells, a printer-journalist, moved in 1840 to Hamilton, Ohio, and here the boy's early life was spent successively as type-setter, reporter and editor in the offices of various newspapers. In the midst of routine work he contrived to familiarize himself with a wide range of authors in several modern tongues, and to drill himself thoroughly in the use of good English. In 1860, as assistant editor of the leading Republican newspaper in Ohio, he wrote—in connexion with the Presidential contest—the campaign life of Lincoln; and in the same year he was appointed consul at Venice, where he remained till 1865. On his return to America he joined the staff of the *Atlantic Monthly*, and from 1872 to 1881 he was its editor-in-chief. Since 1885 he has lived in New York. For a time he

conducted for *Harper's Magazine* the department called "The Editor's Study," and in December 1900 he revived for the same periodical the department of "The Easy Chair," which had lapsed with the death of George William Curtis. Of Mr Howells's many novels, the following may be mentioned as specially noteworthy: *Their Wedding Journey* (1872); *The Lady of the Aroostook* (1879); *A Modern Instance* (1882); *The Rise of Silas Lapham* (1885); *The Minister's Charge* (1886); *A Hazard of New Fortunes* (1889); *The Quality of Mercy* (1892); *The Landlord at Lion's Head* (1897). He also published *Poems* (1873 and 1886); *Stops of Various Quills* (1895), a book of verse; books of travel; several amusing farces; and volumes of essays and literary criticism, among others, *Literary Friends and Acquaintance* (1901), which contains much autobiographical matter, *Literature and Life* (1902), and *English Films* (1905).

Howells is by general consent the foremost representative of the realistic school of indigenous American fiction. From the outset his aim was to portray life with entire fidelity in all its commonplaceness, and yet to charm the reader into a liking for this commonplaceness and into reverence for what it conceals. Though in his earliest novels his method was not consistently realistic—he is at times almost as personal and as whimsical as Thackeray—yet his vivid impressionism and his choice of subjects, as well as an occasional explicit protest that "dulness is dear to him," already revealed unmistakably his realistic bias. In *A Modern Instance* (1882) he gained complete command of his method, and began a series of studies of American life that are remarkable for their loyalty to fact, their truth of tone, and their power to reveal, despite their strictly objective method, both the inner springs of American character and the sociological forces that are shaping American civilization. He refuses to oversophisticate or to over-intellectualize his characters, and he is very sparing in his use of psychological analysis. He insists on seeing and portraying American life as it exists in and for itself, under its own skies and with its own atmosphere; he does not scrutinize it with foreign comparisons in mind, and thus try to find and to throw into relief unsuspected configurations of surface. He keeps his dialogue toned down to almost the pitch of everyday conversation, although he has shown in his comedy sketches how easy a master he is of adroit and witty talk.

See also J. M. Robertson, *Essays towards a Critical Method* (London, 1889); H. C. Vedder, *American Writers* (Boston, 1894).

HOWITT WILLIAM, (1792-1879), English author, was born on the 18th of December 1792 at Heanor, Derbyshire. His parents were Quakers, and he was educated at the Friends' public school at Ackworth, Yorkshire. In 1814 he published a poem on the "Influence of Nature and Poetry on National Spirit." He married, in 1821, Mary Botham (1799-1888), like himself a Quaker and a poet. William and Mary Howitt collaborated throughout a long literary career, the first of their joint productions being *The Forest Minstrels and other Poems* (1827). In 1831 William Howitt produced a work for which his habits of observation and his genuine love of nature peculiarly fitted him. It was a history of the changes in the face of the outside world in the different months of the year, and was entitled *The Book of the Seasons, or the Calendar of Nature* (1831). His *Popular History of Priestcraft* (1833) won for him the favour of active Liberals and the office of alderman in Nottingham, where the Howitts had made their home. They removed in 1837 to Esher, and in 1840 they went to Heidelberg, primarily for the education of their children, remaining in Germany for two years. In 1841 William Howitt produced, under the pseudonym of "Dr Cornelius," *The Student Life of Germany*, the first of a series of works on German social life and institutions. Mary Howitt devoted herself to Scandinavian literature, and between 1842 and 1863 she translated the novels of Frederika Bremer and many of the stories of Hans Andersen. With her husband she wrote in 1852 *The Literature and Romance of Northern Europe*. In June of that year William Howitt, with two of his sons, set sail for Australia, where he spent two years in the goldfields. The results of his travels appeared in *A Boy's*

Adventures in the Wilds of Australia (1854), *Land, Labour and Gold; or, Two Years in Victoria* (1855) and *Tallangetta, the Squatter's Home* (1857). On his return to England Howitt had settled at Highgate and resumed his indefatigable book-making. From 1856 to 1862 he was engaged on Cassell's *Illustrated History of England*, and from 1861 to 1864 he and his wife worked at the *Ruined Abbeys and Castles of Great Britain*. The Howitts had left the Society of Friends in 1847, and became interested in spiritualism. In 1863 appeared *The History of the Supernatural in all Ages and Nations, and in all Churches, Christian and Pagan, demonstrating a Universal Faith*, by William Howitt. He added "his own conclusions from a practical examination of the higher phenomena through a course of seven years." From 1870 onwards Howitt spent the summers in Tirol and the winters in Rome, where he died on the 3rd of March 1870. Mary Howitt was much affected by his death, and in 1882 she joined the Roman Catholic Church, towards which she had been gradually moving during her connexion with spiritualism. She died at Rome on the 30th of January 1888. The Howitts are remembered for their untiring efforts to provide wholesome and instructive literature. Their son, Alfred William Howitt, made himself a name by his explorations in Australia. Anna Mary Howitt married Alaric Alfred Watts, and was the author of *Pioneers of the Spiritual Reformation* (1883).

Mary Howitt's autobiography was edited by her daughter, Margaret Howitt, in 1889. William Howitt wrote some fifty books, and his wife's publications, inclusive of translations, number over a hundred.

HOWITZER (derived, through an earlier form *howitz*, and the Ger. *Haubitze*, from the Bohemian *houfnice* = catapult, from which come also, through the Ital. *obisa* or *obice*, the French forms *obus* = shell and *obusier* = howitzer), a form of mobile ordnance in use from the 16th century up to the present day. It is a short and therefore comparatively light gun, which fires a heavy projectile at low velocity. A high angle of elevation is always given and the angle of descent of the projectile is consequently steep (up to 70°). On this fact is based the tactical use of the modern howitzer. The field howitzer is of the greatest value for "searching" trenches, folds of ground, localities, &c., which are invulnerable to direct fire, while the more powerful siege howitzer has, since the introduction of modern artillery and, above all, of modern projectiles, taken the foremost place amongst the weapons used in siege warfare.

See **ARTILLERY, ORDNANCE AND FORTIFICATION AND SIEGE CRAFT.**

HOWLER, a name applied to the members of a group of tropical American monkeys, now known scientifically as *Alouata*, although formerly designated *Myceles*. These monkeys, which are of large size, with thick fur, sometimes red and sometimes black in colour, are characterized by the inflation of the hyoid-bone (which supports the roof of the tongue) into a large shell-like organ communicating with the wind-pipe, and giving the peculiar resonance to the voice from which they take their title. To allow space for the hyoid, the sides of the lower jaw are very deep and expanded. The muzzle is projecting, and the profile of the face slopes regularly backwards from the muzzle to the crown. The long tail is highly prehensile, thickly furred, with the under surface of the extremity naked. Howlers dwell in large companies, and in the early morning, and again in the evening, make the woods resound with their cries, which are often continued throughout the night. They feed on leaves, and are in the habit of sitting on the topmost branches of trees. When active, they progress in regular order, led by an old male. (R. L.)*

HOWRAH, a city and district of British India, in the Burdwan division of Bengal. The city is situated opposite Calcutta, with which it is connected by a floating bridge. The municipal area is about 11 sq. m.; pop. (1901) 157,594, showing an increase of 35% in the decade. Since 1872 the population has almost doubled, owing to the great industrial development that has taken place. Howrah is the terminus of the East Indian railway, and also of the Bengal-Nagpur and East Coast lines. It is also the centre of two light railways which run to Amta and Sheakhala. Further, it is the headquarters of the jute-manufacturing industry, with many steam mills, steam presses, also

cotton mills, oil mills, rope-works, iron-works and engineering works. Sibpur Engineering College lies on the outskirts of the town. There is a hospital, with a department for Europeans, and Howrah forms a suburban residence for many people who have their place of business in Calcutta.

The DISTRICT OF HOWRAH extends southwards down the right bank of the Hugli to the confluence of the river Damodar. For revenue purposes it is included within the district of Hugli. Its area is 510 sq. m.; pop. (1901) 850,514, showing an increase of 11% in the decade. In addition to the two steam tramways and the East Indian railway, the district is crossed by the high-level canal to Midnapore, which communicates with the Hugli at Ulubaria. The manufacturing industries of Howrah extend beyond the city into the district. One or two systems of draining low-lying lands are maintained by the government.

HOWSON, JOHN SAUL (1816-1885), English divine, was born at Giggleswick-in-Craven, Yorkshire, on the 5th of May 1816. After receiving his early education at Giggleswick school, of which his father was head-master, he went to Trinity College, Cambridge, and there became tutor successively to the marquis of Sligo and the marquis of Lorne. In 1845 Howson, having taken orders, accepted the post of senior classical master at the Liverpool College under his friend W. J. Conybeare, whom he succeeded as principal in 1849. This post he held until 1865, and it was largely due to his influence that a similar college for girls was established at Liverpool. In 1866 he left Liverpool for the vicarage of Wisbech, and in 1867 he was appointed dean of Chester Cathedral, where he gave himself vigorously to the work of restoring the crumbling fabric, collecting nearly 100,000 in five years for this purpose. His sympathies were with the evangelical party, and he stoutly opposed the "Eastward position," but he was by no means narrow. He did much to reintroduce the ministry of women as deaconesses. The building of the King's School for boys, and the Queen's School for girls (both in Chester), was due in a great measure to the active interest which he took in educational matters. He died at Bournemouth on the 15th of December 1885, and was buried in the cloister garth of Chester. Howson's chief literary production was *The Life and Epistles of St Paul* (1852) in which he collaborated with Conybeare.

The book is still of interest, especially for its descriptive passages, which were mostly done by Howson; but later researches (such as those of Sir W. M. Ramsay) have made the geographical and historical sections obsolete, and the same may be said of the treatment of the Pauline theology.

HOWTH [pronounced *Hoth*], a seaside town of Co. Dublin, Ireland, on the rocky hill of Howth, which forms the northern horn of Dublin Bay, 9 m. N.E. by N. of Dublin by the Great Northern railway. Pop. (1901) 1166. It is frequented by the residents of the capital as a watering-place. The artificial harbour was formed (1807-1832) between the mainland and the picturesque island of Ireland's Eye, and preceded Kingstown as the station for the mail-packets from Great Britain, but was found after its construction to be liable to silt, and is now chiefly used by fishing-boats and yachts. The collegiate church, standing picturesquely on a cliff above the sea, was founded about 1235, and has a monastic building attached to it. The embattled castle contains the two-handed sword of Sir Almeric Tristram, the Anglo-Norman conqueror of the hill of Howth, and a portrait of Dean Swift holding one of the Drapier letters, with Wood, the coiner against whom he directed these attacks, prostrate before him. The view of Dublin Bay from the hill of Howth is of great beauty. Howth is connected with the capital by electric tramway, besides the railway, and another tramway encircles the hill.

HÖXTER, a town of Germany, in the Prussian province of Westphalia, prettily situated on the left bank of the Weser, and on the Prussian state railways Bössum-Soest and Scherfede-Holzminden, 32 m. N. of Cassel. Pop. (1905) 7699. It has a medieval town hall, and interesting houses with high gables and wood-carved façades of the 15th and 16th centuries. The most interesting of the churches is the Protestant church of St Kilian,

with a pulpit dating from 1505 and a font dating from 1631. There are a gymnasium, a school of architecture and a monument to Hoffmann von Fallersleben in the town. The Weser is crossed here by a stone bridge about 500 ft. in length, erected in 1833. On the Brunsberg adjoining the town there is an old watch-tower, said to be the remains of a fortress built by Bruno, brother of Widukind. Near Hörter is the castle, formerly the Benedictine monastery, of Corvey. The principal manufactures of the town are linen, cotton, cement and gutta-percha, and there is also a considerable shipping trade. Hörter (Lat. *Huzaria*) in the time of Charlemagne was a *villa regia*, and was the scene of a battle between him and the Saxons. Under the protection of the monastery of Corvey it gradually increased in prosperity, and became the chief town of the principality of Corvey. Later it asserted its independence and joined the Hanseatic League. It suffered severely during the Thirty Years' War. After the peace of Westphalia in 1648 it was united to Brunswick; in 1802 it was transferred to Nassau; and in 1807 to the kingdom of Westphalia, after the dismemberment of which, in 1814, it came into the possession of Prussia.

See Kampschulte, *Chronik der Stadt Hörter* (Hörter, 1872).

HOY (Norse *Hoey*, "high island"), the second largest island of the Orkneys, county of Orkney, Scotland. Pop. (1901) 1216. It has an extreme length from N.W. to S.E. of 13½ m., its greatest breadth from E. to W. is 8 m., and its area occupies 53 sq. m. It is situated 2 m. S.W. of Pomona, from which it is separated by Hoy Sound. As seen from the west it rises abruptly from the sea, presenting in this respect a marked contrast to the rest of the isles of the Orcadian group, which as a whole are low-lying. Its eastern and southern shores are indented by numerous bays, one of which, Long Hope, forms a natural harbour 4 m. long, with a breadth varying from ¼ m. to more than 1 m., affording to any number of vessels a haven of refuge from the roughest weather of the Pentland Firth. Off the eastern coast lie the islands of Graemsay, Cava, Risa, Fara, Flotta and Switha, while the peninsula of South Walls, forming the southern side of the harbour of Long Hope, is an island in all but name. Red and yellow sandstone cliffs, sometimes over 1000 ft. in height, stretch for 10 to 12 m. on the Atlantic front. The detached pillar or stack called the Old Man of Hoy (450 ft.) is a well-known landmark to sailors. The only break in this remarkable run of rocky coast is at Rackwick in the bight below the head of Rora. In the interior, Ward Hill (1564 ft.) is the loftiest summit in either the Orkneys or Shetlands. In the valley between Ward Hill and the ridge of the Hamars to the south-east is situated the famous Dwarfie Stone, an enormous block of sandstone measuring 28 ft. long, from 11 ft. to 14½ ft. broad, and 6½ ft. high at one end and 2 ft. high at the other, in which two rooms have been artificially hollowed out, traditionally believed to be the bed-chambers of Trollid, the dwarf of the sagas, and his wife. A boulder lying at the narrow end was supposed to be used to close the entrance. The generally accepted theory is that it was a pagan altar which some hermit afterwards converted into a cell. Other hills in the island are the Cullaga (1420 ft.) and the Knap of Trewieglen (1308 ft.), besides several peaks exceeding 1000 ft. in height. Hoy is commonly approached from Stromness, there being piers at Linkness, the nearest point to Graemsay, and at Hackness, South Ness and North Bay, the last three all on the harbour of Long Hope.

HOYLAKÉ, a watering-place in the Wirral parliamentary division of Cheshire, England, 8 m. W. of Birkenhead, on the Wirral railway. With West Kirby to the south, at the mouth of the estuary of the Dee, it forms the urban district of Hoylake and West Kirby. Pop. (1901) 10,911. The well-known links of the Royal Liverpool Golf Club are at Hoylake. The town has a considerable population of fishermen.

HOYLAND NETHER, an urban district in the Hallamshire parliamentary division of the West Riding of Yorkshire, England, 5½ m. S.S.E. of Barnsley, on the Midland railway. Collieries and brickworks employ the large industrial population. Pop. (1901) 12,464.

HOYLE, EDMUND, or **EDMOND** (1672-1769), the first systematizer of the laws of whist, and author of a book on games, was born in 1672. His parentage and place of birth are unknown, and few details of his life are recorded. For some time he was resident in London, and partially supported himself by giving instruction in the game of whist. For the use of his pupils he drew up a *Short Treatise* on the game, which after circulating for some time in manuscript was printed by him and entered at Stationers' Hall in November 1742. The laws of Hoyle continued to be regarded as authoritative until 1864, since which time they have been gradually superseded by the new rules adopted by the Arlington and Portland clubs in that year (see *WHIST*). He also published rules for various other games, and his book on games, which includes the *Short Treatise*, has passed into many editions. The weight of his authority is indicated by the phrase "according to Hoyle," which, doubtless first applied with reference to whist, has gained currency as a general proverb. Hoyle died in London on the 20th of August 1769.

HOZIER, PIERRE D', SEIGNEUR DE LA GARDE (1592-1660), French genealogist, was born at Marseilles on the 10th of July 1592. In 1616 he entered upon some very extensive researches into the genealogy of the noble families of the kingdom, in which work he was aided by his prodigious memory for dates, names and family relationships, as well as by his profound knowledge of heraldry. In 1634 he was appointed historiographer and genealogist of France, and in 1641 *juge d'armes* of France, an officer corresponding nearly to the Garter king-of-arms in England. In 1643 he was employed to verify the claims to nobility of the pages and equerries of the king's household. He accumulated a large number of documents, but published comparatively little, his principal works being *Recueil armorial des anciennes maisons de Bretagne* (1638); *Les noms, surnoms, qualités, armes et blasons des chevaliers et officiers de l'ordre du Saint-Esprit* (1634); and the genealogies of the houses of La Rochefoucauld (1654), Bourbonville (1657) and Amanzé (1650). He was renowned as much for his uprightness as for his knowledge, no slight praise in a profession exposed to so many temptations to fraud. He died in Paris on the 1st of December 1660. At his death his collections comprised more than 150 volumes or portfolios of documents and papers relating to the genealogy of the principal families in France. Of his six sons, only two survived him. His eldest son, Louis Roger d'Hozier (1634-1708), succeeded him as *juge d'armes*, but became blind in 1675, and was obliged to surrender his office to his brother.

CHARLES RENÉ D'HOZIER (1640-1732), younger son of Pierre, was the true continuator of his father. In addition to his commentary appended to Antoine Varillas's history of King Charles IX. (1686 ed.), he published *Recherches sur la noblesse de Champagne* (1673). On the promulgation in 1696 of an edict directing all who had armorial bearings to register them on payment of 20 livres, he was employed to collect the declarations returned in the various *généralités*, and established the *Armorial général de France*. This work, which contained not only the armorial bearings of noble families, but also of those commoners who were entitled to bear arms, is not complete, inasmuch as many refused to register their arms, either from vanity or from a desire to evade the fee.

The collection (now in the Bibliothèque Nationale) consists of 34 volumes of text and 35 of coloured armorial bearings, and in spite of its deficiencies is a useful store of information for the history of the old French families. It contains 60,000 names, grouped according to Burgundy and provincial subdivisions. The sections relating to Burgundy and Franche-Comté were published by Henri Bouchot (1875-1876); those relating to the *généralité* of Limoges, by Moreau de Fravioux (1895); and those for the *département* of Reims, by P. Gosset (1903).

In 1717, in consequence of a quarrel with his nephew Louis Pierre, son of Louis Roger, Charles sold his collection to the king. It then comprised 160 portfolios of genealogical papers arranged alphabetically, 175 volumes of documents, and numerous printed books profusely annotated. In 1720 it was inventoried by P. de Clairambault, who added a certain number of genealogies taken from the papers of F. R. de Gaignières, increasing the

total to 217 boxes and portfolios. Thus originated the *Cabinet des livres* of the Bibliothèque Nationale. Charles subsequently became reconciled to his nephew, to whom he left all the papers he had accumulated from the date of the quarrel until his death, which occurred in Paris on the 13th of February 1732.

LOUIS PIERRE D'HOZIER (1685-1767), son of Louis Roger, succeeded his uncle Charles as *juge d'armes*. He published the *Armorial général, ou registre de la noblesse de France* (10 vols., 1738-1768), which must not be confounded with the publication mentioned above, inasmuch as it related solely to noble families and was not an official collection. Complete copies of this work, which should contain six *registres*, are comparatively rare. A seventh *registre*, forming vol. xi., prepared by Ambroise Louis Marie, nephew of Louis Pierre, was published in 1847 by comte Charles d'Hozier. Louis Pierre died on the 25th of September 1767. His eldest son, Antoine Marie d'Hozier de Sérigny (1721-c. 1810), was his father's collaborator and continuator; and his fourth son, Jean François Louis, wrote an account of the knights of St Michael in the province of Poitou, which was published in 1896 by the vicomte P. de Chabot.

His nephew, AMBROISE LOUIS MARIE D'HOZIER (1764-1846), was the last of the *juges d'armes* of France. He held the position of president of the *cour des comptes, aides et finances* of Normandy, and was therefore generally known as President d'Hozier, to distinguish him from the other members of the family. After the Restoration he was employed to verify French armorial bearings for the *conseil du sceau des titres*. He died in obscurity. His collection, which was purchased in 1851 by the Bibliothèque Nationale, comprised 136 volumes, 165 portfolios of documents and 200 packets of extracts from title-deeds, known as the *Carrés d'Hozier*.

ABRAHAM CHARLES AUGUSTE D'HOZIER (1775-1846), who also belonged to his family, was implicated in the conspiracy of Georges Cadoudal, and was condemned to death, but Bonaparte spared his life. He did not, however, recover his liberty until after the fall of the emperor, and died at Versailles on the 24th of August 1846. (C. B.*)

HRABANUS MAURUS MAGNENTIUS (c. 776-856), archbishop of Mainz, and one of the most prominent teachers and writers of the Carolingian age, was born of noble parents at Mainz. Less correct forms of his name are Rabanus and Rhabanus. The date of his birth is uncertain, but in 801 he received deacon's orders at Fulda, where he had been sent to school; in the following year, at the instance of Ratgar, his abbot, he went together with Haimon (afterwards of Halberstadt) to complete his studies at Tours under Alcuin, who in recognition of his diligence and purity gave him the surname of Maurus, after St Maur the favourite disciple of Benedict. Returning after the lapse of two years to Fulda, he was entrusted with the principal charge of the school, which under his direction rose into a state of great efficiency for that age, and sent forth such pupils as Walafrid Strabo, Servatus Lupus of Ferrières and Otfrid of Weissenburg. At this period it is most probable that his *Excerptio* from the grammar of Priscian, long so popular as a text-book during the middle ages, was compiled. In 814 he was ordained a priest; but shortly afterwards, apparently on account of disagreement with Ratgar, he was compelled to withdraw for a time from Fulda. This "banishment" is understood to have occasioned the pilgrimage to Palestine to which he alludes in his commentary on Joshua. He returned to Fulda on the election of a new abbot (Eigil) in 817, upon whose death in 822 he himself became abbot. The duties of this office he discharged with efficiency and success until 842, when, in order to secure greater leisure for literature and for devotion, he resigned and retired to the neighbouring cloister of St Peter's. In 847 he was again constrained to enter public life by his election to succeed Otgar in the archbishopric of Mainz, which see he occupied for upwards of eight years. The principal incidents of historical interest belonging to this period of his life were those which arose out of his relations to Gottschalk (q.v.); they may be regarded as thoroughly typical of that cruel intolerance which he shared with all his contemporaries, and also of that ardent zeal which was peculiar to himself;

but they hardly do justice to the spirit of kindly benevolence which in less trying circumstances he was ever ready to display. He died at Winkel on the Rhine, on the 4th of February 856. He is frequently referred to as St Rabanus, but incorrectly.

His voluminous works, many of which remain unpublished, comprise commentaries on a considerable number of the books both of canonical and of apocryphal Scripture (Genesis to Judges, Ruth, Kings, Chronicles, Judith, Esther, Canticles, Proverbs, Wisdom, Ecclesiasticus, Jeremiah, Lamentations, Ezekiel, Maccabees, Mattheæ, the Epistles of St Paul, including Hebrews); and various treatises relating to doctrinal and practical subjects, including more than one series of Homilies. Perhaps the most important is that *De institutione clericorum*, in three books, by which he did much to bring into prominence the views of Augustine and Gregory the Great as to the training which was requisite for a right discharge of the clerical function; the most popular has been a comparatively worthless tract *De laudibus sanctæ crucis*. Among the others may be mentioned the *De universo libri xxii., sive etymologiarum opus*, a kind of dictionary or encyclopædia, designed as a help towards the historical and mystical interpretation of Scripture, the *De sacris ordinibus*, the *De disciplina ecclesiastica* and the *Martyrologium*. All of them are characterized by erudition (he knew even some Greek and Hebrew) rather than by originality of thought. The poems are of singularly little interest or value, except as including one form of the "Veni Creator." In the annals of German philology a special interest attaches to the *Glossariæ Latio-Theodisæ*. A commentary, *Super Porphyrium*, printed by Cousin in 1836 among the *Ouvrages inédits d'Abelard*, and assigned both by that editor and by Hauréau to Rabanus Maurus, is now generally believed to have been the work of a disciple.

The first nominally complete edition of the works of Rabanus Maurus was that of Colvener (Cologne, 6 vols. fol., 1627). The *Opera omnia* form vols. cvii-cxii. of Migne's *Patrologiæ cursus completus*. The *De universo* is the subject of *Compendium der Naturwissenschaften an der Schule zu Fulda im IX. Jahrhundert* (Berlin, 1880). Maurus is the subject of monographs by Schwarz (*De Rhabano Mauro primo Germaniæ præceptore*, 1811), Kunstmann (*Historische Monographie über Hrabanus Magnentius Maurus*, 1841), Spengler (*Leben des heil. Rhabanus Maurus*, 1856) and Köhler (*Rhabanus Maurus u. die Schule zu Fulda*, 1870). Lines by his disciple Rudolphus and by Joannes Tritheimus are printed in the Cologne edition of the *Opera*. See also Pertz, *Monum. Germ. Hist.* (i. and ii.); Bähr, *Gesch. d. römischen Literatur im Karoling. Zeitalter* (1840), and Hauck's article in the *Herzog-Hauck Realencyclopædie*, ed. 3.

HRÓLFR KRAKI, perhaps the most famous of the Danish kings of the heroic age. In *Beowulf*, where he is called Hrothwulf, he is represented as reigning over Denmark in conjunction with his uncle Hrothgar, one of the three sons of an earlier king called Healdene. In the Old Norse sagas Hrólf is the son of Helgi (Halga), the son of Haldan (Healdene). He is represented as a wealthy and peace-loving monarch similar to Hrothgar in *Beowulf*, but the latter (Hróarr, or Roe) is quite overshadowed by his nephew in the Northern authorities. The chief incidents in Hrólf's career are the visit which he paid to the Swedish king Atilis (Beowulf's Eadgils), of which several different explanations are given, and the war, in which he eventually lost his life, against his brother-in-law Hljóvarðr. The name KRAKI (pole-ladder) is said to have been given to him on account of his great height by a young knight named Vögg, whom he handsomely rewarded and who eventually avenged his death on Hljóvarðr. There is no reason to doubt that Hrólf was an historical person and that he reigned in Denmark during the early years of the 6th century, but the statement found in all the sagas that he was the stepson of Atilis seems hardly compatible with the evidence of *Beowulf*, which is a much earlier authority.

See Saxo Grammaticus, *Gesta Danorum*, pp. 52-58, ed. A. Holder (Strassburg, 1886); and A. Olrik, *Danmarks Heltedigtning* (Copenhagen, 1903).

HROSVITHA (frequently ROSWITHA, and properly HROSTURT), early medieval dramatist and chronicler, occupies a very notable position in the history of modern European literature. Her endeavours formed part of the literary activity by which the age of the emperor Otto the Great sought to emulate that of Charles the Great. The famous nun of Gandersheim has occasionally been confounded with her namesake, a learned abbess of the same convent, who must have died at least half a century earlier. The younger Hrosvitha was born in all probability about the year 935; and, if the statement be correct that she sang the praises of the three Ottos, she must have lived to near the close of the

century. Some time before the year 959 she entered the Benedictine nunnery of Gandersheim, a foundation which was confined to ladies of German birth, and was highly favoured by the Saxon dynasty. In 959 Gerberga, daughter of Duke Henry of Bavaria and niece of the emperor Otto I., was consecrated abbess of Gandersheim; and the earlier literary efforts of the youthful Hrosvitha (whose own connexion with the royal family appears to be an unauthenticated tradition) were encouraged by the still more youthful abbess, and by a nun of the name of Richarda.

The literary works of Hrosvitha, all of which were as a matter of course in Latin, divide themselves into three groups. Of these the first and least important comprises eight narrative religious poems, in leonine hexameters or distichs. Their subjects are the Nativity of the Virgin (from the apocryphal gospel of St James, the brother of our Lord), the Ascension and a series of legends of saints (Gandolph, Pelagius, Theophilus, Basil, Denis, Agnes). Like these narrative poems, the dramas to which above all Hrosvitha owes her fame seem to have been designed for reading aloud or recitation by sisters of the convent. For though there are indications that the idea of their representation was at least present to the mind of the authoress, the fact of such a representation appears to be an unwarrantable assumption. The comedies of Hrosvitha are six in number, being doubtless in this respect also intended to recall their nominal model, the comedies of Terence. They were devised on the simple principle that the world, the flesh and the devil should not have all the good plays to themselves. The experiment upon which the young Christian dramatist ventured was accordingly, although not absolutely novel, audacious enough. In form the dramas of "the strong voice of Gandersheim," as Hrosvitha (possibly alluding to a supposed etymology of her name) calls herself, are by no means Terentian. They are written in prose, with an element of something like rhythm, and an occasional admixture of rhyme. In their themes, and in the treatment of these; they are what they were intended to be, the direct opposites of the lightsome adapter of Menander. They are founded upon legends of the saints, selected with a view to a glorification of religion in its supremest efforts and most transcendental aspects. The emperor Constantine's daughter, for example, Constantia, gives her hand in marriage to *Gallicanus*, just before he starts on a Scythian campaign, though she has already taken a vow of perpetual maidenhood. In the hour of battle he is himself converted, and, having on his return like his virgin bride chosen the more blessed unmarried state, dies as a Christian martyr in exile. The three holy maidens, Agape, Chlonia and Irene, are preserved by a humorous miracle from the evil designs of *Dulcinius*, to offer up their pure lives as a sacrifice under Diocletian's persecutions. *Callimachus*, who has Romeo-like carried his earthly passion for the saintly Drusiana into her tomb, and among its horrors has met with his own death, is by the mediation of St John raised with her from the dead to a Christian life. All these themes are treated with both spirit and skill, often with instinctive knowledge of dramatic effect—often with genuine touches of pathos and undeniable felicities of expression. In *Dulcinius* there is also an element of comedy, or rather of farce. How far Hrosvitha's comedies were an isolated phenomenon of their age in Germany must remain undecided; in the general history of the drama they form the visible bridge between the few earlier attempts at utilizing the forms of the classical drama for Christian purposes and the miracle plays. They are in any case the productions of genius; nor has Hrosvitha missed the usual tribute of the supposition that Shakespeare has borrowed from her writings.

The third and last group of the writings of Hrosvitha is that of her versified historical chronicles. At the request of the abbess Gerberga, she composed her *Carmen de gestis Odoonis*, an epic attempting in some degree to follow the great Roman model. It was completed by the year 968, and presented by the authoress to both the old emperor and his son (then already crowned as) Otto II. This poem so closely adheres to the materials supplied to the authoress by members of the imperial family

that, notwithstanding its courtly omissions, it is regarded as an historical authority. Unfortunately only half of it remains; the part treating of the period from 953 to 962 is lost with the exception of a few fragments, and the period from 962 to 967 is summarized only. Subsequently, in a poem (of 837 hexameters) *De primordiis et fundationibus coenobii Gandersheimensis*, Hrosvitha narrated the beginnings of her own convent, and its history up to the year 919.

The Munich MS., which contains all the works enumerated above except the *Chronicle of Gandersheim*, was edited by the great Vienna humanist, Conrad Celtes, in 1501. The edition of Celtes was published at Nuremberg, with eight wood-cuts by Albrecht Dürer. It was re-edited by H. L. Schurzleisch and published at Wittenberg in 1707. The comedies have been edited and translated into German by J. Bendixen (Lübeck, 1857), and into French by C. Magnin (Paris, 1845), whose introduction gives a full account of the authoress and her works. See also her *Poésies latines*, with a translation into French verse by V. Rétif de la Bretonne (Paris, 1854). A copious analysis of her plays will be found in Klein, *Geschichte des Dramas*, iii. 665-754. See also W. Creizenach, *Geschichte der neueren Dramas*, I. 17 sqq. (Halle, 1893); and A. W. Ward, *History of English Dramatic Literature*, i. 6 sqq. (Cambridge, 1899). Gustav Freytag wrote a dissertation, *De Rosutha poetria* (Breslau, 1839), to qualify himself as an academical teacher, which, as he records (*Erinnerungen aus meinem Leben*, Leipzig, 1887, p. 1839), showed "how impossible it was to the German, a thousand years since, to compose dramatically"; and at the beginning of Albert Cohn's *Shakespeare in Germany* (Berlin, 1865) Shakespearean parallels are suggested to certain passages in Hrosvitha's dramas. Her two chronicles in verse were edited by Z. H. Pertz in the *Monumenta Germaniae*, iv. 306-325 (Hanover, 1841). See also J. P. Migne, *Patrologiae curs. compl.* (Paris, 1853, vol. 137). The *Carmen* was included by Leibnitz in his *Scriptores rer. Brunsvic.* (Hanover, 1707-1711). For other early editions of these see A. Pothast, *Bibliotheca historica medii aevi* (supplement, Berlin, 1862-1868); and for an appreciation of them see Wattenbach, *Geschichtsquellen*, pp. 214-216, and Giesebrecht, *Deutsche Kaiserzeit*, i. 780, who mentions a German translation by Pfund (1860). There is a complete edition of the works of Hrosvitha by K. A. Barack (Nürnberg, 1858). J. Aschbach (1867) attempted to prove that Celtes had forged the productions which he published under the name of Hrosvitha, but he was refuted by R. Köpke (Berlin, 1869). Anatole France, *La Vie littéraire* (3^{ème} série, Paris, 1891), cited by Creizenach, mentions a curious recent experiment, the performance of Hrosvitha's comedies in the *Théâtre des Marionnettes* at Paris. (A. W. W.)

HSÜAN TSANG (HIODEN TSBANG, HIWEN T'SANG, YUAN TSBANG, YUAN-CHWANG), the most eminent representative of a remarkable and valuable branch of Chinese literature, consisting of the narratives of Chinese Buddhists who travelled to India, whilst their religion flourished there, with the view of visiting the sites consecrated by the history of Sakya Muni, of studying at the great convents which then existed in India, and of collecting books, relics and other sacred objects.

The importance of these writings as throwing light on the geography and history of India and adjoining countries, during a very dark period, is great, and they have been the subject of elaborate commentaries by modern students. Several Chinese memoirs of this kind appear to have perished; and especially to be regretted is a great collection of the works of travellers to India, religious and secular, in sixty books, with forty more of maps and illustrations, published at the expense of the emperor Kao-Tsung of the T'ang dynasty, A.D. 666, with a preface from the imperial hand. We will mention the clerical travellers of this description who are known to us by name. 1. *Shi-tao-an* (d. 385) wrote a work on his travels to the "western lands" (an expression applying often to India), which is supposed to be lost. 2. *Fa-hien* travelled to India in 399, and returned by sea in 414. His work, called *Fo-Kuo-Ki*, or *Memoirs on the Buddha Realm*, has been translated by Abel-Rémusat and Landresse, and again into English by the Rev. S. Beale; Mr Laidlay of Calcutta also published a translation from the French, with interesting notes. 3. *Hsui Seng* and *Sung-Yun*, monks, travelled to India to collect books and reliques, 518-521. Their short narrative has been translated by Karl Fried. Neumann, and also by Mr Beale (along with Fa-hien). 4. *Hsuan Tsang*, the subject of this notice. In relation to his travels there are two Chinese works, both of which have been translated with an immense appliance of labour and learning by M. Stanislas Julien, viz. (a) the *Ta-Tang-Si-Yu-Ki*, or *Memoirs on Western Countries issued by the T'ang Dynasty*, which was compiled under the traveller's own supervision, by order of the great emperor Tai-Tsung; and (b) a *Biography of Hsuan Tsang* by two of his contemporaries. 5. *The Itinerary of Fifty-six Religious Travellers*, compiled and published under imperial authority, 730. 6. *The Itinerary of K'hi-Nie*, who travelled (964-976) at the head of a large body of monks to collect books, &c. Neither of the last two has been translated.

Hsüan Tsang was born in the district of Keu-Shi, near Honan-Fu, about 605, a period at which Buddhism appears to have had a powerful influence upon a large body of educated Chinese. From childhood grave and studious, he was taken in charge by an elder brother who had adopted the monastic life, in a convent at the royal city of Loyang in Honan. Hsüan Tsang soon followed his brother's example. For some years he travelled over China, teaching and learning, and eventually settled for a time at the capital Chang-gan (now Si-gan-fu in Shensi), where his fame for learning became great. The desire which he entertained to visit India, in order to penetrate all the doctrines of the Buddhist philosophy, and to perfect the collections of Indian books which existed in China, grew irresistible, and in August 629 he started upon his solitary journey, eluding with difficulty the strict prohibition which was in force against crossing the frontier.

The "master of the law," as his biographers call him, plunged alone into the terrible desert of the Gobi, then known as the Sha-mo or "Sand River," between Kwa-chow and Igu (now Hami or Kamil). At long intervals he found help from the small garrisons of the towers that dotted the desert track. Very striking is the description, like that given six centuries later by Marco Polo, of the quasi-supernatural horrors that beset the lonely traveller in the wilderness—the visions of armies and banners; and the manner in which they are dissipated singularly recalls passages in Bunyan's *Pilgrim's Progress*. After great suffering Hsüan Tsang reached Igu, the seat of a Turkish principality, and pursued his way along the southern foot of the T'ian-shan, which he crossed by a glacier pass (vividly described) in the longitude of Lake Issyk-kul. In the valley of the Talas river he encounters the great khan of the Turks on a hunting party,—a rencontre which it is interesting to compare with the visit of Zernichus to the great khan Dizabul, sixty years before, in the same region. Passing by the present Tashkend, and by Samarkand, then inhabited by fire worshippers, he reached the basin of the Upper Oxus, which had recently been the seat of the powerful dominion of the Haiathelah, Ephthalites or White Huns, known in earlier days to the Greeks as *Tochari*, and to Hsüan Tsang (by the same name) as *Tukolo* or *Tukhāra*. His account of the many small states into which the Tukhara empire had broken up is of great interest, as many of them are identical in name and topography with the high valley states and districts on the Upper Oxus, which are at this day the object of so much geographical and political interest.

Passing by Bamian, where he speaks of the great idols still so famous, he crosses Hindu-Kush, and descends the valley of the Kabul river to Nagarahara, the site of which, still known as Nagara, adjoining Jalalabad, has been explored by Mr W. Simpson. Travelling thence to Peshawar (*Purushapura*), the capital of Gandhara, he made a digression, through the now inaccessible valley of Swat and the Dard states, to the Upper Indus, returning to Peshawar, and then crossing the Indus (*Sindu*) into the decayed kingdom of *Taxila* (Ta-cha-si-lo, Takshasila), then subject to Kashmir. In the latter valley he spent two whole years (631-633) studying in the convents, and visiting the many monuments of his faith. In his further travels he visited Mathura (*Ma'ulo*, Muttra), whence he turned north to Thanesar and the upper Jumna and Ganges, returning south down the valley of the latter to Kanyakubja or Kanauj, then one of the great capitals of India. The pilgrim next entered on a circuit of the most famous sites of Buddhist and of ancient Indian history, such as Ajodhya, Prayaga (Allahabad), Kausambhi, Sravasti, Kapilavastu, the birth-place of Sakya, Kusinagara, his death-place, Pataliputra (Patna, the *Palibothra* of the Greeks), Gaya, Rajagriha and Nalanda, the most famous and learned monastery and college in India, adorned by the gifts of successive kings, of the splendour of which he gives a vivid description, and of which traces have recently been recovered. There he again spent nearly two years in mastering Sanskrit and the depths of Buddhist philosophy. Again, proceeding down the banks of the Ganges, he diverged eastward to Kamarupa (Assam), and then passed by the great ports of Tamralipti (Tamruk, the mis-

placed *Tamralitis* of Ptolemy), and through Orissa to Kanchipera (Conjeeveram), about 640. Thence he went northward across the Carnatic and Maharashtra to Barakcheva (Broach of our day, *Barygasa* of the Greeks). After this he visited the Malwa, Cutch, Surashtra (peninsular Gujrat, *Syrastrene* of the Greeks), Sind, Multan and Ghazni, whence he rejoined his former course in the basin of the Kabul river.

This time, however, he crosses Pamir, of which he gives a remarkable account, and passes by Kashgar, Khotan (*Kustana*), and the vicinity of Lop-nor across the desert to Kwa-chow, whence he had made his venturesome and lonely plunge into the waste fifteen years before. He carried with him great collections of books, precious images and reliques, and was received (April 645) with public and imperial enthusiasm. The emperor T'ai-Tsung desired him to commit his journey to writing, and also that he should abandon the eremitic rule and serve the state. This last he declined, and devoted himself to the compilation of his narrative and the translation of the books he had brought with him from India. The former was completed A.D. 648. In 664 Hsüan Tsang died in a convent at Chang-gan. Some things in the history of his last days, and in the indications of beatitude recorded, strongly recall the parallel history of the saints of the Roman calendar. But on the other hand we find the Chinese saint, on the approach of death, causing one of his disciples to frame a catalogue of his good works, of the books that he had translated or caused to be transcribed, of the sacred pictures executed at his cost, of the aims that he had given, of the living creatures that he had ransomed from death. "When Kia-shang had ended writing this list, the master ordered him to read it aloud. After hearing it the devotees clasped their hands, and showered their felicitations on him." Thus the "well-done, good and faithful" comes from the servant himself in self-applause.

The book of the biography, by the disciples Hwai-li and Yen-t'sung, as rendered with judicious omissions by Stan. Julien, is exceedingly interesting; its Chinese style receives high praise from the translator, who says he has often had to regret his inability to reproduce its grace, elegance and vivacity.

AUTHORITIES.—*Fo-Koue-Ki*, trad. du Chinois, par Abel-Rémusat, revu et complété par Klaproth et Landresse (Paris, 1836); *H. de la vie de Hiouen-Tsang, &c.*, trad. du Chinois par Stanislas Julien (Paris, 1853); *Mémoires sur les contrées occidentales . . . trad. du Chinois en Français* (par le même) (2 vols., Paris, 1857-1859); *Mémoire analytique, &c.*, attached to the last work, by L. Vivien de St. Martin; "Attempt to identify some of the Places mentioned in the Itinerary of Hiuan Tsang," by Major Wm. Anderson, C.B., in *Journ. As. Soc. Bengal*, vol. xvi, pt. 2, p. 1183 (the enunciation of a singularly perverse theory); "Verification of the Itinerary of Hsuan Tsang, &c.," by Captain Alex. Cunningham, Bengal Engineers, *ibid.* vol. xvii, pt. 1, p. 476; *Travels of Fah-hian and Sung-Yan, Buddhist Pilgrims, &c.*, by Sam. Beal (1860); *The Ancient Geography of India*, by Major-General Alex. Cunningham, R.E. (1871); "Notes on Hwen Tshang's Account of the Principalities of Tokharistan," by Colonel H. Yule, C.B., in *Journ. Roy. As. Soc.*, new ser., vol. vi, p. 82; "On Hiouen Tshang's Journey from Patna to Ballabhi," by James Fergusson, D.C.L., *ibid.* p. 213. (H. Y.; R. K. D.)

HUAMBISAS, a tribe of South American Indians on the upper Marañon and Santiago rivers, Peru. In 1841 they drove all the civilized Indians from the neighbouring missions. In 1843 they killed all the inhabitants of the village of Santa Teresa, between the mouths of the Santiago and Morona. They are fair-skinned and bearded, sharing with the Jeveeros a descent from the Spanish women captured by their Indian ancestors at the sack of Sevilla del Oro in 1599.

HUANCAVELICA, a city of central Peru and capital of a department, 160 m. S.E. of Lima. The city stands in a deep ravine of the Andes at an elevation of about 12,400 ft. above the sea, the ravine having an average width of 1 m. Pop. (1906 estimate) 6000. The city is solidly and regularly built, the houses being of stone and the stream that flows through the town being spanned by several stone bridges. Near Huancavelica is the famous quicksilver mine of Santa Barbara, with its subterranean church of San Rosario, hewn from the native cinnabar-bearing rock. Huancavelica was founded by Viceroy Francisco de Toledo in 1572 as a mining town, and mining continues to be the principal occupation of its inhabitants. The

department is traversed by the Cordillera Occidental, and is bounded N., E. and S. by Junin and Ayacucho. Pop. (1906 official estimate) 167,840; area, 9254 sq. m. The principal industry is mining for silver and quicksilver. The best-known silver mines are the Castrovirreyra.

HUÁNUCO, a city of central Peru, capital of a department, 170 m. N.N.E. of Lima in a beautiful valley on the left bank of the Huallaga river, nearly 6000 ft. above sea-level. Pop. (1906 estimate) about 6000. The town was founded in 1539 by Gomez Alvarado. Huánuco is celebrated for its fruits and sweetmeats, the "chirimoya" (*Annona chirimolia*) of this region being the largest and most delicious of its kind. Mining is one of the city's industries. Huánuco was the scene of one of the bloodthirsty massacres of which the Chileans were guilty during their occupation of Peruvian territory in 1881-1883. The department of Huánuco lies immediately N. of Junin, with Ancachs on the W. and San Martin and Loreto on the N. and E. Pop. (1906 estimate) 108,080; area, 14,028 sq. m. It lies wholly in the Cordillera region, and is traversed from S. to N. by the Marañon and Huallaga rivers.

HUARAZ, a city of northern Peru and capital of the department of Ancachs, on the left bank of the Huaraz, or Santa river, about 190 m. N.N.W. of Lima and 58 m. from the coast. Pop. (1876) 4851, (1906 estimate) 6000. Huaraz is situated in a narrow fertile valley of the Western Cordillera, at a considerable elevation above sea-level, and has a mild climate. A railway projected to connect Huaraz with the port of Chimbote, on the Bay of Chimbote; a few miles S. of the mouth of the Santa river, was completed from Chimbote to Suchimán (33 m.) in 1872, when work was suspended for want of money. In the valley of the Huaraz cattle are raised, and wheat, sugar and fruit, gold, silver, copper and coal are produced. Alfalfa is grown by stock-raisers, and the cattle raised here are among the best in the Peruvian market. In the vicinity of Huaraz are megalithic ruins similar to those of Tiabunaco and Cuzco, showing that the aboriginal empire preceding the Incas extended into northern Peru.

HUARTE DE SAN JUAN, or **HUARTE Y NAVARRO, JUAN** (c. 1530-1592), Spanish physician and psychologist, was born at Saint-Jean-Pied-de-Port (Lower Navarre) about 1530, was educated at the university of Huesca, where he graduated in medicine, and, though it appears doubtful whether he practised as a physician at Huesca, distinguished himself by his professional skill and heroic zeal during the plague which devastated Baeza in 1566. He died in 1592. His *Examen de ingenios para las ciencias* (1575) won him a European reputation, and was translated by Lessing. Though now superseded, Huarte's treatise is historically interesting as the first attempt to show the connexion between psychology and physiology, and its acute ingenuity is as remarkable as the boldness of its views.

HUASTECS, a tribe of North American Indians of Mayan stock, living to the north of Vera Cruz. They are of interest to the ethnologist as being so entirely detached from the other Mayan tribes of Central America. The theory is that the Mayas came from the north and that the Huastecs were left behind in the migration southward.

HUBER, FRANÇOIS (1750-1831), Swiss naturalist, was born at Geneva on the 2nd of July 1750. He belonged to a family which had already made its mark in the literary and scientific world: his great-aunt, Marie Huber (1695-1753), was known as a voluminous writer on religious and theological subjects, and as the translator and epitomizer of the *Spectator* (Amsterdam, 3 vols., 1753); and his father Jean Huber (1721-1786), who had served for many years as a soldier, was a prominent member of the coterie at Ferney, distinguishing himself by his *Observations sur le vol des oiseaux* (Geneva, 1784). François Huber was only fifteen years old when he began to suffer from an affection of the eyes which gradually resulted in total blindness; but, with the aid of his wife, Marie Aimée Lullin, and of his servant, François Burnens, he was able to carry out investigations that laid the foundations of our scientific knowledge of the life history of the honey-bee. His *Nouvelles Observations sur les abeilles* was published at Geneva in 1792 (Eng. trans., 1806). He assisted Jean

Senebier in his *Mém. sur l'influence de l'air, &c., dans la germination* (Geneva, 1800); and he also wrote "Mém. sur l'origine de la cire" (*Bibliothèque britannique*, tome xxv), a "Lettre à M. Pictet sur certains dangers que courent les abeilles" (*Bib. brit.* xxvii), and "Nouvelles Observ. rel. au sphinx Atropos" (*Bib. brit.* xxvii). He died at Lausanne on the 22nd of December 1831. De Candolle gave his name to a genus of Brazilian trees—*Huberia laurina*.

PIERRE HUBER (1777-1840) followed in his father's footsteps. His best-known work is *Recherches sur les mœurs des fourmis indigènes* (Geneva and Paris, 1810; new ed., Geneva, 1861), and he also wrote various papers on entomological subjects.

See the account of François Huber, by De Candolle, in *Bibl. universelle* (1832); and the notice of Pierre in *Bibl. univ.* (1886); also Haag, *La France protestante*.

HUBER, JOHANN NEPOMUK (1830-1870), German philosophical and theological writer, a leader of the Old Catholics, was born at Munich on the 18th of August 1830. Originally destined for the priesthood, he early began the study of theology. By the writings of Spinoza and Oken, however, he was strongly drawn to philosophical pursuits, and it was in philosophy that he "habilitated" (1854) in the university of his native place, where he ultimately became professor (extraordinarius, 1859; ordinarius, 1864). With Döllinger and others he attracted a large amount of public attention in 1869 by the challenge to the Ultramontane promoters of the Vatican council in the treatise *Der Papst und das Concil*, which appeared under the pseudonym of "Janus," and also in 1870 by a series of letters (*Römische Briefe*, a redaction of secret reports sent from Rome during the sitting of the council), which were published under the pseudonym Quirinus in the *Allgemeine Zeitung*. He died suddenly of heart disease at Munich on the 20th of March 1870.

WORKS.—The treatise *Über die Willensfreiheit* (1858), followed in 1859 by *Die Philosophie der Kirchenväter*, which was promptly placed upon the Index, and led to the prohibition of all Catholic students from attending his lectures; *Johannes Scotus Erigena* (1861); *Die Idee der Unsterblichkeit* (1864); *Studien* (1867); *Der Proletariat; zur Orientierung in der sozialen Frage* (1865); *Der Jesuitenorden nach seiner Verfassung und Doctrin, Wirkamkeit und Geschichte* (1873), also placed upon the Index; *Der Pessimismus* (1876); *Die Forschung nach der Materie* (1877); *Zur Philosophie der Astronomie* (1878); *Das Gedächtnis* (1878). He also published adverse criticisms of Darwin, Strauss, Hartmann and Häckel; pamphlets on *Das Papsttum und der Staat* (1870), and on *Die Freiheiten der französischen Kirche* (1871); and a volume of *Kleine Schriften* (1871).

See E. Zirngiebl, *Johannes Huber* (1881); and M. Carrière in *Allgemeine deutsche Biographie*, xiii. (1881), and in *Nord und Süd* (1879).

HUBER, LUDWIG FERDINAND (1764-1804), German author, was born in Paris on the 14th of September 1764, the son of Michael Huber (1727-1804), who did much to promote the study of German literature in France. In his infancy young Huber removed with his parents to Leipzig, where he was carefully instructed in modern languages and literature, and showed a particular inclination for those of France and England. In Leipzig he became intimate with Christian Gottfried Körner, father of the poet; in Dresden Huber became engaged to Dora Stock, sister of Körner's betrothed, and associated with Schiller, who was one of Körner's staunchest friends. In 1787 he was appointed secretary to the Saxon legation in Mainz, where he remained until the French occupation of 1792. While here he interested himself for the welfare of the family of his friend Georg Forster, who, favouring republican views, had gone to Paris, leaving his wife Therese Forster (1764-1829) and family in destitute circumstances. Huber, enamoured of the talented young wife, gave up his diplomatic post, broke off his engagement to Dora Stock, removed with the Forster family to Switzerland, and on the death of her husband in 1794 married Therese Forster. In 1798 Huber took over the editorship of the *Allgemeine Zeitung* in Stuttgart. The newspaper having been prohibited in Württemberg, Huber continued its editorship in Ulm in 1803. He was created "counsellor of education" for the new Bavarian province of Swabia in the following year, but had hardly entered upon the functions of his new office when he died on the 24th of December 1804.

Huber was well versed in English literature, and in 1785 he published the drama *ElkeWolf*, with notes on Beaumont and Fletcher and the old English stage. He also wrote many dramas, comedies and tragedies, most of which are now forgotten, and among them only *Das heimliche Gericht* (1790, new ed. 1795) enjoyed any degree of popularity. As a critic he is seen to advantage in the *Vermischte Schriften von dem Verfasser des heimlichen Gerichts* (2 vols., 1793). As a publicist he made his name in the historical-political periodicals *Friedenspräliminarien* (1794-1796, 10 vols.) and *Klio* (1795-1798, 1819).

His collected works, *Sämtliche Werke seit dem Jahre 1802* (4 vols., 1807-1819), were published with a biography by his wife Therese Huber. See L. Speidel and H. Wittmann, *Bilder aus der Schiller-Zeit* (1884).

HUBERT (HUCBERTUS, HUGBERTUS), ST (d. 727), bishop of Liège, whose festival is celebrated on the 3rd of November. The Bollandists have published seven different lives of the saint. The first is the only one of any value, and is the work of a contemporary. Unfortunately, it is very sparing of details. In it we see that Hubert in 708 succeeded Lambert in the see of Maestricht (Tongres), and that he erected a basilica to his memory. In 825 Hubert's remains were removed to a Benedictine cloister in the Ardennes, which thenceforth bore his name (St Hubert, province of Luxemburg, Belgium), and ultimately became a considerable resort of pilgrims. The later legends (*Bibliotheca hagiographica latina*, nos. 3994-4002) are devoid of authority. One of them relates, probably following the legend of St Eustace, the miracle of the conversion of St Hubert. This conversion, represented as having been brought about while he was hunting on Good Friday by a miraculous appearance of a stag bearing between his horns a cross or crucifix surrounded with rays of light, has frequently been made the subject of artistic treatment. He is the patron of hunters, and is also invoked in cases of hydrophobia. Several orders of knighthood have been under his protection; among these may be mentioned the Bavarian, the Bohemian and that of the electorate of Cologne.

See *Acta Sanctorum*, Novembris, i. 759-930; G. Kurth, *Chartes de l'abbaye de St Hubert en Ardenne* (Brussels, 1903); Anna Jameson, *Sacred and Legendary Art*, i. 732-737 (London, 1896); Cahier, *Caractéristiques des saints*, pp. 183, 775, &c. (Paris, 1867). (H. DE.)

HUBERTUSBURG, a château in the kingdom of Saxony, near the village of Wermsdorf and midway 6 m. between the towns Oschatz and Grimma. It was built in 1721-1724 by Frederick Augustus II., elector of Saxony, subsequently King Augustus III. of Poland, as a hunting box, and was often the scene of brilliant festivities. It is famous for the peace signed here on the 15th of February 1763, which ended the Seven Years' War. After undergoing various vicissitudes, it now serves the purpose of a lunatic asylum and a training school for nursing sisters.

See Riemer, *Das Schloss Hubertusburg, sonst und jetzt* (Oschatz, 1881).

HUBLI, a town of British India, in the Dharwar district of Bombay, 15 m. S.E. of Dharwar town. Pop. (1901) 60,214. It is a railway junction on the Southern Mahratta system, where the lines to Bangalore and Bezwada branch off south and west. It is an important centre of trade and of cotton and silk weaving, and has two cotton mills and several factories for ginning and pressing cotton. Hubli was in early times the seat of an English factory, which, with the rest of the town, was plundered in 1673 by Sivaji, the Mahratta leader.

HÜBNER, EMIL (1834-1907), German classical scholar, son of the historical painter Julius Hübner (1806-1882), was born at Düsseldorf on the 7th of July 1834. After studying at Berlin and Bonn, he travelled extensively with a view to antiquarian and epigraphical researches. The results of these travels were embodied in several important works: *Inscriptiones Hispaniae Latinae* (1869, supplement 1892), *I. H. Christianae* (1871, supplement 1900); *Inscriptiones Britanniae Latinae* (1873), *I. B. Christianae* (1876); *La Arqueología de España* (1888); *Monumenta linguae Hibericae* (1893). Hübner was also the author of two books of the greatest utility to the classical student:

Grundriss zu Vorlesungen über die römische Literaturgeschichte (4th ed. 1878, edited, with large additions, by J. E. B. Mayor as *Bibliographical Clue to Latin Literature*, 1875), and *Bibliographie der classischen Altertumswissenschaft* (2nd ed., 1889); mention may also be made of *Römische Epigraphik* (2nd ed., 1892); *Exempla Scripturae Epigraphicae Latinae* (1885); and *Römische Herrschaft in Westeuropa* (1890). In 1870 Hübner was appointed professor of Classical Philology in the university of Berlin, where he died on the 21st of February 1907.

HÜBNER, JOSEPH ALEXANDER, COUNT (1811-1892), Austrian diplomatist, was born in Vienna on the 26th of November 1811. His real name was Hafenedl, which he afterwards changed to Hübner. He began his public career in 1833 under Metternich, whose confidence he soon gained, and who sent him in 1837 as attaché to Paris. In 1841 he became secretary of embassy at Lisbon, and in 1844 Austrian consul-general at Leipzig. In 1848 he was sent to Milan to conduct the diplomatic correspondence of Archduke Rainer, viceroy of Lombardy. On the outbreak of the revolution he was seized as a hostage, and remained a prisoner for some months. Returning to Austria, he was entrusted with the compilation of the documents and proclamations relating to the abdication of the Emperor Ferdinand and the accession of Francis Joseph. His journal, an invaluable clue to the complicated intrigues of this period, was published in 1891 in French and German, under the title of *Une Année de ma vie, 1848-1849*. In March 1849 he was sent on a special mission to Paris, and later in the same year was appointed ambassador to France. To his influence was in large measure due the friendly attitude of Austria to the Allies in the Crimean War, at the close of which he represented Austria at the congress of Paris in 1856. He allowed himself, however, to be taken by surprise by Napoleon's intervention on behalf of Italian unity, of which the first public intimation was given by the French emperor's cold reception of Hübner on New Year's Day, 1859, with the famous words: "I regret that our relations with your Government are not so good as they have hitherto been." He did not return to Paris after the war, and after holding the ministry of police in the Goluchowski cabinet from August to October 1859, lived in retirement till 1865, when he became ambassador at Rome. Quitting this post in 1867, he undertook extensive travels, his descriptions of which appeared as *Promenades autour du monde, 1871* (1873; English translation by Lady Herbert, 1874) and *Through the British Empire* (1886). Written in a bright and entertaining style, and characterized by shrewd observation, they achieved considerable popularity in their time. A more serious effort was his *Sixte-Quint* (1870, translated into English by H. E. H. Jerningham under the title of *The Life and Times of Sixtus the Fifth*, 1872), an original contribution to the history of the period, based on unpublished documents at the Vatican, Simancas and Venice. In 1879 he was made a life-member of the Austrian Upper House, where he sat as a Clerical and Conservative. He had received the rank of Baron (Freiherr) in 1854, and in 1888 was raised to the higher rank of Count (Graf). He died at Vienna on the 30th of July 1892. Though himself of middle-class origin, he was a profound admirer of the old aristocratic régime, and found his political ideals in his former chiefs, Metternich and Schwarzenberg. As the last survivor of the Metternich school, he became towards the close of his life more and more out of touch with the trend of modern politics, but remained a conspicuous figure in the Upper House and at the annual delegations. That he possessed the breadth of mind to appreciate the working of a system at total variance with his own school of thought was shown by his grasp of British colonial questions. It is interesting, in view of subsequent events, to note his emphatic belief in the loyalty of the British colonies—a belief not shared at that time by many statesmen with far greater experience of democratic institutions.

See Sir Ernest Satow, *An Austrian Diplomatist in the Fifties* (1908).

HUC, ÉVARISTE RÉGIS (1813-1860), French missionary-traveller, was born at Toulouse, on the 1st of August 1813. In his twenty-fourth year he entered the congregation of the Lazarists at Paris, and shortly after receiving holy orders in

1839 went out to China. At Macao he spent some eighteen months in the Lazarist seminary, preparing himself for the regular work of a missionary. Having acquired some command of the Chinese tongue, and modified his personal appearance and dress in accordance with Chinese taste, he started from Canton. He at first superintended a Christian mission in the southern provinces, and then passing to Peking, where he perfected his knowledge of the language, eventually settled in the Valley of Black Waters or He Shuy, a little to the north of the capital, and just within the borders of Mongolia. There, beyond the Great Wall, a large but scattered population of native Christians had found a refuge from the persecutions of Kia-King, to be united half a century later in a vast but vague apostolic vicariate. The assiduity with which Huc devoted himself to the study of the dialects and customs of the Tatars, for whom at the cost of much labour he translated various religious works, was an admirable preparation for undertaking in 1844, at the instigation of the vicar apostolic of Mongolia, an expedition whose object was to dissipate the obscurity which hung over the country and habits of the Tibetans. September of that year found the missionary at Dolon Nor occupied with the final arrangements for his journey, and shortly afterwards, accompanied by his fellow-Lazarist, Joseph Gabet, and a young Tibetan priest who had embraced Christianity, he set out. To escape attention the little party assumed the dress of lamas or priests. Crossing the Hwang-ho, they advanced into the terrible sandy tract known as the Ordos Desert. After suffering dreadfully from want of water and fuel they entered Kansu, having recrossed the flooded Hwang-ho, but it was not till January 1845 that they reached Tang-Kiul on the boundary. Rather than encounter alone the horrors of a four months' journey to Lhasa they resolved to wait for eight months till the arrival of a Tibetan embassy on its return from Peking. Under an intelligent teacher they meanwhile studied the Tibetan language and Buddhist literature, and during three months of their stay they resided in the famous Kumbum Lamasery, which was reported to accommodate 4000 persons. Towards the end of September they joined the returning embassy, which comprised 2000 men and 3700 animals. Crossing the deserts of Koko Nor, they passed the great lake of that name, with its island of contemplative lamas, and, following a difficult and tortuous track across snow-covered mountains, they at last entered Lhasa on the 29th of January 1846. Favourably received by the regent, they opened a little chapel, and were in a fair way to establish an important mission, when the Chinese ambassador interfered and had the two missionaries conveyed back to Canton, where they arrived in October of the same year. For nearly three years Huc remained at Canton, but Gabet, returning to Europe, proceeded thence to Rio de Janeiro, and died there shortly afterwards. Huc returned to Europe in shattered health in 1852, visiting India, Egypt and Palestine on his way, and, after a prolonged residence in Paris, died on the 31st of March 1860.

His writings comprise, besides numerous letters and memoirs in the *Annales de la propagation de la foi*, the famous *Souvenirs d'un voyage dans la Tartarie, le Thibet, et la Chine pendant les années 1844-1846* (2 vols., Paris, 1850; Eng. trans. by W. Hazlitt, 1851, abbreviated by M. Jones, London, 1867); its supplement, crowned by the Academy, entitled *L'Empire chinois* (2 vols., Paris, 1854; Eng. trans., London, 1859); and an elaborate historical work, *Le Christianisme en Chine, &c.* (4 vols., Paris, 1857-1858; Eng. trans., London, 1857-1858). These works are written in a lucid, racy, picturesque style, which secured for them an unusual degree of popularity. The *Souvenirs* is a narrative of a remarkable feat of travel, and contains passages of so singular a character as in the absence of corroborative testimony to stir up a feeling of incredulity. That Huc was suspected unjustly was amply proved by later research. But he was by no means a practical geographer, and the record of his travels loses greatly in value from the want of precise scientific data.

See, for information specially relating to the whole subject, the Abbé Desgodin's *Mission au Thibet de 1855 à 1870* (Verdun, 1872); and "Account of the Pundit's Journey in Great Tibet," in the *Royal Geographical Society's Journal* for 1877.

HUCBALD (**HUCBALDUS**, **HUBALDUS**), Benedictine monk, and writer on music, was born at the monastery of Saint Amand

near Tournai, in or about 840, if we may believe the statement of his biographers to the effect that he died in 930, aged 90. He studied at the monastery, where his uncle Milo occupied an important position. Hucbald made rapid progress in the acquirement of various sciences and arts, including that of music, and at an early age composed a hymn in honour of St Andrew, which met with such success as to excite the jealousy of his uncle. It is said that Hucbald in consequence was compelled to leave St Amand, and started an independent school of music and other arts at Nevers. In 860, however, he was at St Germain d'Auxerre, bent upon completing his studies, and in 872 he was back again at St Amand as the successor in the headmastership of the convent school of his uncle, to whom he had been reconciled in the meantime. Between 883 and 900 Hucbald went on several missions of reforming and reconstructing various schools of music, including that of Rheims, but in the latter year he returned to St Amand, where he remained to the day of his death on the 25th of June 930, or, according to other chroniclers, on the 20th of June 932. The only work which can positively be ascribed to him is his *Harmonica Institutio*. The *Musica Enchiridiadis*, published with other writings of minor importance in Gerbert's *Scriptores de Musica*, and containing a complete system of musical science as well as instructions regarding notation, has now been proved to have originated about half a century later than the death of the monk Hucbald, and to have been the work of an unknown writer belonging to the close of the 10th century and possibly also bearing the name of Hucbald. This work is celebrated chiefly for an essay on a new form of notation described in the present day as *Dasia Notation*. The author of the *Harmonica Institutio* wrote numerous lives of the saints and a curious poem on bald men, dedicated to Charles the Bald.

AUTHORITIES.—Sir John Hawkins, *General History of the Science and Practice of Music* (i. 153); *Histoire littéraire de la France* (vi. 216 et seq.); Coussemaker, *Mémoire sur Hucbald* (Paris, 1841); Hans Müller, *Hucbald's echte und unechte Schriften über Musik* (Leipzig, 1884); Spitta, *Die Musica Enchiridiadis und seine Zeitalter* (*Vierteljahrsschrift für Musikwissenschaft*, 1889, 5th year).

HU-CHOW-FU, a city of China, in the province of Cheh-Kiang (30° 48' N., 120° 3' E.), a little S. of Tai-hu Lake, in the midst of the central silk district. According to Chinese authorities it is 6 m. in circumference, and contains about 100,000 families. A broad stream or canal crosses the city from south to north, and forms the principal highway for boat traffic. The main trade of the place is in raw silk, but some silk fabrics, such as flowered crape (*chousha*), are also manufactured. Silk is largely worn even by the lowest classes of the inhabitants.

HUCHOWN, "of the Awle Ryale" (fl. 14th century), Scottish poet, is referred to by Wyntoun in his *Chronicle* in these words:—

"Hucheon,
pat cunnand in litratur,
He made a gret Gest of Arthure,
And pe Awntyre of Gawane,
De Pstiel als of Suet Susane.
He was curyouse in his stille,
Fayr of facunde and subtile,
And ay to pleyssance hade delyte,
Mad in metyr meit his dyte
Lilil or noucht neuir pe lesse
Wauerande fra pe auythastnes."
(Cott. MS. bk. v. 11, 4308-4318).

Much critical ingenuity has been spent in endeavouring to identify (a) the poet and (b) the works named in the foregoing passage. It has been assumed that "Huchown," or "Hucheon," represents the "gude Sir Hew of Eglyntoun" named by Dunbar (q.v.) in his *Lament for the Makaris* (l. 53). The only known Sir Hugh of Eghintoun of the century is frequently mentioned in the public records from the middle of the century onwards, as an auditor of accounts and as witness to several charters. By 1360 he had married Dame Egidia, widow of Sir James Lindsay and half-sister of Robert the Steward. His public office and association with the Steward sorts well with the designation "of the Awle Ryale," if that be interpreted as "Aula Regalis" or "Royal Palace." He appears to have died late in 1376 or early in 1377.

The first of the poems named above, the *Gest of Arthure or Gest Historyalle* (ib. l. 4288), has been identified by Dr Trautmann, "Anglia," *Der Dichter Huchown* (1877), with the alliterative *Morie Arthure* in the Thornton MS. at Lincoln, printed by the E.E.T.S. (ed. Brock, 1865). The problem of the second (*The Awntyre of Gowane*) is still in dispute. There are difficulties in the way of accepting the conjecture that the poem is the "Awntyres of Arthure at the Tern Wathehlyne" (see S.T.S., *Scottish Alliterative Poems*, 1897, and Introduction, pp. 11 et seq.), and little direct evidence in favour of the view that the reference is to the greatest of middle English romances, *Sir Gowain and the Grene Knight*. The third may be safely accepted as the well-known *Pistil* [Epistle] of *Swele Susan*, printed by Laing (*Select Remains*, 1822) and by the S.T.S. (*Scottish Alliterative Poems*, u.s.).

See, in addition to the works named above, G. Neilson's *Sir Hew of Eglington and Huchown of the Awle Ryale* (Glasgow, 1901), which contains a full record of references to the historical Sir Hew of Eglington; *Huchown of the Awle Ryale, the Alliterative Poet* (Glasgow, 1902) by the same; J. T. Brown's *Huchown of the Awle Ryale and his Poems* (Glasgow, 1902), in answer to the foregoing. See also the correspondence in the *Athenaeum*, 1900-1901, and the review of Mr Neilson's pamphlets, *ib.* (Nov. 22, 1902); and J. H. Millar's *Literary History of Scotland* (1903), pp. 8-14.

HUCHTENBURG, the name of two brothers who were Dutch painters in the second half of the 17th century. Both were natives of Haarlem. Jacob, the elder, of whom very little is known, studied under Berghem, and went early to Italy, where he died young about 1667. His pictures are probably confounded with those of his brother. In Copenhagen, where alone they are catalogued, they illustrate the style of a Dutchman who transfers Berghem's cattle and flocks to Italian landscapes and market-places.

John van Huchtenburg (1646-1733), born at Haarlem it is said in 1646, was first taught by Thomas Wyk, and afterwards induced to visit the chief cities of Italy, where, penetrating as far as Rome, he met and dwelt with his brother Jacob. After the death of the latter he wandered homewards, taking Paris on his way, and served under Van der Meulen, then employed in illustrating for Louis XIV. the campaign of 1667-1668 in the Low Countries. In 1670 he settled at Haarlem, where he married, practised and kept a dealer's shop. His style had now merged into an imitation of Philip Wouvermans and Van der Meulen, which could not fail to produce pretty pictures of hunts and robber camps, the faculty of painting horses and men in action and varied dress being the chief point of attraction. Later Huchtenburg ventured on cavalry skirmishes and engagements of regular troops generally, and these were admired by Prince Eugene and William III., who gave the painter sittings, and commissioned him to throw upon canvas the chief incidents of the battles they fought upon the continent of Europe. When he died at Amsterdam in 1733, Huchtenburg had done much by his pictures and prints to make Prince Eugene, King William and Marlborough popular. Though clever in depicting a *mêlée* or a skirmish of dragoons, he remained second to Philip Wouvermans in accuracy of drawing, and inferior to Van der Meulen in the production of landscapes. But, nevertheless, he was a clever and spirited master, with great facility of hand and considerable natural powers of observation.

The earliest date on his pictures is 1674, when he executed the "Stag-Hunt" in the Museum of Berlin, and the "Fight with Robbers" in the Lichtenstein collection at Vienna. A "Skirmish at Fleurus" (1690) in the Brussels gallery seems to be the precursor of larger and more powerful works, such as the "Siege of Namur" (1695) in the Belvedere at Vienna, where William III. is seen in the foreground accompanied by Max Emmanuel, the Bavarian elector. Three years before, Huchtenburg had had sittings from Prince Eugene (Hague museum) and William III. (Amsterdam Trippenhuus). After 1695 he regularly served as court painter to Prince Eugene, and we have at Turin (gallery) a series of eleven canvases all of the same size depicting the various battles of the great hero, commencing with the fight of Zentha against the Turks in 1697, and concluding with the capture of Belgrade in 1717. Had the duke of Marlborough been fond of art he would doubtless have possessed many works of our artist. All that remains at Blenheim, however, is a couple of sketches of battles, which were probably sent to Churchill by his great contemporary. The pictures of Huchtenburg

are not very numerous now in public galleries. There is one in the National Gallery, London, another at the Louvre. But Copenhagen has four, Dresden six, Gotha two, and Munich has the well-known composition of "Tallart taken Prisoner at Blenheim in 1704."

HUCKABACK,¹ the name given to a type of cloth used for towels. For this purpose it has perhaps been more extensively used in the linen trade than any other weave. One of the chief merits of a towel is its capacity for absorbing moisture; plain and other flat-surfaced cloths do not perform this function satisfactorily, but cloths made with huckaback, as well as those made with the honeycomb and similar weaves, are particularly well adapted for this purpose.

The body or foundation of the cloth is plain and therefore sound in structure (see designs A and B in figure), but at fixed intervals some of the warp threads float on the surface of the cloth, while at the same time a number of weft threads float on the back. Thus the cloth has a somewhat similar appearance on both sides. Weave A is the ordinary and most used huck or huckaback, while weave B, which is usually woven with double weft, is termed the Devon or medical huck. The cloths made by the use of these weaves were originally all linen, but are too often adulterated with inferior fibres.



A



B

HUCKLEBERRY, in botany, the popular name in the north-eastern United States of the genus *Gaylussacia*, small branching shrubs resembling in habit the English bilberry (*Vaccinium*), to which it is closely allied, and bearing a similar fruit. The common huckleberry of the northern states is *G. resinosa*; while *G. brachycera* and *G. dumosa* are known respectively as box and dwarf huckleberry. The name *Gaylussacia* commemorates the famous French chemist Gay-Lussac.

HUCKNALL TORKARD, a town in the Rushcliffe parliamentary division of Nottinghamshire, England; 132 m. N.N.W. from London by the Great Central railway, served also by the Great Northern and Midland railways. Pop. (1901) 15,250. The church of St Mary Magdalene contains the tomb of Lord Byron. There are extensive collieries in the vicinity, and the town has tobacco and hosiery works. Small traces are found of Beauvale Abbey, a Carthusian foundation of the 14th century, in the hilly, wooded district W. of Hucknall; and 3 m. N. is Newstead Abbey, in a beautiful situation on the border of Sherwood Forest. This Augustinian foundation owed its origin to Henry II. It came into the hands of the Byron family in 1540, and the poet Byron resided in it at various times until 1818. There remain the Early English west front of the church, a Perpendicular cloister and the chapter-house; while in the mansion, wholly restored since Byron's time, and in the demesne, many relics of the poet are preserved. To the S. of Hucknall are traces of Gresley Castle, of the 14th century.

HUCKSTER, a dealer or retailer of goods in a small way. The word, in various forms, is common to many Teutonic languages. In Early English it is found as *houwester*, *kokaster*, *huxter*; in early modern Dutch as *heuker*, and Medieval Low German as *hoker*; but the ultimate origin is unknown. *Huckster* apparently belongs to that series of words formed from a verb,—as brew, brewer, but the noun "huckster" is found in use before the verb to huck. *Hawker* and *pedlar* are nearly synonymous in meaning, but "huckster" may include a person in a small way of trade in a settled habitation, while a *hawker* or *pedlar* invariably travels from place to place offering his wares. In a contemptuous sense, *huckster* is used of any one who barter, or makes gain or profit in underhand or mean ways, or who over-reaches another, to get advantage for himself.

HUDDERSFIELD, a municipal, county and parliamentary borough in the West Riding of Yorkshire, England, 190 m. N.N.W. from London. Pop. (1901) 95,047. It is served by the Lancashire & Yorkshire and London & North Western

¹ Skeat, *Etym. Dict.* (1898), says, "The word bears so remarkable resemblance to Low Ger. *hukkebak*, Ger. *huckeback*, pick-a-back, that it seems reasonable to suppose that it at first meant 'peddler's ware.'" The *New English Dictionary* does not consider that the connexion can at present be assumed.

railways, and has connexion with all the important railway systems of the West Riding, and with the extensive canal system of Lancashire and Yorkshire. It is well situated on a slope above the river Colne, a tributary of the Calder. It is built principally of stone, and contains several handsome streets with numerous great warehouses and business premises, many of which are of high architectural merit. Of the numerous churches and chapels all are modern, and some of considerable beauty. The parish church of St Peter, however, though rebuilt in 1837, occupies a site which is believed to have carried a church since the 11th century. The town hall (1880) and the corporation offices (1877) are handsome classic buildings; the Ramsden Estate buildings are a very fine block of the mixed Italian order. The market hall (1880) surmounted by a clock-tower is in geometrical Decorated style. The cloth-hall dates from 1784, when it was erected as a clothiers' emporium. It is no longer used for any such purpose, but serves as an exchange news-room. The Armoury, erected as a riding-school, was the headquarters of a volunteer corps, and is also used for concerts and public meetings. The chief educational establishments are the Huddersfield College (1838), a higher-grade school, the technical school and several grammar-schools, of which Longwood school was founded in 1731. The Literary and Scientific Society possesses a museum. Of the numerous charitable institutions, the Infirmary, erected in 1831, is housed in a building of the Doric order. The chief open spaces are Greenhead and Beaumont parks, the last named presented to the town by Mr H. F. Beaumont in 1880. There is a sulphurous spa in the district of Lockwood.

Huddersfield is the principal seat of the fancy woollen trade in England, and fancy goods in silk and cotton are also produced in great variety. Plain cloth and worsteds are also manufactured. There are silk and cotton spinning-mills, iron foundries and engineering works. Coal is abundant in the vicinity. The parliamentary borough returns one member. The county borough was created in 1888. The municipal borough is under a mayor, 15 aldermen and 45 councillors. Area, 11,859 acres.

Huddersfield (*Oderesfelde*) only rose to importance after the introduction of the woollen trade in the 17th century. After the Conquest William I. granted the manor to Ilbert de Laci, of whom the Saxon tenant Godwin was holding as underlord at the time of the Domesday Survey. In Saxon times it had been worth 100s., but after being laid waste by the Normans was still of no value in 1086. From the Lacy's the manor passed to Thomas Plantagenet, duke of Lancaster, through his marriage with Alice de Lacy, and so came to the crown on the accession of Henry IV. In 1599 Queen Elizabeth sold it to William Ramsden, whose descendants still own it. Charles II. in 1670 granted to John Ramsden a market in Huddersfield every Wednesday with the toll and other profits belonging. By the beginning of the 18th century Huddersfield had become a "considerable town," chiefly owing to the manufacture of woollen kerseys, and towards the end of the same century the trade was increased by two events—the opening of navigation on the Calder in 1780, and in 1784 that of the cloth-hall or piece-hall, built and given to the town by Sir John Ramsden, baronet. Since 1832 the burgesses have returned members to parliament. The town possesses no charter before 1868, when it was created a municipal borough.

HUDSON, GEORGE (1800–1871), English railway financier, known as the "railway king," was born in York in March 1800. Apprenticed to a firm of linendrapers in that city, he soon became a successful merchant, and in 1837 was elected lord mayor of York. Having inherited, in 1827, a sum of £30,000, he invested it in North Midland Railway shares, and was shortly afterwards appointed a director. In 1833 he had founded and for some time acted as manager of the York Banking Company. He had for long been impressed with the necessity of getting the railway to York, and he took an active part in securing the passing of the York and North Midland Bill, and was elected chairman of the new company—the line being opened in 1839. From this time he turned his undivided attention to the projec-

tion of railways. In 1841 he initiated the Newcastle and Darlington line. With George Stephenson he planned and carried out the extension of the Midland to Newcastle, and by 1844 had over a thousand miles of railway under his control. In this year the mania for railway speculation was at its height, and no man was more courted than the "railway king." All classes delighted to honour him, and, as if a colossal fortune were an insufficient reward for his public services, the richest men in England presented him with a tribute of £30,000. Deputy-lieutenant for Durham, and thrice lord mayor of York, he was returned in the Conservative interest for Sunderland in 1845, the event being judged of such public interest that the news was conveyed to London by a special train, which travelled part of the way at the rate of 75 m. an hour. Full of rewards and honours, he was suddenly ruined by the disclosure of the Eastern Railway frauds. Sunderland clung to her generous representative till 1850, but on the bursting of the bubble he had lost influence and fortune at a single stroke. His later life was chiefly spent on the continent, where he benefited little by a display of unabated energy and enterprise. Some friends gave him a small annuity a short time before his death, which took place in London, on the 14th of December 1871. His name has long been used to point the moral of vaulting ambition and unstable fortune. The "big swollen gambler," as Carlyle calls him in one of the *Latter-Day Pamphlets*, was savagely and excessively reprobated by the world which had blindly believed in his golden prophecies. He certainly ruined scrip-holders, and disturbed the great centres of industry; but he had an honest faith in his own schemes, and, while he beggared himself in their promotion, he succeeded in overcoming the powerful landed interest which delayed the adoption of railways in England long after the date of their regular introduction into America.

HUDSON, HENRY, English navigator and explorer. Nothing is known of his personal history excepting such as falls within the period of the four voyages on which his fame rests. The first of these voyages in quest of new trade and a short route to China by way of the North Pole, in accordance with the suggestion of Robert Thorne (d. 1527), was made for the Muscovy Company with ten men and a boy in 1607. Hudson first coasted the east side of Greenland, and being prevented from proceeding northwards by the great ice barrier which stretches thence to Spitzbergen sailed along it until he reached "Newland," as Spitzbergen was then called, and followed its northern coast to beyond 80° N. lat. On the homeward voyage he accidentally discovered an island in lat. 71° which he named Hudson's Touches, and which has since been identified with Jan Mayen Island. Molineux's chart, published by Hakluyt about 1600, was Hudson's blind guide in this voyage, and the polar map of 1611 by Pontanus illustrates well what he attempted, and the valuable results both negative and positive which he reached. He investigated the trade prospects at Bear Island, and recommended his patrons to seek higher game in Newland; hence he may be called the father of the English whale-fisheries at Spitzbergen.

Next year Hudson was again sent by the Muscovy Company to open a passage to China, this time by the north-east route between Spitzbergen and Novaya Zemlya, which had been attempted by his predecessors and especially by the Dutch navigator William Barents. This voyage lasted from the 22nd of April to the 26th of August 1608. He raked the Barents Sea in vain between 75° 30' N.W. and 71° 15' S.E. for an opening through the ice, and on the 6th of July, "voide of hope of a north-east passage (except by the Waygats, for which I was not fitted to trie or prove)," he resolved to sail to the north-west, and if time and means permitted to run a hundred leagues up Lumley's Inlet (Frobisher Strait) or Davis's "overfall" (Hudson Strait). But his voyage being delayed by contrary winds he was finally compelled to return without accomplishing his wish. The failure of this second attempt satisfied the Muscovy Company, which thenceforward directed all its energies to the profitable Spitzbergen trade.

Towards the end of 1608 Hudson "had a call" to Amsterdam.

where he saw the celebrated cosmographer the Rev Peter Plancius and the cartographer Hondius, and after some delay, due to the rivalry which was exhibited in the attempt to secure his services, he undertook for the Dutch East India Company his important third voyage to find a passage to China either by the north-east or north-west route. With a mixed crew of eighteen or twenty men he left the Texel in the "Half-Moon" on the 6th of April, and by the 5th of May was in the Barents Sea, and soon afterwards among the ice near Novaya Zemlya, where he had been the year before. Some of his men becoming disheartened and mutinous (it is now supposed that he had arrived two or three months too early), he lost hope of effecting anything by that route, and submitted to his men, as alternative proposals, either to go to Lumley's Inlet and follow up Waymouth's light, or to make for North Virginia and seek the passage in about 40° lat., according to the letter and map sent him by his friend Captain John Smith. The latter plan was adopted, and on the 14th of May Hudson set his face towards the Chesapeake and China. He touched at Stromo in the Faroe Islands for water, and on the 15th of June off Newfoundland the "Half-Moon" "spent overboard her foremast." This accident compelled him to put into the Kennebec river, where a mast was procured, and some communication and an unnecessary encounter with the Indians took place. Sailing again on the 26th of July, he began on the 28th of August the survey where Smith left off, at 37° 36' according to his map, and coasted northwards. On the 3rd of September, in 40° 30', he entered the fine bay of New York, and after having gone 150 m. up the river which now bears his name to near the position of the present Albany, treating with the Indians, surveying the country, and trying the stream above tide-water, he became satisfied that this course did not lead to the South Sea or China, a conclusion in harmony with that of Champlain, who the same summer had been making his way south through Lake Champlain and Lake St Sacrement (now Lake George). The two explorers by opposite routes approached within 20 leagues of each other. On the 4th of October the "Half-Moon" weighed for the Texel, and on the 7th of November arrived at Dartmouth, where she was seized and detained by the English government, Hudson and the other Englishmen of the ship being commanded not to leave England, but rather to serve their own country. The voyage had fallen short of Hudson's expectations, but it served many purposes perhaps as important to the world. Among other results it exploded Hakluyt's myth, which from the publication of Lok's map in 1582 to the 2nd charter of Virginia in May 1609 he had lost no opportunity of promulgating, that near 40° lat. there was a narrow isthmus, formed by the sea of Verrazano, like that of Tehuantepec or Panama.

Hudson's confidence in the existence of a North-West Passage had not been diminished by his three failures, and a new company was formed to support him in a fourth attempt, the principal promoters being Sir Thomas Smith (or Smythe), Sir Dudley Digges and John (afterwards Sir John) Wolstenholme. He determined this time to carry out his old plan of searching for a passage up Davis's "overfall"—so-called in allusion to the overfall of the tide which Davis had observed rushing through the strait. Hudson sailed from London in the little ship "Discovery" of 55 tons, on the 17th of April 1610, and entered the strait which now bears his name about the middle of June. Sailing steadily westward he entered Hudson Bay on the 3rd of August, and passing southward spent the next three months examining the eastern shore of the bay. On the 1st of November the "Discovery" went into winter quarters in the S.W. corner of James Bay, being frozen in a few days later, and during the long winter months which were passed there only a scanty supply of game was secured to eke out the ship's provisions. Discontent became rife, and on the ship breaking out of the ice in the spring Hudson had a violent quarrel with a dissolute young fellow named Henry Greene, whom he had befriended by taking him on board, and who now retaliated by inciting the discontented part of the crew to put Hudson and eight others (including the sick men) out of the ship. This happened on the

22nd of June 1612. Robert Bylot was elected master and brought the ship back to England. During the voyage home Greene and several others were killed in a fight with the Eskimo, while others again died of starvation, and the feeble remnants which reached England in September were thrown into prison. No more tidings were ever received of the deserted men.

Although it is certain that the four great geographical landmarks which to-day serve to keep Hudson's memory alive, namely the Hudson Bay, Strait, Territory and River, had repeatedly been visited and even drawn on maps and charts before he set out on his voyages, yet he deserves to take a very high rank among northern navigators for the mere extent of his discoveries and the success with which he pushed them beyond the limits of his predecessors. The rich fisheries of Spitzbergen and the fur industry of the Hudson Bay Territory were the immediate fruit of his labours.

See *Henry Hudson, the Navigator* (Hakluyt Society, 1860); and T. A. Janvier, *Henry Hudson* (1909). In 1909 a great celebration of the tercentenary was held in the United States.

HUDSON, JOHN (1662-1719), English classical scholar, was born at Wythop in Cumberland. He was educated at Oxford, where the remainder of his life was spent. In 1701 he was appointed Bodley's librarian, and in 1711 principal of St Mary's Hall. His political views stood in the way of his preferment in the church and university. He died on the 26th of November 1719. As an editor and commentator he enjoyed a high reputation both at home and abroad. His works, chiefly editions of classical authors, include the following: Valerius Paterculus (1693); Thucydides (1696); *Geographias Veteris Scriptores Graeci minores* (1698-1712) containing the works and fragments of 21 authors and the learned, though diffuse, dissertations of H. Dodwell—a rare and valuable work, which in spite of its faulty text was not superseded until the appearance of C. W. Müller's edition in the Didot series; the editio princeps of Moeris, *De Vocibus Atticis et Hellenicis* (1712); Josephus (1720, published posthumously by his friend Anthony Hall, the antiquary), a correct and beautifully printed edition, with variorum notes and translation.

See Wood, *Athens Oxonienses*, iv.; introduction to the edition of Josephus; W. Hutchinson, *History of Cumberland* (1734).

HUDSON, a city and the county-seat of Columbia county, New York, U.S.A., on the E. side of the Hudson river, about 114 m. N. of New York City and about 28 m. S. of Albany. Pop. (1890) 9970; (1900) 9528, of whom 1155 were foreign-born; (1920 census) 11,417. It is served by the Boston & Albany, the New York Central & Hudson River and the (electric) Albany & Hudson railways, by river steamboats, and by a steam ferry to Athens and Catskill across the river. The city is picturesquely situated on the slope of Prospect Hill; and Promenade Park, on a bluff above the steamboat landing, commands a fine view of the river and of the Catskill Mountains. Among the public buildings and institutions are a fine city hall, the Columbia County Court House, a public library, a Federal building, a State Training School for Girls, a State Firemen's Home, an Orphan Asylum, a Home for the Aged and a hospital. The city's manufactures include hosiery and knit goods, Portland cement (one of the largest manufactories of that product in the United States being here), foundry and machine shop products, car wheels, ice tools and machinery, ale, beer, bricks and tiles and furniture. The value of the factory products in 1905 was \$4,115,525, an increase of 58.1% over that in 1900. The municipality owns and operates the water-works. Hudson, which was originally known as Claverack Landing, was for many years merely a landing with two rude wharfs and two small storehouses, to which farmers in the neighbourhood brought their produce for shipment on the river. Late in 1783 the place was settled by an association of merchants and fishermen from Rhode Island, Nantucket and Martha's Vineyard. The present name was adopted in 1784, and the city was chartered in 1785. For many years Hudson had a considerable foreign commerce and whaling interests, but these were practically destroyed by the war of 1812.

HUDSON BAY (less often, but more correctly, **Hudson's Bay**), an inland sea in the N.E. of Canada, extending from 78° to 95° W. and from 51° to 70° N. On the east it is connected with the Atlantic Ocean by Hudson Strait, and on the north with the Arctic Ocean by Fox Channel and Fury and Hecla Strait. Its southern extremity between 55° and 51° N. is known as James Bay. It is 500 m. in width, and 1300 from S. to N., including James Bay (350 m.) and Fox Channel (350 m.). The customary use of the term includes James Bay, but not Fox Channel. The average depth of water is about 70 fathoms, deepening at the entrance of Hudson Strait to 100 fathoms. James Bay is much shallower, and unfit for shipping save for a central channel leading to the mouth of the Moose river. The centre and west of the main bay are absolutely free from shoals, rocks or islands, but down its east coast extend two lines of small islands, one close to shore, the other at 70 to 100 m. distance, and comprising a number of scattered groups (the Ottawa Islands, the Sleepers, the Belchers, &c.).

Into Hudson and James Bays flow numerous important rivers, so much so that the water of the latter is rather brackish than salt. Beginning at the north-west, the chief of these are Churchill, Nelson (draining Lake Winnipeg), and the numerous inland rivers of which it is the basin, Hayes (the old boat route of the voyageurs to Winnipeg), Severn, Albany, Moose, Rupert river (draining Lake Mistassini), Nottaway, East Main, Great Whale and Little Whale.

Save for some high bluffs on the east and north-east, the shores of the bay are low. Around much of James Bay extend marshes and swampy ground. Geologically the greater part of the Hudson Bay district belongs to the Laurentian system, though there are numerous outcrops of later formation; Cambro-Silurian on the south and west, and to the north of Cape Jones (the north-eastern extremity of James Bay) a narrow belt of Cambrian rocks, of which the islands are composed. Coal, pumice, iron and other minerals have been found in various districts near the coast. The climate is harsh, though vegetables and certain root crops ripen in the open air as far north as Fort Churchill; cattle flourish, and are fed chiefly on the native grasses; spruce, balsam and poplar grow to a fair size as far as the northern limit of James Bay. Caribou, musk ox and other animals are still found in large numbers, and there is an abundance of feathered game—ducks, geese, loons and ptarmigan; hunting and fishing form the chief occupations of the Indians and Eskimo who live in scattered bands near the shore. The bay abounds with fish, of which the chief are cod, salmon, porpoise and whales. The last have long been pursued by American whalers, whose destructive methods have so greatly depleted the supply that the government of Canada is anxious to declare the bay a *mare clausum*.

Hudson Strait is about 450 m. long with an average breadth of 100 m., narrowing at one point to 45. Its shores are high and bold, rarely less in height than 1000 ft., save on the coast of Ungava Bay, a deep indentation on the south-east. No islands or rocks impede navigation. Its depth is from 100 to 200 fathoms. Owing to the violence of the tides, which rise to a height of 35 ft., it never absolutely freezes over.

After three centuries of exploration, the navigability of Hudson Bay and Strait remains a vexed question. To Canada it is one of great commercial interest, and numerous expeditions have been made and reports issued by the Geological Survey. From Winnipeg to Liverpool via Churchill is over 500 m. less than via Montreal, and from Edmonton to Liverpool almost 1000 m. less. Were navigation open for a sufficient time, such a route for the grain of the Canadian and American west would be of enormous advantage. But the inlet from the Arctic sends down masses of heavy ice, which drift about in the bay and the strait. Past the mouth of the strait flows a stream often over 100 m. wide, of berg and floe ice, carried by the Arctic current. Owing to the proximity of the Magnetic Pole (in Boothia) the compass often refuses to work. For sailing ships, such as the Hudson's Bay Company has long employed, the season for safe navigation is from the 15th of July to the 1st of October. In over 200 years very few serious accidents have occurred to the company's ships within these limits. It is claimed that specially built and protected steamers would be safe from the 15th of June till the 1st of November, and the problem may be solved by ice-breaking vessels of great power. The only good harbour available

is Fort Churchill, at the mouth of the Churchill river, which is large and easy of access. Moose Factory (at the foot of James Bay) and York Factory (at the mouth of the Nelson) are mere roadsteads. Marble Island, south of Chesterfield Inlet, where the whalers winter, is too far north for regular shipping.

The Cabots entered the strait in 1498, and during the next century a series of Elizabethan mariners; but the bay was not explored until 1610, when Henry Hudson pushed through the ice and explored to the southern limit of James Bay.

See Lieutenant Gordon, R.N., *Reports on the Hudson's Bay Expeditions* (1884, 5, 6); William Ogilvie, *Exploratory Survey to Hudson's Bay in 1890* (Ottawa, 1891); R. F. Stupart, *The Navigation of Hudson's Bay and Straits* (Toronto, 1904).

HUDSON RIVER, the principal river of New York state, and one of the most important highways of commerce in the United States of America. It is not a river in the truest sense of the word, but a river valley into which the ocean water has been admitted by subsidence of the land, transforming a large part of the valley into an inlet, and thus opening it up to navigation.

The Hudson lies entirely in the state of New York, which it crosses in a nearly north-and-south direction near the eastern boundary of the state. The sources of the river are in the wildest part of the Adirondack Mountains, in Essex county, north-eastern New York. There are a number of small mountain streams which contribute to the headwater supply, any one of which might be considered the main stream; but assuming the highest collected and permanent body of water to be the true head, the source of the Hudson is Lake Tear-of-the-Clouds, which lies near Mount Marcy at an elevation of about 4322 ft. This small mountain stream flows irregularly southward with a fall of 64 ft. per mile in the upper 52 miles, then, from the mouth of North Creek to the mouth of the Sacondaga, at the rate of nearly 14 ft. per mile. In this part of its course the Hudson has many falls and rapids, and receives a number of mountain streams as tributaries, the largest being Indian river, Schroon river and Sacondaga river. Below the mouth of the Sacondaga the Hudson turns sharply and flows eastward for about 12 m., passing through the mountains, and leaping over several falls of great height and beauty. At Glens Falls there is a fall of about 50 ft.; and just below this, at Sandy Hill, the river again turns abruptly, and for the rest of its course to New York Bay flows almost due south. There are numerous falls and rapids between Glens Falls and Troy which are used as a source of power and are the seats of busy manufacturing plants. Several large tributaries join this part of the river, including Batten Kill, Fish Creek, Hoosic river and the Mohawk, which is the largest of all the tributaries to the Hudson, and contributes more water than the main river itself.

From Troy to the mouth of the Hudson the river is tidal, and from this point also the river is navigable, not because of the river water itself, but because of the low grade of the river bed by which the tide is able to back up the water sufficiently to float good-sized boats. From Albany, 6 m. below Troy, to the mouth of the Hudson, a distance of 145 m., there is a total fall of only 5 ft. It is this lower, tidal, navigable portion of the Hudson that is of so much importance and general interest. Numerous tributaries enter this part of the Hudson from both the east and the west, the largest and most important being the Wallkill which enters at Kingston. In general there is in this part of the river a broad upper valley with a much narrower gorge cut in its bottom, with its rock floor below sea level and drowned by the entrance of the sea. Although this is true in a general way, the character of the river valley varies greatly in detail from point to point, under the influence of the geological structure of the enclosing rock walls.

Most of these variations may be included in a threefold division of the lower Hudson valley. The uppermost of these extends from the south-eastern base of the Adirondack Mountains to the northern portal of the Highlands in Dutchess and Ulster counties. This is a lowland region of ancient Paleozoic rocks. Into the upper portion of this section of the river the non-tidal Hudson is depositing its load of detritus, building a delta below Troy. This, shifted about by the currents, has interposed an obstacle to navigation which has called for extensive dredging and other work, for the purpose of maintaining a navigable channel. The width of the tidal river

varies somewhat, being about 300 yds. at Albany and thence to the Highlands varying from 300 yds. to 900 yds.

The scenery in this part of the river, though not tame, is a little monotonous, the gently sloping hills, with the variegated colours of wood and cultivated land, and the occasional occurrence of a town or village being repeated without any marked feature to break their regularity. Thirty miles from Troy noble views begin to be obtained of the Catskill Mountains towering up behind the west bank, the nearest eminence at the distance of about 7 m. Along the immediate banks of the river are great beds of clay which is extensively used in the manufacture of brick; and the brick-burning plants and huge ice houses are conspicuous features in the landscape. Although the river freezes in the winter, so that ice-boating is a favourite winter sport, the summer climate is warm enough for the cultivation of grapes and other fruits, which is aided to a considerable extent by the influence of the large body of water enclosed between the valley walls, which tends to retard both early and late frosts, and thus to extend the growing season. In addition to smaller towns and villages, there are a number of larger towns and cities, including Hudson and Catskill, nearly opposite each other, and farther down Kingston and the thriving city of Poughkeepsie. Near the extreme end of this section of the Hudson lies the city of Newburgh, a short distance below which, at Cornwall Landing, the river enters the Highlands, the second division of the tidal part of the Hudson and far the grandest of all.

The river enters the northern portals of the Highlands between a series of hills whose frequently precipitous sides rise often abruptly from the water's edge. For about 16 m. the river is bordered by steeply rising hills, giving picturesque and striking views of great variety. These are due to the fact that the river here is crossing a belt of ancient crystalline rocks of moderately high relief, comparable in geological structure to the Adirondack region. The views in this part of the river, often compared with those along the Rhine, are of a character in some respects unparalleled, and at several points they have an impressiveness and surprising grandeur rarely equalled. About 10 m. after the Highlands are entered West Point is reached, a favourite landing-place of tourists and the seat of the United States Military Academy, from whose grounds fine views of the river may be had. This point is historically interesting as the seat of Fort Putnam, now in ruins, built during the American War of Independence, at which time a chain was stretched across the river to prevent the passage of British ships.

The third and lowest section of the tidal part of the Hudson extends from the lower end of the Highlands to New York Bay. This is a region of ancient and metamorphic Paleozoic rocks on the eastern side, and mainly Triassic rocks on the west. Because of their less resistance to denudation, these rocks have permitted a broadening of the valley in this part of the course. Just below Peekskill the river broadens out to form Haverstraw Bay, at the extremity of which is the headland of Croton Point. Below this is the wider expanse of Tappan Bay, which has a length of 12 m. and a breadth of from 4 to 5 m., while below this bay the river narrows to a breadth between 1 and 2 m. On Tappan Bay stands Tarrytown, famous both historically and from its connexion with Washington Irving, whose cottage of Sunnyside is in the vicinity. At Piermont, where the bay ends, the range named the Palisades rises picturesquely from the water's edge to the height of between 300 and 500 ft., extending along the west bank for about 20 m., the opposite shore being level and dotted with hamlets, villages and towns. The Palisades are a lava rock of the variety called trap, which has been intruded as a sheet into the Triassic sandstones, and, on cooling, has developed the prismatic jointing which is so much more perfectly seen at Fingal's Cave in Scotland and Giant's Causeway in Ireland. It is this imperfect hexagonal jointing that has given rise to the name "palisade," applied to the range whose face fronts the lower Hudson. At its mouth the Hudson both broadens and branches, forming a series of islands and an excellent harbour, owing to the fact that the sinking of the land here has permitted the sea to fill the valleys and even to flood low divides. A submerged valley, traceable over the continental shelf, south-east of New York, is commonly believed to represent an earlier course of the Hudson when the land stood 2000 or 3000 ft. higher than at present, and when the inner gorge above New York was being excavated.

Although the Hudson river has a total length of only about 300 m., and a drainage area of but 13,370 sq. m., it has been one of the most significant factors in the development of the United States. With an excellent harbour at its mouth, and navigable waters leading into a fertile interior for a distance of 150 m., it early invited exploration and settlement. Verrazano proceeded a short distance up the Hudson in a boat in 1524, but the first to demonstrate its extent and importance was Henry Hudson, from whom it derives its name. He sailed above the mouth of the Mohawk in September 1609. The Dutch later explored and settled the valley and proceeded westward along

the Mohawk. The Dutch place-names of the region clearly show the significance of this early use of the Hudson highway. Later, in wars, and notably in the American War of Independence, and American War of 1812, the valley became a region of great strategic importance. This was increased by the fact that from the Hudson near Sandy Hill there are two low gaps into the northern country, one along the valley occupied by Lake George, the other into the Lake Champlain valley. The divide between this part of the Hudson and Lake Champlain is only 147 ft. above sea level, and a depression of the land of only 300 ft. in the region between Albany and the St Lawrence river would convert the Hudson and Champlain valleys into a navigable strait having a depth sufficient for the largest vessels. Movements of armies across these gaps were noteworthy events in the wars between the United States and the French and British; but modern commerce has made far less significant use of this highway, mainly because the gaps lead to a region of little economic importance, and thence to the boundary line of a foreign country. Far more important has been the highway westward along the Mohawk, which has cut a gap across the mountains that has been the most useful of all the gaps through the Appalachians. It has been useful in exploration, in war and in commerce, the latter especially because it leads to the fertile interior and to the waterway of the Great Lakes. By the Erie canal the river is connected with Lake Erie, with a branch to Lake Ontario, and other branches to smaller lakes. The Champlain canal connects the Hudson with Lake Champlain. Although these canals are far less used than formerly, the Hudson is still a busy highway for navigation. It is of interest to note that it was on the Hudson that Fulton, the inventor of steam navigation, made his first successful experiment; and that it was along this same highway, from Albany, that one of the first successful railways of the country was built. A railway line now runs parallel to each bank of the Hudson, the New York Central & Hudson River on the eastern side and the West Shore on the western side, each with connexions to the north, east and west, and each turning westward along the Mohawk to Buffalo. It is largely because of the importance of this highway of commerce, by water and by rail, from the coast to the interior, that the greatest and densest population in the United States has gathered at the seaward end of the route in New York City, Jersey City, Hoboken and other places on and near New York Bay, making one of the leading industrial and commercial centres of the world.

For references to articles on the physiography of the Hudson river see R. S. Tarr, *Physical Geography of New York State* (New York, 1902), pp. 184-190. For Pleistocene conditions see J. B. Woodworth, *Ancient Water Levels of the Champlain and Hudson Valleys* (Albany, 1905), N.Y. State Museum, Bulletin 84. For facts concerning water supply see *Surface Water Supply of the Hudson, Passaic, Raritan and Delaware River Drainages* (1907), being U.S. Geological Survey, Water Supply Paper, No. 202. For relation between physiography and history see chapters in E. C. Semple's *American History and its Geographic Conditions* (Boston, 1903); A. P. Brigham, *Geographic Influences in American History* (Boston, 1903); and *From Trail to Railway through the Appalachians* (Boston, 1907). See also E. M. Bacon, *The Hudson River* (New York, 1907); W. E. Verplanck and M. W. Collyer, *Sloops of the Hudson: Story of the Packet and Market Sloops of the Last Century* (New York, 1908); D. L. Buckman, *Old Steamboat Days on the Hudson River* (New York, 1907); and Clifton Johnson, *The Picturesque Hudson* (New York, 1909). (R. S. T.)

HUDSON'S BAY COMPANY, or "the Governor and Company of Adventurers of England trading into Hudson's Bay," a corporation formed for the purpose of importing into Great Britain the furs and skins which it obtains, chiefly by barter, from the Indians of British North America. The trading stations of the Company are dotted over the immense region (excluding Canada proper and Alaska), which is bounded E. and W. by the Atlantic and Pacific Oceans, and N. and S. by the Arctic Ocean and the United States. From these various stations the furs are despatched in part to posts in Hudson Bay and the coast of Labrador for transportation to England by the Company's ships, and in part by steamboat or other conveyances to points on the railways from whence they can be conveyed to Montreal, St. John,

N.B., or other Atlantic port, for shipment to London by Canadian Pacific Railway Company's mail ships, or other line of steamers, to be sold at auction.

In the year 1670 Charles II. granted a charter to Prince Rupert and seventeen other noblemen and gentlemen, incorporating them as the "Governor and Company of Adventurers of England trading into Hudson's Bay," and securing to them "the sole trade and commerce of all those seas, straits, bays, rivers, lakes, creeks and sounds, in whatsoever latitude they shall be, that lie within the entrance of the straits commonly called Hudson's Straits, together with all the lands and territories upon the countries, coasts and confines of the seas, bays, &c., aforesaid, that are not already actually possessed by or granted to any of our subjects, or possessed by the subjects of any other Christian prince or state." Besides the complete lordship and entire legislative, judicial and executive power within these vague limits (which the Company finally agreed to accept as meaning all lands watered by streams flowing into Hudson Bay), the corporation received also the right to "the whole and entire trade and traffic to and from all havens, bays, creeks, rivers, lakes and seas into which they shall find entrance or passage by water or land out of the territories, limits or places aforesaid." The first settlements in the country thus granted, which was to be known as Rupert's Land, were made on James Bay and at Churchill and Hayes rivers; but it was long before there was any advance into the interior, for in 1749, when an unsuccessful attempt was made in parliament to deprive the Company of its charter on the plea of "non-user," it had only some four or five forts on the coast, with about 120 regular employés. Although the commercial success of the enterprise was from the first immense, great losses, amounting before 1700 to £217,514, were inflicted on the Company by the French, who sent several military expeditions against the forts. After the cession of Canada to Great Britain in 1763, numbers of fur-traders spread over that country, and into the north-western parts of the continent, and began even to encroach on the Hudson's Bay Company's territories. These individual speculators finally combined into the North-West Fur Company of Montreal.

The fierce competition which at once sprang up between the companies was marked by features which sufficiently demonstrate the advantages of a monopoly in commercial dealings with savages, even although it is the manifest interest of the monopolists to retard the advance of civilization towards their hunting grounds. The Indians were demoralized, body and soul, by the abundance of ardent spirits with which the rival traders sought to attract them to themselves; the supply of furs threatened soon to be exhausted by the indiscriminate slaughter, even during the breeding season, of both male and female animals; the worst passions of both whites and Indians were inflamed to their fiercest (see *RED RIVER SETTLEMENT*). At last, in 1821, the companies, mutually exhausted, amalgamated, obtaining a licence to hold for 21 years the monopoly of trade in the vast regions lying to the west and north-west of the older company's grant. In 1838 the Hudson's Bay Company acquired the sole rights for itself, and obtained a new licence, also for 21 years. On the expiry of this it was not renewed, and since 1859 the district had been open to all.

The licences to trade did not of course affect the original possessions of the Company. Under the terms of the Deed of Surrender, dated November 19th, 1869, the Hudson's Bay Company surrendered "to the Queen's Most Gracious Majesty, all the rights of Government, and other rights, privileges, liberties, franchises, powers and authorities, granted or purported to be granted to the said Government and Company by the said recited Letters Patent of His Late Majesty King Charles II.; and also all similar rights which may have been exercised or assumed by the said Governor and Company in any parts of British North America, not forming part of Rupert's Land or of Canada, or of British Columbia, and all the lands and territories within Rupert's Land (except and subject as in the said terms and conditions mentioned) granted or purported to be granted to the said Governor and Company by the said Letters Patent," subject to the terms and conditions set out in the Deed of Surrender, including the payment to the Company by the Canadian Government of a sum of £300,000 sterling on the transfer of Rupert's Land to the Dominion of Canada, the retention by the Company of its posts and stations, with a right of selection of a block of land adjoining each post in conformity with a schedule annexed to the Deed of Surrender; and the right to claim in any township or district within the Fertile Belt in which land is set out for settlement, grants of land not exceeding one-twentieth part of the land so set out. The boundaries of the Fertile Belt were in terms of the Deed of Surrender to be as follows:—"On the south by the United States' boundary; on the west by the Rocky Mountains; on the north by the northern branch of the Saskatchewan; on the east by Lake Winnipeg, the Lake of the Woods, and the waters connecting them," and "the Company was to be at liberty to carry on its trade without hindrance, in its corporate capacity; and no exceptional tax was to be placed on the Company's land, trade or servants, nor any import duty on goods introduced by them previous to the surrender."

An Order in Council was passed confirming the terms of the Deed of Surrender at the Court of Windsor, the 23rd of June 1870.

In 1872, in terms of the Dominion Lands Act of that year, it was mutually agreed in regard to the one-twentieth of the lands in the Fertile Belt reserved to the Company under the terms of the Deed of Surrender that they should be taken as follows:

"Whereas by article five of the terms and conditions in the Deed of Surrender from the Hudson's Bay Company to the Crown, the said Company is entitled to one-twentieth of the lands surveyed into Townships in a certain portion of the territory surrendered, described and designated as the Fertile Belt.

"And whereas by the terms of the said deed, the right to claim the said one-twentieth is extended over the period of fifty years, and it is provided that the lands comprising the same shall be determined by lot, and whereas the said Company and the Government of the Dominion have mutually agreed that with a view to an equitable distribution throughout the territory described, of the said one-twentieth of the lands, and in order further to simplify the setting apart thereof, certain sections or parts of sections, alike in numbers and position in each township throughout the said Territory, shall, as the townships are surveyed, be set apart and designated to meet and cover such one-twentieth:

"And whereas it is found by computation that the said one-twentieth will be exactly met, by allotting in every fifth township two whole sections of 640 acres each, and in all other townships one section and three quarters of a section each, therefore—

"In every fifth Township in the said Territory; that is to say: in those townships numbered 5, 10, 15, 20, 25, 30, 35, 40, 45, 50 and so on in regular succession northerly from the International boundary, the whole of sections Nos. 8 and 26, and in each and every of the other townships the whole of section No. 8, and the south half and north-west quarter of section 26 (except in the cases hereinafter provided for) shall be known and designated as the lands of the said Company."

See G. Bryce, *Remarkable History of the Hudson's Bay Company* (London, 1900); and A. C. Laut, *Conquest of the great Northwest; being the story of the adventurers of England known as Hudson's Bay Co.* (New York, 1909).

HUÉ, a town of French Indo-China, capital of Annam, on the Hué river (Song-Huong-Giang) about 8 m. from its mouth in the China Sea. Pop. about 42,000, of whom 240 are Europeans. The country immediately surrounding it is flat, alluvial land, traversed by streams and canals and largely occupied by rice fields. Beyond the plain rises a circle of hills formed by spurs of the mountains of Annam. The official portion of the town, fortified under French superintendence, lies on the left bank of the river within an enclosure over 7300 yds. square. It contains the royal palace, the houses of the native ministers and officials, the arsenals, &c. The palace stands inside a separate enclosure. Once forbidden ground, it is to-day open to foreigners, and the citadel is occupied by French troops. The palace of the French resident-general and the European quarter, opposite the citadel on the right bank of the Hué, are connected with the citadel by an iron bridge. Important suburbs adjoin the official town, the villages of Đông-Bo, Bo-vinh, Gia-Ho, Kim-Long and Nam-Pho forming a sort of commercial belt around it. Glass- and ivory-working are carried on, but otherwise industry is of only local importance. Rice is imported by way of the river. A frequent service of steam launches connects the town with the ports of Thuan-an, at the mouth of the river, and Tourane, on the bay of that name. Tourane is also united to Hué by a railway opened in 1906. In the vicinity the chief objects of interest are the tombs of the dead kings of Annam.

HUE AND CRY, a phrase employed in English law to signify the old common law process of pursuing a criminal with horn and voice. It was the duty of any person aggrieved, or discovering a felony, to raise the hue and cry,¹ and his neighbours were bound to turn out with him and assist in the discovery of the offender. In the case of a hue and cry, all those joining in the pursuit were justified in arresting the person pursued, even though it turned out that he was innocent. A swift fate awaited any one overtaken

¹The word "hue," which is now obsolete except in this phrase and in the "huers" on the Cornish coast who direct the pichard-fishing from the cliffs, is generally connected with the Old French verb *huer*, to cry, shout, especially in war or the chase. It has been suggested that while "cry" represents the sound of the voices of the pursuers, "hue" applies to the sound of horns or other instruments used in the pursuit; and so Blackstone, *Comment. iv. xxi. 293* (1809), "an hue and cry, *hutesum et clamor*, with horn and voice." "Hue," appearance, colour, is in Old English *hwe*, *hw*, cognate with Swedish *hij*, complexion, skin, and probably connected with Sanskrit *chawi*, skin, complexion, beauty.

by hue and cry, if he still had about him the signs of his guilt. If he resisted he could be cut down, while, if he submitted to capture, his fate was decided. Although brought before a court, he was not allowed to say anything in self-defence, nor was there any need for accusation, indictment or appeal. Although regulated from time to time by writs and statutes, the process of hue and cry continued to retain its summary method of procedure, and proof was not required of a culprit's guilt, but merely that he had been taken red-handed by hue and cry. The various statutes relating to hue and cry were repealed in 1827 (7 and 8 Geo. IV. c. 27). The Sheriffs Act 1837, re-enacting 3 Edw. I. c. 9, provides that every person in a county must be ready and appalled at the command of the sheriff and at the cry of the county to arrest a felon, and in default shall on conviction be liable to a fine.

"Hue and cry" has, from its original meaning, come to be applied to a proclamation for the capture of an offender or for the finding of stolen goods, and to an official publication, issued for the information of the authorities interested, in which particulars are given of offenders "wanted," offences committed, &c.

For the early history, see Pollock and Maitland, *History of English Law*, vol. ii.; W. Stubbs, *Select Charters*.

HUEHUETANANGO (*i.e.* in the local Indian dialect, "City of the Ancients"), the capital of the department of Huehuetanango, western Guatemala, 106 m. W.N.W. of Guatemala city, on the right bank and near the source of the river Salegua, a tributary of the Chiapas. Pop. (1905) about 12,000. Huehuetanango was built near the site of the ancient Indian city of Zakuleu, now represented by some ruins on a neighbouring ridge surrounded by deep ravines. It is the principal town of a fertile upland region, which produces coffee, cocoa and many European and tropical fruits. Chiantla, a neighbouring town mainly inhabited by Indians, was long the headquarters of a successful Dominican mission; its convent, enriched by the gifts of pilgrims and the revenues of the silver mines owned by the monks, became one of the wealthiest foundations in Central America. It was secularized in 1873, and the mines have been abandoned.

HUELVA, a maritime province of south-western Spain, formed in 1833 of districts taken from Andalusia, and bounded on the N. by Badajoz, E. by Seville, S. by the Gulf of Cadiz and W. by Portugal. Pop. (1900) 260,880; area 3013 sq. m. With the exception of its south-eastern angle, where the province merges into the flat waste lands known as Las Marismas, at the mouth of the Guadalquivir, Huelva presents throughout its entire extent an agreeably varied surface. It is traversed in a south-westerly direction by the Sierra Morena, here known, in its main ridge, as the Sierra de Aracena. The principal streams are the navigable lower reaches of the Guadalquivir and Guadiana, which respectively form for some distance the south-eastern and south-western boundaries; the Odiel and the Tinto, which both fall into the Atlantic by navigable *rias* or estuaries; the Malagon, Chanza, Alcalaboza and Murtiga, which belong to the Guadiana system; and the Huelva, belonging to that of the Guadalquivir. Huelva has a mild and equable climate, with abundant moisture and a fertile soil. Among the mountains there are many valuable woodlands, in which oaks, pines, beeches, cork-trees and chestnuts predominate, while the lowlands afford excellent pasturage. But agriculture and stock-breeding are here less important than in most Spanish provinces, although the exports comprise large quantities of fruit, oil and wine, besides cork and esparto grass. The headquarters of the fishing trades, which include the drying and salting of fish, are at Huelva, the capital, and Ayamonte on the Guadiana. There are numerous brandy distilleries; and bricks, pottery, soap, candles and flour are also manufactured; but the great local industry is mining. In 1903 no fewer than 470 mines were at work; and their output, consisting chiefly of copper with smaller quantities of manganese and iron, exceeded £1,500,000 in value. The celebrated Rio Tinto copper mines, near the sources of the Tinto, were, like those of Tharsis, 30 m. N.N.W. of Huelva, exploited long before the Christian era, probably by

the Carthaginians, and certainly by the Romans. They are still among the most important copper mines in the world (see RIO TINTO). Saline and other mineral springs are common throughout the province. Huelva is the principal seaport, and is connected with Seville on the east and Mérida on the north by direct railways, while a network of narrow-gauge railways gives access to the chief mining centres. The principal towns, besides Huelva (21,359) and Rio Tinto (11,603), which are described in separate articles, are Alosno (8187), Ayamonte (7530), Bollullos (7922), Moguer (8455), Nerva (7908) and Zalamea la Real (7335). The state and municipal roads are better engineered and maintained than those of the neighbouring provinces. See also ANDALUSIA.

HUELVA (the ancient Onuba, Onoba, or Onuba Aestuaria), the capital of the Spanish province of Huelva, about 10 m. from the Atlantic Ocean, on the left bank of the river Odiel, and on the Seville-Huelva, Mérida-Huelva and Rio Tinto-Huelva railways, the last-named being a narrow-gauge line. Pop. (1900) 21,357. Huelva is built on the western shore of a triangular peninsula formed by the estuaries of the Odiel and Tinto, which meet below the town. It is wholly modern in character and appearance, and owes its prosperity to an ever increasing transit trade in copper and other ores, for which it is the port of shipment. After 1872, when the famous Rio Tinto copper mines were for the first time properly exploited, it progressed rapidly in size and wealth. Dredging operations removed a great part of the sandbanks lining the navigable main channel of the Odiel, and deepened the water over the bar at its mouth; new railways were opened, and port works were undertaken on a large scale, including the construction of extensive quays and two piers, and the installation of modern appliances for handling cargo. Many of these improvements were added after 1900. Besides exporting copper, manganese and other minerals, which in 1903 reached 2,750,000 tons, valued at more than £1,500,000, Huelva is the headquarters of profitable sardine, tunny and bonito fisheries, and of a trade in grain, grapes, olives and cork. The copper and cork industries are mainly in British hands, and the bulk of the imports, which consist chiefly of coal, iron and steel and machinery, comes from Great Britain. Foodstuffs and Australian hardwood are also imported.

Huelva was originally a Carthaginian trading-station, and afterwards a Roman colony; but it retains few memorials of its past, except the Roman aqueduct, repaired in modern times, and the colossal statue of Columbus. This was erected in 1892 to commemorate the fourth centenary of his voyage to the new world in 1492-1493, which began and ended in the village of San Pálos de la Frontera on the Tinto. Columbus resided in the neighbouring monastery of Santa Maria la Rabida after his original plans for the voyage had been rejected by King John II. of Portugal in 1484. An exact reproduction of this monastery was erected in 1893 at the World's Fair, Chicago, U.S.A., and was afterwards converted into a sanatorium. Higher up the Tinto, above San Pálos, is the town of Moguer (pop. 8455), which exports large quantities of oil and wine.

HUÉRCAL OVERA, a town of south-eastern Spain, in the province of Almería, on the Lorca-Baza railway, and between two branches of the river Almanzora. Pop. (1900) 15,763. Huércal Overa is the chief town of a thriving agricultural district, largely dependent for its prosperity on the lead mining carried on among the surrounding highlands.

HUESCA, a frontier province of northern Spain, formed in 1833 of districts previously belonging to Aragon; and bounded on the N. by France, E. and S.E. by Lérida, S.W. and W. by Saragossa, and N.W. by Navarre. Pop. (1900) 244,867, area 5848 sq. m. The entire northern half of Huesca belongs to the mountain system of the Pyrenees, which here attain their greatest altitudes in Aneto, the highest point of the Maladetta ridge (11,168 ft.), and in Monte Perdido (10,997 ft.). The southern half forms part of the rugged and high-lying plateau of Aragon. Its only conspicuous range of hills is the Sierra de Alcubierre on the south-western border. The whole province is included in

the basin of the Ebro, and is drained by four of its principal tributaries—the Aragon in the north-west, the Gallego in the west, the Cinca in the centre, and the Noguera Ribagorzana along part of the eastern border. These rivers rise among the Pyrenees, and take a southerly course; the two last-named unite with the Segre on their way to join the Ebro. The Cinca receives the combined waters of the Alcanadre and Isuela on the right and the Esera on the left.

The climate varies much according to the region; in the north, cold winds from the snow-capped Pyrenees prevail, while in the south, the warm summers are often unhealthy from the humidity of the atmosphere. Agriculture, the leading industry of Huesca, is facilitated by a fairly complete system of irrigation, by means of which much waste land has been reclaimed, although large tracts remain barren. There is good summer pasturage on the mountains, where cattle, sheep and swine are reared. The mountains are richly clothed with forests of pine, beech, oak and fir, and the southern regions, wherever cultivation is possible, produce abundant crops of wheat and other cereals, vines, mulberries and numerous other fruits and vegetables. The mineral resources include argentiferous lead, copper, iron and cobalt, with salt, lignite, limestone, millstone, gypsum, granite and slate. None of these, however, occurs in large quantities; and in 1903 only salt, lignite and fluor-spar were worked, while the total output was worth less than £1500. Mineral springs are numerous, and the mining industry was formerly much more important; but the difficulties of transport hinder the development of this and other resources. Trade is most active with France, whither are sent timber, millstones, cattle, leather, brandy and wine. Between 1882 and 1892 the wine trade thrived greatly, owing to the demand for common red wines, suitable for blending with finer French vintages, but the exports subsequently declined, owing to the protective duties imposed by France. The manufactures, which are of little importance, include soap, spirits, leather, pottery and coarse cloth.

The Saragossa-Lérida-Barcelona railway traverses the province, and gives access, by two branch lines, to Jaca, by way of Huesca, the provincial capital, and to Barbastro. Up to the beginning of the 20th century this was the only railway completed, although it was supplemented by many good roads. But by the Railway Convention of 1904, ratified by the Spanish government in 1906, France and Spain agreed jointly to construct a Transpyrenean line from Oloron, in the Basses Pyrénées, to Jaca, which should pass through the Port de Canfranc, and connect Saragossa with Pau. Apart from the episcopal cities of Huesca (pop. 1900, 12,626) and Jaca (4934), which are separately described, the only towns in the province with more than 5000 inhabitants are Barbastro (7033), an agricultural market, and Fraga (6899), an ancient residence of the kings of Aragon, with a fine 12th century parish church and a ruined Moorish citadel. Monzon, long celebrated as the meeting-place of the Aragonese and Catalanian parliaments, is a town on the lower Cinca, with the ruins of a Roman fortification, and of a 12th century castle, which was owned by the Knights Templar. (See also ARAGON.)

HUESCA (anc. *Osca*), the capital of the Spanish province of Huesca, 35 m. N.N.E. of Saragossa, on the Tardienta-Huesca-Jaca railway. Pop. (1900), 12,626. Huesca occupies a height near the right bank of the river Isuela, overlooking a broad and fertile plain. It is a very ancient city and bears many traces of its antiquity. The streets in the older part are narrow and crooked, though clean, and many of the houses witness by their size and style to its former magnificence. It is an episcopal see and has an imposing Gothic cathedral, begun in 1400, finished in 1515, and enriched with fine carving. In the same plaza is the old palace of the kings of Aragon, formerly given up for the use of the now closed Sertoria (the university), so named in memory of a school for the sons of native chiefs, founded at Huesca by Sertorius in 77 B.C. (Plut. *Sert.* 15). Among the other prominent buildings are the interesting parish churches (San Pedro, San Martin and San Juan), the episcopal palace, and various benevolent and religious foundations. Considerable attention is

paid to public education, and there are not only several good primary schools, but schools for teachers, an institute, an ecclesiastical seminary, an artistic and archaeological museum, and an economic society. Huesca manufactures cloth, pottery, bricks and leather, but its chief trade is in wine and agricultural produce. The development of these industries caused an increase in the population which, owing to emigration to France, had declined by nearly 2000 between 1887 and 1897.

Strabo (iii. 161, where some editors read *Ileosca*) describes *Osca* as a town of the Iltergetes, and the scene of Sertorius's death in 72 B.C.; while Pliny places the Oscenses in *regio Vescitania*. Plutarch (*loc. cit.*) calls it a large city. Julius Caesar names it *Vencedora*; and the name by which Augustus knew it, *Urbs victrix Osca*, was stamped on its coins, and is still preserved on its arms. In the 8th century A.D. it was captured by the Moors; but in 1096 Pedro I. of Aragon regained it, after winning the decisive battle of Alcoraz.

HUET, PIERRE DANIEL (1630-1721), bishop of Avranches, French scholar, was born at Caen in 1630. He was educated at the Jesuit school of Caen, and also received lessons from the Protestant pastor, Samuel Bochart. At the age of twenty he was recognized as one of the most promising scholars of the time. He went in 1651 to Paris, where he formed a friendship with Gabriel Naudé, conservator of the Mazarin library. In the following year Samuel Bochart, being invited by Queen Christina to her court at Stockholm, took his friend Huet with him. This journey, in which he saw Leiden, Amsterdam and Copenhagen, as well as Stockholm, resulted chiefly in the discovery, in the Swedish royal library, of some fragments of Origen's *Commentary on St Matthew*, which gave Huet the idea of editing Origen, a task he completed in 1668. He eventually quarrelled with his friend Bochart, who accused him of having suppressed a line in Origen in the Eucharistic controversy. In Paris he entered into close relations with Chapelain. During the famous dispute of Ancients and Moderns Huet took the side of the Ancients against Charles Perrault and Desmarests. Among his friends at this period were Conrart and Pellisson. His taste for mathematics led him to the study of astronomy. He next turned his attention to anatomy, and, being himself shortsighted, devoted his inquiries mainly to the question of vision and the formation of the eye. In this pursuit he made more than 800 dissections. He then learned all that was then to be learned in chemistry, and wrote a Latin poem on salt. All this time he was no mere book-worm or recluse, but was haunting the salons of Mlle de Scudéry and the studios of painters; nor did his scientific researches interfere with his classical studies, for during this time he was discussing with Bochart the origin of certain medals, and was learning Syriac and Arabic under the Jesuit Parvilliers. He also translated the pastorals of Longus, wrote a tale called *Diane de Castro*, and defended, in a treatise on the origin of romance, the reading of fiction. On being appointed assistant tutor to the Dauphin in 1670, he edited with the assistance of Anne Lefèvre, afterwards Madame Dacier, the well-known edition of the *Delphin Classics*. This series was a comprehensive edition of the Latin classics in about sixty volumes, and each work was accompanied by a Latin commentary, *ordo verborum*, and verbal index. The original volumes have each an engraving of Arion and the Dolphin, and the appropriate inscription *in usum serenissimi Dolorum*. Huet was admitted to the Academy in 1674. He issued one of his greatest works, the *Demonstratio evangelica*, in 1679. He took holy orders in 1676, and two years later the king gave him the abbey of Aulnay, where he wrote his *Questiones Alectuanæ* (Caen, 1690), his *Censura philosophiæ Cartesianæ* (Paris, 1686), his *Nouveau mémoire pour servir à l'histoire du Cartésianisme* (1692), and his discussion with Boileau on the Sublime. In 1685 he was made bishop of Soissons, but after waiting for installation for four years he took the bishopric of Avranches instead. He exchanged the cares of his bishopric for what he thought would be the easier chair of the Abbey of Fontenay, but there he was vexed with continual lawsuits. At length he retired to the Jesuits' House in the Rue Saint Antoine at Paris, where he died in 1721. His great library

even paid homage to Otto, and supported him in his struggle against Louis. When Louis fell into the hands of the Normans in 945, he was handed over to Hugh, who released him in 946 only on condition that he should surrender the fortress of Laon. At the council of Ingelheim (948) Hugh was condemned, under pain of excommunication, to make reparation to Louis. It was not, however, until 950 that the powerful vassal became reconciled with his suzerain and restored Laon. But new difficulties arose, and peace was not finally concluded until 953. On the death of Louis IV. Hugh was one of the first to recognize Lothair as his successor, and, at the intervention of Queen Gerberga, was instrumental in having him crowned. In recognition of this service Hugh was invested by the new king with the duchies of Burgundy (his suzerainty over which had already been nominally recognized by Louis IV.) and Aquitaine. But his expedition in 955 to take possession of Aquitaine was unsuccessful. In the same year, however, Giselbert, duke of Burgundy, acknowledged himself his vassal and betrothed his daughter to Hugh's son Otto. At Giselbert's death (April 8, 956) Hugh became effective master of the duchy, but died soon afterwards, on the 16th or 17th of June 956.

HUGH CAPET (c. 938–996), king of France and founder of the Capetian dynasty, was the eldest son of Hugh the Great by his wife Hadwig. When his father died in 956 he succeeded to his numerous fiefs around Paris and Orleans, and thus becoming one of the most powerful of the feudatories of his cousin, the Frankish king Lothair, he was recognized somewhat reluctantly by that monarch as duke of the Franks. Many of the counts of northern France did homage to him as their overlord, and Richard I., duke of Normandy, was both his vassal and his brother-in-law. His authority extended over certain districts south of the Loire, and, owing to his interference, Lothair was obliged to recognize his brother Henry as duke of Burgundy. Hugh supported his royal suzerain when Lothair and the emperor Otto II. fought for the possession of Lorraine; but chagrined at the king's conduct in making peace in 980, he went to Rome to conclude an alliance with Otto. Laying more stress upon independence than upon loyalty, Hugh appears to have acted in a haughty manner toward Lothair, and also towards his son and successor Louis V.; but neither king was strong enough to punish this powerful vassal, whose clerical supporters already harboured the thought of securing for him the Frankish crown. When Louis V. died without children in May 987, Hugh and the late king's uncle Charles, duke of Lower Lorraine, were candidates for the vacant throne, and in this contest the energy of Hugh's champions, Adalberon, archbishop of Reims, and Gerbert, afterwards Pope Sylvester II., prevailed. Declaring that the Frankish crown was an elective and not an hereditary dignity, Adalberon secured the election of his friend, and crowned him, probably at Noyon, in July 987.

The authority of the new king was quickly recognized in his kingdom, which covered the greater part of France north of the Loire with the exception of Brittany, and in a shadowy fashion he was acknowledged in Aquitaine; but he was compelled to purchase the allegiance of the great nobles by large grants of royal lands, and he was hardly more powerful as king than he had been as duke. Moreover, Charles of Lorraine was not prepared to bow before his successful rival, and before Hugh had secured the coronation of his son Robert as his colleague and successor in December 987, he had found allies and attacked the king. Hugh was worsted during the earlier part of this struggle, and was in serious straits, until he was saved by the wiles of his partisan Adalberon, bishop of Laon, who in 991 treacherously seized Charles and handed him over to the king. This capture virtually ended the war, but one of its side issues was a quarrel between Hugh and Pope John XV., who was supported by the empire, then under the rule of the empresses Adelaide and Theophano as regents for the young emperor Otto III. In 987 the king had appointed to the vacant archbishopric of Reims a certain Arnulf, who at once proved himself a traitor to Hugh and a friend to Charles of Lorraine. In June 991, at the instance of the king, the French bishops deposed Arnulf and elected Gerbert in his stead, a proceeding which was displeasing to the pope, who excom-

municated the new archbishop and his partisans. Hugh and his bishops remained firm, and the dispute was still in progress when the king died at Paris on the 24th of October 996.

Hugh was a devoted son of the church, to which, it is not too much to say, he owed his throne. As lay abbot of the abbey of St Martin at Tours and of St Denis he was interested in clerical reform, was fond of participating in religious ceremonies, and had many friends among the clergy. His wife was Adelaide, daughter of William III., duke of Aquitaine, by whom he left a son, Robert, who succeeded him as king of France. The origin of Hugh's surname of *Capet*, which was also applied to his father, has been the subject of some discussion. It is derived undoubtedly from the Lat. *capa*, *cappa*, a cape, but whether Hugh received it from the cape which he wore as abbot of St Martin's, or from his youthful and playful habit of seizing caps, or from some other cause, is uncertain.

See Richerus, *Historiarum libri IV.*, edited by G. Waitz (Leipzig, 1877); F. Lot, *Les Derniers Carolingiens* (Paris, 1891); and *Études sur le règne de Hugues Capet* (Paris, 1900); G. Monod, "Les Sources du règne de Hugues Capet," in the *Revue historique*, tome xxviii. (Paris, 1891); P. Viollet, *La Question de la légitimité à l'égard de Hugues Capet* (Paris, 1892); and E. Lavisse, *Histoire de France*, tome ii. (Paris, 1903–1905).

HUGH DE PUISET (c. 1125–1195), bishop of Durham, was the nephew of Stephen and Henry of Blois; the latter brought him to England and made him an archdeacon of the see of Winchester. Hugh afterwards became archdeacon and treasurer of York. In 1153 he was chosen bishop of Durham, in spite of the opposition of the archbishop of York; but he only obtained consecration by making a personal visit to Rome. Hugh took little part in politics in the reign of Henry II., remaining in the north, immersed in the affairs of his see. He was, however, present with Roger, archbishop of York, at the coronation of young Henry (1170), and was in consequence suspended by Alexander III. He remained neutral, as far as he could, in the quarrel between Henry and Becket, but he at least connived at the rebellion of 1173 and William the Lion's invasion of England in that year. After the failure of the rebellion the bishop was compelled to surrender Durham, Norham and Northallerton to the king. In 1179 he attended the Lateran Council at Rome, and in 1181 by the pope's order he laid Scotland under an interdict. In 1184 he took the cross. At the general sale of offices with which Richard began his reign (1189) Hugh bought the earldom of Northumberland. The archbishopric of York had been vacant since 1181. This vacancy increased Hugh's power vastly, and when the vacancy was filled by the appointment of Geoffrey he naturally raised objections. This quarrel with Geoffrey lasted till the end of his life. Hugh was nominated justiciar jointly with William Longchamp when Richard left the kingdom. But Longchamp soon deprived the bishop of his place (1191), even going so far as to imprison Hugh and make him surrender his castle, his earldom and hostages. Hugh's chief object in politics was to avoid acknowledging Geoffrey of York as his ecclesiastical superior, but this he was compelled to do in 1195. On Richard's return Hugh joined the king and tried to buy back his earldom. He seemed on the point of doing so when he died. Hugh was one of the most important men of his day, and left a mark upon the north of England which has never been effaced. Combining in his own hands the palatinate of Durham and the earldom of Northumberland, he held a position not much dissimilar to that of the great German princes, a local sovereign in all but name.

See Kate Norgate's *England under the Angevin Kings* (1887); Stubbs's preface to *Hoveden*, iii.

HUGH OF ST CHER (c. 1200–1263), French cardinal and Biblical commentator, was born at St Cher, a suburb of Vienne, Dauphiné, and while a student in Paris entered the Dominican convent of the Jacobins in 1225. He taught philosophy, theology and canon law. As provincial of his order, which office he held during most of the third decade of the century, he contributed largely to its prosperity, and won the confidence of the popes Gregory IX., Innocent IV. and Alexander IV., who charged him with several important missions. Created cardinal-priest in 1244, he played an important part in the council of Lyons in

1245, contributed to the institution of the Feast of Holy Sacrament, the reform of the Carmelites (1247), and the condemnations of the *Introductions in evangelium aeternum* of Gherardino del Borgo San Donnino (1255), and of William of St Amour's *De periculis novissimorum temporum*. He died at Orvieto on the 19th of March 1263. He directed the first revision of the text of the Vulgate, begun in 1236 by the Dominicans; this first "correctorium," vigorously criticized by Roger Bacon, was revised in 1248 and in 1256, and forms the base of the celebrated *Correctorium Biblicae Sorbonicum*. With the aid of many of his order he edited the first concordance of the Bible (*Concordantiae Sacrorum Bibliorum* or *Concordantiae S. Jacobi*), but the assertion that we owe the present division of the chapters of the Vulgate to him is false.

Besides a commentary on the book of Sentences, he wrote the *Postillae in sacra scriptura juxta quadruplicem sensum, litteralem, allegoricum, anagogicum et morale*, published frequently in the 15th and 16th centuries. His *Sermones de tempore et sanctis* are apparently only extracts. His exegetical works were published at Venice in 1754 in 8 vols.

See, for sources, Quetif-Echard, *Scriptores ordinis praedicatorum*; Denifle, in *Archiv für Literatur und Kirchengeschichte des Mittelalters*, i. 49, ii. 171, iv. 263 and 471; *L'Année dominicaine*, iii. (1886) 509 and 883; *Charitularium universitatis Parisiensis*, i. 158. (H. L.)

HUGH OF ST VICTOR (c. 1078–1141), mystic philosopher, was probably born at Hartingam, in Saxony. After spending some time in a house of canons regular at Hamersleben, in Saxony, where he completed his studies, he removed to the abbey of St Victor at Marseilles, and thence to the abbey of St Victor in Paris. Of this last house he rose to be canon, in 1125 *scholasticus*, and perhaps even prior, and it was there that he died on the 11th of February 1141. His eloquence and his writings earned for him a renown and influence which far exceeded St Bernard's, and which held its ground until the advent of the Thomist philosophy. Hugh was more especially the initiator of a movement of ideas—the mysticism of the school of St Victor—which filled the whole of the second part of the 12th century. "The mysticism which he inaugurated," says Ch. V. Langlois, "is learned, unctuous, ornate, florid, a mysticism which never indulges in dangerous temerities; it is the orthodox mysticism of a subtle and prudent rhetorician." This tendency undoubtedly shows a marked reaction from the contentious theology of Roscellinus and Abelard. For Hugh of St Victor dialectic was both insufficient and perflous. Yet he did not profess the haughty contempt for science and philosophy which his followers the Victorines expressed; he regarded knowledge, not as an end in itself, but as the vestibule of the mystic life. The reason, he thought, was but an aid to the understanding of the truths which faith reveals. The ascent towards God and the functions of the "threefold eye of the soul"—*cogitatio, meditatio* and *contemplatio*—were minutely taught by him in language which is at once precise and symbolical.

Manuscript copies of his works abound, and are to be found in almost every library which possesses a collection of ancient writings. The works themselves are very numerous and very diverse. The middle ages attributed to him sixty works, and the edition in Migne's *Patr. Lat.* vols. cxxv–cxxxvii. (Paris, 1854) contains no fewer than forty-seven treatises, commentaries and collections of sermons. Of that number, however, B. Haureau (*Les Œuvres de Hugues de St Victor* (1st ed., Paris, 1859; 2nd ed., Paris, 1886) contests the authenticity of several, which he ascribes with some show of probability to Hugh of Fouilloi, Robert Paululus or others. Among those works with which Hugh of St Victor may almost certainly be credited may be mentioned the celebrated *De sacramentis christianae fidei*; the *Didascalicon de studio legendi*; the treatise on mysticism entitled *Soliloquium de artha animae, De contemplatione et ejus operibus, Aureum de meditando opusculum, De arca Noe morali, De arca Noe mystica, De vanitate mundi, De artha animae, De amore sponsi ad sponsam*, &c.; the introduction (*Praenotatunculae*) to the study of the Scriptures; homilies on the book of Ecclesiastes; commentaries on other books of the Bible, e.g. the Pentateuch, Judges, Kings, Jeremiah, &c.

See B. Haureau, *op. cit.* and *Notices et extraits des MSS. latins de la Bibliothèque Nationale*, passim; De Wulf, *Histoire de la philosophie médiévale* (Louvain, 1900), pp. 220–221; article by H. Denifle in *Archiv für Literatur und Kirchengeschichte des Mittelalters*, iii. 634–640 (1887); A. Mignon, *Les Origines de la scolastique et Hugues de St Victor* (Paris, 1895); J. Kilgenstein, *Die Gotteslehre des Hugo von St Victor* (1898). (P. A.)

HUGHES, DAVID EDWARD (1831–1900), Anglo-American electrician, was born on the 16th of May 1831 in London, but the earlier part of his life was spent in America, whither his parents emigrated when he was about seven years old. In 1850 he became professor of music at the college of Bardstow, Kentucky, and soon afterwards his attainments in physical science procured his appointment as teacher of natural philosophy at the same place. His professorial career, however, was brief, for in 1854 he removed to Louisville to supervise the manufacture of the type-printing telegraph instrument which he had been thinking out for some time, and which was destined to make both his name and his fortune. The patent for this machine was taken out in the United States in 1855, and its success was immediate. After seeing it well established on one side of the Atlantic, Hughes in 1857 brought it over to his native country, where, however, the telegraph companies did not receive it with any favour. Two or three years afterwards he introduced it to the notice of the French Government, who, after submitting it to severe tests, ultimately adopted it, and in the succeeding ten years it came into extensive use all over Europe, gaining for its inventor numerous honours and prizes. In the development of telephony also Hughes had an important share, and the telephone has attained its present perfection largely as a result of his investigations. The carbon transmitters which in various forms are in almost universal use are modifications of a simple device which he called a microphone, and which consists essentially of two pieces of carbon, in loose contact one with the other. The arrangement constitutes a variable electrical resistance of the most delicate character; if it is included in an electric circuit with a battery and subjected to the influence of sonorous vibrations, its resistance varies in such a way as to produce an undulatory current which affords an exact representation of the sound waves as to height, length and form. These results were published in 1878, but Hughes did much more work on the properties of such microphonic joints, of which he said nothing till many years afterwards. When towards the end of 1879 he found that they were also sensitive to "sudden electric impulses, whether given out to the atmosphere through the extra current from a coil or from a frictional machine," he in fact discovered the phenomena on which depends the action of the so-called "coherers" used in wireless telegraphy. But he went further and practised wireless telegraphy himself, surmising, moreover, that the agency he was employing consisted of true electric waves. Setting some source of the "sudden electric impulses" referred to above into operation in his house, he walked along the street carrying a telephone in circuit with a small battery and one of these microphonic joints, and found that the sounds remained audible in the telephone until he had traversed a distance of 500 yards. This experiment he showed to several English men of science, among others to Sir G. G. Stokes, to whom he broached the theory that the results were due to electric waves. That physicist, however, was not disposed to accept this explanation, considering that a sufficient one could be found in well-known electromagnetic induction effects, and Hughes was so discouraged at that high authority taking this view of the matter that he resolved to publish no account of his inquiry until further experiments had enabled him to prove the correctness of his own theory. These experiments were still in progress when H. R. Hertz settled the question by his researches on electric waves in 1887–1889. Hughes, who is also known for his invention of the induction balance and for his contributions to the theory of magnetism, died in London on the 22nd of January 1900. As an investigator he was remarkable for the simplicity of the apparatus which served his purposes, domestic articles like jam-pots, pins, &c., forming a large part of the equipment of his laboratory. His manner of life, too, was simple and frugal in the extreme. He amassed a large fortune, which, with the exception of some bequests to the Royal Society, the Paris Academy of Sciences, the Institution of Electrical Engineers, and the Paris Société Internationale des Electriciens, for the establishment of scholarships and prizes in physical science, was left to four London hospitals, subject only to certain life annuities.

estuary narrows suddenly into the river, and often exceeds 7 ft. in height. It is felt as high up as Calcutta, and frequently destroys small boats. The difference from the lowest point of low-water in the dry season to the highest point of high-water in the rains is reported to be 20 ft. 10 in. The greatest mean rise of tide, about 16 ft., takes place in March, April or May—with a declining range during the rainy season to a mean of 10 ft., and a minimum during freshets of 3 ft. 6 in.

HUGLI, or **HOOGHLY**, a town and district of British India, in the Burdwan division of Bengal, taking their name from the river Hugli. The town, situated on the right bank of the Hugli, 24 m. above Calcutta by rail, forms one municipality with Chinsura, the old Dutch settlement, lower down the river. Pop. (1901) 29,383. It contains the Hooghly College at Chinsura, a Mahomedan college, two high schools and a hospital with a Lady Duffern branch for female patients. The principal building is a handsome *iwambara*, or mosque, constructed out of funds which had accumulated from an endowment originally left for the purpose by a wealthy Shia gentleman, Mahommed Mohsin. The town was founded by the Portuguese in 1537, on the decay of Satgaon, the royal port of Bengal. Upon establishing themselves, they built a fort at a place called Gholghat (close to the present jail), vestiges of which are still visible in the bed of the river. This fort gradually grew into the town and port of Hugli.

The DISTRICT comprises an area of 1191 sq. m. In 1901 the population was 1,049,282, showing an increase of 1% in the decade. It is flat, with a gradual ascent to the north and north-west. The scenery along the high-lying bank of the Hugli has a quiet beauty of its own, presenting the appearance of a connected series of orchards and gardens, interspersed with factories, villages and temples. The principal rivers, besides the Hugli, are the Damodar and the Rupnarayan. As in other deltaic districts, the highest land lies nearest the rivers, and the lowest levels are found midway between two streams. There are in consequence considerable marshes both between the Hugli and the Damodar and between the latter river and the Rupnarayan. The district is traversed by the main line of the East Indian railway, with a branch to the pilgrim resort of Tarakeswar, whence a steam tramway has been constructed for a further distance of 31 m. The Eden canal furnishes irrigation, and there are several embankments and drainage works. Silk and indigo are both decaying industries, but the manufacture of brass and bell-metal ware is actively carried on at several places. There are several jute mills, a large flour mill, bone-crushing mills and a brick and tile works.

From an historical point of view the district possesses as much interest as any in Bengal. In the early period of Mahomedan rule Satgaon was the seat of the governors of Lower Bengal and a mint town. It was also a place of great commercial importance. In consequence of the silting up of the Saraswati, the river on which Satgaon was situated, the town became inaccessible to large ships, and the Portuguese settled at Hugli. In 1632 the latter place, having been taken from the Portuguese by the Mahomedans, was made the royal port of Bengal; and all the public offices and records were withdrawn from Satgaon, which rapidly fell into decay. In 1640 the East India Company established a factory at Hugli, their first settlement in Lower Bengal. In 1685, a dispute having taken place between the English factors and the nawab, the town was bombarded and burned to the ground. This was not the first time that Hugli had been the scene of a struggle deciding the fate of a European power in India. In 1679, when held by the Portuguese, it was besieged for three months and a half by a large Mahomedan force sent by the emperor Shah Jahan. The place was carried by storm; more than 2000 Portuguese were killed, upwards of 4000 prisoners taken, and of 300 vessels only 3 escaped. But Hugli district possesses historical interest for other European nations besides England and Portugal. The Dutch established themselves at Chinsura in the 17th century, and held the place till 1825, when it was ceded to Great Britain in exchange for the island of Sumatra. The Danes settled at Serampur in 1616, where they remained till 1845, when all Danish possessions in India were transferred to the East India Company. Chandernagore

was a French settlement in 1688. The English captured this town twice, but since 1816 it has remained in the possession of the French.

See D. G. Crawford, *A Brief History of the Hooghly District* (Calcutta, 1903).

HUGO, GUSTAV VON (1764-1844), German jurist, was born at Lörrach in Baden, on the 23rd of November 1764. From the gymnasium at Carlsruhe he passed in 1782 to the university of Göttingen, where he studied law for three years. Having received the appointment of tutor to the prince of Anhalt-Dessau, he took his doctor's degree at the university of Halle in 1788. Recalled in this year to Göttingen as extraordinary professor of law, he became ordinary professor in 1792. In the preface to his *Beiträge zur sivilistischen Bücherkenntnis der letzten vierzig Jahre* (1828-1829) he gives a sketch of the condition of the civil law teaching at Göttingen at that time. The Roman Canon and German elements of the existing law were, without criticism or differentiation, welded into an ostensible whole for practical needs, with the result that it was difficult to say whether historical truth or practical ends were most prejudiced. One man handed on the inert mass to the next in the same condition as he had received it, new errors crept in, and even the best of teachers could not escape from the false method which had become traditional. These were the evils which Hugo set himself to combat, and he became the founder of that historical school of jurisprudence which was continued and further developed by Savigny. His *magna opera* are the *Lehrbuch eines sivilistischen Kurses* (7 vols., 1792-1821), in which his method is thoroughly worked out, and the *Zivilistisches Magazin* (6 vols., 1790-1837). He died at Göttingen on the 15th of September 1844.

For an account of his life see Eymannhardt, *Zur Erinnerung an Gustav Hugo* (Berlin, 1845).

HUGO, VICTOR MARIE (1802-1885), French poet, dramatist and romance-writer, youngest son of General J. L. S. Hugo (1773-1828), a distinguished soldier in Napoleon's service, was born at Besançon on the 26th of February 1802. The all but still-born child was only kept alive and reared by the indefatigable devotion of his mother Sophie Trébuchet (d. 1821), a royalist of La Vendée. Educated first in Spain and afterwards in France, the boy whose infancy had followed the fortunes of the imperial camp grew up a royalist and a Catholic. His first work in poetry and in fiction was devoted to the passionate proclamation of his faith in these principles.

The precocious eloquence and ardour of these early works made him famous before his time. The odes which he published at the age of twenty, admirable for their spontaneous fervour and fluency, might have been merely the work of a marvellous boy; the ballads which followed them two years later revealed him as a great poet, a natural master of lyric and creative song. In 1823, at the age of twenty-one, he married his cousin Adèle Foucher (d. 1868). In the same year his first romance, *Has d'Islande*, was given to the press; his second, *Bug-Jargal*, appeared three years later. In 1827 he published the great dramatic poem of *Cromwell*, a masterpiece at all points except that of fitness for the modern stage. Two years afterwards he published *Les Orientales*, a volume of poems so various in style, so noble in spirit, so perfect in workmanship, in music and in form, that they might alone suffice for the foundation of an immortal fame. In the course of nine years, from 1831 to 1840, he published *Les Feuilles d'automne*, *Les Chants du crépuscule*, *Les Voix intérieures* and *Les Rayons et les ombres*.

That their author was one of the greatest elegiac and lyric poets ever born into the world, any one of these volumes would amply suffice to prove. That he was the greatest tragic and dramatic poet born since the age of Shakespeare, the appearance of *Hernani* in 1830 made evident for ever to all but the meanest and most perverse of dunces and malignants. The earlier and even greater tragedy of *Marion de Lorme* (1828) had been proscribed on the ground that it was impossible for royalty to tolerate the appearance of a play in which a king was represented as the puppet of a minister. In all the noble and glorious life of the greatest poet of his time there is nothing on record

more chivalrous and characteristic than the fact that Victor Hugo refused to allow the play which had been prohibited by the government of Charles X. to be instantly produced under the government of his supersessor. *Le Roi s'amuse* (1832), the next play which Hugo gave to the stage, was prohibited by order of Louis Philippe after a tumultuous first night—to reappear fifty years later on the very same day of the same month, under the eyes of its author, with atoning acclamation from a wider audience than the first. Terror and pity had never found on the stage word or expression which so exactly realised the ideal aim of tragic poetry among the countrymen of Aeschylus and Sophocles since the time or since the passing of Shakespeare, of Marlowe and of Webster. The tragedy of *Lucrèce Borgia*, coequal in beauty and power with its three precursors, followed next year in the humbler garb of prose; but the prose of Victor Hugo stands higher on the record of poetry than the verse of any lesser dramatist or poet. *Marie Tudor* (1833), his next play, was hardly more daring in its Shakespearean defiance of historic fact, and hardly more triumphant in its Shakespearean loyalty to the everlasting truth of human character and passion. *Angelo, Tyran de Padoue* (1835), the last of the tragic triad to which their creator denied the transfiguration of tragic verse, is inferior to neither in power of imagination and of style, in skill of invention and construction, and in mastery over all natural and noble sources of pity and of terror. *La Esmeralda*, the libretto of an opera founded on his great tragic romance of *Notre-Dame de Paris*, is a miracle of lyric melody and of skilful adaptation. *Ruy-Blas* (1838) was written in verse, and in such verse as none but he could write. In command and in expression of passion and of pathos, of noble and of evil nature, it equals any other work of this great dramatic poet; in the lifelike fusion of high comedy with deep tragedy it excels them all. *Les Burgraves*, a tragic poem of transcendent beauty in execution and imaginative audacity in conception, found so little favour on the stage that the author refused to submit his subsequent plays to the verdict of a public audience.

Victor Hugo's first mature work in prose fiction, *Le Dernier Jour d'un condamné*, has appeared thirteen years earlier (1839). As a tragic monodrama it is incomparable for sustained power and terrible beauty. The story of *Claude Gueux*, published five years later (1834), another fervent protest against the infliction of capital punishment, was followed by many other eloquent and passionate appeals to the same effect, written or spoken on various occasions which excited the pity or the indignation of the orator or the poet. In 1831 appeared the greatest of all tragic or historic or romantic poems in the form of prose narrative, *Notre-Dame de Paris*. Three years afterwards the author published, under the title of *Littérature et philosophie mêlées*, a compilation or selection of notes and essays ranging and varying in date and in style from his earliest effusions of religious royalism to the magnificent essay on Mirabeau which represents at once the historical opinion and the critical capacity of Victor Hugo at the age of thirty-two. Next year he published *Le Rhin*, a series of letters from Germany, brilliant and vivid beyond all comparison, containing one of the most splendid stories for children ever written, and followed by a political supplement rather pathetically unprophectic in its predictions.

At the age of thirty-eight he honoured the French Academy by taking his place among its members; the speech delivered on the occasion was characteristically generous in its tribute to an undeserving memory, and significantly enthusiastic in its glorification of Napoleon. Idolatry of his father's hero and leader had now superseded the earlier superstition inculcated by his mother. In 1836 his first speech in the chamber of peers—Louis Philippe's House of Lords—was delivered on behalf of Poland; his second, on the subject of coast defence, is memorable for the evidence it bears of careful research and practical suggestion. His pleading on behalf of the exiled family of Bonaparte induced Louis Philippe to cancel the sentence which excluded its members from France. After the fall and flight of the house of Orleans, his parliamentary eloquence was never

less generous in aim and always as fervent in its constancy to patriotic and progressive principle. When the conspiring forces of clerical venality and political prostitution had placed a putative Bonaparte in power attained by perjury after perjury, and supported by massacre after massacre, Victor Hugo, in common with all honourable men who had ever taken part in political or public life under the government superseded by force of treason and murder, was driven from his country into an exile of well-nigh twenty years. Next year he published *Napoléon le petit*; twenty-five years afterwards, *Histoire d'un crime*. In these two books his experience and his opinion of the tactics which founded the second French empire stand registered for all time. In the deathless volume of *Châtiments*, which appeared in 1853, his indignation, his genius, and his faith found such utterance and such expression as must recall to the student alternately the lyric inspiration of Coleridge and Shelley, the prophetic inspiration of Dante and Isaiah, the satiric inspiration of Juvenal and Dryden. Three years after *Les Châtiments*, a book written in lightning, appeared *Les Contemplations*, a book written in sunlight and starlight. Of the six parts into which it is divided, the first translates into many-sided music the joys and sorrows, the thoughts and fancies, the studies and arduous and speculations of youth; the second, as full of light and colour, and grows gradually deeper in tone of thought and music; the third is yet riper and more various in form of melody and in fervour of meditation; the fourth is the noblest of all tributes ever paid by song to sorrow—a series of poems consecrated to the memory of the poet's eldest daughter, who was drowned, together with her husband, by the upsetting of a boat off the coast of Normandy, a few months after their wedding-day, in 1843; the fifth and the sixth books, written during his first four years of exile (all but one noble poem which bears date nine years earlier than its epilogue or postscript), contain more than a few poems unsurpassed and unsurpassable for depth and clarity and trenchancy of thought, for sublimity of inspiration, for intensity of faith, for loyalty in translation from nature, and for tenderness in devotion to truth; crowned and glorified and completed by their matchless dedication to the dead. Three years later again, in 1859, Victor Hugo gave to the world the first instalment of the greatest book published in the 19th century, *La Légende des siècles*. Opening with a vision of Eve in Paradise which eclipses Milton's in beauty no less than in sublimity—a dream of the mother of mankind at the hour when she knew the first sense of dawning motherhood, it closes with a vision of the trumpet to be sounded on the day of judgment which transcends the imagination of Dante by right of a realized idea which was utterly impossible of conception to a believer in Dante's creed: the idea of real and final equity; the concept of absolute and abstract righteousness. Between this opening and this close the pageant of history and of legend, marshalled and vivified by the will and the hand of the poet, ranges through an infinite variety of action and passion, of light and darkness, of terror and pity, of lyric rapture and of tragic triumph.

After yet another three years' space the author of *La Légende des siècles* reappeared as the author of *Les Misérables*, the greatest epic and dramatic work of fiction ever created or conceived: the epic of a soul transfigured and redeemed, purified by heroism and glorified through suffering; the tragedy and the comedy of life at its darkest and its brightest, of humanity at its best and at its worst. Two years afterwards the greatest man born since the death of Shakespeare paid homage to the greatest of his predecessors in a volume of magnificent and discursive eloquence which bore the title of *William Shakespeare*, and might, as its author admitted and suggested, more properly have been entitled *À propos de Shakespeare*. It was undertaken with the simple design of furnishing a preface to his younger son's translation of Shakespeare; a monument of perfect scholarship, of indefatigable devotion, and of literary genius, which eclipses even Urquhart's Rabelais—its only possible competitor; and to which the translator's father prefixed a brief and admirable note of introduction in the year after the

remnants of the Protestant army and by a march as able as it was audacious moved on Paris, and the Peace of St Germain was signed on the 8th of August 1570.

For a moment it seemed reasonable to hope that the war was at an end. Coligny had said that he would prefer to be dragged through the streets of Paris than to recommence the fighting; Charles IX. had realized the nobility and the patriotism of the man who wished to drive the Spaniards from Flanders; Henri de Bourbon was to marry Marguerite of France. Peace seemed to be assured when on the night of the 24th of August, 1572, after a council at which Catherine de' Medici, Charles IX., the duke of Anjou and other leaders of the League assisted, there occurred the treacherous Massacre of St Bartholomew (*q.v.*) in which Coligny and all the leading Huguenots were slain. This date marks a disastrous epoch in the history of France, the long period of triumph of the Catholic reaction, during which the Huguenots had to fight for their very existence. The Paris massacre was repeated throughout France; few were those who were noble enough to decline to become the executioners of their friends, and the Protestants were slain in thousands. The survivors resolved upon a desperate resistance. It was at this time that the Huguenots were driven to form a political party; otherwise they must, like the Protestants of Spain, have been exterminated. This party was formed at Milhau in 1573, definitely constituted at La Rochelle in 1588, and lasted until the peace of Alais in 1629. The delegates selected by the churches bound themselves to offer a united opposition to the violence of the enemies of God, the king and the state. It is a profound mistake to attribute to them, as their enemies have done, the intention of overthrowing the monarchy and substituting a republic. They were royalists to the core, as is shown by the sacrifices they made for the sake of setting Henry IV. on the throne. It is true, however, that among themselves they formed a kind of republic which, according to the historian J. A. de Thou, had its own laws dealing with civil government, justice, war, commerce, finance. They had a president called the Protector of the Churches, an office held first by Condé and afterwards by the king of Navarre up to the day on which he became king of France as Henry IV. (1589). The fourth religious war, which had broken out immediately after the Massacre of St Bartholomew, was brought to an end by the pacification of Boulogne (July 16, 1573), which granted a general amnesty, but the obstinate intolerance of the League resulted in the creation of a Catholic party called "les Politiques" which refused to submit to their domination and offered aid to the Huguenots against the Guises. The recollections of the horrors of St Bartholomew's night had hastened the death of Charles IX., the last of the Valois; he had been succeeded by the most debauched and effeminate of monarchs, Henry III. Once more war broke out. Henry of Guise, "le Balafré," nephew of the cardinal of Lorraine, became chief of the League, while the duke of Anjou, the king's brother, made common cause with the Huguenots. The peace of Monsieur, signed on the 5th of May 1576, marked a new victory of liberty of conscience, but its effect was ephemeral; hostilities soon recommenced and lasted for many years, and only became fiercer when the duke of Anjou died on the 10th of June 1584.

The fact that on the death of Henry III. the crown would pass to Henry of Navarre, the Protector of the Churches, induced the Guise party to declare that they would never accept a heretical monarch, and, at the instigation of Henry of Guise, Cardinal de Bourbon was nominated by them to succeed. Henry of Navarre since 1575 leader of the Huguenots, had year by year seen his influence increase, and now, faced by the machinations of the Guises, who had made overtures to Spain, declared that his only object was to free the feeble Henry III. from their influence. On the 20th of October 1587 he won the battle of Coutras, but on the 28th the foreign Protestants who were coming to his aid were routed by Guise at Montargis. The new body, known as "the Sixteen of Paris," thereupon compelled Henry III. to sign the "Edict of Union" by which the cardinal of Bourbon was declared heir presumptive. The

king could not, however, endure the humiliation of hearing Henry of Guise described as "king of Paris" and on the 23rd of December 1588 had him murdered together with the cardinal of Lorraine at the château of Blois. The League, now led by the duke of Mayenne, Guise's brother, declared war to the knife upon him and caused him to be excommunicated. In his isolation Henry III. threw himself into the arms of Henry of Navarre, who saved the royalist party by defeating Mayenne and escorted the king with his victorious army to St. Cloud, whence he proposed to enter Paris and destroy the League. But Henry III., on the 1st of August 1589, was assassinated by the monk Jacques Clement, on his deathbed appointing Henry of Navarre as his successor.

This only spurred the League to redoubled energy, and Mayenne proclaimed the cardinal of Bourbon king with the title of Charles X. But Henry IV., who had already promised to maintain the Roman Church, gained new adherents every day, defeated the Leaguers at Arques in 1589, utterly routed Mayenne at Ivry on the 14th of March 1590, and laid siege to Paris. Cardinal de Bourbon having died in the same year and France being in a state of anarchy, Philip II. of Spain, in concert with Pope Gregory XIV., who excommunicated Henry IV., supported the claims of the infanta Isabella. Mayenne, unable to continue the struggle without Spanish help, promised to assist him, but Henry neutralized this danger by declaring himself a Roman Catholic at St Denis (July 25, 1593), saying, "Paris after all is worth a mass, in spite of the advice and the prayers of my faithful Huguenots." "It is with anguish and grief," writes Beza, "that I think of the fall of this prince in whom so many hopes were placed." On the 22nd of March 1594 Henry entered Paris. The League was utterly defeated. Thus the Huguenots after forty years of strife obtained by their constancy the promulgation of the Edict of Nantes (April 13, 1598), the charter of religion and political freedom (see NANTES. EDICT OF).

The Protestants might reasonably hope that Henry IV., in spite of his abjuration of their faith, would remember the devoted support which they had given him, and that his authority would guarantee the observance of the provisions of the Edict. Unhappily twelve years afterwards, on the 14th of May 1610, Henry was assassinated by Ravalliac, leaving the great work incomplete. Once more France was to undergo the misery of civil war. During the minority of Louis XIII. power resided in the hands of counsellors who had not inherited the wisdom of Henry IV. and were only too ready to favour the Catholic party. The Huguenots, realizing that their existence was at stake, once more took up arms in defence of their liberty under the leadership of Henri de Rohan (*q.v.*). Their watchword had always been that, so long as the state was opposed to liberty of conscience, so long there could be no end to religious and civil strife, that misfortune and disaster must attend an empire of which the sovereign identified himself with a single section of his people. Richelieu had entered the king's council on the 4th of May 1624; the destruction of the Huguenots was his policy and he pursued it to a triumphant conclusion. On the 28th of October 1628, La Rochelle, the last stronghold of the Huguenots, was obliged to surrender after a siege rendered famous for all time by the heroism of its defenders and of its mayor. The peace of Alais, which was signed on the 28th of June 1629, marks the end of the civil wars.

The Huguenots had ceased to exist as a political party and, in the assurance that liberty of conscience would be accorded to them, showed themselves loyal subjects. On the death of Louis XIII., the declaration of the 8th of July 1643 had guaranteed to the Protestants "free and unrestricted exercise of their religion," thus confirming the Edict of Nantes. The synods of Charenton (1644) and Loudun (1659) asserted their absolute loyalty to Louis XIV., a loyalty of which the Huguenots had given proof not only by their entire abstention from the troubles of the Fronde, but also by their public adherence to the king. The Roman Catholic clergy had never accepted the Edict of Nantes, and all their efforts were directed to obtaining

its revocation. As long as Mazarin was alive the complaints of the clergy were in vain, but when Louis XIV. attained his majority there commenced a legal persecution which was bound in time to bring about the ruin of the reformed churches. The Edict of Nantes, which was part of the law of the land, might seem to defy all attacks, but the clergy found means to evade the law by demanding that it should be observed with literal accuracy, disregarding the changes which had been produced in France during more than half a century. The clergy in 1661 successfully demanded that commissioners should be sent to the provinces to report infractions of the Edict, and thus began a judicial war which was to last for more than twenty years. All the churches which had been built since the Edict of Nantes were condemned to be demolished. All the privileges which were not explicitly stated in the actual text of the Edict were suppressed. More than four hundred proclamations, edicts or declarations attacking the Huguenots in their households and their civil freedom, their property and their liberty of conscience were promulgated during the years which preceded the revocation of the Edict of Nantes. In spite of all sufferings which this rigorous legislation inflicted upon them they did not cease to resist, and in order to crush this resistance and to compel them to accept the "king's religion," there were organized the terrible *dragonnades* (1683-1686) which effected the forcible conversion of thousands of Protestants who gave way under the tortures which were inflicted upon them. It was then that Louis XIV. declared that "the best of the larger part of our subjects, who formerly held the so-called reformed religion, have embraced the Catholic religion, and therefore the Edict of Nantes has become unnecessary"; on the 18th of October 1685 he pronounced its revocation. Thus under the influence of the clergy was committed one of the most flagrant political and religious blunders in the history of France, which in the course of a few years lost more than 400,000 of its inhabitants, men who, having to choose between their conscience and their country, endowed the nations which received them with their heroism, their courage and their ability.

There is perhaps no example in history of so cruel a persecution as this, which destroyed a church of which Protestant Europe was justly proud. At no period in its career had it numbered among its adherents so many men of eminence, Abbadie, Claude, Bayle, Du Bosc, Jurieu, Élie Benoist, La Placette, Basnage, Dailé, Mestrezat, Du Quesne, Schomberg, Ruvigny. There were no Huguenots left in France; those who, conquered by persecution, remained there were described as "New Catholics." All the pastors who refused to abjure their faith were compelled to leave the country within fifteen days. The work was complete. Protestantism, with its churches and its schools, was destroyed. As Bayle wrote, "France was Catholic to a man under the reign of Louis the Great."

Persecution had succeeded in silencing, but it could not convert the people. The Huguenots, before the ruins of their churches, remembered the early Christians and held their services in secret. Their pastors, making light of death, returned from the lands of their exile and visited their own churches to restore their courage. If any one denied the Catholic faith on his death-bed his body was thrown into the common sewers. The galleys were full of brave Huguenots condemned for remaining constant to the Protestant faith. For fifteen years the exiles continuously besought Louis XIV. to give them back their religious liberty. For a moment they hoped that the Treaty of Ryswick (1697) would realise their hopes, but Louis XIV. steadily declined to grant their requests. Despair armed the Cévennes, and in 1702 the war of the Camisards broke out, a struggle of giants sustained by Jean Cavalier with his mountaineers against the royal troops (see CAMISARDS and CAVALIER, JEAN). The Huguenots seemed to be finally conquered. On the 8th of March 1715 Louis XIV. announced that he had put an end to all exercise of the Protestant religion; but in this very year, on the 21st of August, while the king was dying at Versailles, there assembled together at Monoblet in Languedoc, under the presidency of a young man twenty years of age,

Antoine Court, a number of preachers, as the pastors were then called, with the object of raising the church from its ruins. This was the first synod of the Desert. To re-establish the abandoned worship, to unite the churches in the struggle for liberty of conscience, such was the work to which Court devoted his life, and which earned for him the name of the "Restorer of Protestantism" (see COURT, ANTOINE). In spite of persecution the Protestants continued their assemblies; the fear of death and of the galleys were alike powerless to break their resistance. On the demand of the clergy all marriages celebrated by their pastors were declared null and void, and the children born of these unions were regarded as bastards.

Protestantism, which persecution seemed to have driven from France, drew new life from this very persecution. Outlawed, exiles in their own country, deprived of all civil existence, the Huguenots showed an invincible heroism. The history of their church during the period of the Desert is the history of a church which refused to die. Amongst its famous defenders was Paul Rabaut, the successor of Antoine Court. Year by year the churches became more numerous. In 1756 there were already 40 pastors; several years later, in 1763, the date of the last synod of the Desert, their number had increased to 65. The question of Protestant marriages roused public opinion which could not tolerate the idea that Frenchmen, whose sole crime was their religious belief, should be condemned to civil death. The torture of Jean Calas, who was condemned on a false charge of having killed his son because he desired to become a Catholic, caused general indignation, of which Voltaire became the eloquent mouthpiece. Ideas of tolerance, of which Bayle had been the earliest advocate, became victorious, and owing to the devotion of Rabaut Saint-Étienne, son of Paul Rabaut, and the zeal of Lafayette, the edict of November 1787, in spite of the fierce opposition of the clergy, renewed the civil rights of the Huguenots by recognizing the validity of their marriages. Victories even greater were in store; two years later liberty of conscience was won. On the 22nd of August 1789 the pastor Rabaut Saint-Étienne, deputy for the *sénéchaussée* of Nîmes to the States General, cried out, "It is not tolerance which I demand, it is liberty, that my country should accord it equally without distinction of rank, of birth or of religion." The Declaration of the Rights of Man affirmed the liberty of religion; the Huguenots had not suffered in vain, for the cause for which their ancestors and themselves had suffered so much was triumphant, and it was the nation itself which proclaimed the victory. But religious passions were always active, and at Montauban as at Nîmes (1790) Catholics and Protestants came to blows. The Huguenots, having endured the persecutions of successive monarchs, had to endure those of the Terror; their churches were shut, their pastors dispersed and some died upon the scaffold. On the 3rd of Ventose, year II. (February 21, 1795), the church was divorced from the state and the Protestants devoted themselves to reorganization. Some years later Bonaparte, having signed the Concordat of the 15th of July 1801, promulgated the law of the 18th of Germinal, year X., which recognized the legal standing of the Protestant church, but took from it the character of free church which it had always claimed. So great was the contrast between a past which recalled to Protestants nothing but persecution, and a present in which they enjoyed liberty of conscience, that they accepted with a profound gratitude a régime of which the ecclesiastical standpoint was so alien to their traditions. With enthusiasm they repeated the words with which Napoleon had received the pastors at the Tuileries on the 16th of Frimaire, year XII.: "The empire of the law ends where the undefined empire of conscience begins; law and prince are powerless against this liberty."

The Protestants, on the day on which liberty of conscience was restored, could measure the full extent of the misery which they had endured. Of this people, which in the 16th century formed more than one-tenth of the population of France, there survived only a few hundred thousands; migration and persecution had more than decimated them. In 1626 there were 800

pastors in the service of 751 churches; in 1802 there were only 121 pastors and 171 churches; in Paris there was only a single church with a single pastor. The church had no faculty of theology, no schools, no Bible societies, no asylums, no orphanages, no religious literature. Everything had to be created afresh, and this work was pursued during the 19th century with the energy and the earnest faith which is characteristic of the Huguenot character.

At the fall of the Empire (1815) the reaction of the White Terror once more exposed the Protestants to outrage, and once more a number fled from persecution and sought safety in foreign countries. Peace having been established, attention was once more focussed on religious questions, and the period was marked in Protestantism by a remarkable awakening. On all sides churches were built and schools opened. It was an epoch of the greatest importance, for the church concentrated itself more and more on its real mission. During this period were founded the great religious societies:—Société biblique (1819), Société de l'instruction primaire (1820), Société des traités (1821), Société des missions (1822). The influence of English thought on the development of religious life was remarkable, and theology drew its inspiration from the writings of Paley, David Bogue, Chalmers, Ebenezer Erskine, Robert and James Alexander Haldane, which were translated into French. Later on German theology and the works of Kant, Neander and Schleiermacher produced a far-reaching effect. This was due to the period of persecution which had checked that development of religious thought which had been so remarkable a feature of French Protestantism of the 16th and 17th centuries.

Slowly Protestantism once more took its place in the national life. The greatest names in its history are those of Guizot and Cuvier; Adolf Monod, with Athanasie Coquerel, stand in the front rank of pulpit orators. The Protestants associated themselves with all the great philanthropic works—Baron Jules Delessert founded savings banks, Baron de Staël condemned slavery, and all France united to honour the pastor, Jean Frédéric Oberlin. But the reformers, if they had no longer to fear persecution, had still to fight in order to win respect for religious liberty, which was unceasingly threatened by their adversaries. Numerous were the cases tried at this epoch in order to obtain justice. On the other hand the old union of the reformed churches had ceased to exist since the revolution of July. Ecclesiastical strife broke out and has never entirely ceased. A schism occurred first in 1848, owing to the refusal of the synod to draw up a profession of faith, the comte de Gasparin and the pastor Frédéric Monod seceding and founding the Union des Églises Évangéliques de France, separated from the state, of which later on E. de Pressensé was to become the most famous pastor. Under the Second Empire (1852-1870) the divisions between the orthodox and the liberal thinkers were accentuated; they resulted in a separation which followed on the reassembly of the national synod, authorized in 1872 by the government of the Third Republic. The old Huguenot church was thus separated into two parts, having no other link than that of the Concordat of 1802 and each possessing its own peculiar organization.

The descendants of the Huguenots, however, remained faithful to the traditions of their ancestors, and extolled the great past of the French reform movement. Moreover, in 1859 were held the magnificent religious festivals to celebrate the third centenary of the convocation of their first national synod; and when on the 18th of October 1885 they recalled the 200th anniversary of the Revocation of the Edict of Nantes, they were able to assert that the Huguenots had been the first defenders of religious liberties in France. In the early days of the 20th century the work of restoring French Protestantism, which had been pursued with steady perseverance for more than one hundred years, showed great results. This church, which in 1802 had scarcely 100 pastors has seen this number increased to 1000; it possesses more than 900 churches or chapels and 180 presbyteries. In contrast with the poverty of religious life under the First Empire it presented a striking array of Bible societies, missionary societies, and others for evangelical, educational, pastoral and

charitable work, which bear witness to a church risen from its ruins. French Protestantism in the course of the 19th century reckoned among its members such eminent theologians as Timothée Colani (1824-1888), who together with Edmond Scherer founded the celebrated *Revue de théologie de Strasbourg* (1850); Edmond de Pressensé, editor of the *Revue chrétienne*, Charles Bois and Michel Nicolas, professors of theology at Montauban, Auguste Sabatier, professor of theology at the university of Paris, Albert Réville, professor at the Collège de France, Félix Pécaut, &c.; well-known preachers such as Eugène Bersier, Ernest Dhombres, Aristide Viguré, Numa Recolin, Auguste de Coppet, and missionaries, for example Eugène Casalis and Coillard; Jean Bost, who founded the hospitals at Laforce; historians like Napoléon Peyrat, the brothers Haag, who wrote *La France protestante*, François Puaux, Charles Coquerel, Onesime Douca, Henri Bordier, Edouard Sayous, de Félice, Théophile Rolles; Jean Pédezert, Léon Pilatte and others, who were journalists; such statesmen as Guizot, Léon Say, Waddington; such scholars as Cuvier, Broca, Wurtz, Friedel de Quatrefores; such illustrious soldiers and sailors as Rapp, Admirals Baudin, Jauréguiberry, Colonel Denfert-Rochereau. But the population of Protestant France does not exceed 750,000 souls, without counting the Lutherans, who are attached to the Confession of Augsburg, numbering about 75,000. Their chief centres are in the departments of Gard, Ardèche, Drôme, Lozère, the Deux Sèvres and the Seine.

The law of the 9th of December 1905, which separated the church from the state, has been accepted by the great majority of Protestants as a legitimate consequence of the reform principles. Nor has its application given rise to any difficulty with the state. They used their influence only in the direction of rendering the law more liberal and immediately devoted themselves to the organization of their churches under the new régime. If the two great parties, orthodox and liberal, have each their particular constitution, nevertheless a third party has been formed with the object of effecting a reconciliation of all the Protestant churches and of thus reconstituting the old Huguenot church.

BIBLIOGRAPHY.—A complete list of works is impossible. The following are the most important:—

General Authorities.—*Bulletin de la société de l'histoire du protestantisme français* (54 vols.), a most valuable collection, indispensable as a work of reference; Haag, *La France protestante*, lives of French Protestants (10 vols., 1846; 2nd ed., Henri Bordier, 6 vols., 1887); F. Puaux, *Histoire de la Réformation française* (7 vols., 1858) and articles "Calvin" and "France protestante" in *Encyclopédie des sciences religieuses de Lichtenberg*; Smalley, *History of the Reformed Religion in France* (3 vols., London, 1831); Browning, *History of the Huguenots* (1 vol., 1840); G. A. de Félice, *Histoire des protestants de France* (1874).

Special Periods.—H. M. Baird, *The Huguenots and Henry of Navarre* (2 vols., New York, 1886); and *History of the Rise of the Huguenots of France* (New York, 1879); A. W. Whitehead, *Gaspard de Coligny* (London, 1904); J. W. Thompson, *The Wars of Religion in France, 1559-1576* (1909); Th. Beza, *Histoire ecclésiastique des églises réformées au royaume de France* (3 vols., Antwerp, 1580; new edition by G. Baum and Cunitz, 1883); Crespin, *Histoire des martyrs persécutés et mis à mort pour la vérité de l'évangile* (2 vols. in fol., Geneva, 1619; abridged translation by Rev. A. Moadock, London, 1780); Pierre de la Place, *Commentaires sur l'état de la religion et de la république* (1565); Florimond de Raemond, *L'Histoire de la naissance, progrès et décadence de l'hérésie du siècle* (1610); De Thou, *Histoire universelle* (16 vols.); Th. Agruppa D'Aubigné, *Histoire universelle* (3 vols., Geneva, 1626); Hermingard, *Correspondance des réformateurs dans les pays de la langue française* (8 vols., 1866), a scholarly work and the most trustworthy source for the history of the origin of French reform. "Calvini opera" in the *Corpus reformationis*, edited by Reuss, Baum and Cunitz, particularly the correspondence, vols. x. to xxii.; Doumergue, *Jean Calvin, les hommes et les choses de son temps* (3 vols., 1899); G. von Polenz, *Geschichte des französischen Calvinismus* (5 vols., 1857); Étienne A. Laval, *Compendious history of the reformation in France and of the reformed Church in that Kingdom from the first beginning of the Reformation to the Repealing of the Edict of Nantes* (7 vols., London, 1737-1741); Soldan, *Geschichte des Protestantismus in Frankreich bis zum Tode Karls IX.* (2 vols., 1853); Merle D'Aubigné, *Histoire de la réformation en Europe au temps de Calvin* (5 vols., 1861).

17th Century.—Élie Benoit, *Histoire de l'Édit de Nantes* (5 vols., Delft, 1693), a work of the first rank; Aymon, *Tous les synodes*

nationaux des églises réformées de France (2 vols.); J. Quick, *Synodicon* (2 vols., London, 1692), important for the ecclesiastical history of French Protestantism; D'Huisseau, *La Discipline des églises réformées de France* (Amsterdam, 1710); H. de Rohan, *Mémoires . . . jusqu'en 1629* (Amsterdam, 1644); Jean Claude, *Les Plaintes des Protestans de France* (Cologne, 1686, new edition with notes by Frank Puaux, Paris, 1885); Pierre Jurieu, *Lettres pastorales* (3 vols., Rotterdam, 1688); Brousson, *Etat des Réformés de France* (3 vols., The Hague, 1685); Anquez, *Histoire des assemblées politiques des réformés de France* (1 vol., Paris, 1859); Pilatte, *Edits et arrêts concernant la religion prétendue réformée, 1662-1711* (1880); Douen, *Les Premiers pasteurs du Désert* (2 vols., 1879); H. M. Baird, *The Huguenots and The Revocation of the Edict of Nantes* (2 vols., New York).

18th Century.—Peyrat, *Histoire des pasteurs du Désert* (2 vols., 1842); Ch. Coquerel, *Histoire des églises du Désert* (2 vols., 1841); E. Hugues, Antoine Court, *Histoire de la restauration du protestantisme en France* (2 vols., 1872); *Les Synodes du Désert* (3 vols., 1875); A. Coquerel, *Jean Calas* (1869); Court de Gebelin, *Les Toulousains* (1763).

19th Century.—*Die protestantische Kirche Frankreichs* (2 vols., 1848); *Annuaire* de Rabaut 1807, de Soulier 1827, de De Prat 1862, (1878); *Agenda protestant* de Frank Puaux (1880-1894); *Agenda annuaire protestant* de Gambier (1895-1907); Berder, *Histoire du Synode de 1872* (2 vols.); Frank Puaux, *Les Écrivains du protestantisme français au XIX^e siècle*. See also CAMISARDS, CALVIN, EDICT OF NANTES.

HUGUES, CLOVIS (1851-1907), French poet and socialist, was born at Menerbes in Vaucluse on the 3rd of November 1851. He studied for the priesthood, but did not take orders. For some revolutionary articles in the local papers of Marseilles he was condemned in 1871 to three years' imprisonment and a fine of 6000 francs. In 1877 he fought a duel in which he killed his adversary, a rival journalist. Elected deputy by Marseilles in the general elections of 1881, he was at that time the sole representative of the Socialist party in the chambers. He was re-elected in 1885, and in 1893 became one of the deputies for Paris, retaining his seat until 1906. He died on the 11th of June 1907.

His poems, novels and comedies are full of wit and exuberant vitality.

His principal works are: *Poèmes de prison* (1875), written during his detention, *Jours de bataille* (1883); *Jours de combat* (1883); and *Le Travail* (1889); the novels, *Madame Phaton* (1885) and *Monsieur le gendarme* (1891); and the dramas, *Une étoile* (1888) and *Le sommeil de Danton* (1888).

HUICHOLO (pronounced Veetchol—a corruption of the native name *Vishalika* or *Vivarika*, doctors or healers), a tribe of Mexican Indians living in a mountainous region on the eastern side of the Chapalagaos river, Jalisco. Huichol tradition assigns the south as their place of origin. Their name of "healers" is deserved, for about one-fourth of the men are Shamans. The Huichols are in much the same social condition as at the time of the Aztec empire. They were conquered by the Spaniards in 1722.

For full description of the people and their habits see Carl Lumholtz, *Unknown Mexico* (1903).

HUITZILOPOCHTLI, the supreme being in the religions of ancient Mexico, and as a specialized deity, the god of war. He was the mythic leader and chief divinity of the Aztecs, dominant tribe of the Nahuatl nation. As a humming-bird Huitzilopochtli was alleged to have led the Aztecs to a new home. E. B. Tylor (*Primitive Culture*, 4th ed., vol. ii. p. 307) calls him an "inextricable compound parthenogenetic deity"; and finds, in the fact that his chief festival (when his paste idol was shot through with an arrow, and afterwards eaten) was at the winter solstice, ground for believing that he was at first a nature-god, whose life and death were connected with the year's. His idol was a huge block of basalt (still thought to be preserved in Mexico), on one side of which he is sculptured in hideous form, adorned with the feathers of the humming-bird. The ceremonies of his worship were of the most bloodthirsty character, and hundreds of human beings were murdered annually before his shrine, their limbs being eaten by his worshippers. When his temple was dedicated in 1486 it is traditionally reported that 70,000 people were killed. See Mexico.

HULDA, in Teutonic mythology, goddess of marriage. She was a beneficent deity, the patroness and guardian of all maidens (see ВЕРБНА).

HULKE, JOHN WHITAKER (1830-1895), British surgeon and geologist, was born on the 6th of November 1830, being the son of a well-known medical practitioner at Deal. He was educated partly at a boarding-school in this country, partly at the Moravian College at Neuwied (1843-1845), where he gained an intimate knowledge of German and an interest in geology through visits to the Eifel district. He then entered King's College school, and three years later commenced work at the hospital, becoming M.R.C.S. in 1852. In the Crimean War he volunteered, and was appointed (1855) assistant-surgeon at Smyrna and subsequently at Sebastopol. On returning home he became medical tutor at his old hospital, was elected F.R.C.S. in 1857, and afterwards assistant-surgeon to the Royal Ophthalmic Hospital, Moorfields (1857), and surgeon (1868-1890). In 1870 he became surgeon at the Middlesex hospital, and here much of his more important surgical work was accomplished. His skill as an operator was widely known: he was an excellent general surgeon, but made his special mark as an ophthalmologist, while as a geologist he attained a European reputation. He was elected F.R.S. in 1867 for his researches on the anatomy and physiology of the retina in man and the lower animals, particularly the reptiles. He subsequently devoted all his spare time to geology and especially to the fossil reptilia, describing many remains of Dinosaurs, to our knowledge of which as well as of other Saurians he largely contributed. In 1887 the Wollaston medal was awarded to him by the Geological Society of London. He was president of both the Geological and Pathological Societies in 1883, and president of the Royal College of Surgeons from 1893 until his death. He was a man with a wide range of knowledge not only of science but of literature and art. He died in London on the 19th of February 1895.

HULL, ISAAC (1775-1843), commodore in the U.S. navy, was born at Derby in Connecticut on the 9th of March 1775. He went to sea young in the merchant service and was in command of a vessel at the age of nineteen. In 1798 he was appointed lieutenant in the newly organized U.S. navy. From 1803 to 1805 he served in the squadron sent to chastise the Barbary pirates as commander of the "Enterprise," but was transferred to the "Argus" in November of 1803. When the War of 1812 broke out he was captain of the U.S. frigate "Constitution" (44), and was on a mission to Europe carrying specie for the payment of a debt in Holland. The "Constitution" was shadowed by British men-of-war, but was not attacked. In July of that year, however, he was pursued by a squadron of British vessels, and escaped by good seamanship and the fine sailing qualities of the "Constitution." He was to have been superseded, but put to sea before the officer who was to have relieved him arrived—an action which might have been his ruin if he had not signalized his cruise by the capture of the British frigate "Guerrière" (38). Captain Hull had been cruising off the Gulf of St Lawrence, and the engagement, which took place on the 19th of August, was fought south of the Grand Bank. The "Constitution" was a fine ship of 1533 tons, originally designed for a two-decker, but cut down to a frigate. The "Guerrière" was of 1092 tons and very ill-manned, while the "Constitution" had a choice crew. The British ship was easily overpowered. Hull received a gold medal for the capture of the "Guerrière," but had no further opportunity of distinction in the war. After the peace he held a variety of commands at sea, and was a naval commissioner from 1815 to 1817. He had a high reputation in the United States navy for practical seamanship. He died at Philadelphia on the 13th of February 1843.

HULL, a city (1875) and railway junction of the province of Quebec, Canada, and the capital of Wright county, opposite the city of Ottawa. Pop. (1901) 13,988. The magnificent water-power of the Chaudière Falls of the Ottawa is utilized for the lighting of the city, the operation of a system of electric railways connecting Hull with Ottawa and Aylmer, and a number of large saw-mills, pulp, paper and match manufactories. Hull has gone through several disastrous fires, but since that of 1900, which swept out most of the town, an efficient system of fire protection has been established. Three bridges unite Ottawa and Hull.

The city is governed by a council composed of a mayor and twelve aldermen elected annually. Champlain was the first white man to set foot on the site of Hull, but long before he came it was a favourite meeting-place for the Indians. Later it became familiar to explorers and fur-traders as the foot of the Chaudière portage, and many a canoe has been carried shoulder high over the site of future busy streets. Philemon Wright, of Woburn, Massachusetts, was the first man to settle here in 1800. The report he sent back was so favourable that a number of other families followed from the same place and laid the foundations of the future city. His descendants have remained among the substantial men of the town.

HULL (officially **KINGSTON-UPON-HULL**), a city and county of a city, municipal, county and parliamentary borough, and seaport in the East Riding of Yorkshire, England, at the junction of the river Hull with the Humber, 22 m. from the open sea, and 181 m. N. of London. Pop. (1891) 200,472; (1901) 240,259. Its full name, not in general use, is Kingston-upon-Hull. It is served by the North Eastern, Great Central and Hull & Barnsley railways, the principal station being Paragon Street. The town stands on a level plain so low as to render embankments necessary to prevent inundation. The older portion is completely enclosed by the Hull and Humber on the E. and S. and by docks on the N. and W. Here are narrow streets typical of the mediæval mercantile town, though modern improvements have destroyed some of them; and there are a few ancient houses. In Holy Trinity church Hull possesses one of the largest English parish churches, having an extreme length of 272 ft. It is cruciform and has a massive central tower. This and the transepts and choir are of Decorated work of various dates. The choir is largely constructed of brick, and thus affords an unusually early example of the use of this material in English ecclesiastical architecture. The nave is Perpendicular, a fine example of the style. William Mason the poet (1725-1797) was the son of a rector of the parish. The church of St Mary, Lowgate, was founded in the 14th century, but is almost wholly a reconstruction. Modern churches are numerous, but of no remarkable architectural merit. Among public buildings the town-hall, in Lowgate, ranks first. It was completed in 1866, but was subsequently extended and in great part rebuilt; it is in Italian renaissance style, having a richly adorned façade. The exchange, in the same street, was also completed in 1866, in a less ornate Italian style. There are also theatres, a chamber of commerce, corn exchange, market-hall, custom-house, and the dock offices, a handsome Italian building. The principal intellectual institution is the Royal Institution, a fine classical building opened by Albert, prince consort, in 1854, and containing a museum and large library. It accommodates the Literary and Philosophical Society. The grammar school was founded in 1486. One of its masters was Joseph Milner (1744-1797), author of a history of the Church; and among its students were Andrew Marvell the poet (1621-1678) and William Wilberforce the philanthropist (1759-1833), who is commemorated by a column and statue near the dock offices, and by the preservation of the house of his birth in High Street. This house belongs to the corporation and was opened in 1906 as the Wilberforce and Historical Museum. There are also to be mentioned the Hull and East Riding College, Hymer's College, comprising classical, modern and junior departments, the Trinity House marine school (1716), the Humber industrial school ship "Southampton," and technical and art schools. Charities and benevolent foundations are numerous. Trinity House is a charity for seamen of the merchant service; the building (1753) was founded by the Trinity House Gild instituted in 1360, and contains a noteworthy collection of paintings and a museum. The Charterhouse belongs to a foundation for the support of the old and feeble, established by Sir Michael de la Pole, afterwards earl of Suffolk, in 1384. The infirmary was founded in 1782. Of the three parks, Pearson Park was presented by a mayor of that name in 1860, and contains statues of Queen Victoria and the Prince Consort. A botanic garden was opened in 1880.

The original harbour occupied that part of the river Hull which faced the old town, but in 1774 an act was passed for forming a dock on the site of the old fortifications on the right bank of the Hull. This afterwards became known as Queen's dock, and with Prince's and Humber docks completes the circle round the old town. The small railway dock opens from Humber dock. East of the Hull lie the Victoria dock and extensive timber ponds, and west of the Humber dock basin, parallel to the Humber, is Albert dock. Others are the Alexandra, St Andrew's and fish docks. The total area of the docks is about 186 acres, and the owning companies are the North Eastern and the Hull & Barnsley railways. The ports of Hull and Gool (q.v.) have been administratively combined since 1888, the conservancy of the river being under the Humber Conservancy Board. Hull is one of the principal shipping ports for the manufactures of Yorkshire and Lancashire, and has direct communication with the coal-fields of the West Riding. Large quantities of grain are imported from Russia, America, &c., and of timber from Norway and Sweden. Iron, fish, butter and fruit are among other principal imports. The port was an early seat of the whale fisheries. Of passenger steamship services from Hull the principal are those to the Norwegian ports, which are greatly frequented during the summer; these, with others to the ports of Sweden, &c., are in the hands of the large shipping firm of Thomas Wilson & Co. A ferry serves New Holland, on the Lincolnshire shore (Great Central railway). The principal industries of Hull are iron-founding, shipbuilding and engineering, and the manufacture of chemicals, oil-cake, colours, cement, paper, starch, soap and cotton goods; and there are tanneries and breweries.

The parliamentary borough returns three members, an increase from two members in 1885. Hull became the seat of a suffragan bishop in the diocese of York in 1891. This was a revival, as the office was in existence from 1534 till the death of Edward VI. The county borough was created in 1888. The city is governed by a mayor, 16 aldermen and 48 councillors. Area, 8989 acres.

The first mention of Hull occurs under the name of Wyke-upon-Hull in a charter of 1160 by which Maud, daughter of Hugh Camin, granted it to the monks of Meaux, who in 1278 received licence to hold a market here every Thursday and a fair on the vigil, day and morrow of Holy Trinity and twelve following days. Shortly afterwards Edward I., seeing its value as a port, obtained the town from the monks in exchange for other lands in Lincolnshire and changed its name to Kingston-upon-Hull. To induce people to settle here he gave the town a charter in 1299. This granted two weekly markets on Tuesday and Friday and a fair on the eve of St Augustine lasting thirty days; it made the town a free borough and provided that the king would send his justices to deliver the prison when necessary. He sent commissioners in 1303 to inquire how and where the roads to the "new town of Kingston-upon-Hull" could best be made, and in 1321 Edward II. granted the burgesses licence to enclose the town with a ditch and "a wall of stone and lime." In the 14th century the burgesses of Hull disputed the right of the archbishop of York to prisage of wine and other liberties in Hull, which they said belonged to the king. The archbishop claimed under charters of King Æthelstand and Henry III. The dispute, after lasting several years, was at length decided in favour of the king. In 1381 Edward III., while inspecting former charters, granted that the burgesses might hold the borough with fairs, markets and free customs at a fee-farm of £70, and that every year they might choose a mayor and four bailiffs. The king in 1440 granted the burgesses Hessle, North Ferryby and other places in order that they might obtain a supply of fresh water. The charter also granted that the above places with the town itself should become the county of the town of Kingston-upon-Hull. Henry VIII. visited the town in 1541, and ordered that a castle and other places of defence should be built, and Edward VI. in 1552 granted the manor to the burgesses. The town was incorporated by Queen Elizabeth in 1576 and a new charter was granted by James II. in 1688. During the civil wars Hull, although the majority of the inhabitants were

royalists, was garrisoned by the parliamentarians, and Charles I. was refused admission by the governor Sir John Hotham. In 1643 it stood a siege of six weeks, but the new governor Ferdinando Fairfax, 2nd Baron Fairfax, obliged the Royalist army to retreat by opening the sluices and placing the surrounding country under water. Hull was represented in the parliament of 1295 and has sent members ever since, save that in 1384 the burgesses were exempted from returning any member on account of the expenses which they were incurring through fortifying their town. Besides the fairs granted to the burgesses by Edward I., two others were granted by Charles II. in 1664 to Henry Hildiard who owned property in the town.

See T. Gent, *Annales Regioduni Hullini* (York, 1735, reprinted 1869); G. Hadley, *History of the Town and County of Kingston-upon-Hull* (Hull, 1788); C. Frost, *Notices relative to the Early History of the Town and Port of Hull* (London, 1827); J. J. Sheaham, *General and Concise History of Kingston-upon-Hull* (London and Beverley, 1864).

HULL (in O.Eng. *hulu*, from *helan*, to cover, cf. Ger. *Hulle*, covering), the outer covering, pod, or shell of beans, peas, &c., also the enclosing envelope of a chrysalis. The word may be the same as "hull," meaning the body of a ship without its masts or superstructure, &c., but in this sense the word is more usually connected with "hold," the interior cargo-carrying part of a vessel. This word was borrowed, as a nautical term, from the Dutch, *hol* (cognate with "hole"), the *d* being due to confusion with "to hold," "grasp" (O.Eng. *healdan*). The meanings of "hull" and "hold" are somewhat far apart, and the closest sense resemblance is to the word "hulk," which is not known till about a century later.

HULLAH, JOHN FYKE (1812-1884), English composer and teacher of music, was born at Worcester on the 27th June 1812. He was a pupil of William Horsley from 1829, and entered the Royal Academy of Music in 1833. He wrote an opera to words by Dickens, *The Village Coquettes*, produced in 1836; *The Barbers of Bassora* in 1837, and *The Outpost* in 1838, the last two at Covent Garden. From 1839, when he went to Paris to investigate various systems of teaching music to large masses of people, he identified himself with Wilhem's system of the "fixed Do," and his adaptation of that system was taught with enormous success from 1840 to 1860. In 1847 a large building in Long Acre, called St Martin's Hall, was built by subscription and presented to Hullah. It was inaugurated in 1850 and burnt to the ground in 1860, a blow from which Hullah was long in recovering. He had risked his all in the maintenance of the building, and had to begin the world again. A series of lectures was given at the Royal Institution in 1861, and in 1864 he lectured in Edinburgh, but in the following year was unsuccessful in his application for the Reid professorship. He conducted concerts in Edinburgh in 1866 and 1867, and the concerts of the Royal Academy of Music from 1870 to 1873; he had been elected to the committee of management in 1869. In 1872 he was appointed by the Council of Education musical inspector of training schools for the United Kingdom. In 1878 he went abroad to report on the condition of musical education in schools, and wrote a very valuable report, quoted in the memoir of him published by his wife in 1886. He was attacked by paralysis in 1880, and again in 1883. His compositions, which remained popular for some years after his death in 1884, consisted mainly of ballads; but his importance in the history of music is owing to his exertions in popularizing musical education, and his persistent opposition to the Tonic Sol-Fa system, which had a success he could not foresee. His objections to it were partly grounded on the character of the music which was in common use among the early teachers of the system. While it cannot be doubted that Hullah would have won more success if he had not opposed the Tonic Sol-Fa movement so strenuously, it must be confessed that his work was of great value, for he kept constantly in view and impressed upon all who followed him or learnt from him the supreme necessity of maintaining the artistic standard of the music taught and studied, and of not allowing trumpety compositions to usurp the place of good music on account of the greater ease with which they could be read.

HULME, WILLIAM (1631-1691), English philanthropist, was born in the neighbourhood of Manchester, and died on the 29th of October 1691. Having lost his only son Banastre, Hulme left his property in trust to maintain "four exhibitioners of the poorest sort of bachelors for the space of four years" at Brasenose College, Oxford. This was the beginning of the Hulme Trust. Its property was in Manchester, and owing to its favourable situation its value increased rapidly. Eventually in 1881 a scheme was drawn up by the charity commissioners, by which (as amended in 1907) the trust is now governed. Its income of about £10,000 a year is devoted to maintaining the Hulme Grammar School in Manchester and to assisting other schools, to supporting a theological college, Hulme Hall, attached to the university of Manchester, and to providing a number of scholarships and exhibitions at Brasenose College.

See J. Croston, *Hulme's Charity* (1877).

HÜLS, a town of Germany, in the Prussian Rhine province, 4 m. N. of Crefeld and 17 N.W. of Düsseldorf by rail. Pop. (1905) 6520. It has two Roman Catholic churches, a synagogue and manufactures of damask and velvet. In the neighbourhood ironstone is obtained.

HULSE, JOHN (1708-1790), English divine, was born—the eldest of a family of nineteen—at Middlewich, in Cheshire, in 1708. Entering St John's College, Cambridge, in 1724, he graduated in 1728; and on taking orders (in 1732) was presented to a small country curacy. His father having died in 1753, Hulse succeeded to his estates in Cheshire, where, owing to feeble health, he lived in retirement till his death in December 1790. He bequeathed his estates to Cambridge University for the purpose of maintaining two divinity scholars (£30 a year each) at St John's College, of founding a prize for a dissertation, and of instituting the offices of Christian advocate and of Christian preacher or Hulsean lecturer. By a statute in 1866 the Hulsean professorship of divinity was substituted for the office of Christian advocate, and the lectureship was considerably modified. The first course of lectures under the benefaction was delivered in 1820. In 1830 the number of annual lectures or sermons was reduced from twenty to eight; after 1861 they were further reduced to a minimum of four. The annual value of the Hulse endowment is between £800 and £900, of which eight-tenths go to the professor of divinity and one-tenth to the prize and lectureship respectively.

An account of the Hulsean lectures from 1820 to 1894 is given in J. Hunt's *Religious Thought in the 19th Century*, 332-338; among the lecturers have been Henry Alford (1841), R. C. Trench (1845), Christopher Wordsworth (1847), Charles Merivale (1861), James Moorhouse (1865), F. W. Farrar (1870), F. J. A. Hort (1871), W. Boyd Carpenter (1878), W. Cunningham (1885), M. Creighton (1893).

HUMACAO, a small city and the capital of a municipal district and department of the same name, in Porto Rico, 46 m. S.E. of San Juan. Pop. (1899) of the city, 4428; and of the municipal district, 14,313. Humacao is attractively situated near the E. coast, 9 m. from the port of Naguabo and a little over 6 m. from its own port of Punta Santiago, with which it is connected by a good road; a railway was under construction in 1908, and some of the sugar factories of the department are now connected by rail with the port. The department covers the eastern end of the island and includes all the islands off its coast, among which are Culebra and Vieques; the former (pop. in 1899, 704) has two excellent harbours and is used as a U.S. naval station; the latter is 21 m. long by 6 m. wide and in 1899 had a population of nearly 6000. Grazing is the principal industry, but sugar-cane, tobacco and fruit are cultivated. There are valuable forests in the mountainous districts, a part of which has been set aside for preservation under the name of the Luquillo forest reserve. Humacao was incorporated as a city in 1899. It suffered severely in the hurricane of 1868, the damage not having been fully repaired as late as 1906.

HUMANE SOCIETY, ROYAL. This society was founded in England in 1774 for the purpose of rendering "first aid" in cases of drowning and for restoring life by artificial means to those apparently drowned. Dr William Hawes (1736-1808), an

English physician, became known in 1773 for his efforts to convince the public that persons apparently dead from drowning might in many cases be resuscitated by artificial means. For a year he paid a reward out of his own pocket to any one bringing him a body rescued from the water within a reasonable time of immersion. Dr Thomas Cogan (1736-1818), another English physician, who had become interested in the same subject during a stay at Amsterdam, where was instituted in 1767 a society for preservation of life from accidents in water, joined Hawes in his crusade. In the summer of 1774 each of them brought fifteen friends to a meeting at the Chapter Coffee-house, St Paul's Churchyard, when the Royal Humane Society was founded. The society, the chief offices of which are at 4 Trafalgar Square, London, has upwards of 280 depôts throughout the kingdom, supplied with life-saving apparatus. The chief and earliest of these depôts is the Receiving House in Hyde Park, on the north bank of the Serpentine, which was built in 1794 on a site granted by George III. Boats and boatmen are kept to render aid to bathers, and in the winter ice-men are sent round to the different skating grounds in and around London. The society distributes money-rewards, medals, clasps and testimonials, to those who save or attempt to save drowning people. It further recognizes "all cases of exceptional bravery in rescuing or attempting to rescue persons from asphyxia in mines, wells, blasting furnaces, or in sewers where foul gas may endanger life." It further awards prizes for swimming to public schools and training ships. Since 1873 the Stanhope gold medal has been awarded "to the case exhibiting the greatest gallantry during the year." During the year 1905 873 persons were rewarded for saving or attempting to save 947 lives from drowning. The society is maintained by private subscriptions and bequests. Its motto is *Lateat scintilla forsan, "a small spark may perhaps lie hid."* (See also DROWNING AND LIFE-SAVING.)

HUMANISM (from Lat. *humanius*, human, connected with *homo*, mankind), in general any system of thought or action which assigns a predominant interest to the affairs of men as compared with the supernatural or the abstract. The term is specially applied to that movement of thought which in western Europe in the 15th century broke through the medieval traditions of scholastic theology and philosophy, and devoted itself to the rediscovery and direct study of the ancient classics. This movement was essentially a revolt against intellectual, and especially ecclesiastical authority, and is the parent of all modern developments whether intellectual, scientific or social (see RENAISSANCE). The term has also been applied to the philosophy of Comte in virtue of its insistence on the dignity of humanity and its refusal to find in the divine anything external or superior to mankind, and the same tendency has had marked influence over the development of modern Christian theology which inclines to obliterate the old orthodox conception of the separate existence and overlordship of God. The narrow sense of the term survives in modern university terminology. Thus in the University of Oxford the curriculum known as *Litterae Humaniores* ("Humane Literature") consists of Latin and Greek literature and philosophy, i.e. of the "arts," often described in former times as the "polite letters." In the Scottish universities the professor of Latin is called the professor of "humanity." The plural "humanities" is a generic term for the classics. In ordinary language the adjective "humane" is restricted to the sense of "kind-hearted," "unselfish": the abstract "humanity" has this sense and also the sense of "that which pertains to mankind" derived in this case with the companion adjective "human."

HUMANITARIANS, a term applied (1) to a school of theologians who repudiate the doctrine of the Trinity and hold an extreme view of the person of Christ as simply human. The adoption of this position by men like Nathaniel Lardner, Joseph Priestley and Theophilus Lindsey in the middle of the 18th century led to the establishment of the first definitely organized Unitarian churches in England. (2) It is also applied to those who believe in the perfectibility of man apart from superhuman aid, especially those who follow the teaching of Pierre Leroux (q.v.).

The name is also sometimes given to the Positivists, and, in a more general sense, to persons whose chief principle of action is the desire to preserve others from pain and discomfort.

HUMAYUN (1508-1556), Mogul emperor of Delhi, succeeded his father Baber in India in 1530, while his brother Kamra obtained the sovereignty of Kabul and Lahore. Humayun was thus left in possession of his father's recent conquests, which were in dispute with the Indian Afghans under Sher Shah, governor of Bengal. After ten years of fighting, Humayun was driven out of India and compelled to flee to Persia through the desert of Sind, where his famous son, Akbar the Great, was born in the petty fort of Umarkot (1542). Sher Shah was killed at the storming of Kalinjar (1545), and Humayun, returning to India with Akbar, then only thirteen years of age, defeated the Indo-Afghan army and reoccupied Delhi (1555). India thus passed again from the Afghans to the Moguls, but six months afterwards Humayun was killed by a fall from the parapet of his palace (1556), leaving his kingdom to Akbar. The tomb of Humayun is one of the finest Mogul monuments in the neighbourhood of Delhi, and it was here that the last of the Moguls, Bahadur Shah, was captured by Major Hodson in 1857.

HUMBER, an estuary on the east coast of England formed by the rivers Trent and Ouse, the northern shore belonging to Yorkshire and the southern to Lincolnshire. The junction of these two important rivers is near the village of Faxfleet, from which point the course of the Humber runs E. for 18 m., and then S.E. for 19 m. to the North Sea. The total area draining to the Humber is 9293 sq. m. The width of the estuary is 1 m. at the head, gradually widening to 3½ m. at 8 m. above the mouth, but here, with a great shallow bay on the Yorkshire side, it increases to 8 m. in width. The seaward horn of this bay, however, is formed by a narrow protruding bank of sand and stones, thrown up by a southward current along the Yorkshire coast, and known as Spurn Head. This reduces the width of the Humber mouth to 5½ m. Except where the Humber cuts through a low chalk ridge, between north and south Ferryby, dividing it into the Wolds of Yorkshire and of Lincolnshire, the shores and adjacent lands are nearly flat. The water is muddy; and the course for shipping considerably exceeds in length the distances given above, by reason of the numerous shoals it is necessary to avoid. The course is carefully buoyed and lighted, for the Humber is an important highway of commerce, having on the Yorkshire bank the great port of Hull, and on the Lincolnshire bank that of Grimsby, while Goole lies on the Ouse a little above the junction with the Trent. Canals connect with the great manufacturing district of South Yorkshire, and the Trent opens up wide communications with the Midlands. The phenomenon of the tidal bore is sometimes seen on the Humber. The action of the river upon the flat Yorkshire shore towards the mouth alters the shore-line constantly. Many ancient villages have disappeared entirely, notably Ravenspur or Ravense, once a port, represented in parliament under Edward I., and the scene of the landing of Bolingbroke, afterwards Henry IV., in 1399. Soon after this the town, which lay immediately inside Spurn Point, must have been destroyed.

HUMBERT, RANIERI CARLO EMANUELE GIOVANNI MARIA FERDINANDO EUGENIO, KING OF ITALY (1844-1900), son of Victor Emmanuel II. and of Adelaide, archduchess of Austria, was born at Turin, capital of the kingdom of Sardinia, on the 14th of March 1844. His education was entrusted to the most eminent men of his time, amongst others to Massimo d'Azeglio and Pasquale Stanislao Mancini. Entering the army on the 14th of March 1858 with the rank of captain, he was present at the battle of Solferino in 1859, and in 1866 commanded a division at Custoza. Attacked by the Austrian cavalry near Villafranca, he formed his troops into squares and drove the assailants towards Sommacampagna, remaining himself throughout the action in the square most exposed to attack. With Bixio he covered the retreat of the Italian army, receiving the gold medal for valour. On the 21st of April 1868 he married his cousin, Margherita Teresa Giovanna, princess of Savoy, daughter

of the duke of Genoa (born at Turin on the 20th of November 1851). On the 11th of November 1869 Margherita gave birth to Victor Emmanuel, prince of Naples, afterwards Victor Emmanuel III. of Italy. Ascending the throne on the death of his father (9th January 1878), Humbert adopted the style "Humbert I. of Italy" instead of Humbert IV., and consented that the remains of his father should be interred at Rome in the Pantheon, and not in the royal mausoleum of Superga (see CRISPI). Accompanied by the premier, Cairoli, he began a tour of the provinces of his kingdom, but on entering Naples (November 17, 1878), amid the acclamations of an immense crowd, was attacked by a fanatic named Passanante. The king ward off the blow with his sabre, but Cairoli, in attempting to defend him, was severely wounded in the thigh. The would-be assassin was condemned to death, but the sentence was by the king commuted to one of penal servitude for life. The occurrence upset for several years the health of Queen Margherita. In 1881 King Humbert, again accompanied by Cairoli, resumed his interrupted tour, and visited Sicily and the southern Italian provinces. In 1882 he took a prominent part in the national mourning for Garibaldi, whose tomb at Caprera he repeatedly visited. When, in the autumn of 1882, Verona and Venetia were inundated, he hastened to the spot, directed salvage operations, and provided large sums of money for the destitute. Similarly, on the 28th of July 1883, he hurried to Ischia, where an earthquake had engulfed some 5000 persons. Countermanding the order of the minister of public works to cover the ruins with quicklime, the king prosecuted salvage operations for five days longer, and personally saved many victims at the risk of his own life. In 1884 he visited Busca and Naples, where cholera was raging, helping with money and advice the numerous sufferers, and raising the spirit of the population. Compared with the reigns of his grandfather, Charles Albert, and of his father, Victor Emmanuel, the reign of Humbert was tranquil. Scrupulously observant of constitutional principles, he followed, as far as practicable, parliamentary indications in his choice of premiers, only one of whom—Rudini—was drawn from the Conservative ranks. In foreign policy he approved of the conclusion of the Triple Alliance, and, in repeated visits to Vienna and Berlin, established and consolidated the pact. Towards Great Britain his attitude was invariably cordial, and he considered the Triple Alliance imperfect unless supplemented by an Anglo-Italian naval *entente*. Favourably disposed towards the policy of colonial expansion inaugurated in 1885 by the occupation of Massawa, he was suspected of aspiring to a vast empire in north-east Africa, a suspicion which tended somewhat to diminish his popularity after the disaster of Adowa on the 1st of March 1896. On the other hand, his popularity was enhanced by the firmness of his attitude towards the Vatican, as exemplified in his telegram declaring Rome "intangible" (September 20, 1886), and affirming the permanence of the Italian possession of the Eternal City. Above all King Humbert was a soldier, jealous of the honour and prestige of the army to such a degree that he promoted a duel between his nephew, the count of Turin, and Prince Henry of Orleans (August 15, 1897) on account of the aspersions cast by the latter upon Italian arms. The claims of King Humbert upon popular gratitude and affection were enhanced by his extraordinary munificence, which was not merely displayed on public occasions, but directed to the relief of innumerable private wants into which he had made personal inquiry. It has been calculated that at least £100,000 per annum was expended by the king in this way. The regard in which he was universally held was abundantly demonstrated on the occasion of the unsuccessful attempt upon his life made by the anarchist Acciarito near Rome on the 22nd of April 1897, and still more after his tragic assassination at Monza by the anarchist Bresci on the evening of the 29th of July 1900. Good-humoured, active, tender-hearted, somewhat fatalistic, but, above all, generous, he was spontaneously called "Humbert the Good." He was buried in the Pantheon in Rome, by the side of Victor Emmanuel II., on the 9th of August 1900. (H. W. S.)

HUMBOLDT, FRIEDRICH HEINRICH ALEXANDER, BARON VON (1769–1859), German naturalist and traveller, was born at Berlin, on the 14th of September 1769. His father, who was a major in the Prussian army, belonged to a Pomeranian family of consideration, and was rewarded for his services during the Seven Years' War with the post of royal chamberlain. He married in 1766 Maria Elizabeth von Colomb, widow of Baron von Hollwede, and had by her two sons, of whom the younger is the subject of this article. The childhood of Alexander von Humboldt was not a promising one as regards either health or intellect. His characteristic tastes, however, soon displayed themselves; and from his fancy for collecting and labelling plants, shells and insects he received the playful title of "the little apothecary." The care of his education, on the unexpected death of his father in 1779, devolved upon his mother, who discharged the trust with constancy and judgment. Destined for a political career, he studied finance during six months at the university of Frankfort-on-the-Oder; and a year later, April 25, 1789, he matriculated at Göttingen, then eminent for the lectures of C. G. Heyne and J. F. Blumenbach. His vast and varied powers were by this time fully developed; and during the vacation of 1789 he gave a fair earnest of his future performances in a scientific excursion up the Rhine, and in the treatise thence issuing, *Mineralogische Beobachtungen über einige Basalte am Rhein* (Brunswick, 1790). His native passion for distant travel was confirmed by the friendship formed by him at Göttingen with George Forster, Heyne's son-in-law, the distinguished companion of Captain Cook's second voyage. Henceforth his studies, which his rare combination of parts enabled him to render at once multifarious, rapid and profound, were directed with extraordinary insight and perseverance to the purpose of preparing himself for his distinctive calling as a scientific explorer. With this view he studied commerce and foreign languages at Hamburg, geology at Freiberg under A. G. Werner, anatomy at Jena under J. C. Loder, astronomy and the use of scientific instruments under F. X. von Zach and J. G. Köhler. His researches into the vegetation of the mines of Freiberg led to the publication in 1793 of his *Florae Fribergensis Specimen*; and the results of a prolonged course of experiments on the phenomena of muscular irritability, then recently discovered by L. Galvani, were contained in his *Versuche über die gereizte Muskel- und Nervenfaser* (Berlin, 1797), enriched in the French translation with notes by Blumenbach.

In 1794 he was admitted to the intimacy of the famous Weimar coterie, and contributed (June 1795) to Schiller's new periodical, *Die Horen*, a philosophical allegory entitled *Die Lebenskraft, oder der rhodische Genius*. In the summer of 1790 he paid a flying visit to England in company with Forster. In 1792 and 1797 he was in Vienna; in 1795 he made a geological and botanical tour through Switzerland and Italy. He had obtained in the meantime official employment, having been appointed assessor of mines at Berlin, February 29, 1792. Although the service of the state was consistently regarded by him but as an apprenticeship to the service of science, he fulfilled its duties with such conspicuous ability that he not only rapidly rose to the highest post in his department, but was besides entrusted with several important diplomatic missions. The death of his mother, on the 19th of November 1796, set him free to follow the bent of his genius, and, finally severing his official connexions, he waited for an opportunity of executing his long-cherished schemes of travel. On the postponement of Captain Baudin's proposed voyage of circumnavigation, which he had been officially invited to accompany, he left Paris for Marseilles with Aimé Bonpland, the designated botanist of the frustrated expedition, hoping to join Bonaparte in Egypt. Means of transport, however, were not forthcoming, and the two travellers eventually found their way to Madrid, where the unexpected patronage of the minister d'Urquijo determined them to make Spanish America the scene of their explorations.

Armed with powerful recommendations, they sailed in the "Pizarro" from Corunna, on the 5th of June 1799, stopped six days at Tenerife for the ascent of the Peak, and landed, on the

Hermann und Dorothea, published in 1800, had already placed him in the first rank of authorities on aesthetics, and, together with his family connexions, had much to do with his appointment at Rome; while in the years 1795 and 1797 he had brought out translations of several of the odes of Pindar, which were held in high esteem. On quitting his post at Rome he was made councillor of state and minister of public instruction. He soon, however, retired to his estate at Tegel, near Berlin, but was recalled and sent as ambassador to Vienna in 1812 during the exciting period which witnessed the closing struggles of the French empire. In the following year, as Prussian plenipotentiary at the congress of Prague, he was mainly instrumental in inducing Austria to unite with Prussia and Russia against France; in 1815 he was one of the signatories of the capitulation of Paris, and the same year was occupied in drawing up the treaty between Prussia and Saxony, by which the territory of the former was largely increased at the expense of the latter. The next year he was at Frankfurt settling the future condition of Germany, but was summoned to London in the midst of his work, and in 1818 had to attend the congress at Aix-la-Chapelle. The reactionary policy of the Prussian government made him resign his office of privy councillor and give up political life in 1819; and from that time forward he devoted himself solely to literature and study.

During the busiest portion of his political career, however, he had found time for literary work. Thus in 1816 he had published a translation of the *Agamemnon* of Aeschylus, and in 1817 corrections and additions to Adelung's *Mikrologisches*, that famous collection of specimens of the various languages and dialects of the world. Among these additions that on the Basque language is the longest and most important, Basque having for some time specially attracted his attention. In fact, Wilhelm von Humboldt may be said to have been the first who brought Basque before the notice of European philologists, and made a scientific study of it possible. In order to gain a practical knowledge of the language and complete his investigations into it, he visited the Basque country itself, the result of his visit being the valuable "Researches into the Early Inhabitants of Spain by the help of the Basque language" (*Prüfung der Untersuchungen über die Urbewohner Hispaniens vermittelst der vaskischen Sprache*), published in 1821. In this work he endeavoured to show, by an examination of geographical names, that a race or races speaking dialects allied to modern Basque once extended through the whole of Spain, the southern coast of France and the Balearic Islands, and suggested that these people, whom he identified with the Iberians of classical writers, had come from northern Africa, where the name of Berber still perhaps perpetuates their old designation. Another work on what has sometimes been termed the metaphysics of language appeared from his pen in 1828, under the title of *Über den Dualis*; but the great work of his life, on the ancient Kawi language of Java, was unfortunately interrupted by his death on the 8th of April 1835. The imperfect fragment was edited by his brother and Dr Buschmann in 1836, and contains the remarkable introduction on "The Heterogeneity of Language and its Influence on the Intellectual Development of Mankind" (*Über die Verschiedenheit des menschlichen Sprachbaues und ihren Einfluss auf die geistige Entwicklung des Menschengeschlechts*), which was afterwards edited and defended against Steinthal's criticisms by Pott (2 vols., 1876). This essay, which has been called the text-book of the philosophy of speech, first clearly laid down that the character and structure of a language expresses the inner life and knowledge of its speakers, and that languages must differ from one another in the same way and to the same degree as those who use them. Sounds do not become words until a meaning has been put into them, and this meaning embodies the thought of a community. What Humboldt terms the inner form of a language is just that mode of denoting the relations between the parts of a sentence which reflects the manner in which a particular body of men regards the world about them. It is the task of the morphology of speech to distinguish the various ways in which languages differ from each other as regards

their inner form, and to classify and arrange them accordingly. Other linguistic publications of Humboldt, which had appeared in the *Transactions* of the Berlin Academy, the *Journal* of the Royal Asiatic Society, or elsewhere, were republished by his brother in the seven volumes of Wilhelm von Humboldt's *Gesammelte Werke* (1841-1852). These volumes also contain poems, essays on aesthetic subjects and other creations of his prolific mind. Perhaps, however, the most generally interesting of his works, outside those which deal with language, is his correspondence with Schiller, published in 1830. Both poet and philosopher come before us in it in their most genial mood. For, though Humboldt was primarily a philosopher, he was a philosopher rendered practical by his knowledge of statesmanship and wide experience of life, and endowed with keen sympathies, warm imagination and active interest in the method of scientific inquiry. (A. H. S.)

HUMBUGH, an imposture, sham, fraud. The word seems to have been originally applied to a trick or hoax, and appears as a slang term about 1750. According to the *New English Dictionary*, Ferdinando Killigrew's *The Universal Jester*, which contains the word in its sub-title "a choice collection of many conceits . . . bonmots and humbughs," was published in 1754, not, as is often stated, in 1735-1740. The principal passage in reference to the introduction of the word occurs in *The Student*, 1750-1751, ii. 41, where it is called "a word very much in vogue with the people of taste and fashion." The origin appears to have been unknown at that date. Skeat connects it (*Etym. Dict.* 1898) with "hum," to murmur applause, hence flatter, trick, cajole, and "bug," bogey, spectre, the word thus meaning a false alarm. Many fanciful conjectures have been made, e.g. from Irish *wim-bog*, soft copper, worthless as opposed to sterling money; from "Hamburg," as the centre from which false coins came into England during the Napoleonic wars; and from the Italian *uomo bugiardo*, lying man.

HUME, ALEXANDER (c. 1557-1609), Scottish poet, second son of Patrick Hume of Polwarth, Berwickshire, was born, probably at Reidbrais, one of his family's houses, about 1557. It has been generally assumed that he is the Alexander Hume who matriculated at St Mary's college, St Andrews, in 1571, and graduated in 1574. In *Ane Epistle to Maister Gilbert Moncreif* (Moncreiff), *mediciner to the Kings Majestie, wherein is set downe the Experience of the Authours youth*, he relates the course of his disillusionment. He says he spent four years in France before beginning to study law in the courts at Edinburgh (l. 136). After three years' experience there he abandoned law in disgust and sought a post at court (ib. l. 241). Still dissatisfied, he took orders, and became in 1597 minister of Logie, near Stirling, where he lived until his death on the 4th of December 1609. His best-known work is his *Hymns, or Sacred Songs* (printed by Robert Waldegrave at Edinburgh in 1599, and dedicated to Elizabeth Melvill, Lady Comrie) containing an epistle to the Scottish youth, urging them to abandon vanity for religion. One poem of the collection, entitled "A description of the day Estivali," a sketch of a summer's day and its occupations, has found its way into several anthologies. "The Triumph of the Lord after the Manner of Men" is a song of victory of some merit, celebrating the defeat of the Armada in 1588. His prose works include *Ane Treatise of Conscience* (Edinburgh, 1594), *A Treatise of the Felicitie of the Life to come* (Edinburgh, 1594), and *Ane Afoold Admonition to the Ministerie of Scotland*. The last is an argument against prelaty. Hume's elder brother, Lord Polwarth, was probably one of the combatants in the famous "Flyting betwixt Montgomerie and Polwart."

The editions of Hume's verse are: (a) by Robert Waldegrave (1599); (b) a reprint of (a) by the Bannatyne Club (1832); and (c) by the Scottish Text Society (ed. A. Lawson) (1902). The last includes the prose tracts.

HUME, DAVID (1711-1776), English philosopher, historian and political economist, was born at Edinburgh, on the 16th of April (O.S.) 1711. His father, Joseph Hume or Home, a scion of the noble house of Home of Douglas (but see *Notes and Queries*, 4th ser. iv. 72), was owner of a small estate in

Berwickshire, on the banks of the Whiteadder, called, from the spring rising in front of the dwelling-house, Ninewells. David was the youngest of a family of three, two sons and a daughter, who after the early death of the father were brought up with great care and devotion by their mother, the daughter of Sir David Falconer, president of the college of justice.

Of Hume's early education little is known beyond what he has himself stated in his *Life*. He appears to have entered the Greek classes of the university of Edinburgh in 1723, and, he tells us, "passed through the ordinary course of education with success." From a letter printed in *Burton's Life* (i. 30-39), it appears that about 1726 Hume returned to Ninewells with a fair knowledge of Latin, slight acquaintance with Greek and literary tastes decidedly inclining to "books of reasoning and philosophy, and to poetry and the polite authors." We do not know, except by inference, to what studies he especially devoted himself. It is, however, clear that from his earliest years he began to speculate upon the nature of knowledge in the abstract, and its concrete applications, as in theology, and that with this object he studied largely the writings of Cicero and Seneca and recent English philosophers (especially Locke, Berkeley and Butler). His acquaintance with Cicero is clearly proved by the form in which he cast some of the most important of his speculations. From his boyhood he devoted himself to acquiring a literary reputation, and throughout his life, in spite of financial and other difficulties, he adhered to his original intention. A man of placid and even phlegmatic temperament, he lived moderately in all things, and sought worldly prosperity only so far as was necessary to give him leisure for his literary work. At first he tried law, but was unable to give his mind to a study which appeared to him to be merely a barren waste of technical jargon. At this time the intensity of his intellectual activity in the area opened up to him by Locke and Berkeley reduced him to a state of physical exhaustion. In these circumstances he determined to try the effect of complete change of scene and occupation, and in 1734 entered a business house in Bristol. In a few months he found "the scene wholly unsuitable" to him, and about the middle of 1734 set out for France, resolved to spend some years in quiet study. He visited Paris, resided for a time at Rheims and then settled at La Flèche, famous in the history of philosophy as the school of Descartes. His health seems to have been perfectly restored, and during the three years of his stay in France his speculations were worked into systematic form in the *Treatise of Human Nature*. In the autumn of 1737 he was in London arranging for its publication and polishing it in preparation for the judgments of the learned. In January 1739 appeared the first and second volumes of the *Treatise of Human Nature, being an Attempt to Introduce the Experimental Method of Reasoning into Moral Subjects*, containing book i., *Of the Understanding*, and book ii., *Of the Passions*. The third volume, containing book iii., *Of Morals*, was published in the following year. The publisher of the first two volumes, John Noone, gave him £50 and twelve bound copies for a first edition of one thousand copies. Hume's own words best describe its reception. "Never literary attempt was more unfortunate; it fell dead-born from the press, without reaching such distinction as even to excite a murmur among the zealots." "But," he adds, "being naturally of a cheerful and sanguine temper, I very soon recovered the blow, and prosecuted with great ardour my studies in the country." This brief notice, however, is not sufficient to explain the full significance of the event for Hume's own life. The work undoubtedly failed to do what its author expected from it; even the notice, otherwise not unsatisfactory, which it obtained in the *History of the Works of the Learned*, then the principal critical journal, did not in the least appreciate the true bearing of the *Treatise* on current discussions. Hume naturally expected that the world would see as clearly as he did the connexion between the concrete problems agitating contemporary thought and the abstract principles on which their solution depended. Accordingly he looked for opposition, and expected that, if his principles were received, a change in general conceptions of things would ensue. His disappointment at its

reception was great; and though he never entirely relinquished his metaphysical speculations, though all that is of value in his later writings depends on the acute analysis of human nature to which he was from the first attracted, one cannot but regret that his high powers were henceforth withdrawn for the most part from the consideration of the foundations of belief, and expended on its practical applications. In later years he attributed his want of success to the immature style of his early exposition, to the rashness of a young innovator in an old and well-established province of literature. But this has little foundation beyond the irritation of an author at his own failure to attract such attention as he deems his due. None of the principles of the *Treatise* is given up in the later writings, and no addition is made to them. Nor can the superior polish of the more mature productions counterbalance the concentrated vigour of the more youthful work.

After the publication of the *Treatise* Hume retired to his brother's house at Ninewells and carried on his studies, mainly in the direction of politics and political economy. In 1741 he published the first volume of his *Essays*, which had a considerable and immediate success. A second edition was called for in the following year, in which also a second volume was published. These essays Butler, to whom he had sent a copy of his *Treatise*, but with whom he had failed to make personal acquaintance, warmly commended. The philosophical relation between Butler and Hume is curious. So far as analysis of knowledge is concerned they are in harmony, and Hume's sceptical conclusions regarding belief in matters of fact are the foundations on which Butler's defence of religion rests. Butler, however, retained, in spite of his destructive theory of knowledge, confidence in the rational proofs for the existence of God, and certainly maintains what may be vaguely described as an a priori view of conscience. Hume had the greatest respect for the author of the *Analogy*; ranks him with Locke and Berkeley as an originator of the experimental method in moral science, and in his specially theological essays, such as that on *Particular Providence and a Future State*, has Butler's views specifically in mind. (See BUTLER.)

The success of the *Essays*, though hardly great enough to satisfy his somewhat exorbitant cravings, was a great encouragement to him. He began to hope that his earlier work, if recast and lightened, might share the fortunes of its successor; and at intervals throughout the next four years he occupied himself in rewriting it in a more succinct form with all the literary grace at his command. Meantime he continued to look about for some post which might secure him the modest independence he desired. In 1744 we find him, in anticipation of a vacancy in the chair of moral philosophy at Edinburgh university, moving his friends to advance his cause with the electors; and though, as he tells us, "the accusation of heresy, deism, scepticism or theism, &c., &c., was started" against him, it had no effect, "being bore down by the contrary authority of all the good people in town." To his great mortification, however, he found out, as he thought, that Hutcheson and Leechman, with whom he had been on terms of friendly correspondence, were giving the weight of their opinion against his election. The after history of these negotiations is obscure. Failing in this attempt, he was induced to become tutor, or keeper, to the marquis of Annandale, a harmless literary lunatic. This position, financially advantageous, was absurdly false (see letters in *Burton's Life*, i. ch. v.), and when the matter ended Hume had to sue for arrears of salary.

In 1746 Hume accepted the office of secretary to General St Clair, and was a spectator of the ill-fated expedition to France in the autumn of that year. His admirable account of the transaction has been printed by Burton. After a brief sojourn at Ninewells, doubtless occupied in preparing for publication his *Philosophical Essays* (afterwards entitled *An Inquiry concerning Human Understanding*), Hume was again associated with General St Clair as secretary in the embassy to Vienna and Turin (1748). The notes of this journey are written in a light and amusing style, showing Hume's usual keenness of sight in some directions and his almost equal blindness in others.

During his absence from England, early in the year 1748, the *Philosophical Essays* were published; but the first reception of the work was little more favourable than that accorded to the *Treatise*. To the later editions of the work Hume prepared an "Advertisement" referring to the *Treatise*, and desiring that the *Essays* "may alone be regarded as containing his philosophical sentiments and principles." Some modern critics have accepted this disclaimer as of real value, but in fact it has no significance; and Hume himself in a striking letter to Gilbert Elliott indicated the true relation of the two works. "I believe the *Philosophical Essays* contain everything of consequence relating to the understanding which you would meet with in the *Treatise*, and I give you my advice against reading the latter. By shortening and simplifying the questions, I really render them much more complete. *Addo dumminuo*. The philosophical principles are the same in both." The *Essays* are undoubtedly written with more maturity and skill than the *Treatise*; they contain in more detail application of the principles to concrete problems, such as miracles, providence, immortality; but the entire omission of the discussion forming part ii, of the first book of the *Treatise*, and the great compression of part iv., are real defects which must always render the *Treatise* the more important work.

In 1749 Hume returned to Ninewells, enriched with "near a thousand pounds." In 1751 he removed to Edinburgh, where for the most part he resided during the next twelve years of his life. These years are the richest so far as literary production is concerned. In 1751 he published his *Political Discourses*, which had a great and well-deserved success both in England and abroad. It was translated into French by Mauvillon (1753) and by the Abbé le Blanc (1754). In the same year appeared the recast of the third book of the *Treatise*, called *Inquiry concerning the Principles of Morals*, of which he says that "of all his writings, philosophical, literary or historical, it is incomparably the best." At this time also we hear of the *Dialogues concerning Natural Religion*, a work which Hume was prevailed on not to publish, but which he revised with great care, and evidently regarded with the greatest favour. The work itself, left by Hume with instructions that it should be published, did not appear till 1779.

In 1751 Hume was again unsuccessful in the attempt to gain a professor's chair. In the following year he received, in spite of the usual accusations of heresy, the librarianship of the Advocates' Library in Edinburgh, small in emoluments (£40 a year) but rich in opportunity for literary work. In a playful letter to Dr Clephane, he describes his satisfaction at his appointment, and attributes it in some measure to the support of "the ladies."

In 1753 Hume was fairly settled in Edinburgh, preparing for his *History of England*. He had decided to begin the *History*, not with Henry VII., as Adam Smith recommended, but with James I., considering that the political differences of his time took their origin from that period. On the whole his attitude in respect to disputed political principles seems not to have been at first consciously unfair. As for the qualities necessary to secure success as a *writer* on history, he felt that he possessed them in a high degree; and, though neither his ideal of an historian nor his equipment for the task of historical research would now appear adequate, in both he was much in advance of his time. "But," he writes in the well-known passage of his *Life*, "miserable was my disappointment. I was assailed by one cry of reproach, disapprobation, and even detestation; . . . what was still more mortifying, the book seemed to sink into oblivion. Mr Millar told me that in a twelvemonth he sold only forty-five copies of it." This account must be accepted with reservations. It expresses Hume's feelings rather than the real facts. In Edinburgh, as we learn from one of his letters, the book succeeded well, no fewer than 450 copies being disposed of in five weeks. Nor is there anything in Hume's correspondence to show that the failure of the book was so complete as he declared. Within a very few years the sale of the *History* was sufficient to gain for the author a larger revenue than had ever

before been known in his country to flow from literature, and to place him in comparative affluence. He seems to have received £400 for the first edition of the first volume, £700 for the first edition of the second and £840 for the copyright of the two together. At the same time the bitterness of Hume's feelings and their effect are of importance in his life. It is from the publication of the *History* that we date his virulent hatred of everything English, towards society in London, Whig principles, Whig ministers and the public generally (see Burton's *Life*, ii. 268, 417, 434). He was convinced that there was a conspiracy to suppress and destroy everything Scottish.¹ The remainder of the *History* became little better than a party pamphlet. The second volume, published in 1756, carrying on the narrative to the Revolution, was better received than the first; but Hume then resolved to work backwards, and to show from a survey of the Tudor period that his Tory notions were grounded upon the history of the constitution. In 1759 this portion of the work appeared, and in 1761 the work was completed by the history of the pre-Tudor periods. The numerous editions of the various portions—for, despite Hume's wrath and grumbings, the book was a great literary success—gave him an opportunity of careful revision, which he employed to remove from it all the "villainous seditious Whig strokes," and "plaguy prejudices of Whiggism" that he could detect. In other words, he bent all his efforts toward making his *History* more of a party work than it had been, and in his effort he was entirely successful. The early portion of his *History* may be regarded as now of little or no value. The sources at Hume's command were few, and he did not use them all. None the less, the *History* has a distinct place in the literature of England. It was the first attempt at a comprehensive treatment of historic facts, the first to introduce the social and literary aspects of a nation's life as only second in importance to its political fortunes, and the first historical writing in an animated yet refined and polished style.²

While the *History* was in process of publication, Hume did not entirely neglect his other lines of activity. In 1757 appeared *Four Dissertations: The Natural History of Religion, Of the Passions, Of Tragedy, Of the Standard of Taste*. Of these the dissertation on the passions is a very subtle piece of psychology, containing the essence of the second book of the *Treatise*. It is remarkable that Hume does not appear to have been acquainted with Spinoza's analysis of the affections. The last two essays are contributions of no great importance to aesthetics, a department of philosophy in which Hume was not strong. The *Natural History of Religion* is a powerful contribution to the deistic controversy; but, as in the case of Hume's earlier work, its significance was at the time overlooked. It is an attempt to carry the war into a province hitherto allowed to remain at peace, the theory of the general development of religious ideas. Deists, though raising doubts regarding the historic narratives of the Christian faith, had never disputed the general fact that belief in one God was natural and primitive. Hume endeavours to show that polytheism was the earliest as well as the most natural form of religious belief, and that theism or deism is

¹ See Burton, ii. 265, 148 and 238. Perhaps our knowledge of Johnson's sentiments regarding the Scots in general, and of his expressions regarding Hume and Smith in particular, may lessen our surprise at this vehemence.

² Macaulay describes Hume's characteristic fault as an historian: "Hume is an accomplished advocate. Without positively asserting much more than he can prove, he gives prominence to all the circumstances which support his case; he glides lightly over those which are unfavourable to it; his own witnesses are applauded and encouraged; the statements which seem to throw discredit on them are controverted; the contradictions into which they fall are explained away; a clear and connected abstract of their evidence is given. Everything that is offered on the other side is scrutinized with the utmost severity; every suspicious circumstance is a ground for argument and invective; what cannot be denied is extenuated, or passed by without notice; concessions even are sometimes made; but this insidious candour only increases the effect of the vast mass of sophistry."—*Miscell. Writings*, "History." With this may be compared the more favourable verdict by J. S. Brewer, in the preface to his edition of the *Student's Hume*.

the product of reflection upon experience, thus reducing the validity of the historical argument to that of the theoretical proofs.

In 1763 he accompanied Lord Hertford to Paris, doing the duties of secretary to the embassy, with the prospect of the appointment to that post. He was everywhere received "with the most extraordinary honours." The society of Paris was peculiarly ready to receive a great philosopher and historian, especially if he were known to be an avowed antagonist of religion, and Hume made valuable friendships, especially with D'Alembert and Turgot, the latter of whom profited much by Hume's economical essays. In 1766 he left Paris and returned to Edinburgh. In 1767 he accepted the post of under-secretary to General Conway and spent two years in London.

He settled finally in Edinburgh in 1769, having now through his pension and otherwise an income of £1000 a year. The solitary incident of note in this period of his life is the ridiculous quarrel with Rousseau, which throws much light upon the character of the great sentimentalist. Hume certainly did his utmost to secure for Rousseau a comfortable retreat in England, but his usually sound judgment seems at first to have been quite at fault with regard to his protégé. The quarrel which all the acquaintances of the two philosophers had predicted soon came, and no language had expressions strong enough for Rousseau's anger. Hume came well out of the business, and had the sagacity to conclude that his admired friend was little better than a madman. In one of his most charming letters he describes his life in Edinburgh. The new house to which he alludes was built under his own directions at the corner of what is now called St David Street after him; it became the centre of the most cultivated society of Edinburgh. Hume's cheerful temper, his equanimity, his kindness to literary aspirants and to those whose views differed from his own won him universal respect and affection. He welcomed the work of his friends (e.g. Robertson and Adam Smith), and warmly recognized the worth of his opponents (e.g. George Campbell and Reid). He assisted Blackwell and Smollett in their difficulties and became the acknowledged patriarch of literature.

In the spring of 1775 Hume was struck with a tedious and harassing though not painful illness. A visit to Bath seemed at first to have produced good effects, but on the return journey more alarming symptoms developed themselves, his strength rapidly sank, and, little more than a month later, he died in Edinburgh on the 25th of August 1776.

No notice of Hume would be complete without the sketch of his character drawn by his own hand:—"To conclude historically with my own character, I am, or rather was (for that is the style I must now use in speaking of myself, which emboldens me the more to speak my sentiments),—I was, I say, a man of mild dispositions, of command of temper, of an open, social and cheerful humour, capable of attachment, but little susceptible of enmity, and of great moderation in all my passions. Even my love of literary fame, my ruling passion, never soured my temper, notwithstanding my frequent disappointments. My company was not unacceptable to the young and careless, as well as to the studious and literary; and as I took a particular pleasure in the company of modest women, I had no reason to be displeas'd with the reception I met with from them. In a word, though most men anywise eminent have found reason to complain of calumny, I never was touch'd, or even attacked, by her baleful tooth; and, though I wantonly expos'd myself to the rage of both civil and religious factions, they seem to be disarmed on my behalf of their wonted fury. My friends never had occasion to vindicate any one circumstance of my character and conduct; not but that the zealots, we may well suppose, would have been glad to invent and propagate any story to my disadvantage, but they could never find any which they thought would wear the face of probability. I cannot say there is no vanity in making this funeral oration of myself, but I hope it is not a misplaced one; and this is a matter of fact which is easily cleans'd and ascertained." The more his life has become known, the more confidence we place in this admirable estimate.

The results of Hume's speculations may be discussed under two heads:—(1) philosophical, (2) economical.

1. The philosophical writings, which mark a distinct epoch in the development of modern thought, can here be considered in two

only of the many aspects in which they present themselves as of the highest interest to the historian of philosophy. In the *Treatise of Human Nature*, which is in every respect the most complete exposition of Hume's philosophical conception, we

have the first thorough-going attempt to apply the fundamental principles of Locke's empirical psychology to the construction of a theory of knowledge, and, as a natural consequence, the first systematic criticism of the chief metaphysical notions from this point of view. Hume, in that work, holds the same relation to Locke and Berkeley as the late J. S. Mill held with his *System of Logic* to Hartley and James Mill. In certain of the later writings, pre-eminently in the *Dialogues on Natural Religion*, Hume brings the result of his speculative criticism to bear upon the problems of current theological discussion, and gives in their regard, as previously with respect to general philosophy, the final word of the empirical theory in its earlier form. The interesting parallel between Hume and J. S. Mill in this second feature will not be overlooked.

In the first instance, then, Hume's philosophical work is to be regarded as the attempt to supply for empiricism in psychology a consistent, that is, a logically developed theory of knowledge. In Locke, indeed, such theory is not wanting, but, of all the many inconsistencies in the *Essay on the Human Understanding*, none is more apparent or more significant than the complete want of harmony between the view of knowledge developed in the fourth book and the psychological principles laid down in the earlier part of the work. Though Locke, doubtless, drew no distinction between the problems of psychology and of theory of knowledge, yet the discussion of the various forms of cognition given in the fourth book of the *Essay* seems to be based on grounds quite distinct from and in many respects inconsistent with the fundamental psychological principle of his work. The perception of relations, which, according to him, is the essence of cognition, the demonstrative character which he thinks attaches to our inference of God's existence, the intuitive knowledge of self, are doctrines incapable of being brought into harmony with the view of mind and its development which is the keystone of his general theory. To some extent Berkeley removed this radical inconsistency, but in his philosophical work it may be said with safety there are two distinct aspects, and while it holds of Locke on the one hand, it stretches forward to Kantianism on the other. Nor in Berkeley are these divergent features ever united into one harmonious whole. It was left for Hume to approach the theory of knowledge with full consciousness from the psychological point of view, and to work out the final consequences of that view so far as cognition is concerned. The terms which he employs in describing the aim and scope of his work are not those which we should now employ, but the declaration, in the introduction to the *Treatise*, that the science of human nature must be treated according to the experimental method, is in fact equivalent to the statement of the principle implied in Locke's *Essay*, that the problems of psychology and of theory of knowledge are identical. This view is the characteristic of what we may call the English school of philosophy.

In order to make perfectly clear the full significance of the principle which Hume applied to the solution of the chief philosophical questions, it is necessary to render somewhat more precise and complete the statement of the psychological view of knowledge which lies at the foundation of the empirical theory, and to distinguish from it the problem of the theory of knowledge upon which it was brought to bear. Without entering into details, which it is the less necessary to do because the subject has been recently discussed with great fulness in works readily accessible, it may be said that for Locke as for Hume the problem of psychology was the exact description of the contents of the individual mind, and the determination of the conditions of the origin and development of conscious experience in the individual mind. And the answer to the problem which was furnished by Locke is in effect that with which Hume started. The conscious experience of the individual is the result of interaction between the individual mind and the universe of things. This solution presupposes a peculiar conception of the general relation between the mind and things which in itself requires justification, and which, so far at least as the empirical theory was developed by Locke and his successors, could not be obtained from psychological analysis. Either we have a right to the assumption contained in the conception of the individual mind as standing in relation to things, in which case the grounds of the assumption must be sought elsewhere than in the results of this reciprocal relation, or we have no right to the assumption, in which case reference to the reciprocal relation can hardly be accepted as yielding any solution of the psychological problem. But in any case,—and, as we shall see, Hume endeavours so to state his psychological premises as to conceal the assumption made openly by Locke,—it is apparent that this psychological solution does not contain the answer to the wider and radically distinct problem of the theory of knowledge. For here we have to consider how the individual intelligence comes to know any fact whatsoever, and what is meant by the cognition of a fact. With Locke, Hume professes to regard this problem as virtually covered or answered by the fundamental psychological theorem; but the superior clearness of his reply enables us to mark with perfect precision the nature of the difficulty inherent in the attempt to regard the two as identical. For purposes of psychological analysis the conscious experience of the individual mind is taken as given fact, to be known, i.e. observed, discriminated, classified and explained in the same way in which any one special portion of experience is treated. Now if this mode of treatment be accepted as the only possible method, and its results assumed to be conclusive as regards

Theory of knowledge.

the problem of knowledge, the fundamental peculiarity of cognition is overlooked. In all cognition, strictly so-called, there is involved a certain synthesis or relation of parts of a characteristic nature, and if we attempt to discuss this synthesis as though it were in itself but one of the facts forming the *matter* of knowledge, we are driven to regard this relation as being of the quite external kind discovered by observation among matters of knowledge. The difficulty of reconciling the two views is that which gives rise to much of the obscurity in Locke's treatment of the theory of knowledge; in Hume the effort to identify them, and to explain the synthesis which is essential to cognition as merely the accidental result of external relations among the elements of conscious experience, appears with the utmost clearness, and gives the keynote of all his philosophical work. The final perplexity, concealed by various forms of expression, comes forward at the close of the *Treatise* as absolutely unsolved, and leads Hume, as will be pointed out, to a truly remarkable confession of the weakness of his own system.

While, then, the general idea of a theory of knowledge as based upon psychological analysis is the groundwork of the *Treatise*, it is a particular consequence of this idea that furnishes to Hume the characteristic criterion applied by him to all philosophical questions. If the relations involved in the fact of cognition are only those discoverable by observation of any particular portion of known experience, then such relations are quite external and contingent. The only necessary relation which can be discovered in a given fact of experience is that of non-contradiction (*i.e.* purely formal); the thing must be what it is, and cannot be conceived as having qualities contradictory of its nature. The universal test, therefore, of any supposed philosophical principle is the possibility or impossibility of imagining its contradictory. All our knowledge is but the sum of our conscious experience, and is consequently material for imagination. "Let us fix our attention out of ourselves as much as possible; let us chase our imagination to the heavens or to the utmost limits of the universe; we never really advance a step beyond ourselves, nor can conceive any kind of existence, but those perceptions which have appeared in that narrow compass. This is the universe of the imagination, nor have we any idea but what is there produced." (*Works*, ed. of 1854, i. 93, cf. i. 107.)

The course of Hume's work follows immediately from his fundamental principle, and the several divisions of the treatise, so far as the theoretical portions are concerned, are but its logical consequences. The first part of the first book contains a brief statement of the contents of mind, a description of all that observation can discover in conscious experience. The second part deals with those judgments which rest upon the formal elements of experience, space and time. The third part discusses the principle of real connexion among the elements of experience, the relation of cause and effect. The fourth part is virtually a consideration of the ultimate significance of this conscious experience, of the place it is supposed to occupy in the universe of existence, in other words, of the relations between the conscious experience of an individual mind as disclosed to observation and the supposed realities of self and external things.

In the first part Hume gives his own statement of the psychological foundations of his theory. Viewing the contents of mind as a matter of experience, he can discover among them only one distinction, a distinction expressed by the terms *impressions* and *ideas*. Ideas are secondary in nature, copies of data supplied we know not whence. All that appears in conscious experience as primary, as arising from some unknown cause, and therefore relatively as original, Hume designates by the term *impressions*, and claims to imply by such term no theory whatsoever as to the origin of this portion of experience. There is simply the fact of conscious experience, ultimate and inexplicable. Moreover, if we remain faithful to the fundamental conception that the contents of the mind are merely matters of experience, it is evident in the first place that as impressions are strictly individual, ideas also must be strictly particular, and in the second place that the faculties of combining, discriminating, abstracting and judging, which Locke had admitted, are merely expressions for particular modes of having mental experience, *i.e.* are modifications of *conceiving* (cf. i. 128 n. 137, 192). By this theory, Hume is freed from all the problems of abstraction and judgment. A comparative judgment is simplified into an isolated perception of a peculiar form, and a series of similar facts are grouped under a single symbol, representing a particular perception, and only by the accident of custom treated as universal (see i. 37, 38, 100).

Such, in substance, is Hume's restatement of Locke's empirical view. Conscious experience consists of isolated states, each of which is to be regarded as a fact and is related to others in a quite external fashion. It remains to be seen how knowledge can be explained on such a basis; but, before proceeding to sketch Hume's answer to this question, it is necessary to draw attention, first, to the peculiar device invariably resorted to by him when any exception to his general principle that ideas are secondary copies of impressions presents itself, and, secondly, to the nature of the substitute offered by him for that perception of relations or synthesis which even in Locke's confused statement had appeared as the essence of cognition. Whenever Hume finds it impossible to recognize in an idea the mere copy of a particular impression, he introduces the phrase, "manner of conceiving." This general or abstract ideas are merely copies of a

particular impression conceived in a particular manner. The ideas of space and time, as will presently be pointed out, are classes of impressions conceived in a particular manner. The idea of necessary connexion is merely the reproduction of an impression which the mind *feels* itself compelled to conceive in a particular manner. Such a fashion of disguising difficulties points, not only to an inconsistency in Hume's theory as stated by himself, but to the error upon which it proceeds; for these perplexities are but the consequences of the doctrine that cognition is to be explained on the basis of particular perceptions. These external relations are, in fact, what Hume describes as the natural bonds of connexion among ideas, and, regarded subjectively as principles of association among the facts of mental experience, they form the substitute he offers for the synthesis implied in knowledge. These principles of association determine the imagination to combine ideas in various modes, and by this mechanical combination Hume, for a time, endeavours to explain what are otherwise called judgments of relation. It is impossible, however, for him to carry out this view consistently. The only combination which, even in appearance, could be explained satisfactorily by its means was the formation of a complex idea out of simpler parts, but the idea of a relation among facts is not accurately described as a complex idea; and, as such relations have no basis in impressions, Hume is finally driven to a confession of the absolute impossibility of explaining them. Such confession, however, is only reached after a vigorous effort had been made to render some account of knowledge by the experimental method.

The psychological conception, then, on the basis of which Hume proceeds to discuss the theory of knowledge, is that of conscious experience as containing merely the succession of isolated impressions and their fainter copies, ideas, and as bound together by merely natural or external links of connexion. The principles of association among ideas. The foundations of cognition must be discovered by observation or analysis of experience so conceived. Hume wavers somewhat in his division of the various kinds of cognition, laying stress now upon one now upon another of the points in which mainly they differ from one another. Nor is it of the first importance, save with the view of creating by own consistency, that we should adopt any of the divisions implied in his exposition. For practical purposes we may regard the most important discussions in the *Treatise* as falling under two heads. In the first place there are certain principles of cognition which appear to rest upon and to express relations of the universal elements in conscious experience, *viz.* space and time. The propositions of mathematics seem to be independent of this or that special fact of experience, and to remain unchanged even when the concrete matter of experience varies. They are formal. In the second place, cognition, in any real sense of that term, implies connexion for the individual mind between the present fact of experience and other facts, whether past or future. It appears to involve, therefore, some real relation among the portions of experience, on the basis of which relation judgments and inferences as to matters of fact can be shown to rest. The theoretical question is consequently that of the nature of the supposed relation, and of the certainty of judgments and inferences resting on it.

Hume's well-known distinction between relations of ideas and matters of fact corresponds fairly to this separation of the formal and real problems in the theory of cognition, although that distinction is in itself inadequate and not fully representative of Hume's own conclusions.

With regard, then, to the first problem, the formal element in knowledge, Hume has to consider several questions, distinct in nature and hardly discriminated by him with sufficient precision. For a complete treatment of this portion of the theory of knowledge, there require to be taken into consideration at least the following points: (a) the exact nature and significance of the space and time relations in our experience, (b) the mode in which the primary data, facts or principles, of mathematical cognition are obtained, (c) the nature, extent and certainty of such data, in themselves and with reference to the concrete material of experience, (d) the principle of inference from the data, however obtained. Not all of these points are discussed by Hume with the same fullness, and with regard to some of them it is difficult to state his conclusions. It will be of service, however, to attempt a summary of his treatment under these several heads,—the more so as almost all expositions of his philosophy are entirely defective in the account given of this essential portion. The brief statement in the *Inquiry*, § iv., is of no value, and indeed is almost unintelligible unless taken in reference to the full discussion contained in part II. of the *Treatise*.

(a) The nature of space and time as elements in conscious experience is considered by Hume in relation to a special problem, that of their supposed infinite divisibility. Evidently upon his view of conscious experience, of the world of imagination, such infinite divisibility must be a fiction. The ultimate elements of experience must be real units, capable of being represented or imagined in isolation. Whence then do these units arise? or, if we put the problem as it was necessary Hume should put it to himself, in what orders or classes of impressions do we find the elements of space and time? Beyond all question Hume, in endeavouring to answer this problem, is brought face to face with one of the difficulties inherent in his conception of conscious experience.

For he has to give some explanation of the nature of space and time which shall identify these with impressions, and at the same time is compelled to recognize the fact that they are not identical with any single impression or set of impressions. Putting aside, then, the various obscurities of terminology, such as the distinction between the objects known, viz. "points" or several mental states, and the impressions themselves, which disguise the full significance of his conclusion, we find Hume reduced to the following as his theory of space and time. Certain impressions, the sensations of sight and touch, have in themselves the element of space, for these impressions (Hume skillfully transfers his statement to the *points*) have a certain order or mode of arrangement. This mode of arrangement or manner of disposition is common to coloured points and tangible points, and, considered separately, is the impression from which our idea of space is taken. All impressions and all ideas are received, or form parts of a mental experience only when received, in a certain order, the order of succession. This manner of presenting themselves is the impression from which the idea of time takes its rise.

It is almost superfluous to remark, first, that Hume here deliberately gives up his fundamental principle that ideas are but the fainter copies of impressions, for it can never be maintained that order of disposition is an impression, and, secondly, that he fails to offer any explanation of the mode in which *coexistence and succession* are possible elements of cognition in a conscious experience made up of isolated presentations and representations. For the consistency of his theory, however, it was indispensable that he should insist upon the real, i.e. presentative character of the ultimate units of space and time.

(b) How then are the primary data of mathematical cognition to be derived from an experience containing space and time relations in the manner just stated? It is important to notice that *Mathematics*. Hume, in regard to this problem, distinctly separates geometry from algebra and arithmetic, i.e. he views extensive quantity as being cognized differently from number. With regard to geometry, he holds emphatically that it is an empirical doctrine, a science founded on observation of concrete facts. The rough appearances of physical facts, their outlines, surfaces and so on, are the data of observation, and only by a method of approximation do we gradually come near to such propositions as are laid down in pure geometry. He definitely repudiates a view often ascribed to him, and certainly advanced by many later empiricists, that the data of geometry are hypothetical. The ideas of perfect lines, figures and surfaces have not, according to him, any existence. (See *Works*, i. 66, 69, 73, 97 and iv. 180.) It is impossible to give any consistent account of his doctrine regarding number. He holds, apparently, that the foundation of all the science of number is the fact that each element of conscious experience is presented as a unit, and adds that we are capable of considering any fact or collection of facts as a unit. This *manner of conceiving* is absolutely general and distinct, and accordingly affords the possibility of an all-comprehensive and perfect science, the science of discrete quantity. (See *Works*, i. 97.)

(c) In respect to the third point, the nature, extent and certainty of the elementary propositions of mathematical science, Hume's utterances are far from clear. The principle with which he starts and from which follows his well-known distinction between relations of ideas and matters of fact, a distinction which Kant appears to have thought identical with his distinction between analytical and synthetic judgments, is comparatively simple. The *ideas* of the quantitative aspects of phenomena are exact representations of these aspects or quantitative impressions; consequently, whatever is found true by consideration of the ideas may be asserted regarding the real impressions. No question arises regarding the *existence* of the fact represented by the idea, and in so far, at least, mathematical judgments may be described as hypothetical. For they simply assert what will be found true in any conscious experience containing coexisting impressions of sense (specifically, of sight and touch), and in its nature successive. That the propositions are hypothetical in this fashion does not imply any distinction between the abstract truth of the ideal judgments and the imperfect correspondence of concrete material with these abstract relations. Such distinction is quite foreign to Hume, and can only be ascribed to him from an entire misconception of his view regarding the ideas of space and time. (For an example of such misconception, which is almost universal, see Riehl, *Der philosophische Kriticismus*, i. 96, 97.)

(d) From this point onwards Hume's treatment becomes exceedingly confused. The identical relation between the ideas of space and time and the impressions corresponding to them apparently leads him to regard judgments of continuous and discrete quantity as standing on the same footing, while the ideal character of the data gives a certain colour to his inexact statements regarding the extent and truth of the judgments founded on them. The emphatic utterances in the *Inquiry* (iv. 30, 186), and even at the beginning of the relative section in the *Treatise* (i. 95) may be cited in illustration. But in both works these utterances are qualified in such a manner as to enable us to perceive the real bearings of his doctrine, and to pronounce at once that it differs widely from that commonly ascribed to him. "It is from the idea of a triangle that we discover the relation of equality which its three angles bear to two right ones; and this relation is invariable, so long as our idea remains the same"

(i. 95). If taken in isolation this passage might appear sufficient justification for Kant's view that, according to Hume, geometrical judgments are analytical and therefore perfect. But it is to be recollected that, according to Hume, an idea is actually a *representation* or individual picture, not a notion or even a *schema*, and that he never claims to be able to extract the predicate of a geometrical judgment by analysis of the subject. The properties of this individual subject, the idea of the triangle, are, according to him, discovered by observation, and an observation, whether actual or ideal, never presents us with more than the rough or general appearances of geometrical quantities, the relations so discovered have only approximate exactness. "Ask a mathematician what he means when he pronounces two quantities to be equal, and he must say that the idea of equality is one of those which cannot be defined, and that it is sufficient to place two equal quantities before any one in order to suggest it. Now this is an appeal to the general appearances of objects to the imagination or senses" (iv. 180). "Though it (i.e. geometry) much excels, both in universality and exactness, the loose judgments of the senses and imagination, yet [it] never attains a perfect precision and exactness" (i. 97). Any exactitude attaching to the conclusions of geometrical reasoning arises from the comparative simplicity of the data for the primary judgments.

So far, then, as geometry is concerned, Hume's opinion is perfectly definite. It is an experimental or observational science, founded on primary or immediate judgments (in his phraseology, *perceptions*), of relation between facts of intuition; its conclusions are hypothetical only in so far as they do not imply the existence at the moment of corresponding real experience; and its propositions have no exact truth. With respect to arithmetic and algebra, the science of numbers, he expresses an equally definite opinion, but unfortunately it is quite impossible to state in any satisfactory fashion the grounds for it or even its full bearing. He nowhere explains the origin of the notions of unity and number, but merely asserts that through their means we can have absolutely exact arithmetical propositions (*Works*, i. 97, 98). Upon the nature of the reasoning by which in mathematical science we pass from data to conclusions, Hume gives no explicit statement. If we were to say that on his view the essential step must be the establishment of identities or equivalences, we should probably be doing justice to his doctrine of numerical reasoning, but should have some difficulty in showing the application of the method to geometrical reasoning. For in the latter case we possess, according to Hume, no standard of equivalence other than that supplied by immediate observation, and consequently transition from one premise to another by way of reasoning must be, in geometrical matters, a purely verbal process.

Hume's theory of mathematics—the only one, perhaps, which is compatible with his fundamental principle of psychology—is a practical condemnation of his empirical theory of perception. He has not offered even a plausible explanation of the mode by which a consciousness made up of isolated momentary impressions and ideas can be aware of coexistence and number, or succession. The relations of ideas are accepted as facts of immediate observation, as being themselves perceptions or individual elements of conscious experience, and to all appearance they are regarded by Hume as being in a sense analytical, because the form criterion of identity is applicable to them. It is applicable, however, not because the predicate is contained in the subject, but on the principle of contradiction. If these judgments are admitted to be facts of immediate perception, the supposition of their non-existence is impossible. The ambiguity in his criterion, however, seems entirely to have escaped Hume's attention.

A somewhat detailed consideration of Hume's doctrine with regard to mathematical science has been given for the reason that this portion of his theory has been very generally overlooked or misinterpreted. It does not seem necessary to endeavour to follow his minute examination of the principle of real cognition with the same fulness. It will probably be sufficient to indicate the problem as conceived by Hume, and the relation of the method he adopts for solving it to the fundamental doctrine of his theory of knowledge.

Real cognition, as Hume points out, implies transition from the present impression or feeling to something connected with it. As this thing can only be an impression or perception, and is not itself present, it is represented by its copy or idea. Now the supreme, all-comprehensive link of connexion between present feeling or impression and either past or future experience is that of causation. The idea in question is, therefore, the idea of something connected with the present impression as its cause or effect. But this is explicitly the idea of the said thing as having had or as about to have existence,—in other words, belief in the existence of some matter of fact. What, for a conscious experience so constituted as Hume will admit, is the precise significance of such belief in real existence?

Clearly the real existence of a fact is not demonstrable. For whatever is may be conceived not to be. "No negation of a fact can involve a contradiction." Existence of any fact, not present as a perception, can only be proved by arguments from cause or effect. But as each perception is in consciousness only as a contingent fact, which might not be or might be other than it is, we must admit that the mind can conceive no necessary relations or connexions among the several portions of its experience.

Real cognition and causation.

If, therefore, a present perception leads us to assert the existence of some other, this can only be interpreted as meaning that in some natural, i.e. psychological, manner the idea of this other perception is excited, and that the idea is viewed by the mind in some peculiar fashion. The natural link of connexion Hume finds in the similarities presented by experience. One fact or perception is discovered by experience to be uniformly or generally accompanied by another, and its occurrence therefore naturally excites the idea of that other. But when an idea is so roused up by a present impression, and when this idea, being a consequence of memory, has in itself a certain vivacity or liveliness, we regard it with a peculiar indefinable feeling, and in this feeling consists the immense difference between mere imagination and belief. The mind is led easily and rapidly from the present impression to the ideas of impressions found by experience to be the usual accompaniments of the present fact. The ease and rapidity of the mental transition is the sole ground for the supposed necessity of the causal connexion between portions of experience. The idea of necessity is not intuitively obvious; the ideas of cause and effect are correlative in our minds, but only as a result of experience. Hobbes and Locke were wrong in saying that the mind must find in the relation the idea of Power. We mistake the subjective transition resting upon custom or past experience for an objective connexion independent of special feelings. All reasoning about matters of fact is therefore a species of feeling, and belongs to the sensitive rather than to the cognitive side of our nature. It should be noted that this theory of Causation entirely denies the doctrine of Uniformity in Nature, so far as the human mind is concerned. All alleged uniformity is reduced to observed similarity of process. The idea is a mere convention, product of inaccurate thinking and custom.

While it is evident that some such conclusion must follow from the attempt to regard the cognitive consciousness as made up of disconnected feelings, it is equally clear, not only that the result is self-contradictory, but that it involves certain assumptions not in any way deducible from the fundamental view with which Hume starts. For in the problem of real cognition he is brought face to face with the characteristic feature of knowledge, distinction of self from matters known, and reference of transitory states to permanent objects or relations. Deferring his criticism of the significance of self and object, Hume yet makes use of both to aid his explanation of the belief attaching to reality. The reference of an idea to past experience has no meaning, unless we assume an identity in the object referred to. For a past impression is purely transitory, and, as Hume occasionally points out, can have no connexion of fact with the present consciousness. His exposition has thus a certain plausibility, which would not belong to it had the final view of the permanent object been already given.

The final problem of Hume's theory of knowledge, the discussion of the real significance of the two factors of cognition, self and external things, is handled in the *Treatise* with great fulness and dialectical subtlety.

As in the case of the previous problem, it is unnecessary to follow the steps of his analysis, which are, for the most part, attempts to substitute qualities of feeling for the relations of thought. The self in cognition, which appear to be involved. The results follow with the utmost ease from his original postulate. If there is nothing in conscious experience save what observation can disclose, while each act of observation is itself an isolated feeling (an impression or idea), it is manifest that a permanent identical thing can never be an object of experience. Whatever permanence or identity is ascribed to an impression or idea is the result of association, is one of those "propensities to feign" which are due to natural connexions among ideas. We regard as successive presentations of one thing the resembling feelings which are experienced in succession. Identity, then, whether of self or object, there is none, and the supposition of objects, distinct from impressions, is but a further consequence of our "propensity to feign." Hume's explanation of the belief in external things by reference to association is well deserving of careful study and of comparison with the more recent analysis of the same problem by J. S. Mill.

The weak points in Hume's empiricism are so admirably realized by the author himself that it is only fair to quote his own summary in the *Appendix to the Treatise*. He confesses that, in confining all cognition to single perceptions and supplying no purely intellectual faculty for modifying, recording and classifying their results, he has destroyed real knowledge altogether:

"If perceptions are distinct existences, they form a whole only by being connected together. But no connexions among distinct existences are ever discoverable by human understanding. We only feel a connexion or determination of the thought to pass from one object to another. It follows, therefore, that the thought alone feels personal identity, when, reflecting on the train of past perceptions that compose a mind, the ideas of them are felt to be connected together and naturally introduce each other.

However extraordinary this conclusion may seem, it need not surprise us. Modern philosophers seem inclined to think that personal identity arises from consciousness, and consciousness is nothing but a reflected thought or perception. The present philosophy, therefore, has a promising aspect. But all my hopes vanish

when I come to explain the principles that unite our successive perceptions in our thought or consciousness. I cannot discover any theory which gives me satisfaction on this head. . . .

"In short, there are two principles which I cannot render consistent, nor is it in my power to renounce either of them; viz. that all our distinct perceptions are distinct existences, and that the mind never perceives any real connexion among distinct existences. Did our perceptions either inhere in something simple or individual, or did the mind perceive some real connexion among them, there would be no difficulty in the case" (ii. 551).

The closing sentences of this passage may be regarded as pointing to the very essence of the Kantian attempt at solution of the problem of knowledge. Hume sees distinctly that if conscious experience be taken as containing only isolated states, no progress in explanation of cognition is possible, and that the only hope of further development is to be looked for in a radical change in our mode of conceiving experience. The work of the critical philosophy is the introduction of this new mode of regarding experience, a mode which, in the technical language of philosophers, has received the title of *transcendental* as opposed to the psychological method followed by Locke and Hume. It is because Kant alone perceived the full significance of the change required in order to meet the difficulties of the empirical theory that we regard his system as the only sequel to that of Hume. The writers of the Scottish school, Reid in particular, did undoubtedly indicate some of the weaknesses in Hume's fundamental conception, and their attempts to show that the isolated feeling cannot be taken as the ultimate and primary unit of cognitive experience are efforts in the right direction. But the question of knowledge was never generalized by them, and their reply to Hume, therefore, remains partial and inadequate, while its effect is weakened by the uncritical assumption of principles which is a characteristic feature of their writings.

The results of Hume's theoretical analysis are applied by him to the problems of practical philosophy and religion. For the first of these the reader is referred to the article *ETHICS*, where Hume's views are placed in relation to those of his predecessors in the same field of inquiry. His position, as regards the second, is very noteworthy. As before said, his metaphysic contains in abstracto the principles which were at that time being employed, uncritically, alike by the deists and by their antagonists. There can be no doubt that Hume has continually in mind the theological questions then current, and that he was fully aware of the mode in which his analysis of knowledge might be applied to them. A few of the less important of his criticisms, such as the argument on miracles, became then and have since remained public property and matter of general discussion. But the full significance of his work on the theological side was not at the time perceived, and justice has barely been done to the admirable manner in which he reduced the theological disputes of the century to their ultimate elements. The importance of the *Dialogues on Natural Religion*, as a contribution to the criticism of theological ideas and methods, can hardly be over-estimated. A brief survey of its contents will be sufficient to show its general nature and its relations to such works as Clarke's *Demonstration* and Butler's *Analogy*. The *Dialogues* introduce three interlocutors, Demea, Cleanthes and Philo, who represent three distinct orders of theological opinion. The first is the type of a certain a priori view, then regarded as the safest bulwark against infidelity, of which the main tenets were that the being of God was capable of a priori proof, and that, owing to the finitude of our faculties, the attributes and modes of operation of deity were absolutely incomprehensible. The second is the typical deist of Locke's school, improved as regards his philosophy, and holding that the only possible proof of God's existence was a posteriori, from design, and that such proof was, on the whole, sufficient. The third is the type of completed empiricism or scepticism, holding that no argument, either from reason or experience, can transcend experience, and consequently that no proof of God's existence is at all possible. The views of the first and second are played off against one another, and criticized by the third with great literary skill and effect. Cleanthes, who maintains that the doctrine of the incomprehensibility of God is hardly distinguishable from atheism, is compelled by the arguments of Philo to reduce to a minimum the conclusion capable of being inferred from experience as regards the existence of God. For Philo lays stress upon the weakness of the analogical argument, points out that the demand for an ultimate cause is no more satisfied by thought than by nature itself, shows that the argument from design cannot warrant the inference of a perfect or infinite even of a single deity, and finally, carrying out his principles to the full extent, maintains that, as we have no experience of the origin of the world, no argument from experience can carry us to its origin, and that the apparent marks of design in the structure of animals are only results from the conditions of their actual existence. So far as argument from nature is concerned, a total suspension of judgment is our only reasonable resource. Nor does the a priori argument in any of its forms fare better, for reason can never demonstrate a matter of fact, and, unless we know that the world had a beginning in time, we cannot insist that it must have had a cause. Demea, who is willing to give up his abstract proof, brings forward the ordinary theological topic, man's consciousness of his own imperfection, misery and dependent condition. Nature is throughout

corrupt and polluted, but "the present evil phenomena are rectified in other regions and in some future period of existence." Such a view satisfies neither of his interlocutors. Cleanthes, pointing out that from a nature thoroughly evil we can never prove the existence of an infinitely powerful and benevolent Creator, hazards the conjecture that the deity, though all-benevolent, is not all-powerful. Philo, however, pushing his principles to their full consequences, shows that unless we assumed (or knew) beforehand that the system of nature was the work of a benevolent but limited deity, we certainly could not, from the facts of nature, infer the benevolence of its creator. Cleanthes's view is, therefore, an hypothesis, and in no sense an inference.

The *Dialogues* ought here to conclude. There is, however, appended one of those perplexing statements of personal opinion (for Hume declares Cleanthes to be his mouthpiece) not uncommon among writers of this period. Cleanthes and Philo come to an agreement, in admitting a certain illogical force in the a posteriori argument, or, at least, in expressing a conviction as to God's existence, which may not perhaps be altogether devoid of foundation. The precise value of such a declaration must be matter of conjecture. Probably the true statement of Hume's attitude regarding the problem is the somewhat melancholy utterance with which the *Dialogues* close.

It is apparent, even from the brief summary just given, that the importance of Hume in the history of philosophy consists in the vigour and logical exactness with which he develops a particular metaphysical view. Inconsistencies, no doubt, are to be detected in his system, but they arise from the limitations of the view itself, and not, as in the case of Locke and Berkeley, from imperfect grasp of the principle, and endeavour to unite with it others radically incompatible. In Hume's theory of knowledge we have the final expression of what may be called psychological individualism or atomism, while his ethics and doctrine of religion are but the logical consequences of this theory. So far as metaphysics is concerned, Hume has given the final word of the empirical school, and all additions, whether from the specifically psychological side or from the general history of human culture, are subordinate in character, and affect in no way the nature of his results. It is no exaggeration to say that the later English school of philosophy represented by J. S. Mill made in theory no advance beyond Hume. In the *Logic* of Mill, e.g., we find much of a special character that has no counterpart in Hume, much that is introduced *ad extra*, from general considerations of scientific procedure, but, so far as the groundwork is concerned, the *System of Logic* is a mere reproduction of Hume's doctrine of knowledge. It is impossible for any reader of Mill's remarkable posthumous essay on theism to avoid the reflection that in substance the treatment is identical with that of the *Dialogues on Natural Religion*, while on the whole the superiority in critical force must be assigned to the earlier work.

2. Hume's eminence in the fields of philosophy and history must not be allowed to obscure his importance as a political economist. *Economics.* Berkeley had already, in the *Querist*, attacked the mercantile theory of the nature of national wealth and the functions of money, and Locke had, in a partial manner, shown that political economy could with advantage be viewed in relation to the modern system of critical philosophy. But Hume was the first to apply to economics the scientific methods of his philosophy. His services to economics may be summed up in two heads: (1) he established the relation between economic facts and the fundamental phenomena of social life, and (2) he introduced into the study of these facts the new historical method. Thus, though he gave no special name to it, he yet describes the subject-matter, and indicates the true method, of economic science. His economic essays were published in the volumes entitled *Political Discourses* (1752) and *Essays and Treatises on Several Subjects* (1753); the most important are those on Commerce, on Money, on Interest and on the Balance of Trade, but, notwithstanding the disconnected form of the essays in general, the other less important essays combine to make a complete economic system. We have said that Berkeley and Locke had already begun the general work for which Hume is most important; in details also Hume had been anticipated to some extent. Nicholas Barbon and Sir Dudley North had already attacked the mercantile theory as to the precious metals and the balance of trade; Joseph Massie and Barbon had anticipated his theory of interest. Yet when we compare Hume with Adam Smith, the advance which Hume had made as his predecessors in lucidity of exposition and subtlety of intellect becomes clear, and modern criticism is agreed that the main errors of Adam Smith are to be found in those deductions which deviate from the results of the *Political Discourses*. A very few examples must suffice to illustrate his services to economics.

In dealing with money, he refutes the Mercantile School, which had tended to confound it with wealth. "Money," said Hume, "is *Money*, none of the wheels of trade; it is the oil which renders the motion of the wheels more smooth and easy." "Money and commodities are the real strength of any community." From the internal, as distinct from the international, aspect, the absolute quantity of money, supposed as of fixed amount, in a country, is of no consequence, while a quantity larger than is required for the interchange of commodities is injurious, as tending to raise prices and to drive foreigners from the home markets. It is only during

the period of acquisition of money, and before the rise in prices, that the accumulation of precious metals is advantageous. This principle is perhaps Hume's most important economic discovery (cf. F. A. Walker's *Money in its Relations to Trade and Industry*, London, 1880, p. 84 sqq.). He goes on to show that the variations of prices are due solely to money and commodities in circulation. Further, it is a misconception to regard as injurious the passage of money into foreign countries. "A government," he says, "has great reason to preserve with care its people and its manufactures; its money it may safely trust to the course of human affairs without fear or jealousy." Dealing with the phenomena of interest, he exposes the old fallacy that the rate depends upon the amount of money

in a country; low interest does not follow on abundance of money. The reduction in the rate of interest must, in general, result from "the increase of industry and frugality, of arts and commerce." In connexion with this he emphasizes a too generally neglected factor in economic phenomena, "the constant and insatiable desire of the mind for exercise and employment." "Interest," he says in general, "is the barometer of the state, and its lowness an almost infallible sign of prosperity," arising, as it does, from increased trade, frugality in the merchant class, and the consequent rise of new leaders: low interest and low profits mutually forward each other. In the matter of free trade and protection he compromises. He says on the one hand, "not only as a man, but as a British subject

I pray for the flourishing commerce of Germany, Spain, Italy and even France itself," and condemns "the numerous bars, obstructions and imposts which all nations of Europe, and none more than England, have put upon trade." On the other hand, he approves of a protective tax on German linen in favour of home manufactures, and of a tax on brandy as encouraging the sale of rum, and so supporting our southern colonies. Indeed it has been fairly observed that Hume retains an attitude of refined mercantilism. With regard to taxation he takes very definite views. The best taxes, he says, are those levied on consumption, especially on luxuries, for these are least heavily felt. He denies that all taxes fall finally on the land. Superior frugality and industry on the part of the artisan will enable him to pay taxes without mechanically raising the price of labour.

Here, as in other points, he differs entirely from the physiocrats, and his criticism of contemporary French views are, as a whole, in accordance with received modern opinion. For the modern expedient of raising money for national emergencies by way of loan he has a profound distrust. He was convinced that what is bad for the individual credit must be bad for the state also. A national debt, he maintains, enriches the capital at the expense of the provinces; further, it creates a leisured class of stockholders, and possesses all the disadvantages of paper credit. "Either the nation must destroy public credit, or public credit will destroy the nation." To sum up, it may be said that Hume enunciated the principle that "everything in the world is purchased by labour, and our passions are the only causes of labour"; and further, that, in analysing the complex phenomena of commerce, he is superior sometimes to Adam Smith in that he never forgets that the ultimate causes of economic change are the "customs and manners" of the people, and that the solution of problems is to be sought in the elementary factors of industry.

BIBLIOGRAPHY.—1. Life.—J. H. Burton's *Life and Correspondence of David Hume* (2 vols., 1846); Dr G. Birkbeck Hill, *Letters of Hume to William Strahan*; C. J. W. Franke, *David Hume* (Haarlem, 1907). 2. Works.—Until 1874 the standard edition was that of 1826 (reprinted 1854), in 4 vols. The best modern edition is that in 4 vols. by T. H. Green and T. H. Grose (containing a valuable introduction and excellent bibliographical matter); the *Enquiry* and the *Treatise* (1894 and 1896, Oxford), edited by L. A. Selby-Bigge.

3. Philosophic (the more important only can be quoted).—Huxley's *Hume* (a popular reproduction of Hume's views in "English Men of Letters" series); Sir L. Stephen's *English Thought in the XVIIIth Century* (1876, especially ch. vi.); J. Orr, *David Hume and his Influence on Philosophy and Theology* (1903, especially ch. ix. on "Moral Theory of Hume"); H. Calderwood, *David Hume* (1898, especially ch. vii. on Hume's attitude to religion); A. Seth, *Scottish and German Answers to Hume*; F. Jodl, *Leben und Philosophie d. Humes* (1872); E. Pfeleiderer, *Empirismus und Skepsis in D. Humes Philosophie* (1874); G. Spicker, *Kant, Hume und Berkeley* (1875); G. Compayré, *La Philosophie de D. Hume* (1873); A. Meinong, *Hume-Studien* (1877, especially Hume's nominalism); G. von Gizycki (a thorough exposition of Hume's utilitarianism), *Die Ethik D. Humes* (1878); G. Lechartier, *D. Hume, moraliste et sociologue* (1900); M. Klemme, *Die volkswirtschaftlichen Anschauungen D. Humes* (1900); E. Marcus, *Kants Revolutionsprinzip. Eine exakte Lösung des Kant-Humeschen Erkenntnisproblems* (1902); C. Hedvall, *Humes Erkenntnistheorie* (1906); R. Hönigswald, *Über die Lehre Humes von der Realität der Aussendungen* (1904); O. Quast, *Der Begriff des Belief bei David Hume* (1903). Hume's relation to the society of his time is described in the Rev. H. G. Graham's *Social Life in Scotland and Scottish Men of Letters*; "Jupiter" in Carlyle's *Autobiography*. J. MacCosh published a short pamphlet (1884) containing interesting but perhaps not conclusive arguments on the *Apostolicism of Hume and Huxley*. 4. Economic.—J. Bonar, *Philosophy and Political Economy* (London, 1893), chapter on Hume; notes to W. G. F. Roscher's

Principles of Political Economy (J. Lalor's trans. of 13th ed., New York, 1878); F. A. Walker's *Money* (New York, 1877) gives an account of Hume's views on interest and money; H. H. Gibbs (Lord Aldenham), *Colloquy on the Currency*; for Hume's relation to Adam Smith, John Rae's *Life of Adam Smith* (London, 1895). See also M. Teissiere, *Les Essais économiques de David Hume* (1902; a critical study); A. Schatz, *L'Œuvre économique de David Hume* (1902). (R. Ad.; J. M. M.)

HUME, JOSEPH (1777-1855), British politician, was born on the 22nd of January 1777, of humble parents, at Montrose, Scotland. After completing his course of medical study at the university of Edinburgh he sailed in 1797 for India, where he was attached as surgeon to a regiment; and his knowledge of the native tongues and his capacity for business threw open to him the lucrative offices of interpreter and commissary-general. In 1802, on the eve of Lord Lake's Mahratta war, his chemical knowledge enabled him to render a signal service to the administration by making available a large quantity of gunpowder which damp had spoiled. In 1808, on the restoration of peace, he resigned all his civil appointments, and returned home in the possession of a fortune of £40,000. Between 1808 and 1811 he travelled much both in England and the south of Europe, and in 1812 published a blank verse translation of the *Inferno*. In 1812 he purchased a seat in parliament for Weymouth and voted as a Tory. When upon the dissolution of parliament the patron refused to return him he brought an action and recovered part of his money. Six years elapsed before he again entered the House, and during that interval he had made the acquaintance and imbibed the doctrines of James Mill and the philosophical reformers of the school of Bentham. He had joined his efforts to those of Francis Place, of Westminster, and other philanthropists, to relieve and improve the condition of the working classes, labouring especially to establish schools for them on the Lancasterian system, and promoting the formation of savings banks. In 1818, soon after his marriage with Miss Burnley, the daughter of an East India director, he was returned to parliament as member for the Border burghs. He was afterwards successively elected for Middlesex (1830), Kilkenny (1837) and for the Montrose burghs (1842), in the service of which constituency he died. From the date of his re-entering the House Hume became the self-elected guardian of the public purse, by challenging and bringing to a direct vote every single item of public expenditure. In 1820 he secured the appointment of a committee to report on the expense of collecting the revenue. He was incessantly on his legs in committee, and became a name for an opposition bandog who gave chancellors of the exchequer no peace. He undoubtedly exercised a check on extravagance, and he did real service by helping to abolish the sinking fund. It was he who caused the word "retrenchment" to be added to the Radical programme "peace and reform." He carried on a successful warfare against the old combination laws that hampered workmen and favoured masters; he brought about the repeal of the laws prohibiting the export of machinery and of the act preventing workmen from going abroad. He constantly protested against flogging in the army, the impressment of sailors and imprisonment for debt. He took up the question of light-houses and harbours; in the former he secured greater efficiency, in the latter he prevented useless expenditure. Apart from his pertinacious fight for economy Hume was not always fortunate in his political activity. He was conspicuous in the agitation raised by the so-called Orange plot to set aside King William IV. in favour of the duke of Cumberland (1835 and 1836). His action as trustee for the notorious Greek Loan in 1824 was at least not delicate, and was the ground of charges of downright dishonesty. He died on the 20th of February 1855.

A *Memorial of Hume* was published by his son Joseph Burnley Hume (London, 1855).

HUMILIATI, the name of an Italian monastic order created in the 12th century. Its origin is obscure. According to some chroniclers, certain noblemen of Lombardy, who had offended the emperor (either Conrad III. or Frederick Barbarossa), were carried captive into Germany and after suffering the miseries of exile for some time, "humiliated" themselves before the emperor. Returning to their own country, they did penance

and took the name of Humiliati. They do not seem to have had any fixed rule, nor did St. Bernard succeed in inducing them to submit to one. The traditions relating to a reform of this order by St. John of Meda are ill authenticated, his *Acta sanctorum Boll.*, Sept., vii. 320) being almost entirely unsupported by contemporary evidence. The "Chronicon anonymi Laudensensis canonici" (*Mon. Germ. hist. Scriptores*, xxvi. 449), at date 1178, states that a group of Lombards came to Rome with the intention of obtaining the pope's approval of the rule of life which they had spontaneously chosen; while continuing to live in their houses in the midst of their families, they wished to lead a more pious existence than of old, to abandon oaths and litigation, to content themselves with a modest dress, and all in a spirit of Catholic piety. The pope approved their resolve to live in humility and purity, but forbade them to hold assemblies and to preach in public; the chronicler adding that they infringed the pope's wish and thus drew upon themselves his excommunication. Their name, Humiliati ("Humiles" would have been more appropriate), arose from the fact that the clothes they wore were very simple and of one colour. This lay fraternity spread rapidly and soon put forth two new branches, a second order composed of women, and a third composed of priests. No sooner, however, had this order of priests been formed, than it claimed precedence of the others, and, though chronologically last, was called *primus ordo* by hierarchical right—*propter tonsuram* (see P. Sabatier, "Regula antiqua Fr. et Sor. de poenitentia" in *Opuscula de critique historique*, part i. p. 15). In 1201 Pope Innocent III. granted a rule to this third order. Sabatier has drawn attention to the resemblances between this rule and the *Regula de poenitentia* granted to Franciscanism in the course of its development; on the other hand, it is incontestable that Innocent III. wished to reconcile the order with the Waldenses, and, indeed, its rule reproduces several of the Waldensian propositions, ingeniously modified in the orthodox sense, but still very easily recognizable. It forbade useless oaths and the taking of God's name in vain; allowed voluntary poverty and marriage; regulated pious exercises; and approved the solidarity which already existed among the members of the association. Finally, by a singular concession, it authorized them to meet on Sunday to listen to the words of a brother "of proved faith and prudent piety," on condition that the hearers should not discuss among themselves either the articles of faith or the sacraments of the church. The bishops were forbidden to oppose any of the utterances of the Humiliati brethren, "for the spirit must not be stifled." James of Vitry, without being unfavourable to their tendencies, represents their association as one of the peculiarities of the church of his time (*Historia orientalis*, Douai, 1597). So broad a discipline must of necessity have led back some waverers into the pale of the church, but the Waldenses of Lombardy, in their *congregationes laborantium*, preserved the tradition of the independent Humiliati. Indeed, this tradition is confounded throughout the later 12th century with the history of the Waldenses. The "Chronicon Urspergense" (*Mon. Germ. hist. Scriptores*, xxiii. 376-377) mentions the Humiliati as one of the two Waldensian sects. The celebrated decretal promulgated in 1184 by Pope Lucius III. at the council of Verona against all heretics condemns at the same time as the "Poor Men of Lyons" "those who attribute to themselves falsely the name of Humiliati," at the very time when this name denoted an order recognized by the papacy. This order, though orthodox, was always held in tacit and ever-increasing suspicion, and, in consequence of grave disorders, Pius V. suppressed the entire congregation in February 1570-71.

See Tiraboschi, *Vetera humiliatorum monumenta* (Milan, 1766); K. Müller, *Die Waldenser* (Gotha, 1886); W. Preger, *Beiträge zur Geschichte der Waldenser* (Munich, 1875). (P. A.)

HUMITE, a group of minerals consisting of basic magnesium fluo-silicates, with the following formulæ:—Chondrodite, $Mg_2[Mg(F,OH)_2]SiO_4$; Humite, $Mg_3[Mg(F,OH)_2]SiO_4$; Clinohumite, $Mg_2[Mg(F,OH)_2]SiO_4$. Humite crystallizes in the orthorhombic and the two others in the monoclinic system, but between them there is a close crystallographic relation: the

lengths of the vertical axes are in the ratio 5:7:9, and this is also the ratio of the number of magnesium atoms present in each of the three minerals. These minerals are strikingly similar in appearance, and can only be distinguished by the goniometric measurement of the complex crystals. They are honey-yellow to brown or red in colour, and have a vitreous to resinous lustre; the hardness is 6-6½, and the specific gravity 3.1-3.2. Further, they often occur associated together, and it is only comparatively recently that the three species have been properly discriminated. The name humite, after Sir Abraham Hume, Bart. (1749-1839), whose collection of diamond crystals is preserved at Cambridge in the University museum, was given by the comte de Bournon in 1813 to the small and brilliant honey-yellow crystals found in the blocks of crystalline limestone ejected from Monte Somma, Vesuvius; all three species have since been recognized at this locality. Chondrodite (from *χονδροειδης*, "a grain") was a name early (1817) in use for granular forms of these minerals found embedded in crystalline limestones in Sweden, Finland and at several places in New York and New Jersey. Large hyacinth-red crystals of all three species are associated with magnetite in the Tilly Foster iron-mine at Brewster, New York; and at Kafveltorp in Örebro, Sweden, similar crystals (of chondrodite) occur embedded in galena and chalcopyrite.

The relation mentioned above between the crystallographic constants and the chemical composition is unique amongst minerals, and is known as a morphotropic relation. S. L. Penfield and W. T. H. Howe, who in 1894 noticed this relation, predicted the existence of another member of the series, the crystals of which would have a still shorter vertical axis and contain less magnesium, the formula being $Mg[Mg(F,OH)]_2SiO_6$; this has since been discovered and named proclite (from *προκλιτης*, "to foretell"). (L. J. S.)

HUMMEL, JOHANN NEPOMUK (1778-1837), German composer and pianist, was born on the 14th of November 1778, at Pressburg, in Hungary, and received his first artistic training from his father, himself a musician. In 1785 the latter received an appointment as conductor of the orchestra at the theatre of Schikaneder, the friend of Mozart and the librettist of the *Magic Flute*. It was in this way that Hummel became acquainted with the composer, who took a great fancy to him, and even invited him to his house for a considerable period. During two years, from the age of seven to nine, Hummel received the invaluable instruction of Mozart, after which he set out with his father on an artistic tour through Germany, England and other countries, his clever playing winning the admiration of amateurs. He began to compose in his eleventh year. After his return to Vienna he completed his studies under Albrechtsberger and Haydn, and for a number of years devoted himself exclusively to composition. At a later period he learned song-writing from Salieri. For some years he held the appointment of orchestral conductor to Prince Eszterhazy, probably entering upon this office in 1807. From 1811 to 1815 he lived in Vienna. On the 18th of May 1813 he married Elisabeth Röckl, a singer, and the sister of one of Beethoven's friends. It was not till 1816 that he again appeared in public as a pianist, his success being quite extraordinary. His gift of improvisation at the piano was especially admired, but his larger compositions also were highly appreciated, and for a time Hummel was considered one of the leading musicians of an age in which Beethoven was in the zenith of his power. In Prussia, which he visited in 1822, the ovations offered to him were unprecedented, and other countries—France in 1825 and 1829, Belgium in 1826 and England in 1830 and 1833—added further laurels to his crown. He died in 1837 at Weimar, where for a long time he had been the musical conductor of the court theatre. His compositions are very numerous, and comprise almost every branch of music. He wrote, amongst other things, several operas, both tragic and comic, and two grand masses (*Op.* 80 and 111). Infinitely more important are his compositions for the pianoforte (his two concerti in A minor and B minor, and the sonata in F sharp minor), and his chamber music (the celebrated septet, and several trios, etc.). His experience as a player and teacher of the pianoforte was embodied in his *Great*

Pianoforte School (Vienna), and the excellence of his method is further proved by such pupils as Henselt and Ferdinand Hiller. Both as a composer and as a pianist Hummel continued the traditions of the earlier Viennese school of Mozart and Haydn; his style in both capacities was marked by purity and correctness rather than by passion and imagination.

HUMMING-BIRD, a name in use, possibly ever since English explorers first knew of them, for the beautiful little creatures to which, from the sound occasionally-made by the rapid vibrations of their wings, it is applied. Among books that are ordinarily in naturalists' hands, the name seems to be first found in the *Museum Tradescantianum*, published in 1656, but it therein occurs (p. 3) so as to suggest its having already been accepted and commonly understood; and its earliest use, as yet traced, is by Thomas Morton (d. 1640), a disreputable lawyer who had a curiously adventurous career in New England, in the *New English Canaan*, printed in 1637—a rare work giving an interesting description of the natural scenery and social life in New England in the 17th century, and reproduced by Peter Force in his *Historical Tracts* (vol. ii., Washington, 1838). André Thevet, in his *Singularités de la France antarctique* (Antwerp, 1558, fol. 92), has been more than once cited as the earliest author to mention humming-birds, which he did under the name of *Couambuck*; but it is quite certain that Oviedo, whose *Historia general de las Indias* was published at Toledo in 1525, preceded him by more than thirty years, with an account of the "paxaro mosquito" of Hispaniola, of which island "the first chronicler of the Indies" was governor.¹ This name, though now apparently disused in Spanish, must have been current about that time, for we find Gesner in 1555 (*De avium natura*, iii. 629) translating it literally into Latin as *Passer muscatus*, owing, as he says, his knowledge of the bird to Cardan, the celebrated mathematician, astrologer and physician, from whom we learn (*Comment. in Ptolem. de astr. judiciis*, Basel, 1554, p. 472) that, on his return to Milan from professionally attending Archbishop Hamilton at Edinburgh, he visited Gesner at Zürich, about the end of the year 1552.² The name still survives in the French *oiseau-mouche*; but the ordinary Spanish appellation is, and long has been, *Tominejo*, from *tomis*, signifying a weight equal to the third part of an *adamo* or drachm, and used metaphorically for anything very small. Humming-birds, however, are called by a variety of other names, many of them derived from American languages, such as *Guanambi*, *Ouarissis* and *Colibri*, to say nothing of others bestowed upon them (chiefly from some peculiarity of habit) by Europeans, like *Picaflores*, *Chuparosa* and *Froufrou*. Barrère, in 1745, conceiving that humming-birds were allied to the wren, the *Trochilus*,³ in part, of

¹ In the edition of Oviedo's work published at Salamanca in 1547, the account (lib. xiv. cap. 4) runs thus: "Ay assi mismo enesta ysla vnos paxaricos tan negros como vn terciopelo negro muy bueno & son tan pequeños que ningunos he yo visto en Indias menores/ excepto el que aca se llama paxaro mosquito. El qual es tan pequeño que el bulto del es menor harto o asaz que le cabeça del dedo pulgar de la mano. Este no le he visto enesta ysla pero dizen me que aqui los ay: & por esso dexo de hablar enel pa lo dexir dode los he visto que es en la tierra firme quaddo della se trate." A modern Spanish version of this passage will be found in the beautiful edition of Oviedo's works published by the Academy of Madrid in 1851 (i. 444).

² See also Morley's *Life of Girolamo Cardano* (ii. 152, 153).

³ Under this name Phiny perpetuated (*Hist. naturalis*, viii. 25) the confusion that had doubtless arisen before his time of two very distinct birds. As Sundevall remarks (*Tentamen*, p. 87, note), *trochilos* was evidently the name commonly given by the ancient Greeks to the smaller plover, and was not improperly applied by Herodotus (ii. 68) to the species that feeds in the open mouth of the crocodile—the *Pluvianus aegyptius* of modern ornithologists—in which sense Aristotle (*Hist. animalium*, ix. 6) also uses it. But the received text of Aristotle has two other passages (ix. 1 and 11) wherein the word appears in a wholly different connexion, and can there be only taken to mean the wren—the usual Greek name of which would seem to be *θρῦλος* (Sundevall, *On Aristot. Dialecter*, No. 54). Though none of his editors or commentators has suggested the possibility of such a thing, one can hardly help suspecting that in these passages some early copyist has substituted *trochilos* for *θρῦλος*, and so laid the foundation of a curious error. It may be remarked that the crocodile of Santo Domingo is said to have the like office done for it by some kind of bird, which is called by Descourtilles

Pliny, applied that name in a generic sense (*Ornith. spec. novum*, pp. 47, 48) to both. Taking the hint thus afforded, Linnaeus very soon after went farther, and, excluding the wrens, founded his genus *Trochilus* for the reception of such humming-birds as were known to him. The unfortunate act of the great nomenclator cannot be set aside; and, since his time, ornithologists, with but few exceptions, have followed his example, so that nowadays humming-birds are universally recognized as forming the family *Trochilidae*.

The relations of the *Trochilidae* to other birds were for a long while very imperfectly understood. Nitzsch first drew attention to their agreement in many essential characters with the swifts, *Cypselidae*, and placed the two families in one group, which he called *Macrochires*, from the great length of their manual bones, or those forming the extremity of the wing. The name was perhaps not very happily chosen, for it is not the distal portion that is so much out of ordinary proportion to the size of the bird, but the proximal and median portions, which in both families are curiously dwarfed. Still the *manus*, in comparison with the other parts of the wing, is so long that the term *Macrochires* is not wholly inaccurate. The affinity of the *Trochilidae* and *Cypselidae*, once pointed out, became obvious to every careful and unprejudiced investigator, and there are probably few systematists now living who refuse to admit its validity. More than this, it is confirmed by an examination of other osteological characters. The "lines," as a boat-builder would say, upon which the skeleton of each form is constructed are precisely similar, only that whereas the bill is very short and the head wide in the swifts, in the humming-birds the head is narrow and the bill long—the latter developed to an extraordinary degree in some of the *Trochilidae*, rendering them the longest-billed birds known.¹ Huxley takes these two families, together with the goatsuckers (*Caprimulgidae*), to form the division *Cypselomorphae*—one of the two into which he separated his larger group *Aegithognathae*. However, the most noticeable portion of the humming-bird's skeleton is the *sternum*, which in proportion to the size of the bird is enormously developed both longitudinally and vertically, its deep keel and posterior protraction affording abundant space for the powerful muscles which drive the wings in their rapid vibrations as the little creature poises itself over the flowers where it finds its food.²

So far as is known, all humming-birds possess a protrusible tongue, in conformation peculiar among the class *Aves*, though to some extent similar to that member in the woodpeckers (*Picidae*)—the "horns" of the hyoid apparatus upon which it is seated being greatly elongated, passing round and over the back part of the head, near the top of which they meet, and thence proceed forward, lodged in a broad and deep groove, till they terminate in front of the eyes. But, unlike the tongue of the woodpeckers, that of the humming-bird consists of two cylindrical tubes, tapering towards the point, and forming two sheaths which contain the extensible portion, and are capable of separation, thereby facilitating the extraction of honey from the nectaries of flowers, and with it, what is of far greater importance for the bird's sustenance, the small insects that have been attracted to feed upon the honey.³ These, on the tongue being withdrawn into the bill, are caught by the mandibles (furnished (*Voyage*, iii. 26), a "Todier," but, as Geoffr. St Hilaire observes (*Descr. de l'Égypte*, ed. 2, xxiv. 440), is more probably a plover, Unfortunately the fauna of Hispaniola is not much better known now than in Oviedo's days.

¹ Thus *Docimastes ensifer*, in which the bill is longer than both head and body together.

² This is especially the case with the smaller species of the group, for the larger, though shooting with equal celerity from place to place, seem to flap their wings with comparatively slow but not less powerful strokes. The difference was especially observed with respect to the largest of all humming-birds, *Patagona gigas*, by Darwin.

³ The resemblance, so far as it exists, must be merely the result of analogical function, and certainly indicates no affinity between the families.

⁴ It is probable that in various members of the *Trochilidae* the structure of the tongue, and other parts correlated therewith, will be found subject to several and perhaps considerable modifications, as is the case in various members of the *Picidae*.

in the males of many species with fine, horny, sawlike teeth⁴, and swallowed in the usual way. The stomach is small, moderately muscular, and with the inner coat slightly hardened. There seem to be no caeca. The trachea is remarkably short, the bronchi beginning high up on the throat, and song-muscles are wholly wanting, as in all other *Cypselomorphae*.⁵

Humming-birds comprehend the smallest members of the class *Aves*. The largest among them measures no more than 8½ and the least 2½ in. in length, for it is now admitted generally that Sloane must have been in error when he described (*Voyage*, ii. 308) the "least humming-bird of Jamaica" as "about 1½ in. long from the end of the bill to that of the tail"—unless, indeed, he meant the proximal end of each. There are, however, several species in which the tail is very much elongated, such as the *Aithurus polytmus* (fig. 1) of Jamaica, and the remarkable *Lodiglesia mirabilis* of Chachapoyas in Peru, which last was for some time only known from a unique specimen (*Ibis*, 1880, p. 152); but "trochilidists" in giving their measurements do not take these extraordinary developments into account. Next to their generally small size, the best-known characteristic of the *Trochilidae* is the wonderful brilliancy of the plumage of nearly all their forms, in which respect they are surpassed by no other birds, and are only equalled by a few, as, for instance, by the *Nectariniidae*, or sun-birds of the tropical parts of the Old World, in popular estimation so often confounded with them.

The number of species of humming-birds now known to exist considerably exceeds 400; and, though none departs very widely from what a morphologist would deem the typical structure of the family, the amount of modification, within certain limits, presented by the various forms is surprising and even bewildering to the uninitiated. But the features that are ordinarily chosen by systematic ornithologists in drawing up their schemes of classification are found by the "trochilidists," or special students of the *Trochilidae*, insufficient for the purpose of arranging these birds in groups, and characters on which genera can be founded have to be sought in the style and coloration of plumage, as well as in the form and proportions of those parts which are most generally deemed sufficient to furnish them. Looking to the large number of species to be taken into account, convenience has demanded what science would withhold, and the genera established by the ornithologists of a preceding generation have been broken up by their successors into multitudinous sections—the more adventurous making from 150 to 180 of such groups, the modest being content with 120 or thereabouts, but the last dignifying each of them by the title of genus. It is of course obvious that these small divisions cannot be here considered in detail, nor would much advantage accrue by giving statistics from the works of recent trochilidists, such as Gould,⁶ Mulsant⁷ and Elliot.⁸ It would be as unprofitable here to trace the successive steps by which the original genus *Trochilus* of Linnaeus, or the two genera *Polytmus* and *Mellisuga* of Brisson, have been split into others, or have been added

⁵ These are especially observable in *Rhamphodon nasutus* and *Androdon aequaliorialis*.

⁶ P. H. Gosse (*Birds of Jamaica*, p. 130) says that *Mellisuga minima*, the smallest species of the family, has "a real song"—but the like is not recorded of any other.

⁷ *A Monograph of the Trochilidae or Humming-birds*, 5 vols. imp. fol. (London, 1861, with Introduction in 8vo).

⁸ *Histoire naturelle des oiseaux-mouches, ou colibris*, 4 vols., with supplement, imp. 4to (Lyon-Gendve-Bale, 1874-1877).

⁹ *Smithsonian Contributions to Knowledge*, No. 317, *A Classification and Synopsis of the Trochilidae*, 1 vol. imp. 4to (Washington, 1879).

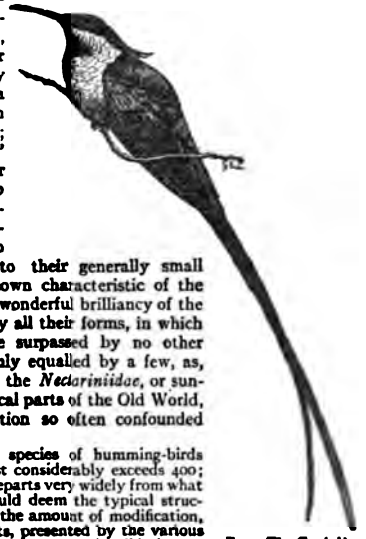

From *The Cambridge Natural History*, vol. 2, "Birds," by permission of Macmillan & Co., Ltd.

FIG. 1.—*Aithurus polytmus*.

to, by modern writers, for not one of these professes to have arrived at any final, but only a provisional, arrangement; it seems, however, expedient to notice the fact that some of the authors of the 18th century¹ supposed themselves to have seen the way to dividing what we now know as the family *Trochilidae* into two groups, the distinction between which was that in the one the bill was arched and in the other straight, since that difference has been insisted on in many works. This was especially the view taken by Brisson and Buffon, who termed the birds having the arched bill "colibris," and those having it straight "oiseaux-mouches." The distinction wholly breaks down, not merely because there are *Trochilidae* which possess almost every gradation of decurvation of the bill, but some which have the bill upturned after the manner of that strange bird the avocet,² while it may be remarked that several of the species placed by those authorities among the "colibris" are not humming-birds at all.

In describing the extraordinary brilliant plumage which most of the *Trochilidae* exhibit, ornithologists have been compelled to adopt the vocabulary of the jeweller in order to give an idea of the indescribable radiance that so often breaks forth from some part or other of the investments of these feathered gems. In all, save a few other birds, the most imaginative writer sees gleams which he may adequately designate metallic, from their resemblance to burnished gold, bronze, copper or steel, but such similitudes wholly fail when he has to do with the *Trochilidae*, and there is hardly a precious stone—ruby, amethyst, sapphire, emerald or topaz—the name of which may not fitly, and without any exaggeration, be employed in regard to humming-birds. In some cases this radiance beams from the brow, in some it glows from the throat, in others it shines from the tail-coverts, in others it sparkles from the tip only of elongated feathers that crest the head or surround the neck as with a frill, while again in others it may appear as a luminous streak across the cheek or auriculars. The feathers that cover the upper parts of the body very frequently have a metallic lustre of golden-green, which in other birds would be thought sufficiently beautiful, but in the *Trochilidae* its sheen is overpowered by the almost dazzling splendour that radiates from the spots where Nature's lapidary has set her jewels. The light feathers are almost invariably dusky—the rapidity of their movement would, perhaps, render any display of colour ineffective; while, on the contrary, the feathers of the tail, which, as the bird hovers over its food-bearing flowers, is almost always expanded, and is therefore comparatively motionless, often exhibit a rich translucency, as of stained glass, but iridescent in a manner that no stained glass ever is—cinnamon merging into crimson, crimson changing to purple, purple to violet, and so to indigo and bottle-green. But this part of the humming-bird is subject to quite as much modification in form as in colour, though always consisting of ten *rectrices*. It may be nearly square, or at least but slightly rounded, or wedge-shaped with the middle quills prolonged beyond the rest; or, again, it may be deeply forked, sometimes by the overgrowth of one or more of the intermediate pairs, but most generally by the development of the outer pair. In the last case the lateral feathers may be either broadly webbed to their tip or acuminate, or again, in some forms, may lessen to the filiform shaft, and suddenly enlarge into a terminal spatulation as in the forms known as "racquet tails." The wings do not offer so much variation; still there are a few groups in which diversities occur that require notice. The primaries are invariably ten in number, the outermost being the longest, except in the single instance of *Aithya*, where it is shorter than the next. The group known as "saber-wings," comprising the genera *Campylopterus*, *Eupetomena* and *Sphenoproctus*, present a most curious sexual peculiarity, for while the female has nothing remarkable in the form of the wing, in the male the shaft of two or three of the outer primaries is dilated proximally, and bowed near the middle in a manner almost unique among birds. The feet again, diminutive as they are, are very diversified in form. In most the tarsus is bare, but in some groups, as *Eriocnemis*, it is clothed with tufts of the most delicate down, sometimes black, sometimes buff, but more often of a snowy whiteness. In some the toes are weak, nearly equal in length, and furnished with small rounded nails; in others they are largely developed, and armed with long and sharp claws.

Apart from the well-known brilliancy of plumage, of which enough has been here said, many humming-birds display a large amount of ornamentation in the addition to their attire of crests of various shape and size, elongated ear-tufts, projecting neck-frills, and pendant beards—forked or forming a single point. But it would be impossible here to dwell on a tenth of these beautiful modifications, each of which as it comes to our knowledge excites fresh surprise and exemplifies the ancient adage—*maxime miranda in minimis Natura*. It must be remarked, however, that there are certain forms which possess little or no brilliant colouring at all, but, as most tropical birds go, are very soberly clad. These are known to trochilidists as "hermits," and by Gould have been separated as a subfamily under the name of *Phaethornithinae*, though Elliot says he cannot find any

¹ Salerne must be excepted, especially as he was rebuked by Buffon for doing what we now deem right.

² For example *Avocetula recurvirostris* of Guiana and *A. euryptera* of Colombia.

characters to distinguish it from the *Trochilidae* proper. But sight is not the only sense that is affected by humming-birds. The large species known as *Pterophanes lemnich* has a strong musky odour, very similar to that given off by the petrel, though, so far as appears to be known, that is the only one of them that possesses this property.³

All well-informed people are aware that the *Trochilidae* are a family peculiar to America and its islands, but one of the commonest of common errors is the belief that humming-birds are found in Africa and India—to say nothing even of England. In the first two cases the mistake arises from confounding them with some of the brightly-coloured sun-birds (*Nectariniidae*), to which British colonists or residents are apt to apply the better-known name; but in the last it can be only due to the want of perception which disables the observer from distinguishing between a bird and an insect—the object seen being a hawk-moth (*Macroglossa*), whose mode of feeding and rapid flight certainly bears some resemblance to that of the *Trochilidae*, and hence one of the species (*M. stellarum*) is very generally called the "humming-bird hawk-moth." But though confined to the New World the *Trochilidae* pervade almost every part of it. In the south *Eustephanus galerii* has been seen fitting about the fuchsias of Tierra del Fuego in a snow-storm, and in the north-west *Selasphorus rufus* in summer visits the ribes-blossoms of Sitka, while in the north-east *Trochilus colubris* charms the vision of Canadians as it poises itself over the althaea-bushes in their gardens, and extends its range at least so far as lat. 57° N. Nor is the distribution of humming-birds limited to a horizontal direction only, it rises also vertically. *Oreotrochilus chimeranus* and *O. pichinchu* live on the lofty mountains whence each takes its specific name, but just beneath the line of perpetual snow, at an elevation of some 16,000 ft., dwelling in a world of almost constant hail, sleet and rain, and feeding on the insects which resort to the indigenous flowering plants, while other peaks, only inferior to these in height, are no less frequented by one or more species. Peru and Bolivia produce some of the most splendid of the family—the genera *Cometes*, *Diphlogaena* and *Thaumastura*, whose very names indicate the glories of their bearers. The comparatively gigantic *Patagona* inhabits the west coast of South America, while the isolated rocks of Juan Fernandez not only afford a home to the *Eustephanus* but also to two other species of the same genus which are not found elsewhere. The slopes of the Northern Andes and the hill country of Colombia furnish perhaps the greatest number of forms, and some of the most beautiful, but leaving that great range, we part company with the largest and most gorgeously arrayed species, and their number dwindles as we approach the eastern coast. Still there are many brilliant humming-birds common enough in the Brazil, Guiana and Venezuela. The *Chrysolampis mosquitus* is perhaps the most plentiful. Thousands of its skins are annually sent to Europe to be used in the manufacture of ornaments, its rich ruby-and-topaz glow rendering it one of the most beautiful objects imaginable. In the darkest depths of the Brazilian forests dwell the russet-clothed brotherhood of the genus *Phaethornis*—the "hermits"; but the great wooded basin of the Amazons seems to be particularly unfavourable to the *Trochilidae*, and from Pará to Ega there are scarcely a dozen species to be met with. There is no island of the Antilles but it is inhabited by one or more humming-birds, and there are some very remarkable singularities of geographical distribution to be found. Northwards from Panama the highlands present many genera whose names it would be useless here to insert, few or none of which are found in South America—though that must unquestionably be deemed the metropolis of the family—and advancing towards Mexico the numbers gradually fall off. Eleven species have been enrolled among the fauna of the United States, but some on slender evidence, while others only just cross the frontier line.

The habits of humming-birds have been ably treated by writers like Waterton, Wilson and Audubon, to say nothing of P. H. Gosse, A. R. Wallace, H. W. Bates and others. But there is no one appreciative

³ The specific name of a species of *Chrysolampis*, commonly written by many writers *moschatus*, would lead to the belief that it was a mistake for *moschatus*, i.e. musky," but in truth it originates with their carelessness, for though they quote Linnaeus as the authority they can never have referred to his works, or they would have found the word to be *mosquitus*, the "mosquito" of Oviedo, awkwardly, it is true, Latinized. If emendation be needed, *muschatus*, after Gesner's example, is undoubtedly, preferable.



From The Cambridge National History, vol. ix. "Birds," by permission of Macmillan & Co. Ltd.
FIG. 2.—*Eulampis jugularis*.

of the beauties of nature who will not recall to memory with delight the time when a live humming-bird first met his gaze. The suddenness of the apparition, even when expected, and its brief duration, are alone enough to fix the fluttering vision on the mind's eye. The wings of the bird, if flying, are only visible as a thin grey film, bounded above and below by fine black threads, in form of a St Andrew's cross.—the effect on the observer's retina of the instantaneous reversal of the motion of the wing at each beat—the strokes being so rapid as to leave no more distinct image. Consequently an adequate representation of the bird on the wing cannot be produced by the draughtsman. Humming-birds show to the greatest advantage when engaged in contest with another, for rival cocks fight fiercely, and, as may be expected, it is then that their plumage flashes with the most glowing tints. But these are quite invisible to the ordinary spectator except when very near at hand, though doubtless efficient enough for their object, whether that be to inflame their mate or to irritate or daunt their opponent, or something that we cannot compass. Humming-birds, however, will also often sit still for a while, chiefly in an exposed position, on a dead twig, occasionally darting into the air, either to catch a passing insect or to encounter an adversary; and so pugnacious are they that they will frequently attack birds many times bigger than themselves, without, as would seem, any provocation.

The food of humming-birds consists mainly of insects, mostly gathered in the manner already described from the flowers they visit; but, according to Wallace, there are many species which he has never seen so occupied, and the "hermits" especially seem to live almost entirely upon the insects which are found on the lower surface of leaves, over which they will closely pass their bill, balancing themselves the while vertically in the air. The same excellent observer also remarks that even among the common flower-frequenting species he has found the alimentary canal entirely filled with insects, and very rarely a trace of honey. It is this fact doubtless that has hindered almost all attempts at keeping them in confinement for any length of time—nearly every one making the experiment having fed his captives only with syrup, which, without the addition of some animal food, is insufficient as sustenance, and seeing therefore the wretched creatures gradually sink into inanition and die of hunger. With better management, however, several species have been brought on different occasions to Europe, some of them to England.

The beautiful nests of humming-birds, than which the work of fairies could not be conceived more delicate, are to be seen in moist muscums, and will be found on examination to be very solidly and tenaciously built, though the materials are generally of the slightest—cotton-wool or some vegetable down and spiders' webs. They vary greatly in form and ornamentation—for it would seem that the portions of lichen which frequently bestud them are affixed to their exterior with that object, though probably concealment was the original intention. They are mostly cup-shaped, and the singular fact is on record (*Zool. Journal*, v. p. 1) that in one instance as the young grew in size the walls were heightened by the parents, until at last the nest was more than twice as big as when the eggs were laid and hatched. Some species, however, suspend their nests from the stem or tendril of a climbing plant, and more than one case has been known in which it has been attached to a hanging rope. These pensile nests are said to have been found loaded on one side with a small stone or bits of earth to ensure their safe balance, though how the compensatory process is applied no one can say. Other species, and especially those belonging to the "hermit" group, weave a frail structure round the side of a drooping palm-leaf. The eggs are never more than two in number, quite white, and having both ends nearly equal. The solicitude for her offspring displayed by the mother is not exceeded by that of any other birds, but it seems doubtful whether the male takes any interest in the brood.

(A. N.)

HUMMOCK (of uncertain derivation; cf. hump or hillock), a boss or rounded knoll of ice rising above the general level of an ice-field, making sledge travelling in the Arctic and Antarctic region extremely difficult and unpleasant. Hummocky ice is caused by slow and unequal pressure in the main body of the packed ice, and by unequal structure and temperature at a later period.

HUMOUR (Latin *humor*), a word of many meanings and of strange fortune in their evolution. It began by meaning simply "liquid." It passed through the stage of being a term of art used by the old physicians—whom we should now call physiologists—and by degrees has come to be generally understood to signify a certain "habit of the mind," shown in speech, in literature and in action, or a quality in things and events observed by the human intelligence. The word reached its full development by slow degrees. When Dr Johnson compiled his dictionary, he gave nine definitions of, or equivalents for, "humour." They may be conveniently quoted: "(1) Moisture. (2) The different kinds of moisture in man's body, reckoned by

the old physicians to be phlegm, blood, choler and melancholy, which as they predominate are supposed to determine the temper of mind. (3) General turn or temper of mind. (4) Present disposition. (5) Grotesque imagery, jocularity, merriment. (6) Tendency to disease, morbid disposition. (7) Pettulance, peevishness. (8) A trick, a practice. (9) Caprice, whim, predominant inclination." The list was not quite complete, even in Dr Johnson's own time. Humour was then, as it is now, the name of the semi-fluid parts of the eye. Yet no dictionary-maker has been more successful than Johnson in giving the literary and conversational meaning of an English word, or the main lines of its history. It is therefore instructive to note that in no one of his nine clauses does humour bear the meaning it has for Thackeray or for George Meredith. "General turn or temper of mind" is at the best too vague, and has more-over another application. His list of equivalents only carries the history of the word up to the beginning of the last stage of its growth.

The limited original sense of liquid, moisture, mere wet, in which "humour" is used in Wycliffe's translation of the Bible, continued to attach to it until the 17th century. Thus Shakespeare, in the first scene of the second act of *Julius Caesar*, makes Portia say to her husband:—

'Is Brutus sick? and is it physical
To walk unbraced and suck up the humours
Of the dank morning?'

In the same scene Decius employs the word in the wide metaphorical sense in which it was used, and abused, then and afterwards. "Let me work," he says, referring to Caesar—

'For I can give his humour the true beat,
And I will bring him to the Capitol.'

Here we have "the general turn or temper of mind," which can be flattered, or otherwise directed to "present disposition." We have travelled far from mere fluid, and have been led on the road by the old physiologists. We are not concerned with their science, but it is necessary to see what they mean by "primary humours," and "second or third concoctions," if we are to understand how it was that a name for liquid could come to mean "general turn" or "present disposition," or "whim" or "jocularity." Part I., Section 1, Member 2, Subsection 2, of Burton's *Anatomy of Melancholy* will supply all that is necessary for literary purposes. "A humour is a liquid or fluent part of the body comprehended in it, and is either born with us, or is adventitious and acquiescent." The first four primary humours are—"Blood, a hot, sweet, tempered, red humour, prepared in the meseraic veins, and made of the most temperate parts of the chylus (chyle) in the liver, whose office it is to nourish the whole body, to give it strength and colour, being dispersed through every part of it. And from it spirits are first begotten in the heart, which afterwards in the arteries are communicated to the other parts. Pituita or phlegm is a cold and moist humour, begotten of the colder parts of the chylus (or white juice coming out of the meat digested in the stomach) in the liver. His office is to nourish and moisten the members of the body," &c. "Choler is hot and dry, begotten of the hotter parts of the chylus, and gathered to the gall. It helps the natural heat and senses. Melancholy, cold and dry, thick, black and sour, begotten of the more feculent part of nourishment, and purged from the spleen, is a bridle to the other two hot humours, blood and choler, preserving them in the blood, and nourishing the bones." Mention must also be made of serum, and of "those excrementitious humours of the third concoction, sweat and tears." An exact balance of the four primary humours makes the justly constituted man, and allows for the undisturbed production of the "concoctions"—or processes of digestion and assimilation. Literature seized upon these terms and definitions. Sometimes it applied them gravely in the moral and intellectual sphere. Thus the Jesuit Bouhours, a French critic of the 17th century, in his *Entretiens d'Ariste et d'Eugène*, says that in the formation of a *bel esprit*, "La bile donne le brillant et la pénétration, la mélancoë donne le bon sens et la solidité; le sang donne l'agrément et

la délicatesse." It was, in fact, taken for granted that the character and intellect of men were produced by—were, so to speak, concoctions dependent on—the "humours." In the fallen state of mankind it rarely happens that an exact balance is maintained. One or other humour predominates, and thus we have the long-established doctrine of the existence of the sanguine, the phlegmatic, the choleric, or the melancholy *temperaments*. Things being so, nothing was more natural than the passage of these terms of art into common speech, and their application in a metaphorical sense, when once they had been adopted by the literary class. The process is admirably described by Asper in the introduction to Ben Jonson's play—

Every Man out of his Humour:—

"Why humour, as it is 'ens,' we thus define it,
To be a quality of air or water;
And in itself holds these two properties
Moisture and fluxure: as, for demonstration
Pour water on this floor. "Will wet and run.
Likewise the air forced through a horn or trumpet
Flows instantly away, and leaves behind
A kind of dew; and hence we do conclude
That whatsoever hath fluxure and humidity
As wanting power to contain itself
Is humour. So in every human body
The choleric, melancholy, phlegm and blood
By reason that they flow continually
In some one part and are not continent
Receive the name of humours. Now thus far
It may, by metaphor, apply itself
Unto the general disposition;
As when some one peculiar quality
Doth so possess a man that it doth draw
All his effects, his spirits and his powers,
In their confluxion all to run one way,—
This may be truly said to be a humour."

A humour in this sense is a "ruling passion," and has done excellent service to English authors of "comedies of humours," to the Spanish authors of *comedias de figuron*, and to the French followers of Molière. Nor is the metaphor racked out of its fair proportions if we suppose that there may be a temporary, or even an "adventitious and acquiste" "predominance of a humour," and that "deliveries of a man's self" to passing passion, or to imitation, are also "humours," though not primary, but only second or third concoctions. By a natural extension, therefore, "humours" might come to mean oddities, tricks, practices, mere whims, and the aping of some model admired for the time being. "But," as Falstaff has told us, "it was always yet the trick of our English, if they have a good thing, to make it too common." The word "humour" was a good thing, but the Elizabethans certainly made it too common. It became a hack epithet of all work, to be used with no more discretion, though with less imbecile iteration, than the modern "awful." Shakespeare laughed at the folly, and pinned it for ever to the ridiculous company of Corporal Nym—"I like not the humour of lying. He hath wronged me in some humours. I should have borne the humoured letter to her. . . I love not the humour of bread and cheese; and there's the humour of it." The humour of Jonson was that he tried to clear the air of this ledown by stamping on it. Asper ends in denunciation:—

'But that a rook by wearing a pied feather,
The sable hat-band, or the three-piled ruff,
A yard of shoe tie, or the Switzer knot
On his French gaiters, should affect a humour,
O! it is more than most ridiculous."

The abuse of the word was the peculiar practice of England. The use of it was not confined wholly to English writers. The Spaniards of the 16th and 17th centuries knew *humores* in the same sense, and still employ the word as a name for caprices, whims and vapours. *Humorada* was, and is, the correct Spanish for a festive saying or writing of epigrammatic form. Martial's immortal reply to the critic who admired only dead poets—

*Innocas petimus Vacerra: tantū
Non est, ut placeam tibi perire,—*

is a model *humorada*. It would be a difficult and would certainly be a lengthy task to exhaust all the applications given

to so elastic a word. We still continue to use it in widely different senses. "Good humour" or "bad humour" are simply good temper or bad temper. There is a slight archaic flavour about the phrases "grim humour," "the humour they were in," in the sense of suspicious, or angry or careless mood, which were favourites with Carlyle, but though somewhat antiquated they are not affected, or very unusual. With the proviso that the exceptions must always be excepted, we may say that for a long time "humour" came to connote comic matter less refined than the matter of wit. It had about it a smack of the Boar's Head Tavern in Eastcheap, and of the unyoked "humour" of the society in which Prince Henry was content to imitate the sun—

"Who doth permit the base contagious clouds
To smother up his beauty from the world."

The presence of a base contagious cloud is painfully felt in the so-called humorous literature of England till the 18th century. The reader who does not sometimes wonder whether humour in the mouths of English writers of that period did not stand for maniacal tricks, horse-play, and the foul names of foul things, material and moral, must be very determined to prove himself a whole-hearted admirer of the ancient literature. Addison, who did much to clean it of mere nastiness, gives an excellent example of the base use of the word in his day. In Number 371 of the *Spectator* he introduces an example of the "sort of men called Whims and Humourists." It is the delight of this person to play practical jokes on his guests. He is proud when "he has packed together a set of oglers" who had "an unlucky cast in the eye," or has filled his table with stammerers. The humourist, in fact, was a mere practical joker, who was very properly answered by a challenge from a military gentleman of peppery temper. Indeed, the pump and a horse-whip would appear to have been the only effective forms of criticism on the prevalent humour and humours of the 16th, 17th and 18th centuries. But the pump and the horse-whip were themselves humours. Carlo Buffone in Jonson's play is put "out of his humour" by the counter humour of Signor Puntarvolo, who knocks him down and gags him with candle wax. The brutal pranks of Fanny Burney's Captain Mirvan, who belongs to the earlier part of the 18th century, were meant for humour, and were accepted as such. Examples might easily be multiplied. A briefer and also a more convincing method of demonstration is to take the deliberate judgment of a great authority. No writer of the 18th century possessed a finer sense of humour in the noble meaning than Goldsmith. What did he understand the word to mean? Not what he himself wrote when he created Dr Primrose. We have his express testimony in the 9th chapter of *The Present State of Polite Learning*. Goldsmith complains that "the critic, by demanding an impossibility from the comic poet, has, in effect, banished true comedy from the stage." This he has done by banning "low" subjects, and by proscribing "the comic or satirical muse from every walk but high life, which, though abounding in fools as well as the humbler station, is by no means so fruitful in absurdity. . . . Absurdity is the poet's game, and good breeding is the nice concealment of absurdity. The truth is, the critic generally mistakes 'humour' for 'wit,' which is a very different excellence; wit raises human nature above its level; humour acts a contrary part, and equally depresses it. To expect exalted humour is a contradiction in terms. . . . The poet, therefore, must place the object he would have the subject of humour in a state of inferiority; in other words, the subject of humour must be low."

That no doubt may remain in his reader's mind, Goldsmith gives an example of true humour. It is nothing more or less than the absurdity and incongruity obvious in a man who, though "wanting a nose," is extremely curious in the choice of his snuff-box. We applaud "the humour of it," for "we here see him guilty of an absurdity of which we imagine it impossible for ourselves to be guilty, and therefore applaud our own good sense on the comparison."

Nothing could be more true as an account of what the Elizabethans, the Restoration, the Queen Anne men, and the 18th century meant by "humour." Nothing could be more false

as an example of what we mean by the humour of Falstaff or of *The Vicar of Wakefield*.

When we pass from Goldsmith to Hazlitt—one of the greatest names in English criticism—we find that "humour" has grown in meaning, without quite reaching its full development. In the introduction to his *Lectures on the English Comic Writers* he attempts a classification of the comic spirit into wit and humour. "Humour," he says, "is the describing the ludicrous as it is in itself; wit is the exposing it, by comparing or contrasting it with something else. Humour is, as it were, the growth of nature and accident; wit is the product of art and fancy. Humour, as it is shown in books, is an imitation of the natural or acquired absurdities of mankind, or of the ludicrous in accident, situation and character; wit is the illustrating and heightening the sense of that absurdity by some sudden and unexpected likeness or opposition of one thing to another, which sets off the quality we laugh at or despise in a still more contemptible or striking point of view." Hazlitt's definition will, indeed, not stand analysis. The element of comparison is surely as necessary for humour as for wit. Yet his classification is valuable as illustrating the growth of the meaning of the word. Observe that Hazlitt has transferred to wit that power of pleasing as by a flattering sense of our own superiority which Goldsmith attributed to humour. He had not thought, and had not heard, that sympathy is necessary to complete humour. He cannot have thought it needful, for if he had he would hardly have said of the *Arabian Nights* that they are "an inexhaustible mine of comic humour and invention," "which from the manners of the East, which they describe, carry the principle of callous indifference in the jest as far as it can go." He might, and probably would, have dismissed Goldsmith's illustration as "low" in every conceivable sense. He would not have added, as we should to-day, that humour does not lie in laughter, according to the definition of Hobbes, in a "sudden glory," in a guffaw of self-conceited triumph over the follies and deficiencies of others. If there is any place for humour in Goldsmith's sordid example, it must be made by pity, and shown by a deft introduction of the *de la fabula* dear to Thackeray, by a reminder that the world is full of people, who, though wanting noses, are extremely curious in their choice of snuff-boxes, and that the more each of us thinks himself above the weakness the more likely he is to fall into it.

The critical value of Hazlitt's examination of the differences between wit and humour lies in this, that he ignores the doctrine that the quality of humour lies in the thing or the action and not in the mind of the observer. The examples quoted above, to which any one with a moderate share of reading in English literature could add with ease, show that humour was first held to lie in the trick, the whim, the act, or the event and clash of incidents. It might even be a mere flavour, as when men spoke of the salt humour of sea-sand. Even when it stood for the "general turn or temper of mind" it was a form of the ruling passion which inspires men's actions and words. It was used in that sense by Decius when he spoke of the humour of Caesar, which is a liability to be led by one who can play on his weakness—

"for he loves to hear
That unicorns may be betrayed with trees,
And bears with glasses, elephants with holes,
Lions with toils, and men with flatterers;
But when it tell him he hates flatterers,
He says he does; being then most flattered."

It is plain that this is not what Hazlitt meant, or we now mean, by the humour displayed in "describing the ludicrous as it is shown in itself." Nor did he, any more than we do, suppose with Goldsmith that a "low" quality of actions and persons is inseparable from humour. It had become for Hazlitt what Addison called cheerfulness, "a habit of the mind" as distinguished from mirth, which is "an act." If in Addison's sentences the place of cheerfulness is taken by humour, and that of mirth by wit, we have a very fair description of the two. "I have always preferred cheerfulness to mirth. The latter I consider as an act, the former as a habit of the mind. Mirth is short

and transient, cheerfulness is fixed and permanent." Humour is the fixed and permanent appreciation of the ludicrous, of which wit may be the short and transient expression.

If now we pass to an attempt to define "humour," the temptation to take refuge in the use of an evasion employed by Dr Johnson is very strong. When Boswell asked him, "Then, Sir, what is poetry?" the doctor answered, "Why, Sir, it is much easier to say what it is not. We all know what light is, but it is not easy to tell what it is." But George Meredith has come to our assistance in two passages of his *Essay on Comedy and the uses of the Comic Spirit*. "If you laugh all round him (to wit, the ridiculous person), tumble him, roll him about, deal him a smack, and drop a tear on him, own his likeness to you, and yours to your neighbour, spare him as little as you shun, pity him as much as you expose, it is spirit of Humour that is moving you. . . . The humourist of mean order is a refreshing laugher, giving tone to the feelings, and sometimes allowing the feelings to be too much for him. But the humourist, if high, has an embrace of contrasts beyond the scope of the comic poet." The third sentence is required to complete the first. The tumbling and rolling, the smacks and the exposure, may be out of place where there is humour of the most humorous quality. Who could associate them with Sir Walter Scott's characters of Bradwardine or Monkbarne? Bradwardine, one feels, would have stopped them as he did the ill-timed jests of Sir Hew Halbert, "who was so unthinking as to deride my family name." Monkbarne was a man of peace who loved the company of Sir Priest better than that of Sir Knight. But there is that in him which cows mere ridicule, be it ever so genial. He cared not who knew so much of his valour, and by that very avowal of his preference took his position sturdily in the face of the world. But Meredith has given its due prominence to the quality which, for us, distinguishes humour from pure wit and the harder forms of jocularity. It is the sympathy, the appreciation, the love, which include the follies of Doa Quixote, the prosaic absurdities of Sancho Panza, the oddities of Bradwardine, Dr Primrose or Monkbarne, and the jovial animalism of Falstaff, in "an embrace of contrasts beyond the scope of the comic poets."

It is needless to insist that humour of this order is far older than the very modern application of the name. It is assuredly present in Horace. Chaucer, who knew the word only as meaning "liquid," has left a masterpiece of humour in his prologue to the *Canterbury Pilgrims*. We look for the finest examples in Shakespeare. And if it is old, it is also more universal than is always allowed. National, or at least racial, partiality, has led to the unfortunate judgment that humour is a virtue of the northern peoples. Yet Rabelais came from Touraine, and if the creator of Panurge has not humour, who has? The Italians may say that *umore* in the English sense is unknown to them. They mean the word, not the thing, for it is in Ariosto. To claim the quality for Cervantes would indeed be to push at an open door. The humour of the Germans has been rarely indeed of so high an order as his. It has been found wherever humanity has been combined with a keen appreciation of the ludicrous. The appreciation may exist without the humanity. When Rivalro met the Chevalier Florian with a manuscript sticking out of his pocket, and said, "How rash you are! if you were not known you would be robbed," he was making use of the comic spirit, but he was not humorous. When Rivalro himself, a man of dubious claim to nobility, was holding forth on the rights of the nobles, and calling them "our rights," one of the company smiled. "Do you find anything singular in what I say?" asked he. "It is the plural which I find singular," was the answer. There is certainly something humorous in the neat overthrow of an insolent wit by a rival insolence, but the humour is in the spectator, not in the answer. The spirit of humour as described by George Meredith cannot be so briefly shown as in the rapid flash of the Frenchmen's wit. It lingers and expatiates, as in Dr Johnson's appreciation of Bet Flint. "Oh, a fine character, Madam! She was habitually a slut and a drunkard, and occasionally a thief and a harlot. And for heaven's

sake how came you to know her? Why, Madam, she figured in the literary world too! Bet Flint wrote her own life, and called herself Cassandra, and it was in verse; it began:—

'When nature first ordained my birth
A diminutive I was born on earth
And then I came from a dark abode
Into a gay and gaudy world.'

"So Bet brought her verses to me to correct; but I gave her half-a-crown, and she liked it as well. Bet had a fine spirit; she advertised for a husband, but she had no success, for she told me no man aspired to her. Then she hired very handsome lodgings and a footboy, and she got a harpsichord, but Bet could not play; however, she put herself in fine attitudes and drummed. And pray what became of her, Sir? Why, Madam, she stole a quilt from the man of the house, and he had her taken up; but Bet Flint had a spirit not to be subdued, so when she found herself obliged to go to gaol, she ordered a sedan chair, and bid her footboy walk before her. However, the footboy proved refractory, for he was ashamed, though his mistress was not. And did she ever get out of gaol, Sir? Yes, Madam, when she came to her trial, the judge acquitted her. 'So now,' she said to me, 'the quilt is my own, and now I'll make a petticoat of it.' Oh! I loved Bet Flint."

The subject is low enough to please Goldsmith. The humour may be of that mean order which has only a refreshing laugh, and gives tone to the feelings, but it is the pure spirit of humour.

We need not labour to demonstrate that a kindly appreciation of the ludicrous may find expression in art as well as in literature. But humour in art tends so inevitably to become caricature, which can be genial as well as ferocious, that the reader must be referred to the article on CARICATURE for an account of its manifestations in that field. (D. H.)

HUMPBAC WHALE (*Megaptera longimana* or *M. bôops*), the representative of a genus of whalebone whales distinguished by the great length of the flippers. This whale (or a closely



Humpback Whale (*Megaptera longimana* or *bôops*).

allied species) is found in nearly all seas; and when full-grown may reach from 45 ft. to 50 ft. in length, the flippers which are indented along their edges measuring from 10 ft. to 12 ft. or more. The general colour is black, but there are often white markings on the under surface; and the flippers may be entirely white, or parti-coloured like the body. Deep longitudinal furrows, folds or plaits occur on the throat and chest. It is said that the popular name refers to a prominence on which the back fin is set; but this "hump" varies greatly in size in different individuals. The humpback is a coast-whale, irregular in its movements, sometimes found in "schools," at others singly. The whalebone is short, broad and coarse; but the yield of oil from a single whale has been as much as 75 barrels. A few examples of this whale have been taken in Scotland and the north of England (see CETACEA).

HUMPERDINCK, ENGELBERT (1854-), German musical composer, was born at Siegburg, in the Rhine Province, and studied under F. Hiller at Cologne, and F. Lachner and J. Rheinberger at Munich. In 1879, by means of a scholarship, he went to Italy, where he met Wagner at Naples; and on the latter's invitation he went to Bayreuth and helped to produce *Parsifal* there next year. He travelled for the next few years in Italy and Spain but in 1890 became a professor at Frankfurt, where he remained till 1896. In 1900 he became the head of a school in Berlin. His fame as a composer was made by his charming children's opera *Hänsel und Gretel* in 1893, founded very largely (like his later operas) on folk-tunes; but his works

also include other forms of music, in all of which his mastery of technique is apparent.

HUMPHREY (or **HUMFREY**), **LAWRENCE** (1527?-1590), president of Magdalen College, Oxford, and dean successively of Gloucester and Winchester, was born at Newport Pagnel. He was elected demy of Magdalen College in 1546 and fellow in 1548. He graduated B.A. in 1549, M.A. in 1552, and B.D. and D.D. in 1562. He was noted as one of the most promising pupils of Peter Martyr, and on Mary's accession obtained leave from his college to travel abroad. He lived at Basel, Zurich, Frankfurt and Geneva, making the acquaintance of the leading Swiss divines, whose ecclesiastical views he adopted. His leave of absence having expired in 1556, he ceased to be fellow of Magdalen. He returned to England at Elizabeth's accession, was appointed regius professor of divinity at Oxford in 1560, and was recommended by Archbishop Parker and others for election as president of Magdalen. The fellows refused at first to elect so pronounced a reformer, but they yielded in 1561, and Humphrey gradually converted the college into a stronghold of Puritanism. In 1564 he and his friend Thomas Sampson, dean of Christ Church, were called before Parker for refusing to wear the prescribed ecclesiastical vestments; and a prolonged controversy broke out, in which Bullinger and other foreign theologians took part as well as most of the leading divines in England. In spite of Bullinger's advice, Humphrey refused to conform; and Parker wished to deprive him as well as Sampson. But the presidency of Magdalen was elective and the visitor of the college was not Parker but the bishop of Winchester; and Humphrey escaped with temporary retirement. Parker, in fact, was not supported by the council; in 1566 Humphrey was selected to preach at St Paul's Cross, and was allowed to do so without the vestments. In the same year he took a prominent part in the ceremonies connected with Elizabeth's visit to Oxford. On this occasion he wore his doctor's gown and habit, which the queen told him "became him very well"; and his resistance now began to weaken. He yielded on the point before 1571 when he was made dean of Gloucester. In 1578 he was one of the divines selected to attend a diet at Schmalkalde to discuss the project of a theological accommodation between the Lutheran and Reformed churches; and in 1580 he was made dean of Winchester. In 1585 he was persuaded by his bishop, Cooper, to restore the use of surplices in Magdalen College chapel. He died on the 1st of February 1590 and was buried in the college chapel, where there is a mural monument to his memory; a portrait is in Magdalen College school.

Humphrey was a voluminous writer on theological and other subjects. At Parker's desire he wrote a life of his friend and patron Bishop Jewel, which was published in 1573 and was also prefixed to the edition of Jewel's works issued in 1600. One of his books against the Jesuits was included in vol. iii. of the *Doctrina Jesuitarum per varios auctores*, published at La Rochelle (6 vols., 1585-1586).

See Bloxam's *Register of Magdalen College*, iv. 101-132; Cooper's *Athenae Cantabrigienses*; Wood's *Athenae Oxonienses*; Gough's *Index to Parker Soc. Publ.*; Strype's *Works: Col. State Papers* (Dom. 1547-1590); *Acts of the Privy Council*; Burnet's *Hist. Ref.*; Collier's *Eccles. Hist.*; Dixon's *Church Hist.* vol. vi.; *Dict. Nat. Biog.* (A. F. P.)

HUMPHREYS, ANDREW ATKINSON (1810-1883), American soldier and engineer, was born at Philadelphia on the 2nd of November 1810. He was the son of Samuel Humphreys (1778-1846), chief constructor U.S.N., and grandson of Joshua Humphreys (1751-1838), the designer of the "Constitution" and other famous frigates of the war of 1812, sometimes known as the "father of the American navy." Graduating from West Point in 1831, he served with the 2nd Artillery in the Florida war in 1835. He resigned soon afterwards and devoted himself to civil engineering. In 1838 he returned to the army for survey duties, and from 1842 to 1849 was assistant in charge of the Coast Survey Office. Later he did similar work in the valley of the Mississippi, and, with Lieut. H. L. Abbott, produced in 1861 a valuable *Report on the Physics and Hydraulics of the Mississippi River*. In connexion with this work he visited Europe in 1851.

In the earlier part of the Civil War Humphreys was employed as a topographical engineer with the Army of the Potomac, and rendered conspicuous services in the Seven Days' Battles. It is stated that he selected the famous position of Malvern Hill, before which Lee's army was defeated. Soon after this he was assigned to command a division of the V. corps, and at the battle of Fredericksburg he distinguished himself greatly in the last attack of Marye's heights. General Burnside recommended him for promotion to the rank of major-general U.S.V., which was not however awarded to Humphreys until after Gettysburg. He took part in the battle of Chancellorsville, and at Gettysburg commanded a division of the III. corps under Sickles. Upon Humphreys' division fell the brunt of Lee's attack on the second day, by which in the end the III. corps was dislodged from its advanced position. His handling of his division in this struggle excited great attention, and was compared to Sheridan's work at Stone river. A few days later he became chief of staff to General Meade, and this position he held throughout the Wilderness campaign. Towards the end of the war General Humphreys succeeded General Hancock in command of the famous II. corps. The short campaign of 1865, which terminated in Lee's surrender, afforded him a greater opportunity of showing his capacity for leadership. His corps played a conspicuous part in the final operations around Petersburg, and the credit of the vigorous and relentless pursuit of Lee's army may be claimed hardly less for Humphreys than for Sheridan. After the war, now brevet major-general, he returned to regular engineer duty as chief engineer of the U.S. army, and retired in 1879. He was a member of the American Philosophical Society (1857) and of the American Academy of Arts and Sciences (1863), and received the degree of LL.D. from Harvard University in 1868. He died at Washington on the 27th of December 1883. Amongst his works may be mentioned *From Gettysburg to the Rapidan* (1882) and *The Virginia Campaigns of 1864-1865* (1882).

See Wilson, *Critical Sketches of some Commanders* (Boston, 1895).

HUMPHRY, OZIAS (1742-1810), English miniature painter, was born at Honiton and educated at the Grammar School of that town. Attracted by the gallery of casts opened by the duke of Richmond, Humphry came to London and studied at Shipley's school; and later he left for Bath, where he lodged with Linley and became a great friend of his beautiful daughter, afterwards Mrs Sheridan. In 1766 he was in London warmly encouraged by Sir Joshua Reynolds, who was always interested in Devonshire painters. He was a great friend of Romney, with whom in 1773 he went to Italy, staying, on his way to Dover, at Knole, where the duke of Dorset gave him many commissions. In 1785 he went to India, visiting the native courts, painting a large number of miniatures, and making many beautiful sketches. His sight failed him in 1797, and he died in Hampstead in 1810. The bulk of his possessions came into the hands of his natural son, William Upcott, the book collector. From him the British Museum acquired a large number of papers relating to Humphry. He was Opie's first master, and is alluded to in some lines by Hayley. His miniatures are exquisite in detail and delightful in colouring. Many of the finest are in the collection of Mr J. Pierpont Morgan.

See *The History of Portrait Miniatures*, by G. C. Williamson, vol. ii. (London, 1904).

HUMUS (a Latin word meaning the ground), a product of decomposing organic matter. It is especially present in peat bogs, and also occurs in surface soils, to which it imparts a brown or black colour. It is one of the most important soil-constituents from the agricultural point of view; it is the chief source of nitrogenous food for plants, and modifies the properties of the soil by increasing its water-holding capacity and diminishing its tenacity. Little is known with regard to its chemical composition. By treating with a dilute acid to remove the bases present, and then acting on the residue with ammonia, a solution is obtained from which a mineral acid precipitates humic acid; the residue from the ammonia extraction is termed humin. Both the humic acid and humin are mixtures, and several constituents have been separated; ulmic acid and ulmin,

in addition to humic acid and humin, are perhaps the best characterized.

HUNALD, DUKE OF AQUITAINE, succeeded his father Odo, or Eudes, in 735. He refused to recognize the high authority of the Frankish mayor of the palace, Charles Martel, whereupon Charles marched south of the Loire, seized Bordeaux and Blaye, but eventually allowed Hunald to retain Aquitaine on condition that he should promise fidelity. From 736 to 741 the relations between Charles and Hunald seem to have remained amicable. But at Charles's death in 741 Hunald declared war against the Franks, crossed the Loire and burned Chartres. Menaced by Pippin and Carloman, Hunald begged for peace in 745 and retired to a monastery, probably on the Isle of Ré. We find him later in Italy, where he allied himself with the Lombards and was stoned to death. He had left the duchy of Aquitaine to Waifer, who was probably his son, and who struggled for eight years in defending his independence against King Pippin. At the death of Pippin and at the beginning of the reign of Charlemagne, there was a last rising of the Aquitanians. This revolt was directed by a certain Hunald, and was repressed in 768 by Charlemagne and his brother Carloman. Hunald sought refuge with the duke of the Gascons, Lupus, who handed him over to his enemies. In spite of the opinion of certain historians, this Hunald seems to have been a different person from the old duke of Aquitaine.

See J. Vaissette, *Histoire générale de Languedoc*, vol. i. (ed. of 1872 seq.); Th. Breysig, H. Hahn, L. Oelmer, S. Abel and B. Sisson, *Jahrbücher des deutschen Reichs*. (C. Pp.)

HU-NAN, a central province of China, bounded N. by Hu-peh, E. by Kiang-si, S. by Kwang-si and Kwang-tung, and W. by Kwei-chow and Szech'uen. It occupies an area of 84,000 sq. m., and its population is estimated at 22,000,000. The provincial capital is Chang-sha Fu, in addition to which it has eight prefectural cities. It is essentially a province of hills, the only considerable plain being that around the Tung-t'ing lake, but this extends little beyond the area which in summer forms part of the lake. To the north of Heng-chow Fu detached groups of higher mountains than are found in the southern portion of the province are met with. Among these is the Heng-shan, one of the Wu-yo or five sacred mountains of China, upon which the celebrated tablet of Yu was placed. The principal rivers of the province are: (1) The Siang-kiang, which takes its rise in the Nan-shan, and empties into the Tung-t'ing lake; it is navigable for a great distance from its mouth, and the area of its basin is 39,000 sq. m.; (2) the Tsze-kiang, the basin of which covers an area of 10,000 sq. m., and which is full of rapids and navigable only for the smallest boats; (3) the Yuen-kiang, a large river, which has some of its head-waters in the province of Kwei-chow, and empties into the Tung-t'ing lake in the neighbourhood of Chang-té Fu; its basin has an area of 35,000 sq. m., 22,500 of which are in the province of Hu-nan and 12,500 in that of Kwei-chow; its navigation is dangerous, and only small boats are able to pass beyond Hang-kia, a mart about 180 m. above Chang-té Fu; and (4) the Ling-kiang, which flows from the tea district of Ho-féng Chow to the Tung-t'ing lake. Its basin covers an area of about 8000 sq. m., and it is navigable only in its lowest portion. The principal places of commerce are: (1) Siang-t'an, on the Siang-kiang, said to contain 1,000,000 inhabitants, and to extend 3 m. long by nearly 2 m. deep; (2) Chang-sha Fu, the provincial capital which stands on the same river 60 m. above the treaty port of Yo-chow, and between which mart and Han-kow steamers of 500 tons burden run; and (3) Chang-té Fu, on the Yuen-kiang. The products of the province are tea (the best quality of which is grown at Gan-hwa and the greatest quantity at Ping-kiang), hemp, cotton, rice, paper, tobacco, tea-oil and coal. The whole of the south-eastern portion of the province is one vast coal-field, extending over an area of 21,700 sq. m. This area is divided into nearly two equal parts—one, the Lei river coal-fields, yielding anthracite, and the other the Siang river coal-fields, yielding bituminous coal. The people have been, as a rule, more anti-foreign in their ideas, and more generally prosperous than the

inhabitants of the other provinces. Baron von Richthofen noticed with surprise the number of fine country seats, owned by rich men who had retired from business, scattered over the rural districts. Almost all the traffic is conveyed through Hu-nan by water-ways, which lead northward to Han-kow on the Yangtze Kiang, and Fan-cheng on the Han River, eastward to Fu-kien, southward to Kwang-tung and Kwang-si and westward to Sze-ch'uen. One of the leading features of the province is the Tung-t'ing lake. Yo Chow, the treaty port of the province stands at the outlet of the river Siang into this lake.

HUNDRED, the English name of the cardinal number equal to ten times ten. The O. Eng. *hundred* is represented in other Teutonic languages; cf. Dutch *honderd*, Ger. *Hundert*, Dan. *hundrede*, &c. It is properly a compound, *hund-red*, the suffix meaning "reckoning"; the first part *hund* is the original Teutonic word for 100 which became obsolete in English in the 13th century. It represents the Indo-European form *hanta*, seen in Gr. *ἑκατόν*, Lat. *centum*, Sans. *catana*; *kanla* stands for *dakaula* and meant the tenth ten, and is therefore connected with Gr. *δέκα*, Lat. *decem* and Eng. "ten," the Teutonic form of Indo-European *dakan* being *tehan*, cf. Ger. *zehn*. In England the term "hundred" is particularly applied to an ancient territorial division intermediate between the *villa* and the county. Such subordinate districts were also known in different parts of the country by other names, e.g. *wapentakes* in Yorkshire, *linc* inshire, Nottinghamshire, Derbyshire, Rutland and Leicestershire; *wards* in Northumberland, Durham and Cumberland; while some of the hundreds of Cornwall were formerly called *shires*. In some parts of England a further intermediate division is to be found between the hundred and the county. Thus we have the *trithing*, or as it is now called the *riding*, in Yorkshire, the *lathe* in Kent, and the *rape* in Sussex. In Lincolnshire the arrangement is peculiar. The whole county was divided into the three sub-counties of Lindsey, Kesteven and Holland; and of these Lindsey was again divided into three ridings. The division into hundreds is generally ascribed to the creative genius of Alfred, who, according to William of Malmesbury, divided his kingdom into counties, the counties into hundreds, and the hundreds into tithings or *villae*. It is probable, however, that he merely rearranged existing administrative districts in that part of England which was subject to his rule. The significance of the name hundred is a matter of some difficulty. The old theory, and perhaps the best, is that the hundred denoted first a group of a hundred families, and then the district which these families occupied. This is not inconsistent with another view, according to which the hundred was originally a term of measurement denoting a hundred hides of land, for there is good reason for considering that the hide was originally as much land as supported one family. It is important to notice that in the document compiled before the Norman Conquest, and now known as the *County Hidage*, the number of hides in all the counties are multiples of a hundred, and that in many cases the multiples agree with the number of hundreds ascribed to a county in Domesday Book. The hundreds of Devon, however, seem never to have contained a hundred hides; but various multiples of five, such as twenty, forty and sixty. Here, and in some of the other western counties, the hundreds are geographical divisions, to which a varying number of hides was attributed for fiscal purposes.

In the middle ages the hundred was chiefly important for its court of justice; and the word *hundredum* was as often applied to the court as to the district over which the court had jurisdiction. According to the compilation known as *Leges Henrici*, written shortly before 1118, it was held twelve times a year, but an ordinance of 1234, after stating that it had been held fortnightly in the reign of Henry II., declares that its ordinary sessions were henceforth to take place every three weeks (*Dunstable Annals*, 139). Existing court rolls show that from the 13th to the 15th centuries it usually sat seventeen times a year, in some hundreds in a fixed place, in others in various places, but in no regular course of rotation. Twice a year a specially full court was held, to which various names such as

hundredum legale or *hundredum magnum* were applied. This was the sheriffs' turn held after Easter and Michaelmas in accordance with the Magna Carta of 1217. The chief object of these sessions was to see that all who ought to be were in the frank-pledge, and that the articles of the view of frank-pledge had been properly observed during the preceding half-year. Each township of the hundred was represented by a varying number of suitors who were bound to attend at these half-yearly sessions without individual summons. If the proper number failed to appear the whole township was amerced, the entry on the rolls being frequently of the form "*Villata de A. est in misericordia quia non venit plenarie*." All the seventeen courts, including the two full courts, had jurisdiction in trespass covenant and debt of less than forty shillings, and in these civil cases such of the freeholders of the county as were present were judges. But the sheriff or the lord of the hundred was the sole judge in the criminal business transacted at the full courts. A hundred court, especially in the west of England, was often appurtenant to the chief manor in the hundred, and passed with a grant of the manor without being expressly mentioned. In the 13th century a large number of hundreds had come into private hands by royal grant, and in Devonshire there was scarcely a hundred which still belonged to the king. In private hundreds the lord's steward took the place of the king's sheriff.

Owing to the great fall in the value of money the hundred court began to decay rapidly under the Tudor sovereigns. They were for the most part extinguished by a section in the County Courts Act 1867, which enacts that no action which can be brought in a county court shall thenceforth be brought in a hundred or other inferior court not being a court of record. Until lately the most important of the surviving duties of the hundred was its liability to make good damages occasioned by rioters. This liability was removed by the Riot (Damages) Act 1886, which threw the liability on the police rate.

See Pollock and Maitland, *History of English Law*; F. W. Maitland, *Domesday Book and Beyond* (1897); J. H. Round, *Feudal England* (1895); *Annales monastici*, "Rolls" series, iii. (Dunstable), 139; various court rolls at the Public Record Office, London. (G. J. T.)

HUNDRED DAYS (Fr. *Cent Jours*), the name commonly given to the period between the 20th of March 1815, the date on which Napoleon arrived in Paris after his return from Elba, and the 28th of June 1815, the date of the restoration of Louis XVIII. The phrase *Cent Jours* was first used by the prefect of Paris, the comte de Chabrol, in his speech welcoming the king. See NAPOLEON, and FRANCE: *History*.

HUNDRED YEARS' WAR. This name is given to the protracted conflict between France and England from 1337 to 1453, which continued through the reigns of the French kings Philip VI., John II., Charles V., Charles VI., Charles VII., and of the English kings Edward III., Richard II., Henry IV., Henry V. and Henry VI. The principal causes of the war, which broke out in Guienne in 1337, were the disputes arising in connexion with the French possessions of the English kings, in respect to which they were vassals of the kings of France; the pretensions of Edward III. to the French throne after the accession of Philip VI.; Philip's intervention in the affairs of Flanders and Scotland; and, finally, the machinations of Robert of Artois.

During Philip VI.'s reign fortune favoured the English. The French fleet was destroyed at Sluys on the 24th of June 1340. After the siege of Tournai a truce was arranged on the 25th of September 1340; but the next year the armies of England and France were again at war in Brittany on account of the rival pretensions of Charles of Blois and John of Montfort to the succession of that duchy. In 1346, while the French were trying to invade Guienne, Edward III. landed in Normandy, ravaged that province, part of the Ile de France and Picardy, defeated the French army at Crécy on the 26th of August 1346, and besieged Calais, which surrendered on the 3rd of August 1347. Hostilities were suspended for some years after this, in consequence of the truce of Calais concluded on the 28th of September 1347.

The principal feats of arms which mark the first years of John the Good's reign were the taking of St Jean d'Angély by the French in 1351, the defeat of the English near St Omer in 1352, and the English victory near Guines in the same year. In 1355 Edward III. invaded Artois while the Black Prince was pillaging Languedoc. In 1356 the battle of Poitiers (September 19), in which John was taken prisoner, was the signal for conflicts in Paris between Stephen Marcel and the dauphin, and for the outbreak of the Jacquerie. The treaty of Brétigny, concluded on the 8th of May 1360, procured France several years' repose.

Under Charles V. hostilities at first obtained only between French, Anglo-Navarrais (Du Guesclin's victory at Cocherel, May 16, 1364) and Bretons. In 1369, on the pretext that Edward III. had failed to observe the terms of the treaty of Brétigny, the king of France declared war against him. Du Guesclin, having been appointed Constable, defeated the English at Pontvallain in 1370, at Chizé in 1373, and drove them from their possessions between the Loire and the Gironde, while the duke of Anjou retook part of Guienne. Edward III. thereupon concluded the truce of Bruges (June 27, 1375), which was prolonged until the 24th of June 1377. Upon the death of Edward III. (June 21, 1377) Charles V. recommenced war in Artois and Guienne and against Charles the Bad, but failed in his attempt to reunite Brittany and France. Du Guesclin, who had refused to march against his compatriots, died on the 13th of July 1380, and Charles V. on the 16th of the following September.

In the beginning of Charles VI.'s reign the struggle between the two countries seemed to slacken. An attempt at reconciliation even took place on the marriage of Richard II. with Isabella of France, daughter of Charles VI. (September 26, 1396). But Richard, having been dethroned by Henry of Lancaster (Henry IV.), hostilities were resumed, Henry profiting little by the internal discords of France. In 1415 his son, Henry V., landed in Normandy on the expiry of the truce of the 25th of September 1413, which had been extended in 1414 and 1415. He won the victory of Agincourt (October 25, 1415), and then seized Caen and part of Normandy, while France was exhausting herself in the feuds of Armagnacs and Burgundians. By the treaty of Troyes (May 21, 1415) he obtained the hand of Catherine, Charles VI.'s daughter, with the titles of regent and heir to the kingdom of France. Having taken Meaux on the 2nd of May 1420, and made his entry into Paris on the 30th of May, he died on the 31st of August in the Bois de Vincennes, leaving the throne to his son, Henry VI., with the duke of Bedford as regent in France. Charles VI. died shortly afterwards, on the 21st of October.

His son, who styled himself Charles VII., suffered a series of defeats in the beginning of his reign: Cravant on the Yonne (1423), Verneuil (1424), St James de Beuvron (1426) and Rouvray (1429). Orleans, the last bulwark of royalty, had been besieged since the 12th of October 1428, and was on the point of surrender when Joan of Arc appeared. She saved Orleans (May 8, 1429), defeated the English at Patay on the 16th of June, had Charles VII. crowned at Reims on the 17th of July, was taken at Compiègne on the 24th of May 1430, and was burned at Rouen on the 30th of May 1431 (see JOAN OF ARC). From this time on the English lost ground steadily, and the treaty of Arras (March 20, 1435), by which good relations were established between Charles VII. and Philip the Good, duke of Burgundy, dealt them a final blow. Normandy rose against them, while the constable De Richemont¹ drove them from Paris (1436) and retook Nemours, Montereau (1437) and Meaux (1439). The quickly repressed revolt of the Praguerie made no break in Charles VII.'s successes. In 1442 he relieved successively Saint Sever, Dax, Marmande, La Réole, and in 1444 Henry VI. had to conclude the truce of Tours. In 1448 the English were driven from Mans; and in 1449, while Richemont was capturing Cotentin and Fougères, Dunois conquered Lower Normandy and Charles VII. entered Rouen. The defeat of Sir Thomas Kyriel, one of Bedford's veteran captains, at Formigny in 1450, and the taking of Cherbourg, completed the conquest of the

¹ Arthur, earl of Richmond, afterwards Arthur III., duke of Brittany.

province. During this time Dunois in Guienne was taking Bordeaux and Bayonne. Guienne revolted against France, whereupon Talbot returned there with an army of 5000 men, but was vanquished and killed at Castillon on the 17th of July 1453. Bordeaux capitulated on the 6th of October, and the Hundred Years' War was terminated by the expulsion of the English, who were by this time so fully occupied with the Wars of the Roses as to be unable to take the offensive against France anew.

AUTHORITIES.—The chronicles of Jean le Bel, Adam Murimuth, Robert of Avesbury, Froissart and "Le Religieux de Saint Denis." See Simón Luce, *Hist. de Bertrand du Guesclin* (3rd ed., Paris, 1896); G. du Fresne de Beaucourt, *Hist. de Charles VII* (6 vols., Paris, 1881-1891); F. J. Snell, articles in the *United Service Magazine* (1906-1907).

HUNGARY (Hungarian *Magyarország*), a country in the south-eastern portion of central Europe, bounded E. by Austria (Bukovina) and Rumania; S. by Rumania, Servia, Bosnia and Austria (Dalmatia); W. by Austria (Istria, Carniola, Styria and Lower Austria); and N. by Austria (Moravia, Silesia and Galicia). It has an area of 125,402 sq. m., being thus about 4000 sq. m. larger than Great Britain and Ireland.

I. GEOGRAPHY AND STATISTICS

The kingdom of Hungary (*Magyarbirtalom*) is one of the two states which constitute the monarchy of Austria-Hungary (*q.v.*), and occupies 51.8% of the total area of the monarchy. Hungary, unlike Austria, presents a remarkable geographical unity. It is almost exclusively continental, having only a short extent of seaboard on the Adriatic (a little less than 100 m.). Its land-frontiers are for the most part well defined by natural boundaries: on the N.W., N., E. and S.E. the Carpathian mountains; on the S. the Danube, Save and Unna. On the W. they are not so clearly marked, being formed partly by low ranges of mountains and partly by the rivers March and Leitha. From the last-mentioned river are derived the terms Cisleithania and Transleithania, applied to Austria and Hungary respectively.

General Division.—The kingdom of Hungary in its widest extent, or the "Realm of the Crown of St Stephen," comprises Hungary proper (*Magyarország*), with which is included the former grand principality of Transylvania, and the province of Croatia-Slavonia. This province enjoys to a large extent autonomy, granted by the so-called compromise of 1868. The town and district of Fiume, though united with Hungary proper in respect of administration, possess a larger measure of autonomy than the other cities endowed with municipal rights. Of the total area of the kingdom Hungary proper has 108,082 sq. m. and Croatia-Slavonia 16,420 sq. m. In the present article the kingdom is treated mainly as a whole, especially as regards statistics. In some respects Hungary proper has been particularly dealt with, while special information regarding the other regions will be found under CROATIA-SLAVONIA, TRANSYLVANIA and FIUME.

Mountains.—Orographically Hungary is composed of an extensive central plain surrounded by high mountains. These mountains belong to the Carpathians and the Alps, which are separated by the valley of the Danube. But by far the greater portion of the Hungarian highlands belongs to the Carpathian mountains, which begin, to the north, on the left bank of the Danube at Debrecen near Presburg (Pozsony), run in a north-easterly and easterly direction, sway round south-eastward and then westward in a vast irregular semicircle, and end near Orsova at the Iron Gates of the Danube, where they meet the Balkan mountains. The greatest elevations are in the Tatra mountains of the north of Hungary proper, in the east and south of Transylvania (the Transylvanian Alps) and in the eastern portion of the Banat. The highest peak, the Gerlsdorf or Spitz or Gerlachfalva, situated in the Tatra group, has an altitude of 8700 ft. The portion of Hungary situated on the right bank of the Danube is filled by the Alpine system, namely, the eastern outlying groups of the Alps. These groups are the Leitha mountains, the Styrian highlands, the Lower Hungarian highlands, which are a continuation of the former, and the Bakony Forest. The Bakony Forest, which lies entirely within Hungarian territory, extends to the Danube in the neighbourhood of Budapest, the highest peak being Köröshegy (2320 ft.). The south-western portion of this range is specially called Bakony Forest, while the ramifications to the north-east are known as the Vértes group (1575 ft.), and the Pilis group (2476 ft.). The Lower Hungarian highlands extend between the Danube, the Mur, and Lake Balaton, and attain in the

Mecek hills near Mohács and Pécs an altitude of 2200 ft. The province of Croatia-Slavonia belongs mostly to the Karst region, and is traversed by the Dinaric Alps.

Plains.—The mountain systems enclose two extensive plains, the smaller of which, called the "Little Hungarian Alfold" or "Pressburg Basin," covers an area of about 6000 sq. m., and lies to the west of the Bakony and Mátra ranges, which separate it from the "Pest Basin" or "Great Hungarian Alfold." This is the largest plain in Europe, and covers about 37,000 sq. m., with an average elevation above sea-level of from 300 to 350 ft. The Pest Basin extends over the greater portion of central and southern Hungary, and is traversed by the Theiss (Tisza) and its numerous tributaries. This immense tract of low land, though in some parts covered with barren wastes of sand, alternating with marshes, presents in general a very rich and productive soil. The monotonous aspect of the Alfold is in summer time varied by the *déli-bód*, or *Fata Morgana*.

Caverns.—The numerous caverns deserve a passing notice. The Aggtelek (q.v.) or Barada cave, in the county of Gömör, is one of the largest in the world. In it various fossil mammalian remains have been found. The Fönácza cave, in the county of Bihar, has also yielded fossils. No less remarkable are the Okno, Vodi and Deményfalva caverns in the county of Liptó, the Veterani in the Banat and the ice cave at Dobosina (q.v.) in Gömör county. Of the many interesting caverns in Transylvania the most remarkable are the sulphurous Búdás in the county of Haromszék, the Almás to the south of Udvarhely and the brook-traversed rocky caverns of Csetate-Bali, Pestere and Fonor in the southern mountains of Hunyad county.

Rivers.—The greater part of Hungary is well provided with both rivers and springs, but some trachytic and limestone mountainous districts show a marked deficiency in this respect. The Mátra group, e.g., is poorly supplied, while the outliers of the Vértes mountains towards the Danube are almost entirely wanting in streams, and have but few water sources. A relative scarcity in running waters prevails in the whole region betw. the Danube and the Drave. The greatest proportionate deficiency, however, is observable in the arenaceous region between the Danube and Theiss, where for the most part only periodical floods occur. But in the north and east of the kingdom rivers are numerous. Owing to its orographical configuration the river system of Hungary presents several characteristic features. The first consists in the parallelism in the course of its rivers, as the Danube and the Theiss, the Drave and the Save, the Waag with the Neutra and the Gran, &c. The second is the direction of the rivers, which converge towards the middle of the country, and are collected either mediately or immediately by the Danube. Only the Zail, the Aluta and the Bodza or Buzeu pierce the Transylvanian Alps, and flow into the Danube outside Hungary. Another characteristic feature is the uneven distribution of the navigable rivers, of which Upper Hungary and Transylvania are almost completely devoid. But even the navigable rivers, owing to the direction of their course, are not available as a means of external communication. The only river communication with foreign countries is furnished by the Danube, on the one hand towards Austria and Germany, and on the other towards the Black Sea. All the rivers belong to the watershed of the Danube, with the exception of the Poprád in the north, which as an affluent of the Dunajec flows into the Vistula, and of a few small streams near the Adriatic. The Danube enters Hungary through the narrow defile called the *Porta Hungarica* at Dévény near Pressburg, and after a course of 585 m. leaves it at Orsova by another narrow defile, the Iron Gate. Where it enters Hungary the Danube is 400 ft. above sea-level, and where it leaves it is 127 ft.; it has thus a fall within the country of 273 ft. It forms several large islands, as the Great Schütt, called in Hungarian Czallóköz or the deceiving island, with an area of nearly 1000 sq. m.; the St Andrew's or Szent-Endre island; the Csepel island; and the Margitta island. The principal tributaries of the Danube in Hungary, of which some are amongst the largest rivers in Europe, are, on the right, the Raab, Drave and Save, and, on the left, the Waag, Neutra, Gran, Eipel, Theiss (the principal affluent, which receives numerous tributaries), Temes and Cerna. The total length of the river system of Hungary is about 8800 m., of which only about one-third is navigable, while of the navigable part only one-half is available for steamers. The Danube is navigable for steamers throughout the whole of its course in Hungary. Regulating works have been undertaken to ward off the dangers of periodical inundations, which occur in the valley of the Danube and of the other great rivers, as the Theiss, the Drave and the Save. The beds of these rivers, as well as that of the Danube, are continually changing, forming morasses and pools, and rendering the country near their banks marshy. Notwithstanding the work already done, such as canalizing and regulating the rivers, the erection of dams, &c., the problems of preventing inundations, and of reclaiming the marshes, have not yet been satisfactorily solved.

Canals.—Hungary is poorly supplied with canals. They are constructed not only as navigable waterways, but also to relieve the rivers from periodical overflow, and to drain the marshy districts. The most important canal is the Franz Josef canal between Bécs and Bezán, above Zombor. It is about 70 m. in length, and

considerably shortens the passage between the Theiss and the Danube. A branch of this canal called Új Castorna or New Channel, extends from Kis-Szappár, a few miles below Zombor, to Ujvidék, opposite Petervárad. The Béga canal runs from Temesvár to Nagy-Beskerék, and thence to Titel, where it flows into the Theiss. The Versez and the Berzava canal, which are connected with one another, drain the numerous marshes of the Banat, including the Alibunar marsh. The Berzava canal ends in the river Temes. The Sió and the Kapos or Zichy canal between Lake Balaton and the Danube is joined by the Sárviz canal, which drains the marshes south of Sopron. The Berettyó canal between the Körös and the Berettyó rivers, and the Körös canal along the White Körös were constructed in conjunction with the regulation of the Theiss, and for the drainage of the marshy region.

Lakes and Marshes.—Hungary has two large lakes, Balaton (q.v.) or Platten-See, the largest lake of southern Europe, and Fertő or Neusiedler See. The Fertő lake lies in the counties of Moson and Sopron, not far from the town of Sopron, and is about 23 m. in length by 6 to 8 m. in breadth. It is so shallow that it completely evaporated in 1865, but has filled again since 1870, at the same time changing its configuration. It lies in the marshy district known as the Hanság, through which it is in communication with the Danube. In the neighbourhood of this lake are very good vineyards. Several other small lakes are found in the Hanság. The other lowland lakes, as, for instance, the Palics near Szabadka, and the Velencez in the county of Fehér, are much smaller. In the deep hollows between the peaks of the Carpathians are many small lakes, popularly called "eyes of the sea." In the *puszta* are numerous small lakes, named generally *Fehér Tó* or White Lakes, because they evaporate in the summer leaving a white crust of soda on their bed. The vegetation around them contains plants characteristic of the sea shores. The largest of these lakes is the Fehér Tó situated to the north of Szeged.

As already mentioned large tracts of land on the banks of the principal rivers are occupied by marshes. Besides the Hanság, the other principal marshes are the Sárét, which covers a considerable portion of the counties of Jász-Kun-Szolnok, Békés and Bihar; the Escedi Láp in the county of Szatmár; the Sertye near Munkács, and the Alibunár in the county of Torontál. Since the last half of the 19th century many thousands of acres have been reclaimed for agricultural purposes.

Geology.—The hilly regions of Transylvania and of the northern part of Hungary consist of Palaeozoic and Mesozoic rocks and are closely connected, both in structure and origin, with the Carpathian chain. The great Hungarian plain is covered by Tertiary and Quaternary deposits, through which rise the Bakony-wald and the Mecsek ridge near Pécs (Fünfkirchen). These are composed chiefly of Triassic beds, but Jurassic and Cretaceous beds take some share in their formation. Amongst the most interesting features of the Bakony-wald are the volcanic and the igneous rocks.

The great plain itself is covered for the most part by loess and alluvium, but near its borders the Tertiary deposits rise to the surface. Eocene nummulitic beds occur, but the deposits are mostly of Miocene age. Five subdivisions may be recognised in the Miocene deposits, corresponding with five different stages in the evolution of southern Europe. The first is the *First Mediterranean stage* of E. Suess, during which the Hungarian plain was covered by the sea, and the deposits were purely marine. The next is the *Schlier*, a peculiar blue-grey clay, widely spread over southern Europe, and contains extensive deposits of salt and gypsum. During the formation of the Schlier the plain was covered by an inland sea or series of salt lakes, in which evaporation led to the concentration and finally to the deposition of the salts contained in the water. Towards the close of this period great earth movements took place and the gap between the Alps and the Carpathians was formed. The third period is represented by the *Second Mediterranean stage* of Suess, during which the sea again entered the Hungarian plain and formed true marine deposits. This was followed by the *Sarmatian period*, when Hungary was covered by extensive lagoons, the fauna being partly marine and partly brackish water. Finally, in the *Position period*, the lagoons became gradually less and less salt, and the deposits are characterized especially by the abundance of shells which live in brackish water, especially *Congeria*.

Climate.—Hungary has a continental climate—cold in winter, hot in summer—but owing to the physical configuration of the country it varies considerably. If Transylvania be excepted, three separate zones are roughly distinguishable: the "highland," comprising the counties in the vicinity of the Northern and Eastern Carpathians, where the winters are very severe and continue for half the year; the "intermediate" zone, embracing the country stretching northwards from the Drave and Mur, with the Little Hungarian Plain, and the region of the Upper Alfold, extending from Budapest to Nyiregyháza and Sárospatak; and the "great lowland" zone, including the main portion of the Great Hungarian Plain, and the region of the lower Danube, where the heat during the summer months is almost tropical. In Transylvania the climate bears the extreme characteristics peculiar to mountainous countries interspersed with valleys; whilst the climate of the districts bordering on the Adriatic is modified by the neighbourhood of the sea. The minimum of the temperature is attained in January and the

maximum in July. The rainfall in Hungary, except in the mountainous regions, is small in comparison with that of Austria. In these regions the greatest fall is during the summer, though in some years the autumn showers are heavier. Hail storms are of frequent occurrence in the Carpathians. On the plains rain rarely falls during the heats of summer; and the showers though violent are generally of short duration, whilst the moisture is quickly evaporated owing to the aridity of the atmosphere. The vast sandy wastes mainly contribute to the dryness of the winds on the Great Hungarian Allföld. Occasionally, the whole country suffers much from drought; but disastrous floods not infrequently occur, particularly in the spring, when the beds of the rivers are inadequate to contain the increased volume of water caused by the rapid melting of the snows on the Carpathians. On the whole Hungary is a healthy country, excepting in the marshy tracts, where intermittent fever and diphtheria sometimes occur with great virulence.

The following table gives the mean temperature, relative humidity, and rainfall (including snow) at a series of meteorological stations during the years 1896-1900:—

Stations.	Feet above Sea.	Mean Temperature (Fahrenheit).			Relative Humidity.	Rainfall in Inches.
		Annual.	Jan.	July.		
Selmeczbánya . . .	2037	46.2	27.9	64.8	79	33.29
Budapest	502	50.9	30.9	68.8	76	24.02
Kezsthely	436	52.5	30.0	71.4	78	26.67
Zágráb	534	52.3	34.3	70.5	72	34.32
Fiume	16	56.9	43.6	72.7	75	70.39
Debreczen	423	50.2	28.6	70	79	22.26
Szeged	312	51.6	31.1	71.1	80	25.58
Nagyszében	1357	48.9	25.9	69.1	79	28.66

Fauna.—The horned cattle of Hungary are amongst the finest in Europe, and large herds of swine are reared in the oak forests. The wild animals are bears, wolves, foxes, lynxes, wild cats, badgers, otters, martens, stoats and weasels. Among the rodents there are hares, marmots, beavers, squirrels, rats and mice, the last in enormous swarms. Of the larger game the chamois and deer are specially noticeable. Among the birds are the vulture, eagle, falcon, buzzard, kite, lark, nightingale, heron, stork and bustard. Domestic and wild fowl are generally abundant. The rivers and lakes yield enormous quantities of fish, and leeches also are plentiful. The Theiss, once better supplied with fish than any other river in Europe, has for many years fallen off in its productiveness. The culture of the silkworm is chiefly carried on in the south, and in Croatia-Slavonia.

Flora.—Almost every description of grain is found, especially wheat and maize, besides Turkish pepper or paprika, rape-seed, hemp and flax, beans, potatoes and root crops. Fruits of various descriptions, and more particularly melons and stone fruits, are abundant. In the southern districts almonds, figs, rice and olives are grown. Amongst the forest and other trees are the oak, which yields large quantities of galls, the beech, fir, pine, ash and alder, also the chestnut, walnut and filbert. The vine is cultivated over the greater part of Hungary, the chief grape-growing districts being those of the Hegyalja (Tokaj), Sopron, and Ruszt, Ménes, Somlyó (Schomlau), Bélye and Villány, Balaton, Nezmély, Visonta, Eger (Erlau) and Buda. Hungary is one of the greatest wine-producing countries in Europe, and the quality of some of the vintages, especially that of Tokaj, is unsurpassed. A great quantity of tobacco is also grown; it is wholly monopolized by the crown. In Hungary proper and in Croatia and Slavonia there are many species of indigenous plants, which are unrepresented in Transylvania. Besides 12 species peculiar to the former grand-principality, 14 occur only there and in Siberia.

Population.—Hungary had in 1900 a population of 19,254,559, equivalent to 153.7 inhabitants per square mile. The great Allföld and the western districts are the most densely populated parts, whereas the northern and eastern mountainous counties are sparsely inhabited. As regards sex, for every 1000 men there were 1011 women in Hungary, and 998 women in Croatia-Slavonia. The excess of females over males is great in the western and northern counties, while in the eastern parts and in Croatia-Slavonia there is a slight preponderance of males.

The population of the country at the censuses of 1880, 1890 and 1900 was:—

	1880.	1890.	1900.
Hungary proper	13,749,603	15,261,864	16,838,255
Croatia-Slavonia	1,892,499	2,201,927	2,416,304
Total	15,642,102	17,463,791	19,254,559

From 1870 to 1880 there was little increase of population, owing to the great cholera epidemic of 1872-1873, and to many epidemic diseases among children towards the end of the period. More normal conditions having prevailed from 1880 to 1890, the yearly increase rose from 0.13% to 1.09%, declining in the decade 1890-1900 to 1.03.

If compared with the first general census of the country, decreed by Joseph II. in 1785, the population of the kingdom shows an increase of nearly 108% during these 116 years. Recent historical research has ascertained that the country was densely peopled in the 15th century. Estimates, based on a census of the tax-paying peasantry in the years 1494 and 1495, give five millions of inhabitants, a very respectable number, which explains fully the predominant position of Hungary in the east of Europe at that epoch. The disastrous invasion of the Turks, incessant civil wars and devastation by foreign armies and pestilence, caused a very heavy loss both of population and of prosperity. In 1715 and 1720, when the land was again free from Turkish hordes and peace was restored, the population did not exceed three millions. Then immigration began to fill the deserted plains once more, and by 1785 the population had trebled itself. But as the immigrants were of very different foreign nationalities, the country became a collection of heterogeneous ethnical elements, amid which the ruling Magyar race formed only a minority.

The most serious drain on the population is caused by emigration, due partly to the grinding poverty of the mass of the peasants, partly to the resentment of the subject races against the process of "Magyarization" to which they have long been subjected by the government. This movement reached its height in 1900, when 178,170 people left the country; in 1906 the number had sunk to 169,202, of whom 47,920 were women.¹ Altogether, since 1896 Hungary has lost about a million of its inhabitants through this cause, a serious source of weakness in a sparsely populated country; in 1907 an attempt was made by the Hungarian parliament to restrict emigration by law. The flow of emigration is mainly to the United States, and a certain number of the emigrants return (27,612 in 1906) bringing with them much wealth, and Americanized views which have a considerable effect on the political situation.² Of political importance also is the steady immigration of Magyar peasants and workmen into Croatia-Slavonia, where they become rapidly absorbed into the Croat population. From the Transylvanian counties there is an emigration to Rumania and the Balkan territories of 4000 or 5000 persons yearly.

This great emigration movement is the more serious in view of the very slow increase of the population through excess of births over deaths. The birth-rate is indeed high (40.2 in 1897), but with the spread of culture it is tending to decline (38.4 in 1902), and its effect is counteracted largely by the appalling death-rate, which exceeds that of any other European country except Russia.

In this respect, however, matters are improving, the death-rate sinking from 33.1 per thousand in 1881-1885 to 28.1 per thousand in 1896-1900. The improvement, which is mainly due to better sanitation and the draining of the pestilential marshes, is most conspicuous in the case of Hungary proper, which shows the following figures: 33.3 per thousand in 1881-1885, and 27.8 per thousand in 1896-1900.

At the census of 1900 fifteen towns had more than 40,000 inhabitants, namely: Budapest, 732,322; Szeged 109,270; Szabadka (Maria-Theresiopel), 81,464; Debreczen, 72,351; Pozsony (Pressburg), 61,537; Hódmező-Vásárhely, 60,824; Zágráb (Agram), 61,002; Kecskemét, 56,786; Arad, 53,993; Temesvár, 53,023; Nagyvárad (Grosswardein), 47,018; Kolozsvár (Klausenburg), 46,670; Pécs (Fünfkirchen), 42,252; Miskolcz, 40,833; Kassa, 35,856.

The number and aggregate population of all towns and boroughs in Hungary proper having in 1890 more than 10,000 inhabitants was at the censuses of 1880, 1890 and 1900:—

Census.	Towns.	Inhabitants.	Percentage of Total Population.
1880	93	2,191,878	15.94
1890	106	2,700,852	17.81
1900	122	3,525,377	21.58

Thus the relative increase of the population living in urban districts of more than 10,000 inhabitants amounted in 1900 to nearly 4% of the total population. In Croatia-Slavonia only 5.62% of the population was concentrated in such towns in 1900.

Races.—One of the prominent features of Hungary being the great complexity of the races residing in it (see map, "Distribution of

¹ See the table in Seton-Watson's *Racial Problems in Hungary*, Appendix xiii, p. 470, and Drage, *Austria-Hungary*, p. 269. Of the emigrants in 1906, 52,121 were Magyars, 32,904 Slovaks, 30,551 Germans, 20,859 Rumanians and 16,016 Croats.

² *Racial Problems*, p. 202.

Races," in the article AUSTRIA), the census returns of 1880, 1890 and 1900, exhibiting the numerical strength of the different nationalities, are of great interest. Classifying the population according to the mother-tongue of each individual, there were, in the civil population of Hungary proper, including Fiume:—

Census.	Hungarians (<i>Magyars</i>).	Germans (<i>Mágnak</i>).	Slovaks (<i>Szék</i>).	Rumanians (<i>Oldak</i>).	Ruthenians (<i>Rutének</i>).	Croatians (<i>Horvát</i>).	Serbian (<i>Szegrb</i>).	Others.
1880	6,404,070	1,870,772	1,855,451	2,403,041	353,229	639,986		223,054
1890	7,357,936	1,990,084	1,896,665	2,580,079	379,786	194,412	495,133	259,803
1900	8,388,834	1,980,423	1,991,402	2,784,726	423,159	188,552	434,641	329,837
i.e. in percentages of the total population:								
1880	46.58	13.61	13.49	17.48	2.57	4.65		1.62
1890	48.53	13.12	12.51	17.08	2.50	1.28	3.27	1.71
1900	51.38	11.88	11.88	16.62	2.52	1.17	2.60	1.95

The censuses show a decided tendency of change in favour of the dominating nationality, the Magyar, which reached an absolute majority in the decade 1890-1900. This is also shown by the data relating to the percentage of members of other Hungarian races speaking this language. Thus in 1900 out of a total civil population of 8,132,740, whose mother-tongue is not Magyar, 1,365,763 could speak Magyar. This represents a percentage of 16.8, while in 1890 the percentage was only 13.8. In Croatia-Slavonia the language of instruction and administration being exclusively Croat, the other races tend to be absorbed in this nationality. The Magyars formed but 3.8%, the Germans 5.6% of the population according to the census of 1900.

The various races of Hungary are distributed either in compact ethnographical groups, in larger or smaller colonies surrounded by other nationalities, or—e.g. in the Banat—so intermingled as to defy exact definition.¹ The Magyars occupy almost exclusively the great central plain intersected by the Danube and the Theiss, being in an overwhelming majority in 19 counties (99.7% in Hajdu, east of the Theiss). With these may be grouped the kindred population of the three Szekel counties of Transylvania. In 14 other counties, on the linguistic frontier, they are either in a small majority or a considerable minority (61.6% in Szatmár, 18.9% in Torontál). The Germans differ from the other Hungarian races in that, save in the counties on the borders of Lower Austria and Styria, where they form a compact population in touch with their kin across the frontier, they are scattered in racial islets throughout the country. Excluding the above counties these settlements form three groups: (1) central and northern Hungary, where they form considerable minorities in seven counties (25% in Szepes, 7% in Komárom); (2) the Swabians of southern Hungary, also fairly numerous in seven counties (35.5% in Baranya, 32.9% in Temes, 10.5% in Arad); (3) the Saxons of Transylvania, in a considerable minority in five counties (42.7% in Nagy Küküllő, 17.6% in Kis Küküllő). The Germans are most numerous in the towns, and tend to become absorbed in the Magyar population. The Slavs, the most numerous race after the Magyars, are divided into several groups: the Slovaks, mainly massed in the mountainous districts of northern Hungary; the Ruthenians, established mainly on the slopes of the Carpathians between Poprád and Máramaros Sziget; the Serbs, settled in the south of Hungary from the bend of the Danube eastwards across the Theiss into the Banat; the Croats, overwhelmingly preponderant in Croatia-Slavonia, with outlying settlements in the counties of Zala, Vas and Sopron along the Croatian and Styrian frontier. Of these the Slovaks are the most important, having an overwhelming majority in seven counties (94.7% in Árva, 66.1% in Sáros), a bare majority in three (Szepes, Bars and Pozosdy) and a considerable minority in five (40.6% in Gömör, 22.9% in Abauj-Torna). The Ruthenians are not in a majority in any county, but in four they form a minority of from 36 to 46% (Máramaros, Bereg, Ugocsa, Ung) and in three others (Sáros, Zemplén, Szepes) a minority of from 8.2 to 19.7%. The Serbs form considerable minorities in the counties of Torontál (31.2%), Bács-Bodrog (19.0%) and Temes (21.4%). Next to the Slav races in importance are the Rumanians (Vlachs), who are in an immense majority in ten of the eastern and south-eastern counties (90.2% in Fogaras), in eight others form from 30 to 60% of the population, and in two (Máramaros and Torontál) a respectable minority.²

The Jews in 1900 numbered 851,378, not counting the very great number who have become Christians, who are reckoned as Magyars. Their importance is out of all proportion to their number, since they monopolize a large portion of the trade, are with the Germans the chief employers of labour, and control not only the finances but

to a great extent the government and press of the country. Owing to the improvidence of the Hungarian landowners and the poverty of the peasants the soil of the country is also gradually passing into their hands.³

The Gipsies, according to the special census of 1893, numbered 274,940. Of these, however, only 82,000 gave Romany as their language, while 104,000 described themselves as Magyars and 67,000 as Rumanians. They are scattered in small colonies, especially in Gömör county and in Transylvania. Only some 9000 are still nomads, while some 20,000 more are semi-nomads. Other races, which are not numerous, are Armenians, Greeks, Bulgars, Albanians and Italians.

The ethnographical map of Hungary does much to explain the political problems of the country. The central plains, which have the most fertile soil, and from the geographical conditions of the country form its centre of gravity, are occupied almost exclusively by the Magyars, the most numerous and the dominant race. But all round these, as far as the frontiers, the country is inhabited by the other races, which, as a rule, occupy it in large, compact and uniform ethnographical groups. The only exception is formed by the Banat, where Magyars, Rumanians, Serbs, Bulgarians, Croats and Germans live mixed together. Another important fact is that these races are all in direct contact with kindred peoples living outside Hungary: the Rumanians in Transylvania and Banat with those in Rumania and Bukovina; the Serbs and Croats with those on the other bank of the Danube, the Save and the Unna; the Germans in western Hungary with those in Upper Austria and Styria; the Slovaks in northern Hungary with those in Moravia; and lastly the Ruthenians with the Ruthenians of Galicia, who occupy the opposite slopes of the Carpathians. The centrifugal forces within the Hungarian kingdom are thus increased by the attraction of kindred nationalities established beyond its borders, a fact which is of special importance in considering the vexed and difficult racial problem in Hungary.

Agriculture.—Hungary is pre-eminently an agricultural country and one of the principal wheat-growing regions of Europe. At the census of 1900 nearly 69% of the total population of the country derived their income from agriculture, forestry, horticulture and other agricultural pursuits. The agricultural census taken in 1895 shows the great progress made in agriculture by Hungary, manifested by the increase in arable lands and the growth of the average production. The increase of the arable land has been effected partly by the reclamation of the marshes, but mostly by the transformation of large tracts of *puszta* (waste prairie land) into arable land. This latter process is growing every year, and is coupled with great improvements in agricultural methods, such as more intensive cultivation, the use of the most modern implements and the application of scientific discoveries. According to the agricultural census of 1895, the main varieties of land are distributed as follows:—

	Hungary Proper.	Croatia- Slavonia.
By area in acres—		
Arable land	29,714,382	13,370,540
Gardens	928,053	136,354
Meadows	7,075,888	1,099,451
Vineyards	482,801	65,475
Pastures	9,042,267	1,465,930
Forests	18,464,396	3,734,094
Marshes	199,685	7,921
By percentage of the total area—		
Arable land	42.81	32.26
Gardens	1.34	1.31
Meadows	10.19	10.52
Vineyards	0.69	0.63
Pastures	13.03	14.03
Forests	26.60	35.74
Marshes	0.28	0.08

The remainder, such as barren territory, devastated vineyards, water and area of buildings, amounts to 5.1% of the total.

The chief agricultural products of Hungary are wheat, rye, barley, oats and maize, the acreage and produce of which are shown in the following tables:—

¹ The colouring of ordinary ethnographical maps is necessarily somewhat misleading. When an attempt is made to represent in colour the actual distribution of the races (as in Dr Chavanne's *Geographischer und statistischer Handatlas*) the effect is that of occasional blotches of solid colour on a piece of shot silk.

² The distribution of the races is analysed in greater detail in Mr Seton-Watson's *Racial Problems*, p. 3 seq.

³ Seton-Watson, *op. cit.* pp. 173, 188, 252; Drage, *Austria-Hungary*, pp. 280, 588; Gonnard, *La Hongrie*, p. 72.

Area in Acres in Hungary Proper.

Cereal.	Average per Annum.			1900.	1907.
	1881-85.	1886-90.	1891-95.		
Wheat . .	6,483,876	7,014,891	7,551,584	8,142,303	8,773,440
Rye . . .	2,475,301	2,727,078	2,510,093	2,546,738	2,529,350
Barley . .	2,420,393	2,491,422	2,407,469	2,485,117	2,885,160
Oats . . .	2,460,080	2,546,582	2,339,297	2,324,992	2,808,780
Maize . . .	4,567,186	4,681,376	5,222,538	5,469,050	7,017,270

Produce in Millions of Bushels.

Cereal.	Average per Annum.			1900.	1907.
	1881-85.	1886-90.	1891-95.		
Wheat . .	99.8	121.3	144.9	137.3	128.5
Rye . . .	41.8	42.1	45.5	39.2	38.0
Barley . .	46.2	43.7	53.6	49.7	51.0
Oats . . .	53.9	52.3	64.9	63.6	43.7
Maize . . .	92.4	86.4	118.0	121.7	158.7

In Croatia-Slavonia no crop statistics were compiled before 1885. Subsequent returns for maize and wheat show an increase both in the area cultivated and quantity yielded. The former is the principal product of this province. Certain districts are distinguished for particular kinds of fruit, which form an important article of commerce both for inland consumption and for export. The principal of these fruits are apricots round Keszthely, cherries round Kőrös, melons in the Alföld and plums in Croatia-Slavonia. The vineyards of Hungary, which have suffered greatly by the phylloxera since 1881, show since 1900 a tendency to recover ground, and their area is again slowly increasing.

Forests.—Of the productive area of Hungary 26.6% is occupied by forests, which for the most part cover the slopes of the Carpathians. Nearly half of them belong to the state, and in them forestry has been carried out on a scientific basis since 1879. The exploitation of this great source of wealth is still hindered by want of proper means of communication, but in many parts of Transylvania it is now carried on successfully. The forests are chiefly composed of oak, fir, pine, ash and alder.

Live Stock.—The number of live stock in Hungary proper in two different years is shown in the following table:—

Animal.	1884.	1895.
Horses . .	1,749,302	1,972,930
Cattle . . .	4,879,334	5,829,483
Sheep . . .	10,594,867	7,526,783
Pigs	4,803,777	6,447,134

In Croatia-Slavonia the live stock was numbered in 1895 at: horses, 309,098; cattle, 908,774; sheep, 595,898; pigs, 882,957. But the improved quality of the live stock is more worthy of notice than the growth in numbers.

The small Magyar horse, once famous for its swiftness and endurance, was improved during the Turkish wars, so far as height and beauty were concerned, by being crossed with Arabs; but it degenerated after the 17th century as the result of injudicious cross-breeding. The breed has, however, been since improved by government action, the establishment of state studs supported since 1867 by annual parliamentary grants, and the importation especially of English stock. The largest of the studs is that at Mezöhegyes (founded 1785) in the county of Csanád, the most extensive and remarkable of those "economies," model farms on a gigantic scale, which the government has established on its domains.¹ In 1905 it had 2224 horses, including 27 stallions and 422 blood mares. The next most important stud is at Kisber (founded 1853), with 731 horses; others are at Babolna (founded 1798), with 802 horses and Fogarás (founded 1874), with 400 horses.² Besides these there are several large depôts of state stallions, which are hired out or sold at moderate rates; but buyers have to guarantee not to export them without permission of the government. Large numbers of horses are exported annually, principally to Austria, Germany, Italy, France and Rumania.

Owing to its wide stretches of pasture-land Hungary is admirably suited for cattle-raising, and in the government "economies" the same care has been bestowed on improving the breed of horned beasts as in the case of horses. The principal breeds are either native or Swiss (especially that of Simmenthal). The export trade in cattle is considerable, amounting in 1905 to 238,296 head of

¹ An admirable account of this "little world, which produces almost everything and is almost self-sufficient" is given by M. Comnard in his *Hongrie au XX^{me} siècle*, p. 159 seq.

² *Ib.* p. 349 seq.

oxen, 56,540 cows, 23,765 bulls and 19,643 breeding cattle, as well as a large number of carcasses.

Sheep are not stocked so extensively as cattle, and are tending rapidly to decrease, a result due to the spread of intensive cultivation and the rise in value of the soil. They are not exported, but there is a considerable export trade in wool.

Pigs are reared in large quantities all over the country, but the principal centres for distribution are Debreczen, Gyula, Bács, Szeged and Budapest. They are exported in large numbers (408,000 in 1905), almost exclusively to Austria. There is also a considerable export trade in geese and eggs.

Minerals.—Hungary is one of the richest countries in Europe as regards both the variety and the extent of its mineral wealth. Its chief mineral products are coal, nitre, sulphur, alum, soda, saltpetre, gypsum, porcelain-earth, pipe-clay, asphalt, petroleum, marble and ores of gold, silver, mercury, copper, iron, lead, zinc, antimony, cobalt and arsenic. The principal mining regions are Zsepes-Gömör in Upper Hungary, the Kremnitz-Schemnitz district, the Nagy-bánya district, the Transylvanian deposits and the Banat. Gold and silver are chiefly found in Transylvania, where their exploitation dates back to the Roman period, and are mined at Zalatna and Abrudbánya; rich deposits are also found in the Kremnitz-Schemnitz, and the Nagy-bánya districts. The average yearly yield of gold is about £100,000, and that of silver about the same amount. The sand of some of the rivers, as for instance the Maros, Szamos, Körös and Aranyos, is auriferous. Coal is extensively mined in the region of Budapest-Oravicza, Nagy-bánya, Zalatna, at Brensborg near Sopron, at Salgó-Tarján, Pécs, in the counties of Kraszószerény, and of Esztergom, and in the valley of the river Zsík. Iron is extracted in the counties of Zsepes, Gömör and Abauj-Torna. The production of coal and iron trebled during the period 1885-1900, amounting in 1900 to 6,600,000 tons, and 465,000 tons respectively. The principal salt-mines are in Transylvania at Torda, Parad, Deákfalu and Maros-Ujvár; and in Hungary at Salfátina, Rónaszék and Sugatag. The salt-mines are a state monopoly. Hungary is the only country in Europe where the opal is found, namely at the famous mines of Vörösvágás in the county of Szécsény, and at Nagy-Mihály in that of Zemplén. Other precious stones found are chrysolite, garnet, jacinth, amethyst, carnelian, agate, rock-crystals, &c. Amber is found at Magura in Zsepes, while fine marble quarries are found in the counties of Esztergom, Komárom, Veszprém and Zsepes. The value of the mining (except salt) and smelting production in Hungary amounted in 1900 to £4,500,000, while in 1897 the value was only £1,500,000. The number of persons employed in mining and smelting works was (1900 census) 70,476.

Mineral Springs.—Hungary possesses a great number of cold and several hot mineral springs, some of them being greatly frequented. Among the principal in Hungary proper except Transylvania are those of Budapest, Mehadia, Eger, Sztubanya (Tuzsóló county), Szécsény (Zólyom county), Harkány (Baranya county), Pástyán (Nyitra county) and Tréncsén-Teplitz, where there are hot springs. Cold mineral springs are at Bértál, with alkaline ferruginous waters; Czigelka, with iodate waters; Parád, with ferruginous and sulphate springs; Korintz or Korytnica, with strong iron springs; and the mineral springs of Budapest. Among the principal health resorts of Hungary are Tatrafalva in the Tatra mountains, and Balatonfüred on the shores of Lake Balaton.

Industrial Development.—Efforts to create a native industry date only from 1867, and, considering the shortness of the time and other adverse factors, such as scarcity of capital, lack of means of communication, the development of industry in the neighbouring states of Austria, &c., the industry of Hungary has made great strides. Much of this progress is due to the state, one of the principal aims of the Hungarian government being the creation of a large and independent native industry. For this purpose legislation was promoted in 1867, 1881, 1890 and 1907. The principal facilities granted by the state are, exemption of taxation for a determined period of years, reduced railway fares for the goods manufactured, placing of government contracts, the grant of subsidies and loans and the foundation of industrial schools for the training of engineers and of skilled workmen. The branches of industry which have received special encouragement are those whose products are in universal request, such as cotton and woollen goods, and those which are in the service of natural production. In this category are the manufacture of agricultural machines, of tools and implements for agriculture, forestry and mining; such industries as depend for their raw material on the exploitation of the natural resources of the country, viz. those related to agriculture, forestry, mining, &c. Lastly, encouragement is given to all branches of industry concerned with the manufacture of articles used in the more important Hungarian industries, i.e. machinery, or semi-manufactured goods which serve as raw material for those industries. For the period 1890-1905, an average of 40 to 50 industrial establishments with an invested capital of £1,250,000 to £1,750,000 were founded yearly.

The principal industry of Hungary is flour-milling. The number of steam-mills, which in 1867 was about 150, rose to 1723 in 1893 and to 1845 in 1905. Between 3,000,000 and 3,200,000 tons of wheat-flour are produced annually. The principal steam-mills are at Budapest; large steam-mills are also established in many towns, while there are a great number of water-mills and some wind-mills.

The products of these mills form the principal article of export of Hungary. Brewing and distilling, as other branches of industry connected with agriculture, are also greatly developed. The sugar industry has made great strides, the amount of beetroot used having increased tenfold between 1880 and 1905. Other principal branches of industry are: tobacco manufactures, belonging to the state, tobacco being a government monopoly; iron foundries, mostly in the mining region; agricultural machinery and implements, notably at Budapest; leather manufactures; paper-mills, the largest at Fiume; glass (only the more common sort) and earthenwares; chemicals; wooden products; petroleum-refineries; woollen yarns and cloth manufactures, as well as several establishments of knitting and weaving. The various industrial establishments are located in the larger towns, but principally at Budapest, the only real industrial town of Hungary.

In 1900 the various industries of Hungary (including Croatia-Slavonia) employed 1,127,730 persons, or 12.8% of the earning population. In 1890 the number of persons employed was 913,010. Including families and domestic servants, 2,605,000 persons or 13.5% of the total population were dependent on industries for their livelihood in Hungary in 1900.

Commerce.—Hungary forms together with Austria one customs and commercial territory, and the statistics for the foreign trade is given under AUSTRIA-HUNGARY. The following table gives the foreign trade of Hungary only for a period of years in millions sterling:—

Year.	Imports.	Exports.
1886-1890	37.3	37.5
1891-1895	43.7	44.1
1900	46.3	55.3
1907	66.0	64.7

Of the merchandise¹ entering the country, 75-80% comes from Austria, and exports go to the same country to the extent of 75%. Next comes Germany with about 10% of the value of the total exports and 5% of that of imports. The neighbouring Balkan states—Rumania and Servia—follow, and the United Kingdom receives somewhat more than 2% of the exports, while supplying about 1.5% of the imports. The principal imports are: cotton goods, woollen manufactures; apparel, haberdashery and linen; silk manufactures; leather and leather goods. The exports, which show plainly the prevailing agricultural character of the country, are flour, wheat, cattle, beef, barley, pigs, wine in barrels, horses and maize.

With but a short stretch of sea-coast, and possessing only one important seaport, Fiume, the mercantile marine of Hungary is not very developed. It consisted in 1905 of 434 vessels with a tonnage of 91,784 tons and with crews of 2359 persons. Of these 95 vessels with a tonnage of 89,161 tons were steamers. Fifty-four vessels with 84,844 tons and crews numbering 1168 persons were sea-going; 134 with 6587 tons were coasting-vessels, and 246 with 353 tons were fishing vessels.

At all the Hungarian ports in 1900 there entered 19,223 vessels of 2,223,302 tons; cleared 19,218 vessels of 2,226,733 tons. The tonnage of British steamers amounted to somewhat more than 11% of the total tonnage of steamers entered and cleared.

Railways.—Hungary is covered by a fairly extensive network of railways, although in the sparsely populated parts of the kingdom the high road is still the only means of communication. The first railway in Hungary was the line between Budapest and Vác (Waitzen), 20 m. long, opened in 1846 (15th of July). After the Compromise of 1867, the policy of the Hungarian government was to construct its own railways, and to take over the lines constructed and worked by private companies.² In 1907 the total length of the Hungarian railways, in which over £145,000,000 had been invested, was 12,100 m., of which 5000 m. belonged to and were worked by the state, 5100 m. belonged to private companies but were worked by the state, and 2000 m. belonged to and were worked by private companies. The passengers carried in 1907 numbered 107,471,000, the goods traffic was 61,483,000 tons; the traffic receipts for the year were £16,420,000. The corresponding figures for 1880 were as follows: passengers carried, 9,346,000; goods carried, 11,225,000 tons; traffic receipts, £4,300,000. The so-called zone tariff, adopted for the first time in Europe by the Hungarian state railways, was inaugurated in 1889 for passengers and in 1891 for goods.³ The principle of this system is to offer cheap fares and relatively low tariffs for greater distances, and to promote, therefore, long-distance travelling. The zone tariff has given a great impetus both to passenger and goods traffic in Hungary, and has been adopted on some of the Austrian railways.

¹ Merchandise passing the boundaries is subject to declaration; the respective values are stated by a special commission of experts residing in Budapest.

² The acquisition of the Austrian Staatsbahn in 1891 practically gave to the state the control of the whole railway net of Hungary. By 1900 all the main lines, except the Südbahn and the Kaschan-Oberberger Bahn, were in its hands.

In 1907 the length of the navigable waterways of Hungary was 3200 m., of which 2450 m. were navigable by steamers.

Seaports.—On the Adriatic lies the port of Fiume (q.v.), the only direct outlet by sea for the produce of Hungary. Its commanding position at the head of the Gulf of Quarnero, and spacious new harbour works, as also its immediate connexions with both the Austrian and Hungarian railway systems, render it specially advantageous as a commercial port. As shipping stations, Buccari, Portoré, Selče, Novi, Zengg, San Giorgio, Jablanac and Cariopago are of comparative insignificance. The whole of the short Hungarian seaboard is mountainous and subject to violent winds.

Government.—Hungary is a constitutional monarchy, its monarch bearing the title of king. The succession to the throne is hereditary in the order of primogeniture in the male line of the house of Habsburg-Lorraine; and failing this, in the female line. The king must be a member of the Roman Catholic Church. The king of Hungary is also emperor of Austria, but beyond this personal union, and certain matters regulated by both governments jointly (see AUSTRIA-HUNGARY), the two states are independent of each other, having each its own constitution, legislature and administration. The king is the head of the executive, the supreme commander of the armed forces of the nation, and shares the legislative power with the parliament.

The constitution of Hungary is in many respects strikingly analogous to that of Great Britain, more especially in the fact that it is based on no written document but on immemorial prescription, confirmed or modified by a series of enactments, of which the earliest and most famous was the Golden Bull of Andrew III. (1222), the Magna Carta of Hungary. The ancient constitution, often suspended and modified, based upon this charter, was reformed under the influence of Western Liberalism in 1848, the supremacy of the Magyar race, however, being secured by a somewhat narrow franchise. Suspended after the collapse of the Hungarian revolt in 1849 for some eighteen years, the constitution was restored in 1867 under the terms of the Compromise (*Ausgleich*) with Austria, which established the actual organization of the country (see *History*, below).

The legislative power is vested in the parliament (*Országgyűlés*), which consists of two houses: an upper house or the House of Magnates (*Főrendiház*), and a lower house or House of Representatives (*Képviselőház*). The House of Magnates is composed as follows: princes of the royal house who have attained their majority (16 in 1904); hereditary peers who pay at least £250 a year land-tax (237 in 1904); high dignitaries of the Roman Catholic and Eastern Orthodox churches (42 in 1904); representatives of the Protestant confessions (13 in 1904); life peers appointed by the crown, not exceeding 50 in number, and life peers elected by the house itself (73 altogether in 1904); members *ex officio* consisting of state dignitaries and high judges (19 in 1904); and three delegates of Croatia-Slavonia. The House of Representatives consists of members elected, under the Electoral Law of 1874, by a complicated franchise based upon property, taxation, profession or official position, and ancestral privileges.⁴ The house consists of 453 members, of which 413 are deputies elected in Hungary and 43 delegates of Croatia-Slavonia sent by the parliament of that province. The members are elected for five years and receive payment for their services. The parliament is summoned annually by the king at Budapest. The official language is Magyar, but the delegates of Croatia-Slavonia may use their own language. The Hungarian parliament has power to legislate on all matters concerning Hungary, but for Croatia-Slavonia only on matters which concern these provinces in common with Hungary. The executive power is vested in a responsible cabinet, consisting of ten ministers, namely, the president of the council, the minister of the interior, of national defence, of education and public worship, of finance,

⁴ The franchise is "probably the most illiberal in Europe." Servants, in the widest sense of the word, apprenticed workmen and agricultural labourers are carefully excluded. The result is that the working classes are wholly unrepresented in the parliament, only 6% of them, and 13% of the small trading class, possessing the franchise, which is only enjoyed by 6% of the entire population (see Seton-Watson, *Racial Problems*, 250, 251). For the question of franchise reform which played so great a part in the Austro-Hungarian crisis of 1909-1910 see *History*, below.—[Ed.]

of agriculture, of industry and commerce, of justice, the minister for Croatia-Slavonia, and the minister *ad latus* or near the king's person. As regards local government, the country is divided into municipalities or counties, which possess a certain amount of self-government. Hungary proper is divided into sixty-three rural, and—including Fiume—twenty-six urban municipalities (see section on *Administrative Divisions*). These urban municipalities are towns which for their local government are independent of the counties in which they are situated, and have, therefore, a larger amount of municipal autonomy than the communes or the other towns. The administration of the municipalities is carried on by an official appointed by the king, aided by a representative body. The representative body is composed half of elected members, and half of citizens who pay the highest taxes. Since 1876 each municipality has a council of twenty members to exercise control over its administration.

Administrative Divisions.—Since 1867 the administrative and political divisions of the lands belonging to the Hungarian crown have been in great measure remodelled. In 1868 Transylvania was definitely reunited to Hungary proper, and the town and district of Fiume declared autonomous. In 1873 part of the "Military Frontier" was united with Hungary proper and part with Croatia-Slavonia. Hungary proper, according to ancient usage, was generally divided into four great divisions or circles, and Transylvania up to 1876 was regarded as the fifth. In 1876 a general system of counties was introduced. According to this division Hungary proper is divided into seven circles, of which Transylvania forms one. The whole country is divided into the following counties:—

(a) The circle on the left bank of the Danube contains eleven counties: (1) Arva, (2) Bars, (3) Esztergom, (4) Hont, (5) Liptó, (6) Nógrád, (7) Nyitra, (8) Pozsony (Pressburg), (9) Trencsén, (10) Turóc, and (11) Zólyom.

(b) The circle on the right bank of the Danube contains eleven counties: Baranya, Fejér, Győr, Komárom, Moson, Somogy, Sopron, Tolna, Vas, Veszprém and Zala.

(c) The circle between the Danube and Theiss contains five counties: Bács-Bodrog, Csongrád, Heves, Jász-Nagykun-Szolnok and Pest-Pilis-Solt-Kiskun.

(d) The circle on the right bank of the Theiss contains eight counties: Abauj-Torna, Bereg, Borsod, Gömör-és Kis-Hont, Sáros, Szepes, Ung, Zemplén.

(e) The circle on the left bank of the Theiss contains eight counties: Békés, Bihar, Hajdu, Máramaros, Szabolcs, Saattmár, Szilágy and Ugocsa.

(f) The circle between the Theiss and the Maros contains five counties: Arad, Csanád, Krasó-Szörény, Temes and Torontál.

(g) Transylvania contains fifteen counties: Alsó-Fehér, Beszterce-Nászód, Brassó, Csk, Fogaras, Háromszék, Hunyad, Kis-Küküllő, Kolozs, Maros-Torda, Nagy-Küküllő, Szeben, Szolnok-Doboka, Torda-Aranyos and Udvarhely.

Fiume town and district forms a separate county.

Croatia-Slavonia is divided into eight counties: Belovar-Kőrös, Lika-Krbava, Modrus-Fiume, Pozsega, Szerém, Varasd, Verőcse and Zágráb.

Besides these sixty-three rural counties for Hungary, and eight for Croatia-Slavonia, Hungary has twenty-six urban counties or towns with municipal rights. These are: Arad, Baja, Debreczen, Győr, Hódmező-Vásárhely, Kassa, Kecskemét, Kolozsvár, Komárom, Maros-Vásárhely, Nagyvárad, Pancsova, Pécs, Pozsony, Selmecz-és Béalábánya, Sopron, Szabadka, Szatmár-Németi, Szeged, Székesfehérvár, Temevár, Ujvidék, Veszec, Zombor, the town of Fiume, and Budapest, the capital of the county.

In Croatia-Slavonia there are four urban counties or towns with municipal rights namely: Eszék, Varasd, Zágráb and Zimony.

Justice.—The judicial power is independent of the administrative power. The judicial authorities in Hungary are: (1) the district courts with single judges (458 in 1905); (2) the county courts with collegiate judges (76 in number); to these are attached 15 jury courts for press offences. These are courts of first instance. (3) Royal Tables (12 in number), which are courts of second instance, established at Budapest, Debreczen, Győr, Kassa, Kolozsvár, Maros-Vásárhely, Nagyvárad, Pécs, Pressburg, Szeged, Temevár and Zágráb. (4) The Royal Supreme Court at Budapest, and the Supreme Court of Justice, or Table of Septemvirs, at Zágráb, which are the highest judicial authorities. There are also a special commercial court at Budapest, a naval court at Fiume, and special army courts.

Finance.—After the revolution of 1848–1849 the Hungarian budget was amalgamated with the Austrian, and it was only after the Compromise of 1867 that Hungary received a separate budget. The development of the Hungarian kingdom can be better appreciated by a comparison of the estimates for the year 1849 prepared by the Hungarian minister of finance, which shows a revenue of £1,335,000 and an expenditure of £5,166,000 (including £3,500,000 for warlike purposes), with the budget of 1905, which shows a revenue

of £51,583,000, and an expenditure of about the same sum. Owing to the amount spent on railways, the Fiume harbour works and other causes, the Hungarian budgets after 1867 showed big annual deficits, until in 1888 great reforms were introduced and the finances of the country were established on a more solid basis. During the years 1891–1895 the annual revenue was £42,100,000 and the expenditure £39,000,000; in 1900 the revenue and expenditure balanced themselves at £45,400,000. The following figures in later years are typical:—

	Revenue.	Expenditure.
1904 . . .	£49,611,200	£49,592,400
1908 . . .	57,896,845	57,894,923

The ordinary revenue of the state is derived from direct and indirect taxation, monopolies, stamp dues, &c. In 1904 direct taxes amounted to £9,048,000, and the chief heads of direct taxes yielded as follows: ground tax, £2,317,000; trade tax, £1,879,000; income tax, £1,400,000; house tax, £1,000,000. Indirect taxes amounted in 1904 to £7,363,000, and the chief heads of indirect taxation yielded as follows: taxes on alcoholic drinks, £4,375,000; sugar tax, £1,292,000; petroleum tax, £118,000; meat tax, £375,000. The principal monopolies yielded as follows: salt monopoly, £1,210,000; tobacco monopoly, £2,850,000; lottery monopoly, £105,000. Other revenues yielded as follows: stamp taxes and dues, £3,632,000; state railways, £3,545,000; post and telegraphs, £710,000; state landed property and forests, £250,000.

The national debt of Hungary alone, excluding the debt incurred jointly by both members of the Austro-Hungarian monarchy, was £192,175,000 at the end of 1903. The following table shows the growth of the total debt, due chiefly to expenditure on public works, in millions sterling:—

1880.	1890.	1900.	1905.
£83.6	£171.9	£192.8	£198.02

Religion.—There is in Hungary just as great a variety of religious confessions as there is of nationalities and of languages. None of them possesses an overwhelming majority, but perfect equality is granted to all religious creeds legally recognised. According to the census returns of 1900 in Hungary proper there were:—

	Per Cent. of Population.
Roman Catholics	8,198,497 or 48.69
Uniat Greeks ¹	1,841,272 or 10.93
Greek Orthodox	2,199,195 or 13.06
Evangelicals—	
Augsburg confession, or Lutherans	1,258,860 or 7.48
Helvetic confession, or Calvinists	2,427,232 or 14.41
Unitarians	68,551 or 0.41
Jews	831,162 or 4.94
Others	13,486 or 0.08

In many instances nationality and religious faith are coincident. Thus the Serbians are mostly Greek Orthodox; the Ruthenians are Uniat Greeks; the Rumanians are either Greek Orthodox or Greek Uniat; the Slovaks are Lutherans; the only other Lutherans are the Germans in Transylvania and in the Szepes county. The Calvinists are composed mostly of Magyars, so that in the country the Lutherans are designated as the "German Church," and the Calvinists as the "Hungarian Church." The Unitarians are all Magyars. Only to the Roman Catholic Church belong several nationalities. The Roman Catholic Church has 4 archbishops; Esztergom (Gran), Kalocsa, Eger (Erlau) and Zágráb (Agram); and 17 diocesan bishops; to the latter must be added the chief abbot of Pannonhalma, who likewise enjoys episcopal rights. The primate is the archbishop of Esztergom, who also bears the title of prince, and whose special privilege it is to crown the sovereigns of Hungary. The Greek Uniat Church owns besides the archbishop of Esztergom the archbishop of Gyulafehérvár (Carlsburg), or rather Balásfalva (i.e. "the city of Blasius"), and 6 bishops. The Armenian Uniat Church is partly under the jurisdiction of the Roman Catholic bishop of Transylvania, and partly under that of the Roman Catholic archbishop of Kalocsa. The Orthodox Eastern Church in Hungary is subject to the authority of the metropolitan of Carlowitz and the archbishop of Nagyszombat (Hermannstadt); under the former are the bishops of Bács, Buda, Temevár, Veszec and Pakrácz, and under the latter the bishops of Arad and Karánseba. The two great Protestant communities are divided into ecclesiastical districts, five for each; the heads of these districts bear the title of superintendents. The Unitarians, chiefly resident in Transylvania, are under the authority of a bishop, whose see is Kolozsvár (Klausenburg). The Jewish communities are comprised in ecclesiastical districts, the head direction being at Budapest.

Education.—Although great improvements have been effected in the educational system of the country since 1867, Hungary is still backward in the matter of general education, as in 1900 only a little over 50% of the population could read and write. Before 1867 public instruction was entirely in the hands of the clergy of the various confessions, as is still the case with the majority of the

¹ i.e. Catholics of the Oriental rite in communion with Rome.

primary and secondary schools. One of the first measures of newly established Hungarian government was to provide supplementary schools of a non-denominational character. By a law passed in 1868 attendance at school is obligatory on all children between the ages of 6 and 12 years. The communes or parishes are bound to maintain elementary schools, and they are entitled to levy an additional tax of 5% on the state taxes for their maintenance. But the number of state-aided elementary schools is continually increasing, as the spread of the Magyar language to the other races through the medium of the elementary schools is one of the principal concerns of the Hungarian government, and is vigorously pursued.¹ In 1902 there were in Hungary 18,729 elementary schools with 32,020 teachers, attended by 2,573,377 pupils, figures which compare favourably with those of 1877, when there were 15,486 schools with 20,717 teachers, attended by 1,559,636 pupils. In about 61% of these schools the language used was exclusively Magyar, in about 20% it was mixed, and in the remainder some non-Magyar language was used. In 1902, 80-85% of the children of school age actually attended school. Since 1801 infant schools, for children between the ages of 3 and 6 years, have been maintained either by the communes or by the state.

The public instruction of Hungary contains three other groups of educational institutions: middle or secondary schools, "high schools" and technical schools. The middle schools comprise classical schools (gymnasias) which are preparatory for the universities and other "high schools," and modern schools (*Realschulen*) preparatory for the technical schools. Their course of study is generally eight years, and they are maintained mostly by the state. The state-maintained gymnasias are mostly of recent foundation, but some schools maintained by the various churches have been in existence for three, or sometimes four, centuries. The number of middle schools in 1902 was 243 with 4703 teachers, attended by 71,788 pupils; in 1880 their number was 185, attended by 40,747 pupils.

The high schools include the universities, of which Hungary possesses three, all maintained by the state: at Budapest (founded in 1635), at Kolozsvár (founded in 1872), and at Zágráb (founded in 1874). They have four faculties: of theology, law, philosophy and medicine. (The university at Zágráb is without a faculty of medicine.) There are besides ten high schools of law, called academies, which in 1900 were attended by 1569 pupils. The Polytechnicum in Budapest, founded in 1844, which contains four faculties and was attended in 1900 by 1772 pupils, is also considered a high school. There were in Hungary in 1900 forty-nine high theological colleges, twenty-nine Roman Catholic; five Greek Uniat, four Greek Orthodox, ten Protestant and one Jewish. Among special schools the principal mining schools are at Selmeczbánya, Nagyág and Felsőbánya; the principal agricultural colleges at Debreczen and Kolozsvár; and there are a school of forestry at Selmeczbánya, military colleges at Budapest, Kassa, Déva and Zágráb, and a naval school at Fiume. There are besides an adequate number of training institutes for teachers, a great number of schools of commerce, several art schools for design, painting, sculpture, music, &c. Most of these special schools are of recent origin, and are almost entirely maintained by the state or the communes.

The richest libraries in Hungary are the National Library at Budapest; the University Library, also at Budapest, and the library of the abbey of Pannonhálma. Besides the museums mentioned in the article Budapest, several provincial towns contain interesting museums, namely, Pressburg, Temesvár, Déva, Kolozsvár, Nagyszecben; further, the national museum at Zágráb, the national (Székler) museum at Maros-Vásárhely, and the Carpathian museum at Porpád should be mentioned.

At the head of the learned and scientific societies stands the Hungarian Academy of Sciences, founded in 1830; the Kislafudy Society, the Petöfi Society, and numerous societies of specialists, as the historical, geographical, &c., with their centres at Budapest. There are besides a number of learned societies in the various provinces for the fostering of special provincial or national aims. There are also a number of societies for the propagation of culture, both amongst the Hungarian and the non-Hungarian nationalities. Worth mentioning are also the two Carpathian societies: the Hungarian and the Transylvanian.

BIBLIOGRAPHY.—F. Umlauf, *Die Länder Österreich-Ungarns in Wort und Bild* (Vienna, 1879-1889, 15 vols., 12th volume, 1886, deals with Hungary), *Die österreichische Monarchie in Wort und Bild* (Vienna, 1889-1902, 24 vols., 7 vols. are devoted to Hungary), *Die Völker Österreich-Ungarns* (Teschon, 1881-1885, 12 vols.); A. Supan, "Österreich-Ungarn" (Vienna, 1889, in Kirchhoff's *Lehrerhandbuch von Europa*, vol. II); Auerbach, *Les Races et les nationalités en Autriche-Hongrie* (Paris, 1897); Mayerhofer, *Österreich-ungarisches Orientsikon* (Vienna, 1896); *Hungary, Its People, Places and Politics. The Journey of the Eighty Club to Hungary in 1906* (London, 1907); R. W. Seton-Watson ("Scotus Viator"), *Racial Problems in Hungary* (London, 1908), a strong indictment of the racial policy of the Magyars, supported by exact references and many

¹ The methods pursued to this end are exposed in pitiless detail by Mr Seton-Watson in his chapter on the Education Laws of Hungary, in *Racial Problems*, 205.

documents, mainly concerned with the Slovaks; René Gonnard, *La Hongrie au XX^e siècle* (Paris, 1908), an admirable description of the country and its people, mainly from the point of view of economic development and social conditions; Geoffrey Drage, *Austria-Hungary* (London, 1909), a very useful book of reference; P. Alden (editor), *Hungary of To-day*, by members of the Hungarian Government (London, 1909); see also "The Problem of Hungary" in the *Edinburgh Review* (No. 429) for July 1909. The various reports of the Central Statistical Office at Budapest contain all the necessary statistical data. A summary of them is annually published under the title *Magyar statisztikai Évkönyv* (*Statistical Year-Book of Hungary*) (O. B.).

II. HISTORY

When Árpád, the semi-mythical founder of the Magyar monarchy, at the end of A.D. 895 led his savage hordes through the Vereczka pass into the regions of the Upper Theiss, the land, now called Hungary, was, for the most part, in the possession of Slavs or semi-Slavs. From the Ritsengebirge to the Vistula, and from the Moldau to the Drave, extended the shadowy empire of Moravia, founded by Moimir and Svatopluk (c. 850-890), which collapsed so completely at the first impact of the Magyars that, ten years after their arrival, not a trace of it remained. The Bulgarians, Serbs, Croats and Avars in the southern provinces were subdued with equal ease. Details are wanting, but the traditional decisive battle was fought at Alpar on the Theiss, whereupon the victors pressed on to Orsova, and the conquest was completed by Árpád about the year 906. This forcible intrusion of a non-Aryan race altered the whole history of Europe; but its peculiar significance lay in the fact that it permanently divided the northern from the southern and the eastern from the western Slavs. The inevitable consequence of this rupture was the Teutonizing of the western branch of the great Slav family, which, no longer able to stand alone, and cut off from both Rome and Constantinople, was forced, in self-defence, to take Christianity, and civilization along with it, from Germany.

During the following seventy years we know next to nothing of the internal history of the Magyars. Árpád died in 907, and his immediate successors, Zsolt (907-947) and Taksony (947-972), are little more than chronological landmarks. This was the period of those devastating raids which made the savage Magyar horsemen the scourge and the terror of Europe. We have an interesting description of their tactics from the pen of the emperor Leo VI., whose account of them is confirmed by the contemporary Russian annals. Trained riders, archers and javelin-throwers from infancy, they advanced to the attack in numerous companies following hard upon each other, avoiding close quarters, but wearing out their antagonists by the persistency of their onslaughts. Scarce a corner of Europe was safe from them. First (908-910) they ravaged Thuringia, Swabia and Bavaria, and defeated the Germans on the Lechfeld, whereupon the German king Henry I. bought them off for nine years, employing the respite in reorganizing his army and training cavalry, which henceforth became the principal military arm of the Empire. In 933 the war was resumed, and Henry, at the head of what was really the first national German army, defeated the Magyars at Gotha and at Ried (933). The only effect of these reverses was to divert them elsewhere. Already, in 926, they had crossed the Rhine and ravaged Lotharingia. In 934 and 942 they raided the Eastern Empire, and were bought off under the very walls of Constantinople. In 943 Taksony led them into Italy, when they penetrated as far as Otranto. In 955 they ravaged Burgundy. The same year the emperor Otto I. proclaimed them the enemies of God and humanity, refused to receive their ambassadors, and finally, at the famous battle of the Lechfeld, overwhelmed them on the very scene of their first victory, near Augsburg, which they were besieging (Aug. 10, 955). Only seven of the Magyars escaped, and these were sold as slaves on their return home.

The catastrophe of the Lechfeld convinced the leading Magyars of the necessity of accommodating themselves as far as possible to the Empire, especially in the matter of religion. Christianity had already begun to percolate Hungary. A large proportion

of the captives of the Magyars had been settled all over the country to teach their conquerors the arts of peace, and close contact with this civilizing element was of itself an enlightenment. The moral superiority of Christianity to paganism was speedily obvious. The only question was which form of Christianity were the Magyars to adopt, the Eastern or the Western? Constantinople was the first in the field. The splendour of the imperial city profoundly impressed all the northern barbarians, and the Magyars, during the 10th century, saw a great deal of the Greeks. One Transylvanian raider, Gyula, brought back with him from Constantinople a Greek monk, Hierothus (c. 950), who was consecrated "first bishop of Turkia." Simultaneously a brisk border trade was springing up between the Greeks and the Magyars, and the Greek chapmen brought with them their religion as well as their wares. Everything at first tended to favour the propaganda of the Greek Church. But ultimately political prevailed over religious considerations. Alarmed at the sudden revival of the Eastern Empire, which under the Macedonian dynasty extended once more to the Danube, and thus became the immediate neighbour of Hungary, Duke Geza, who succeeded Taksony in 972, shrewdly resolved to accept Christianity from the more distant and therefore less dangerous emperor of the West. Accordingly an embassy was sent to Otto II. at Quedlinburg in 973, and in 975 Geza and his whole family were baptized. During his reign, however, Hungarian Christianity did not extend much beyond the limits of his court. The nation at large was resolutely pagan, and Geza, for his own sake, was obliged to act warily. Moreover, by accepting Christianity from Germany, he ran the risk of imperilling the independence of Hungary. Hence his cautious, dilatory tactics: the encouragement of Italian propagandists, who were few, the discouragement of German propagandists, who were many. Geza, in short, regarded the whole matter from a statesman's point of view, and was content to leave the solution to time and his successor.

That successor, Stephen I. (975), was one of the great constructive statesmen of history. His long and strenuous reign (997-1038) resulted in the firm establishment of the Hungarian church and the Hungarian state. The great work may be said to have begun in 1001, when Pope Silvester II. recognized Magyar nationality by endowing the young Magyar prince with a kingly crown. Less fortunate than his great exemplar, Charlemagne, Stephen had to depend entirely upon foreigners—men like the Saxon Asztrik¹ (c. 976-1010), the first Hungarian primate; the Lombard St Gellert (c. 977-1046); the Bosomans, a German family, better known under the Magyarized form of their name Pázmány, and many others who came to Hungary in the suite of his enlightened consort Gisela of Bavaria. By these men Hungary was divided into dioceses, with a metropolitan see at Esztergom (Gran), a city originally founded by Geza, but richly embellished by Stephen, whose Italian architects built for him there the first Hungarian cathedral dedicated to St Adalbert. Towns, most of them also the sees of bishops, now sprang up everywhere, including Székesfehérvár (Stuhlweissenburg), Veszprém, Pécs (Fünfkirchen) and Győr (Raab). Esztergom, Stephen's favourite residence, was the capital, and continued to be so for the next two centuries. But the Benedictines, whose settlement in Hungary dates from the establishment of their monastery at Pannonhalma (c. 1001), were the chief pioneers. Every monastery erected in the Magyar wildernesses was not only a centre of religion, but a focus of civilization. The monks cleared the forests, cultivated the recovered land, and built villages for the colonists who flocked to them, teaching the people western methods of agriculture and western arts and handicrafts. But conversion, after all, was the chief aim of these devoted missionaries, and when some Venetian priests had invented a Latin alphabet for the Magyar language a great step had been taken towards its accomplishment.

The monks were soon followed by foreign husbandmen, artificers and handicraftsmen, who were encouraged to come to Hungary by reports of the abundance of good land there and

¹ Ger. Otrik, in religion Anastasius.

the promise of privileges. This immigration was also stimulated by the terrible condition of western Europe between 987 and 1060, when it was visited by an endless succession of bad harvests and epidemics.² Hungary, now better known to Europe, came to be regarded as a Promised Land, and, by the end of Stephen's reign, Catholics of all nationalities, Greeks, Pagans, Jews and Mahomedans were living securely together within her borders. For, inexorable as Stephen ever was towards fanatical pagans, renegades and rebels, he was too good a statesman to inquire too closely into the private religious opinions of useful and quiet citizens.

In endeavouring, with the aid of the church, to establish his kingship on the Western model Stephen had the immense advantage of building on unencumbered ground, the greater part of the soil of the country being at his absolute disposal. His authority, too, was absolute, being tempered only by the shadowy right of the Magyar nation to meet in general assembly; and this authority he was careful not to compromise by any slavish imitation of that feudal polity by which in the West the royal power was becoming obscured. Although he broke off the Magyar tribal system, encouraged the private ownership of land, and even made grants of land on condition of military service—in order to secure an armed force independent of the national levy—he based his new principle of government, not on feudalism, but on the organization of the Frankish empire, which he adapted to suit the peculiar exigencies of his realm. Of the institutions thus borrowed and adapted the most notable was the famous county system which still plays so conspicuous a part in Hungarian national life. Central and western Hungary (the south and north-east still being desolate) were divided into forty-six counties (*vármegyék*, Lat. *comitatus*). At the head of each county was placed a count, or lord-lieutenant³ (*Főispán*, Lat. *comes*), who nominated his subordinate officials: the castellan (*várnagy*), chief captain (*hadnagy*) and "hundredor" (*szászados*, Lat. *centurio*). The lord-lieutenant was nominated by the king, whom he was bound to follow to battle at the first summons. Two-thirds of the revenue of the county went into the royal treasury, the remaining third the lord-lieutenant retained for administrative purposes. In the county system were included all the inhabitants of the county save two classes: the still numerous pagan clans, and those nobles who were attached to the king's person, from whom he selected his chief officers of state and the members of his council, of which we now hear for the first time.

It is significant for the whole future of Hungary that no effort was or could be made by Stephen to weld the heterogeneous races under his crown into a united nation. The body politic consisted, after as before, of the king and the whole mass of Magyar freemen or nobles, descendants of Árpád's warriors, theoretically all equal in spite of growing inequalities of wealth and power, who constituted the *populus*; privileges were granted by the king to foreign immigrants in the cities, and the rights of nobility were granted to non-Magyars for special services; but, in general, the non-Magyars were ruled by the royal governors as subject races, forming—in contradistinction to the "nobles"—the mass of the peasants, the *misera contribuens plebs* upon whom until 1848 nearly the whole burden of taxation fell. The right, not often exercised, of the Magyar nobles to meet in general assembly and the elective character of the crown Stephen also did not venture to touch. On the other hand, his example in manumitting most of his slaves, together with the precepts of the church, practically put an end to slavery in the course of the 13th century, the slaves becoming for the most part serfs, who differed from the free peasants only in the fact that they were attached to the soil (*adscripti glebæ*).

At this time all the conditions of life in Hungary were simple

² At its worst, c. 1030-1033, cannibalism was common.

³ The English title of lord-lieutenant is generally used as the best translation of *Főispán* or *comes* (in this connexion). The title of count (*gróf*) was assumed later (15th century) by those nobles who had succeeded, in spite of the Golden Bull, in making their authority over whole counties independent and hereditary.—[Ed.]

and primitive. The court itself was perambulatory. In summer the king dispensed justice in the open air, under a large tree. Only in the short winter months did he dwell in the house built for him at Esztergom by his Italian architects. The most valuable part of his property still consisted of flocks and herds, or the products of the labours of his serfs, a large proportion of whom were bee-keepers, hunters and fishers employed in and around the interminable virgin-forests of the rough-hewn young monarchy.

A troubled forty years (1038-1077) divides the age of St Stephen from the age of St Ladislaus. Of the six kings who reigned in Hungary during that period three died violent deaths, and the other three were fighting incessantly against foreign and domestic foes. In 1046, and again in 1061, two dangerous pagan risings shook the very foundations of the infant church and state; the western provinces were in constant danger from the attacks of the acquisitive emperors, and from the south and south-east two separate hordes of fierce barbarians (the Petchenegs in 1067-1068, and the Kumanians in 1071-1072) burst over the land. It was the general opinion abroad that the Magyars would either relapse into heathendom, or become the vassals of the Holy Roman Empire, and this opinion was reflected in the increasingly hostile attitude of the popes towards the Árpád kings. The political independence of Hungary was ultimately secured by the outbreak of the quarrel about investiture (1076), when

Geza I. (1074-1077) shrewdly applied to Pope Gregory VII. for assistance, and submitted to accept his kingdom from him as a fief of the Holy See. The immediate result of the papal alliance was to enable Hungary, under both Ladislaus and his capable successor Coloman [Kálmán] (1095-1116), to hold her own against all her enemies, and extend her dominion abroad by conquering Croatia and a portion of the Dalmatian coast. As an incipient great power, she was beginning to feel the need of a seaboard.

In the internal administration both Ladislaus I. and Coloman

Ladislaus
I. and
Coloman.

planted large Petcheneg colonies in Transylvania and the trans-Dravian provinces, and established military cordons along the constantly threatened south-eastern boundary, the germs of the future banates' (*bánságok*) which were to play such an important part in the national defence in the following century. Law and order were enforced with the utmost rigour. In that rough age crimes of violence predominated, and the king's justiciars regularly perambulated the land in search of offenders, and decimated every village which refused to surrender fugitive criminals. On the other hand, both the Jews and the "Ishmaelites" (Mahomedans) enjoyed complete civil and religious liberty in Hungary, where, indeed, they were too valuable to be persecuted. The Ishmaelites, the financial experts of the day, were the official mint-masters, treasurers and bankers. The clergy, the only other educated class, supplied the king with his lawyers, secretaries and ambassadors. The Magyar clergy was still a married clergy, and their consubial privileges were solemnly confirmed by the synod of Szabolcs, presided over by the king, in 1092. So firmly rooted in the land was this practice, that Coloman, much as he needed the assistance of the Holy See in his foreign policy, was only with the utmost difficulty induced, in 1106, to bring the Hungarian church into line with the rest of the Catholic world by enforcing clerical celibacy. Coloman was especially remarkable as an administrative reformer, and Hungary, during his reign, is said to have been the best-governed state in Europe. He regulated and simplified the whole system of taxation, encouraged agriculture by differential duties in favour of the farmers, and promoted trade by a systematic improvement of the ways of communication. The *Magna via Colomanni Regis* was in use for centuries after his death. Another important reform was the law permitting the free disposal of landed estate, which gave the holders an increased interest in their property, and an inducement to improve it. During the reign of Coloman, moreover, the number of freemen was increased by the frequent manumission of serfs.

¹ The *báns* is equivalent to the margrave, or count of the marches.

The lot of the slaves was also somewhat ameliorated by the law forbidding their exportation.

Throughout the greater part of the 12th century the chief impediment in the way of the external development of the Hungarian monarchy was the Eastern Empire, which, under the first three princes of the Comnenian dynasty, dominated south-eastern Europe. During the earlier part of that period the Magyars competed on fairly equal terms with their imperial rivals for the possession of Dalmatia, Rascia (the original home of the Servians, situated between Bosnia, Dalmatia and Albania) and Ráma or northern Bosnia (acquired by Hungary in 1135); but on the accession of Manuel Comnenus in 1143 the struggle became acute. As the grandson of St Ladislaus, Manuel had Hungarian blood in his veins; his court was the ready and constant refuge of the numerous Magyar malcontents, and he aimed not so much at the conquest as at the suzerainty of Hungary, by placing one of his Magyar kinsmen on the throne of St Stephen. He successfully supported the claims of no fewer than three pretenders to the Magyar throne, and finally made Béla III. (1173-1196) king of Hungary, on condition that he left him, Manuel, a free hand in Dalmatia. The intervention of the Greek emperors had important consequences for Hungary. Politically it increased the power of the nobility at the expense of the crown, every competing pretender naturally endeavouring to win adherents by distributing largesse in the shape of crown-lands. Ecclesiastically it weakened the influence of the Catholic Church in Hungary, the Greek Orthodox Church, which permitted a married clergy and did not impose the detested tithe (the principal cause of nearly every pagan revolt) attracting thousands of adherents even among the higher clergy. At one time, indeed, a Magyar archbishop and four or five bishops openly joined the Orthodox communion and willingly crowned Manuel's nominees despite the anathemas of their Catholic brethren.

The Eastern Empire ceased to be formidable on the death of Manuel (1080), and Hungary was free once more to pursue a policy of aggrandizement. In Dalmatia the Venetians were too strong for her; but she helped materially to break up the Byzantine rule in the Balkan peninsula by assisting Stephen Nemanya to establish an independent Servian kingdom, originally under nominal Hungarian suzerainty. Béla endeavoured to strengthen his own monarchy by introducing the hereditary principle, crowning his infant son Emerich, as his successor during his own lifetime, a practice followed by most of the later Árpáds; he also held a brilliant court on the Byzantine model, and replenished the treasury by his wise economies.

Unfortunately the fruits of his diligence and foresight were dissipated by the follies of his two immediate successors, Emerich (1196-1204) and Andrew II. (q.v.), who weakened the royal power in attempting to win support by lavish grants of the crown domains on the already over-influential magnates, a policy from which dates the supremacy of the semi-savage Magyar oligarchs, that insolent and self-seeking class which would obey no superior and trampled ruthlessly on every inferior. The most conspicuous event of Andrew's reign was the promulgation in 1222 of the so-called Golden Bull, which has aptly been called the Magna Carta of Hungary, and is in some of its provisions strikingly reminiscent of that signed seven years previously by the English king John.

The Golden Bull has been described as consecrating the humiliation of the crown by the great barons, whose usurpations it legalized; the more usually accepted view, however, is that it was directed not so much to weakening as to strengthening the crown by uniting its interests with those of the mass of the Magyar nobility, equally threatened by the encroachments of the great barons.³ The preamble, indeed, speaks of the curtailment of the liberties of the nobles by the power of certain of the kings, and at the end the right of armed resistance to any attempt to infringe the charter is conceded to "the bishops and the higher and lower nobles" of the realm; but, for the rest, its contents clearly show that it was intended to strengthen the monarchy by ensuring "that the momentary folly

³ Andrassy, *Development of Hung. Const. Liberty* (Eng. trans., p. 93); *Knatchbull-Hugessen*, i. 26 seq., where its provisions are given in some detail.

Rivalry
with the
Eastern
Empire.

Béla III.

Andrew II.

or weakness of the king should not endanger the institution itself." This is especially clear from clause xvi., which decrees that the title and estates of the lords-tenant of counties should not be hereditary, thus attacking feudalism at its very roots, while clause xiv. provides for the degradation of any lord-tenant who should abuse his office. On the other hand, the principle of the exemption of all the nobles from taxation is confirmed, as well as their right to refuse military service abroad, the defence of the realm being their sole obligation. All nobles were also to have the right to appear at the court which was to be held once a year at Székesfehérvár, by the king, or in his absence by the palatine,¹ for the purpose of hearing causes. A clause also guarantees all nobles against arbitrary arrest and punishment at the instance of any powerful person.

This famous charter, which was amplified, under the influence of the clergy, in 1231, when its articles were placed under the guardianship of the archbishop of Esztergom (who was authorized to punish their violation by the king with excommunication), is generally regarded as the foundation of Hungarian constitutional liberty, though like Magna Carta it purported only to confirm immemorial rights; and as such it was expressly ratified as a whole in the coronation oaths of all the Habsburg kings from Ferdinand to Leopold I. Its actual effect in the period succeeding its issue was, however, practically nugatory; if indeed it did not actually give a new handle to the subversive claims of the powerful barons.

Béla IV. (1235-1270), the last man of genius whom the Árpáds produced, did something to curb the aristocratic misrule which was to be one of the determining causes of the collapse of his dynasty. But he is best known as the regenerator of the realm after the cataclysm of 1241-1242 (see BÉLA IV.). On his return from exile, after the subsidence of the Tatar deluge, he found his kingdom in ashes; and his two great remedies, wholesale immigration and castle-building, only sowed the seeds of fresh disasters. Thus the Kumanian colonists, mostly pagans, whom he settled in vast numbers on the waste lands, threatened to overwhelm the Christian population; while the numerous strongholds, which he encouraged his nobles to build as a protection against future Tatar invasions, subsequently became so many centres of disloyalty. To bind the Kumanian still more closely to his dynasty, Béla married his son Stephen V.

Stephen V. and Ladislaus IV. (1270-1272) to a Kumanian girl, and during the reign of her son Ladislaus IV. (1272-1290) the court was certainly more pagan than Christian. Valiant and enterprising as both these princes were (Stephen successfully resisted the aggressions of the brilliant "golden King," Ottakar II. of Bohemia, and Ladislaus materially contributed to his utter overthrow at Durnkrüt in 1278), neither of them was strong enough to make head against the disintegrating influences all around them. Stephen contrived to hold his own by adroitly contracting an alliance with the powerful Neapolitan Angevins who had the ear of the pope; but Ladislaus (q.v.)

End of the Árpád Dynasty. was so completely caught in the toils of the Kumanians, that the Holy See, the suzerain of Hungary, was forced to intervene to prevent the relapse of the kingdom into barbarism; and the unfortunate Ladislaus perished in the crusade that was preached against him. An attempt of a patriotic party to keep the last Árpád, Andrew III. (1290-1301), on the throne was only temporarily successful, and after a horrible eight years' civil war (1301-1308) the crown of St Stephen finally passed into the capable hands of Charles Robert of Naples.

During the four hundred years of the Árpád dominion the nomadic Magyar race had established itself permanently in central Europe, adopted western Christianity and founded a national monarchy on the western model. Hastily and violently converted, driven like a wedge between the Eastern and the Western Empires, the young kingdom was exposed from the first to extraordinary perils. But, under the guidance of a

series of eminent rulers, it successfully asserted itself alike against pagan reaction from within, and aggressive pressure from without, and, as it grew in strength and skill, expanded territorially at the expense of all its neighbours. These triumphs were achieved while the monarchy was absolute, and thus able to concentrate in its hands all the resources of the state, but towards the end of the period a political revolution began. The weakness and prodigality of the later Árpáds, the depopulation of the realm during the Tatar invasion, the infiltration of western feudalism and, finally, the endless civil discords of the 13th century, brought to the front a powerful and predacious class of barons who ultimately overshadowed the throne. The ancient county system was gradually absorbed by this new governing element. The ancient royal tenants became the feudatories of the great nobles, and fell naturally into two classes, the *nobiles bene possessionati*, and the *nobiles minus servituti*, in other words the richer and the poorer gentry. We cannot trace the gradations of this political revolution, but we know that it met with determined opposition from the crown, which resulted in the utter destruction of the Árpáds, who, while retaining to the last their splendid physical qualities, now exhibited unmistakable signs of moral deterioration, partly due perhaps to their too frequent marriages with semi-Oriental Greeks and semi-savage Kumanians. On the other hand the great nobles were the only class who won for themselves a recognized political position. The tendency towards a representative system of government had begun, but the almost uninterrupted anarchy which marked the last thirty years of the Árpád rule was no favourable time for constitutional development. The kings were fighting for their lives, the great nobles were indistinguishable from brigands and the whole nation seemed to be relapsing into savagery.

It was reserved for the two great princes of the house of Anjou, Charles I. (1310-1342) and Louis I. (1342-1382), to rebuild the Hungarian state, and lead the Magyars back to civilization. Both by character and education they were eminently fitted for the task, and all the circumstances were in their favour. They brought from their native Italy a thorough knowledge of the science of government as the middle ages understood it, and the decimation of the Hungarian magnates during the civil wars enabled them to re-create the noble hierarchy on a feudal basis, in which full allowance was made for Magyar idiosyncracies. Both these monarchs were absolute. The national assembly (*Országgyűlés*) was still summoned occasionally, but at very irregular intervals, the real business of the state being transacted in the **Reforms of Louis I.** royal council, where able men of the middle class, principally Italians, held confidential positions. The lesser gentry were protected against the tyranny of the magnates, encouraged to appear at court and taxed for military service by the royal treasury direct—so as to draw them closer to the crown. Scores of towns, too, owe their origin and enlargement to the care of the Angevin princes, who were lavish of privileges and charters, and saw to it that the high-roads were clear of robbers. Charles, moreover, was a born financier, and his reform of the currency and of the whole fiscal system greatly contributed to enrich both the merchant class and the treasury. Louis encouraged the cities to surround themselves with strong walls. He himself erected a whole cordon of forts round the flourishing mining towns of northern Hungary. He also appointed Hungarian consuls in foreign trade centres, and established a system of protective tariffs. More important in its ulterior consequences to Hungary was the law of 1351 which, while confirming the Golden Bull in general, abrogated the clause (iv.) by which the nobles had the right to alienate their lands. Henceforward their possessions were to descend directly and as of right to their brothers and their issue, whose claim was to be absolute. This "principle of aviticity" (*örökös aviticium*), which survived till 1848, was intended to preserve the large feudal estates as part of the new military system, but its ultimate effect was to hamper the development of the country by preventing the alienation, and therefore the mortgaging of

¹ The full title of the palatine (Mag. *nádor* or *nádor-ispán*, Lat. *palatinus*) was *comes palatii regni*, the first palatine being Abu Samuel (c. 1041). By the Golden Bull the palatine acquired something of the quality of a responsible minister, as "intermediary between the crown and people, guardian of the nation's rights, and keeper of the king's conscience" (*Knatchbull-Hugessen*, i. 30).

lands, so long as any, however distant, scion of the original owning family survived.¹ Louis's efforts to increase the national wealth were also largely frustrated by the Black Death, which ravaged Hungary from 1347 to 1360, and again during 1380-1381, carrying off at least one-fourth of the population.

Externally Hungary, under the Angevin kings, occupied a commanding position. Both Charles and Louis were diplomatists as well as soldiers, and their foreign policy, largely based on family alliances, was almost invariably successful. Charles married Elizabeth, the sister of Casimir the Great of Poland, with whom he was connected by ties of close friendship, and Louis, by virtue of a compact made by his father thirty-one years previously, added the Polish crown to that of Hungary in 1370. Thus, during the last twelve years of his reign, the dominions of Louis the Great included the greater part of central Europe, from Pomerania to the Danube, and from the Adriatic to the steppes of the Dnieper.

The Angevins were less successful towards the south, where the first signs were appearing of that storm which ultimately swept away the Hungarian monarchy. In 1353 the Ottoman

Turkish invasions.

Turks crossed the Hellespont from Asia Minor and began that career of conquest which made them the terror of Europe for the next three centuries. In 1360 they conquered southern Bulgaria. In 1365 they transferred their capital from Brusa to Adrianople. In 1371 they overwhelmed the Servian tsar Vukashin at the battle of Tearnus and penetrated to the heart of old Servia. In 1380 they threatened Croatia and Dalmatia. Hungary herself was now directly menaced, and the very circumstances which had facilitated the advance of the Turks, enfeebled the potential resistance of the Magyars. The Árpád kings had succeeded in encircling their whole southern frontier with half a dozen military colonies or banates, comprising, roughly speaking, Little Walachia,² and the northern parts of Bulgaria, Servia and Bosnia. But during this period a redistribution of territory had occurred in these parts, which converted most of the old banates into semi-independent and violently anti-Magyar principalities. This was due partly to the excessive proselytizing energy of the Angevins, which provoked rebellion on the part of their Greek-Orthodox subjects, partly to the natural dynastic competition of the Servian and Bulgarian tsars, and partly to the emergence of a new nationality, the Walachian. Previously to 1320, what is now called Walachia was regarded by the Magyars as part of the banate of Szörény. The base of the very mixed and ever-shifting population in these parts were the Vlachs (Rumanians), perhaps the descendants of Trajan's colonists, who, under their voivode, Bazarad, led King Charles into an ambushade from which he barely escaped with his life (Nov. 9-12, 1330). From this disaster are to be dated the beginnings of Walachia as an independent state. Moldavia, again, ever since the 11th century, had been claimed by the Magyars as forming, along with Bessarabia and the Bukovina, a portion of the semi-mythical Etelköz, the original seat of the Magyars before they occupied modern Hungary. This desolate region was subsequently peopled by Vlachs, whom the religious persecutions of Louis the Great had driven thither from other parts of his domains, and, between 1350 and 1360, their voivode Bogdan threw off the Hungarian yoke altogether. In Bosnia the persistent attempts of the Magyar princes to root out the stubborn, crazy and poisonous sect of the Bogomils had alienated the originally amicable Bosnians, and in 1353 Louis was compelled to buy the friendship of their Bar Tvrtko by acknowledging him as king of Bosnia. Both Servia and Bulgaria were by this time split up into half a dozen principalities which, as much for religious as for political reasons, preferred paying tribute to the Turks to acknowledging the hegemony of Hungary. Thus, towards the end of his reign, Louis found himself cut off from the Greek emperor, his sole ally in the Balkans, by a chain of bitterly hostile Greek-Orthodox states, extending from the Black Sea to the Adriatic. The

The Vlachs.

commercial greed of the Venetians, who refused to aid him with a fleet to cut off the Turks in Europe from the Turks in Asia Minor, nullified Louis' last practical endeavour to cope with a danger which from the first he had estimated at its true value.

Louis the Great left two infant daughters: Maria, who was to share the throne of Poland with her betrothed, Sigismund of Pomerania, and Hedwig, better known by her Polish name of Jadwiga, who was to reign over Hungary with her young bridegroom, William of Austria. This plan was upset by the queen-dowager Elizabeth, who determined to rule both kingdoms during the minority of her children. Maria, her favourite, with whom she refused to part, was crowned queen of Hungary a week after her father's death (Sept. 17, 1382). Two years later Jadwiga, reluctantly transferred to the Poles instead of her sister, was crowned queen of Poland at Cracow (Oct. 15, 1384) and subsequently compelled to marry Jagiello, grand-duke of Lithuania. In Hungary, meanwhile, impatience at the rule of women induced the great family of the Horváthys to offer the crown of St Stephen to Charles III. of Naples, who, despite the oath of loyalty he had sworn to his benefactor, Louis the Great, accepted the offer, landed in Dalmatia with a small Italian army, and, after occupying Buda, was crowned king of Hungary on the 31st of December, 1385, as Charles II. His reign lasted thirty-eight days. On the 7th of February, 1386, he was treacherously attacked in the queen-dowager's own apartments, at her instigation, and died of his injuries a few days later. But Elizabeth did not profit long by this atrocity. In July the same year, while on a pleasure trip with her daughter, she was captured by the Horváthys, and tortured to death in her daughter's presence. Maria herself would doubtless have shared the same fate, but for the speedy intervention of her *fiancé*, whom a diet, by the advice of the Venetians, had elected to rule the headless realm on the 31st of March 1387. He married Maria in June the same year, and she shared the sceptre with him till her sudden death by accident on the 17th of May 1395.

During the long reign of Sigismund (1387-1437) Hungary was brought face to face with the Turkish peril in its most threatening shape, and all the efforts of the king were directed towards combating or averting it. However sorry a figure Sigismund may have cut as emperor in Germany, as king of Hungary he claims our respect, and as king of Hungary he should be judged, for he ruled her, not unsuccessfully, for fifty years during one of the most difficult crises of her history, whereas his connexion with Germany was at best but casual and transient.³ From the first he recognized that his chief duty was to drive the Turks from Europe, or, at least, keep them out of Hungary, and this noble ambition was the pivot of his whole policy. A domestic rebellion (1387-1395) prevented him at the outset from executing his design till 1396, and if the hopes of Christendom were shattered at Nicopolis, the failure was due to no fault of his, but to the haughty insubordination of the feudal levies. Again, his inaction during those memorable twelve years (1401-1413) when the Turkish empire, after the collapse at Angora (1402), seemed about to be swallowed up by "the great wolf" Tamerlane, was due entirely to the malice of the Holy See, which, enraged at his endeavours to maintain the independence of the Magyar church against papal aggression (the diet of 1404, on Sigismund's initiative, had declared bulls bestowing Magyar benefices on foreigners, without the royal consent, pernicious and illegal), saddled him with a fresh rebellion and two wars with Venice, resulting ultimately in the total loss of Dalmatia (c. 1430). Not till 1400 could Sigismund be said to be king in his own realm, yet in 1413 we find him traversing Europe in his endeavour to terminate the Great Schism, as the first step towards uniting Christendom once more against the Turk. Hence the council of Constance to depose three rival popes; hence the council of Basel to pacify the Hussites, and promote another anti-Moslem league. But by this time the Turkish

¹ Knatchbull-Hugessen, i. 41.

² That is to say the western portion of Walachia, which lies between the Aluta and the Danube.

³ Though elected king of the Romans in 1411, he cannot be regarded as the legal emperor till his coronation at Rome in 1423, and if he was titular king of Bohemia as early as 1419, he was not acknowledged as king by the Czechs themselves till 1436.

empire had been raised again from its ruins by Mahommed I. (1402-1421), and resumed its triumphal progress under Murad II. (1421-1451). Yet even now Sigismund, at the head of his Magyars, thrice (1422-1424, 1426-1427, and 1430-1431) encountered the Turks, not ingloriously, in the open field, till, recognizing that Hungary must thenceforth rely entirely on her own resources in any future struggle with Islam, he elaborately fortified the whole southern frontier, and converted the little fort of Nándorfehérvár, later Belgrade, at the junction of the Danube and Save, into an enormous first-class fortress, which proved strong enough to repel all the attacks of the Turks for more than a century. It argued no ordinary foresight thus to recognize that Hungary's strategy in her contest with the Turks must be strictly defensive, and the wisdom of Sigismund was justified by the disasters which almost invariably overcame the later Magyar kings whenever they ventured upon aggressive warfare with the sultans.

A monarch so overburdened with cares was naturally always in need of money,¹ and thus obliged to lean heavily upon the support of the estates of the realm. The importance and influence of the diet increased proportionately. It met every year, sometimes twice a year, during Sigismund's reign, and was no longer, as in the days of Louis the Great, merely a consultative council, but a legislative body in partnership with the king. It was still, however, essentially an assembly of notables, lay and clerical, at which the gentry, though technically eligible, do not seem to have been directly represented. At Sigismund's first diet (1397) it was declared that the king might choose his counsellors where he listed, and at the diet of 1397 he invited the free and royal towns to send their deputies to the parliament. Subsequently this privilege was apparently erected into a statute, but how far it was acted upon we know not. Sigismund, more fortunate than the Polish kings, seems to have had little trouble with his diets. This was largely due to his friendly intimacy with the majority of the Magyar notables, from among whom he chose his chief counsellors. The estates loyally supported him against the attempted exactions of the popes, and do not seem to have objected to any of his reforms, chief among which was the army-reform project of 1435, to provide for the better defence of the land against the Turks. This measure obliged all the great dignitaries, and the principal towns also, according to their means, to maintain a *banderium* of five hundred horsemen, or a proportional part thereof, and hold it ready, at the first summons, thus supplying the crown with a standing army 76,875 strong. In addition to this, a reserve force called the *telekatonaság* was recruited from among the lesser gentry according to their *teleks* or holdings, every thirty-three *teleks* being held responsible for a mounted and fully equipped archer. Moreover, river fleets, built by Genoese masters and manned by Servians, were constructed to patrol and defend the great rivers of Hungary, especially on the Turkish frontier. Much as he owed to them, however, Sigismund was no mere nobles' king. His care for the common people was sincere and constant, but his beneficial efforts in this direction were thwarted by the

curious interaction of two totally dissimilar social factors, feudalism and Hussitism. In Sigismund's reign the feudal system, for the first time, became deeply rooted in Magyar soil, and it is a lamentable fact that in 15th-century Hungary it is to be seen at its very worst, especially in those wild tracts, and they were many, in which the king's writ could hardly be said to run. Simultaneously from the west came the Hussite propagandists teaching that all men were equal, and that all property should be held in common. The suffering Magyar multitudes eagerly responded to these seductive teachings, and the result was a series of dangerous popular risings (the worst in 1433 and 1436) in which heresy and communism were inextricably intermingled. With the aid of inquisitors from Rome, the evil was literally burnt out, but not before provinces, especially in the south and

¹ In 1412 he pawned the twenty-four Zips towns to Poland, and, in 1411 he pledged his margraviate of Brandenburg to the Hohenzollerns.

south-east, had been utterly depopulated. They were re-peopled by Vlachs.

Yet despite the interminable wars and rebellions which darken the history of Hungary in the reign of Sigismund, the country, on the whole, was progressing. Its ready response to the king's heavy demands for the purpose of the national defence points to the existence of a healthy and self-sacrificing public spirit, and the eagerness with which the youth of all classes now began to flock to the foreign universities is another satisfactory feature of the age. Between 1362 and 1450 no fewer than 4151 Magyar students frequented the university of Vienna, nearly as many went by preference to Prague, and this, too, despite the fact that there were now two universities in Hungary itself, the old foundation of Louis the Great at Pécs, and a new one established at Buda by Sigismund.

Like Louis the Great before him, Sigismund had failed to found a dynasty, but, fifteen years before his death, he had succeeded in providing his only daughter Elizabeth with a consort apparently well able to protect both her and her inheritance in the person of Albert V., duke of Austria. Albert, a sturdy soldier, who had given brilliant proofs of valour and generalship in the Hussite wars, was crowned king of Hungary at Székesfehérvár (Stuhlweissenburg) on the 1st of January 1438, elected king of the Romans at Frankfort on the 18th of March 1438, and crowned king of Bohemia at Prague on the 29th of June 1438. On returning to Buda in 1439, he at once plunged into a war with the Turks, who had, in the meantime, captured the important Servian fortress of Smedocria and subjugated the greater part of Bosnia. But the king got no farther than Servia, and was carried off by dysentery (Oct. 27, 1439), in the forty-second year of his age, in the course of the campaign.

Albert left behind him two infant daughters only, but his consort was big with child, and, in the event of that child proving to be an heir male, his father's will bequeathed to him the kingdoms of Hungary and Bohemia, under the regency of his mother. Thus, with the succession uncertain, with the Turk at the very door, with the prospect, dismal at the best, of a long minority, the political outlook was both embarrassing and perilous. Obviously a warrior-king was preferable to a regimen of women and children, and the eyes of the wiser Magyars turned involuntarily towards Wladislaus III. of Poland, who, though only in his nineteenth year, was already renowned for his martial disposition. Wladislaus accepted the proffered throne from the Magyar delegates at Cracow on the 8th of March 1440; but in the meantime (Feb. 22) the queen-widow gave birth to a son who, six weeks later, as Ladislaus V. (q.v.) was crowned king of Hungary (May 15) at Székesfehérvár. On the 22nd of May the Polish monarch appeared at Buda, was unanimously elected king of Hungary under the title of Wladislaus I. (June 24) and crowned on the 17th of July. This duoregnum proved even more injurious to Hungary than the dreaded interregnum. Queen Elizabeth, aided by her kinsmen, the emperor Frederick III. and the counts of Cilli, flooded northern and western Hungary with Hussite mercenaries, one of whom, Jan Giszkra, she made her captain-general, while Wladislaus held the central and south-eastern parts of the realm. The resulting civil war was terminated only by the death of Elizabeth on the 13th of December 1443.

All this time the pressure of the Turks upon the southern provinces of Hungary had been continuous, but fortunately all their efforts had so far been frustrated by the valour and generalship of the ban of Szörény, John Hunyadi, the fame of whose victories, notably in 1442 and 1443, encouraged the Holy See to place Hungary for the third time at the head of a general crusade against the infidel. The experienced diplomatist Cardinal Cesarini was accordingly sent to Hungary to reconcile Wladislaus with the emperor. The king, who had just returned from the famous "long campaign" of 1443, willingly accepted the leadership of the Christian League. At the diet of Buda, early in 1444, supplies were voted for the enterprise, and Wladislaus was on the point of quitting

John
Hunyadi.

his camp at Szeged for the seat of war, when envoys from Sultan Murad arrived with the offer of a ten years' truce on such favourable conditions (they included the relinquishment of Servia, Walachia and Moldavia, and the payment of an indemnity) that Hunyadi persuaded the king to conclude (in July) a peace which gave him more than could reasonably be anticipated from the most successful campaign. Unfortunately, two days later, Cardinal Cesarini absolved the king from the oath whereby he had sworn to observe the peace of Szeged, and was thus mainly responsible for the catastrophe of Varna, when four months later (Nov. 10) the young monarch and the flower of the Magyar chivalry were overwhelmed by fourfold odds on Turkish soil. (See HUNYADI, JÁNOS; and WLADISLAUS III.)

The next fourteen years form one of the most interesting and pregnant periods of Hungarian history. It marks the dawn of a public spirit as represented by the gentry, who, alarmed at the national peril and justly suspicious of the ruling magnates, unhesitatingly placed their destinies in the hands of Hunyadi, the one honest man who by sheer merit had risen within the last ten years from the humble position of a country squire to a leading position in the state. This feeling of confidence found due expression at the diet of 1446, which deliberately passing over the palatine László Garai elected Hunyadi governor of Hungary, and passed a whole series of popular measures intended to be remedial, e.g. the decree ordering the demolition of the new castles, most of them little better than robber-strongholds; the decree compelling the great officers of state to suspend their functions during the session of the diet; the decree declaring illegal the new fashion of forming confederations on the Polish model, all of which measures were obviously directed against the tyranny and the lawlessness of the oligarchy. Unfortunately this salutary legislation remained a dead letter. It was as much as the governor could do to save the state from destruction, let alone reform it. At this very time northern Hungary, including the wealthy mining towns, was in the possession of the Hussite mercenary Jan Giszka, who held them nominally for the infant king Ladislaus V., still detained at Vienna by his kinsman the emperor. The western provinces were held by Frederick himself. Invaluable time was wasted in negotiating with these intruders before the governor could safely devote himself to the task of expelling the Turk from the southern provinces. He had to be content with armistices, reconciliations and matrimonial contracts, because the great dignitaries of the state, men like the palatine László Garai, Count Ulrich of Cilli, and the voivode of Transylvania, Mihály Ujlaky, thwarted in every way the *novus homo* whom they hated and envied. From them, the official guardians of Hungary's safety, he received no help, either during his governorship (1446-1453), or when, in 1454, on the eve of his departure for his last and most glorious campaign, the diet commanded a *levée en masse* of the whole population in his support. At that critical hour it was at his own expense that Hunyadi fortified Belgrade, now the sole obstacle between Hungary and destruction, with the sole assistance of the Franciscan friar Giovanni da Capistrano, equipped the fleet and the army which relieved the beleaguered fortress and overthrew Mahommed II. But the nation at least was grateful, and after his death (Aug. 11, 1456) it freely transferred its allegiance to his family as represented by his two sons, László, now in his 23rd, and Matthias, now in his 16th year. The judicial murder of László Hunyadi (q.v.) by the enemies of his house (March 16, 1457) was therefore a stupid blunder as well as the foulest of crimes, and on the death of his chief assassin, Ladislaus V., six months later (Nov. 23, 1457), the diet which assembled on the banks of the Rákos, in defiance of the magnates and all foreign competitors, unanimously and enthusiastically elected Matthias Hunyadi king of Hungary (Jan. 24, 1458).

In less than three years the young king had justified their confidence, and delivered his country from its worst embarrassments. (See MATTHIAS I., king of Hungary.) This *Matthias I.* prodigy was accomplished in the face of every conceivable obstacle. His first diet grudgingly granted him

supplies and soldiers for the Turkish war, on condition that under no circumstances whatever should they henceforth be called upon to contribute towards the national defence, and he was practically deprived of the control of the *banderia* or mounted militia. It was with a small force of mercenaries, raised at his own expense, that the young king won his first Turkish victories, and expelled the Czechs from his northern and the Habsburgs from his western provinces. But his limited resources, and, above all, the proved incapacity of the militia in the field, compelled him instantly to take in hand the vital question of army reform. In the second year of his reign he undertook personally the gigantic task of providing Hungary with an army adequate to her various needs on the model of the best military science of the day. The landless younger sons of the gentry and the Servian and Vlach immigrants provided him with excellent and practically inexhaustible military material. The old feudal levies he put aside. Brave enough personally, as soldiers they were distinctly inferior both to the Janissaries and the Hussites, with both of whom Matthias had constantly to contend. It was a trained regular army in his pay and consequently at his disposal that he wanted. The nucleus of the new army he found in the Czech mercenaries, seasoned veterans who readily transferred their services to the best payer. This force, formed in 1459, was generally known as the *Fekete Sereg*, or "Black Brigade," from the colour of its armour. From 1465 the pick of the Magyars and Croatians were enlisted in the same way every year, till, towards the end of his reign, Matthias could count upon 20,000 horse and 8000 foot, besides 6000 black brigadiers. The cavalry consisted of the famous Hussars, or light horse, of which he may be said to have been the creator, and the heavily armed mounted musketeers on the Czech-German model. The infantry, in like manner, was divided into light and heavy. This army was provided with a regular commissariat, cannon and ballistic machines, and, being constantly on active service, was always in a high state of efficiency. The land forces were supported by a river fleet consisting (in 1479) of 360 vessels, mostly sloops and corvettes, manned by 2600 sailors, generally Croats, and carrying 10,000 soldiers. Eight large military stations were also built at the chief strategic points on the Danube, Save and Theiss. These armaments, which cost Matthias 1,000,000 florins per annum, equivalent to £200,000, did not include the auxiliary troops of the hospodars of Walachia and Moldavia, or the feudal levies of the barons and prelates.

The army of Matthias was not only a military machine of first-rate efficiency, but an indispensable civilizing medium. It enabled the king to curb the lawlessness of the Magyar nobility, and explains why none of the numerous rebellions against him ever succeeded. Again and again, during his absence on the public service, the barons and prelates would assemble to compass his ruin or dispose of his crown, when, suddenly, "like a tempest," from the depths of Silesia or of Bosnia, he would himself appear among them, confounding and scattering them, often without resistance, always without bloodshed. He also frequently employed his soldiers in collecting the taxes from the estates of those magnates who refused to contribute to the public burdens, in protecting the towns from the depredations of the robber barons, or in conveying the caravans of the merchants. In fact, they were a police force as well as an army.

Despite the enormous expense of maintaining the army, Matthias, after the first ten years of his reign, was never in want of money. This miracle was achieved by tact and management. No Hungarian king had so little trouble with the turbulent diet as Matthias. By this time the gentry, as well as the barons and prelates, took part in the legislature. But attendance at the diet was regarded by the bulk of the poorer deputies as an intolerable burden, and they frequently agreed to grant the taxes for two or three years in advance, so as to be saved the expense

¹ Some of these were of gigantic size, e.g. the Varga Mosaic, or great mortar, which sixty horses could scarce move from its place, and a ballistic machine invented by Matthias which could hurl stones of 3 cwt.

of attending every year. Moreover, to promote their own convenience, they readily allowed the king to assess as well as to collect the taxes, which consequently tended to become regular and permanent, while Matthias' reform of the treasury, which was now administered by specialists with separate functions, was economically of great benefit to the state. Yet Matthias never dispensed with the diet. During the thirty-two years of his reign he held at least fifteen diets,¹ at which no fewer than 450 statutes were passed. He re-codified the Hungarian common law; strictly defined the jurisdiction of the whole official hierarchy from the palatine to the humblest village judge; cheapened and accelerated legal procedure, and in an age when might was right did his utmost to protect the weak from the strong. There is not a single branch of the law which he did not simplify and amend, and the iron firmness with which he caused justice to be administered, irrespective of persons, if it exposed him to the charge of tyranny from the nobles, also won for him from the common people the epithet of "the Just." To Matthias is also due the credit of creating an efficient official class. Merit was with him the sole qualification for advancement. One of his best generals, Pál Kinizsy, was a miller's son, and his capable chancellor, Péter Várady, whom he made archbishop of Kálcsa, came of a family of small squires. For education so scholarly a monarch as Matthias naturally did what he could. He founded the university of Pressburg (*Academia Istropolitana*, 1467), revived the declining university of Pécs, and, at the time of his death, was meditating the establishment of a third university at Buda.

Unfortunately the civilizing efforts of Matthias made but little impression on society at large. The bulk of the Magyar nobility was still semi-barbaric. Immensely wealthy (it is estimated that most of the land, at this time, was in the hands of 25 great families, the Zapolyas alone holding an eighth of it), it was a point of honour with them to appear in public in costly raiment ablaze with silver, gold and precious stones, followed at every step by armies of retainers scarcely less gorgeous. At the same time their ignorance was profound. Many of the highest dignitaries of state did not know their alphabet. Signatures to documents of the period are rare; seals served instead of signatures, because most of the nobles were unable to sign their names. Learning, indeed, was often ridiculed as pedantry in a gentleman of good family.

The clergy, the chief official class, were naturally less ignorant than the gentry. Some of the prelates—notably János Csezmecezy, better known as Janus Faanonius (1433-1472)—had a European reputation for learning. The primate Cardinal, János Vitez (1408-1472), at the beginning, and the primate, Cardinal Tamas Bakócz (*q.v.*), at the end of the reign were men of eminent ability and the highest culture. But the moral tone of the Magyar church at this period was very low. The bishops prided themselves on being great statesmen, great scholars, great financiers, great diplomatists—anything, in fact, but good Christians. Most of them, except when actually celebrating mass, were indistinguishable alike in costume and conduct from the temporal magnates. Of twelve of them it is said that foreigners took them at first for independent temporal princes, so vast were their estates, so splendid their courts, so numerous their armed retainers. Under such guides as these the lower clergy erred deplorably, and drunkenness, gross immorality, brawling and manslaughter were common occurrences in the lives of the parish priests. The regular clergy were if possible worse than the secular, with the exception of the Paulicians, the sole religious order which steadily resisted the general corruption, of whose abbot, the saintly Gregory, was the personal friend of Matthias.

What little culture there was outside the court, the capital and the palaces of a few prelates, was to be found in the towns, most of them of German origin. Matthias laboured strenuously to develop and protect the towns, multiplied municipal charters, and materially improved the means of communication, especially in

¹ We know actually of fifteen, but there may have been many more.

Transylvania. His Silesian and Austrian acquisitions were also very beneficial to trade, throwing open as they did the western markets to Hungarian produce. Wine and meat were the chief exports. The wines of Hungary were already renowned throughout Europe, and cattle breeding was conducted on a great scale. Of agricultural produce there was barely sufficient for home consumption, but the mining industries had reached a very high level of excellence, and iron, tin and copper were very largely exported from the northern counties to Danzig and other Baltic ports. So highly developed indeed were the Magyar methods of smelting, that Louis XI. of France took the Hungarian mining system as the model for his metallurgical reforms, and Hungarian master-miners were also in great demand at the court of Ivan the Terrible. Moreover, the keen artistic instincts of Matthias led him to embellish his cities as well as fortify them. Debreczen was practically rebuilt by him, and dates its prosperity from his reign. Breslau, his favourite town, he endowed with many fine public buildings. Buda he endeavoured to make the worthy capital of a great realm, and the palace which he built there was pronounced by the papal legates to be superior to any in Italy.

Politically Matthias raised Hungary to the rank of the greatest power in central Europe, her influence extending into Asia and Africa. Poland was restrained by his alliances with the Teutonic Knights and the tsardom of Muscovy, ^{Power in Europe.} and his envoys appeared in Persia and in Egypt to combat the diplomacy of the Porte. He never, indeed, jeopardized the position of the Moslems in Europe as his father had done, and thus the peace of Szeged (1444), which regained the line of the Danube and drove the Turk behind the Balkans, must always be reckoned as the high-water mark of Hungary's Turkish triumphs. But Matthias at least taught the sultan to respect the territorial integrity of Hungary, and throughout his reign the Eastern Question, though often vexatious, was never acute. Only after his death did the Ottoman empire become a menace to Christendom. Besides, his hands were tied by the unappeasable enmity of the emperor and the emperor's allies, and he could never count upon any material help from the West against the East. The age of the crusades had gone. Throughout his reign the Czechs and the Germans were every whit as dangerous to Hungary as the Turks, and the political necessity which finally compelled Matthias to partition Austria and Bohemia, in order to secure Hungary, committed him to a policy of extreme circumspection. He has sometimes been blamed for not crushing his incurably disloyal and rebellious nobles, instead of cajoling them, after the example of his contemporary, Louis XI., who laid the foundations of the greatness of France on the ruin of the vassals. But Louis XI. had a relatively civilized and politically developed middle class behind him, whereas Matthias had not. It was as much as Matthias could do to keep the civic life of Hungary from expiring altogether, and nine-tenths of his burgesses were foreigners with no political interest in the country of their adoption. Never was any dominion so purely personal, and therefore so artificial as his. His astounding energy and resource curbed all his enemies during his lifetime, but they were content to wait patiently for his death, well aware that the collapse of his empire would immediately follow.

All that human foresight could devise for the consolidation and perpetuation of the newly established Hungarian empire had been done by Matthias in the last years of his reign. He had designated as his successor his natural son, ^{Period of decline.} the highly gifted János (John) Corvinus, a youth of seventeen. He had raised him to princely rank, endowed him with property which made him the greatest territorial magnate in the kingdom, placed in his hands the sacred crown and half-a-dozen of the strongest fortresses, and won over to his cause the majority of the royal council. How János was cajoled out of an almost impregnable position, and gradually reduced to insignificance, is told elsewhere (see CORVINUS, JÁNOS). The nobles and prelates, who detested the severe and strenuous ^{Wladislaus II.} Matthias system, desired, as they expressed it, "a king whose beard they could hold in their fists," and they found a monarch after their own heart in Wladislaus Jagiello, since 1471

king of Bohemia, who as Wladislaus II. was elected unanimously king of Hungary on the 15th of July 1400. Wladislaus was the personification of helpless inertia. His Bohemian subjects had long since dubbed him "King All Right" because he said yes to everything. As king of Hungary he was, from first to last, the puppet of the Magyar oligarchs, who proceeded to abolish all the royal prerogatives and safeguards which had galled them under Matthias. By the compact of Farkashida (1400) Wladislaus not only confirmed all the Matthias privileges, but also repealed all the Matthias novelties, including the system of taxation which had enabled his predecessor to keep on foot an adequate national army. The virtual suppression of Wladislaus was completed at the diet of 1402, when "King All Right" consented to live on the receipts of the treasury, which were barely sufficient to maintain his court, and engaged never to impose any new taxes on his Magyar subjects. The dissolution of the standing army, including the Black Brigade, was the immediate result of these decrees. Thus, at the very time when the modernization of the means of national defence had become the first principle, in every other part of Europe, of the strongly centralized monarchies which were rising on the ruins of feudalism, the Hungarian magnates deliberately plunged their country back into the chaos of medievalism. The same diet which destroyed the national armaments and depleted the exchequer confirmed the disgraceful peace of Pressburg, concluded between Wladislaus and the emperor Maximilian on the 7th of November 1401, whereby Hungary retroceded all the Austrian conquests of Matthias, together with a long strip of Magyar territory, and paid a war indemnity equivalent to £200,000.

The thirty-six years which elapsed between the accession of Wladislaus II. and the battle of Mohács is the most melancholy and discreditable period of Hungarian history. Like Poland two centuries later, Hungary had ceased to be a civilized autonomous state because her prelates and her magnates, uncontrolled by any higher authority, and too ignorant or corrupt to look beyond their own immediate interests, abandoned themselves to the exclusive enjoyment of their inordinate privileges, while openly repudiating their primal obligation of defending the state against extraneous enemies. During these miserable years everything like patriotism or public spirit seems to have died out of the hearts of the Hungarian aristocracy. The great officers of state acted habitually on the principle that might is right. Stephen Bathóry, voivode of Transylvania and count of the Széklers, for instance, ruled Transylvania like a Turkish pasha, and threatened to behead all who dared to complain of his exactions; "Stinking carrion," he said, was better than living Széklers. Thousands of Transylvanian gentlemen emigrated to Turkey to get out of his reach. Other great nobles were at perpetual feud with the towns whose wealth they coveted. Thus the Zapolyas, in 1500 and again in 1507, burnt a large part of Breznóbánya and Besztercebánya, two of the chief industrial towns of north Hungary. Kronstadt, now the sole flourishing trade centre in the kingdom, defended itself with hired mercenaries against the robber barons. Everywhere the civic communities were declining; even Buda and Pressburg were half in ruins. In their misery the cities frequently appealed for protection to the emperor and other foreign potentates, as no redress was attainable at home. Compared even with the contemporary Polish diet the Hungarian national assembly was a tumultuous mob. The diet of 1497 passed most of its time in constructing, and then battering to pieces with axes and hammers, a huge wooden image representing the ministers of the crown, who were corrupt enough, but immovable, since they regularly appeared at the diet with thousands of retainers armed to the teeth, and openly derided the reforming endeavours of the lower gentry, who perceived that something was seriously wrong, yet were powerless to remedy it. All that the gentry could do was to depress the lower orders, and this they did at every opportunity. Thus, many of the towns, notably Visegrád, were deprived of the charters granted to them by Matthias, and a whole series of anti-civic ordinances were passed. Noblemen dwelling within the walls of the towns were especially exempted from all civic burdens,

while every burgher who bought an extra-mural estate was made to pay double for the privilege.¹ Every nobleman had the right to engage in trade toll-free, to the great detriment of their competitors the burghers. The peasant class suffered most of all. In 1406 Varady, archbishop of Kalocsa, one of the few good prelates, declared that their lot was worse than that of brute beasts. The whole burden of taxation rested on their shoulders, and so ground down were they by ingeniously multiplied exactions, that thousands of them were reduced to literal beggary.

Yet, despite this inward rottenness, Hungary, for nearly twenty years after the death of Matthias, enjoyed an undeserved prestige abroad, due entirely to the reputation which that great monarch had won for her. Circumstances, indeed, were especially favourable. The emperor Maximilian was so absorbed by German affairs, that he could do her little harm, and under Bayezid II. and Selim I. the Turkish menace gave little anxiety to the court of Buda, Bayezid being no warrior, while Selim's energies were claimed exclusively by the East, so that he was glad to renew the triennial truce with Hungary as often as it expired. Hungary, therefore, for almost the first time in her history, was free to choose a foreign policy of her own, and had she been guided by a patriot, she might now have easily regained Dalmatia, and acquired besides a considerable sea-board. Unfortunately Tamás Bakócz, her leading diplomatist from 1499 to 1521, was as much an egotist as the other magnates, and he sacrificed the political interests of Hungary entirely to personal considerations. Primate of Hungary since 1497, he coveted the popedom—and the red hat as the first step thereto above all things,—and looked mainly to Venetian influence for both. He therefore supported Venice against her enemies, refused to enter the League of Cambray in 1508, and concluded a ten years' alliance with the Signoria, which obliged Hungary to defend Venetian territory without any equivalent gain. Less reprehensible, though equally self-seeking, were his dealings with the emperor, which aimed at a family alliance between the Jagiellos and the Habsburgs on the basis of a double marriage between the son and daughter of Wladislaus, Louis and Anne, and an Austrian archduke and archduchess; this was concluded by the family congress at Vienna, July 22, 1515, to which Sigismund I. of Poland, the brother of Wladislaus, acceded. The Hungarian diet frantically opposed every Austrian alliance as endangering the national independence, but to any unprejudiced observer a union with the house of Habsburg, even with the contingent probability of a Habsburg king, was infinitely preferable to the condition into which Hungary, under native aristocratic misrule, was swiftly drifting. The diet itself had become as much a nullity as the king, and its decrees were systematically disregarded. Still more pitiable was the condition of the court. The penury of Wladislaus II. was by this time so extreme, that he owed his very meals to the charity of his servants. The diet, indeed, voted him aids and subsidies, but the great nobles either forbade their collection within their estates, or confiscated the amount collected. Under the circumstances, we cannot wonder if the frontier fortresses fell to pieces, and the border troops, unpaid for years, took to brigandage.

The last reserves of the national wealth and strength were dissipated by the terrible peasant rising of György Doza (*q.v.*) in 1514, of which the enslavement of the Hungarian peasantry was the immediate consequence. The "Savage Diet" which assembled on the 18th of October the same year, to punish the rebels and restore order, well deserved its name. Sixty-two of its seventy-one enactments were directed against the peasants, who were henceforth bound to the soil and committed absolutely into the hands of "their natural lords." To this vindictive legislation, which converted the labouring population into a sullenly hostile

*Peasant
Rising,
1514.*

¹ It should be remembered that at this time one-third of the land belonged to the church, and the remainder was in the hands of less than a dozen great families who had also appropriated the royal domains.

force within the state, it is mainly due that a healthy political life in Hungary became henceforth impossible. The same spirit of hostility to the peasantry breathed through the famous condonation of the Hungarian customary law known as the *Tripartitum*, which, though never actually formally passed into law, continued until 1845 to be the only document defining the relations of king and people, of nobles and their peasants, and of Hungary and her dependent states.¹

Wladislaus II. died on the 13th of March 1516, two years after the "Savage Diet," the ferocity of whose decrees he had feebly endeavoured to mitigate, leaving his two

*Subjected
by the
Turks.*

kingdoms to his son Louis, a child of ten, who was pronounced of age in order that his foreign guardians, the emperor Maximilian and Sigismund of Poland, might be dispensed with. The government remained in the hands of Cardinal Bakócz till his death in 1521, when the supreme authority at court was disputed between the lame palatine István Báthory, and his rival, the eminent jurist and orator István Verböczy (*q.v.*),—both of them incompetent, unprincipled place-hunters,—while, in the background lurked János Zapolya (see JOHN (ZAPOLYA), KING OF HUNGARY), voivode of Transylvania, patiently waiting till the death of the feeble and childless king (who, in 1522, married Maria of Austria) should open for him a way to the throne. Every one felt that a catastrophe was approaching. "Things cannot go on like this much longer," wrote the Venetian ambassador to his government. The war of each against all continued; no taxes could be collected; the holders of the royal domains refused to surrender them at the command of the diet; and the boy king had very often neither clothes to wear nor food to eat. The whole atmosphere of society was one of rapine and corruption, and only on the frontier a few self-sacrificing patriots like the ban-bishop, Peter Biriszo, the last of Matthias's veterans, and his successor the saintly Pál Tomori, archbishop of Kalocsa, showed, in their ceaseless war against the predatory Turkish bands, that the ancient Magyar valour was not yet wholly extinct. But the number of the righteous men was too few to save the state. The first blow fell in 1521, when Sultan Suleiman appeared before the southern fortresses of Sabác and Belgrade, both of which fell into his hands during the course of the year. After this Venice openly declared that Hungary was no longer worth the saving. Yet the *coup de grâce* was postponed for another five years, during which time Suleiman was occupied with the conquest of Egypt and the siege of Rhodes. The Magyars fancied they were safe from attack, because the final assault was suspended; and everything went on in the old haphazard way. Every obstacle was opposed to the collection of the taxes which had been voted to put the kingdom in a state of defence. "If this realm could be saved at the expense of three florins," exclaimed the papal envoy, Antonio Burgio, "there is not a man here willing to make the sacrifice." Only on the southern frontier did Archbishop Tomori painfully assemble a fresh army and fleet, and succeed, by incredible efforts, in constructing at Péterwardein, on the right bank of the Danube, a new fortress which served him as a refuge and sally post in his interminable guerilla war with the Turks.

In the spring of 1526 came the tidings that Sultan Suleiman had quitted Constantinople, at the head of a countless host, to conquer Hungary. On the 28th of July Péterwardein, after a valiant resistance, was blown into the air. The diet, which met at Buda in hot haste, proclaimed the young king's dictator,

¹ The *Opus tripartitum juris consuetudinarii regni Hungariæ* was drawn up by Verböczy at the instance of the diet in 1507. It was approved by a committee of the diet and received the royal imprimatur in 1514, but was never published. In the constitutional history of Hungary the *Tripartitum* is of great importance as re-asserting the fundamental equality of all the members of the *populus* (i.e. the whole body of the nobles) and, more especially, as defining the co-ordinate power of the king and "people" in legislation: i.e. the king may propose laws, but they had no force without the consent of the people, and vice versa. See Knatchbull-Hugessen, i. 64.

² He was just twenty.

granted him unlimited subsidies which there was no time to collect, and ordered a *levée en masse* of the entire male population, which could not possibly assemble within the given time. Louis at once formed a camp at Tolna, whence he issued despairing summonses to the lieges, and, by the middle of August, some 25,000 ill-equipped gentlemen had gathered around him. With these he marched southwards to the plain of Mohács, where, on the 29th of August, the Hungarians, after a two hours' fight, were annihilated, the king, both the archbishops, five bishops and 24,000 men perishing on the field. The sultan refused to believe that the pitiful array he had so easily overcome could be the national army of Hungary. Advancing with extreme caution, he occupied Buda on the 12th of September, but speedily returned to his own dominions, carrying off with him 105,000 captives, and an amount of spoil which filled the bazaars of the East for months to come. By the end of October the last Turkish regular had quitted Magyar soil, and, to use the words of a contemporary observer, one quarter of Hungary was as utterly destroyed as if a flood had passed over it.

The Turks had no sooner quitted the land than John Zapolya, voivode of Transylvania, assembled a diet at Tokaj (Oct. 14, 1526) at which the towns were represented as well as the counties. The tone of the assembly being violently anti-German, and John being the only conceivable national candidate, his election was a matter of course; but his misgivings were so great that it was not till the beginning of November that he very reluctantly allowed himself to be crowned at a second diet, held at Székesfehérvár. By this time a competitor had entered the field. This was the archduke Ferdinand, who claimed the Hungarian crown by right of inheritance in the name of his wife, Anne, sister of the late king. Ferdinand was elected (Dec. 16) by a scratch assembly consisting of deputies from Croatia and the towns of Pressburg and Sopron; but he speedily improved his position in the course of 1527, by driving King John first from Buda and then from Hungary. In November the same year he was elected and crowned by a properly constituted diet at Székesfehérvár (Stuhlweissenburg). In 1530 Zapolya was reinstated in Buda by Suleiman the Magnificent in person, who, at this period, preferred setting up a rival to "the king of Vienna" to conquering Hungary outright. Thus the Magyars were saddled with two rival kings with equally valid titles, which proved an even worse disaster than the Mohács catastrophe; for in most of the counties of the unhappy kingdom desperadoes of every description plundered the estates of the gentry, and oppressed the common people, under the pretext that they were fighting the battles of the contending monarchs. The determination of Ferdinand to partition Hungary rather than drive the Turks out, which he might easily have done after Suleiman's unsuccessful attempts on Vienna in 1529-1530, led to a prolongation of the struggle till the 24th of February 1538, when, by the secret peace of Nagyvarad,² Hungary was divided between the two competitors. By this treaty Ferdinand retained Croatia-Slavonia and the five western counties with Pressburg and Esztergom (Gran), while Zapolya kept the remaining two-thirds with the royal title. He was indeed the last national king of Hungary till modern times. His court at Buda was maintained according to the ancient traditions, and his *gyűlés*, at which 67 of the 73 counties were generally represented, was the true national diet, the phantom assembly occasionally convened at Pressburg by Ferdinand scarcely deserving the title. Indeed, Ferdinand regarded his narrow strip of Hungarian territory as simply a barrier behind which he could better defend the hereditary states. During the last six years (1534-1540) of John's reign, his kingdom, beneath the guidance of the Paulician monk, Frater György, or George Martinuzzi (*q.v.*), the last great statesman of old Hungary, enjoyed a stability and prosperity marvellous in the difficult circumstances of the period, Martinuzzi holding the balance exactly between the emperor and the Porte with

*John
Zapolya
elected
King.*

*Ferdinand
of Austria
elected.*

*Rival
Kings.*

² It was kept secret for some years for fear of Turkish intervention.

astounding diplomatic dexterity, and at the same time introducing several important domestic reforms. Zapolya died on the 18th of July 1540, whereupon the estates of Hungary elected his baby son John Sigismund king, in direct violation of the peace of Grosswardein which had formally acknowledged Ferdinand as John's successor, whether he left male issue or not. Ferdinand at once asserted his rights by force of arms, and attacked Buda in May 1541, despite the urgent remonstrances of Martinuzzi, who knew that the Turk would never suffer the emperor to reign at Buda. His fears were instantly justified. In August 1541, Suleiman, at the head of a vast army, invaded Hungary, and on the 30th of August, Buda was in his hands. During the six following years the sultan still further improved his position, capturing, amongst many other places, Pécs, and the primatial city of Esztergom; but, in 1547, the exigencies

of the Persian war induced him to sell a truce of five years to Ferdinand for £100,000, on a *ui possidetis* basis, Ferdinand holding thirty-five counties (including Croatia and Slavonia) for which he was to pay an annual tribute of £60,000; John Sigismund retaining Transylvania and sixteen adjacent counties with the title of prince, while the rest of the land, comprising most of the central counties, was annexed to the Turkish empire. Thus the ancient kingdom was divided into three separate states with divergent aims and interests, a condition of things which, with frequent rearrangements, continued for more than 150 years.

A period of infinite confusion and extreme misery now ensued, of which only the salient points can here be noted. The attempts

of the Habsburgs to conquer Transylvania drew down upon them two fresh Turkish invasions, the first in 1552, when the sultan's generals captured Temesvár and fifty-four lesser forts or fortresses, and the second in 1566, memorable as Suleiman's last descent upon Hungary, and also for the heroic defence of Szigetvár by Miklós Zrínyi (q.v.), one of the classical sieges of history. The truce of Adrianople in 1568, nominally for eight years, but prolonged from time to time till 1593, finally suspended regular hostilities, and introduced the epoch known as "The Long Peace," though, throughout these twenty-five years, the guerrilla warfare on the frontier never ceased for more than a few months at a time, and the relations between the Habsburgs and Transylvania were persistently hostile.

Probably no other country ever suffered so much from its rulers as Hungary suffered during the second half of the 16th century. This was due partly to political and partly to religious causes. To begin with, there can be no doubt that from 1558, when the German imperial crown was transferred from the Spanish to the Austrian branch of the Habsburg family, royal Hungary¹ was regarded by the emperors as an insignificant barrier province yielding far more trouble than profit. The visible signs of this contemptuous point of view were (1) the suspension of the august dignity of palatine, which, after the death of Tamás Nádasdy, "the great palatine," in 1562, was left vacant for many years; (2) the abolition or attenuation of all the ancient Hungarian court dignitaries; (3) the degradation of the capital, Pressburg, into a mere provincial town; and (4) the more and more openly expressed determination to govern Hungary from Vienna by means of foreigners, principally German or Czech. During the reign of Ferdinand, whose consort, Anne, was a Hungarian princess, things were at least tolerable; but under Maximilian (1564-1576) and Rudolph (1576-1612) the antagonism of the Habsburgs towards their Magyar subjects was only too apparent. The diet, which had the power of the purse, could not be absolutely dispensed with; but it was summoned as seldom as possible, the king often preferring to forego his subsidies rather than listen to the unanswerable remonstrances of the estates against the illegalities of his government. In the days of the semi-insane recluse Rudolph things went from bad to worse. The Magyar nobles were now systematically spoliated on trumped-up charges of treason;

¹In contradistinction to Turkish Hungary and Transylvanian Hungary.

hundreds of them were ruined. At last they either durst not attend the diet, or "sat like dumb dogs" during its session, allowing the king to alter and interpret the statutes at his good pleasure. Presently religious was superadded to political persecution.

The Reformation had at first produced little effect on Hungary. Except in the towns, mostly of German origin, it was generally detested, just because it came from Germany. The battle of Mohács, however, severely shook the faith of the Hungarians. "Where are the old Magyar saints? Why do they not defend the realm against the Turks?" was the general cry. Moreover, the corrupt church had lost its hold on the affections of the people. Zapolya, a devout Catholic, is lauded by Archbishop Frangipan in 1533 for arresting the spread of the new doctrines, though he would not allow Martinuzzi to take the extreme step of burning

Effect of Reformation.

perverts at the stake. These perverts were mostly to be found among nobles desirous of amassing church property, or among those of the clergy who clamoured for communion in both kinds. So long, however, as the old national kingdom survived, the majority of the people still clung to the old faith. Under Ferdinand the parochial clergy were tempted to become Lutherans by the prospect of matrimony, and, in reply to the remonstrances of their bishops, declared that they would rather give up their cures than their wives. In Transylvania matters were at first ordered more peaceably. In 1552 the new doctrine obtained complete recognition there, the diet of Torda (1557) going so far as to permit every one to worship in his own way so long as he did not molest his neighbour. Yet, in the following year, the whole of the property of the Catholic Church there was diverted to secular uses, and the Calvinists were simultaneously banished, though they regained complete tolerance in 1564, a privilege at the same time extended to the Unitarians, who were now very influential at court and converted Prince John Sigismund to their views. In Turkish Hungary all the confessions enjoyed liberty of worship, though the Catholics, as possible partisans of the "king of Vienna," were liked the least. It was only when the Jesuits obtained a footing both at Prague² and Klausenburg that persecution began, but then it was very violent. In Transylvania the princes of the Báthory family (1571-1604) were ardent disciples of the Jesuit fathers, and Sigismund Báthory in particular persecuted fiercely, his fury being especially directed against the queer judaizing sect known as the Sabbatarians, whose tenets were adopted by the Szeklers, the most savage of "the three nations" of Transylvania, many thousands of whom were, after a bloody struggle, forced to emigrate. In royal Hungary also the Jesuits were the chief persecutors. The extirpation of Protestantism was a deliberate prearranged programme, and as Protestantism was by this time identical with Magyarism³ the extirpation of the one was tantamount to the extirpation of the other. The method generally adopted was to deprive the preachers in the towns of their churches by force, Italian mercenaries being preferably employed for the purpose. It was assumed that the Protestant nobles' jealousy of the burgesses would prevent them from interfering; but religious sympathy proved stronger than caste prejudice, and the diets protested against the persecution of their fellow citizens so vehemently that religious matters were withdrawn from their jurisdiction.

This persecution raged most fiercely towards the end of what is generally called "The Long War," which began in 1593 and lasted till 1606. It was a confused four-cornered struggle between the emperor and the Turks, the Turks and Transylvania, Michael of Moldavia and Transylvania, and Transylvania and the emperor, desultory and languishing as regards the Turks (the one notable battle being Sigismund Báthory's brilliant victory over the

The "Long War."

²At first the Habsburgs held their court at Prague instead of at Vienna.

³According to contemporary records the number of prelates and priests in the three parts of Hungary at the beginning of the 17th century was but 103, all told, and of the great families not above half a dozen still clung to Catholicism.

grand vizier in Walachia in 1595, when the Magyar army penetrated as far as Giurgevo), but very bitter as between the emperor and Transylvania, the principality being finally subdued by the imperial general, George Basta, in August 1604. A reign of terror ensued, during which the unfortunate principality was well-nigh ruined. Basta was authorized to Germanize and Catholicize without delay, and he began by dividing the property of most of the nobles among his officers, appropriating the lion's share himself. In royal Hungary the same object was aimed at by innumerable indictments against the richer landowners, indictments supported by false title-deeds and carried through by forged or purchased judgments of the courts. At last the estates of even the most devoted adherents of the Habsburgs were not safe, and some of them, like the wealthy István Illésházy (1540-1600), had to fly abroad to save their heads. Fortunately a peculiarly shameless attempt to blackmail Stephen Bocskay, a rich and

powerful Transylvanian nobleman, converted a long-suffering friend of the emperor into a national deliverer.

Stephen Bocskay. Bocskay (q.v.), a quiet but resolute man, having once made up his mind to rebel, never paused till he had established satisfactory relations between the Austrian court and the Hungarians. The two great achievements of his brief reign (he was elected prince of Transylvania on the 5th of April 1605, and died on the 20th of December 1606) were the peace of Vienna (June 23, 1606) and the truce of Zsitvatorök (November 1606). By the peace of Vienna, Bocskay obtained religious liberty and political autonomy, the restoration of all confiscated estates, the repeal of all unrighteous judgments and a complete retrospective amnesty for all the Magyars in royal Hungary, besides his own recognition as independent sovereign prince of an enlarged Transylvania. This treaty is remarkable as being the first constitutional compact between the ruling dynasty and the Hungarian nation. Almost equally important was the twenty years' truce of Zsitvatorök, negotiated by Bocskay between the emperor and the sultan, which established for the first time a working equilibrium between the three parts of Hungary, with a distinct political preponderance in favour of Transylvania. Of the 5163 sq. m. of Hungarian territory, Transylvania now possessed 2082, Turkish Hungary 1850, and royal Hungary only 1222. The emperor, on the other hand, was freed from the humiliating annual tribute to the Porte on payment of a war indemnity of £400,000. The position of royal Hungary was still further improved when the popular and patriotic Archduke Matthias was elected king of Hungary on the 16th of November 1608. He had previously confirmed the treaty of Vienna, and the day after his election he appointed Illésházy, now reinstated in all his possessions and dignities, palatine of Hungary.¹ In Transylvania, meantime, Gabriel Bathóry had been elected (Nov. 11, 1608) in place of the decrepit Sigismund Rákoczy, Bocskay's immediate successor.

For more than fifty years after the peace of Vienna the principality of Transylvania continued to be the bulwark of the liberties of the Magyars. It owed its ascendancy in the first place to the abilities of the two princes who *Transylvanian* *Hegemony.* ruled it from 1613 to 1648. The first and most famous of these rulers was Gabriel Bethlen (q.v.), who reigned from 1613 to 1620, perpetually thwarted all the efforts of the emperor to oppress or circumvent his Hungarian subjects, and won some reputation abroad by adroitly pretending to champion the Protestant cause. Three times he waged war on the emperor, twice he was proclaimed king of Hungary, and by the peace of Nikolsburg (Dec. 31, 1621) he obtained for the Protestants a confirmation of the treaty of Vienna, and for himself seven additional counties in northern Hungary besides other substantial advantages. Bethlen's successor, George I. Rákoczy, was equally successful. His principal achievement was the peace of Linz (Sept. 16, 1645), the last political triumph of Hungarian Protestantism, whereby the emperor was forced to confirm once more the oft-broken articles of the peace of Vienna,

¹ The counties of Szatmar, Ugocsa and Bereg and the fortress of Tokaj were formally ceded to him.

² He was the first Protestant palatine.

to restore nearly a hundred churches to the sects and to acknowledge the sway of Rákoczy over the north Hungarian counties. Gabriel Bethlen and George I. Rákoczy also did much for education and civilization generally, and their era has justly been called the golden era of Transylvania. They lavished money on the embellishment of their capital, Gyulafehérvár, which became a sort of Protestant Mecca, whither scholars and divines of every anti-Roman denomination flocked to bask in the favour of princes who were as liberal as they were pious. Yet both Bethlen and Rákoczy owed far more to favourable circumstances than to their own cunning. Their reigns synchronized with the Thirty Years' War, during which the emperors were never in a position seriously to withstand the attacks of the malcontent Magyars, the vast majority of whom were still Protestants, who naturally looked upon the Transylvanian princes as their protectors and joined them in thousands whenever they raided Moravia or Lower Austria, or threatened to advance upon Vienna. In all these risings no battle of importance was fought. Generally speaking, the Transylvanians had only to appear, to have their demands promptly complied with; for these marauders had to be bought off because the emperor had more pressing business elsewhere. Yet their military efficiency must have been small, for their allies the Swedes invariably allude to them as wild and ragged semi-barbarians.

Another fortunate accident which favoured the hegemony of Transylvania was the temporary collapse of Hungary's most formidable adversary, the Turk. From the peace of Zsitvatorök (1606) to the ninth year of the reign of *Turkish* *conqueror.* George Rákoczy II., who succeeded his father in 1648, the Turkish empire, misruled by a series of incompetent sultans and distracted by internal dissensions, was unable to intervene in Hungarian politics. But in the autumn of 1656 a great statesman, Mahommed Kuprili (q.v.), obtained the supreme control of affairs at Constantinople, and all Europe instantly felt the pressure of the Turk once more. It was George Rákoczy II. (q.v.) who gave the new grand vizier a pretext for interference. Against the advice of all his counsellors, and without the knowledge of the estates, Rákoczy, in 1657, plunged into the troubled sea of Polish politics, in the hope of winning the Polish throne, and not only failed miserably but overwhelmed Transylvania in his own ruin. Kuprili, who had forbidden the Polish enterprise, at once occupied Transylvania, and, in the course of the next five years, no fewer than four princes, three of whom died violent deaths, were forced to accept the kaftan and kalpag of investiture in the camp of the grand vizier. When, at the end of 1661, a more stable administration was set up with Michael Apaffy (1661-1690) as prince, Transylvania had descended to the rank of a feudatory of the Turkish empire. On the death of Mahommed Kuprili (Oct. 11, 1661) his son Fazil Ahmed succeeded him as grand vizier, and pursued his father's policy with equal genius and determination. In 1663 he invaded royal Hungary, with the intention of uniting all the Magyars against the emperor, but, the Magyars steadily refusing to attend any diet summoned under Turkish influence, his plan fell through, and his only notable military success was the capture of the fortress of Érsekújvár (Neuhäusel). In the following year, thanks to the generalship and heroism of Miklós Zrinyi the younger (q.v.), Kuprili was still less successful. Zrinyi captured *Peace of* *Vasvár,* *1664.* the fortress after fortress, and interrupted the Turkish communications by destroying the famous bridge of Esseg, while Montecuculi defeated the grand vizier at the battle of St Gothard (Aug. 1, 1664). Yet, despite these reverses, Kuprili's superior diplomacy enabled him, at the peace of Vasvár (Aug. 10, 1664) to obtain terms which should only have been conceded to a conqueror. The fortress of Érsekújvár and surrounding territory were now ceded to the Turks, with the result that royal Hungary was not only still further diminished, but its northern practically separated from its southern portion. On the other hand the treaty of Vasvár gave Hungary a respite from regular Turkish invasions for twenty years, though the border raiding continued uninterruptedly.

Of far more political importance than these fluctuating wars of

invasion and conquest was the simultaneous Catholic reaction in Hungary. The movement may be said to have begun about 1601, when the great Jesuit preacher and controversialist, Péter Pázmány (q.v.), first devoted himself to the task of reconverting his countrymen.

Catholic reaction.

Progress was necessarily retarded by the influence of the independent Protestant princes of Transylvania in the northern counties of Hungary. Even as late as 1622 the Protestants at the diet of Pressburg were strong enough to elect their candidate, Szaniszló Thurzó, palatine. But Thurzó was the last Protestant palatine, and, on his death, the Catholics, at the diet of Sopron (1625), where they dominated the Upper Chamber, and had a large minority in the Lower, were able to elect Count Miklós Esterházy in Thurzó's stead. The Jesuit programme in Hungary was the same as it had been in Poland a generation earlier, and may be summed up thus: convert the great families and all the rest will follow.¹ Their success, due partly to their whole-hearted zeal, and partly to their superior educational system, was extraordinary; and they possessed the

Pázmány's work.

additional advantage of having in Pázmány a leader of commanding genius. During his primacy (1616-1637), when he had the whole influence of the court, and the sympathy and the assistance of the Catholic world behind him, he put the finishing touches to his life's labour by founding a great Catholic university at Nagyszombat (1635), and publishing a Hungarian translation of the Bible to counteract the influence of Gaspar Károli's widely spread Protestant version. Pázmány was certainly the great civilizing factor of Hungary in the seventeenth century, and indirectly he did as much for the native language as for the native church. His successors had only to build on his foundations. One most striking instance of how completely he changed the current of the national mind may here be given. From 1526 to 1625 the usual jubilee pilgrimages from Hungary to Rome had entirely ceased. During his primacy they were revived, and in 1650, only seventeen years after his death, they were as numerous as ever they had been. Five years later there remained but four noble Protestant families in royal Hungary. The Catholicization of the land was complete.

Unfortunately the court of Vienna was not content with winning back the Magyars to the Church. The Habsburg kings were as jealous of the political as of the religious liberties of their Hungarian subjects. This was partly owing to the fact that national aspirations of any sort were contrary to the Imperial system, which claimed to rule by right divine, and partly to an inveterate distrust of the Magyars, who were regarded at court as rebels by nature, and therefore as enemies far more troublesome than the Turks. The conduct of the Hungarian nobles in the past, indeed, somewhat justified this estimate, for the fall of the ancient monarchy was entirely due to their persistent disregard of authority, to their refusal to bear their share of the public burdens. They were now to suffer severely for their past misdoings, but unfortunately the innocent nation was forced to suffer with them. Throughout the latter part of the 17th and the beginning of the 18th century, the Hungarian gentry underwent a cruel discipline at the hands of their Habsburg kings. Their privileges were overridden, their petitions were disregarded, their diets were degraded into mere registries of the royal decrees. They were never fairly represented in the royal council, they were excluded as far as possible from commands in Hungarian regiments, and were treated, generally, as the members of an inferior and guilty race. This era of repression corresponds roughly with the reign of Leopold I. (1657-1705), who left the government of the country to two bigoted Magyar prelates, György Szécsenyi (1595-1685) and Lipót (Leopold) Kollonich (1631-1707), whose domination represents the high-water mark of the anti-national regimen. The stupid and abortive conspiracy of Peter Zrínyi and three other magnates, who were publicly executed (April 30, 1671), was followed by wholesale arrests and confisca-

¹ The *jobbagyok*, or under-tenants, had to follow the example of their lords; they were, by this time, mere serfs with no privileges either political or religious.

tions, and for a time the legal government of Hungary was superseded (Patent of March 3, 1673) by a committee of eight persons, four Magyars and four Germans, presided over by a German governor, but the most influential person in this committee was Bishop Kollonich, of whom it was said that, while Pázmány hated the heretic in the Magyar, Kollonich hated the Magyar in the heretic. A gigantic process against leading Protestant ministers for alleged conspiracy was the first act of this committee. It began at Pressburg in March 1674, when 236 of the ministers were "converted" or confessed to acts of rebellion. But the remaining 93 stood firm and were condemned to death, a punishment commuted to slavery in the Neapolitan galleys. Sweden, as one of the guarantors of the peace of Westphalia, and several north German states, protested against the injury thus done to their coreligionists. It was replied that Hungary was outside the operation of the treaty of Westphalia, and that the Protestants had been condemned *not ex odio religionis* but *crimine rebellionis*.

But a high-spirited nation cannot be extinguished by any number of patents and persecutions. So long as the Magyar people had any life left, it was bound to fight in self-defence, it was bound to produce "malcontents" who looked abroad for help to the enemies of the house of Habsburg. The first and most famous of the malcontent leaders was Count Imre Tököli (q.v.). Between 1678 and 1682 Tököli waged three wars with Leopold, and, in September 1682, was acknowledged both by the emperor and the sultan as prince of North Hungary as far as the river Garam, to the great relief of the Magyar Protestants. The success of Tököli rekindled the martial ardour of the Turks, and a war party, under the grand vizier Kara Mustafa, determined to wrest from Leopold his twelve remaining Hungarian counties, gained the ascendancy at Constantinople in the course of 1682. Leopold, intent on the doings of his perennial rival Louis XIV., was loth to engage in an eastern war even for the liberation of Hungary, which he regarded as of far less importance than a strip or two of German territory on the Rhine. But, stimulated by the representations of Pope Innocent XI., who, well aware of the internal weakness of the Turk, was bent upon forming a Holy League to drive them out of Europe, and alarmed, besides, by the danger of Vienna and the hereditary states, Leopold reluctantly contracted an alliance with John III. of Poland, and gave the command of the army which, mainly through the efforts of the pope he had been able to assemble, to Prince Charles of Lorraine. The war, which lasted for 16 years and put an end to the Turkish dominion in Hungary, began with the world-renowned siege of Vienna (July 14-Sept. 12, 1683). There is no need to recount the oft-told victories of Sobieski (see JOHN III. SOBIESKI, KING OF POLAND). What is not quite so generally known is the fact that Leopold slackened at once and would have been quite content with the results of these earlier victories had not the pope stiffened his resistance by forming a Holy League between the Emperor, Poland, Venice, Muscovy and the papacy, with the avowed object of dealing the Turk the *coup de grâce* (March 5, 1684). This statesmanlike persistence was rewarded by an uninterrupted series of triumphs, culminating in the recapture of Buda (1686) and Belgrade (1688), and the recovery of Bosnia (1689). But, in 1690, the third of the famous Kuprili, Mustafa, brother of Fazil Ahmed, became grand vizier, and the Turk, still further encouraged by the death of Innocent XI., rallied once more. In the course of that year Kuprili regained Serbia and Bulgaria, placed Tököli on the throne of Transylvania, and on the 6th of October took Belgrade by assault. Once more the road to Vienna lay open, but the grand vizier wasted the remainder of the year in fortifying Belgrade, and on August 18th, 1691, he was defeated and slain at Slankamen by the margrave of Baden. For the next six years the war languished owing to the timidity of the emperor, the incompetence of his generals and the exhaustion of the Porte; but on the 11th of September 1697 Prince Eugene of Savoy routed the Turks at Zenta and on the 13th of November 1698 a peace-congress was opened at

Hungarian resistance.

Liberation from the Turks.

or even to the diet, for the necessary reforms. Society itself must take the initiative by breaking down the barriers of class exclusiveness and reviving a healthy public spirit. The effect of this teaching was manifest at the diet of 1832, when the Liberals in the Lower Chamber had a large majority, prominent among whom were Francis Deák and Ödön Böchy. In the Upper House, however, the magnates united with the government to form a conservative party obstinately opposed to any project of reform, which frustrated all the efforts of the Liberals.

The alarm of the government at the power and popularity of the Liberal party induced it, soon after the accession of the new king, the emperor Ferdinand I. (1835-1848), to attempt to crush the reform movement by arresting and imprisoning the most active agitators among them, Louis Kossuth and Miklós Weselényi. But the nation was no longer to be cowed. The diet of 1839 refused to proceed to business till the political prisoners had been released, and, while in the Lower Chamber the reforming majority was larger than ever, a Liberal party was now also formed in the Upper House under the brilliant leadership of Count Louis Batthyány and Baron Joseph Eötvös. Two progressive measures of the highest importance were passed by this diet, one making Magyar the official language of Hungary, the other freeing the peasants' holdings from all feudal obligations.

The results of the diet of 1839 did not satisfy the advanced Liberals, while the opposition of the government and of the

Upper House still further embittered the general discontent. The chief exponent of this temper was the *Kossuth*. *Pesti Hirlap*, Hungary's first political newspaper, founded in 1841 by Kossuth, whose articles, advocating armed reprisals if necessary, inflamed the extremists but alienated Széchenyi, who openly attacked Kossuth's opinions. The polemic on both sides was violent; but, as usual, the extreme views prevailed, and on the assembling of the diet of 1843 Kossuth was more popular than ever, while the influence of Széchenyi had sensibly declined. The tone of this diet was passionate, and the government was fiercely attacked for interfering with the elections. Fresh triumphs were won by the Liberals. Magyar was now declared to be the language of the schools and the law-courts as well as of the legislature; mixed marriages were legalized; and official positions were thrown open to non-nobles.

The interval between the diet of 1843 and that of 1847 saw a complete disintegration and transformation of the various political parties. Széchenyi openly joined the government, while the moderate Liberals separated from the extremists and formed a new party, the Centralists. Immediately before the elections, however, Deák succeeded in reuniting all the Liberals on the common platform of "The Ten Points": (1) Responsible ministries, (2) Popular representation, (3) The incorporation of Transylvania, (4) Right of public meeting, (6) Absolute religious liberty, (7) Universal equality before the law, (8) Universal taxation, (9) The abolition of the *Aviticum*, an obsolete and anomalous land-tenure, (10) The abolition of serfdom, with compensation to the landlords. The ensuing elections resulted in a complete victory of the Progressives. All efforts to bring about an understanding between the government and the opposition were fruitless. Kossuth demanded not merely the redress of actual grievances, but a reform which would make grievances impossible in the future. In the highest circles a dissolution of the diet now seemed to be the sole remedy; but, before it could be carried out, tidings of the February revolution in Paris reached Pressburg¹ (March 1), and on the 3rd of March Kossuth's motion for the appointment of an independent, responsible ministry was accepted by the Lower House. The moderates, alarmed not so much by the motion itself as by its tone, again tried to inter-

vene; but on the 13th of March the Vienna revolution broke out, and the king, yielding to pressure or panic, appointed Count Louis Batthyány premier of the first Hungarian responsible ministry, which included Kossuth, Széchenyi and Deák. The Ten Points, or the March Laws as they were now called, were

¹ Up to 1848 the Hungarian diet was usually held at Pressburg.

then adopted by the legislature and received the royal assent (April 10). Hungary had, to all intents and purposes, become an independent state bound to Austria only by the fact that the palatine chanced to be an Austrian archduke.

In the assertion of their national aspirations, conrused as these were with the new democratic ideals, the Magyars had had the support of the German democrats who temporarily held the reins of power in Vienna. On the other hand, they were threatened by an ominous stirring of the subject races in Hungary itself. Croats, Vlachs, Serbs and Slovaks resented Magyar domination—a domination which had been carefully secured under the revolutionary constitution by a very narrow franchise, and out of the general chaos each race hoped to create for itself a separate national existence. The separatist movement was strongest in the south, where the Rumanes were in touch with their kinsmen in Walachia and Moldavia, the Serbs with their brethren in Servia, and the Croats intent on reasserting the independence of the "Tri-une Kingdom."

The attitude of the distracted imperial government towards these movements was at first openly suspicious and hostile. The emperor and his ministers hoped that, having conceded the demands of the Magyars, they would receive the help of the Hungarian government in crushing the revolution elsewhere, a hope that seemed to be justified by the readiness with which Batthyány consented to send a contingent to the assistance of the imperialists in Italy. That the encouragement of the Slav aspirations was soon deliberately adopted as a weapon against the Hungarian government was due, partly to the speedy predominance at Pest of Kossuth and the extreme party of which he was the mouthpiece, but mainly to the calculated policy of Baron Jellachich, who on the 14th of April was appointed ban of Croatia. Jellachich, who as a soldier was devoted to the interests of the imperial house, realized that the best way to break the revolutionary power of the Magyars and Germans would be to encourage the Slav national ideas, which were equally hostile to both; to set up against the Dumlism in favour at Pest and Vienna the federal system advocated by the Slavs, and so to restore the traditional Habsburg principle of *Divide et impera*. This policy he pursued with masterly skill. His first acts on taking up his office were to repudiate the authority of the Hungarian diet, to replace the Magyar officials with ardent "Illyrians," and to proclaim martial law. Under pressure from the palatine of Batthyány an imperial edict was issued, on the 7th day of May, ordering the ban to desist from his separatist plans and take his orders from Pest. He not only refused to obey, but on the 5th of June convoked to Agram the Croatian national diet, of which the first act was to declare the independence of the Tri-une Kingdom. Once more, at the instance of Batthyány, the emperor intervened; and on the 10th an imperial edict stripped Jellachich of all his offices.

Meanwhile, however, Jellachich had himself started for Innsbruck, where he succeeded in persuading the emperor of the loyalty of his intentions, and whence, though not as yet formally reinstated, he was allowed to return to Croatia with practically unfettered discretion. The Hungarian government, in fact, had played into his hands. At a time when everything depended on the army, they had destroyed the main tie which bound the Austrian court to their interests by tampering with the relation of the Hungarian army to the crown. In May a national guard had been created, the disaffected troops being bribed by increased pay to desert their colours and join this; and on the 1st of June the garrison of Pest had taken an oath to the constitution. All hope of crushing revolutionary Vienna with Magyar aid was thus at an end, and Jellachich, who on the 20th issued a proclamation to the Croat regiments in Italy to remain with their colours and fight for the common fatherland, was free to carry out his policy of identifying the cause of the southern Slavs with that of the imperial army. The alliance was cemented in July by a military demonstration, of which Jellachich was the hero, at Vienna; as the result of which the government mustered up courage to declare publicly that the basis of the Austrian state was "the recognition of the equal rights of all nationalities."

This was the challenge which the Magyars were not slow to accept.

In the Hungarian diet, which met on the 2nd of July, the influence of the conservative cabinet was wholly overshadowed

*Jellachich
invades
Hungary.*

by that of Kossuth, whose inflammatory orations—directed against the disruptive designs of the Slavs and the treachery of the Austrian government—precipitated the crisis. At his instance the diet not only refused to vote supplies for the troops of Croatia, but only consented to pass a motion for sending reinforcements to the army in Italy on condition that the anti-Magyar races in Hungary should be first disarmed. On the 11th, on his motion, a decree was passed by acclamation for a levy of 200,000 men and the raising of £4,500,000 for the defence of the independence of the country. Desultory fighting, in which Austrian officers with the tacit consent of the minister of war took part against the Magyars, had already broken out in the south. It was not, however, until the victory of Cuzcoza (July 25) set free the army in Italy, that the Austrian government ventured on bolder measures. On the 4th of September, after weeks of fruitless negotiation, the king-emperor threw down the gauntlet by reinstating Jellachich in all his honours. Seven days later the ban declared open war on Hungary by crossing the Drave at the head of 36,000 Croatian troops (see *AUSTRIA-HUNGARY: History*). The immediate result was to place the extreme revolutionaries in power at Pest. Széchenyi had lost his reason some days before; Eötvös and Deák retired into private life; of the conservative ministers only Batthyány, to his undoing, consented to remain in office, though hardly in power. Kossuth alone was supreme.

The advance of Jellachich as far as Lake Balaton had not been checked, the Magyar troops, though—contrary to his expectation—none joined him, offering no opposition. The palatine, the Austrian Archduke Stephen, after fruitless attempts at negotiation, laid down his office on the 24th of September and left for Vienna. One more attempt at compromise was made, General Count Lamberg¹ being sent to take command of all the troops, Slav or Magyar, in Hungary, with a view to arranging an armistice. His mission, which was a slight to Jellachich, was conceived as a concession to the Magyars, and had the general approval of Batthyány. Unhappily, however, when Lamberg arrived in Pest, Batthyány had not yet returned; the diet, on Kossuth's motion, called on the army not to obey the new commander-in-chief, on the ground that his commission had not been countersigned by a minister at Pest. Next day, as he was crossing the bridge of Buda, Lamberg was dragged from his carriage by a frantic mob and torn to pieces. This made war inevitable; though Batthyány hurried to Vienna to try and arrange a settlement. Failing in this, he retired, and on the 2nd of October a royal proclamation, countersigned by his successor, Reccaséy, placed Hungary under martial law and appointed Jellachich viceroy and commander of all the forces. This proclamation, together with the order given to certain Viennese regiments to march to the assistance of Jellachich, who had been defeated at Pákozd on the 20th of September, led to the *émence* (Oct. 3) which ended in the murder of the minister of war, Latour, and the second flight of the emperor to Innsbruck. The fortunes of the German revolutionaries in Vienna and the Magyar revolutionists in Pest were now closely bound up together; and when, on the 11th, Prince

*Fall of
Vienna.*

Windischgrätz laid siege to Vienna, it was to Hungary that the democrats of the capital looked for relief. The despatch of a large force of militia to the assistance of the Viennese was, in fact, the first act of open rebellion of the Hungarians. They suffered a defeat at Schwechat on the 30th of October, which sealed the fate of the revolutionists in Vienna and thus precipitated a conflict *à outrance* in Hungary itself.

¹ Franz Philipp, Count von Lamberg (1791-1848), a field-marshal in the Austrian army, who had seen service in the campaigns of 1814-1815 in France, belonged to the Stockerau branch of the ancient county family of Orteneck-Ottenstein. He was chosen for this particular mission as being himself a Hungarian magnate conversant with Hungarian affairs, but at the same time of the party devoted to the court.

In Austria the army was now supreme, and the appointment of Prince Felix Schwarzenberg as head of the government was a guarantee that its power would be used in a reactionary sense without weakness or scruple. The Austrian diet was transferred on the 15th of November to Kremsier, remote from revolutionary influences; and, though the government still thought it prudent to proclaim its constitutional principles, it also proclaimed its intention to preserve the unity of the monarchy. A still further step was taken when, on the 2nd of December, the emperor Ferdinand abdicated in favour of his nephew Francis Joseph. The new sovereign was a lad of eighteen, who for the present was likely to be the mere mouthpiece of Schwarzenberg's policy. Moreover, he was not bound by the constitutional obligations unwillingly accepted by his uncle. The Magyars at once took up the challenge. On the 7th the Hungarian diet formally refused to acknowledge the title of the new king, "as without the knowledge and consent of the diet no one could sit on the Hungarian throne," and called the nation to arms. Constitutionally, in the Magyar opinion, Ferdinand was still king of Hungary, and this gave to the revolt an excuse of legality. Actually, from this time until the collapse of the rising, Louis Kossuth was the ruler of Hungary.

The struggle opened with a series of Austrian successes. Prince Windischgrätz, who had received orders to reduce

Hungary by fire and sword, began his advance on the 15th of December; opened up the way to the capital by the victory of Mór (Oct. 30), and on the 5th of January 1849 occupied Pest, while the Hungarian

*War of
Independence.*

government and diet retired behind the Theiss and established themselves at Debreczen. A last attempt at reconciliation, made by the more moderate members of the diet in Windischgrätz's camp at Bieské (Jan. 3), had fundered on the uncompromising attitude of the Austrian commander, who demanded unconditional submission; whereupon the moderates, including Deák and Batthyány, retired into private life, leaving Kossuth to carry on the struggle with the support of the enthusiastic extremists who constituted the rump of the diet at Debreczen. The question now was: how far the military would subordinate itself to the civil element of the national government. The first symptom of dissonance was a proclamation by the commander of the Upper Danube division, Arthur Görgei, from his camp at Vác (Jan. 5) emphasizing the fact that the national defence was purely constitutional, and menacing all who might be led astray from this standpoint by republican aspirations. Immediately after this proclamation Görgei disappeared with his army among the hills of Upper Hungary, and, despite the difficulties of a phenomenally severe winter and the constant pursuit of vastly superior forces, fought his way down to the valley of Hernád—and safety. This masterly winter-campaign first revealed Görgei's military genius, and the discipline of that terrible month of marching and counter-marching had hardened his recruits into veterans whom his country regarded with pride and his country's enemies with respect. Unfortunately his success caused some jealousy in official quarters, and when, in the middle of February 1849, a commander-in-chief was appointed to carry out Kossuth's plan of campaign, that vital appointment was given, not to the man who had made the army what it was, but to a foreigner, a Polish refugee, Count Henrik Dembinski, who, after fighting the bloody and indecisive battle of Kápolna (Feb. 26-27), was forced to retreat. Görgei was immediately appointed his successor, and the new generalissimo led the Honvéds from victory to victory. Ably supported by Klapka and Damjanich he pressed forward irresistibly. Szólinok (March 5), Isaszeg (April 6), Vác (April 10), and Nagysarló (April 19) were so many milestones in his triumphal progress. On the 25th of May the Hungarian capital was once more in the hands of the Hungarians.

*Battle of
Kápolna.*

Meanwhile, the earlier events of the war had so altered the political situation that any idea which the diet at Debreczen had cherished of a compromise with Austria was destroyed. The capture of Pest had confirmed the Austrian court in its polic

of unification, which after the victory of Kápolna they thought it safe to proclaim. On the 7th of March the diet of Kremsier was dissolved, and immediately afterwards a proclamation was issued in the name of the emperor Francis Joseph establishing a united constitution for the whole empire, of which Hungary, cut up into half a dozen administrative districts, was henceforth to be little more than the largest of several subject provinces. The news of this manifesto, arriving as it did simultaneously with that of Görgei's successes, destroyed the last vestiges of a desire of the Hungarian revolutionists to compromise, and on the 14th of April, on the motion of Kossuth, the diet proclaimed the independence of Hungary, declared the house of Habsburg as false and perjured, for ever excluded from the throne, and elected Kossuth president of the Hungarian Republic. This was an execrable blunder in the circumstances, and the results were fatal to the national cause. Neither the government nor the army could accommodate itself to the new situation. From henceforth the military and civil authorities, as represented by Kossuth and Görgei, were hopelessly out of sympathy with each other, and the breach widened till all effective co-operation became impossible.

Meanwhile the humiliating defeats of the imperial army and the course of events in Hungary had compelled the court of Vienna to accept the assistance which the emperor Nicholas I. of Russia had proffered in the loftiest spirit of the Holy Alliance. The Austro-Russian alliance was announced at the beginning of May, and before the end of the month the common plan of campaign had been arranged. The Austrian commander-in-chief, Count Haynau, was to attack Hungary from the west, the Russian, Prince Paskevich, from the north, gradually envying the kingdom, and then advancing to end the business by one decisive blow in the mid-Theissian counties. They had at their disposal 375,000 men, to which the Magyars could only oppose 160,000. The Magyars, too, were now more than ever divided among themselves, no plan of campaign had yet been drawn up, no commander-in-chief appointed to replace Görgei, whom Kossuth had deposed. Haynau's first victories (June 20-28) put an end to their indecisions. On the 2nd of July the Hungarian government abandoned Pest and transferred its capital first to Szeged and finally to Arad. The Russians were by this time well on their way to the Theiss, and the terrible girdle which was to throttle the liberties of Hungary was all but completed. Kossuth again appointed as commander-in-chief the brave but inefficient Dembinski, who was utterly routed at Temesvar (Aug. 9) by Haynau. This was the last great battle of the War of Independence. The final catastrophe was now unavoidable. On the 13th of August Görgei, who had been appointed dictator by the panic-stricken government two days before, surrendered the remnant of his hardly pressed army to the Russian General Rüdiger at Világos. The other army corps and all the fortresses followed his example, Komárom, heroically defended by Klapka, being the last to capitulate (Sept. 27). Kossuth and his associates, who had quitted Arad on the 10th of August, took refuge in Turkish territory. By the end of the month Paskevich could write to the Emperor Nicholas: "Hungary lies at the feet of your Imperial Majesty."

From October 1849 to July 1850 Hungary was governed by martial law administered by "the butcher" Haynau. This was a period of military tribunals, dragooning, wholesale confiscation and all manner of brutalities.¹ From 1851 to 1860 pure terrorism was succeeded by the "Bach System," which derives its name from the imperial minister of the interior, Baron Alexander von Bach. The Bach System did not recognize historical Hungary. It

¹ The crowning atrocities, which the Magyars have never wholly forgiven, were the shooting and hanging of the "Arad Martyrs" and the execution of Batthyány. On October 6, 1849, thirteen generals who had taken part in the war, including Damjanics and Counts Vecsey and Leiningen, were hanged or shot at Arad. On the same day Count Louis Batthyány, who had taken no part in the war and had done his utmost to restrain his countrymen within the bounds of legality, was shot at Pest.

postulated the existence of one common indivisible state of which mutilated Hungary² formed an important section. The supreme government was entrusted to an imperial council responsible to the emperor alone. The counties were administered by imperial officials, Germans, Czechs and Galicians, who did not understand the Magyar tongue. German was the official language. But though reaction was the motive power of this new machinery of government, it could not do away with many of the practical and obvious improvements of 1848, and it was not blind to some of the indispensable requirements of a modern state. The material welfare of the nation was certainly promoted by it. Modern roads were made, the first railways were laid down, the regulation of the river Theiss was taken in hand, a new and better scheme of finance was inaugurated. But the whole system, so to speak, hung in the air. It took no root in the soil. The Magyar nation stood aloof from it. It was plain that at the first revolutionary blast from without, or the first insurrectionary outburst from within, the "Bach System" would vanish like a mirage.

Meanwhile the new Austrian empire had failed to stand the test of international complications. The Crimean War had isolated it in Europe. The Italian war of 1859 had revealed its essential instability. It was felt at court that some concessions were now due to the subject nationalities. Hence the October Diploma (Oct. 20, 1860) which proposed to prop up the crazy common state with the shadow of a constitution and to grant some measure of local autonomy to Hungary, subject always to the supervision of the imperial council (Reichsrath).³ This project was favoured by the Magyar conservative magnates who had never broken with the court, but was steadily opposed by the Liberal leader Ferenc Deák whose upright and tenacious character made him at this crisis the oracle and the buttress of the national cause. Deák's standpoint was as simple as it was unchangeable. He demanded the re-establishment of the constitution of 1848 in its entirety, the whole constitution and nothing but the constitution.

The October Diploma was followed by the February Patent (Feb. 26, 1861), which proposed to convert the Reichsrath into a constitutional representative assembly, with two chambers, to which all the provinces of the empire were to send deputies. The project, elaborated by Anton von Schmerling, was submitted to a Hungarian diet which assembled at Pest on the 2nd of April 1861. After long and violent debates, the diet, on the 8th of August, unanimously adopted an address to the crown, drawn up by Deák, praying for the restoration of the political and territorial integrity of Hungary, for the public coronation of the king with all its accompaniments, and the full restitution of the fundamental laws. The executive retorted by dissolving the diet on the 21st of August and levying the taxes by military execution. The so-called *Provisorium* had begun.

But the politicians of Vienna had neither the power nor the time to realize their intentions. The question of Italian unity had no sooner been settled than the question of German unity arose, and fresh international difficulties once more inclined the Austrian government towards moderation and concession. In the beginning of June 1865, Francis Joseph came to Buda; on the 26th a provisional Hungarian government was formed, on the 20th of September the February constitution was suspended, and on the 14th of December a diet was summoned to Buda-Pest. The great majority of the nation naturally desired a composition with its ruler and with Austria, and this general desire was unerringly interpreted and directed by Deák, who carried two-thirds of the deputies along with him. The session was interrupted by the outbreak of the Austro-Prussian War, but not before a

² Transylvania, Croatia-Slavonia with Fiume and the Temes Banat were separated from the kingdom and provided with local governments.

³ This Reichsrath was a purely consultative body, the ultimate control of all important affairs being reserved to the emperor. Its representative element consisted of 100 members elected by the provinces.

Intervention of Russia.

The October Diploma, 1860.

The February Patent, 1861.

The Austro-Prussian War of 1866.

committee had been formed to draft the new constitution. The peace of Prague (Aug. 20, 1866), excluding Austria from Italy and Germany, made the fate of the Habsburg monarchy absolutely dependent upon a compromise with the Magyars. (For the Compromise or *Ausgleich*, see AUSTRIA-HUNGARY: *History*.) On the 7th of November 1866, the diet reassembled.

The Compromise of 1867.

On the 17th of February 1867 a responsible independent ministry was formed under Count Gyula Andrassy. On the 29th of May the new constitution was adopted by 209 votes to 89. Practically it was an amplification of the March Laws of 1848. The coronation took place on the 8th of June, on which occasion the king solemnly declared that he wished "a veil to be drawn over the past." The usual coronation gifts he devoted to the benefit of the Honvéd invalids who had fought in the War of Independence. The reconciliation between monarch and people was assured.

Hungary was now a free and independent modern state; but the very completeness and suddenness of her constitutional victory made it impossible for the strongly flowing current of political life to keep within due bounds. The circumstance that the formation of political parties had not come about naturally, was an additional difficulty. Broadly speaking, there have been in Hungary since 1867 two parties: those who accept the compromise with Austria, and affirm that under it Hungary, so far from having surrendered any of her rights, has acquired an influence which she previously did not actually possess, and secondly, those who see in the compromise an abandonment of the essentials of independence and aim at the restoration of the conditions established in 1848. Within this broad division, however, have appeared from time to time political groups in bewildering variety, each adopting a party designation according to the exigencies of the moment, but each basing its programme on one or other of the theoretical foundations above mentioned.

Thus, at the outset, the most heterogeneous elements were to be found both on the Left and Right. The Extreme Left was infected by the fanaticism of Kossuth, who condemned the compromise and refused to take the benefit of the amnesty, while the prelates and magnates who had originally opposed the compromise were now to be found by the side of Deák and Andrassy. The Deák party preserved its majority at the elections of 1869, but the Left Centre and Extreme Left returned to the diet considerably reinforced. The outbreak of the Franco-German War of 1870 turned the attention of the Magyars to foreign affairs. Andrassy never rendered a greater service to his country than when he prevented the imperial chancellor and joint foreign minister, Count Beust,¹ from intervening in favour of France. On the retirement of Beust in 1871, Andrassy was appointed his successor, the first instance, since Hungary came beneath the dominion of the Habsburgs, of an Hungarian statesman being entrusted with the conduct of foreign affairs. But, however gratifying such an elevation might be, it was distinctly prejudicial, at first, to Hungary's domestic affairs, for no one else at this time, in Hungary, possessed either the prestige or the popularity of Andrassy. Within the next five years ministry followed ministry in rapid succession. A hopeless political confusion ensued. Few measures could be passed. The finances fell into disorder. The national credit was so seriously impaired abroad that foreign loans could only be obtained at ruinous rates of interest. During this period Deák had almost entirely withdrawn from public life. His last great speech was delivered on the 28th of June 1873, and he died on the 20th of January 1876. Fortunately, in Kálmán Tisza, the leader of the Liberal

(*Szabadelmsű*, i.e. "Free Principle") party, he left behind him a statesman of the first rank, who for the next eighteen years was to rule Hungary uninterruptedly.

Kálmán Tisza.

¹ Beust was the only "imperial chancellor" in Austro-Hungarian history; even Metternich bore only the title of "chancellor"; and Andrassy, who succeeded Beust, styled himself "minister of the imperial and royal household and for foreign affairs."

From the first, Tisza was exposed to the violent attacks of the opposition, which embraced, not only the party of Independence, champions of the principles of 1848, but the so-called National party, led by the brilliant orator Count Albert Apponyi, which aimed at much the same ends but looked upon the Compromise of 1867 as a convenient substructure on which to build up the Magyar state. Neither could forgive Tisza for repudiating his earlier Radical policy, the so-called Bihar Programme (March 6, 1868), which went far beyond the Compromise in the direction of independence, and both attacked him with a violence which his unyielding temper, and the ruthless methods by which he always knew how to secure victory, tended ever to fan into fury. Yet Tisza's aim also was to convert the old polyglot Hungarian kingdom into a homogeneous Magyar state, and the methods which he employed—notably the enforced magyarization of the subject races, which formed part of the reformed educational system introduced by him—certainly did not err on the side of moderation.² Whatever view may be held of Tisza's policy in this respect, or of the corrupt methods by which he maintained his party in power,³ there can be no doubt that during his long tenure of office—which practically amounted to a dictatorship—he did much to promote the astonishing progress of his country, which ran a risk of being stifled in the strife of factions. Himself a Calvinist, he succeeded in putting an end to the old quarrel of Catholic and Protestant and uniting them in a common enthusiasm for a race ideal; nominally a Liberal, he trampled on every Liberal principle in order to secure the means for governing with a firm hand; and if the political corruption of modern Hungary is largely his work,⁴ to him also belongs the credit for the measures which have placed the country on a sound economic basis and the statesmanlike temper which made Hungary a power in the affairs of Europe. In this latter respect Tisza rendered substantial aid to the joint minister for foreign affairs by repressing the anti-Russian ardour of the Magyars on the outbreak of the Russo-Turkish war of 1877-78, and by supporting Andrassy's execution of the mandate from the Berlin Congress to Austria-Hungary for the occupation of Bosnia, against which the Hungarian opposition agitated for reasons ostensibly financial. Tisza's policy on both these occasions increased his unpopularity in Hungary, but in the highest circles at Vienna he was now regarded as indispensable.

The following nine years mark the financial and commercial rehabilitation of Hungary, the establishment of a vast and original railway system which won the admiration of Europe, the liberation and expansion of her over-sea trade, the conversion of her national debt under the most favourable conditions and the consequent equilibrium of her finances. These benefits the nation owed for the most part to Gábor Baross, Hungary's greatest finance minister, who entered the cabinet in 1886 and greatly strengthened it. But the opposition, while unable to deny the recuperation of Hungary, shut their eyes to everything but Tisza's "tyranny," and their attacks were never so savage and unscrupulous as during the session of 1880, when threats of a revolution were uttered by the opposition leaders and the premier could only enter or leave the House under police protection. The tragic death of the crown prince Rudolph hushed for a time the strife of tongues, and in the meantime Tisza brought into the ministry Dezső Szilágyi, the most powerful debater in the House, and Sándor Wekerle, whose solid talents had hitherto been hidden beneath the bush of an under-secretaryship. But in 1890, during the debates on the Kossuth Repatriation Bill, the attacks on the premier were renewed, and on the 13th of March he placed his resignation in the king's hands.

The withdrawal of Tisza scarcely changed the situation, but the period of brief ministries now began. Tisza's successor,

² See for this Mr Seton-Watson's *Racial Problems of Hungary*, *passim*.

³ *Ibid.* p. 168.

⁴ Especially the Electoral Law of 1874, which established a very unequal distribution of electoral areas, a highly complicated franchise, and voting by public declaration, thus making it easy for the government to intimidate the electors and generally to gerrymander the elections.

Count Gyula Szápáry, formerly minister of agriculture, held office for eighteen months, and was succeeded (Nov. 21, 1892) by

**First
Wekerle
Ministry,
1892. The
religious
question.**

Wekerle. Wekerle, essentially a business man, had taken office for the express purpose of equilibrating the finances, but the religious question aroused by the encroachments of the Catholic clergy, and notably their insistence on the baptism of the children of mixed marriages, had by this time (1893-1894) excluded all others, and the government were forced to postpone their financial programme to its consideration. The Obligatory Civil Marriage Bill, the State Registries Bill and the Religion of Children of Mixed Marriages Bill, were finally adopted on the 21st of June 1894, after fierce debates and a ministerial interregnum of ten days (June 10-20); but on the 25th of December, Wekerle, who no longer possessed the king's confidence,¹ resigned a second time, and was succeeded by Baron Dezső (Desiderius) Bánffy.

The various parties meanwhile had split up into some half a dozen sub-sections; but the expected fusion of the party of independence and the government fell through, and the barren struggle continued till the celebration of the millennium of the foundation of the monarchy produced for some months a lull in politics. Subsequently, Bánffy still further exasperated the opposition by exercising undue influence during the elections of 1896. The majority he obtained on this occasion enabled him, however, to carry through the Army Education Bill, which tended to magyarize the Hungarian portion of the joint army; and another period of comparative calm ensued, during which Bánffy attempted to adjust various outstanding financial and economical differences with Austria. But in November 1898, on the occasion of the renewal of the commercial convention with Austria, the attack on the ministry was renewed with unprecedented virulence, obstruction being systematically practised with the object of goading the government into committing illegalities, till Bánffy, finding the situation impossible, resigned on the 17th of February 1899. His successor,

**Széll
Ministry,
1899.**

Kálmán Széll, obtained an immense but artificial majority by a fresh fusion of parties, and the minority pledged itself to grant an indemnity for the extra-parliamentary financial decrees rendered necessary by Hungary's understanding with Austria, as well as to cease from obstruction. As a result of this compromise the budget of 1899 was passed in little more than a month, and the commercial and tariff treaty with Austria were renewed till 1903.² But the government had to pay for this complacency with a so-called "pactum" which bound its hands in several directions, much to the profit of the opposition during the "pure" elections of 1901.

On the reassembling of the diet, Count Albert Apponyi was elected speaker, and the minority seemed disposed to let the government try to govern. But the proposed raising of the contingent of recruits by 15,000 men (Oct. 1902) once more brought up the question of the common army, the parliament refusing to pass the bill, except in return for the introduction of the Hungarian national flag into the Hungarian regiments and the substitution of Magyar for German in the words of command. The king refusing to yield an inch of his rights under clause ii. of Law XII. of the Compromise of 1867, the opposition once more took to obstruction, and on the 1st of May 1903 Széll was forced to resign.

Every one now looked to the crown to extract the nation from an *ex-lex*, or extra-constitutional situation, but when the king, passing over the ordinary party-leaders, appointed as premier Count Károly Khuen-Hederváry, who had made himself impossible as ban of Croatia, there was general amazement and indignation. The fact was that the king, weary of the tactics of a minority which for years had terrorized every majority and prevented the government from exercising its proper constitutional functions, had resolved to show the Magyars that he was prepared to rule unconstitu-

tionally rather than imperil the stability of the Dual Monarchy by allowing any tampering with the joint army. In an ordinance on the army word of command, promulgated on the 16th of September, he reaffirmed the inalienable character of the powers of the crown over the joint army and the necessity for maintaining German as the common military language. This was followed by the fall of Khuen-Hederváry (September 29), and a quarrel *à outrance* between crown and parliament seemed unavoidable. The Liberal party, however, realized the abyss towards which they were hurrying the country, and united their efforts to come to a constitutional understanding with the king. The problem was to keep the army an Hungarian army without infringing on the prerogative of the king as commander-in-chief, for, unconstitutional as the new ordinance might be, it could not constitutionally be set aside without the royal assent. The king met them half way by inviting the majority to appoint a committee to settle the army question provisionally, and a committee was formed, which included Széll, Apponyi, Count István Tisza and other experienced statesmen.

A programme approved of by all the members of the committee was drawn up, and on the 3rd of November 1903, Count István Tisza was appointed minister president to carry it out. Thus, out of respect for the wishes of the nation, the king had voluntarily thrown open to public discussion the hitherto strictly closed and jealously guarded domain of the army. Tisza, a statesman of singular probity and tenacity, seemed to be the one person capable of carrying out the programme of the king and the majority. The irreconcilable minority, recognizing this, exhausted all the resources of "technical obstruction" in order to reduce the government to impotence, a task made easy by the absurd standing-rules of the House which enabled any single member to block a measure. These tactics soon rendered legislation impossible, and a modification of the rule of procedure became absolutely necessary if any business at all was to be done. The Modification of the Standing-orders Bill was accordingly introduced by the deputy Gábor Daniel (Nov. 18, 1904); but the opposition, to which the National party had attached itself, denounced it as "a gagging order" inspired at Vienna, and shouted it down so vehemently that no debate could be held; whereupon the president declared the bill carried and adjourned the House till the 13th of December 1904. This was at once followed by an anti-ministerial fusion of the extremists of all parties, including seceders from the government (known as the Constitutional party); and when the diet reassembled, the opposition broke into the House by force and wrecked all the furniture, so that a session was physically impossible (Jan. 5, 1905). Tisza now appealed to the country, but was utterly defeated. The opposition thereupon proceeded to annul the Lex Daniel (April 7) and stubbornly to clamour for the adoption of the Magyar word of command in the Hungarian part of the common army. To this demand the king as stubbornly refused to accede;³ and as the result of the consequent dead-lock, Tisza, who had courageously continued in office at the king's request, after every other leading politician had refused to form a ministry, was finally dismissed on the 17th of June.

**István
Tisza
Ministry,
1904.**

**Crises of
1904-
1906.**

**The
"Coalition"
Ministry.**

(R. N. B.; W. A. P.)

Long negotiations between the crown and the leaders of the Coalition having failed to give any promise of a *modus vivendi*, the king-emperor at last determined to appoint an

¹ The question involves rather complex issues. Apart from the question of constitutional right, the Magyars objected to German as the medium of military education as increasing the difficulty of magyarizing the subordinate races of Hungary (see *Knatchbull-Hughessen*, ii. 296). On the other hand the Austrians pointed out that not only would failure to understand each other's language cause fatal confusion on a battlefield, but also tend to disintegrate the forces even in peace time. They also laid stress on the fact that Magyar was not, any more than German, the language of many Hungarian regiments, consisting as these did mainly of Slovaks, Vlachs, Serbs and Croats. In resisting the Magyar word of command, then, the king-emperor was able to appeal to the anti-Magyar feeling of the other Hungarian races. (W. A. P.)

² The Austrian court resented especially the decree proclaiming national mourning for Louis Kossuth, though no minister was present at the funeral.

³ Subsequently extended till 1907.

extra-parliamentary ministry, and on the 21st of June Baron Fejérváry, an officer in the royal bodyguard, was nominated minister president with a cabinet consisting of little-known permanent officials. Instead of presenting the usual programme, the new premier read to the parliament a royal autograph letter stating the reasons which had actuated the king in taking this course, and giving as the task of the new ministry the continuance of negotiations with the Coalition on the basis of the exclusion of the language question. The parliament was at the same time prorogued. A period followed of arbitrary government on the one hand and of stubborn passive resistance on the other. Three times the parliament was again prorogued—from the 15th of September to the 10th of October, from this date to the 19th of December, and from this yet again to the 1st of March 1906—in spite of the protests of both Houses. To the repressive measures of the government—press censorship, curtailment of the right of public meeting, dismissal of recalcitrant officials, and dragooning of disaffected county assemblies and municipalities—the Magyar nation opposed a sturdy refusal to pay taxes, to supply recruits or to carry on the machinery of administration.

Had this attitude represented the temper of the whole Hungarian people, it would have been impossible for the crown to have coped with it. But the Coalition represented, in fact, not the mass of the people, but only a small dominant minority,¹ and for years past this minority had neglected the social and economic needs of the mass of the people in the eager pursuit of party advantage and the effort to impose, by coercion and corruption failing other means, the Magyar language and Magyar culture on the non-Magyar races. In this supreme crisis, then, it is not surprising that the masses listened with sullen indifference to the fiery eloquence of the Coalition leaders. Moreover, by refusing the royal terms, the Coalition had forced the crown into an alliance with the extreme democratic elements in the state. Universal suffrage had already been adopted in the Cis-leithan half of the monarchy; it was an obvious policy to propose it for Hungary also, and thus, by an appeal to the non-Magyar majority, to reduce the irreconcilable Magyar minority to reason. Universal suffrage, then, was the first and most important of the proposals put forward by Mr Jozsef Kristóffy, the minister of the interior, in the programme issued by him on the 26th of November 1905. Other proposals were: the maintenance of the system of the joint army as established in 1867, but with the concession that all Hungarian recruits were to receive their education in Magyar; the maintenance till 1917 of the actual customs convention with Austria; a reform of the land laws, with a view to assisting the poorer proprietors; complete religious equality; universal and compulsory primary education.

The issue of a programme so liberal, and notably the inclusion in it of the idea of universal suffrage, entirely checkmated the opposition parties. Their official organs, indeed, continued to fulminate against the "unconstitutional" government, but the enthusiasm with which the programme had been received in the country showed the Coalition leaders the danger of their position, and henceforth, though they continued their denunciations of Austria, they entered into secret negotiations with the king-emperor, in order, by coming to terms with him, to ward off the fatal consequences of Kristóffy's proposals.

On the 19th of February 1906 the parliament was dissolved, without writs being issued for a new election, a fact accepted by the country with an equanimity highly disconcerting to patriots. Meanwhile the negotiations continued, so secretly that when, on the 9th of April, the appointment of a Coalition cabinet² under Dr Sandor Wekerle was announced, the world was taken completely by surprise.

¹ Of the 16,000,000 inhabitants of Hungary barely a half were Magyar; and the franchise was possessed by only 800,000, of whom the Magyars formed the overwhelming majority.

² The cabinet consisted of Dr Wekerle (premier and finance), Ferencz Kossuth (commerce), Count Gyula Andrássy (interior), Count Albert Apponyi (education), Daványi (agriculture), Polónyi (justice) and Count Aladár Zichy (court).

The agreement with the crown which had made this course possible included the postponement of the military questions that had evoked the crisis, and the acceptance of the principle of Universal Suffrage by the Coalition leaders, who announced that their main tasks would be to repair the mischief wrought by the "unconstitutional" Fejérváry cabinet, and then to introduce a measure of franchise reform so wide that it would be possible to ascertain the will of the whole people on the questions at issue between themselves and the crown.³ In the general elections that followed the Liberal party was practically wiped out, its leader, Count István Tisza, retiring into private life.

For two years and a half the Coalition ministry continued in office without showing any signs that they intended to carry out the most important item of their programme. The old abuses continued: the muzzling of the press in the interests of Magyar nationalism, the imprisonment of non-Magyar deputies for "incitement against Magyar nationality," the persecution of Socialists and of the subordinate races. That this condition of things could not be allowed to continue was, indeed, recognized by all parties; the fundamental difference of opinion was as to the method by which it was to be ended. The dominant Magyar parties were committed to the principle of franchise reform; but they were determined that this reform should be of such a nature as not to imperil their own hegemony. What this would mean was pointed out by Mr Kristóffy in an address delivered at Budapest on the 14th of March 1907. "If the work of social reform," he said, "is scamped by a measure calculated to falsify the essence of reform, the struggle will be continued in the Chamber until full electoral liberty is attained. Till then there can be no social peace in Hungary."⁴ The postponement of the question was, indeed, already producing ugly symptoms of popular indignation. On the 10th of October 1907 there was a great and orderly demonstration at Budapest, organized by the socialists, in favour of reform. About 100,000 people assembled, and a deputation handed to Mr Justh, the president of the Chamber, a monster petition in favour of universal suffrage. The reception it met with was not calculated to encourage constitutional methods. The Socialist deputy, Mr Mezöffy, who wished to move an interpellation on the question, was howled down by the Independents with shouts of "Away with him! Down with him!"⁵ Four days later, in answer to a question by the same deputy, Count Andrássy said that the Franchise Bill would be introduced shortly, but that it would be of such a nature that "the Magyar State idea would remain intact and suffer no diminution."⁶ Yet more than a year was to pass before the promised bill was introduced, and meanwhile the feeling in the country had grown more intense, culminating in serious riots at Budapest on the 13th of March 1908.

At last (November 11, 1908) Count Andrássy introduced the long-promised bill. How far it was from satisfying the demands of the Hungarian people was at once apparent. It granted manhood suffrage, it is true, but hedged with so many qualifying conditions and complicated with so elaborate a system of plural voting as to make its effect nugatory. Every male Hungarian citizen, able to read and write, was to receive the vote at the beginning of his twenty-fifth year, subject to a residential qualification of twelve months. Illiterate citizens were to choose one elector for every ten of their number. All electors not having the qualifications for the plural franchise were to have one vote. Electors who, e.g., had passed four standards of a secondary school, or paid 16s. 8d. in direct taxation, were to have two votes. Electors who had passed five standards, or who paid £4. 3s. 4d. in direct taxes, were to have three votes. Voting was to be public, as before, on the ground, according to the Preamble, that "the secret ballot protects electors in dependent positions only in so far as they break their promises under the veil of secrecy."

It was at once seen that this elaborate scheme was intended

¹ Seton-Watson, *Racial Problems*, p. 194.

² *The Times*, March 14, 1907.

³ *Ibid.* October 11, 1907.

⁴ *Ibid.* October 15, 1907.

to preserve "the Magyar State idea intact." Its result, had it passed, would have been to strengthen the representation of the Magyar and German elements, to reduce that of the Slovaks, and almost to destroy that of the Rumanians and other non-Magyar races whose educational status was low.¹ On the other hand, according to the *Neue Freie Presse*, it would have increased the number of electors from some million odd, to 2,600,000, and the number of votes to 4,000,000; incidentally it would have largely increased the working-class representation.

This proposal was at once recognized by public opinion—to use the language of the *Journal des Débats* (May 21, 1909)—as "an instrument of domination" rather than as an attempt to carry out the spirit of the compact under which the Coalition government had been summoned to power. It was not, indeed, simply a reactionary or undemocratic measure; it was, as *The Times* correspondent pointed out, "a measure *sui generis*, designed to defeat the objects of the universal suffrage movement that compelled the Coalition to take office in April 1906, and framed in accordance with Magyar needs as understood by one of the foremost Magyar noblemen." Under this bill culture was to be the gate to a share in political power, and in Hungary culture must necessarily be Magyar.

Plainly, this bill was not destined to settle the Hungarian problem, and other questions soon arose which showed that the crisis, so far from being near a settlement, was destined to become more acute than ever. In December 1908

The crisis 1909-1910.

it was clear that the Coalition Ministry was falling to pieces. Those ministers who belonged to the constitutional and popular parties, i.e. the Liberals and Clericals, desired to maintain the compact with the crown; their colleagues of the Independence party were eager to advance the cause they have at heart by pressing on the question of a separate Hungarian bank. So early as March 1908 Mr Hallo had laid a formal proposal before the House that the charter of the Austro-Hungarian bank, which was to expire on the 31st of December 1910, should not be renewed; that negotiations should be opened with the Austrian government with a view to a convention between the banks of Austria and Hungary; and that, in the event of these negotiations failing, an entirely separate Hungarian bank should be established. The Balkan crisis threw this question into the background during the winter; but, with the settlement of the international questions raised by the annexation of Bosnia and Herzegovina, it once more came to the front. The ministry was divided on the issue, Count Andrassy opposing and Mr Ferencz Kossuth supporting the proposal for a separate bank. Finally, the prime minister, Dr Wekerle, mainly owing to the pressure put upon him by Mr Justh, the president of the Chamber, yielded to the impertunity of the Independence party, and, in the name of the Hungarian government, laid the proposals for a separate bank before the king-emperor and the Austrian government.

The result was a foregone conclusion. The conference at Vienna revealed the irreconcilable difference within the ministry; but it revealed also something more—the determination of the emperor Francis Joseph, if pressed beyond the limits of his patience, to appeal again to the non-Magyar Hungarians against the Magyar chauvinists. He admitted that under the Compromise of 1867 Hungary might have a separate bank, while urging the expediency of such an arrangement from the point of view of the international position of the Dual Monarchy. But he pointed out also that the question of a separate bank did not actually figure in the act of 1867, and that it could not be introduced into it, *more especially since the capital article of the ministerial programme, i.e. electoral reform, was not realised, nor near being realised.* On the 27th of April, in consequence of this rebuff, Dr Wekerle tendered his resignation, but consented to hold office pending the completion of the difficult task of forming another government.

This task was destined to prove one of almost insuperable difficulty. Had the issues involved been purely Hungarian and

¹ *The Times*, September 27, 1908.

constitutional, the natural course would have been for the king to have sent for Mr Kossuth, who commanded the strongest party in the parliament, and to have entrusted him with the formation of a government. But the issues involved affected the stability of the Dual Monarchy and its position in Europe; and neither the king-emperor nor his Austrian advisers, their position strengthened by the success of Baron Aehrenthal's diplomatic victory in the Balkans, were prepared to make any substantial concessions to the party of Independence. In these circumstances the king sent for Dr László Lukacs, once finance minister in the Fejérváry cabinet, whose task was, acting as a *homo regius* apart from parties, to construct a government out of any elements that might be persuaded to co-operate with him. But Lukacs had no choice but to apply in the first instance to Mr Kossuth and his friends, and these, suspecting an intention of crushing their party by entrapping them into unpopular engagements, rejected his overtures. Nothing now remained but for the king to request Dr Wekerle to remain "for the present" in office with his colleagues, thus postponing the settlement of the crisis (July 4).

This procrastinating policy played into the hands of the extremists; for supplies had not been voted, and the question of the credits for the expenditure incurred in connexion with the annexation of Bosnia and Herzegovina, increasingly urgent, placed a powerful weapon in the hands of the Magyars, and made it certain that in the autumn the crisis would assume an even more acute form. By the middle of September affairs had again reached an *impasse*. On the 14th Dr Wekerle, at the ministerial conference assembled at Vienna for the purpose of discussing the estimates to be laid before the delegations, announced that the dissensions among his colleagues made the continuance of the Coalition government impossible. The burning points of controversy were the magyarization of the Hungarian regiments and the question of the separate state bank. On the first of these Wekerle, Andrassy and Apponyi were prepared to accept moderate concessions; as to the second, they were opposed to the question being raised at all. Kossuth and Justh, on the other hand, competitors for the leadership of the Independence party, declared themselves not prepared to accept anything short of the full rights of the Magyars in those matters. The matter was urgent; for parliament was to meet on the 28th, and it was important that a new cabinet, acceptable to it, should be appointed before that date, or that the Houses should be prorogued pending such appointment; otherwise the delegations would be postponed and no credits would be voted for the cost of the new Austro-Hungarian "Dreadnoughts" and of the annexation of Bosnia-Herzegovina. In the event, neither of these courses proved possible, and on the 28th Dr Wekerle once more announced his resignation to the parliament.

The prime minister was not, however, as yet to be relieved of an impossible responsibility. After a period of wavering Mr Kossuth had consented to shelve for the time the question of the separate bank, and on the strength of this Dr Wekerle advised the crown to entrust to him the formation of a government. The position thus created raised a twofold question: Would the crown accept? In that event, would he be able to carry his party with him in support of his modified programme? The answer to the first question, in effect, depended on that given by events to the second; and this was not long in declaring itself. The plan, concerted by Kossuth and Apponyi, with the approval of Baron Aehrenthal, was to carry on a modified coalition government with the aid of the Andrassy Liberals, the National party, the Clerical People's party* and the Independence party, on a basis of suffrage reform with plural franchise, the

* The People's party first emerged during the elections of 1896, when it contested 98 seats. Its object was to resist the anti-clerical tendencies of the Liberals, and for this purpose it appealed to the "nationalities" against the dominant Magyar parties, the due enforcement of the Law of Equal Rights of Nationalities (1868) forming a main item of its programme. Its leader, Count Zichy, in a speech of Jan. 1, 1897, declared it to be neither national, nor Liberal, nor Christian to oppress the nationalities. See Seton-Watson, p. 185.

prolongation of the charter of the joint bank, and certain concessions to Magyar demands in the matter of the army. It was soon clear, however, that in this Kossuth would not carry his party with him. A trial of strength took place between him and Mr de Justh, the champion of the extreme demands in the matter of Hungarian financial and economic autonomy; on the 7th of November rival banquets were held, one at Mako, Justh's constituency, over which he presided, one at Budapest with Kossuth in the chair; the attendance at each foreshadowed the outcome of the general meeting of the party held at Budapest on the 11th, when Kossuth found himself in a minority of 46. The Independence party was now split into two groups: the "Independence and 1848 party," and the "Independence, 1848 and Kossuth party."

On the 12th Mr de Justh resigned the presidency of the Lower House and sought re-election, so as to test the relative strength of parties. He was defeated by a combination of the Kossuthists, Andrásy Liberals and Clerical People's party, the 30 Croatian deputies, whose vote might have turned the election, abstaining on Dr Wekerle promising them to deliver Croatia from the oppressive rule of the ban, Baron Rauch. A majority was thus secured for the Kossuthist programme of compromise, but a majority so obviously precarious that the king-emperor, influenced also—it was rumoured—by the views of the heir-apparent, in an interview with Count Andrásy and Mr Kossuth on the 15th, refused to make any concessions to the Magyar national demands. Hereupon Kossuth publicly declared (Nov. 22) to a deputation of his constituents from Czegled that he himself was in favour of an independent bank, but that the king opposed it, and that in the event of no concessions being made he would join the opposition.

How desperate the situation had now become was shown by the fact that on the 27th the king sent for Count Tisza, on the recommendation of the very Coalition ministry which had been formed to overthrow him. This also proved abortive, and affairs rapidly tended to revert to the *ex-lex* situation. On the 23rd of December Dr Lukacs was again sent for. On the previous day the Hungarian parliament had adopted a proposal in favour of an address to the crown asking for a separate state bank. Against this Dr Wekerle had protested, as opposed to general Hungarian opinion and ruinous to the national credit, pointing out that whenever it was a question of raising a loan, the maintenance of the financial community between Hungary and Austria was always postulated as a preliminary condition. Point was given to this argument by the fact that the premier had just concluded the preliminaries for the negotiation of a loan of £20,000,000 in France, and that the money—which could not be raised in the Austrian market, already glutted with Hungarian securities—was urgently needed to pay for the Hungarian share in the expenses of the annexation policy, for public works (notably the new railway scheme), and for the redemption in 1910 of treasury bonds. It was hoped that, in the circumstances, Dr Lukacs, a financier of experience, might be able to come to terms with Mr de Justh, on the basis of dropping the bank question for the time, or, failing that, to patch together out of the rival parties some sort of a working majority.

On the 28th the Hungarian parliament adjourned *sine die*, pending the settlement of the crisis, without having voted the estimates for 1910, and without there being any prospect of a meeting of the delegations. On the two following days Dr Lukacs and Mr de Justh had audiences of the king, but without result; and on the 31st Hungary once more entered on a period of extra-constitutional government.

After much negotiation a new cabinet was finally constituted on the 17th of January 1910. At its head was Count Khuen Hederváry, who in addition to the premiership, was **Khuen Hederváry** minister of the interior, minister for Croatia, and minister in waiting on the crown. Other ministers were Mr Károly de Hieronymi (commerce), Dr Lukacs (finance), Ferencz de Szekeley (justice, education, public worship), Béla Serenyi (agriculture) and General Hazay (national defence). The two main items in the published programme of the new

government were the introduction of universal suffrage and— even more revolutionary from the Magyar point of view—the substitution of state-appointed from elected officials in the counties. The real programme was to secure, by hook or by crook, a majority at the polls. Meanwhile, the immediate necessities of the government were provided for by the issue through Messrs Rothschild of £2,000,000 fresh treasury bills. These were to be redeemed in December 1910, together with the £9,000,000 worth issued in 1909, out of the £20,000,000 loan agreed on in principle with the French government; but in view of the opposition in Paris to the idea of advancing money to a member of the Triple Alliance, it was doubtful whether the loan would ever be floated.

The overwhelming victory of the government in June at the polls produced a lull in a crisis which at the beginning of the year had threatened the stability of the Dual Monarchy and the peace of Europe; but, in view of the methods by which the victory had been won, not the most sanguine could assert that the crisis was overpassed. Its deep underlying causes can only be understood in the light of the whole of Hungarian history. It is easy to denounce the dominant Magyar classes as a selfish oligarchy, and to criticize the methods by which they have sought to maintain their power. But a nation that for a thousand years had maintained its individuality in the midst of hostile and rival races could not be expected to allow itself without a struggle to be sacrificed to the force of mere numbers, and the less so if it were justified in its claim that it stood for a higher ideal of culture and civilization. The Magyars had certainly done much to justify their claim to a special measure of enlightenment. In their efforts to establish Hungarian independence on the firm basis of national efficiency they had succeeded in changing their country from one of very backward economic conditions into one which promised to be in a position to hold its own on equal terms with any in the world. (W. A. P.)

BIBLIOGRAPHY.—(a) Sources. The earliest important collection of sources of Hungarian history was Johann Georg Schrandtner's *Scriptores rerum Hungaricarum* (4th ed., Vienna, 1766-1768). The *Codex diplomaticus* of György Fejér (40 vols., Buda, 1829-1844), though full of errors, remains an inexhaustible storehouse of materials. In 1849 Stephen Ladislaus Endlicher (1804-1849), better known as a botanist than as a historian, published a collection of documents, *Rerum hungaricarum monumenta Arpadiana*. This was followed by Gustav Wenzel's *Codex diplomaticus arpadianus continuens* (12 vols., Pest, 1857) and A. Theiner's *Vel. monumenta hist. Hungariam sacram illustrantia* (2 vols., Rome, 1859, &c.). Later collections are *Documents of the Angevin Period*, ed. by G. Wenzel and Imre Nagy (8 vols., ib. 1874-1876); *Diplomatic Records of the Time of King Matthias* (Mag. and Lat.), ed. by Ivan Nagy (ib. 1875-1878); *National Documents* (Mag. and Lat.), ed. by Farkas Deák and others (Pest, 1878-1891); *Monumenta Vaticana historiam regni Hungariae illustrantia* (8 vols., Budapest, 1885-1891), a valuable collection of materials from the Vatican archives, edited under the auspices of the Hungarian bishops; *Principal Sources for the Magyar Conquest* (Mag.), by Gyula Pauler and Sándor Szilágyi (ib. 1900). Numerous documents have also been issued in the various publications of the Hungarian Academy and the Hungarian Historical Society. Of these the most important is the *Monumenta Hungariae Historica*, published by the Academy. This falls into three main groups: *Diplomata* (30 vols.); *Scriptores* (40 vols.); *Monumenta Comitatalia* (records of the Hungarian and Transylvanian diets, 12 vols. and 21 vols.). With these are associated the *Turkish-Hungarian Records* (9 vols.), *Turkish Historians* (2 vols. pubd.), and the *Archives of the Hungarian subordinate countries* (2 vols. pubd.).

On the sources see Hendrik Marczali, *Ungarns Geschichtsquellen im Zeitalter des Arpáden* (Berlin, 1882); Kaindl, *Studien zu den ungarischen Geschichtsquellen* (Vienna, 1894-1902); and, for a general appreciation, Mangold, *Pragmatic History of the Hungarians* (in Mag., 5th ed., Budapest, 1907).

(b) Works. The modern literature of Hungary is very rich in historical monographs, of which a long list will be found in the Subject Index of the London Library. Here it is only possible to give some of the more important general histories, together with such special works as are most readily accessible to English readers. Of the earlier Hungarian historians two are still of some value: Katona, *Hist. critica regum Hungariae* (42 vols., Pest, 1779-1810), and Pray, *Annales regum Hungariae* (5 vols., Vienna, 1764-1770). Of modern histories written in Magyar the most imposing is the *History of the Hungarian Nation* (10 vols., Budapest, 1898), issued to commemorate the celebration of the millennium of the foundation of the monarchy, by Sándor Szilágyi and numerous collaborators. Of importance, too,

work¹ at Cracow in 1531 to the end of the period just treated, more than 1800 publications in the native language are known.²

The period comprised between the peace of Szatmár (1711) and the year 1772 is far more barren in literary results than even that which preceded it. The exhaustion of the nation from its protracted civil and foreign wars, the extinction of the court of the Transylvanian princes where the native language had been cherished, and the prevalent use of Latin in the schools, public transactions and county courts, all combined to bring about a complete neglect of the Magyar language and literature. Among the few prose writers of distinction were Andrew Spangár, whose "Hungarian Bookstore," *Magyar Könyvtár* (Kassa, 1738), is said to be the earliest work of the kind in the Magyar dialect; George Bárányi, who translated the New Testament (Lauba, 1754); the historians Michael Cserei and Matthew Béli, which last, however, wrote chiefly in Latin; and Peter Bod, who besides his theological treatises compiled a history of Hungarian literature under the title *Magyar Athénás* (Szeben, 1766). But the most celebrated writer of this period was the Jesuit Francis Faludi, the translator, through the Italian, of William Darrell's works. On account of the classic purity of his style in prose, Faludi was known as the "Magyar Cicero." Not only as a philosophic and didactic writer, but also as a lyric and dramatic poet he surpassed all his contemporaries. Another pleasing lyric poet of this period was Ladislaus Amadei, the naturalness and genuine sentiment of whose lightly running verses are suggestive of the love songs of Italian authors. Of considerable merit are also the sacred lyrical melodies of Paul Rádai in his *Lelki hódolat* (Spiritual Homage), published at Debreczen in 1715. Among the didactic poets may be mentioned Lewis Nagy, George Kálmár, John Illey and Paul Bertalanf, especially noted for his rhymed "Life of St. Stephen, first Hungarian king," *Dicsőitésés Szent István első magyar királyának életé* (Vienna, 1751).

The next three literary periods stand in special relationship to one another, and are sometimes regarded as the same. The first two, marking respectively the progress of the "Regeneration of the Native Literature" (1772-1807) and the "Revival of the Language" (1807-1830), were introductory to and preparatory for the third or "Academy," period, which began about 1830. In consequence of the general neglect of the Magyar language during the reigns of Maria Theresa and her successor Joseph II., the more important prose productions of the latter part of the 18th century, as for instance the historical works of George Pray, Stephen Katona, John Engel and Ignatius Fessler, were written either in Latin or in German. The reaction in favour of the native literature manifested itself at first chiefly in the creation of various schools of poetry. Foremost among these stood the so-called "French" school, founded by George Bessenyei, the author of several dramatic pieces, and of an imitation of Pope's "Essay on Man," under the title of *As embernek próbája* (Vienna, 1772). Bessenyei introduced the use of rhymed alexandrines in place of the monotonous Zrínyi measure. Other writers of the same school were Laurence Orczy and Abraham Barcsay, whose works have a striking resemblance to each other, and were published together by Révai (1780). The songs and elegies of the short-lived Paul Ányos, edited by Bacszányi in 1798, show great depth of feeling. Versifiers and adapters from the French appeared also in Counts Adam and Joseph Teleki, Alexander Báróczi and Joseph Péczeli, known also as the translator of Young's "Night Thoughts." The chief representatives of the strictly "classical" school, which adopted the ancient Greek and Latin authors as its models, were David Baróti Szabó, Nicholas Révai, Joseph Rájnis and Benedict Virág. Among the most noteworthy works of Baróti are the *Uj mértékbe vitt külömb versék* (Kassa, 1777), comprising hexameter verses, Horatian odes, distichs, epistles and epigrams; the *Paraszt Majorság* (Kassa, 1779-1780), an hexameter version of Vanière's *Prædium rusticum*; and an abridged version of "Paradise Lost," contained in the *Költeményes munkái* (Komárom, 1802). Baróti, moreover, published (1810-1813) a translation of Virgil's *Aeneid* and *Eloques*. Of Baróti's purely linguistic works the best known are his *Orthographia és Prosodia* (Komárom, 1800); and the *Kisded Szótár* (Kassa, 1784 and 1792) or "Small Lexicon" of rare Hungarian words. As a philologist Baróti was far surpassed by Nicholas Révai, but as a poet he may be considered superior to Rájnis, translator of Virgil's *Bucolics* and *Georgics*, and author of the *Magyar Helikonra vezető kalauz* (Guide to the Magyar Helicon, 1781). The "classical" school reached its highest state of culture under Virág, whose poetical works, consisting chiefly of Horatian odes and epistles, on account of the perfection of their style, obtained for him the name of the "Magyar Horace." The *Poetái Munkái* (Poetical Works) of Virág were published at Pest in 1790, and again in 1822. Of his prose works the most important is the *Magyar Szászok* or "Pragmatic History of Hungary" (Buda, 1808 and 1816). Vályi-Nagy, the first Magyar

translator of Homer, belongs rather to the "popular" than the "classical" school. His translation of the *Iliad* appeared at Sárospatak in 1821. The establishment of the "national" or "popular" school is attributable chiefly to Andrew Dugonics, though his earliest works, *Troja veszedelmé* (1774) and *Ulysszes* (1780), indicate a classical bias. His national romances, however, and especially *Etelka* (Pozsony, 1787) and *As arany pereszék* (Pest and Pozsony, 1790), attracted public attention, and were soon adapted for the stage. The most valuable of his productions is his collection of "Hungarian Proverbs and Famous Sayings," which appeared in 1820 at Szeged, under the title of *Magyar példabeszédek és jók mondások*. The most noteworthy follower of Dugonics was Adam Horváth, author of the epic poems *Hunnák* (Győr, 1787) and *Rudolphás* (Vienna, 1817). Joseph Gvadányi's tripartite work *Faluai notárius* (Village Notary), published between 1790 and 1796, as also his *Rontó Pál és gr. Benyowsky történetek* (Adventures of Paul Rontó and Count Benyowski), are humorous and readable, but careless in style. As writers of didactic poetry may be mentioned John Endrődy, Caspar Göböl, Joseph Takács and Barbara Molnár, the earliest distinguished Magyar poetess.

Of a more general character, and combining the merits of the above schools, are the works of the authors who constituted the so-called "Debreczen Class," which boasts the names of the naturalist and philologist John Földi, compiler of a considerable part of the *Debreczeni magyar grammatica*; Michael Fazekas, author of *Ludas Mátty* (Vienna, 1817), an epic poem, in 4 cantos; and Joseph Kovács. Other precursors of the modern school were the poet and philologist Francis Verseghy, whose works extend to nearly forty volumes; the gifted didactic prose writer, Joseph Kármán; the metrical rhymster, Gideon Ráday; the lyric poets, Szentjóbí Szabó, Janos Bacszányi (q.v.), and the short-lived Gabriel Dayka, whose posthumous "Verses," were published in 1813 by Kazinczy. Still more celebrated were Mihály Csokonai (q.v.) and Alexander Kisfaludy (q.v.). The first volume of Alexander Kisfaludy's *Himfy*, a series of short lyrics of a descriptive and reflective nature, appeared at Buda in 1801, under the title of *Kesergő szerelme* (Unhappy Love), and was received with great enthusiasm; nor was the success of the second volume *Boldog szerelme* (Happy Love), which appeared in 1807, inferior. The *Regék*, or "Tales of the Past," were published at Buda from 1807 to 1808, and still further increased Kisfaludy's fame; but in his dramatic works he was not equally successful. Journalistic literature in the native language begins with the *Magyar Harmonia* (Harbinger) started by Matthias Ráth at Pozsony in 1760. Among the magazines the most important was the *Magyar Museum*, established at Kassa (Kaschau) in 1788 by Baróti, Kazinczy and Bacszányi. The *Orpheus* (1790) was the special work of Kazinczy, and the *Urania* (1794) of Kármán and Fajor.

Closely connected with the preceding period is that of the "Revival of the Language" (1807-1830), with which the name of Francis Kazinczy (q.v.) is especially associated. To him it was left to perfect that work of restoration begun by Baróti and amplified by Révai. Poetry and belles lettres still continued to occupy the chief place in the native literature, but under Kazinczy and his immediate followers Berzsenyi, Kálcsay, Fáy and others, a correctness of style and excellence of taste hitherto unknown soon became apparent. Kazinczy, in his efforts to accommodate the national language to the demands of an improved civilization, availed himself of the treasures of European literature, but thereby incurred the opposition of those who were prejudiced by a too biased feeling of nationality. The opinions of his enemies were ventilated in a lampoon styled *Mondolat*. Daniel Berzsenyi, whose odes are among the finest in the Hungarian language, was the correspondent of Kazinczy, and like him a victim of the attacks of the *Mondolat*. But the fervent patriotism, elevated style, and glowing diction of Berzsenyi soon caused him to be recognized as a truly national bard. A too frequent allusion to Greek mythological names is a defect sometimes observable in his writings. His collective works were published at Buda by Döbrentei in 1842. Those of John Kis, the friend of Berzsenyi, cover a wide range of subjects, and comprise, besides original poetry, many translations from the Greek, Latin, French, German and English, among which last may be mentioned renderings from Blair, Pope and Thomson, and notably his translation, published at Vienna in 1791, of Louth's "Choice of Hercules." The style of Kis is unaffected and easy. As a sonnet writer none stands higher than Paul Szemere, known also for his rendering of Körner's drama *Zrínyi* (1818), and his contributions to the *Élet és Irodalmis* (Life and Literature). The articles of Francis Kálcsay in the same periodical are among the finest specimens of Hungarian æsthetic criticism. The lyric poems of Kálcsay can hardly be surpassed, whilst his orations, and markedly the *Emlék beszéd Kazinczy felett* (Commemorative Speech on Kazinczy), exhibit not only his own powers, but the singular excellence of the Magyar language as an oratorical medium. Andrew Fáy, sometimes styled the "Hungarian Aesop," is chiefly remembered for his *Eredeti Mesék* (Original Fables). The dramatic works of Charles Kisfaludy, brother of Alexander, won him enthusiastic recognition as a regenerator of the drama. His plays bear a distinctive national character, the subjects of most of them referring to the golden era of the country. His genuine simplicity as a lyrical writer is shown by the fact that several of his shorter pieces have

¹ The earliest, styled "Song on the Discovery of the right hand of the Holy King Stephen," and printed at Nuremberg by Anton Koburger in 1484, is lost.

² See Chas. Szabó's *Régi Magyar Könyvtár* (Budapest, 1879). Cf. also *Lit. Ber. aus Ungarn* for 1879, Bd. iii. Heft 2, pp. 433-434.

Revival of the language (1807-1830).

passed into popular song. As the earliest Magyarizer of Servian folk-song, Michael Vitkovics did valuable service. Not without interest to Englishmen is the name of Gabriel Döbrentei (q.v.), the translator of Shakespeare's *Macbeth*, represented at Pozsony in 1825. An historical poem of a somewhat philosophical nature was produced in 1814 by Andreas Horváth under the title of *Zircs emlékeztető* (Reminiscence of Zirc); but his *Arpád*, in 12 books, finished in 1830, and published at Pest in the following year, is a great national epic. Among other poets of this period were Alois Szentmiklósy, George Gaal, Emil Buczy, Joseph Szász, Ladislaus Tóth and Joseph Katona, author of the much-extolled historical drama *Bánk Bán*.¹ Izidore Gussnics, the translator of Theocritus into Magyar hexameters, is chiefly noted for his prose writings on ecclesiastical and philosophical subjects. As authors of special works on philosophy, we find Samuel Kőtelek, John Imre, Joseph Ruasek, Daniel Ercei and Paul Sárvári; as a theologian and Hebraist John Somossy; as an historian and philologist Steffen Horváth, who endeavored to trace the Magyar descent from the earliest historic times; as writers on jurisprudence Alexander Kövy and Paul Selemencia. For an account of the historian George Fejér, the laborious compiler of the *Codex Diplomaticus*, see FEJÉR.

The establishment of the Hungarian Academy of Sciences² (17th November 1830) marks the commencement of a new period, in the first eighteen years of which gigantic exertions were made as regards the literary and intellectual life of the nation. The language, nursed by the academy, developed rapidly, and showed its capacity for giving expression to almost every form of scientific knowledge.³ By offering rewards for the best original dramatic productions, the academy provided that the national theatre should not suffer from a lack of classical dramas. During the earlier part of its existence the Hungarian academy devoted itself mainly to the scientific development of the language and philological research. Since its reorganization in 1869 the academy has, however, paid equal attention to the various departments of history, archaeology, national economy and the physical sciences. The encouragement of polite literature was more especially the object of the Kisfaludy Society, founded in 1836.⁴

Polite literature had received a great impulse in the preceding period (1807-1830), but after the formation of the academy and the Kisfaludy society it advanced with accelerated speed towards the point attained by other nations. Foremost among epic poets, though not equally successful as a dramatist, was Mihály Vörösmarty (q.v.), who, belonging also to the close of the last period, combines great power of imagination with elegance of language. Generally less varied and romantic, though easier in style, are the heroic poems *Augsburgi átköztés* (Battle of Augsburg) and *Aradi gyűlés* (Diet of Arad) of Gregory Csanócz, who was, moreover, very felicitous as an epigrammatist. Martin Debreczeni was chiefly famed for his *Kivői csata* (Battle of Kieff), published at Pest in 1854 after his death by Count Emerich Mikó. The laborious John Garay in his *Szent László* shows considerable ability as an epic poet, but his greatest merit was rather as a romancist and ballad writer, as shown by the "Pen Sketches" or *Teljesítmények* (1843), and his legendary series *Arpádotok* (1847). Joseph Bajza was a lyricist of a somewhat melancholy cast, but his *Borsoskő* (Wine Song), *Sokaföldi* (Siph), *Ebresség* (Awakening) and *Aposztolok* are much admired. He is known further as the translator of F. C. Dahlmann's *Geschichte der englischen*

Reminiscence. As generally able writers of lyrical poetry during the earlier part of this period may be mentioned among others Francis Császár, Joseph Székács and Andrew Kunos—also Lewis Szalki and Alexander Vachott, whose songs and romances are of an arless and simple character, and the sacred lyricist Béla Tárkányi. As an original but rather heavy lyric and didactic poet we may mention Peter Vajda, who was, moreover, the translator of Bulwer's "Night and Morning." Of a more distinctly national tendency are the lyrics of John Kriza⁵ and John Erdélyi, but the reputation of the latter was more especially due to his collections of folk-lore made on behalf of the Kisfaludy society. More popular than any of the preceding, and well known in England through Sir John Bowring's translation, are the charming lyrics of Alexander Petöfi (q.v.), the "Burns" of Hungary. His poems, which embody the national genius, have passed into the very life of the people, particularly is he happy in the pieces descriptive of rural life. Among lyricists were: Coloman Tóth, who is also the author of several epic and dramatic pieces; John Vajda, whose *Kisebb költemények* (Minor Poems), published by the Kisfaludy society in 1872, are partly written in the mode of Heine, and are of a pleasing but melancholy character; Joseph Lévy, known also as the translator of Shakespeare's *Titus Andronicus*, *Taming of the Shrew* and *Henry IV.*; and Paul Gyulai, who, not only as a faultless lyric and epic poet, but as an impartial critical writer, is highly esteemed, and whose *Romhányi* is justly prized as one of the best Magyar poems that has appeared in modern times. To these may be added the names of Charles Berecz, Joseph Zalár, Samuel Nyilas, Joseph Vida, Lewis Tolnai, the sentimental Ladislaus Seleztey, and the talented painter Zoltán Balogh, whose romantic poem *Alpári* was published in 1871 by the Kisfaludy society. The lyrics of Anthony Várady (1875, 1877) are somewhat dull and unequal in tone; both he and Baron Ivor Kaas, author of *Az ítélet napja* (Day of Judgment, 1876), have shown skill rather in the art of dramatic verse. The poems of Count Géza Zichy and Victor Dalmady, those of the latter published at Budapest in 1876, are mostly written on subjects of a domestic nature, but are conceived in a patriotic spirit. Emil Abarányi adopts a rather romantic style, but his *Nagyfőntök* (Good Friday) is an excellent descriptive sketch. Alexander Endrődy, author of *Ticsók dalok* (Cricket Songs, 1876), is a glowing writer, with great power of conception, but his metaphors, following rapidly one upon the other, become often confused. Joseph Kiss in 1876 brought out a few lyric and epic poems of considerable merit. The *Mesék* of Augustus Greguss (1878), a collection of verse "Fables," belonging to the school of Gay, partake more of a didactic than lyrical nature. This feature is noticeable also in the *Költemények* (1873) of Ladislaus Torkos and the *Modern Mesék* (1874) of Ladislaus Névy. The *Salamon* (1878) of Charles Szász (b. 1829) was rewarded with the prize of the academy. The subject, taken from the age of Hungarian chivalry, is artistically worked out from medieval legends, and gives an excellent description of the times of St Ladislaus of Hungary. Charles Szász is generally better known as a metrical translator than as an original poet. He is the Magyarizer of Shakespeare's *Anthony and Cleopatra*, *Othello*, *Macbeth*, *Henry VIII.*, *Winter's Tale*, *Romeo and Juliet* and *Tempest*, as also of some of the best pieces of Burns, Moore, Byron, Shelley, Milton, Béranger, Lamartine, Victor Hugo, Goethe and others. A translator from Byron and Pope appeared also in Maurice Lukács.⁶

⁵ Unitarian bishop of Transylvania, author of *Vadrúdsók*, or "Wild Roses" (1863), a collection of Szekler folk-songs, ballads and sayings.

⁶ Besides the various translators from the English, as for instance William Györi, Augustus Greguss, Ladislaus Arany, Sigismund Ács, Stephen Fejes and Eugene Rákossy, who, like those already incidentally mentioned, assisted in the Kisfaludy society's version of Shakespeare's complete works, metrical translations from foreign languages were successfully made by Emil Abarányi, Dr Ignatius Barna, Anthony Várady, Andrew Szabó, Charles Berecz, Julius Greguss, Lewis Dóczi, Béla Erdődi, Emerik Gáspár and many others. A Magyar version, by Ferdinand Barna, of the *Kalevala* was published at Pest in 1871. Faithful renderings by Lewis Seberényi, Theodore Lohoczky and Michael Fincicky of the popular poetry of the Slavic nationalities appeared in vols. I. and II. of the *Hazai népköltészet tára* (Treasury of the Country's Popular Song), commenced in 1866, under the auspices of the Kisfaludy society. In vol. III. Rumanian folk-songs were Magyarized by George Ember, Julian Grozescu and Joseph Vilcanu, under the title *Román népdalok* (Budapest, 1877). The *Részak* (Zambor, 1875) is a translation by Eugene Pavlovits from the Servian of Jovan Jovanovits. Both the last-mentioned works are interesting from an ethnographical point of view. We may here note that for foreigners unacquainted with Hungarian there are, besides several special versions of Petöfi and of Arany, numerous anthologies of Magyar poetry in German, by Count Majláth (1825), J. Fenyéry and F. Toldy (1828), G. Steinaecker (1840, 1875), G. Stier (1850), K. M. Kertbeny (1854, 1860), A. Dux (1854), Count Pongrácz (1859-1861), A. M. Riedl (1860), J. Nordheim (1872), G. M. Henning (1874), A. von der Heide (1879) and others. Selections have also been published in English by Sir John Bowring (1830), S. Wekey in his grammar (1852) and E. D. Butler (1877), and in French by H. Desbordes-Valmore and C. E. de Ujfalvy (1873).

¹ The subject is similar to that of Grillparzer's tragedy, *Ein treuer Diener seines Herrn*.

² It was founded in 1825 through the generosity of Count Széchenyi, who devoted his whole income for one year (60,000 florins) to the purpose. It was soon supported by contributions from all quarters except from the government.

³ Among the earlier publications of the academy were the *Tudománytár* (Treasury of Sciences, 1834-1844), with its supplement *Literatúra*; the *Külföldi játkönyv* (Foreign Theatres); the *Magyar nyelv rendszere* (System of the Hungarian language, 1846; 2nd ed., 1847); various dictionaries of scientific, mathematical, philosophical and legal terms; a Hungarian-German dictionary (1835-1838), and a Glossary of Provincialisms (1838). The *Nagy-Szótár* (Great Dictionary), begun by Csanócz and Fogarasi in 1845, was not issued till 1863-1874. Among the regular organs of the academy are the *Transactions* (from 1840), in some 60 vols., and the *Annuaire*.

⁴ Among its earlier productions were the *Nemzeti könyvtár* (National Library), published 1843-1847, and continued in 1852 under the title *Ujabb Nemzeti könyvtár*, a repository of works by celebrated authors; the *Külföldi Regénytár* (Treasury of Foreign Romances), consisting of translations; and some valuable collections of proverbs, folk-songs, traditions and fables. Of the many later publications of the Kisfaludy society the most important as regards English literature is the *Shakspeare Minden Munkái* (Complete Works of Shakespeare), in 19 vols. (1864-1878), to which a supplementary vol., *Shakspeare Pályája* (1880), containing a critical account of the life and writings of Shakespeare, has been added by Professor A. Greguss. Translations from Molière, Racine, Corneille, Calderon and Moreto have also been issued by the Kisfaludy society. The *Bolopok új sorozata*, or "New Series of Annuals," from 1860 (Budapest, 1868, &c.), is a chrestomathy of prize orations, and translations and original pieces, both in poetry and prose.

ecclesiastical history; John Szombáthi, Emeric Révész and Balogh, writers on Protestant church history; William Fraknói, biographer of Cardinal Pázmán, and historian of the Hungarian diets; and Anthony Gévay, Aaron Széldi, Joseph Podhradzky, Charles Szabó, John Jerney and Francis Salamon, who have investigated and elucidated many special historical subjects. For the mediæval history of Hungary the *Mátyás-kori diplomatikai emlékek* (Diplomatic Memorials of the Time of Matthias Corvinus), issued by the academy under the joint editorship of Ivan Nagy and Baron Albert Nyáry, affords interesting material. As a masterly production based on extensive investigation, we note the *Wesselenyi Perencz* (Wesselenyi's Conspiracy) (The Secret Plot of Francis Wesselenyi, 1663-1671), by Julius Pauler (1876). Among the many historians of Magyar literature Francis Toldy *alias* Schödel holds the foremost place. As compilers of useful manuals may be mentioned also Joseph Sevorányi, Zoltán Beóthy, Alexander Imre, Paul Jánbor, Ladislaus Négy, John Körösy and Joseph Szinyei, junior. For philological and ethnographical research into the origin and growth of the language none excels Paul Hunfalvy. He is, moreover, the warm advocate of the theory of its Ugro-Finnic origin, as established by the Uralian traveller Anthony Reguly, the result of whose labours Hunfalvy published in 1864, under the title *A Vogul föld és népe* (The Vogul Land and People). Between 1862 and 1866 valuable philological studies bearing on the same subject were published by Joseph Budenz in the *Nyelvtudományi közlemények* (Philological Transactions). This periodical, issued by the academy, has during the last decade (1870-1880) contained also comparative studies, by Arminius Vámbéry and Gabriel Bálint, of the Magyar, Turkish-Tatar and Mongolian dialects.

As compilers and authors of works in various scientific branches allied to history, may be particularly mentioned—in statistics and geography, Alexis Fényes, Emeric Palugyay, Alexander Konec, John Hunfalvy, Charles Galgóczy, Charles Keleti, Leo Beóthy, Joseph Kőrösi, Charles Ballagi and Paul Király, and, as regards Transylvania, Ladislaus Kováry; in travel, Arminius Vámbéry, Ignatius Goldziher, Ladislaus Magyar, John Xantus, John Jerney, Count Andrásy, Ladislaus Podmaniczky, Paul Hunfalvy; in astronomy, Nicholas Konkoly; in archaeology, Bishop Arnold Ipolyi, Florian Rómer, Emeric Henslmann, John Erdy, Baron Albert Nyáry, Francis Pulszky and Francis Kiss; in Hungarian mythology, Bishop Ipolyi, Anthony Csengery, and Árpád Kerkélyártó; in numismatics, John Erdy and Jacob Rupp; and in jurisprudence, Augustus Karvassy, Theodore Pauler, Gustavus Wenzel, Emeric Csöcskó, John Fogarasi and Ignatius Frank. After 1867 great activity was displayed in history and its allied branches, owing to the direct encouragement given by the Hungarian Historical Society, and by the historical, archaeological, and statistical committees of the academy.

Notwithstanding the exertions of Paul Bugát to arouse an interest in the natural sciences by the establishment in 1841 of the "Hungarian Royal Natural Science Association," no general activity was manifested in this department of knowledge, so far as the native literature was concerned, until 1860, when the academy organized a special committee for the advancement of mathematical and natural science.¹ The principal contributors to the "Transactions" of this section of the academy were—for anatomy and physiology, Coloman Balogh, Eugene Jendrassik, Joseph Lenhossék and Lewis Thanhoffner; for zoology, John Frivaldszky, John Kriesch and Theodore Margó; for botany, Frederick Hazsinszky, Lewis Jurányi and Julius Klein; for mineralogy and geology, Joseph Szabó, Max Hanken, Joseph Krenner, Anthony Koch and Charles Hoffman; for physics, Baron Lorand Eötvös, Coloman Szily and Joseph Sztoczek; for chemistry, Charles Than and Vincent Wartha; for meteorology, Guido Schenel. As good text-books, for which the so-called "Ladies' Prize" was awarded by the academy, we may mention the *Természettan* (Physics) and *Természettani földrajz* (Physical Geography) of Julius Gressus.

Almost simultaneously with the formation of the above-mentioned committee of the academy, the "Natural Science Association" showed signs of renewed animation, and soon advanced with rapid strides in the same direction, but with a more popular aim than the academy. Between 1868 and 1878 the number of its members increased from some 600 to about 5000. After 1872, in addition to its regular organs, it issued Hungarian translations of several popular scientific English works, as, for instance, Darwin's *Origin of Species*; Huxley's *Lessons in Physiology*; Lubbock's *Prehistoric Times*; Proctor's *Other Worlds than Ours*; Tyndall's *Heat as a Mode of Motion*, &c. Versions were also made of Cotta's *Geologie der Gegenwart* and Helmholtz's *Populäre Vorlesungen*. As important original monographs we note—*As drápdy a Fiumei öbölben* (Ebb and Flow in the Gulf of Fiume), by Emil Stahlberger (1874); *Magyarország pókfajánlása* (The Arachnida of Hungary), by Ottó Hermann (1876-1878); *Magyarország vaszkövi és vasterményei* (The Iron Ores and

Iron Products of Hungary), by Anthony Kerpely (1877); *Magyarország nevezetesebb dohányfajainak chemiai megvizsgálása* (Chemical Examination of the most famous Tobaccos of Hungary), by Dr Thomas Kosutány (1877). (E. D. Bu.)

The number of Magyar writers has since 1880 increased to an extent hardly expected by the reading public in Hungary itself. In 1830 there were only 10 Magyar periodical publications; in 1880 we find 368; in 1885 their number rose to 494; in 1890 to 636; and at the beginning of 1895 no fewer than 806 periodical publications, written in the Hungarian language, appeared in Hungary. Since that time (1895) the number of periodicals as well as of non-periodical literary works has been constantly rising, although, as in all countries with a literature of rather recent origin, the periodical publications are, in proportion to the whole of the output, far more numerous than the non-periodical.² This remarkable increase in the quantity of literary work was, on the whole, accompanied by a fair advance in literary quality.

In lyrical poetry, among the poets who first came to the fore in the 'sixties several were active after 1880, such as Joseph Komócsy (d. 1894), whose *Szerlem Könyve* ("Book of Love") has become a popular classic; Victor Dalmady, who published in the nineties his *Hazafias Költemények* (Patriotic Poems); and Ladislaus Arany, son of the great John. Among the prominent lyrists whose works, although partly published before 1880, belong largely to the later period, the following deserve special mention: The poetry of Emil Ábrányi (born 1850) is filled with the ideas and ideals of Victor Hugo. Ábrányi excels also as a translator, more particularly of Byron. Julius Reviczky (1855-1899) also inclined to the Occidental rather than to the specifically Magyar type of poets; his lyrics are highly finished, aristocratic and pessimistic (*Pán halál*, "The Death of Pan"). Count Géza Zichy (b. 1849) published his lyrical poems in 1892. Joseph Kiss (b. 1843) is especially felicitous in ballads taken from village and Jewish life, and in love-songs; Alexander Endrödi (b. 1850), one of the most gifted modern lyrical poets of Hungary, has the charm of tenderness and delicacy together with that of a peculiar and original style, his *Kurucz útidő* being so far his most successful attempt at romantic lyrics. Louis Bartók (b. 1851) is a remarkable satirist and epigrammatist (*Kárpáti emlékek*). Odón Jakab (b. 1850) leans towards the poetic manner of Tompa, with perhaps a greater power of expression than the author of the *Virágregék* ("Flower-fables"); Jakab wrote *Hangok az ifjúságból* ("Sounds of Youth"), *Nyár* ("Summer"), both collections of lyrical poems. Louis Pósa (b. 1850) has made a sphere of his own in his charming poems for and about children, *Édes anyám* ("My dear Mother"). In Andor Kozma (b. 1860), author of *A tegnapi és a ma* ("Yesterday and To-day," 1889), *Versek* (Poems, 1893), &c., there is undoubted power of genuine satire and deep humour. Michael Szabolcska (b. 1864), author of *Hangulatok* ("Moods," 1894), showed great promise; Julius Vargha (b. 1853) cultivates the *népies* or folk-poetry as represented by Hungary's two greatest poets, Petöfi and Arany; Vargha has also published excellent translations of Schiller and Goethe. Perhaps scarcely less remarkable are the modern Magyar lyrists, such as, of the older set, John Bulla (b. 1843), J. D. Temérdek, Gustavus Csengery (b. 1842), Paul Korödi (b. 1854), E. Julius Kovács (b. 1859), *Poems*, 1892), Ladislaus Inezsdi, Julius Négrádi; Pap, Julius Szávay (b. 1860), John Dengi (b. 1853); among the juniors, Anton Radó (also an excellent translator), Louis Palágyi (*Magányos éjlen*, "On Lonely Way," &c.), Géza Gárdonyi (b. 1863), *Aprilis*, 1894), Zoltán Pap, Eugen Heltai (*Ignatius*), Julius Rudnyánszky (b. 1860, *Szerlem*, "Love"; *Nyár*, "Summer"), Árpád Zemplényi, Julius Szentesy, Emil Makai (b. 1870), Cornelius Gáspár, Julius Várányi (b. 1863, *Mulandóság*, "The Unstability of Things"), Alexander Luby (*Vergődés*, "Striving"), Eugen V. Szászvárosi, Endre Szabó (b. 1849), political satirist. In the most recent lyrics of Hungary there is a growing tendency to socialist poetry, to the "poetry of misery" (*A nyomor költsége*). In epic poetry Josef Kiss's *Jehova* is the most popular work. Amongst rhymed novels—novels in verse form—the best is the *Déliárok hőse* ("The Hero of Mirages"), in which Ladislaus Arany tells, in brilliantly humorous and captivating fashion, the story of a young Magyar nobleman who, at first full of great ideals and aspirations, finally ends as a commonplace country squire.

Among Hungarian novels we may distinguish four dominant genres or tendencies. The first is represented almost exclusively by Maurus Jókai (*q.v.*). To the school so perfectly represented by

¹ This will appear even more striking by a consideration of the number of periodical publications published in Hungary in languages other than Magyar. Thus, while of German periodicals appearing in Hungary there were in 1871 only 85, they increased in 1880 to 114, in 1885 to 141; and they were, at the beginning of 1895, still 128, in spite of the constant spread of that process of Magyarization which has, since 1880, considerably changed the linguistic habits of the people of Hungary.

² The translator of Macaulay.

³ See, however, J. Szinyei and Son's *Bibliotheca Hungarica historiae naturalis et matheosae, 1472-1875* (Budapest, 1878), where the number of Magyar works bearing on the natural sciences and mathematics printed from the earliest date to the end of 1875 is stated to be 3811, of which 106 are referred to periodicals.

Jókai belong Árpád Kupa (*A napszámotok*, "The Labourers"; *Képselt királyok*, "Imaginary Kings"); Robert Tabory (*Nagy játéka*, "Great Game"; *A negyvenéves férfiu*, "The Man at Forty"); and Julius Werner (*Kendi Imre házassága*, "The Wedding of Emericus Kendi"; *Ólga*, *Megvadászt meg valóra*, "Dawn will come in the End"). The second class of Hungarian modern novelists is led by the well-known Koloman Mikszáth, a poet endowed with originality, a charming novelist, and a freshness of observation from life. A close observer of the multifarious low life of Hungary, Mikszáth has in his short stories, given a delightful yet instructive picture of all the minor varied phases of the peasant life of the Slavs, the *Poláczok*, the Saxons, the town artisan. Amongst his numerous works may be mentioned *A jó poláczok* ("The Good Poláczok"; Slav peasants); *Egy választás Magyarországon* ("An Election in Hungary"); *Pipacok a búzában* ("The Wild Poppies in the Wheatfield"); *A lekinletes vármegye* ("The Worshipful County"); *Ne okoshodj Pista* ("Don't reason, Pista"); *Szent Péter esernyője* ("St Peter's Umbrella," translated from the original into English by Miss B. W. Worswick), &c. Mikszáth has had considerable influence upon other writers. Such are Victor Rákosi (*Sípulós történi*, "The Essays of Sípulós"; *Rejtelt fészkek*, "Hidden Nests"); Stephen Móra (*Atyánkfiai*, "Our Compatriots"); Alexius Benedek, the author of numerous distinctly sympathetic and truly Magyar tales, fables and novels, one of the most gifted and deserving literary workers of modern Hungary (*Husár Anna*, "Anna Huszar"; *Egy szalmaövény levelei*, "Letters of a grass widow"; *A zszó könyve*, "The Book of the Heart"; *Katalin*, "Catherine"; *Csendes órák*, "Quiet Hours"; *Testamentum és hat level*, "Last Will and Six Letters," translated into German by Dr. W. Schönwald, &c.); Géza Gárdonyi (several novels containing the adventures, observations, &c., of Mr Gabriel Göre; *A békemű Davidkiné*, "Blue-eyed Mrs Davidka"; *A Kálos*, scenes from gipsy life); Charles Murai (*Vig történetek*, "Jolly Stories"; *Bárdi*, a collection of short tales); Stephen Bárony (*Csend*, "Silence"; *A Kaméleon-leány*, "The Chameleon Girl, and other Stories"; *Erdőn-mészán*, "In Wood and Field"). The third class of Magyar novelists comprises those cosmopolitan writers who take their method of work, their inspiration and even many of their subjects from foreign authors, chiefly French, German, Russian and also Norwegian. A people with an intense national sentiment, such as the Hungarians, do not as a rule incline towards permanent admiration of foreign-born or imported literary styles; and accordingly the work of this class of novelists has frequently met with very severe criticism on the part of various Magyar critics. Yet it can scarcely be denied that several of the "foreign" novelists have contributed a wholesome, if not quite Magyar, element of form or thought to literary narrative style in Hungary. Probably the foremost among them is Sigismund Justh, who died prematurely in the midst of his painful attempt at reconciling French "realistic" modes of thought with what he conceived to be Magyar simplicity (*A pászta könyve*, "The Book of the Pászta," patrie of Hungary; *A Pénz legendája*, "The Legend of Money"; *Gönyv Juleica*, Juliet Gányó"; *Fuimus*). Other novelists belonging to this school are: Desiderius Malonyai (*Az utolsó*, "The Last"; *Judith könyve*, "The Book of Judith"; *Tanulmányfejek*, "Typical Heads"); Julius Pekár (*Dodo főhadnagy problémái*, "Lieutenant Dodo's Problems"; *Áz aranykesztyűs kisasszony*, "The Maid with the Golden Gloves"; *A szoborleplez asszony*, "The Lady as Beautiful as a Statue"; *Az estendő legendája*, "The Legend of the Year"; Thomas Kobor (*Aszfalt*, "Asphalt"; *Ó akarta*, "He Wanted It"; *A csillagok felé*, "Towards the Stars"); Stephen Szomaházy (*Huszonnyé óra*, "Twenty-four Hours"; *A Clairette Keringő*, "The Clairette Valse"; *Páratlan szerdák*, "Incomparable Wednesdays"; *Nyári felhők*, "Clouds of Summer"); Zoltán Thury (*Ulrich főhadnagy és egyéb történetek*, "Lieutenant Ulrich and other Tales"; *Órák és parasztok*, "Gentlemen and Peasants"); also Desiderius Szomory, Odón Gerő, Árpád Ahonyi, Koloman Szántó, Edward Sas, Julius Vértesi, Tibor Dénes, Akos Pintér, the Misses Janka and Stéphanie Wohl, Mrs Sigismund Gyarmathy and others. In the fourth class may be grouped such of the latest Hungarian novelists as have tried, and on the whole succeeded, in clothing their ideas and characters in a style peculiar to themselves. Besides Stephen Petelei (*Jelti*, a name—Henrietta; *Felhők*, "Clouds") and Zoltán Ambrus (*Pókhaló kisasszony*, "Miss Cobweb"; *Gyana*, "Suspicion") must be mentioned especially Francis Herczeg, who has published a number of very interesting studies of Hungarian social life (*Simon Zsuzsa*, "Susanna Simon"; *Fenn és lejjebb*, "Above and Below"; *Egy leány története*, "The History of a Girl"; *Járgenek kőszőlő*, "Amongst Strangers"); Alexander Bródy, who brings a delicate yet resolute analysis to unfold the mysterious and fascinating inner life of persons suffering from overwrought nerves or overstrung mind (*A kettélke asszony*, "The Double-Souled Lady"; *Don Quixote kisasszony*, "Miss Don Quixote"; *Faust orvos*, "Faust the Physician"; *Tündér Ilona*, *Rejtelmek*, "Mysteries"; *Az ezüst kecske*, "The Silver Goat"); and Edward Kabos, whose sombre and powerful genius has already produced works, not popular by any means, but full of great promise. In him we may trace the influence of Nietzsche's philosophy (*Koldusok*, "Beggars"; *Vándorok*, "Wanderers"). To this list we must add the short but incomparable *feuilletons* (*újságcikkek*) of Dr Adolf Agai (writing under the nom de plume of Porzó), whose influence on the formation of modern

Hungarian literary prose is hardly less important than the *esprit* and charm of his writings.

Dramatic literature, liberally supported by the king and government, and aided by magnificent theatres in the capital and also in the provinces (the finest provincial theatre is in Kolozsvár in Transylvania), has developed remarkably. The Hungarians in the genuine dramatic gift in abundance; they have, moreover, actors and actresses of the first rank. In the modern drama three great and clearly differentiated groups may be distinguished. First, the romantic group, whose chief representatives are Eugen Rákóczi, Louis Dóczy (b. 1845), who, in addition to *Csók* ("The Kiss"), has written *Utolsó szerelm* ("Last Love"), *Sáchy Mária* ("Mrs Sáchy"), *Vegyes Párok* ("Mixed Couples"). In these and other dramatic writings, Dóczy still maintains his brilliancy of diction and the delicacy of his poetic touch. To the same school belong Louis Baróczy, Ányos Váradi and Alexander Somló. The next group of Hungarian dramatists is dominated by the master spirit of Gregor Csiky (1845). Among Csiky's most promising disciples is Francis Herczeg (already mentioned as a novelist), author of the successful society comedy *A Gyurkovics leányok* ("The Misses Gyurkovics"), *Három leány* ("Three Guardsmen"), *Honny ház* ("The House of Honny"), Árpád Berczik's *Nézd meg az anyját* ("Look at her Mother"), *prolekció* ("Patronizing"), also followed on the lines of Csiky. The third group of dramatic writers take their subjects, surroundings and diction from the folk-life of the villages (*Népszínház*, "Folk drama"). The greatest of these dramatists has so far been Edward Tóth (*Tolona*, "The Ousted Pauper"). Amongst his numerous followers, who have, however, sometimes vulgarized their legends and plots, may be mentioned Tibamér Almási (*Műlimeri*, *A Műszerezők bálja*, "The Ball of the Premier") and Alexander Somló.

In philosophy there has been a remarkable increase of activity, partly assimilative or eclectic and partly original. Péter Bibányi and Maurice Kármán have in various writings spread the ideas of Herbart. After the school of Comte, yet to a large extent original, is the *ember és világa* ("Man and his World") of Charles Boehm, who in 1881 started a philosophical review (*Magyar Filozófiai Szemle*, subsequently edited by Joseph Bokor, a vigorous thinker. Realism, more particularly of the Wundt type, is represented by Emerich Pauer, *Az etikai determinizmus* ("Ethical Determinism"), and Eugen Posch (*Az időről*, "On Time"). On a Thomistic basis János Kiss edits a philosophical review (*Bölcséleti Folyóirat*); on similar lines have been working Akos Mihályfi, Répássy, Augustin Lubich and others. Neo-Hegelianism is cultivated by Eugen Schön, efficiently assisted by Joseph Alexander Simon (*Az egység és voláris természet filozófia alapelvei*, "Outlines of a Uniform and Realistic Philosophy of Nature"). F. Medveczky (formerly a German author under the name of Fr. von Bärenbach) espouses Neo-Kantian (*Társadalmi elmélet és eszmények*, 1887, "Social Theories and Ideals"). The Hungarian scholar Samuel Brassai published, in 1898, *Az igaz pozitív filozófia* ("The True Positive Philosophy"). Amongst the ablest and most zealous students of the history of philosophy are Bernhard Alexander, under whose editorship, aided by Joseph Bánoczi, a series of the works of the world's great thinkers has appeared; Andrew Domanovszky, author of an elaborate History of Philosophy; Julius Gyomai, translator of Plato; Eugen Herber, likewise translator of philosophical works, &c.

Juristic literature has been stimulated by the activity in positive legislation. On 1st January 1900 a new criminal code, thoroughly modern in spirit, was put in force; and in 1901 a Civil Code Bill, to replace the old Hungarian customary system, was introduced. Among the newer writers on common and commercial law may be mentioned Wenzsl, Zlinsky, Zogod, Gustave Schwarz, Alexander Plósz, Francis Nagy and Neumann, on constitutional law, Kerehely, Bonca, Stephen Kiss, Ernest Nagy, Kmetz, Arthur Balogh, Ferdinandy, Béla Grünwald, Julius Andrásey and Emeric Hajnik; on administration, George Féatus, Kmetz and Csiky; on finance, Mariska, Esner and László. Among the later writers on statistics, moreover, have been Konek, Keleti, Láng, Földes, Jekelfalussy, Vörgha, Körösy, Ráth and Vizkányi.

On subjects of politics, amongst the more important works are the various monographs of Gustavus Bekics on the Dualism of Austria-Hungary, on the "New Foundations of Magyar Politics" (*A magyar politika új alapjai*, 1899), on the Rumanian question, &c.; the writings of Emericus Balint, Akos Boóthy, Victor Concha (systematic politics), L. Esery, Géza Ferdinandy (historical and systematic politics), Árpád Zsigány, Béla Földes (political economy), Julius Mandelö (political economy), Alexander Matkovics (Hungary's administrative service; *Államháztartás*, 3 vols.), J. Pólya (applied politics), M. Somogyi (sociology), and the late Augustus Poláky.

In history there has been great activity. The millennial festivities in 1896 gave rise to the publication of what was then the most extensive history of the Hungarian nation (*A magyar nemzet története*, 1895-1901), ten large and splendidly illustrated volumes edited by Alexander Szilágyi, with the collaboration of the best specialists of modern Hungary, Robert Frölich, B. Kusnifer, Géza Nagy, H. Marczali, Antón Por, Schönherr, V. Fraukó, Árpád Károlyi, David Angyal, Coloman Thaly, Géza Ballagi.

Literary criticism is actively pursued. Among the more authoritative writers Paul Gyulai and Zoltán Beöthy represent the

conservative school; younger critics, like Béla Lázár, Alexander Hevesi, H. Lenkei, Zoltán Ferenczy, Aladár Ballagi, Ladislas Nögyesy, have shown themselves somewhat too ready to follow the latest Norwegian or Parisian sensation.

AUTHORITIES.—The best authorities on Magyar literature are: F. Toldy, *A Magyar nemzeti irodalom története a legrégibb időkől a jelenkorig* (Pest, 1864-1865; 3rd ed., 1872); S. Imre, *A Magyar irodalom és nyelvi története* (Debreczen, 1865; 4th ed., 1878); J. Szörvényi, *Magyar irodalmi szemelvények* (Pest, 1867); and *A Magyar irodalmi tanulmányok kézikönyve* (Pest, 1868); P. Jámbor, *A Magyar irodalom története* (Pest, 1864); J. Környei, *A Magyar nemzeti irodalomtörténet vázlata* (Pest, 1861; 3rd ed., 1874); A. Lonkay, *A Magyar irodalom ismeretése* (Budán, 1855; 3rd ed., Pest, 1864); J. Ferencz, *Magyar irodalom és tudományosság története* (Pest, 1854); J. Ferencz és J. Daniélik, *Magyar Irók. Életrajz-Gyűjtemény* (2 vols., Pest, 1856-1858); and the literary histories of L. Névy, Z. Boöthy and B. Erdödi. One of the most useful monographs on "Magyar Literary History Writing" is that of J. Szinyei, junior, *A Magyar Irodalomtörténet-Írás ismeretése* (Budapest, 1878). For information as to the most recent literature see A. Dux, *Aus Ungarn* (Leipzig, 1886); Zolt. Boöthy, *A Magyar nemz. irod. tört.*; S. Bodnár, *A magy. irod. tört.*; Béla Lázár, *A legnap, a ma, és a holnap* (Budapest, 1896-1900); Joseph Szinyei, *Magy. irók élete és munkái* (an extensive biographical dictionary of Hungarian authors); *Irodalom történeti Közlemények* (a periodical edited by Aron Szilády, for the history of literature); Emil Reich, *Hungarian Literature* (London, 1898). (E. R.)

HUNGER and THIRST. These terms are used to express peculiar sensations which are produced by and give expression to general wants of the system, satisfied respectively by the ingestion of organic solids containing substances capable of acting as food, and by water or liquids and solids containing water.

Hunger (a word common to Teutonic languages) is a peculiarly indefinite sensation of craving or want which is referred to the stomach, but with which is often combined, always indeed in its most pronounced stages, a general feeling of weakness or faintness. The earliest stages are unattended with suffering, and are characterized as "appetite for food." Hunger is normally appeased by the introduction of solid or semi-solid nutriment into the stomach, and it is probable that the almost immediate alleviation of the sensation in these circumstances is in part due to a local influence, perhaps connected with a free secretion of gastric juice. Essentially, however, the sensation of hunger is a mere local expression of a general want, and this local expression ceases when the want is satisfied, even though no food be introduced into the stomach, the needs of the economy being satisfied by the introduction of food through other channels, as, for example, when food which admits of being readily absorbed is injected into the large intestine.

Thirst (a word of Teutonic origin, Ger. *Durst*, Swed. and Dan. *tirst*, akin to the Lat. *lorrere*, to parch) is a peculiar sensation of dryness and heat localized in the tongue and throat. Although thirst may be artificially produced by drying, as by the passage of a current of air over the mucous membrane of the above parts, normally it depends upon an impoverishment of the system in water. And, when this impoverishment ceases, in whichever way this be effected, the sensation likewise ceases. The injection of water into the blood, the stomach, or the large intestine appeases thirst, though no fluid is brought in contact with the part to which the sensation is referred.

The sensations of hunger and thirst lead us, or when urgent compel us, to take food and drink into the mouth. Once in the mouth, the entrance to the alimentary canal, the food begins to undergo a series of processes, the object of which is to extract from it as much as possible of its nutritive constituents. Food in the alimentary canal is, strictly speaking, outside the confines of the body; as much so as the fly grasped in the leaves of the insectivorous *Dionea* is outside of the plant itself. The mechanical and chemical processes to which the food is subjected have their seat and conditions outside the body which it is destined to nourish, though unquestionably the body is no passive agent, and innumerable glands come into action to supply the chemical agents which dissolve and render assimilable those constituents of the food capable of being absorbed into the organism, and of forming part and parcel of its substance (see further under **NUTRITION**).

HUNGERFORD, WALTER HUNGERFORD, BARON (d. 1449), English soldier, belonged to a Wiltshire family. His father, Sir Thomas Hungerford (d. 1398), was speaker of the House of Commons in 1377, a position which he owed to his friend John of Gaunt, and is the first person formally mentioned in the rolls of parliament as holding the office. Walter Hungerford also served as speaker, but he is more celebrated as a warrior and diplomatist, serving in the former capacity at Agincourt and in the latter at the council of Constance and the congress of Arras. An executor of Henry V.'s will and a member of the council under Henry VI., Hungerford became a baron in 1426, and he was lord treasurer from 1426 to 1431. Remains of his benefactions still exist at Heytesbury, long the principal residence of the family.

Hungerford's son Robert (c. 1400-1459) was also called to parliament as a baron; he was very wealthy, both his mother and his wife being heiresses. Like several other members of the family, Robert was buried in the cathedral at Salisbury.

Robert's son and heir, Robert, Lord Moleyns and Hungerford (c. 1420-1464), married Eleanor, daughter of Sir William de Moleyns, and was called to parliament as Lord de Moleyns in 1445. He is chiefly remembered through his dispute with John Paston over the possession of the Norfolk manor of Gresham. After losing this case he was taken prisoner in France in 1452, not securing his release until 1459. During the Wars of the Roses he fought for Henry VI., with whom he fled to Scotland; then he was attainted, was taken prisoner at the battle of Hexham, and was executed at Newcastle in May 1464.

His eldest son, Sir Thomas Hungerford (d. 1469), was attainted and executed for attempting the restoration of Henry VI.; a younger son, Sir Walter Hungerford (d. 1516), who fought for Henry VII. at Bosworth, received some of the estates forfeited by his ancestors. Sir Thomas, who had no sons, left an only daughter Mary (d. c. 1534). When the attainders of her father and grandfather were reversed in 1485 this lady became Baroness Hungerford and Baroness de Moleyns; she married into the Hastings family and was the mother of George Hastings, 1st earl of Huntingdon.

Sir Walter Hungerford's son Edward (d. 1522) was the father of Walter, Lord Hungerford of Heytesbury (1503-1540), who was created a baron in 1536, but was attainted for his alleged sympathy with the Pilgrimage of Grace; he was beheaded on the 28th of July 1540, the same day as his patron Thomas Cromwell. As his sons Sir Walter (1532-1596) and Sir Edward (d. 1607) both died without sons the estates passed to another branch of the family.

Sir Edward Hungerford (1506-1648), who inherited the estates of his kinsman Sir Edward in 1607, was the son of Sir Anthony (1564-1627) and a descendant of Walter, Lord Hungerford. He was a member of both the Short and Long Parliaments in 1640; during the Civil War he attached himself to the parliamentary party, fighting at Lansdowne and at Roundway Down. His half-brother Anthony (d. 1657) was also a member of both the Short and the Long Parliaments, but was on the royalist side during the war. This Anthony's son and heir was Sir Edward Hungerford (1632-1711), the founder of Hungerford market at Charing Cross, London. He was a member of parliament for over forty years, but was very extravagant and was obliged to sell much of his property; and little is known of the family after his death.

See Sir R. C. Hoare, *History of Modern Wiltshire* (1822-1844).

HUNGERFORD, a market town in the Newbury parliamentary division of Berkshire, England, extending into Wiltshire, 61 m. W. by S. of London by the Great Western railway. Pop. (1901) 2906. It is beautifully situated in the narrow valley of the Kennet at the junction of tributary valleys from the south and south-west, the second of which is followed by the Bath road, an important highway from London to the west. The town, which lies on the Kennet and Avon canal, has agricultural trade. John of Gaunt, duke of Lancaster, presented to the citizens manorial rights, including common pasture and fishing. The fishing is valuable, for the trout of the Kennet and other streams

in the locality are numerous and carefully preserved. Hungerford is also a favourite hunting centre. A horn given to the town by John of Gaunt is preserved in the town hall, another horn dating from 1634 being used to summon the manorial court of twelve citizens called *feoffees* (the president being called the constable), at Hocktide, the Tuesday following Easter week. In 1774, when a number of towns had taken action against the imposition of a fee for the delivery of letters from their local post-offices, Hungerford was selected as a typical case, and was first relieved of the imposition.

HÜNINGEN, a town of Germany, in Alsace-Lorraine, situated on the left bank of the Rhine, on a branch of the Rhine-Rhone canal, and 3 m. N. of Basel by rail. Pop. (1905) 3304. The Rhine is here crossed by an iron railway bridge. The town boasts a handsome Roman Catholic church, and has manufactures of silk, watches, chemicals and cigars. Hüningen is an ancient place and grew up round a stronghold placed to guard the passage of the Rhine. It was wrested from the Imperialists by the duke of Lauenburg in 1634, and subsequently passed by purchase to Louis XIV. of France. It was fortified by Vauban (1679-1681) and a bridge was built across the Rhine. The fortress capitulated to the Austrians on the 26th of August 1815 and the works were shortly afterwards dismantled. In 1871, the town passed, with Alsace-Lorraine, to the German empire.

See Tachamber, *Geschichte der Stadt und ehemaligen Festung Hüningen* (St Ludwig, 1894); and Latruffe, *Huningue et Bâle devant les traités de 1815* (Paris, 1863).

HUNNERIC (d. 484), king of the Vandals, was a son of King Gaiseric, and was sent to Italy as a hostage in 435 when his father made a treaty with the emperor Valentinian III. After his return to the Vandal court at Carthage, he married a daughter of Theodoric I., king of the Visigoths; but when this princess was suspected of attempting to poison her father-in-law, she was mutilated and was sent back to Europe. Hunneric became king of the Vandals on his father's death in 477. Like Gaiseric he was an Arian, and his reign is chiefly memorable for his cruel persecution of members of the orthodox Christian Church in his dominions. Hunneric's second wife was Eudocia, a daughter of Valentinian III. and his wife Eudocia. (See VANDALS.)

HUNNIS, WILLIAM (d. 1597), English musician and poet, was as early as 1549 in the service of William Herbert, afterwards earl of Pembroke. His friend Thomas Newton, in a poem prefixed to *The Hite of Hunnye* (1578), says: "In prime of youth thy pleasant Penne depainted Sonets sweete," and mentions his interludes, gallant lays, rondelets and songs, explaining that it was in the winter of his age that he turned to sacred lore and high philosophy. In 1550 he published *Certaine Psalms . . . in English metre*, and shortly afterwards was made a gentleman of the Chapel Royal. At Mary's accession he retained his appointment, but in 1555 he is said to have been one of a party of twelve conspirators who had determined to take Mary's life. Nothing came of this plot, but shortly afterwards he was party to a conspiracy to dethrone Mary in favour of Elizabeth. Hunnis, having some knowledge of alchemy, was to go abroad to coin the necessary gold, but this doubtful mission was exchanged for the task of making false keys to the treasury in London, which he was able to do because of his friendship with Nicholas Brigham, the receiver of the exchequer. The conspirators were, however, betrayed by one of their number, Thomas Whyte. Some of them were executed, but Hunnis escaped with imprisonment. The death of Mary made him a free man, and in 1559 he married Margaret, Brigham's widow, but she died within the year, and Hunnis married in 1560 the widow of a grocer. He himself became a grocer and freeman of the City of London, and supervisor of the Queen's Gardens at Greenwich. In 1566 he was made Master of the Children of the Chapel Royal. No complete piece of his is extant, perhaps because of the rule that the plays acted by the Children should not have been previously printed. In his later years he purchased land at Barking, Essex. If the lines above his signature on a 1557 edition of Sir Thomas More's works are genuine, he remained a poor man, for he refuses to make a will on the ground that "the good that I shall leave, will not

pay all I owe." In Harleian MS. 6403 is a story that one of his sons, in the capacity of page, drank the remainder of the poisoned cup supposed to have been provided by Leicester for Walter Devereux, 1st earl of Essex, but escaped with no injury beyond the loss of his hair.

Hunnis's extant works include *Certaine Psalms* (1549). *A Hite full of Hunnye* (1578). *Seven Sabbes of a sorrowful Soule for Sinne* (1583). *Hunnies Recreations* (1588), sixteen poems in the *Paradise of Dainty Devices* (1576), and two in *England's Helicon* (1600). See Mrs C. Carmichael Stopes's tract on William Hunnis, reprinted (1892) from the *Jahrbuch der deutschen Shakespeare Gesellschaft*.

HUNS. This or some similar name is given to at least four peoples, whose identity cannot be regarded as certain. (1) The Huns, who invaded the East Roman empire from about A.D. 373 to 453 and were most formidable under the leadership of Attila. (2) The Hungarians or Magyars. The Magyars crossed the Carpathians into Hungary in A.D. 898 and mingled with the races they found there. The modern Hungarians (excluding Slavonic elements) are probably a mixture of these Magyars with the remnants of older invaders such as Huns, Petchenegs and Kumans. (3) The White Huns (*Λευκοὶ Ὀφθαλίται* or Ephthalites), who troubled the Persian empire from about 420 to 557 and were known to the Byzantines. (4) The Hūnas, who invaded India during the same period. There is not much doubt that the third and fourth of these tribes are the same, and it is quite likely that the Magyars are descended from the horde which sent forth the Huns in the 4th century, but it is not demonstrable. Neither can it be proved that the Huns and Magyars belonged either physically or linguistically to the same section as the Hūnas and Ephthalites. But the occurrence of the name in both India and Europe is *prima facie* evidence in favour of a connexion between those who bore it, for, though civilized races often lumped all their barbarian neighbours together under one general name, it would seem that, when the same name is applied independently to similar invaders in both India and eastern Europe, the only explanation can be that they gave themselves that name, and this fact probably indicates that they were members of the same tribe or group. What we know of the history and distribution of the Huns does not conflict with this idea. They appear in Europe towards the end of the 4th century and the Ephthalites and Hūnas in western Asia about fifty years later. It may be supposed that some defeat in China (and the Chinese were successful in driving back the Hiung-nu in the 1st century A.D.) had sent them westwards some time earlier. One body remained in Transoxiana and, after resting for a time, pushed their way through the mountains into Afghanistan and India, exactly as the Yüe-Chi had done before them. Another division pressed farther westwards and probably made its headquarters near the northern end of the Caspian Sea and the southern part of the Ural Mountains. It was from here that the Huns invaded Europe, and when their power collapsed, after the death of Attila, many of them may have returned to their original haunts. Possibly the Bulgarians and Khazars were offshoots of the same horde. The Magyars may very well have gradually spread first to the Don and then beyond it, until in the 9th century they entered Hungary. But this sketch of possible migrations is largely conjectural, and authorities are not even agreed as to the branch of the Turanians to which the Huns should be referred. The physical characteristics of these nomadic armies were very variable, since they continually increased their numbers by slaves, women and soldiers of fortune drawn from all the surrounding races. The language of the Magyars is Finno-Ugric and most nearly allied to the speech of the Ostiaks now found on the east of the Ural, but we have no warrant for assuming that the Huns, and still less that the Ephthalites and Hūnas, spoke the same language. Neither can we assume that the Huns and Hūnas are the same as the Hiung-nu of the Chinese. The names may be identical, but it is not certain, for in Hun may lurk some such designation as the ten (Turkish *on* or *äw*) tribes. Also Hiung-nu seems to be the name of warlike nomads in general, not of a particular section. Again the Finnish languages spoken in various parts of Russia and more or less allied to Magyar must have spread gradually westwards from the Urals, and their

development and diffusion seem to postulate a long period (for the history of the Finns shows that they were not mobile like the Turks and Mongols), so that the ancestral language from which spring Finnish and Magyar can hardly have been brought across Asia after the Christian era. The warlike and vigorous temper of the Huns has led many writers to regard them as Turks. The Turks were perhaps not distinguished by name or institutions from other tribes before the 5th century, but the Huns may have been an earlier offshoot of the same stock. Apart from this the Hungarians may have received an infusion of Turkish blood not only from the Osmanlis but from the Kumans and other tribes who settled in the country.

History.—The authentic history of the Huns in Europe practically begins about the year A.D. 372, when under a leader named Balamir (or, according to some MSS., Balamber) they began a westward movement from their settlements in the steppes lying to the north of the Caspian. After crushing, or compelling the alliance of, various nations unknown to fame (Alpizuri, Alcizuri, Himari, Tuncarsi, Boisci), they at length reached the Alani, a powerful nation which had its seat between the Volga and the Don; these also, after a struggle, they defeated and finally enlisted in their service. They then proceeded, in 374, to invade the empire of the Ostrogoths (Greutungii), ruled over by the aged Ermanaric, or Hermanric, who died (perhaps by his own hand) while the critical attack was still impending. Under his son Huaimund a section of his subjects promptly made a humiliating peace; under Withemir (Winitar), however, who succeeded him in the larger part of his dominions, an armed resistance was organized; but it resulted only in repeated defeat, and finally in the death of the king. The representatives of his son Witheric put an end to the conflict by accepting the condition of vassalage. Balamir now directed his victorious arms still farther westward against that portion of the Visigothic nation (or Tervingii) which acknowledged the authority of Athanaric. The latter entrenched himself on the frontier which had separated him from the Ostrogoths, behind the "Greutung-rampart" and the Dniester; but he was surprised by the enemy, who forded the river in the night, fell suddenly upon his camp, and compelled him to abandon his position. Athanaric next attempted to establish himself in the territory between the Pruth and the Danube, and with this object set about heightening the old Roman wall which Trajan had erected in north-eastern Dacia; before his fortifications, however, were complete, the Huns were again upon him, and without a battle he was forced to retreat to the Danube. The remainder of the Visigoths, under Alavivus and Frigiter, now began to seek, and ultimately were successful in obtaining (376), the permission of the emperor Valens to settle in Thrace; Athanaric meanwhile took refuge in Transylvania, thus abandoning the field without any serious struggle to the irresistible Huns. For more than fifty years the Roman world was undisturbed by any aggressive act on the part of the new invaders, who contented themselves with overpowering various tribes which lived to the north of the Danube. In some instances, in fact, the Huns lent their aid to the Romans against third parties; thus in 404-405 certain Hunnic tribes, under a chief or king named Uldin, assisted Honorius in the struggle with Radagaisus (Ratigar) and his Ostrogoths, and took a prominent part in the decisive battle fought in the neighbourhood of Florence. Once indeed, in 400, they are said to have crossed the Danube and invaded Bulgaria under perhaps the same chief (Uldin), but extensive desertions soon compelled a retreat.

About the year 432 a Hunnic king, Ruas or Rugulus, made himself of such importance that he received from Theodosius II. an annual stipend or tribute of 350 pounds of gold (£14,000), along with the rank of Roman general. Quarrels soon arose, partly out of the circumstance that the Romans had sought to make alliances with certain Danubian tribes which Ruas chose to regard as properly subject to himself, partly also because some of the undoubted subjects of the Hun had found refuge on Roman territory; and Theodosius, in reply to an indignant and insulting message which he had received about this cause

of dispute, was preparing to send off a special embassy when tidings arrived that Ruas was dead and that he had been succeeded in his kingdom by Attila and Bleda, the two sons of his brother Mundzuk (433). Shortly afterwards the treaty of Margus (not far from the modern Belgrade), where both sides negotiated on horseback, was ratified. By its stipulations the yearly stipendium or tribute payable to Attila by the Romans was doubled; the fugitives were to be surrendered, or a fine of £8 to be paid for each of those who should be missing; free markets, open to Hun and Roman alike, were to be instituted; and any tribe with which Attila might be at any time at war was thereby to be held as excluded from alliance with Rome. For eight years afterwards there was peace so far as the Romans were concerned; and it was probably during this period that the Huns proceeded to the extensive conquests to which the contemporary historian Priscus so vaguely alludes in the words: "He (Attila) has made the whole of Scythia his own, he has laid the Roman empire under tribute, and he thinks of renewing his attacks upon Persia. The road to that eastern kingdom is not untrodden by the Huns; already they have marched fifteen days from a certain lake, and have ravaged Media." They also appear before the end of this interval to have pushed westward as far as to the Rhone, and to have come into conflict with the Burgundians. Overt acts of hostility, however, occurred against the Eastern empire when the town of Margus (by the treachery of its bishop) was seized and sacked (441), and against the Western when Sirmium was invested and taken.

In 445 Bleda died, and two years afterwards Attila, now sole ruler, undertook one of his most important expeditions against the Eastern empire; on this occasion he pushed southwards as far as Thermopylae, Gallipoli and the walls of Constantinople; peace was cheaply purchased by tripling the yearly tribute (which accordingly now stood at 2100 pounds of gold, or £84,000 sterling) and by the payment of a heavy indemnity. In 448 again occurred various diplomatic negotiations, and especially the embassy of Maximinus, of which many curious details have been recorded by Priscus his companion. Then followed, in 451, that westward movement across the Rhine which was only arrested at last, with terrible slaughter, on the Catalaunian plains (according to common belief, in the neighbourhood of the modern Châlons, but more probably at a point some 50 m. to the south-east, near Mery-sur-Seine). The following year (452), that of the Italian campaign, was marked by such events as the sack of Aquileia, the destruction of the cities of Venetia, and finally, on the banks of the Mincio, that historical interview with Pope Leo I. which resulted in the return of Attila to Pannonia, where in 453 he died (see ATTILA). Almost immediately afterwards the empire he had amassed rather than consolidated fell to pieces. His too numerous sons began to quarrel about their inheritance, while Ardaric, the king of the Gepidae, was placing himself at the head of a general revolt of the dependent nations. The inevitable struggle came to a crisis near the river Netad in Pannonia, in a battle in which 30,000 of the Huns and their confederates, including Ellak, Attila's eldest son, were slain. The nation, thus broken, rapidly dispersed, exactly as the White Huns did after a similar defeat about a hundred years later. One horde settled under Roman protection in Little Scythia (the Dobrudzha), others in Dacia Ripensis (on the confines of Servia and Bulgaria) or on the southern borders of Pannonia. Many, however, appear to have returned to what is now South Russia, and may perhaps have taken part in the ethnical combinations which produced the Bulgarians.

The chief original authorities are Ammianus Marcellinus, Priscus, Jordanes, Procopius, Sidonius Apollinaris and Menander Protector. See also Gibbon, *Decline and Fall of the Roman Empire*; J. B. Bury, *History of the Later Roman Empire* (1889); H. H. Howorth, *History of the Mongols* (1876-1888); J. Hodgkin, *Italy and her Invaders* (1892); and articles in the *Revue orientale pour les études Oural-altaïques*. For the Chinese sources see E. H. Parker, *A Thousand Years of the Tartars* (1905), and numerous articles by the same author in the *Asiatic Quarterly*; also articles by Chavannes, O Franke, Stein and others in various learned periodicals. For the literature on the White Huns see EPHITALITES. (C. E. L.)

HUNSDON, HENRY CAREY, 1ST BARON (c. 1524-1596), English soldier and courtier, was a son of William Carey (d. 1529); his mother was Mary (d. 1543), a sister of Anne Boleyn, and he was consequently cousin to Queen Elizabeth. Member of parliament for Buckingham under Edward VI. and Mary, he was knighted in 1558, was created Baron Hunsdon in 1559, and in 1561 became a privy councillor and a knight of the Garter. In 1568 he became governor of Berwick and warden of the east Marches, and he was largely instrumental in quelling the rising in the north of England in 1569, gaining a decisive victory over Leonard Dacre near Carlisle in February 1570. Hunsdon received very little money to cover his expenses, but Elizabeth lavished honours upon him, although he did not always carry out her wishes. In 1583 he became lord chamberlain, but he did not relinquish his post at Berwick. Hunsdon was one of the commissioners appointed to try Mary queen of Scots; after Mary's execution he went on a mission to James VI. of Scotland, and when the Spanish Armada was expected he commanded the queen's bodyguard. He died in London, at Somerset House, on the 23rd of July 1596.

His eldest son, **GEORGE** (1547-1603), 2nd Baron Hunsdon, was a member of parliament, a diplomatist, a soldier and lord chamberlain. He was also captain-general of the Isle of Wight during the time of the Spanish Armada. He was succeeded by his brother John (d. 1617). In 1628 John's son Henry, 4th Baron Hunsdon, was created earl of Dover. This title became extinct on the death of the 2nd earl, John, in 1677, and a like fate befell the barony of Hunsdon on the death of the 8th baron, William Ferdinand, in June 1765. Elizabeth, daughter of Sir John Spencer of Althorp, and wife of the 2nd Lord Hunsdon, is celebrated as the patroness of her kinsman, the poet Spenser; and either this lady or her daughter Elizabeth was the author of the *Tragedie of Marian* (1613).

The 1st lord's youngest son, **ROBERT CAREY** (c. 1560-1639), was for a long time a member of the English parliament. He was frequently employed on the Scottish borders; he announced the death of Elizabeth to James VI. of Scotland; and he was created earl of Monmouth in 1626. He wrote some interesting *Memoirs*, first published in 1759. His son and successor, Henry (1596-1661), is known as a translator of various French and Italian books. The title of earl of Monmouth became extinct on his death in June 1661.

HUNSTANTON [commonly pronounced Hunston], a seaside resort in the north-western parliamentary division of Norfolk, England, on the east shore of the Wash, 112 m. N. by E. from London by the Great Eastern railway. Pop. of urban district of New Hunstanton (1901) 1893. The new watering-place is about 1 m. from the old village. It has a good beach, a golf course and a pier. The parish church of St Mary is a fine Decorated building, containing monuments of the L'Estrange family, whose mansion, Hunstanton Hall, is a picturesque Tudor building of brick in a well-wooded park. A convalescent home (1872) commemorates the recovery from illness of King Edward VII. when Prince of Wales. At Brancaster, 6 m. E., there is a Roman fort which formed part of the defences of the *Litus Saxonicum* (4th century A.D.).

HUNT, ALFRED WILLIAM (1830-1896), English painter, son of Andrew Hunt, a landscape painter, was born at Liverpool in 1830. He began to paint while at the Liverpool Collegiate School; but as the idea of adopting the artist's profession was not favoured by his father, he went in 1848 to Corpus Christi College, Oxford. His career there was distinguished; he won the Newdigate Prize in 1851, and became a Fellow of Corpus in 1858. He did not, however, abandon his artistic practice, for, encouraged by Ruskin, he exhibited at the Royal Academy in 1854, and thenceforward regularly contributed landscapes in oil and water-colour to the London and provincial exhibitions. In 1861 he married, gave up his Fellowship, and was elected an Associate of the Royal Society of Painters in Water-Colours, receiving full membership three years later. His work is distinguished mainly by its exquisite quality and a poetic rendering of atmosphere. Hunt died on 3rd May 1896. Mrs A. W. Hunt

(née Margaret Raine) wrote several works of fiction; and one of her daughters, Violet Hunt, is well known as a novelist.

See Frederick Wedmore, "Alfred Hunt," *Magazine of Art* (1891); *Exhibition of Drawings in Water Colour by Alfred William Hunt*, Burlington Fine Arts Club (1897).

HUNT, HENRY (1773-1835), English politician, commonly called "Orator Hunt," was born at Widdington Farm, Upavon, Wiltshire, on the 6th of November 1773. While following the vocation of a farmer he made the acquaintance of John Horne Tooke, with whose advanced views he soon began to sympathize. At the general election of 1806 he came to the front in Wiltshire; he soon associated himself with William Cobbett, and in 1811 he was an unsuccessful candidate for Bristol. He was one of the speakers at the meeting held in Spa Fields, London, in November 1816; in 1818 he tried in vain to become member of parliament for Westminster, and in 1820 for Preston. In August 1819 Hunt presided over the great meeting in St Peter's Field, Manchester, which developed into a riot and was called the "Peterloo massacre." He was arrested and was tried for conspiracy, being sentenced to imprisonment for two years and a half. In August 1830 he was elected member of parliament for Preston, but he lost his seat in 1833. While in parliament Hunt presented a petition in favour of women's rights, probably the first of this kind, and he moved for a repeal of the corn laws. He died on the 15th of February 1835. During his imprisonment Hunt wrote his *Memoirs* which were published in 1820.

See R. Huish, *Life of Hunt* (1836); and S. Bamford, *Passages in the Life of a Radical* (2nd ed., 1893).

HUNT, HENRY JACKSON (1819-1889), American soldier, was born in Detroit, Michigan, on the 14th of September 1819, and graduated at the U.S. military academy in 1839. He served in the Mexican War under Scott, and was brevetted for gallantry at Contreras and Churubusco and at Chapultepec. He became captain in 1852 and major in 1861. His professional attainments were great, and in 1856 he was a member of a board entrusted with the revision of light artillery drill and tactics. He took part in the first battle of Bull Run in 1861, and soon afterwards became chief of artillery in the Washington defences. As a colonel on the staff of General M'Clellan he organized and trained the artillery reserve of the Army of the Potomac. Throughout the Civil War he contributed more than any other officer to the effective employment of the artillery arm. With the artillery reserve he rendered the greatest assistance at the battle of Malvern Hill, and soon afterwards he became chief of artillery in the Army of the Potomac. On the day after the battle of South Mountain he was made brigadier-general of volunteers. At the Antietam, Fredericksburg and Chancellorsville, he rendered further good service, and at Gettysburg his handling of the artillery was conspicuous in the repulse of Pickett's charge, and he was rewarded with the brevet of colonel. He served in Virginia to the end of the war, attaining the brevet ranks of major-general of volunteers and brigadier-general of regulars. When the U.S. army was reorganized in 1866 he became colonel of the 5th artillery and president of the permanent Artillery Board. He held various commands until 1883, when he retired to become governor of the Soldiers' Home, Washington, D.C. He died on the 11th of February 1889. He was the author of *Instructions for Field Artillery* (1860), and of papers on Gettysburg in the "Battles and Leaders" series.

His brother, **LEWIS CASS HUNT** (1824-1886), served throughout the Civil War in the infantry arm, becoming brigadier-general of volunteers in 1862, and brevet brigadier-general U.S.A. in 1865.

HUNT, JAMES HENRY LEIGH (1784-1859), English essayist and miscellaneous writer, was born at Southgate, Middlesex, on the 19th of October 1784. His father, the son of a West Indian clergyman, had settled as a lawyer in Philadelphia, and his mother was the daughter of a merchant there. Having embraced the loyalist side, Leigh Hunt's father was compelled to fly to England, where he took orders, and acquired some reputation as a popular preacher, but want of steadiness, want of orthodoxy, and want of interest conspired to prevent his obtaining any preferment. He was engaged by James Brydges, 3rd duke of Chandos, to act as tutor to his nephew, James

Henry Leigh, after whom Leigh Hunt was called. The boy was educated at Christ's Hospital, of which school he has left a lively account in his autobiography. As a boy at school he was an ardent admirer of Gray and Collins, writing many verses in imitation of them. An impediment in his speech, afterwards removed, prevented his being sent to the university. "For some time after I left school," he says, "I did nothing but visit my school-fellows, haunt the book-stalls and write verses." These latter were published in 1801 under the title of *Juvenilia*, and contributed to introduce him into literary and theatrical society. He began to write for the newspapers, and published in 1807 a volume of theatrical criticisms, and a series of *Classic Tales* with critical essays on the authors.

In 1808 he quitted the War Office, where he had for some time been a clerk, to become editor of the *Examiner* newspaper, a speculation of his brother John. The new journal with which Leigh Hunt was connected for thirteen years soon acquired a high reputation. It was perhaps the only newspaper of the time which owed no allegiance to any political party, but assailed whatever seemed amiss, "from a principle of taste," as Keats happily expressed it. The taste of the attack itself, indeed, was not always unexceptionable; and one upon the Prince Regent, the chief sting of which lay in its substantial truth, occasioned (1813) a prosecution and a sentence of two years' imprisonment for each of the brothers. The effect was to give a political direction to what should have been the career of a man of letters. But the cheerfulness and gaiety with which Leigh Hunt bore his imprisonment attracted general attention and sympathy, and brought him visits from Byron, Moore, Brougham and others, whose acquaintance exerted much influence on his future destiny.

In 1810-1811 he edited for his brother John a quarterly magazine, the *Reflector*, for which he wrote "The Feast of the Poets," a satire which gave offence to many contemporary poets, and particularly offended William Gifford of the *Quarterly*. The essays afterwards published under the title of the *Round Table* (2 vols., 1816-1817), conjointly with William Hazlitt, appeared in the *Examiner*. In 1816 he made a permanent mark in English literature by the publication of his *Story of Rimini*. There is perhaps no other instance of a poem short of the highest excellence having produced so important and durable an effect in modifying the accepted standards of literary composition. The secret of Hunt's success consists less in superiority of genius than of taste. His refined critical perception had detected the superiority of Chaucer's versification, as adapted to the present state of the language by Dryden, over the sententious epigrammatic couplet of Pope which had superseded it. By a simple return to the old manner he effected for English poetry in the comparatively restricted domain of metrical art what Wordsworth had already effected in the domain of nature; his is an achievement of the same class, though not of the same calibre. His poem is also a triumph in the art of poetical narrative, abounds with verbal felicities, and is pervaded throughout by a free, cheerful and animated spirit, notwithstanding the tragic nature of the subject. It has been remarked that it does not contain one hackneyed or conventional rhyme. But the writer's occasional flippancy and familiarity, not seldom degenerating into the ludicrous, made him a mark for ridicule and parody on the part of his opponents, whose animosity, however, was rather political than literary.

In 1818 appeared a collection of poems entitled *Foliage*, followed in 1819 by *Hero and Leander*, and *Bacchus and Ariadne*. In the same year he reprinted these two works with *The Story of Rimini* and *The Descent of Liberty* with the title of *Poetical Works*, and started the *Indicator*, in which some of his best work appeared. Both Keats and Shelley belonged to the circle gathered around him at Hampstead, which also included William Hazlitt, Charles Lamb, Bryan Procter, Benjamin Haydon, Cowden Clarke, C. W. Dilke, Walter Coulson,¹ John Hamilton

¹ Walter Coulson (1794?-1866), lawyer and journalist, was at one time amanuensis to Jeremy Bentham, and became in 1823 editor of the *Globe*.

Reynolds,² and in general almost all the rising young men of letters of liberal sympathies. He had now for some years been married to Marianne Kent, who seems to have been sincerely attached to him, but was not in every respect a desirable partner. His own affairs were by this time in the utmost confusion, and he was only saved from ruin by the romantic generosity of Shelley. In return he was lavish of sympathy to Shelley at the time of the latter's domestic distresses, and defended him with spirit in the *Examiner*, although he does not appear to have at this date appreciated his genius with either the discernment or the warmth of his generous adversary, Professor Wilson. Keats he welcomed with enthusiasm, and introduced to Shelley. He also wrote a very generous appreciation of him in the *Indicator*, and, before leaving for Italy, Keats stayed with Hunt at Hampstead. Keats seems, however, to have subsequently felt that Hunt's example as a poet had been in some respects detrimental to him. After Shelley's departure for Italy (1818) Leigh Hunt's affairs became still more embarrassed, and the prospects of political reform less and less satisfactory. His health and his wife's failed, and he was obliged to discontinue his charming series of essays entitled the *Indicator* (1819-1821), having, he says, "almost died over the last numbers." These circumstances induced him to listen to a proposal, which seems to have originated with Shelley, that he should proceed to Italy and join Shelley and Byron in the establishment of a quarterly magazine in which Liberal opinions should be advocated with more freedom than was possible at home. The project was injudicious from every point of view; it would have done little for Hunt or the Liberal cause at the best, and depended entirely upon the co-operation of Byron, the most capricious of allies, and the most parsimonious of paymasters. Byron's principal motive for acceding to it appears to have been the expectation of acquiring influence over the *Examiner*, and he was exceedingly mortified on discovering when too late that Hunt had parted, or was considered to have parted, with his interest in the journal. Leigh Hunt left England for Italy in November 1821, but storm, sickness and misadventure retarded his arrival until the 1st of July 1822, a rate of progress which T. L. Peacock appropriately compares to the navigation of Ulysses.

The tragic death of Shelley, a few weeks later, destroyed every prospect of success for the *Liberal*. Hunt was now virtually a dependant upon Byron, whose least amiable qualities were called forth by the relation of patron to an unsympathetic dependant, burdened with a large and troublesome family. He was moreover incessantly wounded by the representations of his friends that he was losing caste by the connexion. The *Liberal* lived through four quarterly numbers, containing contributions no less memorable than Byron's "Vision of Judgment" and Shelley's translations from *Faust*; but in 1823 Byron sailed for Greece, leaving his coadjutor at Genoa to shift for himself. The Italian climate and manners, however, were entirely to Hunt's taste, and he protracted his residence until 1825, producing in the interim *Ultra-Crepidarius, a Satire on William Gifford* (1823); and his matchless translation (1825) of Francesco Redi's *Bacco in Toscana*. In 1825 an unfortunate litigation with his brother brought him back to England, and in 1828 he committed his greatest mistake by the publication of his *Lord Byron and some of his Contemporaries*: The work is of considerable value as a corrective of merely idealized estimates of Lord Byron. But such a corrective should not have come from one who had lain under obligations to Byron. British ideas of what was decent were shocked, and the author especially writhed under the withering satire of Moore. For many years ensuing the history of Hunt's life is that of a painful struggle with poverty and sickness. He worked unremittingly, but one effort failed after another. Two journalistic ventures, the *Teller* (1830-1832), a daily devoted to literary and dramatic criticism, and *Leigh Hunt's London Journal* (1834-1835),

² John Hamilton Reynolds (1796-1852), best known for his friendship and correspondence with Keats. His narrative verse founded on the tales of Boccaccio appeared in 1821 as *The Garden of Florence and other Poems*. He wrote some admirable sonnets, one of which is addressed to Keats.

were discontinued for want of subscribers, although in the latter Leigh Hunt had able coadjutors, and it contained some of his best writing. His editorship (1837-1838) of the *Monthly Repository*, in which he succeeded W. J. Fox, was also unsuccessful. The adventitious circumstances which had for a time made the fortune of the *Examiner* no longer existed, and Hunt's strong and weak points, his refinement and his affectations, were alike unsuited to the general body of readers.

In 1832 a collected edition of his poems was published by subscription, the list of subscribers including many of his opponents. In the same year was printed for private circulation *Christianism*, the work afterwards published (1853) as *The Religion of the Heart*. A copy sent to Carlyle secured his friendship, and Hunt went to live next door to him in Cheyne Row in 1833. *Sir Ralph Esher*, a romance of Charles II.'s period, had a success, and *Captain Sword and Captain Pen* (1835), a spirited contrast between the victories of peace and the victories of war, deserves to be ranked among his best poems. In 1840 his circumstances were improved by the successful representation at Covent Garden of his *Legend of Florence*, a play of considerable merit. *Lover's Amusements*, a comedy, was acted several years afterwards, and was printed in *Leigh Hunt's Journal* (1850-1851); and other plays remained in MS. In 1840 he wrote introductory notices to the work of R. B. Sheridan and to Moxon's edition of the works of Wycherley, Congreve, Vanbrugh and Farquhar, a work which furnished the occasion of Macaulay's essay on the *Dramatists of the Restoration*. The pretty narrative poem of *The Palfrey* was published in 1842.

The time of Hunt's greatest difficulties was between 1834 and 1840. He was at times in absolute want, and his distress was aggravated by domestic complications. By Macaulay's recommendation he began to write for the *Edinburgh Review*. In 1844 he was further benefited by the generosity of Mrs Shelley and her son, who, on succeeding to the family estates, settled an annuity of £120 upon him; and in 1847 Lord John Russell procured him a civil list pension of £200. The fruits of the improved comfort and augmented leisure of these latter years were visible in the production of some charming volumes. Foremost among these are the companion books, *Imagination and Fancy* (1844), and *Wit and Humour* (1846), two volumes of selections from the English poets. In these Leigh Hunt shows himself within a certain range the most refined, appreciative and felicitous of critics. Homer and Milton may be upon the whole beyond his reach, though even here he is great in the detection of minor and unapprehended beauties; with Spenser and the old English dramatists he is perfectly at home, and his subtle and discriminating criticism upon them, as well as upon his own great contemporaries, is continually bringing to light unsuspected beauties. His companion volume on the pastoral poetry of Sicily, quaintly entitled *A Jar of Honey from Mount Hybla* (1848), is almost equally delightful. *The Town* (2 vols., 1848) and *Men, Women and Books* (2 vols., 1847) are partly made up from former material. *The Old Court Suburb* (2 vols., 1855; ed. A. Dobson, 1902) is an anecdotic sketch of Kensington, where he long resided before his final removal to Hammersmith. In 1850 he published his *Autobiography* (3 vols.), a naive and accurate piece of self-portraiture, full of affectations, but on that account free from the affectation of unreality. It contains very detailed accounts of some of the most interesting periods of the author's life, his education at Christ's Hospital, his imprisonment, and his residence in Italy. *A Book for a Corner* (2 vols.) was published in 1849, and his *Table Talk* appeared in 1851. In 1855 his narrative poems, original and translated, were collected under the title of *Stories in Verse*, with an interesting preface. He died at Putney on the 28th of August 1859.

Leigh Hunt's virtues were charming rather than imposing or brilliant; he had no vices, but very many foibles. His great misfortune was that these foibles were for the most part of an undignified sort. His affectation is not comparable to Byron's, nor his egotism to Wordsworth's, but their very pettiness excites a sensation of the ludicrous. The very sincerity of his nature is detrimental to him; the whole man seems to be revealed

in everything he ever wrote, and hence the most beautiful productions of his pen appear in a manner tainted by his really very pardonable weaknesses. Some of these, such as his helplessness in money matters, and his facility in accepting the obligations which he would have delighted to confer, involved him in painful and humiliating embarrassments, which seem to have been aggravated by the mismanagement of those around him. The notoriety of these things has deprived him of much of the honour due to him for his fortitude under the severest calamities, for his unremitting literary industry under the most discouraging circumstances, and for his uncompromising independence as a journalist and an author. It was his misfortune to be involved in politics, for he was as thorough a man of letters as ever existed, and most of his failings were more or less incidental to that character. But it is not every consummate man of letters of whom it can be unhesitatingly affirmed that he was brave, just and pious. When it was suggested that Leigh Hunt was the original of Harold Skimpole in *Bleak House*, Charles Dickens denied that any of the shadows in the portrait were suggested by Hunt, who was, he said, "the very soul of truth and honour."

Leigh Hunt's character as an author was the counterpart of his character as a man. In some respects his literary position is unique. Few men have effected so much by mere exquisiteness of taste in the absence of high creative power; fewer still, so richly endowed with taste, have so frequently and conspicuously betrayed the want of it; and he was incapable of discovering where familiarity became flippancy. But his poetry possesses a brightness, animation, artistic symmetry and metrical harmony, which lift the author out of the rank of minor poets, particularly when the influence of his example upon his contemporaries is taken into account. He excelled especially in narrative poetry, of which, upon a small scale, there are probably no better examples than "Abou ben Adhem" and "Solomon's Ring." He possessed every qualification for a translator; and as an appreciative critic, whether literary or dramatic, he has hardly been equalled.

Leigh Hunt's other works include: *Amynias, A Tale of the Woods* (1820), translated from Tasso; *The Scer, or Common-Places refreshed* (2 pts., 1830-1831); three of the Canterbury Tales in *The Poems of Geoffrey Chaucer, modernized* (1841); *Stories from the Italian Poets* (1846); compilations such as *One Hundred Romances of Real Life* (1843); selections from Beaumont and Fletcher (1855); and, with S. Adams Lee, *The Book of the Sonnet* (Boston, 1867). His *Poetical Works* (2 vols.), revised by himself and edited by Lee, were printed at Boston, U.S.A., in 1857, and an edition (London and New York) by his son, Thornton Hunt, appeared in 1860. Among volumes of selections are: *Essays* (1887), ed. C. Kent; *Leigh Hunt as Poet and Essayist* (1889), ed. C. Kent; *Essays and Poems* (1891), ed. R. B. Johnson for the "Temple Library."

His *Autobiography* was revised by himself shortly before his death, and edited (1859) by his son Thornton Hunt, who also arranged his *Correspondence* (2 vols., 1862). Additional letters were printed by the Cowden Clarkes in their *Recollections of Writers* (1878). The *Autobiography* was edited (2 vols., 1903) with full bibliographical note by R. Ingpen. A bibliography of his works was compiled by Alexander Ireland (*List of the Writings of William Hazlitt and Leigh Hunt*, 1868). There are short lives of Hunt by Cosmo Monkhouse ("Great Writers," 1893) and by R. B. Johnson (1896).

HUNT, ROBERT (1807-1887), English natural philosopher, was born at Devonport on the 6th of September 1807. His father, a naval officer, was drowned while Robert was a youth. He began to study in London for the medical profession, but ill-health caused him to return to the west of England, and in 1840 he became secretary to the Royal Cornwall Polytechnic Society at Falmouth. Here he was brought into contact with Robert Were Fox, and carried on some physical and chemical investigations with him. He took up photography with great zeal, following Daguerre's discovery, and introducing new processes. His *Manual of Photography* (1841, ed. 5, 1857) was the first English treatise on the subject. He also experimented generally on the action of light, and published *Researches on Light* (1844). In 1845 he accepted the invitation of Sir Henry de la Beche to become keeper of mining records at the Museum of Economic (afterwards "Practical") Geology, and when the school of mines was established in 1851 he lectured for two years on mechanical science, and afterwards for a short time on

experimental physics. His principal work was the collection and editing of the *Mineral Statistics of the United Kingdom*, and this he continued to the date of his retirement (1883), when the mining record office was transferred to the Home Office. He was elected F.R.S. in 1854. In 1884 he published a large volume on *British Mining*, in which the subject was dealt with very fully from an historical as well as a practical point of view. He also edited the fifth and some later editions of Ure's *Dictionary of Arts, Mines and Manufactures*. He died in London on the 17th of October 1887. A mineralogical museum at Redruth has been established in his memory.

HUNT, THOMAS STERRY (1826-1892), American geologist and chemist, was born at Norwich, Conn., on the 5th of September 1826. He lost his father when twelve years old, and had to earn his own livelihood. In the course of two years he found employment in a printing office, in an apothecary's shop, in a book store and as a clerk. He became interested in natural science, and especially in chemical and medical studies, and in 1845 he was elected a member of the Association of American Geologists and Naturalists at Yale—a body which four years later became the American Association for the Advancement of Science. In 1848 he read a paper in Philadelphia *On Acid Springs and Gypsum Deposits of the Onondaga Salt Group*. At Yale he became assistant to Professor B. Silliman, Jun., and in 1846 was appointed chemist to the Geological Survey of Vermont. In 1847 he was appointed to similar duties on the Canadian Geological Survey at Montreal under Sir William Logan, and this post he held until 1872. In 1859 he was elected F.R.S., and he was one of the original members and president of the Royal Society of Canada. He was a frequent contributor to scientific journals, writing on the crystalline limestones, the origin of continents, the chemistry of the primeval earth, on serpentine, &c. He also wrote a notable "Essay on the History of the names Cambrian and Silurian" (*Canadian Naturalist*, 1872), in which the claims of Sedgwick, with respect to the grouping of the Cambrian strata, were forcibly advocated. He died in New York City on the 12th of February 1892.

His publications include *Chemical and Geological Essays* (1875, ed. 2, 1879); *Mineral Physiology and Physiography* (1886); *A New Basis for Chemistry* (1887, ed. 3, 1891); *Systematic Mineralogy* (1891). See an obituary notice by Pesaïor Frazer, *Amer. Geologist* (xi. Jan. 1893), with portrait.

HUNT, WILLIAM HENRY (1790-1864), English water-colour painter, was born near Long Acre, London, on the 28th of March 1790. He was apprenticed about 1805 to John Varley, the landscape-painter, with whom he remained five or six years, exhibiting three oil pictures at the Royal Academy in 1807. He was early connected with the Society of Painters in Water-colour, of which body, then in a transition state, he was elected associate in 1824, and full member in 1827. To its exhibitions he was until the year of his death one of the most prolific contributors. Many years of Hunt's uneventful and industrious life were passed at Hastings. He died of apoplexy on the 10th of February 1864. Hunt was one of the creators of the English school of water-colour painting. His subjects, especially those of his later life, are extremely simple; but, by the delicacy, humour and fine power of their treatment, they rank second to works of the highest art only. Considered technically, his works exhibit all the resources of the water-colour painter's craft, from the purest transparent tinting to the boldest use of body-colour, rough paper and scraping for texture. His sense of colour is perhaps as true as that of any English artist. "He was," says Ruskin, "take him for all in all, the finest painter of still life that ever existed." Several characteristic examples of Hunt's work, as the "Boy and Goat," "Brown Study" and "Plums, Primroses and Birds' Nests" are in the Victoria and Albert Museum.

HUNT, WILLIAM HOLMAN (1827-1910), English artist, was born in London on the 2nd of April 1827. An ancestor on his father's side bore arms against Charles I., and went over to Holland, where he fought in the Protestant cause. He returned with William III., but the family failed to recover their property. Holman Hunt's father was the manager of a city warehouse,

with tastes superior to his position in life. He loved books and pictures, and encouraged his son to pursue art as an amusement, though not as a profession. At the age of twelve and a half Holman Hunt was placed in a city office, but he employed his leisure in reading, drawing and painting, and at sixteen began an independent career as an artist. When he was between seventeen and eighteen he entered the Royal Academy schools, where he soon made acquaintance with his lifelong friend John Everett Millais, then a boy of fifteen. In 1846 Holman Hunt sent to the Royal Academy his first picture ("Hark!"), which was followed by "Dr Rochecliffe performing Divine Service in the Cottage of Joceline Jolliffe at Woodstock," in 1847, and "The Flight of Madeline and Porphyrio" (from Keats's *See of St Agnes*) in 1848. In this year he and Millais, with the co-operation of Dante Gabriel Rossetti and others, initiated the famous Pre-Raphaelite movement in art. Typical examples of the new creed were furnished in the next year's Academy by Millais's "Isabella" and Holman Hunt's "Rienzi vowing to obtain Justice for the Death of his Young Brother." This last pathetic picture, which was sold to Mr Gibbons for £105, was followed in 1850 by "A Converted British Family sheltering a Christian Missionary from the Persecution of the Druids" (bought by Mr Combe, of the Clarendon Press, Oxford, for £150), and in 1851 by "Valentine protecting Sylvia from Proteus." This scene from *The Two Gentlemen of Verona* was very warmly praised by Ruskin (in letters to *The Times*), who declared that as studies both of drapery and of every minor detail there had been nothing in art so earnest and complete since the days of Albert Dürer. It gained a prize at Liverpool, and is reckoned as the finest of Holman Hunt's earlier works. In 1852 he exhibited "A Hiring Shepherd." "Claudio and Isabella," from *Measure for Measure*, and a brilliant study of the Downs near Hastings, called in the catalogue "Our English Coasts, 1852" (since generally known as "Strayed Sheep"), were exhibited in 1853. For three of his works Holman Hunt was awarded prizes of £50 and £60 at Liverpool and Birmingham, but in 1851 he had become so discouraged by the difficulty of selling his pictures, that he had resolved to give up art and learn farming, with a view to emigration. In 1854 he achieved his first great success by the famous picture of "The Light of the World," an allegorical representation of Christ knocking at the door of the human soul. This work produced perhaps the greatest effect of any religious painting of the century. "For the first time in England," wrote William Bell Scott, "a picture became a subject of conversation and general interest from one end of the island to the other, and indeed continued so for many years." "The Awakening Conscience," exhibited at the same time, depicted a tragic moment in a life of sin, when a girl, stricken with memories of her innocent childhood, rises suddenly from the knees of her paramour. The inner meaning of both these pictures was explained by Ruskin in letters to *The Times* in May 1854. "The Light of the World" was purchased by Mr Combe, and was given by his wife to Keble College. In 1904 Holman Hunt completed a second "Light of the World," slightly altered from the original, the execution of which was due to his dissatisfaction with the way in which the Keble picture was shown there; and he intended the second edition of it for as wide public exhibition as possible. It was acquired by Mr Charles Booth, who arranged for the exhibition of the new "Light of the World" in all the large cities of the colonies.

In January 1854 Holman Hunt left England for Syria and Palestine with the desire to revivify on canvas the facts of Scripture history, "surrounded by the very people and circumstances of the life in Judaea of old days." The first fruit of this idea, which may be said to have dominated the artist's life, was "The Scapegoat," a solitary outcast animal standing alone on the salt-encrusted shores of the Dead Sea, with the mountains of Edom in the distance, seen under a gorgeous effect of purple evening light. It was exhibited at the Royal Academy in 1856, together with three Eastern landscapes. His next picture (1860), one of the most elaborate and most successful of his works, was "The Finding of our Saviour in the Temple." Like all his

important pictures, it was the work of years. Many causes contributed to the delay in its completion, including a sentence of what was tantamount to excommunication (afterwards revoked) passed on all Jews acting as models. Thousands crowded to see this picture, which was exhibited in London and in many English provincial towns. It was purchased for £5500, and is now in the Birmingham Municipal Art Gallery. Holman Hunt's next great religious picture was "The Shadow of Death" (exhibited separately in 1873), an imaginary incident in the life of our Lord, who, lifting His arms with weariness after labour in His workshop, throws a shadow on the wall as of a man crucified, which is perceived by His mother. This work was presented to Manchester by Sir William Agnew. Meanwhile there had appeared at the Royal Academy in 1861 "A Street in Cairo: The Lanternmaker's Courtship," and in 1863 "The King of Hearts," and a portrait of the Right Hon. Stephen Lushington, D.C.L. In 1866 came "Isabella and the Pot of Basil," "London Bridge on the Night of the Marriage of the Prince of Wales," and "The Afterglow." In 1867 Holman Hunt sent a charming head of "A Tuscan Girl" to the Grosvenor Gallery and two pictures to the Royal Academy. These were "Il dolce far niente" and a lifelike study of pigeons in rain called "The Festival of St Swithin," now in the Taylor Building, Oxford, with many others of this artist's work. After two years' absence Holman Hunt returned to Jerusalem in 1875, where he was engaged upon his great picture of "The Triumph of the Innocents," which proved to be the most serious labour of his life. The subject is an imaginary episode of the flight into Egypt, in which the Holy Family are attended by a procession of the Holy Innocents, marching along the waters of life and illuminated with unearthly light. Its execution was delayed by an extraordinary chapter of accidents. For months Holman Hunt waited in vain for the arrival of his materials, and at last he unfortunately began on an unsuitable piece of linen procured in despair at Jerusalem. Other troubles supervened, and when he arrived in England he found his picture in such a state that he was compelled to abandon it and begin again. The new version of the work, which is somewhat larger and changed in several points, was not completed till 1885. Meanwhile the old picture was retined and so skilfully treated that the artist was able to complete it satisfactorily, and there are now two pictures entitled "The Triumph of the Innocents," one in the Liverpool, the other in the Birmingham Art Gallery. The pictures exhibited between 1875 and 1885 included "The Ship," a realistic picture of the deck of a passenger ship by night (1878), and portraits of his son (1880), Sir Richard Owen (1881) and Dante Gabriel Rossetti (1884). All of these were exhibited at the Grosvenor Gallery, where they were followed by "The Bride of Bethlehem" (1885), "Amaryllis" and a portrait of his son (tracing a drawing on a window) in 1886. His most important later work is "May-Day, Magdalen Tower," a record of the service of song which has been held on the tower of Magdalen, Oxford, at sunrise on May-Day from time immemorial. The subject had interested the artist for a great many years, and, after "The Triumph of the Innocents" was completed, he worked at it with his usual devotion, climbing up the tower for weeks together in the early morning to study the sunrise from the top. This radiant poem of the simplest and purest devotion was exhibited at the Gainsborough Gallery in Old Bond Street in 1891. He continued to send occasional contributions to the exhibitions of the Royal Water-Colour Society, to the New Gallery and to the New English Art Club. One of the most remarkable of his later works (New Gallery, 1899) is "The Miracle of Sacred Fire in the Church of the Sepulchre, Jerusalem."

By his strong and constant individuality, no less than by his peculiar methods of work, Holman Hunt holds a somewhat isolated position among artists. He remained entirely unaffected by all the various movements in the art-world after 1850. His ambition was always "to serve as high priest and expounder of the excellence of the works of the Creator." He spent too much labour on each work to complete many; but perhaps no painter of the 19th century produced so great an impression by a

few pictures as the painter of "The Light of the World," "The Scapegoat," "The Finding of our Saviour in the Temple" and "The Triumph of the Innocents"; and his greatness was recognized by his inclusion in the Order of Merit. His *History of Pre-Raphaelitism*, a subject on which he could speak as a first authority, but not without dissent from at least one living member of the P.R.B., was published in 1905. On the 7th of September 1910 he died in London, and on September 17th his remains, after cremation at Golder's Green, were buried in St Paul's Cathedral, with national honours.

See Archdeacon Farrar and Mrs Alice Meynell, "William Holman Hunt, his Life and Work" (*Art Annual*) (London, 1893); John Ruskin, *Modern Painters; The Art of England* (Lecture) (consult Gordon Crauford's *Notes on the Pictures of Mr Holman Hunt*, 1886); Robert de la Sizeranne, *La Peinture anglaise contemporaine* (Paris, 1895); W. B. Scott, *Autobiographical Notes*; W. M. Rossetti, *Pre-Raphaelite Diaries and Letters*; Percy H. Bate, *The Pre-Raphaelite Painters* (1899); Sir W. Bayliss, *Fine Great Painters of the Victorian Era* (1902). (C. Mo.)

HUNT, WILLIAM MORRIS (1824-1870), American painter, was born at Brattleboro, Vermont, on the 31st of March 1824. His father's family were large landowners in the state. He was for a time (1840) at Harvard, but his real education began when he accompanied his mother and brother to Europe, where he studied with Couture in Paris and then came under the influence of Jean François Millet. The companionship of Millet had a lasting influence on Hunt's character and style, and his work grew in strength, in beauty and in seriousness. He was the real introducer of the Barbizon school to America, and he more than any other turned the rising generation of American painters towards Paris. On his return in 1855 he painted some of his most beautiful pictures, all reminiscent of his life in France and of Millet's influence. Such are "The Belated Kid," "Girl at the Fountain," "Hurdy-Gurdy Boy," &c. But the public called for portraits, and it became the fashion to sit to him, among his best paintings in this kind being those of William M. Evans, Mrs Charles Francis Adams, the Rev. James Freeman Clarke, William H. Gardner, Chief Justice Shaw and Judge Horace Gray. Unfortunately many of his paintings and sketches, together with five large Milletts and other art treasures collected by him in Europe, were destroyed in the great Boston fire of 1872. Among his later works American landscapes predominated. They also include the "Bathers"—twice painted—and the allegories for the senate chamber of the State Capitol at Albany, N.Y., now lost by the disintegration of the stone panels on which they were painted. Hunt was drowned at the Isles of Shoals on the 8th of September 1870. His book, *Talks about Art* (London, 1878), is well known.

His brother, RICHARD MORRIS HUNT (1828-1895), the famous architect, was born in Brattleboro, Vermont, on the 31st of October 1828. He studied in Europe (1843-1854), mainly in the École des Beaux Arts at Paris, and in 1854 was appointed inspector of works on the buildings connecting the Tuileries with the Louvre. Under Hector Lefuel he designed the Pavillon de la Bibliothèque, opposite the Palais Royal. In 1855 he returned to New York, and was employed on the extension of the Capitol at Washington. He designed the Lenox Library, the Stuyvesant and the Tribune buildings in New York; the theological library, and Marquand chapel at Princeton; the Divinity College and the Scroll and Key building at Yale; the Vanderbilt mausoleum on Staten Island, and the Yorktown monument. For the Administration Building at the World's Columbian Exposition at Chicago in 1893 Hunt received the gold medal of the Institute of British Architects. Among the most noteworthy of his domestic buildings were the residences of W. K. Vanderbilt and Henry G. Marquand in New York City; George W. Vanderbilt's country house at Biltmore, and several of the large "cottages" at Newport, R.I., including "Marble House" and "The Breakers." He was one of three foreign members of the Italian Society of St Luke, an honorary and corresponding member of the Académie des Beaux Arts and of the Royal Institute of British Architects, and a Chevalier of the Legion of Honour. He was the first to command respect in foreign countries for American architecture, and was the leader

of a school that has established in the United States the manner and the traditions of the Beaux Arts. He took a prominent part in the founding of the American Institute of Architects, and, from 1888, was its president. His talent was eminently practical; and he was almost equally successful in the ornate style of the early Renaissance in France, in the picturesque style of his comfortable villas, and the monumental style of the Lenox Library. There is a beautiful memorial to Hunt in the wall of Central Park, opposite this building, erected in 1898 by the associated art and architectural societies of New York, from designs by Daniel C. French and Bruce Price. He died on the 31st of July 1895.

HUNTER, JOHN (1728-1793), British physiologist and surgeon, was born on the 13th¹ of February 1728, at Long Calderwood, in the parish of East Kilbride, Lanarkshire, being the youngest of the ten children of John and Agnes Hunter. His father, who died on the 30th of October 1741,² aged 78, was descended from the old Ayrshire family of Hunter of Hunterston, and his mother was the daughter of a Mr Paul, treasurer of Glasgow. Hunter is said to have made little progress at school, being averse to its restraints and pursuits, and fond of country amusements. When seventeen years old he went to Glasgow, where for a short time he assisted his brother-in-law, Mr Buchanan, a cabinetmaker. Being desirous at length of some settled occupation, he obtained from his brother William (*q.v.*) permission to aid, under Mr Symonds, in making dissections in his anatomical school, then the most celebrated in London, intending, should he be unsuccessful there, to enter the army. He arrived accordingly in the metropolis in September 1748, about a fortnight before the beginning of his brother's autumnal course of lectures. After succeeding beyond expectation with the dissection of the muscles of an arm, he was entrusted with a similar part injected, and from the excellence of his second essay Dr Hunter predicted that he would become a good anatomist. Seemingly John Hunter had hitherto received no instruction in preparation for the special course of life upon which he had entered.

Hard-working, and singularly patient and skilful in dissection, Hunter had by his second winter in London acquired sufficient anatomical knowledge to be entrusted with the charge of his brother's practical class. In the summer months of 1749-1750, at Chelsea Military Hospital, he attended the lectures and operations of William Cheselden, on whose retirement in the following year he became a surgeon's pupil at St Bartholomew's, where Percivall Pott was one of the senior surgeons. In the summer of 1752 he visited Scotland. Sir Everard Home and, following him, Drewry Oatley state that Hunter began in 1754 to assist his brother as his partner in lecturing; according, however, to the *European Magazine* for 1782, the office of lecturer was offered to Hunter by his brother in 1758, but declined by him on account of the "insuperable embarrassments and objections" which he felt to speaking in public. In 1754 he became a surgeon's pupil at St George's Hospital, where he was appointed house-surgeon in 1756.³ During the period of his connexion with Dr Hunter's school he, in addition to other labours, solved the problem of the descent of the testis in the foetus, traced the ramifications of the nasal and olfactory nerves within the nose, experimentally tested the question whether veins could act as absorbents, studied the formation of pus and the nature of the placental circulation, and with his brother earned the chief merit of practically proving the function and importance of the lymphatics in the animal economy. On the 5th of June 1755,⁴ he

was induced to enter as a gentleman commoner at St Mary's Hall, Oxford, but his instincts would not permit him, to use his own expression, "to stuff Latin and Greek at the university." Some three and thirty years later he thus significantly wrote of an opponent: "Jesse Foot accuses me of not understanding the dead languages; but I could teach him that on the dead body which he never knew in any language dead or living."⁵ Doubtless, however, linguistic studies would have served to correct in him what was perhaps a natural defect—a difficulty in the presentation of abstract ideas not wholly attributable to the novelty of his doctrines.

An attack of inflammation of the lungs in the spring of 1759 having produced symptoms threatening consumption, by which the promising medical career of his brother James had been cut short, Hunter obtained in October 1760 the appointment of staff-surgeon in Hodgson and Keppel's expedition to Belleisle. With this he sailed in 1761. In the following year he served with the English forces on the frontier of Portugal. Whilst with the army he acquired the extensive knowledge of gunshot wounds embodied in his important treatise (1794) on that subject, in which, amongst other matters of moment, he insists on the rejection of the indiscriminate practice of dilating with the knife followed almost universally by surgeons of his time. When not engaged in the active duties of his profession, he occupied himself with physiological and other scientific researches. Thus, in 1761, off Belleisle, the conditions of the coagulation of the blood were among the subjects of his inquiries.⁶ Later, on land, he continued the study of human anatomy, and arranged his notes and memoranda on inflammation; he also ascertained by experiment that digestion does not take place in snakes and lizards during hibernation, and observed that enforced vigorous movement at that season proves fatal to such animals, the waste so occasioned not being compensated, whence he drew the inference that, in the diminution of the power of a part attendant on mortification, resort to stimulants which increase action without giving real strength is inadvisable.⁷ A MS. catalogue by Hunter, probably written soon after his return from Portugal, shows that he had already made a collection of about two hundred specimens of natural and morbid structures.

On arriving in England early in 1763, Hunter, having retired from the army on half-pay, took a house in Golden Square, and began the career of a London surgeon. Most of the metropolitan practice at the time was held by P. Pott, C. Hawkins, Samuel Sharp, Joseph Warner and Robert Adair; and Hunter sought to eke out his at first slender income by teaching practical anatomy and operative surgery to a private class. His leisure was devoted to the study of comparative anatomy, to procure subjects for which he obtained the refusal of animals dying in the Tower menagerie and in various travelling zoological collections. In connexion with his rupture of a tendo Achillis,⁸ in 1767, he performed on dogs several experiments which, with the illustrations in his museum of the reunion of such structures after division, laid the foundation of the modern practice of cutting through tendons (tenotomy) for the relief of distorted and contracted joints. In the same year he was elected F.R.S. His first contribution to the *Philosophical Transactions*, with the

salis.⁹ Hunter apparently left Oxford after less than two months' residence, as the last entry in the buttry book with charges for battels against his name is on July 25, 1755. His name was, however, retained on the books of the Hall till December 10, 1756. The record of Hunter's matriculation runs: "Ter. Trin. 1755.—Junii 5^o Aul. S. Mar. Johannes Hunter 24 Johannis de Kilbride in Com. Clidesdale Scotiae Arm. fil."

¹ Oatley, *Life of J. Hunter*, p. 22.

² *Treatise on the Blood*, p. 21.

³ See Adams, *Memoirs*, pp. 32, 33. Cf. Hunter's *Treatise on the Blood*, p. 8, and *Works*, ed. Palmer, i. 604.—On the employment of Hunter's term "increased action" with respect to inflammation, see Sir James Paget, *Lect. on Surg. Path.*, 3rd ed., p. 321 sqq.

⁴ According to Hunter, as quoted in Palmer's edition of his lectures, p. 437, the accident was "after dancing, and after a violent fit of the cramp": W. Clift, however, who says he probably never danced, believed that he met with the accident "in getting up from the dissecting table after being cramped by long sitting" (see W. Lawrence, *Hist. Anat.*, 1834, p. 64).

¹ The date is thus entered in the parish register, see Joseph Adams, *Memoirs*, Appendix, p. 203. The Hunterian Oration, instituted in 1813 by Dr Matthew Baillie and Sir Everard Home, is delivered at the Royal College of Surgeons on the 14th of February, which Hunter used to give as the anniversary of his birth.

² Oatley's date, 1738, is inaccurate, see S. F. Simmons, *Account of . . . W. Hunter*, p. 7. Hunter's mother died on the 3rd of November 1751, aged 66.

³ So in Home's *Life*, p. xvi., and Oatley s. p. 15. Hunter himself (*Treatise on the Blood*, p. 62) mentions the date 1755.

⁴ Oatley incorrectly gives 1753 as the date. In the buttry book for 1755 at St. Mary's Hall his admission is thus noted: "Die Junii 5^o 1755 Admissus est Johannes Hunter superioris ordinis Commen-

exception of a supplement to a paper by J. Ellis in the volume for 1766, was an essay on post-mortem digestion of the stomach, written at the request of Sir J. Pringle, and read on the 18th of June 1772, in which he explained that phenomenon as a result of the action of the gastric juice.¹ On the 9th of December 1768 he was elected a surgeon to St George's Hospital, and, soon after, a member of the Corporation of Surgeons. He now began to take house-pupils. Among these were Edward Jenner, who came to him in 1770, and until the time of Hunter's death corresponded with him on the most intimate and affectionate terms, W. Guy, Dr P. S. Physick of Philadelphia, and Everard Home his brother-in-law. William Lynn and Sir A. Carlisle, though not inmates of his house, were frequent visitors there. His pupils at St George's included John Abernethy, Henry Cline, James Earle and Astley Cooper. In 1770 he settled in Jermyn Street, in the house which his brother William had previously occupied; and in July 1771 he married Anne, the eldest daughter of Robert Home, surgeon to Burgoyne's regiment of light horse.²

From 1772 till his death Hunter resided during autumn at a house built by him at Earl's Court, Brompton, where most of his biological researches were carried on. There he kept for the purpose of study and experiment the fishes, lizards, blackbirds, hedgehogs and other animals sent him from time to time by Jenner; tame pheasants and partridges, at least one eagle, toads, silkworms, and many more creatures, obtained from every quarter of the globe. Bees he had under observation in his conservatory for upwards of twenty years; hornets and wasps were also diligently studied by him. On two occasions his life was in risk from his pets—once in wrestling with a young bull, and again when he fearlessly took back to their dens two leopards which had broken loose among his dogs.

Choosing intuitively the only true method of philosophical discovery, Hunter, ever cautious of confounding fact and hypothesis, besought of nature the truth through the medium of manifold experiments and observations. "He had never read Bacon," says G. G. Babington, "but his mode of studying nature was as strictly Baconian as if he had."³ To Jenner, who had offered a conjectural explanation of a phenomenon, he writes, on the 2nd of August 1775: "I think your solution is just; but why think? why not try the experiment? Repeat all the experiments upon a hedgehog⁴ as soon as you receive this, and they will give you the solution." It was his axiom however, "that experiments should not be often repeated which tend merely to establish a principle already known and admitted, but that the next step should be the application of that principle to useful purposes" ("Anim. Oecon.", *Works*, iv. 86). During

¹ The subjects and dates of his subsequent papers in the *Transactions*, the titles of which give little notion of the richness of their contents, are as follows: The torpedo (1773); air-receptacles in birds, and the Gillaroo trout (1774); the *Gymnotus electricus*, and the production of heat by animals and vegetables (supplemented in 1777); (1775) the recovery of people apparently drowned (1776); the free martin (1779); the communication of smallpox to the foetus in utero, and the occurrence of male plumage in old hen pheasants (1780); the organ of hearing in fishes (1782); the anatomy of a "new marine animal" described by Home (1785); the specific identity of the wolf, jackal and dog (supplemented in 1789); the effect on fertility of extirpation of one ovary, and the structure and economy of whales (1787); observations on bees (1793); and some remarkable caves in Bayreuth and fossil bones found therein (1794). With these may be included a paper by Home, from materials supplied by Hunter, on certain horny excrescences of the human body.

² Mrs Hunter died on the 7th of January 1821, in Holles Street, Cavendish Square, London, in her seventy-ninth year. She was a handsome and accomplished woman, and well filled the social duties of her position. The words for Haydn's English canzonets were supplied by her, and were mostly original poems; of these the lines beginning "My mother bids me bind my hair" are, from the beauty of the accompanying music, among the best known. (See R. Nares in *Genl. Mag.* xci. pt. 1, p. 89, quoted in Nichols's *Lit. Anec.*, 2nd ser., vii. 638.)

³ *Hunt. Orat.*, 1842, p. 15.

⁴ The condition of this animal during hibernation was a subject of special interest to Hunter, who thus introduces it, even in a letter of condolence to Jenner in 1778 on a disappointment in love: "But let her go, never mind her. I shall employ you with hedgehogs, for I do not know how far I may trust mine."

fifteen years he kept a flock of geese simply in order to acquaint himself with the development of birds in eggs, with reference to which he remarked: "It would almost appear that this mode of propagation was intended for investigation." In his toxicological and other researches, in which his experience had led him to believe that the effects of noxious drugs are nearly similar in the brute creation and in man, he had already, in 1780, as he states, "poisoned some thousands of animals."⁵

By inserting shot at definite distances in the leg-bones of young pigs, and also by feeding them with madder, by which all fresh osseous deposits are tiaged,⁶ Hunter obtained evidence that bones increase in size, not by the intercalation of new amongst old particles, as had been imagined by H. L. Duhamel du Monceau, but by means of additions to their extremities and circumference, excess of calcareous tissue being removed by the absorbents. Some of his most extraordinary experiments were to illustrate the relation of the strength of constitution to sex. He exchanged the spurs of a young cock and a young pullet, and found that on the former the transplanted structure grew to a fair size, on the latter but little; whereas a spur from one leg of a cock transferred to its comb, a part well supplied with blood, grew more than twice as fast as that left on the other leg. Another experiment of his, which required many trials for success, was the engrafting of a human incisor on the comb of a cock.⁷ The uniting of parts of different animals when brought into contact he attributed to the production of adhesive instead of suppurative inflammation, owing to their possession of "the simple living principle."⁸ The effects of habit upon structure were illustrated by Hunter's observation that in a sea-gull which he had brought to feed on barley the muscular parietes of the gizzard became greatly thickened. A similar phenomenon was noticed by him in the case of other carnivorous birds fed on a vegetable diet.

It was in 1772 that Hunter, in order effectually to gauge the extent of his own knowledge, and also correctly to express his views, which had been repeatedly misstated or ascribed to others, began his lectures on the theory and practice of surgery, at first delivered free to his pupils and a few friends, but subsequent to 1774 on the usual terms, four guineas. Though Pott, indeed, had perceived that the only true system of surgery is that which most closely accords with the curative efforts of nature, a rational pathology can hardly be said to have had at this time any existence; and it was generally assumed that a knowledge of anatomy alone was a sufficient foundation for the study of surgery. Hunter, unlike his contemporaries, to most of whom his philosophic habit of thought was a mystery, and whose books contained little else than relations of cases and modes of treatment, sought the reason for each phenomenon that came under his notice. The principles of surgery, he maintained, are not less necessary to be understood than the principles of other sciences; unless, indeed, the surgeon should wish to resemble "the Chinese philosopher whose knowledge consisted only in facts." Too much attention, he remarked, cannot be paid to facts; yet a multitude of facts overcrowd the memory without advantage if they do not lead us to establish principles, by an acquaintance with which we learn the causes of diseases. Hunter's course, which latterly comprised eighty-six lectures, delivered on alternate evenings between the hours of seven and eight, lasted from October to April. Some teachers of his time were content to dismiss the subjects of anatomy and surgery in a course of only six weeks' duration. His class was usually small and never exceeded thirty. He was deficient in the gifts of a good extempore speaker, being in this respect a remarkable contrast to his brother William; and he read his lectures, seldom raising his eyes from the manuscript. His manner with his

⁵ See his evidence at the trial of Captain Donellan, *Works*, i. 195.

⁶ On the discovery of the dyeing of bones by madder, see Belcher, *Phil. Trans.*, vol. xxxix., 1736, pp. 287 and 299.

⁷ *Essays and Observations*, i. 55, 56. "May we not claim for him," says Sir Wm. Ferguson, with reference to these experiments, "that he anticipated by a hundred years the scientific data on which the present system of human grafting is conducted?" (*Hunt. Orat.*, 1871, p. 17).

⁸ *Essays and Observations*, i. 115; cf. *Works*, i. 391.

auditory is stated to have been embarrassed and awkward, or, as Adams puts it (*Obs. on Morbid Pois.*, p. 272), "frequently ungraceful," and his language always unadorned; but that his "expressions for the explaining of his new theories rendered his lectures often unintelligible" is scarcely evident in his pupils' notes still extant. His own and others' errors and fallacies were exposed with equal freedom in his teaching. Occasionally he would tell his pupils, "You had better not write down that observation, for very likely I shall think differently next year"; and once in answer to a question he replied, "Never ask me what I have said or what I have written; but, if you will ask me what my present opinions are, I will tell you."

In January 1776 Hunter was appointed surgeon-extraordinary to the king. He began in the same year his Croonian lectures on muscular motion, continued annually, except in 1777, till 1782: they were never published by him, being in his opinion too incomplete. In 1778 appeared the second part of his *Treatise on the Natural History of the Human Teeth*, the first part of which was published in 1771. It was in the waste of the dental alveoli and of the fangs of shedding teeth that in 1754-1755, as he tells us, he received his first hint of the use of the absorbents. Abernethy (*Physiological Lectures*, p. 196) relates that Hunter, being once asked how he could suppose it possible for absorbents to do such things as he attributed to them, replied, "Nay, I know not, unless they possess powers similar to those which a caterpillar exerts when feeding on a leaf." Hunter in 1780 read before the Royal Society a paper in which he laid claim to have been the first to make out the nature of the utero-placental circulation. His brother William, who had five years previously described the same in his *Anatomy of the Gravid Uterus*, thereupon wrote to the Society attributing to himself this honour. John Hunter in a rejoinder to his brother's letter, dated the 17th of February 1780, reiterated his former statement, viz. that his discovery, on the evening of the day in 1754 that he had made it in a specimen injected by a Dr Mackenzie, had been communicated by him to Dr Hunter. Thus arose an estrangement between the two Hunters, which continued until the time of William's last illness, when his brother obtained permission to visit him.

In 1783 Hunter was elected a member of the Royal Society of Medicine and of the Royal Academy of Surgery at Paris, and took part in the formation of "A Society for the Improvement of Medical and Chirurgial Knowledge."¹ It appears from a letter by Hunter that in the latter part of 1783, he, with Jenner, had the subject of colour-blindness under consideration. As in that year the lease of his premises in Jermyn Street was to expire, he purchased the twenty-four years' leasehold of two houses, the one on the east side of Leicester Square, the other in Castle Street with intervening ground. Between the houses he built in 1783-1785, at an expense of above £3000, a museum for his anatomical and other collections which by 1782 had cost him £10,000. The new edifice consisted of a hall 52 ft. long by 28 ft. wide, and lighted from the top, with a gallery all round, and having beneath it a lecture theatre. In April 1785 Hunter's collections were removed into it under the superintendance of Home and William Bell,² and another assistant, André. Among the foreigners of distinction who inspected the museum, which was now shown by Hunter twice a year—in October to medical men, and in May to other visitors—were J. F. Blumenbach, P. Camper and A. Scarpa. In the acquisition of subjects for his varied biological investigations and of specimens for his museum, expense was a matter of small moment with Hunter. Thus he endeavoured, at his own cost, to obtain information respecting the Cetacea by

sending out a surgeon to the North in a Greenland whaler. He is said, moreover, to have given, in June 1783, £500 for the body of O'Brien, or Byrne, the Irish giant, whose skeleton, 7 ft. 7 in. high, is so conspicuous an object in the museum of the College of Surgeons of London.³

Hunter, who in the spring of 1769-1772 had suffered from gout, in spring 1773 from spasms apparently in the pyloric region, accompanied by failure of the heart's action (Ottley, *Life*, p. 44), and in 1777 from vertigo with symptoms of angina pectoris, had in 1783 another attack of the last mentioned complaint, to which he was henceforward subject when under anxiety or excitement of mind.

In May 1785,⁴ chiefly to oblige William Sharp the engraver, Hunter consented to have his portrait taken by Sir Joshua Reynolds. He proved a bad sitter, and Reynolds made little satisfactory progress, till one day Hunter, while resting his somewhat upraised head on his left hand, fell into a profound reverie—one of those waking dreams, seemingly, which in his lectures he has so well described, when "the body loses the consciousness of its own existence."⁵ The painter had now before him the man he would fain depict, and, turning his canvas upside down, he sketched out the admirable portrait which, afterwards skillfully restored by H. Farrar, is in the possession of the Royal College of Surgeons. A copy by Jackson, acquired from Lady Bell, is to be seen at the National Portrait Gallery, and St Mary's Hall, Oxford, also possesses a copy. Sharp's engraving of the original, published in 1788, is one of the finest of his productions. The volumes seen in Reynolds' picture are a portion of the unpublished records of anatomical researches left by Hunter at his death, which, with other manuscripts, Sir Everard Home in 1812 removed from his museum, and eventually, in order, it has been supposed, to keep secret the source of many of his papers in the *Philosophical Transactions*, and of facts mentioned in his lectures, committed to the flames.⁶

Among the subjects of Hunter's physiological investigation in 1785 was the mode of growth of deer's antlers. As he possessed the privilege of making experiments on the deer in Richmond Park, he in July of that year had a buck there caught and thrown, and tied one of its external carotid arteries. He observed that the antler which obtained its blood supply therefrom, then half-grown, became in consequence cold to the touch. Hunter debated with himself whether it would be shed in due time, or be longer retained than ordinarily. To his surprise he found, on re-examining the antler a week or two later, when the wound around the ligatured artery was healed, that it had regained its warmth, and was still increasing in size. Had, then, his operation been in some way defective? To determine this question, the buck was killed and sent to Leicester Fields. On examination Hunter ascertained that the external carotid had been duly tied, but that certain small branches of the artery above and below the ligature had enlarged, and by their anastomoses had restored the blood supply of the growing part. Thus it was evident that under "the stimulus of necessity," to use a phrase of the experimenter, the smaller arterial channels are

¹ O'Brien, dreading dissection by Hunter, had shortly before his death arranged with several of his countrymen that his corpse should be conveyed by them to the sea, and sunk in deep water; but his undertaker, who had entered into a pecuniary compact with the great anatomist, managed that while the escort was drinking at a certain stage on the march seawards, the coffin should be locked up in a barn. There some men he had concealed speedily substituted an equivalent weight of paving-stones for the body, which was at night forwarded to Hunter, and by him taken in his carriage to Earl's Court, and, to avoid risk of a discovery, immediately after suitable division boiled to obtain the bones. See Tom Taylor, *Leicester Square*, ch. xiv. (1874); cf. *Annual Register*, xxvi. 209 (1783).

² See C. R. Leslie and Tom Taylor, *Life and Times of Sir J. Reynolds*, ii. 474 (1865).

³ *Works*, i. 265-266.

⁴ A transcript of a portion of Hunter's MSS., made by Clift in 1793 and 1800, was edited by Sir Richard Owen, in two volumes with notes, in 1861, under the title of *Essays and Observations in Natural History, Anatomy, Physiology, Psychology and Geology*. On the destruction of Hunter's papers see Clift's "Appendix" in vol. ii. p. 497, also W. H. Flower, *Introduct. Lect.*, pp. 7-9 (1870).

¹ The *Transactions* of the Society contain papers by Hunter on inflammation of veins (1784), intussusception (1789), a case of paralysis of the muscles of deglutition (1790), and a case of poisoning during pregnancy (1794), with others written by Home, from materials supplied by him, on Hunter's operation for the cure of popliteal aneurism, on loose cartilages in joints, on certain horny excrescences of the human body, and on the growth of bones.

² Bell lived with Hunter fourteen years, i.e. from 1775 to 1789, and was employed by him chiefly in making and drawing anatomical preparations for the museum. He died in 1792 at Sumatra, where he was assistant-surgeon to the East India Company.

Generation; he told me perhaps it did, and that as to Equivocal Generation all we have was negative Proofs of its not taking Place. He did not deny that Equivocal Generation happened; there were neither positive proofs for nor against its taking place."

To exemplify the differences between organic and inorganic growth, Hunter made and employed in his lectures a collection of crystallized specimens of minerals, or, as he termed them, "natural or native fossils." Of fossils, designated by him "extraneous fossils," because extraneous respecting the rocks in which they occur, he recognized the true nature, and he arranged them according to a system agreeing with that adopted for recent organisms. The study of fossils enabled him to apply his knowledge of the relations of the phenomena of life to conditions, as exhibited in times present, to the elucidation of the history of the earth in geological epochs. He observed the non-occurrence of fossils in granite, but with his customary scientific caution and insight could perceive no reason for supposing it to be the original matter of the globe, prior to vegetable or animal, or that its formation was different from that of other rocks. In water he recognized the chief agent in producing terrestrial changes (cf. *Treatise on the Blood*, p. 15, note); but the popular notion that the Noachian deluge might account for the marine organisms discovered on land he pointed out as untenable. From the diversity of the situations in which many fossils and allied living structures are found, he was led to infer that at various periods not only repeated oscillations of the level of the land, lasting thousands of centuries, but also great climatic variations, perhaps due to a change in the ecliptic, had taken place in geological times. Hunter considered that very few fossils of those that resemble recent forms are identical with them. He conceived that the latter might be varieties, but that if they are really different species, then "we must suppose that a new creation must have taken place." It would appear, therefore, that the origin of species in variation had not struck him as possible. That he believed varieties to have resulted from the influence of changes in the conditions of life in times past is shown by a somewhat obscure passage in his "Introduction to Natural History" (*Essays and Observations*, l. 4), in which he remarks, "But, I think, we have reason to suppose that there was a period of time in which every species of natural production was the same, there being then no variety in any species," and adds that "civilization has made varieties in many species, which are the domesticated." Modern discoveries and doctrines as to the succession of life in time are again foreshadowed by him in the observation in his introduction to the description of drawings relative to incubation (quoted in *Prof. to Cat. of Phys. Ser. i. p. iv.*, 1833) that: "If we were capable of following the progress of increase of the number of the parts of the most perfect animal, as they first formed in succession, from the very first, to its state of full perfection, we should probably be able to compare it with some one of the incomplete animals themselves, of every order of animals in the creation, being at no stage different from some of those inferior orders; or, in other words, if we were to take a series of animals from the more imperfect to the perfect, we should probably find an imperfect animal corresponding with some stage of the most perfect."

In pathological phenomena Hunter discerned the results of the perturbation of those laws of life by which the healthy organism subsists. With him pathology was a science of vital dynamics. He afforded principles bearing not on single complaints only, but on the effects of injury and disease in general. To attempt to set forth what in Hunter's teaching was new to pathology and systematic surgery, or was rendered so by his mode of treatment, would be well-nigh to present an epitome of all that he wrote on those subjects. "When we make a discovery in pathology," says Adams, writing in 1818, "we only learn what we have overlooked in his writings or forgotten in his lectures." Surgery, which only in 1745 had formally ceased to be associated with "the art and mystery of barbers," he raised to the rank of a scientific profession. His doctrines were, necessarily, not those of his age; while lesser minds around him were still dim with the mists of the ignorance and dogmatism of times past, his lofty intellect was illumined by the dawn of a distant day.

AUTHORITIES.—See, besides the above quoted publications, *An Appeal to the present Parliament. . . on the subject of the late J. Hunter's Museum* (1795); Sir C. Bell, *A Lecture. . . being a Commentary on Mr J. Hunter's preparations of the Diseases of the Urethra* (1830); The President of the Royal College of Surgeons of England, *Address to the Committee for the Erection of a Statue of Hunter* (Lond., March 29, 1859); Sir R. Owen, "Sketch of Hunter's Scientific Character and Works," in Tom Taylor's *Lester Square* (1874), also in *Hunter's Works*, ed. by Palmer, vol. iv. (1837), and in *Essays and Observations*; the invaluable catalogues of the Hunterian Collection issued by the Royal College of Surgeons; and numerous Hunterian Orations. In the *Journal of a Voyage to New South Wales*, by John White, is a paper containing directions for preserving animals, printed separately in 1809, besides six zoological descriptions by Hunter, and in the *Natural History of Aleppo*, by A. Russell, are remarks of Hunter's on the anatomy of the jerboa and the camel's stomach. Notes of his lectures on surgery, edited by J. W. K. Parkinson, appeared in 1833 under the title of *Hunterian Reminiscences*. Hunter's *Observations and Reflections on Geology*, intended to serve as an introduction to the catalogue of his collection of extraneous fossils, was published in 1859, and his *Memoranda on Vegetation* in 1860. (F. H. B.)

HUNTER, ROBERT MERCER TALIAFERRO (1809-1887). American statesman, was born in Essex county, Virginia, on the 21st of April 1809. He entered the university of Virginia in his seventeenth year and was one of its first graduates; he then studied law at the Winchester (Va.) Law School, and in 1830 was admitted to the bar. From 1835 to 1837 he was a member of the Virginia house of delegates; from 1837 to 1843 and from 1845 to 1847 was a member of the national house of representatives, being Speaker from 1839 to 1841; and from 1847 to 1861 he was in the senate, where he was chairman of the finance committee (1850-1861). He is credited with having brought about a reduction of the quantity of silver in the smaller coins; he was the author of the Tariff Act of 1857 and of the bonded-warehouse system, and was one of the first to advocate civil service reform. In 1853 he declined President Fillmore's offer to make him secretary of state. At the National Democratic Convention at Charleston, S.C., in 1860 he was the Virginia delegation's choice as candidate for the presidency of the United States, but was defeated for the nomination by Stephen A. Douglas. Hunter did not regard Lincoln's election as being of itself a sufficient cause for secession, and on the 11th of January 1861 he proposed an elaborate but impracticable scheme for the adjustment of differences between the North and the South, but when this and several other efforts to the same end had failed he quietly urged his own state to pass the ordinance of secession. From 1861 to 1862 he was secretary of state in the Southern Confederacy; and from 1862 to 1865 was a member of the Confederate senate, in which he was, at times, a caustic critic of the Davis administration. He was one of the commissioners to treat at the Hampton Roads Conference in 1865 (see LINCOLN, ABRAMAM), and after the surrender of General Lee was summoned by President Lincoln to Richmond to confer regarding the restoration of Virginia in the Union. From 1874 to 1880 he was treasurer of Virginia, and from 1885 until his death near Lloyds, Virginia, on the 18th of July 1887, was collector of the Port of Tappahannock, Virginia.

See Martha T. Hunter, *A Memoir of Robert M. T. Hunter* (Washington, 1903) for his private life, and D. R. Anderson, *Robert Mercer Taliaferro Hunter*, in the John P. Branch Historical Papers of Randolph Macon College (vol. ii. No. 2, 1906), for his public career.

HUNTER, WILLIAM (1718-1783), British physiologist and physician, the first great teacher of anatomy in England, was born on the 23rd of May 1718, at East Kilbride, Lanark. He was the seventh child of his parents, and an elder brother of the still more famous John Hunter (q.v.). When fourteen years of age, he was sent to the university of Glasgow, where he studied for five years. He had originally been intended for the church, but, scruples concerning subscription arising in his mind, he followed the advice of his friend William Cullen, and resolved to devote himself to physic. During 1737-1740 he resided with Cullen at Hamilton, and then, to increase his medical knowledge before settling in partnership with his friend, he spent the winter of 1740-1741 at Edinburgh. Thence he went to London, where Dr James Douglas (1675-1742), an anatomist and obstetrician of some note, to whom he had been recommended, engaged his services as a tutor to his son and as a dissector, and assisted him to enter as a surgeon's pupil at St George's Hospital and to procure the instruction of the anatomist Frank Nicholls (1699-1778). When Dr Douglas died Hunter still continued to live with his family. In 1746 he undertook, in place of Samuel Sharp, the delivery, for a society of naval practitioners, of a series of lectures on operative surgery, so satisfactorily that he was requested to include anatomy in his course. It was not long before he attained considerable fame as a lecturer; for not only was his oratorical ability great, but he differed from his contemporaries in the fullness and thoroughness of his teaching, and in the care which he took to provide the best possible practical illustrations of his discourses. We read that the *syllabus* of Edward Nourse (1701-1761), published in 1748, *totam rem anatomicam complectens*, comprised only twenty-three lectures, exclusive of a short and defective "Syllabus Chirurgicus," and that at "one of the most reputable courses of anatomy in

Europe," which Hunter had himself attended, the professor was obliged to demonstrate all the parts of the body, except the nerves and vessels (shown in a foetus) and the bones, on a single dead subject, and for the explanation of the operations of surgery used a dog! In 1747 Hunter became a member of the Corporation of Surgeons. In the course of a tour through Holland to Paris with his pupil, J. Douglas, in 1728, he visited Albinus at Leiden, and inspected with admiration his injected preparations. By degrees Hunter renounced surgical for obstetric practice, in which he excelled. He was appointed a surgeon-accoucheur at the Middlesex Hospital in 1748, and at the British Lying-in Hospital in the year following. The degree of M.D. was conferred upon him by the university of Glasgow on the 24th of October 1750. About the same time he left his old abode at Mrs Douglas's, and settled as a physician in Jernyn Street. He became a licentiate of the College of Physicians on the 30th of September 1756. In 1762 he was consulted by Queen Charlotte, and in 1764 was made physician-extraordinary to her Majesty.

On the departure of his brother John for the army, Hunter engaged as an assistant William Hewson (1739-1774), whom he subsequently admitted to partnership in his lectures. Hewson was succeeded in 1770 by W. C. Cruikshank (1745-1800). Hunter was elected F.R.S. in 1767; F.S.A. in 1768, and third professor of anatomy to the Royal Academy of Arts; and in 1780 and 1782 respectively an associate of the Royal Medical Society and of the Royal Academy of Sciences of Paris. During the closing ten years of his life his health failed greatly. His last lecture, at the conclusion of which he fainted, was given, contrary to the remonstrances of friends, only a few days before his death, which took place in London on the 30th of March 1783. He was buried in the rector's vault at St James's, Piccadilly.

Hunter had in 1765 requested of the prime minister, George Grenville, the grant of a plot of ground on which he might establish "a museum in London for the improvement of anatomy, surgery, and physics" (see "Papers" at end of his *Two Introductory Lectures*, 1784), and had offered to expend on its erection £7000, and to endow in perpetuity a professorship of anatomy in connexion with it. His application receiving no recognition, he after many months abandoned his scheme, and built himself a house, with lecture and dissecting-rooms, in Great Windmill Street, whither he removed in 1770. In one fine apartment in this house was accommodated his collection, comprising anatomical and pathological preparations, ancient coins and medals, minerals, shells and corals. His natural history specimens were in part a purchase, for £1200, of the executors of his friend, Dr John Fothergill (1712-1780). Hunter's whole collection, together with his fine library of Greek and Latin classics, and an endowment of £8000, by his will became, after the lapse of twenty years, the property of the university of Glasgow.

Hunter was never married, and was a man of frugal habits. Like his brother John, he was an early riser, and a man of untiring industry. He is described as being in his lectures, which were of two hours' duration, "both simple and profound, minute in demonstration, and yet the reverse of dry and tedious"; and his mode of introducing anecdotal illustrations of his topic was most happy. Lecturing was to him a pleasure, and, notwithstanding his many professional distractions, he regularly continued it, because, as he said, he "conceived that a man may do infinitely more good to the public by teaching his art than by practising it" (see "Memorial" appended to *Introd. Lect.* p. 120).

Hunter was the author of several contributions to the *Medical Observations and Enquiries* and the *Philosophical Transactions*. In his paper on the structure of cartilages and joints, published in the latter in 1743, he anticipated what M. F. X. Bichat sixty years afterwards wrote concerning the structure and arrangement of the synovial membranes. His *Medical Commentaries* (pt. i., 1762, supplemented 1764) contains, among other like matter, details of his disputes with the Monros as to who first had successfully performed the injection of the *tubuli testis* (in which, however, both he and they had been forestalled by A. von Haller in 1745), and as to who had discovered the true office of the lymphatics, and also a discussion on the question whether he or Percival Pott ought to be considered the

earliest to have elucidated the nature of *hernia congenita*, which, as a matter of fact, had been previously explained by Haller. In the *Commentaries* is exhibited Hunter's one weakness—an inordinate love of controversy. His impatience of contradiction he averred to be a characteristic of anatomists, in whom he once jocularly condoned it, on the plea that "the passive submission of dead bodies" rendered the crossing of their will the less bearable. His great work, *The Anatomy of the Gravid Uterus, exhibited in Figures*, fol., was published in 1774. His posthumous works are *Two Introductory Lectures* (1784), and *Anatomical Description of the Human Gravid Uterus* (1794), which was re-edited by Dr E. Rigby in 1843.

See *Gen. Mag.* hi., pt. 1, p. 364 (1783); S. F. Simmons: *An Account of the Life of W. Hunter* (1783); Adams's and Otley's *Lives of J. Hunter*; Sir B. C. Brodie, *Hunterian Oration* (1837); W. Munk, *The Roll of the Royal College of Physicians of London*, ii. 205 (1878). (F. H. B.)

HUNTER, WILLIAM ALEXANDER (1844-1898), Scottish jurist and politician, was born in Aberdeen on the 8th of May 1844, and educated at Aberdeen grammar school and university. He entered the Middle Temple, and was called to the English bar in 1867, but then was occupied mainly with teaching. In 1869 he was appointed professor of Roman law at University College, London, and in 1878 professor of jurisprudence, resigning that chair in 1882. His name became well known during this period as the author of a standard work on Roman law, *Roman Law in the Order of a Code*, together with a smaller introductory volume for students, *Introduction to Roman Law*. After 1882 Hunter took up politics and was elected to parliament for Aberdeen as a Liberal in 1885. In the House of Commons he was a prominent supporter of Charles Bradlaugh; he was the first to advocate old age pensions, and in 1890 carried a proposal to free elementary education in Scotland. In 1895 his health broke down; he retired from parliament in 1896 and died on the 21st of July 1898.

HUNTER, SIR WILLIAM WILSON (1840-1900), British publicist, son of Andrew Galloway Hunter, a Glasgow manufacturer, was born at Glasgow on the 15th of July 1840. He was educated at Glasgow University (B.A. 1860), Paris and Bonn, acquiring a knowledge of Sanscrit, and passing first in the final examination for the Indian Civil Service in 1862. Posted in the remote district of Birbhum in the lower provinces of Bengal, he began collecting local traditions and records, which formed the materials for his novel and suggestive publication, entitled *The Annals of Rural Bengal*, a book which did much to stimulate public interest in the details of Indian administration. He also compiled *A Comparative Dictionary of the Non-Aryan Languages of India*, a glossary of dialects based mainly upon the collections of Brian Houghton Hodgson, which testifies to the industry of the writer but contains much immature philological speculation. In 1872 he brought out two attractive volumes on the province of Orissa and its far-famed temple of Jagannath. In 1869 Lord Mayo asked Hunter to submit a scheme for a comprehensive statistical survey of the Indian empire. The work involved the compilation of a number of local gazetteers, in various stages of progress, and their consolidation in a condensed form upon a single and uniform plan. The conception was worthy of the gigantic projects formed by Arthur Young and Sir John Sinclair at the close of the 18th century, and the fact that it was successfully carried through between 1869 and 1881 was owing mainly to the energy and determination of Hunter. The early period of his undertaking was devoted to a series of tours which took him into every corner of India. He himself undertook the supervision of the statistical accounts of Bengal (20 vols., 1875-1877) and of Assam (2 vols., 1879). The various statistical accounts, when completed, comprised no fewer than 128 volumes. The immense task of condensing this mass of material proceeded concurrently with their compilation, an administrative feat which enabled *The Imperial Gazetteer of India* to appear in 9 volumes in 1881 (2nd ed., 14 vols., 1885-1887; 3rd ed., 26 vols., including atlas, 1908). Hunter adopted a transliteration of vernacular place-names, by which means the correct pronunciation is ordinarily indicated; but hardly sufficient allowance was made for old spellings consecrated by history and long usage. Hunter's own article on India was published in 1880 as *A Brief History of the Indian Peoples*, and

has been widely translated and utilized in Indian schools. A revised form was issued in 1895, under the title of *The Indian Empire: its People, History and Products*. In 1882 Hunter, as a member of the governor-general's council, presided over the commission on Indian Education; in 1886 he was elected vice-chancellor of the university of Calcutta. In 1887 he retired from the service, was created K.C.S.I., and settled at Oaken Holt, near Oxford. He arranged with the Clarendon Press to publish a series of *Rulers of India*, to which he himself contributed volumes on Dalhousie (1890) and Mayo (1892). He had previously, in 1875, written an official *Life of Lord Mayo*, in two volumes. He also wrote a weekly article on Indian affairs for *The Times*. But the great task to which he applied himself on his settlement in England was a history upon a large scale of the *British Dominion in India*, two volumes of which only had appeared when he died, carrying the reader barely down to 1700. He was much hindered by the confused state of his materials, a portion of which he arranged and published in 1894 as *Bengal Manuscript Records*, in three volumes. A delightful story, *The Old Missionary* (1895), and *The Thackerays in India* (1897), a gossipy volume which appeals to all readers of *The Newcomes*, may be regarded as the relaxations of an Anglo-Indian amid the stress of severer studies. In the winter of 1898-1899, in consequence of the fatigue incurred in a journey to the Caspian and back, on a visit to the sick-bed of one of his two sons, Hunter was stricken down by a severe attack of influenza, which affected his heart. He died at Oaken Holt on the 6th of February 1900.

HUNTING (the verbal substantive from "hunt"; O. Eng. *hunan*, *huna*; apparently connected with O. Eng. *hentan*, Gothic *hinspan*, to capture, O.H.G. *hunda*, booty), the pursuit of game and wild animals, for profit or sport; equivalent to "chase" (like "catch," from Lat. *captare*, Fr. *chasse*, Ital. *caccia*). The circumstances which render necessary the habitual pursuit of wild animals, either as a means of subsistence or for self-defence, generally accompany a phase of human progress distinctly inferior to the pastoral and agricultural stages; resorted to as a recreation, however, the practice of the chase in most cases indicates a considerable degree of civilization, and sometimes ultimately becomes the almost distinctive employment of the classes which are possessed of most leisure and wealth. It is in some of its latter aspects, viz. as a "sport," pursued on fixed rules and principles, that hunting is dealt with here.

Information as to the field sports of the ancients is in many directions extremely fragmentary. With regard to the ancient Egyptians, however, we learn that the huntsmen constituted an entire sub-division of the great second caste; they either followed the chase on their own account, or acted as the attendants of the chiefs in their hunting excursions, taking charge of the dogs, and securing and bringing home the game. The game was sought in the open deserts which border on both sides the valley of the Nile; but (by the wealthy) sometimes in enclosed spaces into which the animals had been driven or in preserves. Besides the noose and the net, the arrow, the dart and the hunting pole or *venabulum* were frequently employed. The animals chiefly hunted were the gazelle, ibex, oryx, stag, wild ox, wild sheep, hare and porcupine; also the ostrich for its plumes, and the fox, jackal, wolf, hyaena and leopard for their skins, or as enemies of the farm-yard. The lion was occasionally trained as a hunting animal instead of the dog. The sportsman appears, occasionally at least, in the later periods, to have gone to cover in his chariot or on horseback; according to Wilkinson, when the dogs threw off in a level plain of great extent, it was even usual for him "to remain in his chariot, and, urging his horses to their full speed, endeavour to turn or intercept them as they doubled, discharging a well-directed arrow whenever they came within its range."¹ The partiality for the chase which the ancient Egyptians manifested was shared by the Assyrians and Babylonians, as is shown by the frequency with which hunting scenes are depicted on the walls of their temples and palaces; it is even said that their

¹ See on this whole subject ch. viii. of Wilkinson's *Ancient Egyptians* (ii. 78-92, ed. Birch, 1878).

dresses and furniture were ornamented with similar subjects.¹ The game pursued included the lion, the wild ass, the gazelle and the hare, and the implements chiefly employed seem to have been the javelin and the bow. There are indications that hunting was also known. The Assyrian kings also maintained magnificent parks, or "paradises," in which game of every kind was enclosed; and perhaps it was from them that the Persian sovereigns borrowed the practice mentioned both by Xenophon in the *Cyropaedia* and by Curtius. According to Herodotus, Cyrus devoted the revenue of four great towns to meet the expenses of his hunting establishments. The circumstances under which the death of the son of Croesus is by the same writer (i. 34-45) related to have occurred, incidentally show in what high estimation the recreation of hunting was held in Lydia. In Palestine game has always been plentiful, and the Biblical indications that it was much sought and duly appreciated are numerous. As means of capture, nets, traps, snares and pitfalls are most frequently alluded to; but the arrow (Isa. vii. 24), the spear and the dart (Job. xli. 26-29) are also mentioned. There is no evidence that the use of the dog (Jos. *Ant.* iv. 8, 10, notwithstanding) or of the horse in hunting was known among the Jews during the period covered by the Old Testament history; Herod, however, was a keen and successful sportsman, and is recorded by Josephus (*B.J.* i. 21, 13, compare *Ant.* xv. 7, 7; xvi. 10, 3) to have killed no fewer than forty head of game (boar, wild ass, deer) in one day.

The sporting tastes of the ancient Greeks, as may be gathered from many references in Homer (*Il.* ix. 538-545; *Od.* ix. 120, xvii. 295, 316, xix. 429 seq.), had developed at a very early period; they first found adequate literary expression in the work of Xenophon entitled *Cynegeticus*,² which expounds his principles and embodies his experience in his favourite art of hunting. The treatise chiefly deals with the capture of the hare; in the author's day the approved method was to find the hare in her form by the use of dogs; when found she was either driven into nets previously set in her runs or else run down in the open. Boar-hunting is also described; it was effected by nets into which the animal was pursued, and in which when fairly entangled he was speared. The stag, according to the same work, was taken by means of a kind of wooden trap (*ροδοσπάθην*), which attached itself to the foot. Lions, leopards, lynxes, panthers and bears are also specially mentioned among the large game; sometimes they were taken in pitfalls, sometimes speared by mounted horsemen. As a writer on field sports Xenophon was followed by Arrian, who in his *Cynegeticus*, in avowed dependence on his predecessor, seeks to supplement such deficiencies in the earlier treatise as arose from its author's unacquaintance with the dogs of Gaul and the horses of Scythia and Libya. Four books of *Cynegetica*, extending to about 2100 hexameters, by Oppian have also been preserved; the last of these is incomplete, and it is probable that a fifth at one time existed. The poem contains some good descriptive passages, as well as some very curious indications of the state of zoological knowledge in the author's time. Hunting scenes are frequently represented in ancient works of art, especially the boar-hunt, and also that of the hare. In Roman literature allusions to the pleasures of the chase (wild ass, boar, hare, fallow deer being specially mentioned as favourite game) are not wanting (*Virg. Georg.* iii. 409-413; *Ed.* iii. 75; *Hor. Od.* i. 1, 25-28); it seems to have been viewed, however, with less favour as an occupation for gentlemen, and to have been chiefly left to inferiors and professionals. The immense *vivaria* or *theriotrophia*, in which various wild animals, such as boars, stags and roe-deer, were kept in a state of semi-domestication, were developments which arose at a comparatively late period; as also were the *venationes* in the circus, although these are mentioned as having been known as early as 186 B.C. The bald and meagre poem of Grattius Faliscus on hunting (*Cynegetica*) is modelled upon Xenophon's prose work; a still extant fragment (315 lines) of a similar poem with the same title, of much later date, by Nemesianus, seems to have at one

² See Layard (*Niniveh*, ii. 431, 432), who cites Ammian. Marcell. xxvi. 6, and Athen. xii. 9. ³ Engl. transl. by Blane.

time formed the introduction to an extended work corresponding to that of Oppian.

That the Romans had borrowed some things in the art of hunting from the Gauls may be inferred from the name *canis gallicus* (Spanish *galgo*) for a greyhound, which is to be met with both in Ovid and Martial; also in the words (*canis*) *verbragus* and *segusius*, both of Celtic origin.¹ According to Strabo (p. 200) the Britons also bred dogs well adapted for hunting purposes. The addiction of the Franks in later centuries to the chase is evidenced by the frequency with which not only the laity but also the clergy were warned by provincial councils against expending so much of their time and money on hounds, hawks and falcons; and we have similar proof with regard to the habits of other Teutonic nations subsequent to the introduction of Christianity.² Originally among the northern nations sport was open to every one³ except to slaves, who were not permitted to bear arms; the growth of the idea of game-preserving kept pace with the development of feudalism. For its ultimate development in Britain see FOREST LAW, where also the distinction between beasts of forest or venery, beasts of chase and beasts and fowls of warren is explained. See also GAME LAWS.

Modern Hunting.—The term "hunting" has come to be applied specially to the pursuit of such quarry as the stag or fox, or to following an artificially laid scent, with horse and hound. It thus corresponds to the Fr. *chasse au courre*, as distinguished from *chasse au tir*, & *Poiseau*, &c., and to the Ger. *hadjagd* as distinguished from *birsch*. In the following article the English practice is mainly considered.

Doubtless the early inhabitants of Britain shared to a large extent in the habits of the other Celtic peoples; the fact that they kept good hunting dogs is vouched for by Strabo; and an interesting illustration of the manner in which these were used is given in the inscription quoted by Orelli (n. 1603)—"Silvano Invicto Sacrum—ob aprum eximiae formae captum, quem multi antecessores praedari non potuerunt." Asser, the biographer of Alfred the Great, states that before the prince was twelve years of age he "was a most expert and active hunter, and excelled in all the branches of that noble art, to which he applied with incessant labour and amazing success."⁴ Of his grandson Athelstan it is related by William of Malmesbury that after the victory of Brunanburgh he imposed upon the vanquished king of Wales a yearly tribute, which included a certain number of "hawks and sharp-scented dogs fit for hunting wild beasts." According to the same authority, one of the greatest delights of Edward the Confessor was "to follow a pack of swift hounds in pursuit of game, and to cheer them with his voice." It was under the Anglo-Saxon kings that the distinction between the higher and lower chase first came to be made—the former being expressly for the king or those on whom he had bestowed the pleasure of sharing in it, while only the latter was allowed to the proprietors of the land. To the reign of Cnut belong the "Constitutiones de Foresta," according to which four thanes were appointed in every province for the administration of justice in all matters connected with the forests; under them were four inferior thanes to whom was committed immediate care of the vert and venison.⁵ The severity of the forest laws which prevailed during the Norman period is sufficient evidence of the sporting ardour of William and his successors. The Conqueror himself "loved the high game as if he were their father"; and the penalty for the unauthorized slaughter of a hart or hind was loss of both eyes.

¹ Hehn, *Kulturpflanzen u. Haustihere*, p. 327.

² References will be found in Smith's *Dictionary of Christian Antiquities*—art. on "Hunting."

³ "Vita omnis in venationibus . . . consistit." Caes. B.G., vi. 21.

⁴ "Quoties bella non ineunt, multum venatibus, plus per otium transigunt." Tacitus, *Germania*, 15.

⁵ See Strutt, *Sports and Pastimes*, who also gives an illustration, "taken from a manuscript painting of the 9th century in the Cotton Library," representing "a Saxon chieftain, attended by his huntsman and a couple of hounds, pursuing the wild swine in a forest."

⁶ See Lappenberg, *Hist. of England under the Anglo-Saxon Kings* (ii. 361, Thorpe's trans.).

At an early period stag hunting was a favourite recreation with English royalty. It seems probable that in the reign of Henry VIII. the royal pack of buckhounds was kennelled at Swinley, where, in the reign of Charles II. (1684), a Stag-hunting deer was found that went away to Lord Petre's seat in Essex; only five got to the end of this 70 m. run, one being the king's brother, the duke of York. George III. was a great stag hunter, and met the royal pack as often as possible.

In *The Chase of the Wild Red Deer*, Mr Collyns says that the earliest record of a pack of staghounds in the Exmoor district is in 1508, when Hugh Pollard, Queen Elizabeth's ranger, kept one at Simonsbath. The succeeding rangers of Exmoor forest kept up the pack until some 200 years ago, the hounds subsequently passing into the possession of Mr Walter of Stevenstone, an ancestor of the Rolle family. Successive masters continued the sport until 1825, when the fine pack, descended probably from the bloodhound crossed with the old southern hound, was sold in London. It is difficult to imagine how the dispersion of such a pack could have come about in such a sporting country, but in 1827 Sir Arthur Chichester got a pack together again. Stag hunting begins on the 12th of August, and ends on the 8th of October; there is then a cessation until the end of the month, when the hounds are unkenelled for hind hunting, which continues up to Christmas; it begins again about Ladyday, and lasts till the 20th of May. The mode of hunting with the Devon and Somerset hounds is briefly this: the whereabouts of a warrantable stag is communicated to the master by that important functionary the harbourer; two couple of steady hounds called tufters are then thrown into cover, and, having singled out a warrantable deer, follow him until he is forced to make for the open, when the body of the pack are laid on. Very often two or three hours elapse before the stag breaks, but a run over the wild country fully atones for the delay.

It is only within comparatively recent times that the fox has come to be considered as an animal of the higher chase. William Twiss, indeed, who was huntsman-in-chief to Edward II., and who wrote in Norman French a treatise on hunting,⁶ mentions the fox as a beast of venery, but obviously as an altogether inferior object of sport. Strutt also gives an engraving, assigned by him to the 14th century, in which three hunters, one of whom blows a horn, are represented as unearthing a fox, which is pursued by a single hound. The precise date of the establishment of the first English pack of hounds kept entirely for fox hunting cannot be accurately fixed. In the work of "Nimrod" (C. J. Apperley), entitled *The Chase*, there is (p. 4) an extract from a letter from Lord Arundel, dated February 1833, in which the writer says that his ancestor, Lord Arundel, kept a pack of foxhounds between 1600 and 1700, and that they remained in the family till 1782, when they were sold to the celebrated Hugh Meynell, of Quorndon Hall, Leicestershire. Lord Wilton again, in his *Sports and Pursuits of the English*, says that "about the year 1750 hounds began to be entered solely to fox." The *Field* of November 6, 1875, p. 512, contains an engraving of a hunting-horn then in the possession of the late master of the Cheshire hounds, and upon the horn is the inscription:—"Thomas Boothby, Esq., Tooley Park, Leicester. With this horn he hunted the first pack of foxhounds then in England fifty-five years. Born 1677. Died 1752. Now the property of Thomas d'Avenant, Esq., county Salop, his grandson." These extracts do not finally decide the point, because both Mr Boothby's and Lord Arundel's hounds may have hunted other game besides fox, just as in Edward IV.'s time there were "fox dogs" though not kept exclusively for fox. On the whole, it is probable that Lord Wilton's surmise is not far from correct. Since fox hunting first commenced, however, the system of the sport has been much changed. In our great-grandfathers' time the hounds met early, and found the fox by the drag, that is, by the line he took to his kennel on his return from a foraging expedition. Hunting the

⁶ *La Art de venerie*, translated with preface and notes by Sir Henry Dryden (1803), new edition by Miss A. Dryden (1909), including *The Craft of Venerie* from a 15th-century MS. and a 13th-century poem *La Chasse d'on cery*.

drag was doubtless a great test of nose, but many good runs must have been lost thereby, for the fox must often have heard the hounds upwind, and have moved off before they could get on good terms with him. At the present day, the woodlands are neither so large nor so numerous as they formerly were, while there are many more gorse covers; therefore, instead of hunting the drag up to it, a much quicker way of getting to work is to find a fox in his kennel; and, the hour of the meeting being later, the fox is not likely to be gorged with food, and so unable to take care of himself at the pace at which the modern foxhound travels.

Cub hunting carried out on a proper principle is one of the secrets of a successful season. To the man who cares for hunting, as distinct from riding, September and October are not the least enjoyable months of the whole hunting season. As soon as the young entry have recovered from the operation of "rounding," arrangements for cub hunting begin. The hounds must have first of all walking, then trotting and fast exercise, so that their feet may be hardened, and all superfluous fat worked off by the last week in August. So far as the hounds are concerned, the object of cub hunting is to teach them their duty; it is a dress rehearsal of the November business. In company with a certain proportion of old hounds, the youngsters learn to stick to the scent of a fox, in spite of the fondness they have acquired for that of a hare, from running about when at walk. When cubbing begins, a start is made at 4 or 5 A.M., and then the system is adopted of tracking the cub by his drag. A certain amount of blood is of course indispensable for hounds, but it should never be forgotten that a fox cub of seven or eight months old, though tolerably cunning, is not so very strong; the huntsman should not, therefore, be over-eager in bringing to hand every cub he can find.

Hare hunting, which must not be confounded with Coursing (q.v.), is an excellent school both for men and for horses. It is attended with the advantages of being cheaper than any other kind, and of not needing so large an area of country. Hare hunting requires considerable skill; Beckford even goes so far as to say: "There is more of true hunting with harriers than with any other description of hounds. . . . In the first place, a hare, when found, generally describes a circle in her course which naturally brings her upon her foil, which is the greatest trial for hounds. Secondly, the scent of the hare is weaker than that of any other animal we hunt, and, unlike some, it is always the worse the nearer she is to her end." Hare hunting is essentially a quiet amusement; no hallooing at hounds nor whip-cracking should be permitted; nor should the field make any noise when a hare is found, for, being a timid animal, she might be headed into the hounds' mouths. Capital exercise and much useful knowledge are to be derived by running with a pack of beagles. There are the same difficulties to be contended with as in hunting with the ordinary harrier, and a very few days' running will teach the youthful sportsman that he cannot run at the same pace over sound ground and over a deep ploughed field, up hill and down, or along and across furrows.

Otter hunting, which is less practised now than formerly, begins just as all other hunting is drawing to a close. When the waterside is reached an attempt is made to hit

upon the track by which the otter passed to his "couch," which is generally a hole communicating with the river, into which the otter often dives on first hearing the hounds. When the otter "vents" or comes to the surface to breathe, his muzzle only appears above water, and when he is viewed or traced by the mud he stirs up, or by air bubbles, the hounds are laid on. Notwithstanding the strong scent of the otter, he often escapes the hounds, and then a cast has to be made. When he is viewed an attempt is made to spear him by any of the field who may be within distance; if their spears miss, the owners must wade to recover them. Should the otter be transfixed by a spear, the person who threw it goes into the water and raises the game over his head on the spear's point. If instead of being speared, he is caught by the hounds, he is soon worried to death by them, though frequently not before he has inflicted some severe wounds on one or more of the pack.

When railways were first started in England dismal prophecies were made that the end of hunting would speedily be brought about. The result on the whole has been the reverse.

While in some counties the sport has suffered, towns-^{Packs}men who formerly would have been too far from a meet can now secure transport for themselves and their horses in all directions, and as a consequence, meets of certain packs are not advertised because of the number of strangers who would be induced to attend. The sport has never been so vigorously pursued as it was at the beginning of the 20th century, 19 packs of staghounds being kept in England and 4 in Ireland, over 170 packs of foxhounds in England, 10 in Scotland and 23 in Ireland, with packs of harrier and beagles too numerous to be counted. The chase of the wild stag is carried on in the west country by the Devon and Somerset hounds, which hunt three or four days a week from kennels at Dunster; by the Quantock; and by a few other local packs. In other parts of England staghound packs are devoted to the capture of the carted deer, a business which is more or less of a parody on the genuine sport, but is popular for the reason that whereas with foxhounds men may have a blank day, they are practically sure of a gallop when a deer is taken out in a cart to be enlarged before the hounds are laid on. Complaints are often raised about the cruelty of what is called tame stag hunting, and it became a special subject of criticism that a pack should still be kept at the Royal kennels at Ascot (it was abolished in 1901) and hunted by the Master of the Buckhounds; but it is the constant endeavour of all masters and hunt servants to prevent the infliction of any injury on the deer. Their efforts in this direction are seldom unsuccessful; and it appears to be a fact that stags which are hunted season after season come to understand that they are in no grave danger. Packs of foxhounds vary, from large establishments in the "Shires," the meets of which are attended by hundreds of horsemen, some of whom keep large stables of hunters in constant work—for though a man at Melton, for instance, may see a great deal of sport with half-a-dozen well-seasoned animals, the number is not sufficient if he is anxious to be at all times well mounted—to small kennels in the north of England, where the field follow on foot. The "Shires" is a recognized term, but is nevertheless somewhat vague. The three counties included in the expression are Leicestershire, Rutlandshire and Northamptonshire. Several packs which hunt within these limits are not supposed, however, to belong to the "Shires," whereas a district of the Belvoir country is in Lincolnshire, and to hunt with the Belvoir is certainly understood to be hunting in the "Shires." The Shire hounds include the Belvoir, the Cottesmore, the Quorn and the Pytchleys; for besides the Pytchley proper, there is a pack distinguished as the Woodland. It is generally considered that the cream of the sport lies here, but with many of the packs which are generally described as "provincial" equally good hunting may be obtained. Round about London a man who is bent on the pursuit of fox or stag may gratify his desire in many directions. The Essex and the Essex Union, the Surrey and the Surrey Union, the Old Berkeley, the West Kent, the Burstow, the Hertfordshire, the Crawley and Horsham, the Puckeridge, as regards foxhounds; the Berkhamstead, the Enfield Chase, Lord Rothschild's, the Surrey, the West Surrey and the Warnham, as regards staghounds—as well as the Bucks and Berks, which was substituted for the Royal Buckhounds—are within easy reach of the capital.

Questions are constantly raised as to whether horse and hounds have improved or deteriorated in modern times. It is probable that the introduction of scientific agriculture has brought about an increase of pace. Hounds hunt as well as ever they did, are probably faster on the whole, and in the principal hunts more thoroughbred horses are employed. For pace and endurance no hunter approaches the English thoroughbred; and for a bold man who "means going," a steeplechase horse is often the best animal that could be obtained, for when he has become too slow to win races "between the flags," he can always gallop much faster, and usually lasts much longer, than animals who have not his advantage of blood. The quondam "chaser" is, how-^{Modern horses and hounds.}

ever, usually apt to be somewhat impetuous at his fences. But it must by no means be supposed that every man who goes out hunting desires to gallop at a great pace and to jump formidable obstacles, or indeed any obstacles at all. A large proportion of men who follow hounds are quite content to do so passively through gates and gaps, with a canter along the road whenever one is available. A few of the principal packs hunt five days a week, and sometimes even six, and for such an establishment not fewer than seventy-five couples of hounds are requisite. A pack which hunts four days a week will be well supplied with anything between fifty and sixty couples, and for two days a week from twenty-five to thirty will suffice. The young hound begins cub-hunting when he is some eighteen months old, and as a rule is found to improve until his third or fourth season, though some last longer than this. Often, however, when a hound is five or six years old he begins to lack speed. Exceptional animals naturally do exceptional things, and a famous hound called Potentate is recorded by the 8th duke of Beaufort to have done notable service in the hunting field for eleven seasons.

Servants necessary for a pack include the huntsman, the duties of whose office a master sometimes fulfils himself; two whippers-in, an earth-stopper and often a kennel huntsman is also employed, though the 18th Lord Willoughby de Broke (d. 1902), a great authority, laid it down that "the man who hunts the hounds should always feed them." In all but the largest establishments the kennel huntsman is generally called the "feeder." It is his business to look after the pack which is not hunting, to walk them out, to prepare the food for the hunting pack so that it is ready when they return, and in the spring to attend to the wants of the matrons and whelps. A kennel huntsman proper may be described as the man who does duty when the master hunts his own hounds, undertaking all the responsibilities of the huntsman except actually hunting the pack. It may be said that the first duty of a huntsman is to obtain the confidence of his hounds, to understand them and to make himself understood; and the intelligence of hounds is remarkable. If, for example, it is the habit of the huntsman to give a single note on his horn when hounds are drawing a covert, and a double note when a fox is found, the pack speedily understand the significance. The mysteries of scent are certainly no better comprehended now than they were more than a hundred years ago when Peter Beckford wrote his *Thoughts on Hunting*. The subject of scent is full of mysteries. The great authority already quoted, the 8th duke of Beaufort, noted as a very extraordinary but well-known fact, for example, "that in nine cases out of ten if a fox is coursed by a dog during a run all scent ceases afterwards, even when you get your hounds to the line of the fox beyond where the dog has been." This is one of many phenomena which have always remained inexplicable. The duties of the whipper-in are to a great extent explained by his title. Whilst the huntsman is drawing the cover the whipper-in is stationed at the spot from which he can best see what is going on, in order to view the fox away; and it is his business to keep the hounds together when they have found and got away after the fox. There are many ways in which a whipper-in who is not intelligent and alert may spoil sport; indeed, the duke of Beaufort went so far as to declare that "in his experience, with very few exceptions, nine days out of ten that the whipper-in goes out hunting he does more harm than good." In woodland countries, however, a good whipper-in is really of almost as much importance as the huntsman himself; if he is not alert the hounds are likely to divide, as when running a little wide they are apt to put up a fresh fox. The earth-stopper "stops out" and "puts to"—the first expression signifying blocking, during the night, earths and drains to which foxes resort, the second performing the same duties in the morning so as to prevent the fox from getting to ground when he has been found. In the interests of humanity care should be taken that the earth-stopper always has with him a small terrier, as it is often necessary to "stop-out" permanently; and unless a dog is run through the drain some unfortunate creature in it, a fox, cat or rabbit, may be imprisoned

and starved to death. This business is frequently performed by a gamekeeper, a sum being paid him for any litter of cubs or fox found on his beat.

With regard to the expenses of hunting, it is calculated that a master of hounds should be prepared to spend at the rate of £500 a year for every day in the week that his hounds are supposed to hunt. Taking one thing with another, ^{Cost of hunting.} this is probably rather under than over the mark, and the cost of hunting three days a week, if the thing be really properly done, will most likely be nearer £2000 than £1500. The expenses to the individual naturally vary so much that no figures can be given. As long ago as 1826 twenty-seven hunters and hacks were sold for 7500 guineas, an average of over £290; and when Lord Stamford ceased to hunt the Quorn in 1853, seventy-three of his horses fetched at auction an average of close on £200. Early in the 19th century, when on the whole horses were much cheaper than they are at present, 700 and 800 guineas are prices recorded as having been occasionally paid for hunters of special repute. A man may see some sport on an animal that cost him £40; others may consider it necessary to keep an expensive establishment at Melton Mowbray or elsewhere in the Shires, with a dozen or more 500-guinea hunters, some covert-hacks, and a corresponding staff of servants. Few people realize what enormous sums of money are annually distributed in connexion with hunting. Horses must be fed; the wages of grooms and helpers be paid; saddlery, clothing, shoeing, &c., are items; farmers, innkeepers, railway companies, fly-men and innumerable others benefit more or less directly. (A. E. T. W.)

HUNTING DOG (*Lycalon pictus*), an African wild dog, differing from the rest of the family in having only four toes on each foot, and its blotched coloration of ochery yellow, black and white. The species is nearly as large as a mastiff, with long limbs, broad



Cape Hunting Dog (*Lycalon pictus*).

flat head, short muzzle and large erect ears, and presents a superficial resemblance to the spotted hyena on which account it is sometimes called the hyena-dog. "Mimicry" has been suggested as an explanation of this likeness; but it is difficult to see what advantage a strong animal hunting in packs like the present species can gain by being mistaken for a hyena, as it is in every respect fully qualified to take care of itself. These wild dogs are found in nearly the whole of Africa south and east of the Sahara. The statement of Gordon Cumming that a pack "could run into the swiftest or overcome the largest and most powerful antelope," is abundantly confirmed, and these dogs do great damage to sheep flocks. Several local races of the species have been named.

HUNTINGDON, EARLS OF. GEORGE HASTINGS, 1st earl of Huntingdon¹ (c. 1488-1545), was the son and successor of

¹The title of earl of Huntingdon had previously been held in other families (see HUNTINGDONSHIRE). The famous Robin Hood (?1160-?1247) is said to have had a claim to the earldom.

Edward, 2nd Baron Hastings (d. 1506), and the grandson of William, Baron Hastings, who was put to death by Richard III. in 1483. Being in high favour with Henry VIII., he was created earl of Huntingdon in 1520, and he was one of the royalist leaders during the suppression of the rising known as the Pilgrimage of Grace in 1536. His eldest son FRANCIS, the 2nd earl (c. 1514-1561), was a close friend and political ally of John Dudley, duke of Northumberland, sharing the duke's fall and imprisonment after the death of Edward VI. in 1553; but he was quickly released, and was employed on public business by Mary. His brother Edward (c. 1520-1572) was one of Mary's most valuable servants; a stout Roman Catholic, he was master of the horse and then lord chamberlain to the queen, and was created Baron Hastings of Loughborough in 1558, this title becoming extinct when he died.

The 2nd earl's eldest son HENRY, the 3rd earl (c. 1535-1595), married Northumberland's daughter Catherine. His mother was Catherine Pole (d. 1576), a descendant of George, duke of Clarence; and, asserting that he was thus entitled to succeed Elizabeth on the English throne, Huntingdon won a certain amount of support, especially from the Protestants and the enemies of Mary, queen of Scots. In 1572 he was appointed president of the council of the north, and during the troubled period between the flight of Mary to England in 1568 and the defeat of the Spanish armada twenty years later he was frequently employed in the north of England. It was doubtless felt that the earl's own title to the crown was a pledge that he would show scant sympathy with the advocates of Mary's claim. He assisted George Talbot, earl of Shrewsbury, to remove the Scottish queen from Wingfield to Tutbury, and for a short time in 1569 he was one of her custodians. Huntingdon was responsible for the compilation of an elaborate history of the Hastings family, a manuscript copy of which is now in the British Museum. As he died childless, his earldom passed to his brother George. Another brother, Sir Francis Hastings (d. 1610), was a member of parliament and a prominent puritan during Elizabeth's reign, but is perhaps more celebrated as a writer. GEORGE, the 4th earl (c. 1540-1604), was the grandfather of HENRY, the 5th earl (1586-1643), and the father of Henry Hastings (c. 1560-1650), a famous sportsman, whose character has been delineated by the 1st earl of Shaftesbury (see L. Howard, *A Collection of Letters, &c.*, 1753). The 6th earl was the 5th earl's son FERDINANDO (c. 1608-1656). His brother Henry, Baron Loughborough (c. 1610-1643), won fame as a royalist during the Civil War, and was created a baron in 1643.

THEOPHILUS, the 7th earl (1650-1701), was the only surviving son of the 6th earl. In early life he showed some animus against the Roman Catholics and a certain sympathy for the duke of Monmouth; afterwards, however, he was a firm supporter of James II., who appointed him to several official positions. He remained in England after the king's flight and was imprisoned, but after his release he continued to show his hostility to William III. One of his daughters, Lady Elizabeth Hastings (1682-1739), gained celebrity for her charities and her piety. Her beauty drew encomiums from Congreve and from Steele in the pages of the *Tatler*, and her other qualities were praised by William Law. She was a benefactor to Queen's College, Oxford.

The 7th earl's sons, George and Theophilus, succeeded in turn to the earldom. GEORGE (1677-1705) was a soldier who served under Marlborough, and THEOPHILUS (1696-1746) was the husband of the famous Selina, countess of Huntingdon (q.v.). Theophilus was succeeded by his son FRANCIS (1729-1789), on whose death unmarried the baronies passed to his sister Elizabeth (1731-1808), wife of John Rawdon, earl of Moira, and the earldom became dormant.

The title of earl of Huntingdon was assumed by THEOPHILUS HENRY HASTINGS (1728-1804), a descendant of the 2nd earl, who, however, had taken no steps to prove his title when he died. But, aided by his friend Henry Nugent Bell (1792-1822), his nephew and heir, HANS FRANCIS HASTINGS (1779-1828), was more energetic, and in 1818 his right to the earldom was declared proved, and he took his seat in the House of Lords. He did not,

however, recover the estates. Before thus becoming the 11th (or 12th) earl, Hastings had served for many years in the navy, and after the event he was appointed governor of Dominica. He died on the 9th of December 1828 and was succeeded by his son FRANCIS THEOPHILUS HENRY (1808-1875), whose grandson, WARNER FRANCIS, became 14th or 15th earl of Huntingdon in 1885. Another of the 11th earl's sons was Vice-admiral George Fowler Hastings (1814-1876).

See H. N. Bell, *The Huntingdon Peerage* (1820).

HUNTINGDON, SELINA HASTINGS, COUNTESS OF (1707-1791), English religious leader and founder of a sect of Calvinistic Methodists, known as the Countess of Huntingdon's Connexion, was the daughter of Washington Shirley, 2nd Earl Ferrers. She was born at Stanton Harold, a mansion near Ashby-de-la-Zouch in Leicestershire, on the 24th of August 1707, and in her twenty-first year was married to Theophilus Hastings, 9th earl of Huntingdon. In 1739 she joined the first Methodist society in Fetter Lane, London. On the death of her husband in 1746 she threw in her lot with Wesley and Whitefield in the work of the great revival. Isaac Watts, Philip Doddridge and A. M. Toplady were among her friends. In 1748 she gave Whitefield a scarf as her chaplain, and in that capacity he frequently preached in her London house in Park Street to audiences that included Chesterfield, Walpole and Bolingbroke. In her chapel at Bath there was a curtained recess dubbed "Nicodemus's corner" where some of the bishops sat incognito to hear him. Lady Huntingdon spent her ample means in building chapels in different parts of England, e.g. at Brighton (1761), London and Bath (1765), Tunbridge Wells (1766), and appointed ministers to officiate in them, under the impression that as a peeress she had a right to employ as many chaplains as she pleased. It is said that she expended £100,000 in the cause of religion. In 1768 she converted the old mansion of Trevecca, near Talgarth, in South Wales, into a theological seminary for young ministers for the connexion. Up to 1779 Lady Huntingdon and her chaplains continued members of the Church of England, but in that year the prohibition of her chaplains by the consistorial court from preaching in the Pantheon, a large building in London rented for the purpose by the countess, compelled her, in order to evade the injunction, to take shelter under the Toleration Act. This step, which placed her legally among dissenters, had the effect of severing from the connexion several eminent and useful members, among them William Romaine (1714-1795) and Henry Veal (1725-1797). Till her death in London on the 17th of June 1791, Lady Huntingdon continued to exercise an active, and even autocratic, superintendence over her chapels and chaplains. She successfully petitioned George III. in regard to the gaiety of Archbishop Cornwallis's establishment, and made a vigorous protest against the anti-Calvinistic minutes of the Wesleyan Conference of 1770, and against relaxing the terms of subscription in 1772. Her sixty-four chapels and the college were bequeathed to four trustees. In 1792 the college was removed to Chesham, Hertfordshire, where it remained till 1905, when it was transferred to Cambridge. The college is remarkable for the number of men it has sent into the foreign mission field.

The connexion in 1910 consisted of 44 churches and mission stations, with a roll of about 2400 communicants under 26 ordained pastors. The government is vested by the trust deed, sanctioned by the court of Chancery on the 1st of January 1809, in nine trustees assisted by a conference of delegates from each church in the trust. The endowments of the trust produce £1500 per annum, and are devoted to four purposes: grants in aid of the ministry; annuities to ministers over sixty years of age who have given more than twenty years' continuous service in the connexion, or to their widows; grants for the maintenance and extension of the existing buildings belonging to the trust; grants to assist in purchasing chapels and chapel sites. In addition the trustees may grant loans for the encouragement of new progressive work from a loan fund of about £8000.

See *The Life of the Countess of Huntingdon* (London, 2 vols., 1844); A. H. New, *The Coronet and the Cross, or Memorials of Selina, Countess of Huntingdon* (1857); Sarah Tytler, *The Countess of Huntingdon and her Circle* (1907).

HUNTINGDON, a market town and municipal borough and the county town of Huntingdonshire, England, on the left bank of the Ouse, on the Great Northern, Great Eastern and Midland

railways, 59 m. N. of London. Pop. (1901) 4261. It consists principally of one street, about a mile long, in the centre of which is the market-place. Of the ancient religious houses in Huntingdon few traces remain. The parish church of St Mary occupies the site of the priory of Augustinian Canons already existing in the 10th century, in which David Bruce, Scottish earl of Huntingdon, was afterwards buried. The church, which was restored by Sir A. W. Blomfield, in 1876, contains portions of the earlier building which it replaced in 1620. All Saints' church, rebuilt about a century earlier, has slight remains of the original Norman church and some good modern, as well as ancient, carved woodwork. The church registers dating from 1558 are preserved, together with those of the old parish of St John, which date from 1585 and contain the entry of Oliver Cromwell's baptism on the 29th of April 1599, the house in which he was born being still in existence. Some Norman remains of the hospice of St John the Baptist founded by David, king of Scotland, at the end of the 12th century were incorporated in the buildings of Huntingdon grammar school, once attended by Oliver Cromwell and by Samuel Pepys. Hinchingsbrooke House, on the outskirts of the town, an Elizabethan mansion chiefly of the 16th century, was the seat of the Cromwell family, others of the Montagus, earls of Sandwich. It occupies the site of a Benedictine nunnery granted by Henry VIII. at the Dissolution, together with many other manors in Huntingdonshire, to Sir Richard Williams, alias Cromwell, whose son, Sir Henry Cromwell, entertained Queen Elizabeth here in 1564. His son, Sir Oliver Cromwell, was the uncle and godfather of the Protector. Among the buildings of Huntingdon are the town hall (1745), county gaol, barracks, county hospital and the Montagu Institute (1897). A racecourse is situated in the bend of the Ouse to the south of the town, and meetings are held here in August. The town is governed by a mayor, 4 aldermen and 22 councillors. Area, 1074 acres.

Huntingdon (*Hunlandune*, *Huntersdune*) was taken by the Danes in King Alfred's reign but recovered c. 919 by Edward the Elder, who raised a castle there, probably on the site of an older fortress. In 1010 the Danes destroyed the town. The castle was strengthened by David, king of Scotland, after the Conquest, but was among the castles destroyed by order of Henry II. At the time of the Domesday Survey Huntingdon was divided into four divisions, two containing 116 burgesses and the other two 142. Most of the burgesses belonged to the king and paid a rent of £10 yearly. King John in 1205 granted them the liberties and privileges held by the men of other boroughs in England and increased the farm to £20. Henry III. further increased it to £40 in 1252. The borough was incorporated by Richard III. in 1483 under the title of bailiffs and burgesses, and in 1630 Charles I. granted a new charter, appointing a mayor and 12 aldermen, which remained the governing charter until the Municipal Corporations Act of 1835 changed the corporation to a mayor, 4 aldermen and 22 councillors. The burgesses were represented in parliament by two members from 1295 to 1867 when the number was reduced to one, and in 1885 they ceased to be separately represented. Huntingdon owed its prosperity to its situation on the Roman Ermine Street. It has never been noted for manufactures, but is the centre of an agricultural district. The market held on Saturday was granted to the burgesses by King John. During the Civil Wars Huntingdon was several times occupied by the Royalists.

• See *Victoria County History, Huntingdon*; Robert Carruthers, *The History of Huntingdon from the Earliest to the Present Times* (1824); Edward Griffith, *A Collection of Ancient Records relating to the Borough of Huntingdon* (1827).

• **HUNTINGDON**, a borough and the county-seat of Huntingdon county, Pennsylvania, U.S.A., on the Juniata river, about 150 m. E. of Pittsburg, in the S. central part of the state. Pop. (1890) 5729; (1900) 6053 (225 foreign-born); (1910) 6861. It is served by the Pennsylvania and the Huntingdon & Broad Top Mountain railways, the latter running to the Broad Top Mountain coalfields in the S.W. part of the county. The borough is built on ground sloping gently towards the river, which furnishes valuable water power. The surrounding country is well adapted

to agriculture, and abounds in coal, iron, fire clay, limestone and white sand. Huntingdon's principal manufactures are stationery, flour, knitting-goods, furniture, boilers, radiators and sewer pipe. It is the seat of Juniata College (German Baptist Brethren), opened in 1876 as the Brethren's Normal School and Collegiate Institute, and rechartered as Juniata College in 1896, and of the State Industrial Reformatory, opened in 1888. Indians (probably Oneidas) settled near the site of Huntingdon, erected here a tall pillar, known as "Standing Stone"; the original was removed by the Indians, but another has been erected by the borough on the same spot. The place was laid out as a town in 1767 under the direction of Dr William Smith (1737-1803), at the time provost of the college of Pennsylvania (afterwards the university of Pennsylvania); and it was named in honour of the countess of Huntingdon, who had contributed liberally toward the maintenance of that institution. It was incorporated as a borough in 1796.

HUNTINGDONSHIRE (HUNTS), an east midland county of England, bounded N. and W. by Northamptonshire, S.W. by Bedfordshire and E. by Cambridgeshire. Among English counties it is the smallest with the exception of Middlesex and Rutland, having an area of 366 sq. m. The surface is low, and for the most part bare of trees. The south-eastern corner of the county, bounded by the Ouse valley, is traversed by a low ridge of hills entering from Cambridgeshire, and continued over the whole western half of the county, as well as in a strip about 6 m. broad north of the Ouse, between Huntingdon and St Ives. These hills never exceed 300 ft. in height, but form a pleasantly undulating surface. The north-eastern part of the county, comprising 50,000 acres, belongs to that division of the great Fen district called the Bedford Levels. The principal rivers are the Ouse and Nene. The Ouse from Bedfordshire skirts the borders of the county near St Neots, and after flowing north to Huntingdon takes an easterly direction past St Ives into Cambridgeshire on its way to the Wash. The Kym, from Northamptonshire, follows a south-easterly course and joins the Ouse at St Neots, while the Alconbury brook, flowing in a parallel direction, falls into it at Huntingdon. The Nene forms for 15 m. the north-western border of the county, and quitting it near Peterborough, enters the Wash below Wisbech, in Cambridgeshire. The course of the Old River Nene is eastward across the county midway between Huntingdon and Peterborough, and about 1½ m. N. by E. of Ramsey it is intersected by the Forty Foot, or Vermuyden's Drain, a navigable cut connecting it with the Old Bedford river in Cambridgeshire.

Geology.—The geological structure is very simple. All the stratified rocks are of Jurassic age, with the exception of a small area of Lower Greensand which extends for a short distance along the border, north of Potton. The Greensands form low, rounded hills. Phosphatic nodules are obtained from these beds. On the north-western border is a narrow strip of Inferior Oolite, reaching from Thrapston by Oundle to Wansford near Peterborough. It is represented about Wansford by the Northampton sands and by a feeble development of the Lincolnshire limestone. The Great Oolite Series has at the base the Upper Estuarine clays; in the middle, the Great Oolite limestone, which forms the escarpment of Alwalton Lynch; and at the top, the Great Oolite clay. The Cornbrash is exposed along part of the Billing brook, and in a small inlier near Xaxley. Over the remainder of the county the lower rocks are covered by the Oxford clay. It is about 600 ft. thick. This clay cannot be distinguished from the Kimmeridge clay except by the fossils; the two formations probably graduate into one another, but thin limestones are found in places, and at St Ives a patch of the intermediate Corallian rock is present. All the stratified rocks have a general dip towards the south-east.

Much glacial drift clay with stones covers the older rocks over a good deal of the county; it is a bluish clay, often containing masses of chalk, some of them being of considerable size, e.g. the one at Catworth. The Fens on the eastern side of the county are underlain by Oxford clay, which here and there projects through the prevailing newer deposit of silt and loam. There are usually two beds of peat or peaty soil observable in the numerous drains; they are separated by a bed of marine warp. Black loamy alluvium and valley gravels, the most recent deposits, occur in the valleys of the Ouse and Nene. Calcareous tufa is formed by the springs near Alwalton. Oxford clay is dug on a considerable scale for brick-making at Fletton, also at St Ives, Ramsey and St Neots.

Agriculture.—Huntingdonshire is almost wholly an agricultural county; nearly nine-tenths of its total area is under cultivation, and much improvement has been effected by drainage. On account of the tenacity of the clay the drains often require to be placed very close. Much of the soil is, however, undrained, and only partly used for pasturage. On the drained pasturage a large number of cattle are fed. The district comprising the gravel of the Ouse valley embraces an area of 30,000 acres. On the banks of the Ouse it consists of fine black loam deposited by the overflow of the river, and its meadows form very rich pasture grounds. The upland district is under arable culture. Wheat is much more extensively grown than any other grain. Barley is more widely cultivated than oats, but its quality on many soils is lean and inferior, and unsuitable for malting purposes. Beans and peas are largely grown, while mangold and cabbage and similar green crops are chiefly used for the feeding of sheep. During the last quarter of the 19th century there was a large decrease in the areas of grain crops and of fallow, and an increase in that of permanent pasture. Market-gardening and fruit-farming, however, greatly increased in importance. Willows are largely grown in the fen district. Good drinking water is deficient in many districts, but there are three natural springs, once famous for the healing virtues their waters were thought to possess, namely, at Hail Weston near St Neots, at Holywell near St Ives and at Somersham in the same district. Bee-farming is largely practised. Dairy-farming is not much followed, the milk being chiefly used for rearing calves. The village of Stilton, on the Great North Road, had formerly a large market for the well-known cheese to which it has given its name. Large numbers of cattle are fattened in the field or the fold-yard, and are sold when rising three years old. They are mostly of the shorthorn breed, large numbers of Irish shorthorns being wintered in the fens. Leicesters and Lincolns are the most common breeds of sheep; they usually attain great weights at an early age. Pigs include Berkshire, Suffolk and Neapolitan breeds, and a number of crosses. Their fattening and breeding are extensively practised.

Other Industries.—There is no extensive manufacture, but the chief is that of paper and parchment. Maddar is obtained in considerable quantities, and in nearly every part of the county lime burning is carried on. Lace-making is practised by the female peasantry; and the other industries are printing, iron-founding, tanning and currying, brick and tile making, malting and brewing.

Communications.—The middle of the county is traversed from south to north by the Great Northern railway, which enters it at St Neots and passing by Huntingdon leaves it at Peterborough. A branch line running eastward to Ramsey is given off at Holme junction, midway between Huntingdon and Peterborough. From Huntingdon branch lines of the Midland and the Great Eastern run respectively west and east to Thrapston (Northamptonshire) and to Cambridge via St Ives. From St Ives Great Eastern lines also run N.E. to Ely (Cambridgeshire) via Earith Bridges on the county border, and N. to Wisbech (Cambridgeshire) with a branch line westward from Somersham to Ramsey. The north-western border is served by the Great Northern and the London and North-Western railways between Peterborough and Wansford, where they part.

Population and Administration.—The area of the ancient county is 234,218 acres, with a population in 1801 of 57,761, and in 1901 of 57,771. The area of the administrative county is 233,984 acres. The county contains 4 hundreds. The municipal boroughs are Godmanchester (pop. 2017), Huntingdon, the county town (4261) and St Ives (2910). The other urban districts are Old Fletton (4585), Ramsey (4823) and St Neots (3880). The county is in the south-eastern circuit, and assizes are held at Huntingdon. It has one court of quarter sessions, and is divided into five petty sessional divisions. There are 105 civil parishes. Huntingdonshire, which contains 87 ecclesiastical parishes or districts wholly or in part, is almost wholly in the diocese of Ely, but a small part is in that of Peterborough. The parliamentary divisions, each of which returns one member,

are the Northern or Ramsey and the Southern or Huntingdon. Part of the parliamentary borough of Peterborough also falls within the county.

History.—The earliest English settlers in the district were the Gyrwas, an East Anglian tribe, who early in the 6th century worked their way up the Ouse and the Cam as far as Huntingdon. After their conquest of East Anglia in the latter half of the 9th century, Huntingdon became an important seat of the Danes, and the Danish origin of the shire is borne out by an entry in the Saxon Chronicle (918-921) referring to Huntingdon as a military centre to which the surrounding district owed allegiance, while the shire itself is mentioned in the *Historia Bienenis* in connexion with events which took place before or shortly after the death of Edgar. About 915 Edward the Elder wrested the fen-country from the Danes, repairing and fortifying Huntingdon, and a few years later the district was included in the earldom of East Anglia. Religious foundations were established at Ramsey, Huntingdon and St Neots in the 10th century, and that of Ramsey accumulated vast wealth and influence, owning twenty-six manors in this county alone at the time of the Domesday Survey. In 1011 Huntingdonshire was again overrun by the Danes and in 1016 was attacked by Canute. A few years later the shire was included in the earldom of Thored (of the Middle Angles), but in 1051 it was detached from Mercia and formed part of the East Anglian earldom of Harold. Shortly before the Conquest, however, it was bestowed on Siward, as a reward for his part in Godwin's overthrow, and became an outlying portion of the earldom of Northumberland, passing through Waltheof and Simon de St Lis to David of Scotland. After the separation of the earldom from the crown of Scotland during the Bruce and Balliol disputes, it was conferred in 1336 on William Clinton; in 1377 on Guichard d'Angle; in 1387 on John Holland; in 1471 on Thomas Grey, afterwards marquis of Dorset; and in 1529 on George, Baron Hastings, whose descendants hold it at the present day.

The Norman Conquest was followed by a general confiscation of estates, and only four or five thanes retained lands which they or their fathers had held in the time of Edward the Confessor. Large estates were held by the church, and the rest of the county for the most part formed outlying portions of the fiefs of William's Norman favourites, that of Count Eustace of Boulogne, the sheriff, of whose tyrannous exactions bitter complaints are recorded, being by far the most considerable. Kimbolton was fortified by Geoffrey de Mandeville and afterwards passed to the families of Bohun and Stafford.

The hundreds of Huntingdon were probably of very early origin, and that of Norman Cross is referred to in 963. The Domesday Survey, besides the four existing divisions of Norman Cross, Toseland, Hurstingstone and Leightonstone, which from their assessment appear to have been double hundreds, mentions an additional hundred of Kimbolton, since absorbed in Leightonstone, while Huntingdon is assessed separately at fifty hides. The boundaries of the county have scarcely changed since the time of the Domesday Survey, except that parts of the Bedfordshire parishes of Everton, Pertenhall and Keysoe and the Northamptonshire parish of Hargrave were then assessed under this county. Huntingdonshire was formerly in the diocese of Lincoln, but in 1837 was transferred to Ely. In 1291 it constituted an archdeaconry, comprising the deaneries of Huntingdon, St Ives, Yaxley and Leightonstone, and the divisions remained unchanged until the creation of the deanery of Kimbolton in 1879.

At the time of the Domesday Survey Huntingdonshire had an independent shrievalty, but from 1154 it was united with Cambridgeshire under one sheriff, until in 1637 the two counties were separated for six years, after which they were reunited and have remained so to the present day. The shire-court was held at Huntingdon.

In 1174 Henry II. captured and destroyed Huntingdon Castle. After signing the Great Charter John sent an army to ravage this county under William, earl of Salisbury, and Falke de Breatut. During the wars of the Roses Huntingdon was sacked by the

Lancastrians. The county resisted the illegal taxation of Charles I. and joined in a protest against the arrest of the five members. In 1642 it was one of the seven associated counties in which the king had no visible party. Hinchingsbrook, however, was held for Charles by Sir Sydney Montagu, and in 1645 Huntington was captured and plundered by the Royalist forces. The chief historic family connected with this county were the Cromwells, who held considerable estates in the 16th century.

Huntingdonshire has always been mainly an agricultural county, and at the time of the Domesday Survey contained thirty-one mills, besides valuable fisheries in its meres and rivers. The woollen industry flourished in the county from Norman times, and previous to the draining of its fens in the 17th century, by which large areas were brought under cultivation, the industries of turf-cutting, reed-cutting for thatch and the manufacture of horse-collars from rushes were carried on in Ramsey and the surrounding district. In the 17th century saltpetre was manufactured in the county. In the 18th century women and children were largely employed in spinning yarn, and pillow-lace making and the straw-plait industry flourished in the St Neots district, where it survives; pillow lace was also manufactured at Godmanchester. In the early 19th century there were two large sacking manufactures at Standground, and brewing and malting were largely carried on.

Huntingdonshire was represented by three members in parliament in 1290. From 1295 the county and borough of Huntington returned two members each, until in 1868 the representation of the borough was reduced to one member. By the act of 1885 the borough was disfranchised.

Antiquities.—Huntingdonshire early became famous on account of its great Benedictine abbey at Ramsey and the Cistercian abbey founded in 1146 at Sawtry, 7 m. W. of Ramsey; besides which there were priories at Huntington and Stonely, both belonging to the Augustinian canons, and at St Ives and St Neots belonging to the Benedictines, together with a Benedictine nunnery at Hinchingsbrook, near Huntington. Of these buildings almost the only remains are at Ramsey and St Ives. The most interesting churches for Norman architecture are Hartford near Huntington, Old Fletton near Peterborough (containing on the exterior some carved ornament said to have belonged to the original Saxon cathedral at Peterborough), Ramsey and Alwalton, a singular combination of Norman and Early English. Early English churches are Kimbolton, Alconbury, Warboys and Somersham, near Ramsey, and Hail Weston near St Neots, with a 15th-century wooden tower and spire. Decorated are Orton Longueville and Yaxley, both near Peterborough, the latter containing remains of frescoes on its walls; Perpendicular, St Neots, Conington near Ramsey and Godmanchester. At Buckden near Huntington are remains of a palace (15th century) of the bishops of Lincoln. There were two ancient castles in the county, at Huntington and at Kimbolton, of which only the second remains as a mansion. Hinchingsbrook House, Huntington, was the seat of the Cromwell family. Conington Castle passed, like the title of earl of Huntington, through the hands of Walthof, Simon de St Liz and the Scottish royal family, and was finally inherited by Sir Robert Cotton the antiquary, who was born in the neighbourhood, and is buried in Conington church. Elton Hall, on the north-west border of the county, was rebuilt about 1660, and contains, besides a good collection of pictures, chiefly by English masters, a library which includes many old and rare prayer-books, Bibles and missals.

Norman Cross, 13 m. N. of Huntington, on the Great North Road, marks the site of the place of confinement of several thousand French soldiers during the Napoleonic wars at the beginning of the 19th century. The village of Little Gidding, 9 m. N.W. of Huntington, is memorable for its connexion with Nicholas Ferrar in the reign of Charles I., when the religious community of which Ferrar was the head was organized. Relics connected with this community are preserved in the British Museum.

HUNTINGTON, DANIEL (1816-1906), American artist, was born in New York on the 14th of October 1816. In 1835 he studied with S. F. B. Morse, and produced "A Bar-Room

Politician" and "A Toper Asleep." Subsequently he painted some landscapes on the river Hudson, and in 1839 went to Rome. On his return to America he painted portraits and began the illustration of *The Pilgrim's Progress*, but his eyesight failed, and in 1844 he went back to Rome. Returning to New York in 1846, he devoted his time chiefly to portrait-painting, although he has painted many genre, religious and historical subjects. He was president of the National Academy from 1862 to 1870, and again in 1877-1890. Among his principal works are: "The Florentine Girl," "Early Christian Prisoners," "The Shepherd Boy of the Campagna," "The Roman Penitents," "Christiana and Her Children," "Queen Mary signing the Death-Warrant of Lady Jane Grey," and "Feckenham in the Tower" (1850), "Chocorua" (1860), "Republican Court in the Time of Washington," containing sixty-four careful portraits (1861), "Sowing the Word" (1869), "St Jerome," "Juliet on the Balcony" (1870), "The Narrows, Lake George" (1871), "Titan," "Clement VII. and Charles V. at Bologna," "Philosophy and Christian Art" (1878), "Goldsmith's Daughter" (1884). His principal portraits are: President Lincoln, in Union League Club, New York; Chancellor Ferris of New York University; Sir Charles Eastlake and the earl of Carlyle, the property of the New York Historical Society; President Van Buren, in the State Library at Albany; James Lenox, in the Lenox Library; Louis Agassiz (1856-1857), William Cullen Bryant (1866), John A. Dix (1880) and John Sherman (1881). He died on the 19th of April 1906 in New York City.

HUNTINGTON, FREDERIC DAN (1819-1904), American clergyman, first Protestant Episcopal bishop of central New York, was born in Hadley, Massachusetts, on the 28th of May 1819. He graduated at Amherst in 1839 and at the Harvard Divinity School in 1842. In 1842-1855 he was pastor of the South Congregational Church of Boston, and in 1855-1860 was preacher to the university and Plummer professor of Christian Morals at Harvard; he then left the Unitarian Church, with which his father had been connected as a clergyman at Hadley, resigned his professorship and became pastor of the newly established Emmanuel Church of Boston. He had refused the bishopric of Maine when in 1868 he was elected to the diocese of central New York. He was consecrated on the 9th of April 1869, and thereafter lived in Syracuse. He died in Hadley, Massachusetts, on the 11th of July 1904. His more important publications were *Lectures on Human Society* (1860); *Memorials of a Quiet Life* (1874); and *The Golden Rule applied to Business and Social Conditions* (1892).

See *Memoir and Letters of Frederic Dan Huntington* (Boston, 1906), by Arria S. Huntington, his wife.

HUNTINGTON, a city and the county-seat of Huntington county, Indiana, U.S.A., on the Little river, about 25 m. S.W. of Fort Wayne. Pop. (1900) 9,091, of whom 621 were foreign-born; (1910 census) 10,272. Huntington is served by three railways—the Wabash, the Erie (which has car shops and division headquarters here) and the Cincinnati, Bluffton & Chicago (which has machine shops here), and by the Fort Wayne & Wabash Valley Traction Company, whose car and repair shops and power station are in Huntington. The city has a public library, a business college and Central College (1897), controlled by the United Brethren in Christ (Old Constitution). Woodware is the principal manufacture. The value of the factory product in 1905 was \$2,081,019, an increase of 20.6% since 1900. The municipality owns and operates the waterworks and the electric-lighting plant. Huntington, named in honour of Samuel Huntington (1736-1796), of Connecticut, a signer of the Declaration of Independence, was first settled about 1829, was incorporated as a town in 1828 and was chartered as a city in 1873.

HUNTINGTON, a township of Suffolk county, New York, U.S.A., in the central part of the N. side of Long Island, bounded on the N. by Huntington Bay, a part of Long Island Sound. Pop. (1905, state census) 10,236; (1910) 12,004. The S. part of the township is largely taken up with market-gardening; but along the Sound are the villages of Huntington, Cold Spring

Harbor, Centreport and Northport, which are famous for the fine residences owned by New York business men; they are served by the Wading river branch of the Long Island Railroad. Northport—pop. (1910 census) 2096—incorporated in 1894, is the most easterly of these; it has a large law-publishing house, shipbuilding yards and valuable oyster-fisheries. Cold Spring Harbor, 32 m. E. of Brooklyn, is a small unincorporated village, once famous for its whale-fisheries, and now best known for the presence here of the New York State Fish Hatchery, and of the Biological Laboratory of the Brooklyn Institute of Arts and Sciences and of the laboratory of the Department of Experimental Evolution of the Carnegie Institution of Washington. The village of Huntington, 3½ m. E. of Cold Spring, is unincorporated, but is the most important of the three and has the largest summer colony. There is a public park on the water-front. The Soldiers' and Sailors' Memorial Building is occupied by the public library, which faces a monument to Nathan Hale on Main Street. A big boulder on the shore of the bay marks the place of Hale's capture by the British on the 21st of September 1776. Benjamin Thompson (Count Rumford) occupied the village and built a British fort here near the close of the American War of Independence. Huntington's inhabitants were mostly strong patriots, notably Ebenezer Prime (1700-1779), pastor of the First Presbyterian Church, which the British used as a barracks, and his son Benjamin Young Prime (1733-1791), a physician, linguist and patriot poet, who was the father of Samuel Irenaeus Prime (1812-1885), editor of the *New York Observer*. Walt Whitman was born near the village of Huntington, and established there in 1836, and for three years edited, the weekly newspaper the *Long Islander*. The first settlement in the township was made in 1653; in 1662-1664 Huntington was under the government of Connecticut. The township until 1872 included the present township of Babylon to the S., along the Great South Bay.

HUNTINGTON, a city and the county-seat of Cabell county, West Virginia, U.S.A., about 50 m. W. of Charleston, W. Va., on the S. bank of the Ohio river, just below the mouth of the Guyandotte river. Pop. (1900) 11,923, of whom 1212 were negroes; (1910 census) 31,161. It is served by the Baltimore & Ohio and the Chesapeake & Ohio railways, and by several lines of river steamboats. The city is the seat of Marshall College (founded in 1837; a State Normal School in 1867), which in 1907-1908 had 34 instructors and 1100 students; and of the West Virginia State Asylum for the Incurable Insane; and it has a Carnegie library and a city hospital. Huntington has extensive railway car and repair shops, besides foundries and machine shops, steel rolling mills, manufactories of stoves and ranges, breweries and glass works. The value of the city's factory product in 1905 was \$4,407,153, an increase of 21% over that of 1900. Huntington dates from 1871, when it became the western terminus of the Chesapeake & Ohio railway, was named in honour of Collis P. Huntington (1821-1900), the president of the road, and was incorporated.

HUNTINGTOWER AND RUTHVENFIELD, a village of Perthshire, Scotland, on the Almond, 3 m. N.W. of Perth, and within 1 m. of Almondbank station on the Caledonian railway. Pop. (1901) 459. Bleaching, the chief industry, dates from 1774, when the bleaching-field was formed. By means of an old aqueduct, said to have been built by the Romans, it was provided with water from the Almond, the properties of which render it specially suited for bleaching. Huntingtower (originally Ruthven) Castle, a once formidable structure, was the scene of the Raid of Ruthven (pron. *Riiven*), when the Protestant lords, headed by William, 4th Lord Ruthven and 1st earl of Gowrie (1541-1584), kidnapped the boy-king James VI., on the 22nd of August 1582. The earl's sons were slain in the attempt (known as the Gowrie conspiracy) to capture James VI. (1600), consequent on which the Scots parliament ordered the name of Ruthven to be abolished, and the barony to be known in future as Huntingtower.

HUNTLY, EARLS AND MARQUESSSES OF. This Scottish title, in the Gordon family, dates as to the earldom from 1449,

and as to the marquessate (the premier marquessate in Scotland) from 1599. The first earl (d. 1470) was Alexander de Seton, lord of Gordon—a title known before 1406; and his son George (d. 1502), by his marriage with Princess Annabella (afterwards divorced), daughter of James I. of Scotland, had several children, including, besides his successor the 3rd earl (Alexander), a second son Adam (who became earl of Sutherland), a third son William (from whom the mother of the poet Byron was descended) and a daughter Katherine, who first married Perkin Warbeck and afterwards Sir Matthew Cradock (from whom the earls of Pembroke descended). Alexander, the 3rd earl (d. 1524), consolidated the position of his house as supreme in the north: he led the Scottish vanguard at Flodden, and was a supporter of Albany against Angus. His grandson George, 4th earl (1514-1562), who in 1548 was granted the earldom of Moray, played a leading part in the troubles of his time in Scotland, and in 1562 revolted against Queen Mary and was killed in fight at Corrichie, near Aberdeen. His son George (d. 1576) was restored to the forfeited earldom in 1565; he became Bothwell's close associate—he helped Bothwell, who had married his sister, to obtain a divorce from her; and he was a powerful supporter of Mary III who seceded from her cause in 1572.

GEORGE GORDON, 1st marquess of Huntly (1562-1626), son of the 5th earl of Huntly, and of Anne, daughter of James Hamilton, earl of Arran and duke of Chatelherault, was born in 1562, and educated in France as a Roman Catholic. He took part in the plot which led to the execution of Morton in 1581 and in the conspiracy which delivered King James VI. from the Ruthven raiders in 1583. In 1588 he signed the Presbyterian confession of faith, but continued to engage in plots for the Spanish invasion of Scotland. On the 28th of November he was appointed captain of the guard, and while carrying out his duties at Holyrood his treasonable correspondence was discovered. James, however, who found the Roman Catholic lords useful as a foil to the tyranny of the Kirk, and was at this time seeking Spanish aid in case of Elizabeth's denial of his right to the English throne, and with whom Huntly was always a favourite, pardoned him. Subsequently in April 1589 he raised a rebellion in the north, but was obliged to submit, and after a short imprisonment in Borthwick Castle was again set at liberty. He next involved himself in a private war with the Grants and the Mackintoshes, who were assisted by the earls of Atholl and Murray; and on the 8th of February 1592 he set fire to Murray's castle of Donibristle in Fife, and stabbed the earl to death with his own hand. This outrage, which originated the ballad "The Bonnie Earl of Moray," brought down upon Huntly his enemies, who ravaged his lands. In December the "Spanish Blanks" were intercepted (see ERROLL, FRANCIS HAY, 9TH EARL OF), two of which bore Huntly's signature, and a charge of treason was again preferred against him, while on the 25th of September 1593 he was excommunicated. James treated him and the other rebel lords with great leniency. On the 26th of November they were freed from the charge of treason, being ordered at the same time, however, to renounce Romanism or leave the kingdom. On their refusal to comply they were attainted. Subsequently Huntly joined Erroll and Bothwell in a conspiracy to imprison the king, and the former two defeated the royal forces under Argyll at Glenlivet on the 3rd of October 1594, Huntly especially distinguishing himself. His victory, however, gained no real advantage; his castle of Strathgogie was blown up by James, and he left Scotland about March 1595. He returned secretly very soon afterwards, and his presence in Scotland was at first connived at by James; but owing to the hostile feeling aroused, and the "No Popery" riot in Edinburgh, the king demanded that he should abjure Romanism or go into permanent banishment. He submitted to the Kirk in June 1597, and was restored to his estates in December. On the 7th of April 1599 he was created a marquess, and on the 9th of July, together with Lennox, appointed lieutenant of the north. He was treated with great favour by the king and was reconciled with Murray and Argyll. Doubts, however, as to the genuineness of his abjuration again troubled the Kirk. On the 10th of December 1606 he was confined

to Aberdeen, and on the 10th of March 1607 he was summoned before the privy council. Huntly thereupon went to England and appealed to James himself. He was excommunicated in 1608, and imprisoned in Stirling Castle till the 10th of December 1610, when he signed again the confession of faith. Accused of Romanist intrigues in 1616, he was ordered once more to subscribe the confession, which this time he refused to do; imprisoned at Edinburgh, he was liberated by James's order on the 18th of June, and having joined the court in London was absolved from excommunication by Abbot, archbishop of Canterbury; which absolution, after some heartburnings at the archbishop's interference, and after a further subscription to the confession by Huntly, was confirmed by the Kirk. At the accession of Charles I. Huntly lost much of his influence at court. He was deprived in 1630 of his heritable sheriffships of Aberdeen and Inverness. The same year a feud broke out between the Crichtons and Gordons, in the course of which Huntly's second son, Lord Meldrum, was burnt to death either by treachery or by accident, while being entertained in the house of James Crichton of Frendraught. For the ravaging of the lands of the Crichtons Huntly was held responsible, and having been summoned before the privy council in 1635 he was imprisoned in Edinburgh Castle from December till June 1636. He left his confinement with shattered health, and died at Dundee while on his journey to Strathbogic on the 13th of June 1636, after declaring himself a Roman Catholic.

GEORGE GORDON, 2nd marquess of Huntly (d. 1649), his eldest son by Lady Henrietta, daughter of the duke of Lennox, was brought up in England as a Protestant, and created earl of Enzie by James I. On succeeding to his father's title his influence in Scotland was employed by the king to balance that of Argyll in the dealings with the Covenanters, but without success. In the civil war he distinguished himself as a royalist, and in 1647 was excepted from the general pardon; in March 1649, having been captured and given up, he was beheaded by order of the Scots parliament at Edinburgh. His fourth son CHARLES (d. 1681) was created earl of Aboyne in 1660; and the eldest son LEWIS was proclaimed 3rd marquess of Huntly by Charles II. in 1651. But the attainder was not reversed by parliament till 1661.

GEORGE GORDON, 4th marquess (1643-1716), served under Turenne, and was created 1st duke of Gordon by Charles II. in 1684 (see GORDON). On the death of the 5th duke of Gordon in 1836 the title of 9th marquess of Huntly passed to his relative GEORGE GORDON (1761-1833), son and heir of the 4th earl of Aboyne; who in 1815 was made a peer of the United Kingdom as Baron Meldrum, his descendants being the 10th and 11th marquesses.

HUNTLY, a police burgh, burgh of barony and parish of Aberdeenshire, Scotland, capital of the district of Strathbogic. Pop. (1901) 4136. It lies at the confluence of the rivers Deveron and Bogie, 41 m. N.W. of Aberdeen on the Great North of Scotland Railway. It is a market town and the centre of a large agricultural district, its chief industries including agricultural implement-making, hosiery weaving, weaving of woollen cloth, and the manufacture of lamps and boots. Huntly Castle, half a mile to the north, now in ruins, was once a fortress of the Comyns. From them it passed in the 14th century to the Gordons, by whom it was rebuilt. It was blown up in 1594, but was restored in 1602. It gradually fell into disrepair, some of its stones being utilized in the building of Huntly Lodge, the residence of the widow of the "last" duke of Gordon, who (in 1840) founded the adjoining Gordon schools to his memory. The Standing Stones of Strathbogic in Market Square have offered a permanent puzzle to antiquaries.

HUNTSMAN, BENJAMIN (1704-1776), English inventor and steel-manufacturer, was born in Lincolnshire in 1704. His parents were Germans. He started business as a clock, lock and tool maker at Doncaster, and attained a considerable local reputation for scientific knowledge and skilled workmanship. He also practised surgery in an experimental fashion, and was frequently consulted as an oculist. Finding that the bad quality

of the steel then available for his products seriously hampered him, he began to experiment in steel-manufacture, first at Doncaster, and subsequently at Handsworth, near Sheffield, whither he removed in 1740 to secure cheaper fuel for his furnaces. After several years' trials he at last produced a satisfactory cast steel, purer and harder than any steel then in use. The Sheffield cutlery manufacturers, however, refused to buy it, on the ground that it was too hard, and for a long time Huntsman exported his whole output to France. The growing competition of imported French cutlery made from Huntsman's cast-steel at length alarmed the Sheffield cutlers, who, after vainly endeavouring to get the exportation of the steel prohibited by the British government, were compelled in self-defence to use it. Huntsman had not patented his process, and its secret was discovered by a Sheffield ironfounder, who, according to a popular story, obtained admission to Huntsman's works in the disguise of a tramp. Benjamin Huntsman died in 1776, his business being subsequently greatly developed by his son, William Huntsman (1733-1809).

See Smiles, *Industrial Biography* (1879).

HUNTSVILLE, a city and the county-seat of Madison county, Alabama, U.S.A., situated on a plain 10 m. N. of the Tennessee river, 18 m. from the northern boundary of the state, at an altitude of about 617 ft. Pop. (1900) 8068, of whom 3909 were of negro descent; (1910 census) 7611. There is a considerable suburban population. Huntsville is served by the Southern and the Nashville, Chattanooga & St Louis railways. The public square is on a high bluff (about 750 ft. above sea-level), at the base of which a large spring furnishes the city with water, and also forms a stream once used for floating boats, loaded with cotton, to the Tennessee river. The surrounding country has rich deposits of iron, coal and marble, and cotton, Indian corn and fruit are grown and shipped from Huntsville. Natural gas is found in the vicinity. The principal industry is the manufacture of cotton. The value of the city's factory products increased from \$692,340 in 1900 to \$1,758,718 in 1905, or 154%. At Normal, about 3½ m. N.E. of Huntsville, is the State Agricultural and Mechanical College for Negroes. Huntsville was founded in 1805 by John Hunt, a Virginian and a soldier in the War of Independence; in 1809 its name was changed to Twickenham, in memory of the home of the poet Alexander Pope, some of whose relatives were among the first settlers; but in 1811 the earlier name was restored, under which the town was incorporated by the Territorial Government, the first Alabama settlement to receive a charter. Huntsville was chartered as a city in 1844. Here, in 1819, met the convention that framed the first state constitution, and in 1820 the first state legislature. On the 11th of April 1862 Huntsville was seized by Federal troops, who were forced to retire in the following September, but secured permanent possession in July 1863.

HUNYADI, JÁNOS (c. 1387-1456), Hungarian statesman and warrior, was the son of Vojk, a Magyarized Vlach who married Elizabeth Morsinay. He derived his family name from the small estate of Hunyad, which came into his father's possession in 1409. The later epithet Corvinus, adopted by his son Matthias, was doubtless derived from another property, Piatra da Corvo or Raven's Rock. He has sometimes been confounded with an elder brother who died fighting for Hungary about 1440. While still a youth, he entered the service of King Sigismund, who appreciated his qualities and borrowed money from him; he accompanied that monarch to Frankfort in his quest for the imperial crown in 1410; took part in the Hussite War in 1420, and in 1437 drove the Turks from Semendria. For these services he got numerous estates and a seat in the royal council. In 1438 King Albert II. made him ban of Szöregy, the district lying between the Aluta and the Danube, a most dangerous dignity entailing constant warfare with the Turks. On the sudden death of Albert in 1439, Hunyadi, feeling acutely that the situation demanded a warrior-king on the throne of St Stephen, lent the whole weight of his influence to the candidature of the young Polish king Wladislaus III. (1440), and thus came into collision with the powerful Cilleis, the chief supporters of Albert's widow Elizabeth and her

infant son, Ladislaus V. (see CILLEI, ULRICH; and LADISLAUS V.). He took a prominent part in the ensuing civil war and was rewarded by Wladislaus III. with the captaincy of the fortress of Belgrade and the voivodship of Transylvania, which latter dignity, however, he shared with his rival Mihály Ujlaki.

The burden of the Turkish War now rested entirely on his shoulders. In 1441 he delivered Serbia by the victory of Semendria. In 1442, not far from Hermannstadt, on which he had been forced to retire, he annihilated an immense Turkish host, and recovered for Hungary the suzerainty of Wallachia and Moldavia; and in July he vanquished a third Turkish army near the Iron Gates. These victories made Hunyadi's name terrible to the Turks and renowned throughout Christendom, and stimulated him in 1443 to undertake, along with King Wladislaus, the famous expedition known as the *hosszu háboru* or "long campaign." Hunyadi, at the head of the vanguard, crossed the Balkans through the Gate of Trajan, captured Nish, defeated three Turkish pashas, and, after taking Sofia, united with the royal army and defeated Murad II. at Snaim. The impatience of the king and the severity of the winter then compelled him (February 1444) to return home, but not before he had utterly broken the sultan's power in Bosnia, Herzegovina, Serbia, Bulgaria and Albania. No sooner had he regained Hungary than he received tempting offers from the pope, represented by the legate Cardinal Cesarini, from George Branković, despot of Servia, and George Castriota, prince of Albania, to resume the war and realize his favourite idea of driving the Turk from Europe. All the preparations had been made, when Murad's envoys arrived in the royal camp at Szeged and offered a ten years' truce on advantageous terms. Both Hunyadi and Branković counselled their acceptance, and Wladislaus swore on the Gospels to observe them. Two days later Cesarini received the tidings that a fleet of galleys had set off for the Bosphorus to prevent Murad (who, crushed by his recent disasters, had retired to Asia Minor) from recrossing into Europe, and the cardinal reminded the king that he had sworn to co-operate by land if the western powers attacked the Turks by sea. He then, by virtue of his legatine powers, absolved the king from his second oath, and in July the Hungarian army recrossed the frontier and advanced towards the Euxine coast in order to march to Constantinople escorted by the galleys. Branković, however, fearful of the sultan's vengeance in case of disaster, privately informed Murad of the advance of the Christian host, and prevented Castriota from joining it. On reaching Varna, the Hungarians found that the Venetian galleys had failed to prevent the transit of the sultan, who now confronted them with fourfold odds, and on the 10th of November 1444 they were utterly routed, Wladislaus falling on the field and Hunyadi narrowly escaping.

At the diet which met in February 1445 a provisional government, consisting of five Magyar captain-generals, was formed, Hunyadi receiving Transylvania and the ultra-Theissian counties as his district; but the resulting anarchy became unendurable, and on the 5th of June 1446 Hunyadi was unanimously elected governor of Hungary in the name of Ladislaus V., with regal powers. His first act as governor was to proceed against the German king Frederick III., who refused to deliver up the young king. After ravaging Styria, Carinthia and Carniola and threatening Vienna, Hunyadi's difficulties elsewhere compelled him to make a truce with Frederick for two years. In 1448 he received a golden chain and the title of prince from Pope Nicholas V., and immediately afterwards resumed the war with the Turks. He lost the two days' battle of Kosovo (October 17th-19th) owing to the treachery of Dan, hospodar of Wallachia, and of his old enemy Branković, who imprisoned him for a time in the dungeons of the fortress of Semendria; but he was ransomed by the Magyars, and, after composing his differences with his powerful and jealous enemies in Hungary, led a punitive expedition against the Servian prince, who was compelled to accept most humiliating terms of peace. In 1450 Hunyadi went to Pressburg to negotiate with Frederick the terms of the surrender of Ladislaus V., but no agreement could be come to,

whereupon the Cilleis and Hunyadi's other enemies accused him of aiming at the throne. He shut their mouths by resigning all his dignities into the hands of the young king, on his return to Hungary at the beginning of 1453, whereupon Ladislaus created him count of Bestercze and captain-general of the kingdom.

Meanwhile the Turkish question had again become acute, and it was plain, after the fall of Constantinople in 1453, that Mahommed II. was rallying his resources in order to subjugate Hungary. His immediate objective was Belgrade, and thither, at the end of 1455, Hunyadi repaired, after a public reconciliation with all his enemies. At his own expense he provisioned and armed the fortress, and leaving in it a strong garrison under the command of his brother-in-law Mihály Szilágyi and his own eldest son László, he proceeded to form a relief army and a fleet of two hundred corvettes. To the eternal shame of the Magyar nobles, he was left entirely to his own resources. His one ally was the Franciscan friar, Giovanni da Capistrano (q.v.), who preached a crusade so effectually that the peasants and yeomanry, ill-armed (most of them had but slings and scythes) but full of enthusiasm, flocked to the standard of Hunyadi, the kernel of whose host consisted of a small band of seasoned mercenaries and a few *banderia* of noble horsemen. On the 14th of July 1456 Hunyadi with his flotilla destroyed the Turkish fleet; on the 21st Szilágyi beat off a fierce assault, and the same day Hunyadi, taking advantage of the confusion of the Turks, pursued them into their camp, which he captured after a desperate encounter. Mahommed thereupon raised the siege and returned to Constantinople, and the independence of Hungary was secured for another seventy years. The Magyars had, however, to pay dearly for this crowning victory, the heavy dying of plague in his camp three weeks later (11th August 1456).

We are so accustomed to regard Hunyadi as the incarnation of Christian chivalry that we are apt to forget that he was a great captain and a great statesman as well as a great hero. It has well been said that he fought with his head rather than with his arm. He was the first to recognize the insufficiency and the unreliability of the feudal levies, the first to employ a regular army on a large scale, the first to depend more upon strategy and tactics than upon mere courage. He was in fact the first Hungarian general in the modern sense of the word. It was only late in life that he learnt to read and write, and his Latin was always very defective. He owed his influence partly to his natural genius and partly to the transparent integrity and nobility of his character. He is described as an undersized, stalwart man with full, rosy cheeks, long snow-white locks, and bright, smiling, black eyes.

See J. Teleki, *The Age of the Hunyadis in Hungary* (Hung.). (Pesth, 1852-1857; supplementary volumes by D. Csánki 1893); G. Fejer, *Genus, incunabula et virtus Joannis Corvini de Hunyad* (Buda, 1844); J. de Chassin, *Jean de Hunyad* (Paris, 1859); A. Pir, *Life of Hunyadi* (Hung.) (Budapest, 1873); V. Frankó, *Cardinal Carvajal and his Missions to Hungary* (Hung.) (Budapest, 1889); P. Frankl, *Der Friede von Szegedin und die Geschichte seines Bruches* (Leipzig, 1904); R. N. Bain, "The Siege of Belgrade, 1456," (*Eng. Hist. Rev.*, 1892); A. Bonfini, *Rerum ungaricarum libri 26, editio septima* (Leipzig, 1771).

HUNYADI, LÁSZLÓ (1433-1457), Hungarian statesman and warrior, was the eldest son of János Hunyadi and Elizabeth Szilágyi. At a very early age he accompanied his father in his campaigns. After the battle of Kosovo (1448) he was left for a time, as a hostage for his father, in the hands of George Branković, despot of Servia. In 1452 he was a member of the deputation which went to Vienna to receive back the Hungarian king Ladislaus V. In 1453 he was already ban of Croatia-Dalmatia. At the diet of Buda (1455) he resigned all his dignities, because of the accusations of Ulrich Cillei and the other enemies of his house, but a reconciliation was ultimately patched up and he was betrothed to Maria, the daughter of the palatine, László Garai. After his father's death in 1456, he was declared by his arch-enemy Cillei (now governor of Hungary with unlimited power), responsible for the debts alleged to be owing by the elder Hunyadi to the state; but he defended himself so ably at the diet of Futak (October 1456) that Cillei feigned a reconcilia-

tion, promising to protect the Hunyadis on condition that they first surrendered all the royal castles entrusted to them. A beginning was to be made with the fortress of Belgrade, of which László was commandant, Cillei intending to take the king with him to Belgrade and assassinate László within its walls. But Hunyadi was warned betimes, and while admitting Ladislaus V. and Cillei, he excluded their army of mercenaries. On the following morning (9th of November 1456) Cillei, during a private interview, suddenly drew upon László, but was himself cut down by the commandant's friends, who rushed in on hearing the clash of weapons. The terrified young king, who had been privy to the plot, thereupon pardoned Hunyadi, and at a subsequent interview with his mother at Temesvar swore that he would protect the whole family. As a pledge of his sincerity he appointed László lord treasurer and captain-general of the kingdom. Suspecting no evil, Hunyadi accompanied the king to Buda, but on arriving there was arrested on a charge of compassing Ladislaus's ruin, condemned to death without the observance of any legal formalities, and beheaded on the 16th of March 1457.

See I. Aczady, *History of the Hungarian Realm* (Hung.), vol. i. (Budapest, 1904). (R. N. B.)

HUNZA (also known as KANJUR) and **NAGAR**, two small states on the North-west frontier of Kashmir, formerly under the administration of the Gilgit agency. The two states, which are divided by a river which runs in a bed 600 ft. wide between cliffs 300 ft. high, are inhabited generally by people of the same stock, speaking the same language, professing the same form of the Mahomedan religion, and ruled by princes sprung from the same family. Nevertheless they have been for centuries persistent rivals, and frequently at war with each other. Formerly Hunza was the more prominent of the two, because it held possession of the passes leading to the Pamirs, and could plunder the caravans on their way between Turkestan and India. But they are both shut up in a recess of the mountains, and were of no importance until about 1880, when the advance of Russia up to the frontiers of Afghanistan, and the great development of her military sources in Asia, increased the necessity for strengthening the British line of defence. This led to the establishment of the Gilgit agency, the occupation of Chitral, and the Hunza expedition of 1891, which asserted British authority over Hunza and Nagar. The country is inhabited by a Dard race of the Yeshkun caste speaking Burishki. For a description of the people see GILGIT. The Hunza-Nagar Expedition of 1891, under Colonel A. Durand, was due to the defiant attitude of the Hunza and Nagar chiefs towards the British agent at Gilgit. The fort at Nilt was stormed, and after a fortnight's delay the cliffs (1000 ft. high) beyond it were also carried by assault. Hunza and Nagar were occupied, the chief of Nagar was reinstated on making his submission, and the half-brother of the raja of Hunza was installed as chief in the place of his brother.

HUON OF BORDEAUX, hero of romance. The French *chanson de geste* of Huon de Bordeaux dates from the first half of the 13th century, and marks the transition between the epic *chanson* founded on national history and the *roman d'aventures*. Huon, son of Seguin of Bordeaux, kills Charlot, the emperor's son, who had laid an ambush for him, without being aware of the rank of his assailant. He is condemned to be hanged by Charlemagne, but reprieved on condition that he visits the court of Gaudisse, the amir of Babylon, and brings back a handful of hair from the amir's beard and four of his back teeth, after having slain the greatest of his knights and three times kissed his daughter Esclarmonde. By the help of the fairy dwarf Oberon, Huon succeeds in this errand, in the course of which he meets with further adventures. The Charlot of the story has been identified by A. Longnon (*Romania* viii. 1-11) with Charles l'Enfant, one of the sons of Charles the Bald and Irmintrude, who died in 866 in consequence of wounds inflicted by a certain Aubouin in precisely similar circumstances to those related in the romance. The epic father of Huon may safely be identified with Seguin, who was count of Bordeaux under Louis the Pious in 839, and died

fighting against the Normans six years later. A Turin manuscript of the romance contains a prologue in the shape of a separate romance of *Auberon*, and four sequels, the *Chanson d'Esclarmonde*, the *Chanson de Clarisse et Florent*, the *Chanson d'Ide et d'Otive* and the *Chanson de Godin*. The same MS. contains in the romance of *Les Lorrains* a summary in seventeen lines of another version of the story, according to which Huon's exile is due to his having slain a count in the emperor's palace. The poem exists in a later version in alexandrines, and, with its continuations, was put into prose in 1454 and printed by Michel le Noir in 1516, since when it has appeared in many forms, notably in a beautifully printed and illustrated adaptation (1898) in modern French by Gaston Paris. The romance had a great vogue in England through the translation (c. 1540) of John Bouchier, Lord Berners, as *Huon of Burdenze*. The tale was dramatized and produced in Paris by the *Confrérie de la Passion* in 1557, and in Philip Henslowe's diary there is a note of a performance of a play, *Heaven of Burdoche*, on the 28th of December 1593. For the literary fortune of the fairy part of the romance see **UBERON**.

The *Chanson de geste* of Huon de Bordeaux was edited by MM F. Guesard and C. Grandmaison for the *Anciens poésies de la France* in 1860; Lord Berners's translation was edited for the E.E.T.S. by S. L. Lee in 1883-1885. See also L. Gautier, *Les Epôques françaises* (2nd ed. vol. iii. pp. 719-773); A. Graf, *I complementi della Chanson de Huon de Bordeaux* (Halle, 1878); "Esclarmonde, &c.," by Max Schweigel, in *Ausg. u. Abhandl. . . der roman. phil.* (Marburg, 1899); C. Voretzsch, *Epiques Studien* (vol. i., Halle, 1900); *Hist. litt. de la France* (vol. xxvi., 1873).

HUON PINE, botanical name *Dacrydium Franklinii*, the most valuable timber tree of Tasmania, a member of the order Coniferae (see **GYMNOSPERMS**). It is a fine tree of pyramidal outline 80 to 100 ft. high, and to 20 ft. in girth at the base, with slender pendulous much-divided branchlets densely covered with the minute scale-like sharply-keeled bright green leaves. It occurs in swampy localities from the upper Huon river to Port Davey and Macquarie Harbour, but is less abundant than formerly owing to the demand for its timber, especially for ship- and boat-building. The wood is close-grained and easily worked.

HU-PEH, a central province of China, bounded N. by Ho-nan, E. by Ngan-hui, S. by Hu-nan, and W. by Shen-si and Szech'uen. It has an area of 70,450 sq. m. and contains a population of 34,000,000. Han-kow, Ich'ang and Shasi are the three open ports of the province, besides which it contains ten other prefectural cities. The greater part of the province forms a plain, and its most noticeable feature is the Han river, which runs in a south-easterly direction across the province from its north-westerly corner to its junction with the Yangtze Kiang at Han-kow. The products of the Han valley are exclusively agricultural, consisting of cotton, wheat, rape seed, tobacco and various kinds of beans. Vegetable tallow is also exported in large quantities from this part of Hu-peh. Gold is found in the Han, but not in sufficient quantities to make working it more than barely remunerative. It is washed every winter from banks of coarse gravel, a little above I-ch'eng Hien, on which it is deposited by the river. Every winter the supply is exhausted by the washers, and every summer it is renewed by the river. Baron von Richthofen reckoned that the digger earned from 50 to 150 cash (i.e. about 1d. to 4½d.) a day. Only one waggon road leads northwards from Hu-peh, and that is to Nan-ying Fu in Ho-nan, where it forks, one branch going to Peking by way of K'ai-feng Fu, and the other into Shan-si by Ho-nan Fu.

HUPFELD, HERMANN (1796-1866), German Orientalist and Biblical commentator, was born on the 31st of March 1796 at Marburg, where he studied philosophy and theology from 1813 to 1817; in 1819 he became a teacher in the gymnasium at Hanau, but in 1822 resigned that appointment. After studying for some time at Halle, he in 1824 settled as *Privatdocent* in philosophy at that university, and in the following year was appointed extraordinary professor of theology at Marburg. There he received the ordinary professorships of Oriental languages and of theology in 1827 and 1830 respectively; thirteen years later he removed as successor of Wilhelm Gesenius

(1786-1842) to Halle. In 1865 he was accused by some theologians of the Hengstenberg school of heretical doctrines. From this charge, however, he successfully cleared himself, the entire theological faculty, including Julius Müller (1801-1878) and August Tholuck (1799-1877), bearing testimony to his sufficient orthodoxy. He died at Halle on the 24th of April 1866.

His earliest works in the department of Semitic philology (*Exercitationes Aethiopicæ*, 1825, and *De emendanda ratione lexicographiæ Semiticæ*, 1827) were followed by the first part (1841), mainly historical and critical, of an *Ausführliche Hebräische Grammatik*, which he did not live to complete, and by a treatise on the early history of Hebrew grammar among the Jews (*De rei grammaticæ apud Judæos initiis antiquissimis scriptoribus*, Halle, 1846). His principal contribution to Biblical literature, the exegetical and critical *Übersetzung und Auslegung der Psalmen*, began to appear in 1855, and was completed in 1861 (2nd ed. by E. Riehm, 1867-1871, 3rd ed. 1888). Other writings are *Über Begriff und Methode der sogenannten biblischen Einleitung* (Marburg, 1844); *De primitiva et vera festorum apud Hebræos ratione* (Halle, 1851-1864); *Die Quellen der Genesis von neuem untersucht* (Berlin, 1853); *Die heutige theologische oder mythologische Theologie und Schriftklärung* (1861).

See E. Riehm, *Hermann Eusebius* (Halle, 1867); W. Kay, *Crisis Hupeldiana* (1865); and the article by A. Kamphausen in Band viii. of Herzog-Hauck's *Realencyclopädie* (1900).

HURD, RICHARD (1720-1808), English divine and writer, bishop of Worcester, was born at Congreve, in the parish of Penkridge, Staffordshire, where his father was a farmer, on the 13th of January 1720. He was educated at the grammar-school of Brewwood and at Emmanuel College, Cambridge. He took his B.A. degree in 1739, and in 1742 he proceeded M.A. and became a fellow of his college. In the same year he was ordained deacon, and given charge of the parish of Reymerton, Norfolk, but he returned to Cambridge early in 1743. He was ordained priest in 1744. In 1748 he published some *Remarks on an Enquiry into the Rejection of Christian Miracles by the Heathens* (1746), by William Weston, a fellow of St John's College, Cambridge. He prepared editions, which won the praise of Edward Gibbon, of the *Ars poetica* and *Epistola ad Pisones* (1749), and the *Epistola ad Augustum* (1751) of Horace. A compliment in the preface to the edition of 1749 was the starting-point of a lasting friendship with William Warburton, through whose influence he was appointed one of the preachers at Whitehall in 1750. In 1765 he was appointed preacher at Lincoln's Inn, and in 1767 he became archdeacon of Gloucester. In 1768 he proceeded D.D. at Cambridge, and delivered at Lincoln's Inn the first Warburton lectures, which were published later (1772) as *An Introduction to the Study of the Prophecies concerning the Christian Church*. He became bishop of Lichfield and Coventry in 1774, and two years later was selected to be tutor to the prince of Wales and the duke of York. In 1781 he was translated to the see of Worcester. He lived chiefly at Hartlebury Castle, where he built a fine library, to which he transferred Alexander Pope's and Warburton's books, purchased on the latter's death. He was extremely popular at court, and in 1783, on the death of Archbishop Cornwallis, the king pressed him to accept the primacy, but Hurd, who was known, says Madame d'Arbly, as "The Beauty of Holiness," declined it as a charge not suited to his temper and talents, and much too heavy for him to sustain. He died, unmarried, on the 28th of May 1808.

Hurd's *Letters on Chivalry and Romance* (1762) retain a certain interest for their importance in the history of the romantic movement, which they did something to stimulate. They were written in continuation of a dialogue on the age of Queen Elizabeth included in his *Moral and Political Dialogues* (1759). Two later dialogues *On the Uses of Foreign Travel* were printed in 1763. Hurd wrote two acrimonious defences of Warburton: *On the Delicacy of Friendship* (1755), in answer to Dr J. Jortin; and a *Letter* (1764) to Dr Thomas Leland, who had criticized Warburton's *Doctrine of Grace*. He edited the *Works* of William Warburton, the *Select Works* (1772) of Abraham Cowley, and left materials for an edition (6 vols., 1811) of Addison. His own works appeared in a collected edition in 8 vols. in 1811.

¹ "Examination of Dr Hurd's Commentary on Horace's Epistles" (*Misc. Works*, ed. John, Lord Sheffield, 1837, pp. 403-427).

The chief sources for Bishop Hurd's biography are "Dates of some occurrences in the life of the author," written by himself and prefixed to vol. i. of his works (1811); "Memoirs of Dr Hurd" in the *Ecclesiastical and University Register* (1809), pp. 399-452; John Nichols, *Literary anecdotes*, vol. vi. (1812), pp. 468-612; Francis Kilvert, *Memoirs of . . . Richard Hurd* (1860), giving selections from Hurd's commonplace book, some correspondence, and extracts from contemporary accounts of the bishop. A review of this work, entitled "Bishop Hurd and his Contemporaries," appeared in the *North British Review*, vol. xxiv. (1861), pp. 375-398.

HURDLE (O. Eng. *hyrdle*, cognate with such Teutonic forms as Ger. *Hürde*, Dutch *horde*, Eng. "boarding"); in pre-Teutonic languages the word appears in Gr. *supria*, wickerwork, *cipri* Lat. *crasis*, basket, cf. "crate," "grate"), a movable temporary fence, formed of a framework of light timber, wattles with smaller pieces of hazel, willow or other pliable wood, or constructed on the plan of a light five-barred field gate, filled in with brushwood. Similar movable frames can be made of iron, wire or other material. A construction of the same type is used in military engineering and fortification as a *saunders* for a temporary roadway across boggy ground or as a backing for earthworks.

HURDLE RACING, running races over short distances, at intervals in which a number of hurdles, or fence-like obstacles, must be jumped. This has always been a favourite branch of track athletics, the usual distances being 120 yds., 220 yds. and 440 yds. The 120 yds. hurdle race is run over ten hurdles 3 ft. 6 in. high and 10 yds. apart, with a space of 15 yds. from the start to the first hurdle and a like distance from the last hurdle to the finish. In Great Britain the hurdles are fixed and the race is run on grass; in America the hurdles, although of the same height, are not fixed, and the races are run on the cinder track. The "low hurdle race" of 220 yds. is run over ten hurdles 2 ft. 6 in. high and 20 yds. apart, with like distances between the start and the first hurdle and between the last hurdle and the finish. The record time for the 120 yds. race on grass is 15½ secs., and on cinders 15½ secs., both of which were performed by A. C. Kraenzlein, who also holds the record for the 220 yds. low hurdle race, 23½ secs. For 440 yds. over hurdles the record time is 57½ secs., by T. M. Donovan, and by J. B. Densham at Kennington Oval in 1907.

HURDY-GURDY (Fr. *vielle à manivelle*, *symphonie* or *chysone à roue*; Ger. *Bauernleier*, *Deutscheleier*, *Bettlerleier*, *Rodleier*, Ital. *lira tedesca*, *lira rustica*, *lira pagana*), now loosely used as a synonym for any grinding organ, but strictly a medieval drone instrument with strings set in vibration by the friction of a wheel, being a development of the *organistrum* (q.v.) reduced in size so that it could be conveniently played by one person instead of two. It consisted of a box or soundchest, sometimes rectangular, but more generally having the outline of the guitar; inside it had a wheel, covered with leather and rosined, and worked by means of a crank at the tail end of the instrument. On the fingerboard were placed movable frets or keys, which, on being depressed, stopped the strings, at points corresponding to the diatonic intervals of the scale. At first there were 4 strings, later 6. In the organistrum three strings, acted on simultaneously by the keys, produced the rude harmony known as *organum*. When this passed out of favour, superseded by the first beginnings of polyphony over a pedal bass, the organistrum gave place to the hurdy-gurdy. Instead of acting on all the strings, the keys now affected the first string only, or "chanterelle," though in some cases certain keys, made longer, also reached the third string or "trompette"; the result was that a diatonic melody could be played on the chanterelles. The other open strings always sounded simultaneously as long as the wheel was turned, like drones on the bag-pipe.

The hurdy-gurdy originated in France at the time when the Paris School or Old French School was laying the foundations of counterpoint and polyphony. During the 13th and 14th centuries it was known by the name of *Symphonia* or *Chysonia*, and in Germany *Lira* or *Leyer*. Its popularity remained undiminished in France until late in the 18th century. Although the hurdy-gurdy never obtained recognition among serious musicians in Germany, the idea embodied in the mechanism stimulated

Ingenuity, the result being such musical curiosities as the *Geigen-scherk* or *Geigen-Clavicymbel* of Hans Hayden of Nuremberg (c. 1600), a harpsichord in which the strings, instead of being plucked by quills, were set in vibration by friction of one of the little steel wheels, covered with parchment and well rosined, which were kept rotating by means of a large wheel and a series of cylinders worked by treadles. Other instruments of similar type were the *Bogenclavier* invented by Joh. Hohlfeld of Berlin in 1751 and the *Bogenflügel* by C. A. Meyer of Görlitz in 1794. In Adam Walker's *Celestina* (1772) the friction was provided by a running band instead of a bow. (K. S.)

HURLSTONE, FREDERICK YEATES (1800-1860), English painter, was born in London, his father being a proprietor of the *Morning Chronicle*. His grand-uncle, Richard Hurlstone, had been a well-known portrait-painter a generation earlier. F. Y. Hurlstone studied under Sir W. Beechey, Sir T. Lawrence and B. R. Haydon, and in 1820 became a student at the Royal Academy, where he soon began to exhibit. In 1823 he won the Academy's gold medal for historical painting. In 1831 he was elected to the Society of British Artists, of which in 1835 he became president; it was to their exhibitions that he sent most of his pictures, as he became a pronounced critic of the management of the Academy. He died in London on the 10th of June 1860. His historical paintings and portraits were very numerous. Some of the most representative are "A Venetian Page" (1824), "The Enchantress Armida" (1831), "Eros" (1836), "Prisoner of Chillon" (1837), "Girl of Sorrento" (1847), "Boabdil" (1854), and his portrait of the 7th earl of Cavan (1833).

HURON (a French term, from *huré*, bristled, early used as an expression of contempt, signifying "lout"), a nickname given by the French when first in Canada to certain Indian tribes of Iroquoian stock, occupying a territory, which similarly was called Huronia, in Ontario, and constituting a confederation called in their own tongue Wendat ("islanders"), which was corrupted by the English into Yendat, Guyandotte and then Wyandot. The name persists for the small section of "Hurons of Lorette," in Quebec, but the remnant of the old Huron Confederacy which after its dispersal in the 17th century settled in Ohio and was afterwards removed to Oklahoma is generally called Wyandot. For their history see WYANDOT, and INDIANS, NORTH AMERICAN (under "Indian Wars"; *Algonkian and Iroquoian*).

See *Handbook of American Indians* (Washington, 1907), s.v. "Huron."

HURON, the second largest of the Great Lakes of North America, including Georgian Bay and the channel north of Manitoulin Island, which are always associated with it. It lies between the parallels of 43° and 46° 20' N. and between the meridians of 80° and 84° W., and is bounded W. by the state of Michigan, and N. and E. by the province of Ontario, Georgian Bay and North Channel being wholly within Canadian territory. The main portion of the lake is 235 m. long from the Strait of Mackinac to St. Clair river, and 98 m. wide on the 45th parallel of latitude. Georgian Bay is 125 m. long, with a greatest width of 60 m., while North Channel is 120 m. long, with an extreme width of 16 m., the whole lake having an area of 23,200 sq. m. The surface is 581 ft. above the sea. The main lake reaches a depth of 802 ft.; Georgian bay shows depths, especially near its west shore, of over 300 ft.; North Channel has depths of 180 ft. Lake Huron is 20 ft. lower than Lake Superior, whose waters it receives at its northern extremity through St. Mary river, is on the same level as Lake Michigan, which connects with its north-west extremity through the Strait of Mackinac, and is nearly 9 ft. higher than Lake Erie, into which it discharges at its south extremity through St. Clair river.

On the mainland, the north and east shores are of gneisses and granites of archæan age, with a broken and hilly surface rising in places to 600 ft. above the lake and giving a profusion of islands following the whole shore line from the river St. Mary to Waubesaene at the extreme east end of Georgian bay. Manitoulin Island and the Saugeen Peninsula are comparatively flat and underlaid by a level bed of Trenton limestone. The southern shores, skirting the peninsula of Michigan, are flat. The rock formations are of sand-

stone and limestone, while the forests are either a tangled growth of pine and spruce or a scattered growth of small trees on a sandy soil. This shore is indented by Thunder bay, 78 sq. m. in area, and Saginaw bay, 50 m. deep and 26 m. wide across its mouth.

The chief tributaries of the lake on the U.S. side are Thunder bay river, Au Sable river and Saginaw river. On the Canadian side are Serpent river, Spanish river, French river, draining Lake Nipissing, Muskoka river, Severn river, draining lake Simcoe, and Nottawasaga river, all emptying into Georgian bay and North Channel, and Saugeen and Maitland rivers, flowing into the main lake. These have been or are largely used in connexion with pine lumbering operations. They, with smaller streams, drain a basin of 75,300 sq. m.

There is a slight current in Lake Huron skirting the west shore from inlet to outlet. At the south end it turns and passes up the east coast. There is also a return current south of Manitoulin Island and a current, sometimes attaining a strength of half a knot, passes into Georgian bay through the main entrance. Ice and navigation conditions and yearly levels are similar to those on the other Great Lakes (q.v.).

Practically all the United States traffic is confined to vessels passing through the main lake between Lakes Superior and Michigan and Lake Erie, but on the Canadian side are several railway termini which receive grain mostly from Lake Superior, and deliver mixed freight to ports on that lake. The chief of these are Parry Sound, Midland, Victoria Harbour, Collingwood, Owen Sound, Southampton, Kincardine, Goderich and Sarnia, at the outlet of the lake. The construction of a ship canal to connect Georgian bay with Montreal by way of French river, Lake Nipissing and Ottawa river began in 1910. A river and lake route with connecting canals, in all about 440 m. long, will be opened for vessels of 20 ft. draught at a cost estimated at £20,000,000 saving some 340 miles in the distance from Lake Superior or Lake Michigan to the sea.

There is a large fishing industry in Lake Huron, the Canadian catch being valued at over a quarter million dollars per annum. Salmon trout (*Salvelinus namaycush*, Walb.) and whitefish (*Coregonus clupeiformis*, Mitchell) are the most numerous and valuable. Amongst the islands on the east shore of Georgian bay, which are greatly frequented as a summer resort, black bass (*micropterus*) and maskinonge (*Esox nobilior*, Le Sueur) are a great attraction to anglers.

See *Georgian Bay and North Channel Pilot*, Department of Marine and Fisheries (Ottawa, 1903); *Sailing Directions for Lake Huron, Canadian Shore*, Department of Marine and Fisheries (Ottawa, 1905); *Bulletin No. 17, Survey of Northern and North-Western Lakes*, United States, War Department (Washington, 1907); *U.S. Hydrographic Office Publication, No. 108 C, Sailing Directions for Lake Huron, &c.* U.S. Navy Department (Washington, 1901).

HURRICANE, a wind-storm of great force and violence, originally as experienced in the West Indies; it is now used to describe similar storms in other regions, except in the East Indies and the Chinese seas, where they are generally known as "typhoons." Hurricane is the strongest force of wind in the Beaufort scale. The Caribbean word *huracan* was introduced by the Portuguese, Spanish and Dutch explorers of the 15th and 16th centuries into many European languages, as in Span. *huracan*, Portu. *juracao*, Ital. *wacane*, Fr. *ouragan*, and in Swed., Ger. and Dutch as *orkan*, or *orkaan*. A "hurricane-deck" is an upper deck on a steamer which protects the lower one, and incidentally serves as a promenade.

HURRY (or **URRY**), **SIR JOHN** (d. 1650), British soldier, was born in Aberdeenshire, and saw much service as a young man in Germany. In 1641 he returned home and became Lieut.-Colonel in a Scottish regiment. At the end of the same year he was involved in the plot known as the "Incident." At the outbreak of the Civil War Hurry joined the army of the earl of Essex, and was distinguished at Edgehill and Brentford. Early in 1643 he deserted to the Royalists, bringing with him information on which Rupert acted at once. Thus was brought about the action of Chalgrove Field, where Hurry again showed conspicuous valour; he was knighted on the same evening. In 1644 he was with Rupert at Marston Moor, where with Lucas he led the victorious left wing of horse. But a little later, thinking the King's cause lost, he again deserted, and eventually was sent with Baillie against Montrose in the Highlands. His

detached operations were conducted with great skill, but his attempt to surprise Montrose's camp at Auldearn ended in a complete disaster, partly on account of the accident of the men discharging their pieces before starting on the march. Soon afterwards he once more joined Charles's party, and he was taken prisoner in the disastrous campaign of Preston (1648). Sir John Hurry was Montrose's Major-General in the last desperate attempt of the Scottish Royalists. Taken at Carbisdale, he was beheaded at Edinburgh, May 29th, 1650. A soldier of fortune of great bravery, experience and skill, his frequent changes of front were due rather to laxity of political principles than to any calculated idea of treason.

HURST, JOHN FLETCHER (1834-1903), American Methodist Episcopal bishop, was born in Salem, Dorchester county, Maryland, on the 17th of August 1834. He graduated at Dickinson College in 1854, and in 1856 went to Germany and studied at Halle and Heidelberg. From 1858 to 1867 he was engaged in pastoral work in America, and from 1867 to 1871 he taught in Methodist mission institutes in Germany. In 1871-1873 he was professor of historical theology at Drew Theological Seminary, Madison, New Jersey, of which he was president from 1873 till 1880, when he was made a bishop. He died at Bethesda, Maryland, on the 4th of May 1903. Bishop Hurst, by his splendid devotion in 1876-1879, recovered the endowment of Drew Theological Seminary, lost by the failure in 1876 of Daniel Drew, its founder; and with McClintock and Crooks he improved the quality of Methodist scholarship. The American University (Methodist Episcopal) at Washington, D.C., for postgraduate work was the outcome of his projects, and he was its chancellor from 1891 to his death.

He published *A History of Rationalism* (1866); *Hagenbach's Church History of the Eighteenth and Nineteenth Centuries* (2 vols., 1869); *von Oosterzee's John's Gospel: Apologetical Lectures* (1869); *Lange's Commentary on the Epistle to the Romans* (1869); *Martyr to the Tract Cause: A Contribution to the History of the Reformation* (1872), a translation and revision of Thelemann's *Martyrer der Traktatsache* (1864); *Outlines of Bible History* (1873); *Outlines of Church History* (1874); *Life and Literature in the Fatherland* (1875); brilliant sketches of Germany; a brief pamphlet, *Our Theological Century* (1877); *Bibliotheca Theologica* (1883), a compilation by his students, revised by G. W. Gillmore in 1895 under the title *Literature of Theology: India: the Country and People of India and Ceylon* (1891), the outgrowth of his travels in 1884-1885 when he held the conferences of India; and several church histories (Chautauqua text-books) published together as *A Short History of the Christian Church* (1893).

HURSTMONCEAUX (also **HERSTMONCEUX**), a village in the Eastbourne parliamentary division of Sussex, England, 9 m. N.E. of Eastbourne. Pop. (1901) 1429. The village takes its name from Waleran de Monceaux, lord of the manor after the Conquest, but the castle, for the picturesque ruins of which the village is famous, was built in the reign of Henry VI. by Sir Roger de Fiennes. It is moated, and is a fine specimen of 15th-century brickwork, the buildings covering an almost square quadrangle measuring about 70 yds. in the side. Towers flank the corners, and there is a beautiful turreted entrance gate, but only the foundations of most of the buildings ranged round the inner courts are to be traced. The church of All Saints is in the main Early English, and contains interesting monuments to members of the Fiennes family and others. In the churchyard is the tomb of Archdeacon Julius Charles Hare, the theologian (1855). Much material from the castle was used in the erection of Hurstmonceaux Place, a mansion of the 18th century.

END OF THIRTEENTH VOLUME

PRINTED BY R. E. DONNELLY & SONS COMPANY, CHICAGO, ON "BRITANNICA INDEA PAPER" MANUFACTURED BY S. D. WARREN & COMPANY, BOSTON, MASS. BORDERS, J. F. TAPLEY & COMPANY, NEW YORK, AND R. E. DONNELLY & SONS COMPANY, CHICAGO.

81 01ST 53 004 3 A 324 DR 6002

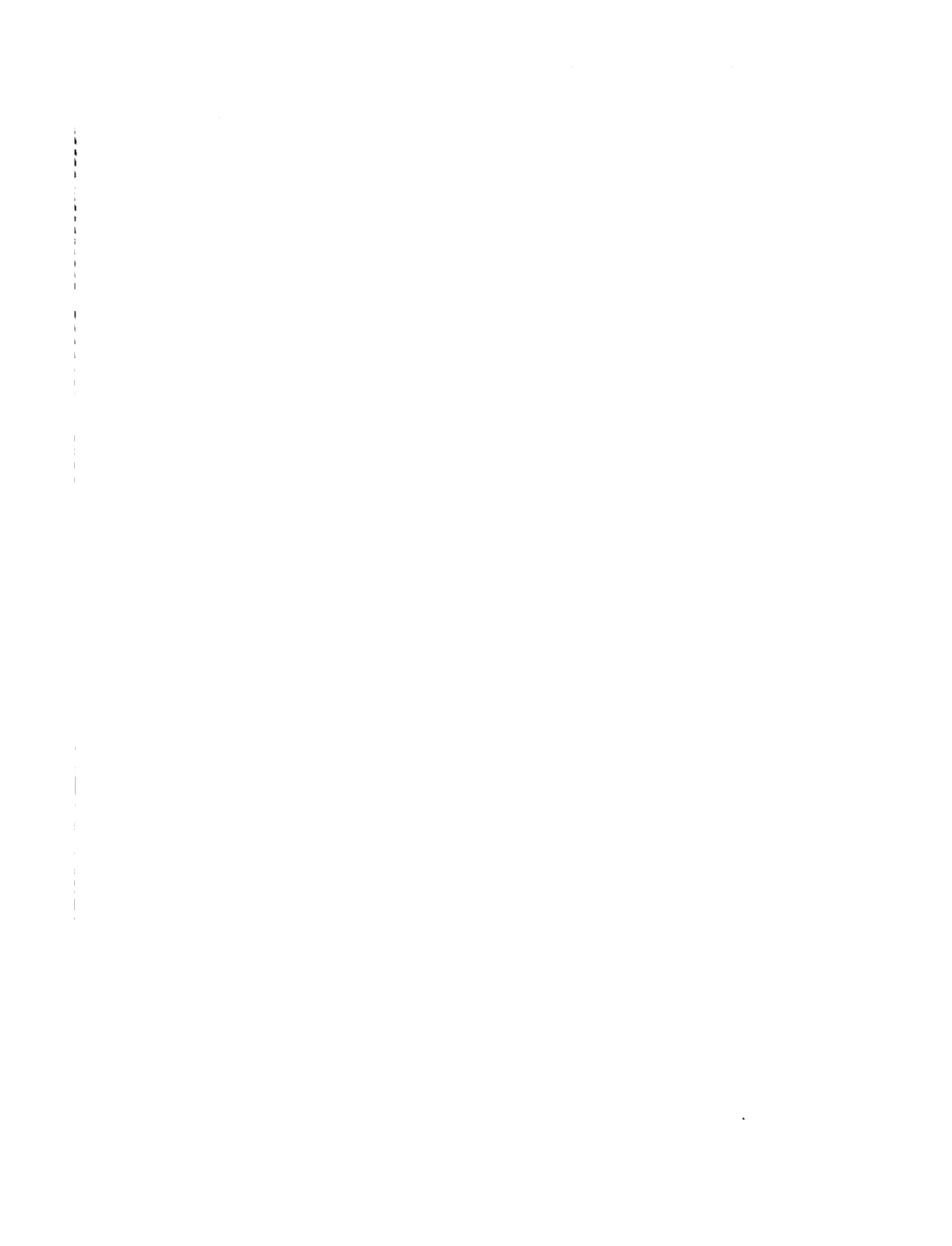

**REFERENCE
BOOK**

**THIS BOOK
DOES NOT
CIRCULATE**



AE5
E56
1922
v. 13

CECIL H. GREEN LIBRARY
STANFORD UNIVERSITY LIBRARIES
STANFORD, CALIFORNIA 94305-6004
(650) 723-1493
gncirc@sulmail.stanford.edu
All books are subject to recall.

DATE DUE

--	--

